

CORNELL UNIVERSITY LIBRARY.

This book, when not in use, must be promptly
returned to its place among the books of reference.

271-A-18

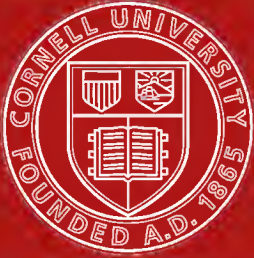

Cornell University Library

The original of this book is in
the Cornell University Library.

There are no known copyright restrictions in
the United States on the use of the text.

CORNELL UNIVERSITY LIBRARY



3 1924 087 904 623

CHAMBERS'S
ENCYCLOPÆDIA

CHAMBERS'S
ENCYCLOPÆDIA

A DICTIONARY
OF UNIVERSAL KNOWLEDGE FOR THE PEOPLE

ILLUSTRATED

WITH MAPS AND NUMEROUS WOOD ENGRAVINGS

VOL. II

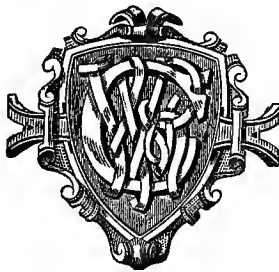

LONDON
W. AND R. CHAMBERS 47 PATERNOSTER ROW
AND HIGH STREET EDINBURGH

1861

LIST OF MAPS FOR VOL. II.

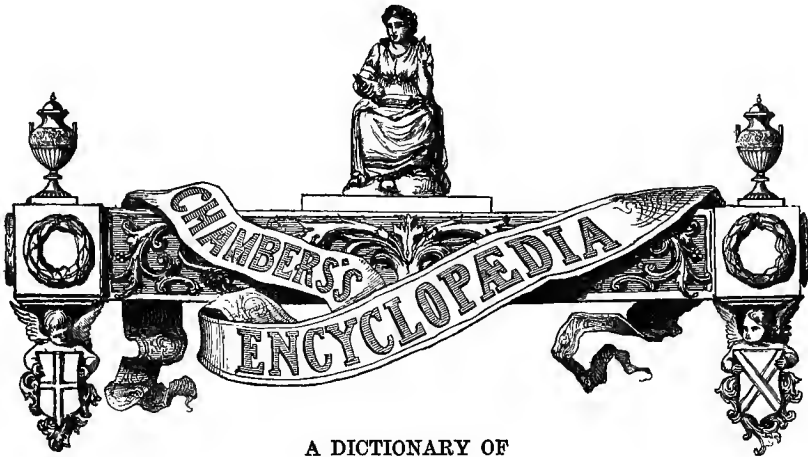

UNIVERSAL KNOWLEDGE FOR THE PEOPLE

BELGIUM.

BELGIUM, one of the smaller European states, consists of the southern portion of the former kingdom of the Netherlands (as created by the Congress of Vienna). In the time of the Romans, it formed a part of *Gallia Belgica*.

Geography and Statistics.—Belgium lies between lat. 49° 27' and 51° 30' N., and between long. 2° 33' and 6° 5' E. It is bounded on the N. by Holland; on the E. by Dutch Limbourg, Luxembourg, and Rhenish Prussia; on the S. and S. W. by France; and on the N. W. by the North Sea. Its greatest length, from north-west to south-east, is 173 English miles; and its greatest breadth, from north to south, 112 English miles. The whole area is 11,313 square miles. The following table gives a list of the provinces in Belgium, with the area, population, and chief town of each:

Provinces.	Area in Square Miles.	Population Dec. 31, 1857.	Chief Cities.
Antwerp,	1,094	439,954	Antwerp.
West Flanders,	1,243	629,379	Bruges.
East Flanders,	1,154	781,531	Ghent.
Hainault,	1,430	778,906	Mons.
Liege,	1,111	509,053	Liege.
Brabant,	1,260	761,404	Brussels.
Limbourg,	929	192,638	Hasselt.
Luxembourg,	1,695	195,498	Arlon.
Namur,	1,397	288,873	Namur.
Total,	11,313	4,577,236	

B. is the most densely peopled country in Europe, the population being about 404 to the square mile; and in the particular provinces of East Flanders, Brabant, Hainault, and West Flanders, respectively, not less than 675, 594, 537, and 502 to the square mile. The rural population bears to that of the towns a proportion of about 3 to 1.

Physical Aspect.—B. is, on the whole, a level, and even low-lying country; diversified, however, by hilly districts. In the south-east, a western branch of the Ardennes highlands makes its appearance, separating the basin of the Maas from that of the

Moselle, but attains only the moderate elevation of 2000 feet. In Flanders the land becomes so low, that in parts where the natural protection afforded by the downs is deficient, dikes, &c., have been raised to check the encroachments of the sea. In the north-east part of Antwerp, a naturally unfertile district named the Campine, and composed of marshes and barren heaths, extends in a line parallel with the coast. The once impassable morasses of the *Morini* and the *Menapii*, which stayed the progress of Cæsar's legions, are now drained, and converted into fertile fields, surrounded by dense plantations, which make the land at a distance look like a vast green forest—though, when more closely regarded, we see only numerous dwellings interspersed among fields, canals, and meadows.

Hydrography, Climate, Agriculture, &c.—The abundant water-system of B. is chiefly supplied by the rivers Scheldt and Maas, both of which rise in France, and have their embouchures in Holland. At Antwerp, the Scheldt, which, like the Maas, is navigable all through Belgium, is 32 feet deep, and about 480 yards wide. Its tributaries are the Lys, Dender, and Rupel. The Maas, or Meuse, receives in its course the waters of the Sambre, the Ourthe, and the Roer. These natural hydrographical advantages are increased by a system of canals which unite Brussels and Louvain with the Rupel, Brussels with Charleroi, Mons with Condé, Ostend with Bruges and Ghent, and this last place with Terneuse. According to the resolution passed by the government in 1842, the long postponed project of cutting canals through the Campine district was at length commenced, and has been very advantageous to the spread of agriculture. A large portion of the Campine seems destined to perpetual barrenness—a dreary, silent, irreclaimable waste; but wherever it has been possible to rescue a patch from the stubborn heath or the relentless sand, there agricultural colonies have been planted, and cornfields shine, and pastures brighten in the heart of the immemorial wilderness. The climate of B., in the plains near the sea, is

cool, humid, and somewhat unhealthy; but in the higher south-east districts, hot summers alternate with very cold winters. April and November are always rainy months. These varieties of climate are favourable to a greater variety of produce than the neighbouring country of Holland can supply. The Ardennes districts yield a large supply of wood; while the level provinces raise all kinds of grain—wheat, rye, barley, oats, &c., leguminous plants, hemp, flax, colza, tobacco, hops, dye-plants, and chicory. Belgium contains upwards of 7,000,000 acres, of which one-half is arable, rather more than one-fifth in meadow and pasture, the same in woods and forests, and not above 500,000 acres lying waste. Some hundreds of acres are devoted to vineyards, but the wine produced is of an inferior quality. The forests of Ardennes abound in game and other wild animals. Good pasturage is found on the slopes and in the valleys of the hilly districts, and in the rich meadows of the low provinces. Gardening occupies not less than 130,000 acres; indeed, it has been said that the agriculture of B. is just gardening on a large scale, so carefully and laboriously is every inch of soil cultivated. The spade is still the principal instrument used. In the Campine, the care of bees is very productive, and the cultivation of the silkworm is encouraged. There are valuable fisheries on the coast, which employ about 200 boats. B. is famous for its horses, and in 1846 contained 294,537 of these animals, 1,203,891 horned cattle, and 662,508 sheep.

Geology.—The geological formations of B. are closely associated with those of France and Britain. The greater portion of the country is covered with *Tertiary deposits*. A line drawn across the course of the Scheldt, by Mechlin, along the Demer and Maas, will have on its northern and north-western aspect a tract of tertiary deposits, bounded northwards by the sea. In these tertiary strata the different geological periods are fully represented; but only the second, containing the Pleiocene deposits, is rich in fossils. The *Secondary deposits* occupy an extensive tract in the centre of Belgium, between the Scheldt and the Demer. The most important district, economically, is the south-western, consisting of *Palaeozoic rocks*—Silurian, Devonian, and Carboniferous. These beds have a very complicated structure, from the numerous and extensive flexures and folds they have undergone, and these are often accompanied with great upward shifts, by which beds of many different ages are brought to the same level.

Mineral Products.—B. is rich in minerals, which, next to its abundant agriculture, constitute the chief source of its national prosperity. The four provinces in which they are found are Hainault, Namur, Liege, and Luxembourg. They include lead, copper, zinc, calamine, alum, peat, marble, limestone, slate, iron, and coal. Lead is wrought, but only to a small extent, in Liege; copper in Hainault and Liege; manganese in Liege and Namur; black marble at Dinant; slates at Herbemont; and calamine principally at Liege. But these products are insignificant compared to the superabundance of coal—from anthracite to the richest gas coal—and iron, in which B. ranks next to England. In 1857, the number of coal-pits was 205; and the amount of coal 'put out' was 8,383,902 tons, valued at upwards of £4,000,000; while the amount of iron ore was between one and two million tons, and of the prepared iron, more than half a million. The number of workmen employed during the same year in the Belgian coal-fields was 72,577. B. also possesses several mineral springs, of which the most celebrated is the chalybeate water of Spa, visited by thousands both from the Old World and the New.

The modern industrial character of the Belgians

may be traced back to a very early period, even to the time of the Romans, who noticed the love of traffic prevailing in the Celtic districts of *Gallia Belgica*. This characteristic has remained steadfast to the present time. It is impossible not to recognise in the cloth-weaving *Atrebatæ* the ancestors of the industrious race who gradually extended themselves towards the east and north of Belgium. During the early commerce of Europe, when trade was secure only within walled towns, Flanders was the principal seat of productive industry; and its recent separation from Holland has also been indirectly favourable to the development of its internal resources. A state which, like B., begins its career under a burden of debt, which is shut in between nations who possess important ports and colonies, and which is peopled by races not yet sufficiently blended to constitute a perfect nationality, must, before all other things, develop its internal, material resources. This has been well understood in Belgium. Since the commencement of its independent career, it has devoted its attention almost exclusively to those branches of industry and commerce by which its future greatness must be supported.

Manufactures.—The chief manufactures are linen, woollen, cotton, silk, lace, leather, and metals. The great seats of the linen manufacture—recently revived after a long depression—are Courtray and Bruges, in West Flanders; Ghent, in East Flanders; Brussels, in Brabant; Mechlin, or Malines, in Antwerp; and Tournay, in Hainault. The number of linen pieces annually produced is about 900,000. The lawn and damask fabrics of Bruges are celebrated, as well as the lace made in and near Brussels, Malines, Louvain, and Bruges, which sometimes commands a price of £40 per yard. But the Belgian hand-spun yarn, though superior in quality, cannot maintain its ground against machinery. Verviers, Liege, Dolhain, Ypres, Doperinghe, Limbourg, Bruges, Mons, Thuin, and Hodimont are centres of the woollen manufacture. Ypres alone employs 50,000 workmen in this branch of industry. Brussels and Tournay have large carpet manufactures, and Hainault supplies a considerable amount of hosiery. The principal manufactures of cotton are at Ghent and Lokoren, in East Flanders; Bruges and Courtray, in West Flanders; Malines, Louvain, and Anderlecht, in Brabant; Tournay and Mons, in Hainault; and also at Antwerp. The separation of B. from Holland had at first a prejudicial effect on this as on other trades; but the opening of the navigation of the Scheldt, the intersection of the country by railways and canals, and, in consequence, the rapid and extensive communication with other countries, have revived the activity of the cotton trade, which now gives employment to between one and two hundred thousand workmen. Maestricht, which belongs to Holland, is one of the chief seats of manufactures of leather; but this trade is also carried on at Limbourg, Liege, Stadelot, Namur, Dinant, and especially at Bruges and Ghent. The manufacture of gloves has made great progress in recent years. Metallurgy also has rapidly increased in productiveness since 1816, when Cockerill introduced into B. the English method of smelting iron with coke. The principal seats of the metal manufacture are Liege, Namur, Charleroi, Mons, and their neighbourhoods. There are large ordnance foundries at Liege and Malines, and celebrated makers of firearms and machinery in Liege; nail-making at Charleroi; tin-ware, &c., at Liege and in Hainault; wire and brass factories at Namur; zinc manufactures at Liege; lead and shot factories at Ghent; the gold and silver goods of Brussels and Ghent may also be noticed as important branches of Belgian industry. Flax is

BELGIUM.

one of the most extensive and valuable products of B., no fewer than 400,000 persons being employed in its culture and preparation. Besides these, we may mention the straw-bonnet manufacture in the neighbourhood of Liege; the paper fabrics of the provinces Liege, Namur, and Brabant; the glass-works of Hainault, Namur, Val-St-Lambert, and Brabant; the porcelain, &c. of Tournay, Brussels, Mons, and Ghent; and sugar-refineries at Antwerp, Bruges, Ostend, Ghent, &c. In 1857, the number of steam-engines employed in the several manufactures of B. was 3499.

The natural wealth and industrial resources of B. have always been more or less modified by the political relations of the country. In the middle of the 13th c., B., with Bruges as its chief seat of manufactures, had surpassed all its neighbours in industry, and had established a flourishing commerce with the Italians. After the discovery of America, Antwerp took the place of Bruges, and was regarded as a northern Venice. But the unhappy period of Spanish oppression and the war in the Netherlands deeply depressed Belgian commerce, which suffered still more at the peace of Westphalia, when Holland monopolised the navigation of the Scheldt. The river was again opened at the close of the 18th c., when the French had invaded the Netherlands, and Napoleon caused the harbour of Antwerp to be restored and enlarged. At the cost of Amsterdam, Belgian commerce received a new impulse by the union of B. with Holland, as settled by the Congress of Vienna; but scarcely were hopes revived, when the revolution of 1830 changed the prospects of the country. The treaty signed in London, April 19, 1839, gave to Holland the right to levy a toll of two-and-sixpence per ton on all vessels navigating the Scheldt. The privilege of navigation on the inland waters between the Scheldt and the Rhine was purchased by B. for an annual payment of £50,000. In June 1839, this privilege was virtually taken away by the government of Holland, and, in 1843, with additional expense to B., the new treaty of navigation was ratified by both parties. During this crisis preceding the development of a free commerce, B. had not neglected her internal resources. The Société de Commerce de Bruxelles, the Banque de Belgique, and other associations for the extension of trade, had been formed; and May 1, 1834, the government adopted the scheme for a railway-system the most complete of any on the continent. The centre of the Belgian net-work of railways is Malines, whence lines are carried out in all directions. The north line goes to Antwerp and its harbour; the west, by Ghent and Bruges, to Ostend; the south-west, by Brussels and Mons, to Quiévrain and the borders of France, not far from Valenciennes; and the east, by Louvain, Tirlemont, Liege, Verviers, and extending to the confines of Prussia. The entire length of these main lines in 1857 was nearly 1000 miles. The amount of government loans expended on the construction of railways up till 31st December 1857, was 186,643,242 francs. The receipts of the main railways during the same year were 25,507,617 francs; the expenses, 13,861,961 francs, shewing a net profit of 11,645,656 francs. In connection with this great scheme of internal communication, the government gave attention to commercial treaties and other measures calculated to supply the want of colonial trade. The colony founded in the district of St Thomas by a treaty with the republic of Guatemala, has passed through a long series of difficulties, but now promises good results.

In 1857, the number of ships which entered Belgian ports was 2791, and the number which left, 2768; their united tonnage, 1,180,835 tons.

The articles of export are far more various than those of import. The value of Belgian exports has nearly quadrupled itself in the last twenty years. In 1837, it amounted to 129,569,000 francs; in 1847, to 205,781,000 francs; and in 1857, to 450,704,000 francs. Among the principal articles of export are coal, flax, linen, woollen, and cotton goods, glass, firearms, and nails. More than a third of the whole quantity is consigned to France, and half of the remainder to the Zollverein, England, and Holland. The unit of the Belgian monetary system is the franc, equal in value to the French franc.

It cannot be said that intellectual improvement has kept pace with the material prosperity of B., though in this respect also there has been a perceptible advance. The great hindrances to a thorough development of the national intellect have been the lack of political independence, which has drawn off the most precious energies of the country to foreign centres of activity; and the variety and confused mixture of dialects, whereby the true Flemish individuality has been driven into the background. An independent national literature, acting as the bond of a pure national unanimity, was not possible, under such unfavourable conditions, to which may be added the facilities afforded for supplying the people with cheap reprints of foreign works. The Flemish element—the most important—seems indeed to have become conscious of its capabilities in respect to literature; but a genuine expression of the entire Belgian mind will first become possible when the Walloon element also begins to develop a freer form of speech along with its own peculiar modes of thought. The Royal Academy of Arts and Sciences at Brussels is at the head of several other unions for scientific purposes. Among the most celebrated names in Belgian literature and science, may be mentioned—Quetelet in mathematics, Altmeyer the historian, Fetis the musical critic, Conscience the Flemish poet and novelist, Willems the philologist, and Baron and Moke in literary history and criticism. Painting and architecture formerly flourished in the wealthy old towns of Flanders; but after the brilliant epoch of Rubens and his pupils, a long period of dulness followed. In modern times, a revival of art has taken place, as may be proved by the names of the painters, Wappers, De Keyser, Gallait, De Biefve, Verboekhoven, &c.; the sculptors, W. Geefs, Simonis, Jehotte, Fraikin, &c.; the engravers, Calamatta, Brown, and Meunier; and the medallists, Wiener and Hars.

The Belgian school-system suffered for more than ten years under the freedom of teaching allowed by the constitution, which was chiefly made use of by the wealthy Catholic clergy. The consequence was that education assumed a divided and sectarian character. Since the state, however, has exercised a general superintendence over the universities, gymnasia, and elementary schools, a higher style of education has prevailed. The two universities of Ghent and Liege, united with a school of architecture and mining; ten national schools (*Athénées*), in which a classical is combined with a commercial education; fifty schools preparatory to these (*Écoles moyennes*); two seminaries for teachers at Lierre and Nivelles, besides the superintendence now exercised by the state over the institutions formerly maintained by communes and provincial corporations, and, above all, over the primary schools—all this forms a sufficient counterpoise to the numerous schools supported by private individuals and religious bodies. Among the latter may be noticed the Catholic High School of Louvain, founded in 1836, and conducted under strict ecclesiastical discipline; the free university of Brussels; and the gymnasia of the Jesuits at Namur, Brugelette, Brussels, and Liege. Journalism in B.

BELGIUM.

has been greatly extended by the abolition of the stamp-duty (1848), and 180 daily newspapers are now published, including 56 Flemish papers; but only a few have obtained a proper degree of respectability and influence.

Population and Religion.—The population of B. is of mixed German and Celtic origin. The Flemings (a branch of the Teutonic family) and Walloons (a branch of the Celtic family), distinguished by their peculiar dialects, are still conspicuous among the pure Germans, Dutch, and French. The French language has gained the ascendancy in educated society, and in the offices of government; but the Flemish dialect prevails numerically in the proportion of 4 to 3. The *Catholic religion* is the prevailing form. There are only about 10,000 or 12,000 Protestants, and 1400 Jews. The supreme Catholic dignitaries of B. are the Archbishop of Mechlin, and the five diocesan bishops of Bruges, Ghent, Tournay, Namur, and Liege.

The *government* of Belgium is a limited constitutional monarchy, and was established in its present form by the revolution of 1830. The legislative body consists of two chambers—that of the senate, and that of the representatives. A responsible ministry, with the king as president, is at the head of all public affairs, and its measures are carried into effect by the governors of the several provinces. The ministry includes departments for home affairs, foreign affairs, finance, justice, public works, and war. The administration of justice retains the forms of French jurisprudence. The total revenue of B. for 1858 was 147,632,990 francs; the total expenditure was 136,635,253 francs. The national debt amounts to nearly 700 millions of francs.

The organisation of the army is based on the law enacted March 19, 1845, and consisted, in 1859, of 2644 officers, and 36,721 men; but it may be increased to 84,219. The Civic or National Guard, organised since 1848, includes about 90,000 men. The whole navy of B. consists only of the brig *Duc de Brabant*, with 20 guns; the schooner, *Luise Marie*, of 10 guns, two war-sloops, and five steamers, which ply as packet-boats between Ostend and Dover. The importance of B. in a military point of view affords a reason for the maintenance of fortifications at Antwerp, Ostend, Nieuport, Ypres, Tournay, Mons, and other places.

History of Belgium to 1830.—In the time of the Romans, the name *Gallia Belgica* was given to the Southern Netherlands lying on the confines of Gaul and Germany. It was peopled by Celtic and German tribes. The latter were predominant in Batavia and Friesland, and, under the rule of the Franks in the 5th and 6th c., gained the ascendancy also in the southern districts. Until the close of the 11th c., the feudal system, which arose at the fall of the Carolingian dynasty, prevailed in the Netherlands, where the several southern provinces were made duchies and counties. The county of Flanders, superior to all the others in industry and commerce, maintained, during a long struggle, its independence against France; and, in 1385, when the male line of the Counts of Flanders expired, was annexed to the powerful House of Burgundy, which, in the beginning of the 15th c., also gained possession of all the other provinces of the Netherlands. The rulers of Burgundy aimed at founding a powerful united state between France and Germany, and therefore endeavoured to repress the free republican spirit which manifested itself in the rapidly rising towns. The work of establishing unlimited sovereignty was interrupted by the fall of Charles the Bold, and the partial division of his territories; but was continued by the Emperor Charles V., the grandson of the Emperor Maximilian, and Maria,

the heiress of Burgundy—through the latter of whom the Netherlands passed into the possession of the House of Hapsburg. After the abdication of Charles, these provinces passed into the hands of Philip II., and by the law of primogeniture, should have remained united with Spain. But scarcely had the peace of Château-Cambresis (1559) put an end to the encroachments of France, when the religious disputes of the Reformation, and the despotic measures of Philip, excited in the provinces a long and bloody war for civil and religious freedom, which ended in the independence of the Northern or Teutonic Netherlands, while in the southern or more Celtic provinces (now included under B.), both the sovereignty of Spain and the rule of the Roman Catholic Church continued. In 1598, B. was ceded by Philip II. to his daughter Isabella, wife of the Archduke Albert, when it became a distinct and independent kingdom. Several measures for the better regulation of internal affairs, especially in the administration of justice, and for the revival of industry, which had been injured by the unenlightened policy of Philip, were projected. Unfortunately, Albert died childless in 1621, and B. fell back into the hands of Spain, and became involved in the wars attending the decline of the Spanish monarchy. Peace was concluded chiefly at the cost of Belgium. By the treaty of the Pyrenees (1659), the counties of Artois, Thionville, and other districts, were given to France. Subsequent conquests by the same powerful neighbour secured to it, at the peace of Aix-la-Chapelle (1668), the possession of Lille, Charleroi, Oudenarde, Courtray, and other places. These were partly restored to B. at the peace of Nimeguen; but as a compensation, Valenciennes, Nieuport, Cambrai, St Omer, Charlemont, and other places, were given up, and only partially regained by B. at the peace of Ryswick in 1697. After the conclusion of this treaty, at the close of the reign of Charles II. of Spain, some endeavours were made to create prosperity in B. by a new system of taxation and customs, and by the construction of canals, to counteract the injury done to its commerce by the closing of the navigation of the Scheldt; but these projected improvements were interrupted by the Spanish War of Succession, which was not concluded until the peace of Utrecht, in 1713. By this treaty, B. was given to Austria, Holland retaining the privilege of garrisoning the most important fortresses on the French frontier, and also of exercising a monopoly of the navigation of the Scheldt. The 'Belgian Commercial Company' at Ostend, founded by Charles VI. in 1722, fell in 1731—another sacrifice to the cupidity of Holland. During the Austrian War of Succession (1744), almost the whole country fell into the hands of the French; but was peaceably restored to Austria by the treaty of Aix-la-Chapelle (1748).

B. remained undisturbed by the Seven Years' War, and during the long peace following the treaty of Aix-la-Chapelle, prosperity was restored. Especially during the mild reign of Maria Theresa of Austria, measures of public improvement were promoted by Prince Charles of Lorraine, governor of the Belgian provinces. The reign of Joseph II., son and successor of Maria Theresa, began in disputes with Holland. The latter country consented to the abolition of the *Barrière-contract*, in consequence of which, several important fortresses were demolished, though the emperor failed in his endeavour to make free the navigation of the Scheldt. But the errors of his internal administration were the serious feature of his policy. By his innovations, he offended the religious sympathies of the people, and violated the legal privileges of the states, of which he had made the strict preservation

a condition of obedience. In a short time, discontent openly manifested itself. The Austrian authorities were attacked; Brabant refused to pay taxes; while the more violent fled into Holland, and organised an armed expedition. Returning, they were joined by numbers of the inhabitants, defeated the foreign troops, captured Brussels, and in the beginning of 1790, declared their independence. In the course of the year, however, the Austrians succeeded in regaining possession of the country. The privileges of the states as they existed at the close of the reign of Maria Theresa were restored, and at the same time stringent measures were adopted to prevent any renewal of disturbances. But this state of peace was soon interrupted by the outbreak of the war of the French Revolution. B. was conquered by Pichegru in the campaign of 1794, and subsequently united to France by the treaties of Campo-Formio and Luneville. It now shared in the fortunes of France during the Consulate and the Empire; received the *Code Napoleon*; and in all political relations, was organised as a part of France. After the fall of Napoleon, it was united with Holland, and its boundaries defined by the Congress of Vienna (May 31, 1815).

At the introduction of the new constitution, the want of national unity in language, faith, and manners was strikingly manifested by the two great parties—the Dutch Protestant population, with their commercial habits, on the one side, and the Catholic population, of agricultural and manufacturing B., on the other. These natural and unavoidable obstacles to the political harmony of the new kingdom, were further increased by the unfair treatment which B. experienced. All the more important provisions of the constitution had a regard chiefly to the interests of Holland. Repeated attempts were made to supersede the Belgian language by the Dutch in all affairs of administration and jurisprudence, though the former were the more numerous people; the privileges of the Belgian clergy were abridged; the poorer classes were severely taxed; while the government was almost exclusively composed of Dutchmen. In 1830, among seven ministers, there was only one Belgian; among 117 functionaries of the ministry of the interior, only 11 Belgians; among 102 subordinates of the ministry at war, only 3 Belgians; and among 1573 officers of infantry, only 274 Belgians. B. was politically divided into two classes—the Liberal and the Catholic. Both of these strongly resented and opposed the encroachments of Holland: the Liberals, from a desire to preserve the national secular institutions; the Catholics, from a desire to preserve the national Church. The government became alarmed at their increasing hostility; and ultimately, when their patriotic fusion rendered its position critical, it made several concessions; the supremacy of the Dutch language, and the taxes on the necessaries of life, were abolished. Efforts were also made to conciliate the Catholic priesthood. But these concessions came too late, and were, in consequence, only construed as signs of weakness. In 1828 and 1829, it was attempted to coerce and intimidate the opposition, by prosecuting the liberal or democratic leaders. This only fanned the fire of discontent, which was already burning fiercely in the hearts of the Belgians, and panting for an opportunity to break out into visible insurrection.

From 1830 to 1858.—The French revolution of 1830 afforded the desired occasion. On the king's birthday (August 24, 1830), several riots occurred in various towns of Belgium. At this period, however, the idea of separation from Holland does not seem to have presented itself consciously to the Belgian mind; the deputies who

were sent to the Hague to state the causes of the general dissatisfaction, merely insisted on its possessing a separate administration, with the redress of particular grievances. But the dilatory and obstructive conduct of the Dutch deputies in the states-general assembled at the Hague on the 13th September, exasperated the Belgian nation beyond measure. A new and more resolute insurrection instantly took place. In seven days, the people had deposed the old authorities, and appointed a provisional government. Prince Frederick, the son of the sovereign, who commanded his father's troops, was compelled to retreat from Brussels to Antwerp, having suffered considerable loss. On the 4th of October, B. was declared independent by the provisional government, composed of Messieurs Rogier, D'Hooghvorst (commandant of the civic guard), Joly, an officer of engineers, and the secretaries Vanderlinden and De Coppin; Count Felix de Mérode, Gendebien, Van de Meyer, Nicolai, and De Potter, the democratic leader. They also announced that a sketch of the new constitution was in course of preparation, and that a national congress of 200 deputies would shortly be called together. Freedom of education, of the press, of religious worship, &c., were proclaimed. Here and there, the new liberty shewed a tendency to become anarchic; but its excesses were speedily suppressed; and at the national congress of the 10th November, out of 187 votes, only 13 were in favour of a democratic government. Meanwhile, the London Congress had assembled, and after mature deliberation, recognised the severance of the two kingdoms as a *fait accompli* (December 10). The Belgian Congress, on its assembly (February 23, 1831), appointed Baron Surlet de Chokier provisional regent, but on the 9th July elected Prince Leopold of Saxe-Cobourg king, who entered Brussels on the 21st of the same month, and subscribed the laws of the constitution, which in the meantime had been prepared. Holland, however, refused to acknowledge the validity of the decision of the London Congress, and declared war against B., which was speedily terminated through the interference of France and England—Holland obtaining several advantages, among others, that B. should annually pay 8,400,000 guilders as interest for its share in the national debt of Holland. The latter country, however, was still dissatisfied, and again ventured to employ force. England and France were once more compelled to interfere. The blockade of the coast of Holland soon brought the Dutch to terms, and the dispute was finally closed by a treaty signed in London, May 21, 1833.

The monarchy of B. is hereditary, according to the law of primogeniture, but with a perpetual exclusion of females and their descendants. The legislative power is vested in the king and two chambers; and the king has the power to dissolve either the Senate or the House of Representatives, or both. The number of the representatives is 108, elected for 4 years. Electors must be Belgians by birth or naturalisation, must have attained 25 years of age, and pay taxes, each to the amount of £1, 13s. 4d. Members of the Chamber of Representatives require no property qualification. The Senate consists of half the number of representatives, and is elected by the same constituency, but for 8 years instead of 4. A senator must be 40 years of age, and must pay at least 1000 florins of direct taxes. The budget is annually voted by the chambers, and the contingent of the army is also subject to their annual vote.

In 1842, a law was carried in both chambers, by which it was enacted that the parishioners should be bound to provide elementary schools, according to the wants of the population, in all places where the want of education was not fully supplied by

voluntary means. The main regulations for the universities were effected by the ministry of De Theux, 1835; but the organisation of intermediate instruction (that is, between the *Ecoles Primaires* and the universities) was postponed, as involving some delicate party interests, until 1850; and even then was not concluded in a way satisfactory to the Catholic clergy.

In 1838, it seemed as if Holland and B. were likely to engage in war once more. According to the 'twenty-four articles' of the 'Definitive Treaty,' B. was under obligation to give up Limbourg and a part of Luxembourg during the above-mentioned year. This it now refused to do, and put its army on a war-footing; but its obstinacy finally gave way to the unanimous decision of the five great powers.

After 1840, the opposition of the Catholic to the Liberal party became more and more decided. The elections of June 8, 1841, were attended with great excitement, and it was a significant fact, that the liberal candidates re-elected were everywhere returned by large majorities, while in the principal towns where Catholics were returned, only small majorities appeared. Meantime, however, commerce progressed under a wise and liberal policy.

In July 1845, the liberal Van de Weyer, at the head of a new administration, endeavoured to confirm the so-called 'union' of Catholics and Liberals. But he had scarcely asserted the prerogative of the civil power in matters pertaining to the question of education in the 'intermediate schools,' when he was forsaken by his colleagues, who acted under the influence of the Catholic priesthood. In March 1846, a purely Catholic ministry was formed under the presidency of De Theux. This was an anachronism, for the elections of 1845 had secured a victory for the Liberals.

The elections of 1847 at last brought to a close the system of government in subservience to the church. A new liberal ministry was formed by Rogier and others, whose programme of policy promised the maintenance of the independent civil authority in all its subordinate functionaries; a budget favourable to the public with regard to duties on provisions; and measures to promote the interests of agriculture. The institution of numerous agricultural and commercial schools, normal *ateliers*, popular libraries, and other means used for raising the working-classes, were followed by most beneficial results. The revolutionary tempest of 1848, however, menaced the tranquillity of the country; but the king, at the outbreak of the catastrophe in France, promptly declared himself ready to retain or to surrender the crown of B. according to the decision of the people. This frank and ready declaration had a successful result in strengthening the party of order, while it disarmed even those most disaffected to the crown.

In July 1848, the result of the elections was found to be a great strengthening of the liberal-constitutional party. In November 1849, a new commercial treaty for ten years was concluded with France, and the duration of the treaty with the German Zollverein was lengthened. In the session of 1850, the educational question was at last disposed of. During the last decade, the Liberal party has, on the whole, steadily increased in numbers and influence. The most recent elections incontestably prove this, the Liberals being nearly two to one, and their majorities coming from the principal towns in the kingdom.

Nothomb's *Travaux Publics en Belgique* (Bruss. 1839); *Statistique de la B.*, by the same author (1848); *Juste, Histoire de B.* (3d ed., Bruss. 1850); Popliment, *La B. depuis l'an 1830* (Bruss. 1850).

BELGORO'D (Russian, *Bejelgorod*, 'White Town'), a town of 12,000 inhabitants, in the Russian government of Koursk. It is situated on the Donetz, in lat. 50° 40' N., long. 36° 35' E. B., which derives its name from a chalk-hill in the vicinity, is divided into two—the old and the new towns. It is built chiefly of wood, is an archbishop's see, has numerous churches, two monasteries, manufactories of leather, soap, &c., and carries on a considerable trade in wax, bristles, and hemp. Three important fairs are held here during the year.

BELGRADE, the ancient *Singidunum*, styled by the Turks *Darol-Jihad*, the 'House of the Holy War,' and in German, *Weissenburg*, is an important fortified and commercial town, capital of Servia. It is situated at the confluence of the rivers Save and Danube. The name B. is derived from the Slavonic *bielo*, 'white,' and *grad* or *grad*, a 'fort' or 'town.' B. contains about 30,000 inhabitants, and is divided into four parts—the fortress, a very strong place, which, situated on the tongue of land between the rivers, commands the Danube; the Water Town, also well protected by walls and ditches, on the north; the Raitzen Town on the west; and the Palanka on the south and east of the citadel. B. contains fourteen mosques, of which the principal one is in the citadel. Here the pasha, of three horse-tails, has his residence. Vessels navigating the Danube anchor between the three islands above Belgrade. B. has manufactories of arms, cutlery, saddlery, silk goods, carpets, &c., and is the seat of the chief Servian authorities. It is the entrepôt of the trade between Turkey and Austria. The position of B. has made it the chief point of communication between Constantinople and Vienna, and the key to Hungary on the south-east. It has consequently been the scene of many hard contests. The Greeks held it until 1073, when it was captured by the Hungarian king, Salomon. After this, it passed through the hands of Greeks, Bulgarians, Bosnians, and Servians, and these last proprietors sold it, in the beginning of the 15th c., to the Emperor Sigismund. In 1442, it was unsuccessfully besieged by the Turks, with a large and vain outlay of time and money; and when stormed (July 14, 1456), was retaken from the Turks by the heroism of Hunyades and Capistrano. In 1522, it was carried by the Sultan Soliman II. In 1688, it was stormed and taken by Maximilian, Elector of Bavaria; but in 1690 was recaptured by the Turks, when the Christian garrison had been reduced to 500 men. In 1693, B. was vainly besieged by the Duke of Croÿ; and in 1717, the citadel surrendered to Prince Eugene, after he had defeated an army of 200,000 Turks, with a loss to them of 20,000 men. But in 1739, B. again changed owners, the Turks obtaining it without a shot. In conformity with the treaty then signed, the fortifications were demolished. In 1789, it was again taken by the Austrians under General Landon; but by the treaty of peace, 1791, was restored to the Turks, and—excepting a temporary possession of 7 years, from 1806 to 1813, by the insurgent Servians—has, since that time, remained in subjection to Turkey. By the peace of Adrianople (1829), the Porte was allowed to maintain in B. a garrison of 3000 men. During the Crimean war, the defences were strengthened, and the garrison largely increased.

BELIAL, or, more accurately, *Bel'ial*, a Hebrew word, signifying idle, wicked, or unprofitable. The scripture phrase, therefore, 'Sons of B.' was originally, in all probability, a mere Hebrew figurative expression denoting worthless or dissolute persons. At a later period, the idea of evil which the word embodies, seems to have been elaborated into a

personality, and B. is supposed by some to correspond to the Pluto of the Greeks.

BELIEF. This is a word sufficiently intelligible in common speech; but, nevertheless, various subtle problems and protracted controversies have been connected with it. A brief account of the chief of these may be here given.

1. It has been a matter of no small difficulty with mental philosophers, to give an exact rendering of the state of mind so denominated, or to specify the exact import, test, or criterion of the act of believing. It is easy enough to comprehend what is meant by an idea or a notion, as when we speak of having the idea of a rose, its shape, colour, odour, &c.; but when we make the further step of affirming our belief in the sweetness of the rose, it is not so easy to describe the exact change that has come over the mind in so doing. In all belief, there must be something intellectual, something thought of, or conceived by the mind; and hence there has been a disposition to recognise the believing function as one of the properties of our *intelligence*. We believe that the sun will rise and the tides flow to-morrow: here are undoubtedly implied intellectual conceptions of the sun, his rising, and of to-morrow; of the sea, its movements, and so on. But the question comes, what is the difference between conceptions believed in as these are, and conceptions quite as clear and intelligible that are not believed? as the notion that the fluctuation of the sea on the shores of Britain is the same as on the shores of Italy. It is not to the purpose to say, that in the one case we have knowledge and evidence, and not in the other; for what is wanted is to define the change that comes over us, when what is a mere notion or supposition passes into a conviction; when a day-dream or hypothesis comes to take rank as truth.

To answer this inquiry, we must bring in a reference to *action*; for although belief connects itself with our intelligence, as now mentioned, it has action for its root and ultimate criterion. Coming up to the edge of a frozen lake, and looking at the thickness of the ice, we believe that it will bear to be trodden on, and accordingly walk across it. The meaning or purport of the believing state here is, that we do not hesitate to trust our safety to the fact believed. The measure of our confidence is the measure of our readiness to act upon our conviction. If the frozen lake lie between us and our destination, we feel elated by the certainty of arriving there, which we should not under a weak or imperfect trust in the goodness of the ice. Belief, therefore, although embodied in ideas, or intellectual conceptions, is in reality a moral power, operating on our conduct, and affecting our happiness or misery. Belief in coming good cheers us almost as much as if it were already come; a like strength of conviction of approaching evil is to the same degree depressing; 'the devils believe, and tremble.' These two tests—readiness to act according to what we believe, and influence on the mental tone—effectually separate the state in question from mere notions, fancies, or suppositions, unaccompanied with credence. We have firm confidence in the food we eat being able to nourish us; we exert ourselves to procure that food, and when we feel hungry, and see it before us, we have the mental elation arising from a near and certain prospect of relief and gratification. If there be anything that we work languidly to procure, and feel little elated by being near or possessing, our conviction is proved to be feeble as to the utility of that thing, or as to the pleasure we shall derive from it. So, in employing means to compass ends, as when we sow that we may reap, work that we may obtain abundance, study that we may be informed—we have a

certain confidence in the connection between the means and the ends; in other words, we are energetically urged to use those means, and having done so, we have the feeling as if the end were already attained.

Even in cases the furthest removed in appearance from any action of ours, there is no other criterion. We believe a great many truths respecting the world, in the shape of general propositions, scientific statements, affirmations on testimony, &c., which are so much beyond our own little sphere, that we can rarely have any occasion to involve them in our own procedure, or to feel any hopeful elation on their account. We likewise give credit to innumerable events of past history, although the greater number of them have never any consequences as regards ourselves. Yet, notwithstanding such remoteness of interest, the tests now mentioned must apply; otherwise, there is no real conviction in any one instance.

There is a distinction, first characterised by Aristotle, between potentiality and actuality (*posse* and *esse*), which truly represents two different states of mind of real occurrence. Besides the actual doing of a thing, we know what it is to be in a state of *preparedness* to act, before the emergency has arisen, or while it is still at a distance and uncertain. The thirsty traveller, not knowing of a spring where he may drink, is debarred from the act that his condition prompts him to, but he is in an attitude of mind that we call being ready for action the moment the opportunity arrives. We all carry about us a number of unexecuted resolutions, some of them perhaps remaining so to the last, for want of the occasion. They are not, on that account, to be set aside as having no part in our nature; they are genuine phases of our activity. So it is with many things believed in by us, without any actual prospect of grounding actions, or staking our welfare, upon such things. When we say we believe that the circumference of the globe is 25,000 miles, if not repeating an empty sound, or indulging an idle conception, we give it out that if any occasion arise for acting on this fact, we are ready to do so. If we were about to circumnavigate the earth, we should commit ourselves to this reckoning. Should there be any hesitation on the point when the time for action came, the professed belief would be shewn to be hollow, no matter how often we heard the statement, or repeated it, with acquiescence. The genuineness of conviction is notoriously open to question, until an opportunity of proceeding upon it occurs. Very often we deceive ourselves and others on the point—whether we are in full potentiality or preparedness in some matter of truth or falsehood. There is a very large amount of blind acquiescence in, or tacit acceptance of, propositions which never become the subject of any real or practical stake. These beliefs falsely so called confuse the line of demarcation between mere intellectual notions and states of credence or conviction. Of this nature is the acceptance given by the mass of mankind to the statements they are accustomed to hear from the better informed class respecting the facts of science and the transactions of history. They do not dispute those statements; and yet they might be little disposed to commit their serious interests to such facts. So with regard to the religious creed handed down from parent to child. Some are found believing, in the full import of the term; others, opposing no negative in any way, yet never perform any actions, or entertain either hopes or fears, as a consequence of their supposed acceptance of the religion of their fathers; their belief, accordingly, must be set down as a nonentity.

2. There is considerable interest attached to the

inquiry into the *sources* or operating causes of this efficacious attribute of our active nature. What are the influences that determine us to adopt some notions as grounds of action and elements of hope or depression, in preference to others? The common answer to this question is the possession of evidence, of which two kinds are reckoned by some schools—namely, experience and intuition; while others recognise experience alone, and reject the intuitive as a sufficient foundation of belief.

As regards the actual sources of men's convictions, it is undeniable that many things are credited without any reference to experience. The existence of superstitions is an example. So the partialities arising out of our likings to particular persons, and the undue depreciation of the merits of those whom we dislike, present instances equally removed from the criterion of experience. It is evident, therefore, that men do not abide by that criterion, even granting that they ought to do so. Accordingly, it is one of the tasks of the mental philosopher to specify the portions of our constitution that give birth to false, mistaken, or unfounded beliefs; and in so doing he indicates, first, certain intuitive impulses connected with our active nature; and secondly, our various feelings, or emotions. Whether the intuitive be a source of authentic beliefs, may be a matter of doubt; there is no doubt as to its being a genuine source of real convictions. We have a decided tendency from the first to believe that the present state of things will continue, and that the absent resembles the present. He that has always seen water liquid, cannot at first be convinced that it is ever or anywhere solid. We have always a great difficulty in surmounting the primitive impulse to consider other men's minds as exactly like our own. It is the tendency of the uncultured human being to over-generalise; and experience comes as a corrective, often very painful to submit to. Then, again, as regards the emotions, it is found that every one of these, if at all strong, is liable to blind us to the realities of the world. Fear is a notable example. Under a fright, a man will believe in the approach of the direst calamities. Superstition is, for the most part, the offspring of men's fears. The effect of a strong emotion is to exclude from the mind every fact or consideration except those in keeping with itself. Intense vanity so lords it over the current of the thoughts and the course of the observations, as to present to one's mind only the very best side of the character. A fit of self-abasement and remorse will work the contrary effect.

It is plain enough, therefore, that we are very often in the wrong, by trusting to our intuitive tendencies, and as often so under our emotions; while we are as ready to act, and to derive comfort or the opposite, under false beliefs, as under the very soundest that we can ever arrive at. The practice of life points to *experience* as the check to wrong believing. If we find on trial that another man's feelings differ very much from ours in the same circumstances, we stand corrected, and are perhaps wiser in future. So, in science, experiment is the ultimate canon of truth. There prevails, notwithstanding, in one school of philosophy, comprising the majority of metaphysical philosophers both in this country and in Germany and France, the opinion that experience is not the only source even of *sound* or true beliefs. There are those who contend for an *à priori* origin of scientific first principles; such, for example, as the axioms of mathematics. 'Things that are equal to the same thing are equal to one another,' is one of the class about which this dispute reigns. There is also a doctrine current that the law of causation has an authority derived from intuition. Another class of beliefs relates to matters altogether

beyond experience; such is the metaphysical doctrine of the infinite. These various convictions—*à priori*, as they are called, being grounded solely in the internal impulses of the human mind—are all open to one common remark. It must be conceded that some intuitive beliefs are unsound, seeing that we are obliged to reject a greater or less number because of their being flatly contradicted by our experience. But if any have to be rejected in this way, why may not all be; and what criterion, apart from experience, can be set up for discriminating those that we are to retain? Man undoubtedly has boundless longings; and the doctrine of the infinite corresponds in a manner to these. But in actual life we find very few of our desires fully gratified, not even those most honourable to the human mind, such as curiosity, the passion for self-improvement, and the desire of doing good. How, then, are we to ascertain which of the longings carries with it its own necessary fulfilment? Moreover, the intuitive tendencies are exceedingly various in men; and all cannot be equally true.

Testimony, which is properly reckoned one of the sources of belief, is, in its operation, partly founded on an intuitive tendency, and partly on experience. We at first believe whatever we are told; the primitive phase of our nature is credulity; the experience that we soon attain to of untrue statements puts us on our guard, and we learn to receive testimony under some circumstances, and from some persons, and not in all cases indiscriminately.

3. *Responsibility for Belief.*—A lengthened controversy arose some time ago, on the saying of Lord Brougham, that 'man is no longer accountable to man for his belief, over which he has himself no control.' Reduced to precise terms, the meaning of this assertion is: a man's belief being involuntary, he is not punishable for it. The question therefore arises, *how far* is belief a voluntary function? for it is known that the will does to some extent influence it.

What a man shall see when he opens his eyes is not in his own power; but the opening of the eyes is a voluntary act. So, after listening to a train of arguments on a certain dispute, we might be irresistibly inclined to one side; but, supposing us to live in a country where the adhesion to that side is criminal, and punished severely, we should very likely be deterred from hearing or reading anything in its favour. To this extent, the adoption of a belief is voluntary. The application of strong motives of the nature of reward or punishment is sufficient to cause one creed to prevail rather than another, as we see in those countries and in those ages where there has been no toleration of dissent from the established religion. The mass of the people have been in this way so fenced in from knowing any other opinions, that they have become conscientiously attached to the creed of their education.

When the question is asked, therefore, whether punishment can control men's beliefs, and not their professions merely, all history answers in the affirmative, as regards religious and political creeds, on which the majority of mankind, being insufficient judges of themselves, are led by tradition and by education. But in matters of daily practice, where the simplest can judge as well as the wisest, the case is altered. No severity of threat could bring a man into the state of believing that his night's rest was hurtful to him; he might be overawed into saying that it was so, but he would never act out his forced affirmation, and therefore he would shew that he did not believe it.

If the sentence of Lord Brougham is held to imply that all beliefs are beyond the power of external

motives, and therefore that rewards and punishments can go no further than making outward conformity, we must pronounce it erroneous. For granting that motives cannot have a direct efficacy on the state of a man's convictions—which cannot be conceded in all cases—yet the *indirect* influence is so great as to produce the unanimity of whole nations for centuries in some one creed. But if it is only meant, that such indirect means *ought not* to be applied to sway men's convictions, this is merely a way of affirming the right of free thought and inquiry to all mankind, and the iniquity of employing force on such a matter.—On the subject of Belief generally, see Bain on the Emotions and the Will.

BELISARIUS (in Slavonic, *Beli-tzar*, 'White Prince'). This heroic and loyal soldier, to whom the Emperor Justinian was principally indebted for the glory of his reign, was born at Germana, in Illyria, about 505 A. D. He first assumed a conspicuous position when he was appointed to the command of the eastern army of the empire, stationed on the confines of Persia, where, in 530 A. D., he gained a victory over a Persian army nearly twice as large as his own. The historian Procopius was at this time secretary to Belisarius. In the following year, when the Persians had penetrated into Syria, intending to attack Antioch, B. being compelled by the impatience of his troops to offer battle at Callinicum, a town at the junction of the rivers Bilecha and Euphrates, was defeated, and in consequence recalled. This petulant injustice, however, did not weaken that principle of duty which ever controlled and inspired the great soldier. He still remained the firm supporter of his sovereign. In Constantinople, the strife of the two parties, styled respectively 'the green' and 'the blue,' had endangered the authority and even the life of Justinian; already a new emperor, Hypatius, had been elected, when B., at the head of the life-guards, attacked and slew, in the race-course, 30,000 of the green or anti-loyalist party, and thus restored tranquillity. Previous to this, he had married a wealthy but profligate lady, Antonina, whom he loved with the same blind uxoriousness that Marcus Aurelius exhibited towards Faustina. The only points in his history which are not edifying, are those in which he yielded to her noxious solicitations. The military career of B. may be divided into two great epochs: the war against the Vandals in Africa, and the war against the Goths in Italy, which again subdivides itself into two campaigns, with an interval of four years between them. The first of these epochs was commenced by Justinian sending B., in 533 A. D., with an army of 15,000 men into Africa, in order to recover the provinces there held by the Vandal king, Gelimer. After achieving two victories, B. made the king a prisoner, seized his treasures, and after conquering Sardinia, Corsica, and the Balearic Isles, he brought him to Constantinople, where he appeared in a triumphal procession of the conqueror—the first that a subject had enjoyed since the days of Tiberius. The African Vandals never recovered from this overthrow. Medals were struck in B.'s honour; and on the 1st January 535, he was invested with the dignity of 'consul,' and granted a second triumph, according to the old republican style. The second war was occasioned by the divisions existing in the royal family of the Ostrogoths, which induced Justinian to attempt to wrest Italy from the hands of the barbarians. In 535, B. conquered Sicily; and in the autumn of 536, he crossed over to Lower Italy, where all the cities submitted to him except Naples, which he carried by storm. On the 10th of December, he entered Rome, having made an amicable arrangement with

the inhabitants. As he found his forces not strong enough to contend with the Goths in open field, he allowed himself to be enclosed and besieged in Rome: after the defence had lasted a year, the Goths raised the siege. In 538, Narses had been sent with a reinforcement for the army in Italy; but some misunderstanding occurring between the two generals, they were prevented from relieving Milan, which in 539 was carried and devastated by Braias, nephew of the Gothic king, Vitiges. Consequently, Narses was recalled from Italy; and B., now placed at the head of both armies, refused to assent to a treaty proposed to King Vitiges by Justinian's ambassadors. Vitiges had persuaded the Persian king, Chosroes, to invade the eastern Roman territory. B. now drove the Goths back to Ravenna, which he captured in 540, along with Vitiges himself. But before he could complete his conquest of the Goths, he was recalled by Justinian to Constantinople, where he soon appeared, bringing with him the king Vitiges, several Gothic chieftains, and the royal treasures. In 541—542, he was engaged in a campaign against the Persians, who had captured Antioch; but was again recalled, on account of slanderous representations made to the emperor, and the enterprise necessarily proved indecisive. His second great struggle with the Ostrogoths now begins. In 544, the barbarians, under Totila, again invaded and reconquered Italy. B. was sent against them, but with an insufficient army. He, however, maintained his ground for five years, harassing the enemy by his skilful movements, and even succeeded so far as to regain possession of Rome. But, in spite of his repeated entreaties, no reinforcements were sent to him; and in September 548, he gave up the command, his rival, Narses, being appointed in his place. After ten years of retirement, B. once more came forward at the head of an army hastily collected, and overthrew the Bulgarians, who had threatened Constantinople. Here this faithful servant, who at Ravenna had, in a spirit of noble loyalty unknown to the warriors in those selfish and ambitious times, refused the crown of Italy offered to him by the Goths, was at length accused of a conspiracy against Justinian, and imprisoned, December 563; but according to Malala and Theophanes, Justinian became convinced of B.'s innocence, and restored him, after six months, to all his honours. He died March 564.

The biography of B. has been treated with great licence by writers of fiction, especially by Marmontel, who has represented the hero as cruelly deprived of sight, and reduced to beg for his bread in the streets of Constantinople. Tzetztes, a writer of the 12th c., states that, during his half-year's imprisonment, B. suspended a bag from the window of his cell, and exclaimed to those who passed by: 'Give an obolus to B., who rose by merit, and was cast down by envy!' but no writer contemporary with B. mentions this circumstance. Lord Mahon, in his *Life of Belisarius* (Lond. 1829), endeavours, but without success, to confirm the tradition, or rather the fiction, of B. being deprived of sight and reduced to mendicancy. This fiction supplies the subject of a fine picture by the French painter Gérard.

In figure, B. was tall and majestic; in disposition, humane and generous; pure in his morals, temperate in his habits, a valiant soldier, a skilful general, and above all, possessed by a sublime spirit of loyalty to his sovereign.

BELI'ZE. See BALIZE.

BELL. Bells are usually formed of a composition of copper and tin, called bell-metal. When the proper proportions of the two metals are fused together,

BELL.

the compound is poured into a mould. Authorities differ as to the best proportions of the copper and tin. Some give 80 parts of copper to 20 of tin, or 4 to 1; others state the proportions as being 3 to 1. In the reign of Henry III. of England, it would seem to have been 2 to 1; and the small bronze bells discovered by Mr Layard in the palace of Nimroud, are found to contain 10 of copper to 1 of tin. Hand-bells are often made of brass, antimony alloyed with tin, German silver,



Queen Mary's silver-gilt Hand-bell.

real silver, and gold. The notion that in old times silver was mixed with bell-metal to sweeten the tone, is a mistake. Silver, in any quantity, would injure the tone. The quality of a bell depends not only on the composition of the metal it is made of, but very much also on its shape, and on the proportions between its height, width, and thickness; for which the bell-founder has rules derived from experience, and confirmed by science. The pitch of a bell is higher the smaller it is. For a peal of four bells to give the pure chord of ground tone (key-note), third, fifth, and octave, the diameters require to be as 30, 24, 20, 15, and the weights as 80, 41, 24, 10. A less quantity of metal than is due to the calibre of the bell though giving the same note, produces a meagre harsh sound; and the real or fancied superiority in dignity of tone of some old bells, is ascribed to a greater weight of metal having been allowed for the same note than modern economy would dictate. Bells have been cast of steel, some of which have had a tone nearly equal in fineness to that of the best bell-metal, but deficient in length, having less vibration. Some have also been cast of glass, with a considerable thickness of the material; and these give an extremely fine sound, but are too brittle to stand the continued use of a clapper.

From a remote antiquity, cymbals and hand-bells were used in religious ceremonies. In Egypt, it is certain that the feast of Osiris was announced by ringing bells; Aaron, and other Jewish high-priests, wore golden bells attached to their vestments; and in Athens, the priests of Cybele used bells in their rites. The Greeks employed them (*koda*) in camps and garrison; and the Romans announced the hour of bathing and of business by the *tintinnabulum*. The introduction of bells into Christian churches is usually ascribed to Paulinus, Bishop of Nola in Campania (400 A. D.); but there is no evidence of their existence for a century later. That they were first made in Campania, is inferred from the name given to them—*campana*; hence *campanile*, the bell-tower. Their use in churches and monasteries soon spread through Christendom. They were introduced into France about 550; and

Benedict, Abbot of Wearmouth, brought one from Italy for his church about 680. Pope Sabinian (600) ordained that every hour should be announced by sound of bell, that the people might be warned of the approach of the *hora canonica*, or hours of devotion. Bells came into use in the East in the 9th c., and in Switzerland and Germany in the 11th. Most of the bells first used in Western Christendom seem to have been hand-bells. Several examples, some of them, it is believed, as old as the 6th c., are still preserved in Ireland, Scotland, and Wales. They are made of thin plates of hammered iron, bent into a four-sided form, fastened with rivets, and brazed or bronzed. Perhaps the most remarkable is that which is said to have belonged to St Patrick, called the *Clog-an-eadhachta Phatraic*, or 'The bell of Patrick's Will' It is 6 inches high, 5 inches broad, and 4 inches deep, and is kept in a case or shrine of brass, enriched with gems and with gold and silver filigree, and made (as an inscription in Irish shews) between the years 1091 and 1105. The bell itself is believed to be mentioned in the *Annals of Ulster* as early as the year 552. Engravings as well of the bell as of its shrine, with a history of both, by the Rev. Dr Reeves of Lusk, were published at Belfast (where the relic is preserved) in 1850. Some of the Scotch bells, of the same primitive type, are figured and described in the *Illustrated Catalogue of the Archaeological Museum at Edinburgh in 1856* (Edin. 1859). The four-sided bell of St Gall, an Irish missionary, who died about 646, is still shewn

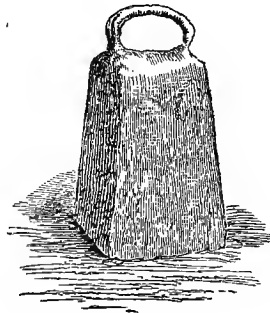

St Ninian's Bell, as figured in the above work.

in the monastery of the city which bears his name in Switzerland. Church-bells were suspended either in the steeples or church-towers, or in special bell-towers. They were long of comparatively small size: the bell which a king presented to the church of Orleans in the 11th c., and which was remarkable in its age, weighed only 2600 pounds. In the 13th c., much larger bells began to be cast, but it was not until the 15th c. that they reached really considerable dimensions. The bell 'Jacqueline' of Paris, cast in 1400, weighed 15,000 pounds; another Paris bell, cast in 1472, weighed 25,000; the famous bell of Rouen, cast in 1501, weighed 36,364 pounds. The largest bell in the world is the Great Bell or Monarch of Moscow, above 21 feet in height and diameter, and weighing 193 tons. It was cast in 1734, but fell down during a fire in 1737, was injured, and remained sunk in the earth till 1837, when it was raised, and now forms the dome of a chapel made by excavating the space below it. Another Moscow bell, cast in 1819, weighs 80 tons. The Great Bell at Pekin, 14 feet high, with a diameter of 13 feet, weighs 53½ tons; those of Olmütz, Rouen, and Vienna, nearly 18 tons; that first cast for the New Palace at Westminster (but cracked),

14 tons; that of the Roman Catholic cathedral at Montreal (cast 1847), 13½ tons; 'Great Peter,'

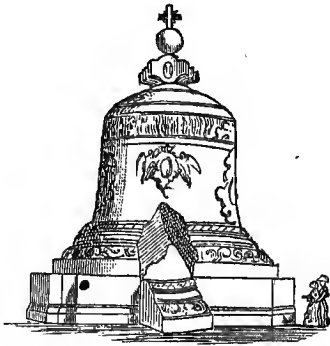

Great Bell at Moscow.

placed in York Minster 1845, 10½ tons; 'Great Tom' at Lincoln, 5½ tons; Great Bell of St Paul's, 5½ tons.—See an interesting article on Bells in the *Quarterly Review* for September 1854.

From old usages, bells are intimately connected with the services of the Christian church—so much so, that apparently from a spirit of opposition, the Mohammedans reject the use of bells, and substitute for them the cry of the Imaum from the top of the mosques. Associated in various ways with the ancient ritual of the church, bells acquired a kind of sacred character. They were founded with religious ceremonies (see Schiller's ode), and consecrated by a complete baptismal service; received names, had sponsors, were sprinkled with water, anointed, and finally covered with the white garment or chrisom, like infants. This usage is as old as the time of Alcuin, and is still practised in Roman Catholic countries. Bells had mostly pious inscriptions, often indicative of the wide-spread belief in the mysterious virtue of their sound. They were believed to disperse storms and pestilence, drive away enemies, extinguish fire, &c. A common inscription in the middle ages was :

Funera plango, fulgura frango, Sabbata pango,
Excito lentos, dissipio ventos, paco cruentos.

Among the superstitious usages recorded to have taken place in old St Paul's Church in London, was the 'ringing the hallowed belle in great tempestes or lightnings' (Brand's *Popular Antiquities*, vol. ii.). From this superstition possibly sprang the later notion, that when the great bell of St Paul's tolled (which it does only on the death of a member of the royal family, or a distinguished personage in the city) it turned all the beer sour in the neighbourhood—a fancy facetiously referred to by Washington Irving in the *Sketch-Book*. It would seem that the strange notion that bells are efficacious in dispelling storms, is by no means extinct. In 1852, the Bishop of Malta ordered the church-bells to be rung for an hour to allay a gale.

Church-bells were at one time tolled for those passing out of the world. It was a prevailing superstition that bells had the power to terrify evil spirits, no less than to dispel storms; and the custom of ringing what was called the *passing-bell*, 'grew [we quote the writer in the *Quarterly Review* above referred to] out of the belief that devils troubled the expiring patient, and lay in wait to afflict the soul the moment when it escaped from

the body.' . . . The tolling of the passing-bell was retained at the Reformation; and the people were instructed that its use was to admonish the living, and excite them to pray for the dying.' But 'by the beginning of the 18th c., the passing-bell, in the proper sense of the term, had almost ceased to be heard. The tolling, indeed, continued in the old fashion; but it took place after the death, instead of before.' The practice of slowly and solemnly tolling church-bells at deaths, or while funerals are being conducted, is still a usage in various parts of the country, more particularly as a mark of respect for the deceased. There is another use of the bell in religion, called the *pardon* or *ave bell*, abolished among Protestants. The pardon-bell was tolled before and after divine service, for some time prior to the Reformation, to call the worshippers to a preparatory prayer to the Virgin Mary before engaging in the solemnity, and an invocation for pardon at its close. Bishop Burnet has recorded the order of a Bishop of Sarum, in 1538, concerning the discontinuance of the custom. It runs thus: 'That the bell called the pardon or ave bell, which of long tyme haths been used to be tolled three tymes after and before divine service, be not hereafter in any part of my diocesse any more tollyd.'

The ringing of the *curfew-bell*, supposed to have been introduced into England by William the Conqueror, was a custom of a civil or political nature, and only strictly observed till the end of the reign of William Rufus. Its object was to warn the public to extinguish their fires and lights at eight o'clock in the evening. The eight o'clock ringing is still continued in many parts of England and Scotland.

As the liberty of public worship in places of meeting by themselves was yielded to dissenters, by the various governments of Europe, only with reluctance, the use of bells in chapels as a summons to divine service is not allowed except in the more enlightened countries. Speaking on this subject as referring to England, Lord Chief-justice Jervis, in giving judgment on a case tried at the Croydon assizes in 1851, says: 'With regard to the right of using bells in places of worship at all, by the common law, churches of every denomination have a full right to use bells, and it is a vulgar error to suppose that there is any distinction at the present time in this respect.' Throughout England and Scotland, however, comparatively few dissenting places of worship possess bells—still fewer have steeple. In towns and villages, the places of worship connected with the established church are commonly distinguished by some kind of belfry or bell-cote with bells. The ringing of these for divine service on Sundays, and on other occasions, forms the theme of many poetical allusions. The lines of Cowper will occur to recollection :

How soft the music of those village bells,
Falling at interval, upon the ear,
In cadence sweet! now dying all away,
Now pealing loud again, and louder still,
Clear and sonorous as the gale comes on.

On all that belongs to the playing of bells in belfries, the inventive genius of the Netherlands long since arrived at proficiency. In some of the church-towers of that country, the striking, chiming, and playing of bells is incessant; the tinkling called chimes usually accompanies the striking of the hours, half-hours, and quarters; while the playing of tunes comes in as a special divertimento. In some instances, these tune-playing bells are sounded by means of a cylinder, on the principle of a barrel-organ; but in others, they are played with keys by a musician. The French apply the term *carillons* to the tunes played

on bells; but in England, it is more usual to give the term *carillons* to the suites of bells which yield this kind of music. In this last sense, the tower of *Les Halles*, a large building at Bruges, is allowed to contain the finest *carillons* in Europe. There is a set of music-bells of this kind in the steeple of St Giles's Church, Edinburgh. On these, tunes are played for an hour daily at certain seasons by a musician, who has a small salary from the civic corporation.

Many of the church-towers in London are provided with peals of bells, the ringing of which is a well-known practice. Eight bells, which form an octave or diatonic scale, make the most perfect peal. The variety of *changes* or permutations of order that can be rung on a peal, increases enormously with the number of bells: 3 bells allow 6 changes; 4 bells, 24; 12 bells give as many as 479,001,600 changes. The ringing of peals differs entirely from tolling—a distinction not sufficiently recognised in those places where an ordinary ringing of bells is made to suffice alike for solemn and festive occasions. The merry peal almost amounts to an English national institution. It consists in ringing the peal in moderately quick time, and in a certain order, without interruption, for the space of an hour. Merry peals are rung at marriages (if ordered), and at other festive events, the ringers being properly paid, according to use and wont. The English appear to be fond of these peals, and the associations which they call up. They actually make bequests to endow periodical peals in their parish church-towers; leaving, for example, so much money to ring a merry peal for an hour on a certain evening of the week, or to commemorate victories, or some other subjects of national rejoicing, in all time coming. One of the most celebrated peals of bells in London is that of St Mary-le-Bow, Cheapside, which form the basis of a proverbial expression meant to mark emphatically a London nativity—'Born within the sound of Bow-bells.' Brand speaks of a substantial endowment by a citizen for the ringing of Bow-bells early every morning to wake up the London apprentices. The ringing of bells in token of merriment is an old usage in England, as we learn from Shakspeare:

Get thee gone, and dig my grave thyself,
And bid the merry bells ring to thy ear,
That thou art crowned, not that I am dead.

Sometimes, in compliment to a newly opened church, efforts are made to furnish its helvesy with the proper number of bells, and to endow it at once for a weekly merry peal. It is common for some of the humbler class of parishioners to form a company of bell-ringers, acting under the authority of the church-wardens. Some endowments for peals embrace a supper, as well as a money-payment to the ringers; and of course, in such circumstances, there is little risk of the merry peal falling into desuetude. The consequence is, that what with marriages, and other festive celebrations, and as a result of endowments, merry peals are almost constantly going on somewhere in the metropolis—a fine proof, it may be said, of the naturally cheerful and generous temperament of the English, and of their respect for old customs. In Lancashire, the art of playing on bells is cultivated with much enthusiasm and success. The bells are small, and arranged on a movable stand; they are struck by a small instrument which is held in each hand of the performer, and produce a sweet tinkling kind of music.

The custom of hanging bells on the necks of horses, cows, and other animals, was in use by the Romans, and survives till our own day. Hung on the necks of horses, the bells give notice of approach

in the dark; and hung on cows, goats, or sheep, these animals can be easily found in the woods, or on the mountains. The charming poetical allusion of Gray—

And drowsy tinklings lull the distant folds—

will be called to remembrance. In some parts of England, as many as eight small bells, forming an octave, are attached to the harness of wagon-horses; and the sounds produced are very pleasant. The attaching of bells in a fanciful manner to riding and sleigh-horses is common in some parts of Europe and America.

The term bell is infused in much of our conversational phraseology. 'To bear the bell,' is a phrase which we previously attempted to explain. At one period, a silver bell was the prize in horse-races in England, and the winning horse was said to bear away the bell. A less probable explanation is, that the phrase originated in the custom of one of the most forward sheep in a flock carrying a bell. Hence, at least, 'bell-wether of the flock,' a phrase applied disparagingly to the leader of a party. The old fable, in which a sagacious mouse proposes that a bell shall be hung on the neck of the cat, so that all the mice may be duly warned of her approach, has given rise to the well-known phrase of 'belling the cat.' Any one who openly and courageously does something to lower the offensive pretensions of a powerful and dangerous person, is said 'to bell the cat.'

The *hanging of bells* in dwelling-houses, and ringing them by means of wires from the different apartments, is quite a modern invention; for it was not known in England in the reign of Queen Anne. Now, the use of room-bells is universal. Lately, there has been a great improvement in domestic bell-hanging. Instead of traversing the apartments, and turning and winding by means of cranks, the wires are carried directly upward in small tubes in the walls to the garret; thence from a row of cranks, they descend together to their respective bells, which are hung in one of the lower passages. In the larger hotels of the United States, wires from the several apartments operate on a single bell, at the same time developing a number on a board corresponding to the number of the room where attendance is required. This ingenious contrivance, which has been introduced into one of the large hotels in Paris, saves the perplexity which would ensue from some hundreds of bells.

BELL, BOOK, AND CANDLE. The excommunication by B., B., and C. is a solemnity belonging to the Church of Rome. The officiating minister pronounces the formula of excommunication, consisting of maledictions on the head of the person anathematised, and closes the pronouncing of the sentence by shutting the book from which it is read, taking a lighted candle and casting it to the ground, and tolling the bell as for the dead. This mode of excommunication appears to have existed in the western churches as early as the 8th c. Its symbolism may be explained by quoting two or three sentences from the conclusion of the form of excommunication used in the Scottish Church before the Reformation: 'Cursed be they from the crown of the head to the sole of the foot. Out be they taken of the book of life. And as this candle is cast from the sight of men, so be their souls cast from the sight of God into the deepest pit of hell. Amen.' The rubric adds: 'And then the candle being dashed on the ground and quenched, let the bell be rung.' So, also, the sentence of excommunication against the murderers of the Archbishop of Dublin in 1534: 'And to the terror and fear of the said damnable persons, in sign and figure that they be accursed of

God, and their bodies committed into the hands of Satan, we have rung these bells, erected this cross with the figure of Christ; and as ye see this candle's light taken from the cross and the light quenched, so be the said cursed murderers excluded from the light of heaven, the fellowship of angels, and all Christian people, and sent to the low darkness of fiends and damned creatures, among whom everlasting pains do endure.'

BELL OF A CAPITAL is the capital of a pillar denuded of the foliage, in which case it resembles the form of a bell reversed.

BELL ROCK, or **INCH CAPE**, a reef of old red sandstone rocks in the German Ocean, 12 miles south-east of Arbroath, and nearly opposite the mouth of the Tay. The reef is 2000 feet long; at spring-tides, part of it is uncovered to the height of four feet; and for 100 yards around, the sea is only three fathoms deep. It was formerly a fruitful cause of shipwreck, and, according to tradition, the abbot of Aberbrothwick (Arbroath) placed a bell on it, 'fixed upon a tree or timber, which rang continually, being moved by the sea, giving notice to the saylers of the danger.' This tradition has been embodied by Southey in his well-known ballad of *The Inchcape Rock*. A light-house, on the plan of the Eddystone one, and a fine example of engineering skill, was completed on the reef in 1811, and

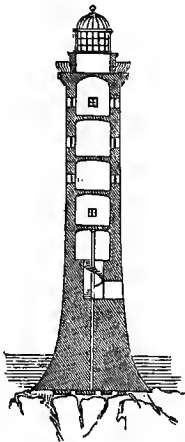

Section of Bell Rock Light-house.

a revolving light exhibited. The structure is 115 feet high, is 42 feet in diameter at base, and 23 at top, is solid for the first 30 feet upwards, 15 feet of which is under water at high tide, and cost upwards of £60,000.

BELL, ANDREW, D.D., author of the 'Madras System of Education,' was born at St Andrews in 1753, and educated at the university of that place. Subsequently, he took orders in the Church of England; and after residing for some time in British America, was appointed one of the chaplains at Fort St George, Madras. While here, he was intrusted by the directors of the East India Company with the management of an institution for the education of the orphan children of the European military. The arduous character of his new duties compelled him to reflect seriously on the best means of fulfilling them. As he found it impossible to obtain the services of properly qualified ushers, he at length resorted to the expedient of conducting the school by the aid of the scholars themselves. Hence originated the far-famed system of 'Mutual Instruction' (q. v.). After superintending the institution for seven years, the state of his health forced him to return to Europe. On his departure, he received a most flattering testimonial from the directors of the school. In 1797, after his arrival in England, B. published a pamphlet entitled *An Experiment in Education, made at the Male Asylum of Madras; suggesting a System by which a School or Family may teach itself under the Superintendance of the Master or Parent*. This pamphlet attracted little attention, until Joseph Lancaster, a dissenter, commenced to work upon the system, and succeeded in obtaining for it a large measure of public recognition. In 1803, Lancaster also

published a tractate on education, recommending the monitorial system, as it was now called, and admitting B. to be the original inventor of it, an admission which he afterwards discredibly retracted. Lancasterian schools now began to spread over the country. The church grew alarmed at the successful results of the efforts made by dissenters to educate the poor, and resolved to be philanthropical ere it was too late. B. was put up against Lancaster. Money was collected, and an immense amount of emulation was excited in the bosoms of churchmen. Fortunately, however, this rivalry produced only beneficial effects, and the motives which induced it may therefore be forgotten. Later in life, B. was made a prebendary of Westminster, and Master of Sherborn Hospital, Durham. He was also a member of various learned societies. He died at Cheltenham, January 28, 1832. He left (besides a valuable estate) £120,000 of three per-cent. stocks for the purpose of founding various educational institutions in Edinburgh, Glasgow, Leith, Aberdeen, Inverness, Cupar, and St Andrews.

BELL, SIR CHARLES, an eminent surgeon, whose discoveries in the nervous system have given him a European fame, was born at Edinburgh in 1778, and while a mere youth, assisted his brother John (afterwards noticed) in his anatomical lectures and demonstrations. In 1797, he was admitted a member of the Edinburgh College of Surgeons, and soon after appointed one of the surgeons of the Royal Infirmary. In 1806, he proceeded to London, and for some years lectured with great success on anatomy and surgery at the academy in Great Windmill Street. Admitted, in 1812, a member of the Royal College of Surgeons, London, he was elected one of the surgeons of the Middlesex Hospital, in which institution he delivered clinical lectures, and raised it to the highest repute. To obtain a knowledge of gunshot wounds, he twice relinquished his London engagements—the first time after the battle of Corunna in 1809, when he visited the wounded landed on the southern coasts of England; the other, after the battle of Waterloo, when he repaired to Brussels, and was put in charge of a hospital with 300 men. In 1824, he was appointed senior Professor of Anatomy and Surgery to the Royal College of Surgeons, London, and subsequently a member of the council. On the establishment of the London University, now University College, in 1826, B. was placed at the head of their new medical school. He delivered the general opening lecture in his own section, and followed it by a regular course of characteristic lectures on physiology; but soon resigned, and confined himself to his extensive practice, which was chiefly in nervous affections. In 1831, he was one of the five eminent men in science knighted on the accession of William IV., the others being Sir John Herschel, Sir David Brewster, Sir John Leslie, and Sir James Ivory. In 1836, he was elected Professor of Surgery in the university of Edinburgh. He was a fellow of the Royal Societies of London and Edinburgh, and a member of some other learned bodies. Author of various works on surgery and the nervous system, and editor, jointly with Lord Brougham, of Paley's *Evidences of Natural Religion*, B. was one of the eight distinguished men selected to write the celebrated Bridgewater Treatises, his contribution being on *The Hand, its Mechanism and Vital Endowments, as evincing Design* (1834). He died suddenly, April 30, 1842. Among his principal works are: *The Anatomy of the Brain Explained, in a Series of Engravings*, 12 plates (Lond. 1802, 4to); *A Series of Engravings, explaining the Course of the Nerves* (Lond. 1804, 4to); *Essays on the Anatomy*

of *Expression in Painting*, plates (Lond. 1806, 4to); posthumous edition, much enlarged, entitled *The Anatomy and Philosophy of Expression as connected with the Fine Arts* (Lond. 1844, 8vo); *A System of Operative Surgery*, 2 vols. (Lond. 1807—1809; 2d ed. 1814); *Dissertation on Gunshot Wounds* (Lond. 1814, 2 vols. 8vo); *Anatomy and Physiology of the Human Body*, 3 vols. (1816); various papers on the nervous system, which originally appeared in the *Philosophical Transactions*; *Exposition of the Natural System of the Nerves of the Human Body* (1824); *Institutes of Surgery* (Edin. 2 vols. 1838, 12mo); *Animal Mechanics*, contributed to the *Library for the Diffusion of Useful Knowledge* (1828); *Nervous System of the Human Body*, 1830, 4to complete edition (Edin. 1836, 8vo).

BELL, GEORGE JOSEPH, an eminent lawyer, brother of the above, was born at Edinburgh 26th March 1770, and passed advocate in 1791. Acknowledged one of the greatest masters of commercial jurisprudence of his time, and in particular of that department of it which relates to the laws of bankruptcy, he was, in 1822, appointed Professor of Scots Law in Edinburgh University; and in 1823, a member of the commission for inquiring into Scottish judicial proceedings. Subsequently, he was member of a commission to examine into and simplify the mode of procedure in the Court of Session. On the report, drawn up by B., was founded the Scottish Judicature Act, prepared by him, which effected many important changes in the forms of process in the superior courts of Scotland; the jury court being abolished as a separate judicature, and conjoined with the Court of Session. Appointed in 1831 one of the clerks of the Court of Session, he was, in 1833, chairman of the Royal Commission to examine into the state of the law in general. He also prepared a bill for the establishment of a Court of Bankruptcy in Scotland. His principal works are—*Commentaries on the Laws of Scotland, and on the Principles of Mercantile Jurisprudence* (Edin. 1810, 4to; 5th ed. 1826, 2 vols. 4to); *Principles of the Law of Scotland* (Edin. 1829, 8vo; 4th ed. 1839, 8vo); and *Commentaries on the Recent Statutes Relative to Diligence or Execution against the Movable Estate, Imprisonment, Cessio Bonorum, and Sequestration in Mercantile Bankruptcy* (Edin. 1840, 4to). Died 23d September 1843.

BELL, HENRY, the successful introducer of steam-navigation into Europe, fifth son of Patrick Bell, a mechanic, was born at Torphichen, Linlithgowshire, Scotland, April 7, 1767. After working three years as a stone-mason, he was, in 1783, apprenticed to his uncle, a mill-wright. He was instructed in ship-modelling at Borrowstounness, and completed his knowledge of mechanics with an engineer at Bell's Hill. Repairing to London, he was employed by the celebrated Mr Rennie. About 1790 he returned to Glasgow, and in 1808 removed to Helensburgh, where he kept the principal inn, and devoted himself to mechanical experiments. How far B. was anticipated by Fulton and others, in his application of steam to navigation, will be considered under the head of STEAM NAVIGATION. In January 1812, a small vessel, 40 feet in length, called the *Comet*, built under his directions, and with an engine constructed by himself, was launched on the Clyde with success—the first on European waters. Five years previously, on October 3, 1807, Mr Fulton, a Scottish engineer in America, had placed the first steam-boat on the Hudson. B. died at Helensburgh, November 14, 1830. A monument was erected to his memory at Duglass Point on the Clyde.

BELL, JOHN, of Antermony, a celebrated Asiatic traveller, born in the west of Scotland in 1691, studied for the medical profession. In 1714, he went to St Petersburg, and soon after was appointed physician to an embassy from Russia to Persia. In 1719, he was sent upon another to China, through Siberia. In 1737, he was sent on an embassy to Constantinople, and afterwards settled for some years in the Turkish capital as a merchant. In 1747, he returned to Scotland, and died at Antermony, July 1, 1780. His *Travels from St Petersburg to various Parts in Asia*, in 2 vols. 4to, were published by subscription at Glasgow in 1763. From its simplicity of style, the work has been described as 'the best model, perhaps, for travel-writing in the English language.'

BELL, JOHN, an eminent surgeon, second son of the Rev. William Bell, an Episcopal minister in Edinburgh, was born in that city, May 12, 1763. He studied under the celebrated Black, Cullen, and Monro *secundus*; and while attending the anatomy classes of Dr Monro, first conceived the idea of teaching the application of the science of anatomy to practical surgery. He commenced, in 1786, lecturing at Edinburgh on surgery and anatomy, and in 1793 published the first volume of his *Anatomy of the Human Body*; in 1797, appeared the second volume; and in 1802, the third. A volume of anatomical drawings by himself, illustrative of the structure of the bones, muscles, and joints, was published in 1794; and another volume, illustrative of the arteries, with drawings by his brother, afterwards Sir Charles Bell, appeared in 1801. In 1798, B. passed some weeks at Yarmouth among the seamen of Lord Duncan's fleet wounded at Camperdown; and in 1800 he published a *Memorial concerning the Present State of Military Surgery*. His *System of the Anatomy of the Human Body*, and his *Discourses on the Nature and Cure of Wounds* (Edin. 1793—1795), were translated into German. A good classical scholar, he was distinguished alike for his great conversational powers and general information. Early in 1816, he was thrown from his horse, and, his health declining, he went to Paris, and thence proceeded to Italy. He died at Rome, of dropsy, April 15, 1820. Besides the works mentioned, he was the author of *The Principles of Surgery*, 3 vols. 4to, 1801—1807; new edition, edited by his brother, Sir Charles Bell, 1826. A posthumous work, entitled *Observations on Italy*, edited by Bishop Sandford of Edinburgh, was published by his widow.

BELL, JOHN, an eminent sculptor, remarkable for rejecting the classical antique model, and following nature only in his works, born in Norfolk in 1800, first exhibited at the Royal Academy, London, in 1832, a religious group. His works are numerous, and of high and original merit. B.'s statues of Lord Falkland, exhibited in model at Westminster Hall, 1847, and Sir Robert Walpole, 1854, were commissioned for the new Houses of Parliament. One of his latest designs is a monument to the Guards who fell in the Crimea, executed in 1858. In decorative art, he has also distinguished himself, having modelled many objects for the drawing-room table, combining the practical with the ornamental. B. is the author of a *Free Hand Drawing-book, for the Use of Artisans*.

BELL, ROBERT, an industrious and versatile literary writer, the son of a magistrate, was born at Cork, 10th January 1800, and when very young, obtained an appointment in a government department in Dublin. He was for a time editor of the government journal, *The Patriot*. In 1828, he removed to London, and was appointed editor

of *The Atlas* newspaper. In 1839, in conjunction with Sir Edward Bulwer Lytton and Dr Lardner, he started *The Monthly Chronicle*, a literary periodical, published by Longman & Co.; and latterly was editor of it. In 1841, he retired from *The Atlas*. For Lardner's *Cyclopædia*, B. wrote *The History of Russia*, 3 vols., and *The Lives of the English Poets*, 2 vols. The last volume of Southey's *Naval History*, left unfinished by the author, was also written by him, as was the concluding volume of Mackintosh's *History of England*. At the London theatres, three five-act comedies have been produced by him. He is author, also, of *The Ladder of Gold*, a novel, 3 vols., 1850; *Heart and Altars*, a collection of tales, 3 vols.; *Life of Canning*; *Outlines of China*; *Memorials of the Civil War*, consisting of the Fairfax correspondence, 2 vols.; *Way-side Pictures through France, Belgium, and Holland*. In 1854, he commenced an annotated edition of the English poets; and received from the king of the Belgians a gold medal, as a token of his majesty's sense of his services to literature.

BELL, THOMAS, a distinguished naturalist, the son of a medical practitioner, was born at Poole, Dorsetshire, in 1792. In 1814, he went to London, and studied at Guy's Hospital, and in 1815, passed the College of Surgeons. In 1817, he commenced a course of annual lectures on dental surgery at Guy's Hospital, where he also for some time delivered lectures on comparative anatomy. He was one of the founders of, and a principal contributor to, *The Zoological Journal*, of which five volumes were published; also one of the members of the Zoological Club of the Linnean Society, afterwards incorporated with the Zoological Society. Elected in 1828 a Fellow of the Royal Society, in 1840 he was appointed its secretary. In 1836, he became Professor of Zoology in King's College, London. On the establishment of the Ray Society, in 1844, for the publication of rare and costly works on natural history, he was elected its first president. In 1853, he resigned the secretaryship of the Royal Society, on being elected president of the Linnean Society. He is author of a *History of British Reptiles*, in Van Voors's series of British natural history, 1829; a *History of British Quadrupeds*, same series, 1836; and a *History of the British Stalk-eyed Crustacea*, same series, 1853. In 1833, he commenced a *Monograph of the Testudinata*. The article 'Reptiles,' in Darwin's *Zoology of the Voyage of the Beagle*, was written by Bell. It has been the happy but deserved good-fortune of Professor Bell to become proprietor of the manor of Selborne, endeared to all naturalists by the observations of the celebrated Gilbert White.

BELLA, a thriving town of Naples, in the province of Basilicata, with a population of between 5000 and 6000.

BELLA, STEFANO DELLA, a famous Italian engraver, was born at Florence, 18th May 1610. He was intended for a goldsmith, but he soon left that calling, and devoted himself to engraving. He executed upwards of 1400 different works, of almost all subjects—battles, sea-pieces, landscapes, animals, &c. All are characterised by freedom and delicacy, and give evidence of high imagination on the part of the author, and also of much patient and careful manipulation. One of his most admired works is a view of the Pont-Neuf, Paris. He died 12th July 1664.

BELLADO'NNA, DWALE, or DEADLY NIGHTSHADE (*Atropa Belladonna*), a plant of the natural order *Solanaceæ* (q. v.); an herbaceous perennial, growing up every year as a bush, from two to six feet high, with ovate entire leaves, and

bell-shaped flowers of a lurid purple colour, which are fully larger than those of the common harebell, stalked and solitary in the axils of the leaves. It produces berries, of the size of a middle-sized cherry,



Belladonna.

a, part of a branch with leaves and flowers; b, fruit, with persistent calyx.

and which, when ripe, are of a shining black colour, and of a sweetish and not nauseous taste, although the whole plant has a disagreeable heavy smell. It is a native of the southern and middle parts of Europe, and is not uncommon in England, in the neighbourhood of towns and of ruins. All parts of the plant are narcotic and poisonous, and fatal consequences not unfrequently follow from the eating of its berries, which have an inviting appearance. Its roots have sometimes been mistaken for parsnips. Dryness of the mouth and throat, dilatation of the eyes, obscurity of vision, paralytic tremblings, loss of sensation, delirium, and stupor, are among the effects of poisoning by belladonna. When death takes place from this cause, corruption ensues with extraordinary rapidity. B. is, however, of great value in medicine, soothing irritation and pain, particularly in nervous maladies, and is administered both internally and externally, in the form of extract, tincture, ointment, and plaster, which are generally prepared from the dried leaves, sometimes from the root. It is particularly useful, from its power of dilating the pupil of the eye, and is constantly employed by oculists both for examinations and operations. It is also applied to the eye to diminish the sensibility of the retina to light. It has recently been recommended as a preventive of scarlet fever, apparently on the ground of its tendency, when administered in frequent small doses, to produce an eruption and an affection of the throat, somewhat similar to those characteristic of that disease; but the evidence of its utility for this purpose is not sufficient to warrant confidence.—The name B., i. e., Fair Lady, is supposed to have originated in the employment of the juice for staining the skin. The name Dwale is apparently from the same root with the French *deuil*, grief—an allusion to the same qualities which have obtained for the plant the appellation of Deadly Nightshade. *Atropa* is from *Atropos*, one of the Fates.—The other species of *Atropa* are South American.

B. owes its active properties on the animal system to the presence of the alkaloid *Atropine*, accompanied by another alkaloid, *Belladonnine*. The alkaloid atropine is present in all parts of the plant, and in all the preparations. It is generally procured from the root of B., and then forms

needle-shaped crystals, which are sparingly soluble in water, but readily dissolve in alcohol and ether. Atropine is a very active poison, and its effects on the animal system resemble in an intensified degree the manner in which B. acts. It has recently been introduced into medicine, along with its nitrate, its sulphate, and its hydrochlorate.

BELLADONNA LILY (*Amaryllis Belladonna*), a very beautiful species of *Amaryllis* (q. v.), with rose-coloured drooping flowers clustered at the summit of the leafless flowering stem. It is a native of the Cape of Good Hope and of the West Indies, has become naturalised in Madeira, and is a not unfrequent ornament of gardens in England. The flowering stem is about 18 inches high.

BELLAMY, JACOBUS, a distinguished Dutch poet, was born at Vliessing (Flushing), November 12, 1757, and died March 11, 1786. His parents were very poor, and he was indebted for his education to the patronage of a clergyman, and other persons, who had seen and admired the patriotic effusions of his boyish muse, and who subscribed to send him to the university of Utrecht. Here the talents already remarked in B. were devoted chiefly to poetry, though his benefactors had hoped that he would devote himself to theology. His first sentimental and anaerontic poems, published at Amsterdam in 1782, were followed by a series of earnest patriotic poems (*Vaderlandsche Gezangen*), and in the same year, a third volume full of merit (1785). A collected edition of his works appeared at Haarlem (1826), but it does not contain his most popular poem, *Roozje*. B. was possessed of a glowing spirit and fancy, as well as a fine taste and ease in composition. He deservedly ranks as one of the chief restorers of national literature in Holland.

BELLARMINÉ, ROBERT, one of the most celebrated Catholic theologians, was born at Monte Pulciano in Tuscany, October 4, 1542. He entered the order of Jesuits in 1560, and was distinguished among his *confères* by the zeal with which he studied theology, the church-councils, the Fathers, Hebrew, history, and the canon law. In 1563, he gave lessons in polite literature and astronomy at Florence; and in rhetoric, at Mondovi, 1564—1567. In his twenty-seventh year, when he went to Louvain as professor of theology, he began that long controversy with 'heretics' which formed the main business of his life. In 1599, when he was made a cardinal against his own inclination, he used his influence over Pope Clement VIII. to prevent the introduction of the Platonic philosophy into the university of Rome, on the ground of its being 'pernicious;' but though himself a Jesuit, he honourably opposed the Dominicans with regard to the Pelagian writings of Molina. He seems, however, to have participated to some extent in that writer's suicidal ethics, for in his *Disputationes* he argues that, as the pope is the supreme authority in doctrine and morals, if he should call virtue vice, and vice virtue we are bound to believe him, and to act accordingly. In 1602, he was appointed Archbishop of Capua. After the death of Clement VIII., he contrived to escape promotion to the papal chair, but was induced by Pius V. (1605) to hold an important place in the Vatican, where he remained until the time of his death, which took place in the Novitiate-house of the Jesuits, September 17, 1621. In his work, *De Potestate Pontificis in Temporalibus* (On the Pope's Power in Secular Matters), he introduced the doctrine that the pope must be held as supreme over all kings. On this account, the book was condemned as treasonable in Paris, Venice, and Mentz. His chief work contains the disputations held in the Jesuits' College at Rome, 1576—1581, *Disputationes*

de Controversiis Fidei adversus hujus Temporis Hereticos (3 vols., Rome, 1581; 4 vols., Prague, 1721; 4 vols., Mayence, 1842). These disputations are regarded by Catholics as the best arguments for their tenets. There can be no question of their merits with regard to erudition and adroitness in controversy; but as Gerhard, in his *Bellarminus Orthodoxias Testis* (Jena, 1631—1633), and Dallæus have shewn, many of the conclusions are far from being sound or logical. Industry, clearness, and acuteness are the chief merits of B.'s great work; but it is seriously lessened in value by subtlety, forced conclusions, and a very defective exegesis—faults which have long been evident to enlightened Catholic writers themselves. Among his other writings, the most able is the *Christianæ Doctrinæ Applicatio*, originally written in Italian, and now translated into all the European languages. Pope Urban VIII., at the instigation of the Jesuits, declared B. to be a 'faithful servant of God;' but his canonisation as a saint has hitherto been opposed. Complete editions of his works have been published at Venice, 5 vols., 1721; and Cologne, 7 vols., 1619. His life was written in Italian by the Jesuit Fuligatti (Rome, 1624); and translated into Latin by Petra Sancta (Liege, 1626).

BELLARY, a district of British India in the presidency of Madras, bounded on the N. by the Nizam's territories, on the E. by Cuddapah, on the S. by Mysore, and on the W. by Dharwar. With an area of 13,056 square miles, it extends in N. lat. between 13° 40' and 15° 58'; and in E. long. between 75° 44' and 78° 19'. Pop. 1,229,599. The main peculiarities of the district are connected with its situation. Elevated on the east slope of the West Ghauts, B. enjoys so healthy a climate that it has been officially recommended as the site of a sanatorium for the neighbouring provinces. Screened by the Ghauts from the south-west monsoon, and protected against the north-east one by its distance from the Bay of Bengal, B. receives, on an average, less rain than any other portion of Southern India—the annual fall ranging between about 12 inches and about 26 inches. Hence all its subordinate streams become, in the dry season, mere expanses of sand, which, excepting when bound together by the growth of the nuth-grass, is apt to encroach from year to year, like a glacier, over the bordering grounds. B., in fact, may in a great measure be said to be habitable through artificial means. Irrigation, though rude, is yet ingenious; dug wells amount to 22,000; of tanks there are 1400; and weirs or dams of huge stones, to the number of 331, cross the various water-courses, so as to form, after the rains, so many reservoirs.

BELLARY, the chief town of the above district, is situated about 380 miles south-east of Bombay, and 270 north-west of Madras. Lat. 15° 8' N., and long. 76° 59' E. As one of the principal military stations in the presidency of Madras, it is connected by good roads with Belgaum, Bangalore, Hyderabad, and Madras itself. The fort stands on a rock two miles round, and 450 feet high; and is supplied with water from tanks excavated in the solid granite. Besides the fort and adjacent cantonments, B. contains a native town, which, in 1836, numbered 30,426 inhabitants.

BELL-BIRD (*Casmarynchus carunculata*), a bird found in some of the warm parts of South America, remarkable for the metallic resonance of its cry, which resembles the tolling of a bell, with pauses varying from a minute to several minutes. This bird belongs to a genus nearly allied to the Cotingas (q. v.) and Wax-wings (q. v.), but characterised by a very broad and much depressed bill, soft and flexible

at the base, and hard towards the extremity. It is about the size of a jay; the male is of snow-white plumage, and from his forehead rises a strange tubular appendage, which, when empty, is pendulous, but which can be filled with air by a communication from the palate, and then rises erect to the height of nearly three inches. He generally takes his place on the top of a lofty tree, and his tolling can be heard to the distance of three miles. It resounds through the forest, not only at morning and evening, but also at mid-day, when the heat of the blazing sun has imposed silence on almost every other creature.

BELLE-ALLIANCE, the name of a farm in the province of Brabant, Belgium, 13 miles south of Brussels. It has become famous as the position occupied by the centre of the French army in the battle of Waterloo, June 18, 1815. The Prussians gave the name B. to this decisive battle; the French named it from Mont-Saint-Jean, the key of the British position, about two miles to the north; but the English name, Waterloo (q. v.), taken from the village where Wellington had his head-quarters, is now commonly used.

BELLE DE NUIT (Fr., Beauty of the Night), a name given to certain tropical species of *Convolvulaceæ*, with extremely beautiful and fragrant flowers, which open only during the night. The species to which perhaps the name more particularly belongs, is *Calonyction Bona Nox*, a native of the forests of the West Indies and of tropical America, with twining stem, spiny branches, heart-shaped leaves, and exquisitely beautiful white flowers of five or six inches in diameter, which are produced in large many-flowered corymbs.

BELLEGARDE, a hill-fortress of France, in the department of Pyrénées Orientales. It is situated on the Spanish confines on the road from Perpignan to Figueras, and in the pass between Col de Portus on the east, and Col de Panizas on the west. Here the French, under Philip III., were defeated by Peter III. of Arragon in 1285. In the 14th c., B. consisted only of a fortified tower. It was captured by the Spaniards in 1674, and again by the French under Marshal Schomberg in 1675. After the peace of Nimeguen, 1678—1679, a regular fortress, with five bastions, was erected here by order of Louis XIV. In 1793, it was blockaded and taken by the Spaniards under Ricardos, but was retaken by the French in the following year.

BELLE ISLE, an island in the Atlantic, about midway between the north-west of Newfoundland and the south-east of Labrador, in lat. 52° N., and long. 56° W. Although on the parallel of Essex in England, it yields little but potatoes and ordinary vegetables. It is chiefly known as giving name to the adjacent strait on the south-west, which, separating Labrador from Newfoundland, forms the most northerly of the three channels between the Gulf of St Lawrence and the open ocean.

BELLEISLE-EN-MER, an island belonging to France in the department Morbihan, in the Atlantic, 8 miles south of Quiberon Point. Its length is 11 miles, and its greatest breadth 7. Pop. about 9000, chiefly engaged in pilchard-fishing. Salt is made on the island. B. is a place of considerable antiquity. The chief town is *Palais*, a seaport and fortified place. In the 9th c., B. came into the possession of the Count of Cornouailles, who bestowed it on the abbey of Redon, afterwards on the abbey of Quimperlé. In the 16th c., the monks of Quimperlé ceded the island to Charles IX., who gave it as a marquisate to the Marshal de Retz, who fortified it. His successor sold the island in 1658 to Fouquet, intendant of finance, who further improved and

strengthened it. His grandson, the celebrated Marshal Belleisle, ceded the island to Louis XV. in exchange for the comté Gisors, 1718. In 1761, it was captured by the English fleet under Keppel, and restored in 1763.

BELLENDEN (BALLANTYNE), JOHN, Archdeacon of Moray, a Scottish writer in the reigns of James V. and Queen Mary, regarding whose personal history little is known with certainty. He is frequently confounded with a contemporary of the same name, Sir John Bellenden of Auchinvole, who held the offices of Lord Justice-Clerk and director of the Chancery at that time, and took a considerable part in political affairs. The works by which the archdeacon established his claim to an honourable place among Scottish literary men, are his translations of Boece's *Scottish History*, and of the first five books of Livy, both interesting as specimens of the Scottish prose of that period, and remarkable for the ease and vivacity of their style. To these works are prefixed poetical prologues; and appended to the Scottish history is an epistle to the king, written in a free and manly strain of admonition. B. had enjoyed some share of favour at the court of James, at whose request he executed the translations. As the reward of his performances, he received grants of considerable value from the treasury, and afterwards was made Archdeacon of Moray and Canon of Ross. The translation of Livy was first published in 1822 by Mr Thomas Maitland (afterwards Lord Dundrennan), uniform with his edition of Boece in the previous year (Edin., 2 vols. 4to).

BELLENDEN, WILLIAM, a Scottish author in the time of Queen Mary and James VI. His personal history is meagre and obscure; all that we know being the testimony of Dempster (*Hist. Eccl.*), that he was a professor in the university, and an advocate in the parliament of Paris, and that he was employed in a diplomatic capacity by Queen Mary, and also by her son, who conferred on him the honorary appointment of Master of Requests. His first work, entitled *Ciceronis Princeps*, &c., was published at Paris in 1608; his next, *Ciceronis Consul, Senator*, &c., in 1612. Both these works are compilations from the writings of Cicero, and exhibit in a systematic form, and in the words of the original, all the information and reflections scattered throughout his works on the subjects of regal, consular, and senatorial government. His next work, *De Statu Prisci Orbis*, appeared in 1615, and consists of a condensed sketch of the history and progress of religion, government, and philosophy in ancient times. These three works he soon after republished in a collected form. His crowning labour, *De Tribus Luminibus Romanorum*, was published after his death. The 'three luminaries' were Cicero, Seneca, and Pliny, out of whose works he intended to compile, on the same plan as his previous works, a comprehensive digest of the civil and religious history, and the moral and physical science of the Romans. The first of these only was completed, and forms a remarkable monument of B.'s industry and ability. 'B.,' says Mr Hallam, 'seems to have taken a more comprehensive view of history, and to have reflected more philosophically on it than perhaps any one had done before; at least I do not remember any work of so early an age which reminds me so much of Vico and the *Grandeur et Decadence* of Montesquieu.' B.'s works are supposed to have furnished the materials for Dr Middleton's *Life of Cicero*, though that learned divine abstains from any allusion to his predecessor. An edition of B.'s *De Statu* was published in 1787 by Dr Parr, with an elaborate, political, and somewhat pedantic preface in Latin.

BELLE'ROPHON, a genus of univalve shells, known only as a fossil. Montfort, who established the genus, placed it among the chambered Cephalopoda. It was subsequently associated with the living Argonaut, but is now generally considered as a genus of De Blainville's Nucleobranchiata (q. v.), having as



Bellerophon tangentialis.

its nearest ally the genus *Atlanta*; from which, however, it differs in having a strong shell. The shell of the B. is symmetrically convolute, with few and occasionally sculptured whorls, globular or discoidal, and having a dorsal keel, which terminates in a deep notch in the sinuous aperture. It is a palæozoic organism, extending from the lower silurian to the carboniferous series. Seventy species have been described.

BELLE'ROPHON (originally called **HIPPONOUS**) was the son of the Corinthian king Glaucus, and Eurymede, daughter of Sisyphus. Other accounts make Neptune his father. Having accidentally killed his brother, B. fled to his relative Proetus, king of Argos, by whom he was hospitably received and protected; but Antea, the spouse of Proetus, having become enamoured of him, and he, like Joseph, having declined her overtures, she revenged herself after the manner of Potiphar's wife. This induced Proetus to send his guest away to Iobates, king of Lycia, to whom B. carried a sealed message. After being entertained nine days at the court of Lycia, B. delivered the letter, which contained a request that Iobates would cause the youth to be slain. This, however, Iobates was reluctant to do in a direct way, as B. was his guest. He consequently imposed upon B. the seemingly impossible task of slaying the formidable Chimæra (q. v.). B., mounted on the winged steed Pegasus (given to him by Pallas), ascended into the air, and succeeded in slaying the monster with his arrows. Afterwards, he was sent by King Iobates against the Amazons, whom he defeated. On his way home he destroyed an ambuscade of Lycians, which Iobates had set for his destruction. That monarch now thought it useless to attempt his death, and as a sort of recompense, gave the hero in marriage his daughter Philonoë, by whom he had three children—Isander, Hippolochus, and Laodameia; such at least is the story as told by Apollodorus, who here concludes. Homer relates that he at last drew on himself the hatred of the gods, and wandered about in a desolate condition through the Aleian field. Pindar relates that B. on Pegasus endeavoured to mount to Olympus, when the steed, maddened by Jove through the agency of a gadfly, threw his rider, who was stricken with blindness. B.'s adventures were a favourite subject of the ancient artists. Sculptures have recently been discovered in Lycia which represent him vanquishing the Chimæra.

BELLES-LETTRES, a term adopted from the French into the English and various other languages. It is generally used in a vague way to designate the more refined departments of literature, but has in fact no precise limits. In English usage it is synonymous with another vague expression, *polite literature*, including history, poetry, and the drama, fiction, essay, and criticism.

BELLEVILLE, a town of France, in the

department of the Seine, forming a suburb of Paris, and enclosed by the new fortifications. It has manufactories of cashmeres, varnished leather, articles of polished steel, chemical stuffs, &c. There are springs at B. which have supplied Paris with water from a very early date, and it has tea-gardens and other places of amusement much resorted to by the Parisians. Pop. 56,833.

BELLEY, a town of France in the department of Ain, is a place of great antiquity, and was at one time strongly fortified. The finest lithographing stones in France are procured here. Pop. about 4000.

BELL-FLOWER. See **CAMPANULA**.

BELLI'NI, the name of a Venetian family which produced several remarkable painters. The earliest was **JACOPO B.**, who died in 1470. He was a pupil of the celebrated Gentile da Fabriano, and one of the first who painted in oil. His eldest son, **GENTILE B.**, born 1421, died 1501, was distinguished as a portrait-painter, and also as a *medaillieur*. Along with his brother, he was commissioned to decorate the council-chamber of the Venetian senate. Mohammed II., having by accident seen some of his works, invited Gentile to Constantinople, employed him to execute various historical works, and dismissed him laden with presents. The *Preaching of St Mark* is his most famous achievement. His more celebrated brother, **GIOVANNI B.**, born 1422, died 1512, was the founder of the older Venetian school of painting, and contributed greatly to its progress. His works are marked by naïveté, warmth, and intensity of colouring. His best works are altar-pieces. His picture of the *Infant Jesus* slumbering in the lap of the Madonna, and attended by angels, is full of beauty and lively expression. His *Holy Virgin*, *Baptism of the Lord*, and *Christ and the Woman of Samaria*, are also much admired. Among his numerous pupils the most distinguished were Giorgione and Titian.

BELLI'NI, VINCENZO, one of the most popular modern opera composers, was born at Catania, in Sicily, November 1, 1802, and died at Puteaux, near Paris, September 24, 1835. He received his early education at the Conservatory of Naples, and was subsequently instructed in composition by Tritto and Zingarelli. After making some attempts, without much success, in instrumental and sacred music, he brought forward, in 1825, the opera *Andelson e Salvina*, which was played in the small theatre of the Royal College of Music (Naples). Another opera, *Bianco e Gerardo*, was given in the theatre St Carlo (1826) with such success that, in 1827, Bellini was commissioned to write a piece for *La Scala* at Milan. This opera, *Il Pirata*, was the first which carried the composer's name beyond Italy. It was followed with equal success by *La Straniera*, 1829, and by *I Capuletti ed i Montecchi*, written for the theatre of Venice, 1830, which was the culmination of the fame of B., though it by no means exhausted his productive powers. *La Sonnambula* and *Norma* appeared in 1831, and *Beatrice di Tenda* in 1833. In the same year the composer went to Paris, where he became acquainted with other forms of music beside the Italian. He was received with great applause in London, and after his return to Paris, wrote his opera *I Puritani*, which shews the influence of the French school of music, but without servile imitation. At an early age the career of B. was interrupted by death, before the composer had fully developed his powers. He was the most genial and original of all the followers of Rossini, and though inferior to his master in exuberance of fancy, is superior in carefulness and finish, especially in the due subordination of instrumental decorations to

vocal melody. In private he was highly esteemed for the purity and affectionateness of his character.

BELLINZO'NA, or **BE'LENZ**, a town of Switzerland, in the canton of Tessin or Ticino, on the left bank of the river of that name, and the seat of the provincial government, alternately with Lugano and Locarno. It is guarded by three old castles, and completely commands the passage of the valley in which it is situated. In former times, it was considered a place of great military importance, and was the scene of frequent conflicts between the Italians and Swiss; the latter of whom finally made themselves masters of it about the beginning of the 16th c. As an entrepôt for the merchandise of Germany and Italy, it is now a place of considerable commercial importance, though the population is but small—about 2000.

BELLIS. See **DAISY**.

BELLO'NA, the goddess of war among the Romans, was described by the poets as the companion, sister, wife, or daughter of Mars; she was also represented as armed with a bloody scourge, and as inspiring her votaries with a resistless enthusiasm in battle. In the war with the Samnites, the Consul Appius Claudius vowed a temple to B., which was erected afterwards on the field of Mars. In this temple the senate gave audience to embassies from foreign powers, and also to consuls who had claims to a triumph which would have been nullified by entrance into the city. The priests of the goddess were styled *Bellonarii*, and practised sanguinary rites; such as cutting their own arms or feet, and offering (or even drinking) the blood in sacrifice. This was especially done on the *dies sanguinis* (day of blood), March 24.

BELLOT, **JOSEPH RENÉ**, a lieutenant in the French navy, who perished in the arctic regions, in search of Sir John Franklin, was born in Paris, 18th March 1826, and educated at Rochefort, in the Naval School. In the French expedition against Tamatave, in 1845, he gave proof of so much courage and presence of mind, that the Cross of the Legion of Honour was conferred on him before he had attained his twentieth year. In May 1851, he joined the expedition then preparing in England for the polar regions, in search of Sir John Franklin, and sailed in the *Prince Albert*, Kennedy commander, sent out by Lady Franklin. Distinguished by his noble daring and spirit of enterprise, he took part in several explorations. In one of these he made an important geographical discovery, to which his name was given—*Bellot Strait* (q. v.). On his return, he was promoted to the rank of navy lieutenant. In the expedition fitted out by the British Admiralty, under Captain Inglefield, he sailed as a volunteer, in H.M.S. *Phœnix*; but never returned, having been carried by a violent gust of wind, 21st March 1853, into a deep crack in the ice on which he was travelling. A considerable sum was subscribed in England for a monument to his memory. His *Journal of a Voyage to the Polar Seas made in Search of Sir John Franklin in 1851—1852*, edited, with a notice of his life, by M. Julien Lemer, 2 vols., was published at Paris in 1854. English translation. London, 1855.

BELLOT STRAIT, the passage which separates North Somerset from Boothia Felix, and connects Prince Regent's Inlet with Peel Strait or Sound, or, in M'Clintock's new nomenclature, Franklin Channel. Its east entrance was discovered by Kennedy during his search for Franklin, and he, assuming the continuity of the opening, classified it accordingly, naming it after his lamented companion Bellot. After four unsuccessful attempts, it was explored for the first and perhaps last

time by M'Clintock on his crowning voyage. It is about 20 miles long, and, at its narrowest part, about 1 mile wide, running pretty nearly on the parallel of 72°, between granite shores which, everywhere high, rise here and there to 1500 or 1600 feet. Through this funnel both the winds and the waters have full play; the latter, permanent currents and flood-tides alike, coming from the west. To the most northerly point on the south shore, M'Clintock has given the name of Murchison Promontory, which, at least unless other straits like B. S. be found towards the isthmus of Boothia, must be also the most northerly point of the new continent. See **BARROW, POINT**.

BELLOY, **PIERRE LAURENT BUIRETTE**, one of the first French dramatists who ventured to introduce on the stage native, instead of Greek, Roman, or other outlandish heroes. He was born at St Flour, in Auvergne, 17th November 1727, and died 5th March 1775. His father having died while B. was young, his uncle took him under his protection, and educated him for the law; but the seductions of the drama proved irresistible, and the opposition which he encountered in the cultivation of his theatrical talent ultimately determined him to leave his adopted home. Under the name of Dormont de B., he performed on various northern boards, and was much esteemed for his private worth. For some years he resided at St Petersburg, where the Empress Elizabeth interested herself in him. In 1758, he returned to France, to superintend the 'bringing out' of his tragedy *Titus*, trusting that its success would reconcile his family to him. In this, however, he was disappointed, for the piece proved a failure, being only a feeble imitation of *Metastasio*, and he returned to St Petersburg. After the death of his uncle, he again visited France, and obtained a decided success by his tragedy of *Zelmire*. In 1765 appeared *Le Siège de Calais*, which was immensely popular, and is even yet held in estimation; and in 1771, *Gaston and Bayard*, which secured for him an entrance to the French Academy. But of all his productions, the one which has longest retained a place in the *répertoire* of the stage, though it was far from popular at first, is *Pierre le Cruel*. B.'s dramas are not by any means wanting in theatrical effectiveness, but are marred by great incorrectness. They have been collected and edited by Gaillard (6 vols., Par. 1779).

BELLS, on shipboard, is a term having a peculiar meaning, not exactly equivalent to, but serving as a substitute for 'time' or 'o'clock' in ordinary land-life. The day, or rather the night, is divided into watches or periods, usually of four hours' duration each; and each half-hour is marked by striking on a bell. The number of strokes depends, not on the hour, according to ordinary reckoning, but on the number of half-hours which have elapsed in that particular watch: Thus, 'three bells' is a phrase denoting that three half-hours have elapsed, but it does not in itself shew to which particular watch it refers. Captain Basil Hall, in his *Fragments of Voyages and Travels*, while treating of Sunday usages on board ships of the Royal Navy, mentions one or two phrases illustrative of this mode of time-reckoning. While the sailors are at breakfast on Sunday morning, 'the word is passed to "clean for muster," and the dress is specified according to the season of the year and climate. Thus, at different seasons is heard: "Do you hear there, fore and aft! clean for muster at five bells! duck-frocks and white trousers!"—or, "Do you hear there, clean shirt and a shave for muster at five bells!" A ship's bell is usually hung to the beam of the fore-castle, but occasionally

to a beam near the mizzen-mast. Sometimes, in foggy weather, as a warning to other ships, the bell is struck to denote that the ship is on a starboard-tack; leaving the larboard-tack to be denoted by the beat of a drum. See WATCH ON SHIPBOARD.

BELLUNO (the ancient *Bellunum*), a city of Venetia, Northern Italy, on the right bank of the Piave, and 51 miles north of the city of Venice. It is walled, is the seat of a bishop, has a handsome cathedral, hospital, public library, fine aqueduct, &c. It has a trade in timber, and manufactories of silks, hats, leather, and earthenware. Pop. 10,000.

BEL'LOMANCY (Gr. *belos*, an arrow; *manteia*, prophecy), a mode of divination by arrows, practised among the Arabs and other nations of the east. A number of arrows being shot off with sentences written on labels attached to them, an indication of futurity is sought from the inscription on the first arrow found. This is only one of many ways of divining by arrows. See AXINOMANCY. DIVINING-ROD.

BELON, PIERRE, a celebrated French naturalist, was born in 1517 at Soulletière, in the department of Sarthe. He studied medicine at Paris, and subsequently travelled through Germany. In 1546 he left France, and visited Greece, Asia-Minor, Egypt, and Arabia. He returned in 1549, and in 1553 published the results of his travels, in a work entitled *Observations on several Singular and Memorable Things discovered in Greece, Asia, Judæa, Egypt, Arabia, and other Foreign Countries*. Charles IX. gave him apartments in the Château of Madrid, a sumptuous edifice which Francis I. had constructed in the Bois de Boulogne. Here he resided till his tragic death in April 1564. He was murdered by robbers when gathering herbs at a late hour of the evening in the Bois de Boulogne.

Besides the valuable work already mentioned, B. published in 1551, *A Natural History of Strange Sea-fish, with a correct Representation and Account of the Dolphin, and several others of that Species*, which contains, among other things, an exact description of the dolphin, and the earliest picture of a hippopotamus in any European book; in 1555, *A Natural History of Birds*, which is often quoted by Buffon, and acknowledged to be the most important treatise on ornithology of the 16th c.; in 1558, an elaborate and interesting work on Arboriculture, in which he gave a list of the exotic trees which it would be useful to introduce into France. Besides these, B. wrote several other treatises of trees, herbs, birds, and fishes.

BELONE. See GARFISH.

BELOOCHISTAN, a country of southern Asia, bounded on the N. by Afghanistan, on the E. by Moulton and Sinde, on the S. by the Arabian Sea, and on the W. by a maritime dependency of Muscat in Arabia, and by the Persian province of Kerman. B. corresponds in general with the ancient Gedrosia, excepting that the latter name appears to have extended to the Indus, while the former nowhere reaches that river. B. stretches in N. lat. between 24° 50' and 30° 20', and in E. long. between 57° 40' and 69° 18', giving, with a population of half a million, an area of nearly 200,000 square miles, or fully double that of Great Britain. Though it was anciently a part of Persia, yet its modern relations connect it rather with India, more particularly since Sinde and Moulton have fallen under the dominion of the English. In the bygone ages of the overland invasions of Hindustan, the Gedrosian or Beloochee Desert formed, as it were, a barrier for the Lower Indus, constraining every assailant, from Alexander downwards, to prefer the less barren,

though perhaps more rugged route through Afghanistan into the Panjab—a preference strengthened by Alexander's direful experience in returning from the Indus along the coast. The surface is generally mountainous, more especially towards the north, the peak of Takkatu being said to be 11,000 feet high. Even the bottoms of some of the valleys have an elevation of 5700 feet; and the capital, Kelat, situated on the side of one of them, is 6000 feet above the level of the sea. The rivers are inconsiderable, unless after heavy rains: even the largest of them, the Dusti, after a course of about 1000 miles, has been found to be only 20 inches deep, and 20 yards wide at its mouth. The pastures, as may be supposed, are poor, so that there are few cattle: sheep and goats, however, are numerous. The dromedary is the ordinary beast of burden; and it is only in the north-west, towards Kerman, that horses are bred. Wherever there is a sufficiency of water, the soil is productive—the lowlands yielding rice, sugar, cotton, indigo, and tobacco; and the higher grounds, wheat, barley, madder, pulse, and European fruits. In the sandy waste of Mekran, where Alexander's army suffered its severest hardships and privations, the only valuable product is the date. The minerals are copper, lead, antimony, iron, sulphur, alum, and sal-ammoniac; and the manufactures are skins, woollens, carpets, and tent-covers of goat's and camel's hair, and rude firearms. B. has but one seaport, Sonmceane, near the frontier of Sinde. The trade is insignificant, being, such as it is, chiefly monopolised by Hindus. The inhabitants, however, are, as a body, Mohammedans, of the Sunnite sect, and consequently opposed to their neighbours of Persia, who are Shiites. Most of the east provinces, which alone come into contact with British India, are under the authority of the Khan of Kelat, who, with a revenue of about £30,000, maintains an army of 3000 men. This petty sovereign having acted treacherously towards the British during the Afghan campaign of 1839, his royal city was taken by storm in the same year. In 1840, it was abandoned; but, in 1841, it was again captured, for temporary occupation, by the British.

BELSHAM, THOMAS, one of the ablest expounders of the Unitarian system of theology, was born at Bedford in 1750. He was educated in the principles of Calvinism, and for some years officiated as pastor of the dissenting congregation and head of the theological academy at Daventry. These offices he resigned in 1789, on embracing Unitarian views, and shortly after received the charge of a new theological academy at Hackney, which in a few years collapsed for want of funds. Before its extinction, he succeeded Dr Priestley in his pastoral charge, and in 1805 removed to London as the successor of Dr Disney, where he continued till his death in 1829. Most of his works are controversial: his doctrine regarding the person of Christ represents the purely 'humanitarian' view, as distinguished from the more nearly Arian sentiments of men like Channing. He published also a work on mental and moral philosophy, following Hartley, and a memoir of his predecessor, Theophilus Lindsey. His brother, William (b. 1752; d. 1827), was an active and voluminous writer of history and political tracts on the side of the Whigs.

BELSHAZ'ZAR, or **BELSA'ZAR**, was the last king of the Chaldaean dynasty in Babylon. The name occurs only in the Old Testament, where it indicates either the person who is called by Herodotus Labynetos, or his son. For an account of the circumstances attending his overthrow, see the Book of Daniel, Herodotus, &c.

BELT (signifying Girdle), the name given to two straits, the **GREAT** and the **LITTLE B.**, which, with the Sound, connect the Baltic with the Cattegat. The **GREAT B.**, about 70 miles in length, and varying in breadth from 4 to more than 20 miles, divides the Danish islands, Seeland and Laaland, from Fünen and Langeland. The **LITTLE B.** divides the island of Fünen from Jütland. It is equal in length to the **Great B.**, but much narrower. Its greatest breadth is about 10 miles, but it gradually narrows towards the north, until at the fort of Frederica it is less than a mile wide; thus the passage from the Cattegat into the Baltic is here easily commanded. Both the Belts are dangerous to navigation, on account of numerous sandbanks and strong currents; and therefore, for large vessels, the passage by the Sound (q. v.) is preferred.

BELTEIN, BELTANE, BELTINE, or **BEALTAINN**, the name of a heathen festival once common to all the Celtic nations, and traces of which have survived to the present day. The name is derived from *tin* or *teine*, fire, and *Beal* or *Beil*, the Celtic god of light or Sun-god, a deity mentioned by Ausonius (309—392 A.D.) and Tertullian (who flourished during the first half of the 3d c.), as well as on several ancient inscriptions, as *Belenus* or *Belinus*. *B.* thus means 'Beal's fire,' and belongs to that sun and fire worship which has always been one of the most prominent forms of polytheism. The great festival of this worship among the Celtic nations was held in the beginning of May, but there seems to have been a somewhat similar observance in the beginning of November (the beginning, and the end of summer). On such occasions, all the fires in the district were extinguished (while the system was in full force, even death was the penalty of neglect); the *needfire* (q. v.) was then kindled with great solemnity, and sacrifices were offered—latterly, perhaps, of animals, but originally, there can be little doubt, of human beings. From this sacrificial fire the domestic hearths were rekindled.

The earliest mention of *B.* is found by Cormac, Archbishop of Cashel in the beginning of the 10th c. A relic of this festival, as practised in some parts of the Highlands of Scotland about the beginning of the 19th c., is thus described: 'The young folks of a hamlet meet in the moors on the 1st of May. They cut a table in the green sod, of a round figure, by cutting a trench in the ground of such circumference as to hold the whole company. They then kindle a fire, and dress a repast of eggs and milk in the consistence of a custard. They knead a cake of oatmeal, which is toasted at the embers against a stone. After the custard is eaten up, they divide the cake in so many portions, as similar as possible to one another in size and shape, as there are persons in the company. They daub one of these portions with charcoal until it is perfectly black. They then put all the bits of the cake into a bonnet, and every one, blindfold, draws out a portion. The bonnet-holder is entitled to the last bit. Whoever draws the black bit is the devoted person, who is to be sacrificed to Baal, whose favour they mean to implore in rendering the year productive. The devoted person is compelled to leap three times over the flames.' The leaping three times through the fire is clearly a symbolical sacrifice, and there was doubtless a time when the victim was bound on the pile, and burned. See **SACRIFICE, HUMAN.**

It has been usual to identify the worship of the Celtic *Beal* with that of the *Baal* (q. v.) or *Bel* of the Phœnicians and other Semitic nations. It is unnecessary, however, to go beyond the family of nations to which the Celts belong (see **ARYANS**), in order to find analogies either for the name or the

thing. **J. Grimm** (*Deutsche Mythologie*, i. 208, 581) identifies the Celtic *Beal* not only with the Slavonic *Belbog* or *Ejebog* (in which name the syllable *bel* or *bjel* means white, and *bog*, god), but also with the Scandinavian and Teutonic *Balder* (q. v.) or *Paltar*, whose name appears under the form of *Baldag* (the white or bright day), and who appears to have been also extensively worshipped under the name of *Phól* or *Pol*. The universality all over Europe in heathen times of the worship of these personifications of the sun and of light through the kindling of fires and other rites, is testified by the yet surviving practice of periodically lighting *bonfires* (q. v.). The more marked turning-points of the seasons would naturally determine the times of these festivals. The two solstices at midwinter (see **YULE**) and midsummer, and the beginning and end of summer, would be among the chief seasons. The periods of observance, which varied, no doubt, originally, more or less in different places, were still further disturbed by the introduction of Christianity. Unable to extirpate these rites, the church sought to Christianise them by associating them with rites of her own, and for this purpose either appointed a church-festival at the time of the heathen one, or endeavoured to shift the time of the heathen observance to that of an already fixed church-festival. All over the south of Germany, the great bonfire celebration was held at midsummer (*Johannisfeuer*), [see **JOHN'S (ST) EVE**—a relic, probably, of the sun-festival of the summer solstice: throughout the north of Germany, it was held at Easter. It is probable that this fire-festival (*Osterfeuer*) of Ostara—a principal deity among the Saxons and Angles—had been originally held on the 1st of May, and was shifted so as to coincide with the church-festival now known as *Easter* (q. v.; see also **WALPURGIS-NACHT**). The seriousness and enthusiasm with which these observances continued to be celebrated in the 16th and 17th centuries, began afterwards to decline, and the kindling of bonfires has been mostly put down by the governments; the earlier interdicts alleging the unchristian nature of the rites; the later, the danger occasioned to the forests.

In Great Britain, *St John's Eve* was celebrated with bonfires; and *Easter* had its fire-rites, which, although incorporated in the service of the Roman Catholic Church, were clearly of heathen origin. But the great day for bonfires in the British islands was the 1st of November. Fewer traces of this are found in other countries, and therefore we must look upon it as more peculiarly Celtic. While the *May festival* of *B.* was in honour of the sun-god, in his character of god of war—who had just put to flight the forces of cold and darkness—the *November festival* was to celebrate his beneficent influence in producing the fruits which had just been gathered in. Hence it was called *Samhtheine* (peace-fire). If we may judge from the traces that still remain or have been recorded, the *November observances* were more of a private nature, every house having its bonfire and its offerings, probably of fruits, concluding with a domestic feast. The *B. festival*, again, was public, and attended by bloody sacrifices. Although the *November bonfires*, like *B.*, were probably of Celtic origin, they seem to have been adopted by the inhabitants of the British islands generally. About the end of last century they were still kindled in various parts of England, and to this day (1860), over whole districts of Aberdeenshire, every rural dwelling has its *Hallowe'en bonfire* lighted at nightfall in an adjoining stubble-field.

The Anglo-Saxon population of England had their own characteristic *May-day* rites; but there

exist traces also of the observance among them on that day of rites similar to the Celtic Beltane. An 'Old Holne Curate,' writing to *Notes and Queries* in 1853, says: 'At the village of Holne, situated on one of the spurs of Dartmoor, is a field of about two acres, the property of the parish, and called the Ploy (play) Field. In the centre of this stands a granite pillar (Menhir) 6 or 7 feet high. On May morning, before daybreak, the young men of the village assemble there, and then proceed to the moor, where they select a ram lamb (doubtless with the consent of the owner), and after running it down, bring it in triumph to the Ploy Field, fasten it to the pillar, cut its throat, and then roast it whole, skin, wool, &c. At mid-day, a struggle takes place, at the risk of cut hands, for a slice, it being supposed to confer luck for the ensuing year on the fortunate devourer. As an act of gallantry, in high esteem among the females, the young men sometimes fight their way through the crowd to get a slice for their chosen among the young women, all of whom, in their best dresses, attend the *Ram Feast*, as it is called. Dancing, wrestling, and other games, assisted by copious libations of cider during the afternoon, prolong the festivity till midnight.

'The time, the place (looking east), the mystic pillar, and the ram, surely bear some evidence in favour of the Ram Feast being a sacrifice to Baal.'

Additional notices of this sun and fire worship will be found under YULE, CANDLEMAS, LAMMAS, and the other heads referred to in this article.

BELUGA, a genus of *Cetacea* (q. v.), of the family of *Delphinidae* or Dolphins (q. v.), differing from the rest of that family in the blunt and broad head, which has no produced snout; the smaller number of teeth, the greater part of which often fall out before the animal is far advanced in age; and



Beluga.

the want of a dorsal fin. The only species found in the northern parts of the world is *B. arctica* (for which name there are unhappily many synonyms, as *B. leucas*, &c.), the White Whale and White Fish of whalers, often called by English writers the B., and the Round-headed Cachalot. The form of the B. is remarkably characterised by the softness of all its curves, and adapts it for rapid and graceful movements; its skin is usually of a clear white colour, and not very strong, so that it often fails to retain a harpoon. The B. attains a length of more than thirteen feet. The female brings forth two young ones at a birth, and displays the greatest solicitude for them. The food of the B. consists of fish, in pursuit of which it often ascends rivers to some distance. It is gregarious, and may be seen in herds of forty or fifty, which often gambol around boats; it abounds in most parts of the arctic seas, and sometimes, but not very frequently, visits the British shores. One was killed in the Firth of Forth in 1815, and one in the Medway in 1846. The Greenlanders take the B. with harpoons or with strong nets. Its flesh affords them a valuable supply of food, and is eaten by most of the inhabitants of arctic coasts; it affords also a considerable quantity of the very finest oil, and the skin is made into leather. Some of the internal membranes

are also employed for various purposes.—Another species of B. is found in the southern hemisphere. It is called *B. Kingii*.

BEL'US. See BAAL.

BELVEDERE (It.) was originally an erection on the top of a house, for the purpose of looking out on the surrounding country, and enjoying the air, in which sense it is still understood in Italy. A part of the Vatican (q. v.) in Rome is known as the B., and gives name to the famous statue of Apollo. In France, and with us, the word has come to signify any kind of summer-house or place of refreshment.

BELVEDERE (*Kochia scoparia*, *Chenopodium scoparium*, or *Salsola scoparia*), an annual plant of the natural order *Chenopodiaceæ* (q. v.), a native of the middle and south of Europe, and of great part of Asia, which has long been very familiar in British gardens as an ornamental annual, not upon account of its flowers, which have no beauty, but of its close, pyramidal, rigid form, and numerous narrow leaves, which make it appear like a miniature cypress-tree. It is sometimes called SUMMER CYPRESS.

BELV'ISIA (also called NAPOLEO'NA), a genus of exogenous plants, the type of the natural order *Belvisiaceæ*, of which order only a very few species have yet been discovered, natives of the tropical parts of Africa. They are large shrubs, with smooth, simple, leathery leaves. The flowers grow in threes, sessile in the axils of the leaves, and are beautiful and extremely curious. The calyx is a thick, leathery cup, divided into five ovate segments. The corolla consists of three distinct rings; the outer one 5-lobed, and furnished with ribs, by means of which it is strongly plaited, turning back over and hiding the calyx when full blown; the second, a narrow membrane, divided into numerous regular segments like a fringe; the third, an erect cup-shaped membrane. The stamens are erect like another cup; the ovary 5-celled, with two ovules in each cell; the style short, thick, and 5-angled, with a broad, flat, 5-angled stigma. The fruit is a soft berry, crowned with the calyx, with large kidney-shaped seeds. The wood is soft, and contains numerous dotted vessels.—The pulp of the fruit of the best known species is mucilaginous and eatable, the rind very full of tannin; the fruit is as large as a pomegranate, and the seeds $1\frac{1}{2}$ inch long.—The position of this remarkable order in the botanical system is not yet well determined. Lindley regards it as most nearly allied to *Rhizophoraceæ* (Mangroves, q. v.). It is supposed by some that the two inner rings of the corolla should be regarded as sterile stamens, and the place of the order is thus fixed near *Barringtoniaceæ* (q. v.).

BELZO'NI, GIOVANNI BATTISTA, the son of a poor barber, was born at Padua in 1778, and was educated at Rome, for the priesthood, but soon displayed a preference for mechanical science, especially hydraulics; and when the French republican troops took possession of the pontifical city, he quitted his religious studies altogether. About the year 1800, he visited Holland, and in 1803 came to England. For a time he gained a living by exhibiting feats of strength in the theatres. At Astley's, he played the part of Hercules, but he also continued his mechanical studies, and even gave numerous hydraulic representations in the most populous towns of the kingdom. After a sojourn of nine years in England, he went to Spain and Portugal, in his capacity of theatrical athlete. From the peninsula, he passed to Malta, and thence to Egypt in 1815, on the invitation of Mehemet Ali, who wished him to construct a hydraulic machine. After succeeding in

this undertaking, he was induced, by the travellers Burckhardt and Salt, to direct his attention to the exploration of Egyptian antiquities. He threw himself with ardour into his new vocation. He removed the colossal bust of the so-called 'Young Memnon' from the neighbourhood of Thebes to Alexandria, and was the first who opened the temple of Ipsambul. In the valley of 'the royal graves'—Biban-el-Moluk—near Thebes, he discovered several important catacombs containing mummies, and among others, opened, in 1817, the celebrated tomb of Psammethichus, from which he removed the splendid sarcophagus, now, along with the 'Young Memnon,' and other results of B.'s labours, in the British Museum. But B.'s greatest undertaking was his opening of the pyramid of Cephren. An attempt made on his life caused his departure from Egypt, but previously he made a journey along the coast of the Red Sea, and another to the Oasis of Siwah, hoping there to find ruins of the temple of Jupiter-Ammon. In the course of his explorations, he discovered the emerald mines of Zubara and the ruins of Berenice, the ancient commercial entrepôt between Europe and India. In September 1819, he returned to Europe, visited his native town, Padua, and enriched it with two Egyptian statues of granite. He also published in London his *Narrative of the Operations and Recent Discoveries within the Pyramids, Temples, Tombs, and Excavations in Egypt and Nubia; and of a Journey to the Coast of the Red Sea in search of the ancient Berenice, and another to the Oasis of Jupiter-Ammon* (1821, with an atlas of 44 coloured engravings). In 1821, he opened in London an exhibition of his Egyptian antiquities, but soon afterwards undertook a journey to Timbuktu, in Central Africa. At Benin, he was attacked by dysentery, which compelled him to return to Gato, where he died, December 3, 1823. His original drawings of the royal tombs he had opened in Egypt were published by his widow (London, 1829).

BEM, JOSEPH, commander of the army in Transylvania during the Hungarian revolution, 1848—9, was born at Tarnov, in Galicia, 1795. After a course of military adventure in Poland, he went to France, where he resided for a considerable time, earning a livelihood by teaching mechanics and mnemonics. In 1843, after failing in an attempt to organise an insurrection in Vienna, he joined the Hungarians, and was intrusted with the command of the army of Transylvania, amounting to 8000—10,000 men. He at first experienced some checks from the Austrian army, but afterwards defeated them at Hermannstadt and the bridge of Fiski; and finally succeeded, in March 1849, in driving both them and their allies, the Russians, back into Wallachia. Having thus made himself master of Transylvania, he proposed, by amnesties and general mild rule, to gain the adherence of the German and Slavonian population, especially in Wallachia; but his propositions were not entertained by Kossuth and the Hungarian commissariat. After expelling the troops under Puchner from the Banat, B. returned into Transylvania, where the Russians had defeated the Hungarians. Here he reorganised his forces, and did all that was possible in his circumstances to prevent the union of the Russians with the Austrians, but his efforts were unsuccessful. After failing in an attempt to excite an insurrection in Moldavia, he was defeated in a battle near Schászburg, where he was opposed to three times the number of his own troops. At Kossuth's request, he now hastened into Hungary, where he took part in the unfortunate battle near Temesvar. Retreating into Transylvania, he here defended himself for some days against a vastly superior force,

and then made his escape into Turkey, where he embraced, from political motives, the profession of Islam, was raised to the dignity of a pasha, and obtained a command in the Turkish army. In February 1850, he was sent to Aleppo, where, after suppressing the sanguinary insurrection of the Arabs against the Christian population, he died of fever, December 10, 1850. B. was in private life characterised by the benevolence of his disposition, and, as a military leader, was distinguished by courage, presence of mind when in extreme danger, and remarkable rapidity of movement.

BEMBATOOKA, BAY OF, a safe and commodious bay on the north-west coast of Madagascar, in lat. 16° S., and long. 46° E. Prime bullocks are sold here for less than 10s. each, and are bought extensively by agents of the French government, who have them driven to Fort Dauphin, on Antongil Bay, on the opposite side of the island, where they are killed and cured for the use of the French navy, and for colonial consumption. Rice is also sold very cheap at Bembatooka. Majunga, on the north side of the bay, is an important town, Bembatooka being but a village.

BEMBE'CIDÆ, a family of Hymenopterous insects of the division in which the females are furnished with stings. Along with *Sphegida* (q. v.), and other nearly allied families, they receive the popular name of Sand-wasps. They very much resemble bees or wasps in general appearance. They are natives of the warmer parts of the world. Some of them are remarkable for the odour of roses which they emit. The females make burrows in sandy banks, in each of which they deposit an egg, and along with it the bodies of a few flies as food for the larva. The B. fly very rapidly, and with a loud buzzing noise. *Bembex rostrata* is common in the south of Europe.

BEMBO, PIETRO, one of the most celebrated Italian scholars of the 16th c., was born in Venice, May 20, 1470; having studied at Padua and Ferrara, he early devoted himself to polite literature. He edited the Italian poems of Petrarch, printed by Aldus, in 1501, and the *Terzerime* of Dante, 1502. In 1506, he proceeded to the court of Urbino, where he resided until 1512, when he went to Rome, where he was made secretary to Pope Leo X. On the death of that pope, B. returned to Padua, where he became a liberal patron of literature and the arts, as well as a fertile writer himself. In 1529, he accepted the office of historiographer to the republic of Venice, and was also appointed keeper of St Mark's Library. In 1539, B., who had only taken the minor ecclesiastical orders, was unexpectedly presented with a cardinal's hat by Pope Paul III., who afterwards appointed him to the dioceses of Gubbio and Bergamo. He died January 18, 1547. B. united in his character all that is amiable. He was the restorer of good style in both Latin and Italian literature. His taste is said to have been so fastidious with regard to style, that he subjected each of his own writings to forty revisions previous to publication. Some of his writings are marred by the licentiousness of the time. Among his works may be mentioned the *Rerum Veneticarum Libri XII.* (Venice, 1551), of which he published an Italian edition (Venice, 1552); his *Prose*, dialogues in which are given the rules of the Tuscan dialect; *Gli Asolani*, a series of disputations on love, &c.; *Rime*, a collection of sonnets and canzonets; his Letters, Italian and Latin; and the work, *De Virgilio Culice et Terentii Fabulis.* His collected works were published at Venice, in 4 vols., 1729.

BEMBRIDGE BEDS are a division of the Upper

Eocene strata, resting on the St Helen's, and capped by the Hempstead series. They are principally developed in the Isle of Wight. Ed. Forbes, who carefully examined them there, has arranged them in four subdivisions: 1. The upper marls and laminated gray clays, which form the basement bed of the 'black band,' the lowest member of the Hempstead series. They are distinguished by the abundance of *Melania turrettissima*. 2. Unfossiliferous mottled clays, alternating with fossiliferous marls and clays, whose characteristic organisms are *Cerithium mutabile* and *Cyrena pulchra*. 3. The oyster-bed, consisting of greenish marl, and containing immense quantities of a species of oyster (*Ostrea Vectensis*), accompanied with *Cerithia*, *Mytili*, and other marine mollusca. 4. The Bembridge limestone, generally a compact, pale-yellow, or cream-coloured limestone, but sometimes vesicular and concretionary, and containing occasionally siliceous or cherty bands. This is interstratified with shales and friable marls. All the beds are fossiliferous, containing numerous land and fresh-water shells. One bed is composed almost entirely of the remains of a little globular *Paludina*. Shells of *Lymnea* and *Planorbis* are abundant, and are accompanied with the spirally striated nucleolus of two species of *Chara*, water-plants which have been well preserved because of the large quantity of lime which enters into their composition. In this division have been found the mammalian remains of the species of *Palaotherium* (q. v.) and *Anoplotherium* (q. v.) which characterise the gypseous deposits of Montmartre; it is consequently considered the British equivalent of these Parisian beds.

No marked line of distinction separates this series from the St Helen's beds on which it rests. The contained organisms indicate that both had the same fluvi-marine origin. The maximum thickness of the Bembridge series is 115 feet.

BEN, a term of Gaelic origin, prefixed to the names of the principal mountains of Scotland—as Ben Ledi, Ben Lomond, Ben Nevis, &c. It is essentially the same word as the Welsh *Pen*, the primary signification of which is 'head,' and hence it may be considered as equivalent to 'mountain summit' or 'mountain head.' The term *Pennine*, applied to a division of the Alps, is doubtless derived from the Celtic *Pen* or *Ben*; and even the name Apennines is in all probability from the same root.

BEN, a Hebrew word signifying 'son,' and forming the first syllable of many names ancient and modern—as Benhadad, Benjamin, Ben Israel, &c. The corresponding Arabic word, *Ibn* or *Ebn*, in like manner enters into the composition of a great number of names—as Ibn Sina (Avicenna), Ibn-al-Faradhi, Ibn-al-Khatib, &c. *Ibn*, in some of its construct forms, drops the initial vowel, thus nearly corresponding to the Hebrew—as *Jusuf-ben-Yakub* (Joseph the son of Jacob). The plural (in the construct form), *Beni*, is found in the names of many Arab tribes both in Asia and Africa—as Beni Temem (or Temim), Beni Selim, Beni Sala, &c.; and sometimes it occurs in the names of places—as Beni Hassan.

BEN, OIL OF, a fluid fixed oil, obtained from the seeds of a tree found in India and Arabia, and known as the HORSE RADISH TREE (*Moringa pterygosperma*). The seeds are called BEN NUTS, and are roundish, with three membranous wings. The oil is used by watchmakers, because it does not readily freeze; also by perfumers, as the basis of various scents; and other oils are often adulterated with it. See HORSE RADISH TREE.

BENARES, a city on the left side of the Ganges, which here varies, according to the season, between

50 and 92 feet in depth, and in width between 600 yards and a little more than half a mile. It is in lat. 25° 17' N., and long. 83° 4' E., being 421 miles to the north-west of Calcutta, and 466 and 74 respectively to the south-east of Delhi and Allahabad. Without reckoning Secrole, which, at the distance of 2 or 3 miles to the westward, contains the official establishments, B. covers, as it were, an amphitheatre of 3 miles in front, and 1 mile in depth, the immediate margin of the river, which is comparatively steep, being chiefly occupied by flights of steps, or ghats, as they are called, where crowds of all classes spend the day in business, amusement, or devotion. This lively scene, backed by the minarets of about 300 mosques, and the pinnacles of about 1000 pagodas, presents a truly picturesque appearance to spectators on the opposite shore of the Ganges. On closer inspection, however, the city, as a whole, disappoints a visitor. The streets, or rather alleys, altogether impracticable for wheeled-carriages, barely afford a passage to individual horsemen or single beasts of burden; and these thoroughfares, besides being shut out from sun and air by buildings of several stories, are said to be shared with the numerous passengers by sacred bulls that roam about at will. The estimates of the population vary from 200,000 to 1,000,000.

In the traditions of the country, B. is believed to have been coeval with creation; and tolerably authentic history does assign to it a really high antiquity. In its actual condition, however, B. is a modern city. Both in extent and in embellishment, it owes much to the influence of Mahratta ascendancy, which dates from the close of the 17th c.; and it possesses, perhaps, not a single structure that reaches back to the close of the 16th. As the central seat of Hinduism, B., on high occasions, attracts immense crowds of pilgrims—sometimes as many as 100,000; and a few years ago, during an eclipse of the moon, forty persons were trampled to death in the streets. Naturally enough, the Brahmins of B. have always been remarkable for bigotry. Now, however, Brahminism appears to be on the decline; and a result, which Mohammedan persecution vainly tried to produce, would seem to be gradually achieved, chiefly through the introduction of European literature and science. On the Sanscrit College, instituted in 1792, there was at a later date ingrafted an English department, comprising poetry, history, mathematics, and political economy. In 1850, the pupils numbered 230—6 converts to Christianity, 16 Mussulmans, and 208 Hindus. B., as Heber has observed, is very industrious and wealthy, as well as very holy. Besides having extensive manufactures of its own in cotton, wool, and silk, its commanding position on the grand line of communication—road, river, and rail alike—renders it the principal emporium of the neighbouring regions. It is the great mart for the shawls of the north, the diamonds of the south, and the muslins of the east; while it circulates the varied productions of Europe and America over Bundelcund, Goruckpore, Nepal, &c. For the general history of the city, see the following article on the district of the same name. The details of the mutiny of 1857 will be found under the head of SECROLE. At the same time, B. proper added its share to the fearful interest of the emergency through the proverbially fanatical character of its inhabitants, who, during the second siege of Bhurtpore, had got 30,000 sabres sharpened in anticipation of a second repulse of the British.

BENARES, the district mentioned in the immediately preceding article. It is under the lieutenant-governorship of the North-west Provinces, being bounded on the W. and N. by Jounpur; on the E. by Ghazepore and Shahabad; and on the S. and W.

by Mirzapore. It extends in N. lat. between 25° 7' and 25° 32', and in E. long. between 82° 45' and 83° 38'; and thus measuring about 300 miles by about 55, it embraces an area of about 1000 square miles. In 1848, the census gave a population of 741,426, or about 750 to a square mile, the Hindus being 676,050, and all others, 65,376. The district is traversed by the Ganges in a north-east direction for about 45 miles. Besides other rivers, such as the Karamnosa, the Goomtee, and the Burna, and several inferior streams, lakes and tanks are numerous, but small, the largest not exceeding a mile in circuit. The annual rain-fall, though averaging less than in the lower parts of the Ganges, is still considerable, always exceeding 30 inches, and amounting in 1823 to 89. Considering that the tract is barely beyond the tropics, and but little elevated above the sea, the range of the thermometer is unusually great, being between 45° in January, and 111° in May. The mean temperature is stated at 77°, pretty nearly the middle point between the two extremes. The soil, though here and there sterile, is in general characterised by great fertility, more particularly to the left of the Ganges. In the growth of opium, indigo, and sugar—more especially of the last—the district surpasses nearly every other portion of British India. In fact, the state of agriculture is such as may be expected from the density of the population. The rich fields, the thriving villages, and the luxuriant groves, render the aspect of the country very delightful; and perhaps the best proof of the presence of industry and civilisation is the fact, that elephants, rhinoceroses, buffaloes, lions, and tigers, which were hunted in 1529, have entirely disappeared. After a Hindu domination, according to popular faith, of 2400 years, the district sank under the Mussulman yoke in 1193; and, in the first half of the 16th c., it was annexed by Baber to the Mogul Empire. On the dismemberment of that dominion, it fell to the share of the Nawab of Oude, whose grandson, in 1775, ceded it to the East India Company, about ten years after that body had acquired the sovereignty of Bengal.

BENA'TEK, a small town of Bohemia, on the right bank of the Iser, a few miles distant from Prague. It is worthy of note as being for a long time the residence of the celebrated astronomer Tycho Brahe.

BENBECU'LA, one of the Hebrides or Western Isles of Scotland, between North and South Uist, 20 miles west of Skye, and belonging to Inverness-shire. It is 8 miles long, and 8 broad, low and flat, and consists chiefly of bog, sand, and lake, resting on a substratum of gneiss rock, with a very broken coast-line. Pop. 1718, consisting of fishermen and small farmers, who fertilise the soil with the seaweed which is cast ashore on the island.

BENBOW, JOHN, a brave English admiral, was born in Shropshire in 1650. He first distinguished himself as captain of a merchantman, in a bloody action with Sallee pirates. He attracted the notice of James II., who gave him a commission in the navy. After the Revolution, he obtained the command of a large ship, and in the course of a few years was made rear-admiral. The high confidence reposed in him by King William is borne in memory by a very bad pun on his name, said to have been perpetrated by the taciturn monarch. Objecting to several names proposed for the command of an expedition, he said: 'No; these are all fresh-water *beaus*, we need another kind of *beau*: we must send *Benbow*.' The most memorable of this gallant sailor's exploits was his last, where his stubborn valour contrasted nobly with the dastardly behaviour of his captains. Off St Martha, in the West

Indies, on the 19th August 1702, he came up with a superior Freuch force under Admiral Du Casse. For four days he kept up a running-fight with the enemy, almost deserted by the rest of his squadron. On the morning of the 24th, his right leg was smashed by a chain-shot. His officers condoled with him. 'I had rather have lost them both,' said the sturdy admiral, 'than have seen this dishonour brought upon the English nation. But, hark ye—if another shot should take me off, behave like men, and fight it out!' As soon as his wound was dressed, he was carried to the quarter-deck, and directed the fight while it lasted. The enemy sustained severe loss; but the infamous cowardice of the other captains, who actually refused to obey the admiral's signals, made the contest hopeless, and B. sailed away to Jamaica. He died of his wound on the 4th November. The recusant officers were tried by court-martial, and two captains were shot. B.'s employment of explosive vessels at St Malo, seems to have been an anticipation of Lord Dundonald's method at Basque Roads.

BENCH, a hall or court where justice is administered. In this sense, however, it has in modern times received a more limited acceptation, signifying the dais or elevated part of a court-room or chamber where the judges sit to administer the laws. In English courts of justice, this seat is in form literally a bench or couch running along one end of the court-room, the number of judges and their places on this bench being marked by separate desks, one for each judge; but in Scotland and Ireland, the arrangement is different, the judges in these countries sitting on chairs placed at a long and, as in Scotland, a semicircular table, which is in a raised position. The term B. is also applied, by way of distinction, to the judges themselves as a class; thus, we speak of the *B. and bar*. It has likewise, popularly and conventionally, an ecclesiastical application, the bishops of the Church of England being, as a body, sometimes designated by it; hence the expression, 'B. of Bishops.' See **BANC**.

BENCH, COMMON, COURT OF. This is a technical name sometimes given to the Court of Common Pleas. See **COURTS OF COMMON LAW**.

BENCH, KING'S, OR QUEEN'S, the supreme court of common law in the kingdom. See **COURTS OF COMMON LAW**.

BENCH, UPPER, the name given to the Court of King's Bench in the time of Cromwell. See preceding notice, and **COURTS OF COMMON LAW**.

BENCHERS. The governing bodies of the four great Law Societies in England, or Inns of Court—Lincoln's Inn, Inner Temple, Middle Temple, and Gray's Inn—are so called. They are generally Queen's counsel or barristers of distinction; and they annually elect a president or *treasurer*, as he is called, who takes the chair at their corporate meetings, and speaks and acts in their name. See **INNS OF COURT**.

BENCH-WARRANT, is a warrant signed by a superior judge or two justices of the peace, during the assizes or sessions, to apprehend a defendant, against whom a bill of indictment has been found. See **WARRANT**.

BENCOOLEN, a Dutch establishment on the south-west coast of Sumatra, near the outer entrance of the Strait of Sunda, being in lat. 3° 47' S., and long. 102° 19' E. It was founded by the English in 1685; but, in 1825, it was exchanged for the Dutch possessions in the peninsula of Malacca. Its population is said to be about 13,000. Its principal export is pepper; and its external trade is carried on chiefly with Batavia, Bengal, and Holland.

BEND, one of the honourable ordinaries, or more important figures in Heraldry. It is formed by two parallel lines, which may be either straight, or indented, engrailed, &c. (q. v.), drawn from the dexter to the sinister base, and consequently passing athwart the shield. The B. occupies a fifth part of the shield in breadth, if plain; and a third part, if charged. The B. is supposed to represent a shoulder-belt, or scarf



Bend.

worn over the shoulder. When heralds speak of the B. simply, the B. dexter is understood, the B. sinister being always expressly mentioned.

Bend Sinister is the bend dexter reversed, and passing from the left to the right side of the shield, as the dexter does from the right to the left. See **BAR** and **BASTARD BAR**.

There are four diminutives of the Bend—viz, the *bendlet*, the *garter*, the *cost*, and the *ribbon*.



Bendlet.



Garter.



Cost.



Ribbon.

The terms *in bend*, *per bend*, *bendy*, &c., are of frequent occurrence in heraldic works, and signify that the charge is placed, or the shield divided, diagonally in the direction of the bend.

BEND is the name for one among many kinds of knot by which ropes are fastened on shipboard. Seamen imply this meaning when they speak of 'bending the cable,' 'bending a sail,' the 'carrick-B.,' the 'fishermen's B.,' the 'sheet-B.,' &c.

BENDEMANN, EDUARD, one of the most distinguished painters of the Düsseldorf school, was born in Berlin in 1811. Although he had received a very careful scientific education, he devoted himself to art, became a pupil of Schadow's, and soon proved that he had not mistaken his vocation. As early as 1832, his great picture of the Captive Jews was exhibited at Berlin, and at once acknowledged to be a master-piece. His next important work, in 1833, represented Two Girls at a Fountain. It was followed, in 1837, by Jeremiah at the Ruins of Jerusalem, a very large picture, which excited universal enthusiasm in Paris, where it was exhibited, and for which he obtained a prize-medal. In 1838, B. was summoned to Dresden as member of the Academical Council, and professor of the Academy of Art; and the execution of the larger frescoes in the palace was intrusted to his skill. An affection of the eyes, from which he suffered for several years, interrupted the work, which is now, however, completed, and embraces a wide range of historical and mythological subjects. B.'s artistic bias is characteristic of the Düsseldorf school, his pictures being rather lyrical than dramatic. But he is distinguished by a peculiar grace and charm of his own, arising from a most perfect symmetry in drawing and composition, an exquisite *naïveté* in conception, and a tender, harmonious, yet always truthful colouring. He married, in 1838, a daughter

of Schadow's, and his protrait of her is one of his best works.

BENDER, a fortified town, with a citadel, in the province of Bessarabia, Russia. The town is situated on the right bank of the Dniester, 48 miles from its mouth, and has paper-mills, tanneries, forges, and saltpetre-works. Pop. 15,000, including many Armenians, Tatars, Moldavians, and Jews. In 1770, the Russians captured the place, and put the garrison and inhabitants, then amounting to about 30,000, to the sword. It was restored to the Turks in 1774, and again stormed by the Russians in 1809. The peace of Jassy gave it back to the Turks, from whom it was again taken by the Russians in 1811, who were confirmed in the possession of it by the treaty of Bucharest in the following year.—Charles XII. of Sweden lived for some time, 1709—1712, at Varnitza, a village near Bender.

BE'NDIGO, one of the most productive gold-fields in the colony of Victoria, having, in 1857, yielded, according to the official returns, 525,018 ounces. It is about 25 miles to the north of Mount Alexander, which, again, is about 75 miles inland from Melbourne.

BE'NÉ, a town of about 6000 inhabitants, in the province of Mondovi, Piedmont, 18 miles north-east of Coni. It occupies the site of the ancient *Augusta Bagiennorum*, destroyed by Alaric. Many interesting vestiges are found in the neighbourhood; and the ruins of an aqueduct, baths, and amphitheatre are still visible.

BENEDEK, LUDWIG VON, an Austrian general, born in 1804 at Odenburg, in Hungary, where his father was a physician of repute. He received his military education at the Neustädt Academy, and at its close entered the army as ensign in 1822. In 1843, he was promoted to the rank of senior lieutenant, and on the occasion of the insurrection in Galicia in 1846, had several opportunities of distinguishing himself. In August 1847, as commandant of Count Gyulai's infantry-regiment, he moved to Italy, where a still more brilliant career awaited him. On the occasion of the retreat from Milan, and especially after Curtalone, where he had led on the assault with great skill and gallantry, his name was mentioned in the army reports by Marshal Radetsky in the highest terms; and, consequently, he received the cross of the Order of Maria Theresa. He afterwards distinguished himself at the taking of Mortara, and in the battle of Novara. In April 1849 he was made major-general and brigadier of the first body of reserve of the army of the Danube. He commanded the *avant-garde* at Raab and Oszony, and received a slight wound in the affair at Uj-Szegedin; which did not, however, prevent him from taking a most active part in the subsequent engagements of Szörny and Osz Ivany, where he was wounded in the foot. At the close of the Hungarian campaign, he was ordered again, high in command, to Italy. In the Italian campaign of 1859, B. commanded the eighth corps of the Austrians. At Solferino, B. occupied the ground between Pozzolengo and San Marino, and drove back the Piedmontese, who were opposed to him, with great slaughter along his whole line; and he must have forced a great portion of the enemy to surrender, had it not been that he was ordered by the emperor to retreat, an order he obeyed with 'tears in his eyes.'

BENEDI'CITÉ, a hymn or song of the three children in the fiery furnace, sung in the Christian Church as early as the time of St Chrysostom, and used in the Anglican Church in the morning-services when the Te Deum is not sung.

BENEDICT, SAINT, the founder of monachism in the west, was born of a rich and respected family at Nursia, in Umbria, Italy, 480 A.D. At an early age B. was sent to the schools of literature and jurisprudence at Rome, but soon grew dissatisfied with the sterile character of the instruction dispensed. The world was full of distractions, impurities, and ignorance; but the learned doctors, under whom he studied, were, like their heathen predecessors, serenely unconscious of the colossal evils by which men were environed; only, therefore, in the devotions of religion, in the holy silence of solitary meditation, did B. see a safe refuge from the sins of the time, and the possibility of realising a spiritual strength which would enable him to stem the tide of corruption that was setting in. He resolved to leave the city, and betake himself to some deep solitude in which the murmur of the world would be inaudible, and alone in the rocky wilderness wrestle with his own nature, until he had conquered it and laid it a sacrifice on the altar of God. In pursuance of this resolution, when he had only reached, according to some, the age of 14, he departed from Rome, accompanied for the first 24 miles by the nurse whom his parents had sent with him as an attendant to the city. B. then left her, and retired to a deserted country lying on a lake, hence called *Sublacum* (now Subiaco). Here, in a cavern (which afterwards received the name of the Holy Grotto), he dwelt for three years, until his fame spread over the country, and multitudes came to see him. He was now appointed abbot of a neighbouring monastery; but soon left it, as the morals of the half-wild monks were not severe enough for his taste. This, however, only excited a livelier interest in his character, and as he lived in a period when the migration and interfusion of races and nations were being rapidly carried on, he could not fail to draw crowds of wanderers about him. Wealthy Romans also placed their sons under his care, anxious that they should be trained for a spiritual life. B. was thus enabled to found twelve cloisters, over each of which he placed a superior. The savage *Goths* even were attracted to him, and employed in the useful and civilising practice of agriculture, gardening, &c. He now sought another retreat, and, along with a few followers, founded a monastery on Monte Cassino, near Naples, afterwards one of the richest and most famous in Italy. Here he extirpated the lingering relics of paganism, and had his celebrated interview with Totila, king of the Goths, to whom he spoke frankly and sharply on his errors. In 515, he is said to have composed his *Regula Monachorum*, in which he aimed, among other things, at repressing the irregular and licentious life of the wandering monks, by introducing stricter discipline and order. It eventually became the common rule of all western monachism. The monasteries which B. founded were simply religious colleges, intended to develop a high spiritual character, which might beneficially influence the world. To the abbot was given supreme power, and he was told to acquit himself in all his relations with the wisdom of God, and of his Master. The discipline recommended by St B. is, nevertheless, milder than that of oriental monachism with regard to food, clothing, &c.; but enjoins continual residence in the monastery, and, in addition to the usual religious exercises, directs that the monks shall employ themselves in manual labours, imparting instruction to youth, copying manuscripts for the library, &c. By this last injunction, St B., though without intending so to do, preserved many of the literary remains of antiquity; for the injunction, which he gave only with regard to religious books, was extended

afterwards to many secular productions. It is remarkable that the founder of the most learned of all the monastic orders was himself so little of a scholar, that St Gregory the Great described him as being '*scienter nesciens, et sapienter indoctus*'—learnedly ignorant, and wisely unlearned. St B. died March 21, 543.

BENEDICT is the name of fourteen popes. Of these only the following are historically important enough to deserve special mention.—BENEDICT VIII., son of Count Gregory of Tuscoli, was elected in 1012; but was driven from Rome by the anti-pope Gregory. In 1014, he was restored to the papal chair by the Emperor Henry II., and afterwards defeated the Saracens, and took from them, with the help of the Pisans and Genoese, the island of Sardinia; and also various places in Apulia from the Greeks, by the help of Henry. He distinguished himself as a reformer of the clergy, and interdicted, at the synod of Pavia, both clerical marriage and concubinage. He died in 1024.—BENEDICT IX., a nephew of the preceding, was elected pope during his boyhood, in 1033; but in 1038, the Romans rose in indignation, and banished him on account of his almost unexampled licentiousness. He was reinstalled by Conrad II.; again formally deposed by the faction of Consul Ptolemæus, and the anti-pope, Sylvester III.; and after three months, was once more installed as pope by means of bribery. He sold his papal dignity to John Gratianus—Gregory VI.—but was still regarded as pope. The Emperor Henry III., to remove such gross scandals from the church, deposed all the three popes—B., Sylvester, and Gregory—at the synod of Sutri in 1046; but after the death of Clement II., 1047—who was probably poisoned—the deposed B. IX. again gained the papal see by force of bribery, and held it eight months, until 1049, when he was displaced, first by Damasus II., and afterwards by Leo IX. He then sank into obscurity, and died in some convent.—BENEDICT XIII., 1724—1730, was a learned and well-disposed man, of simple habits and pure morals, though rather strict in his notions of the papal prerogative. He unfortunately yielded himself to the guidance of Cardinal Coscia, a greedy, unscrupulous personage, who greatly abused the confidence reposed in him. B. always exhibited great moderation in politics, and an honourable love of peace, and was instrumental in bringing about the Seville treaty of 1729. During this pontificate, a remarkably large number of saints, chiefly from the monastic orders, were added to the calendar.—BENEDICT XIV. (PROSPERO LAMBERTINI), the most worthy to be remembered of all the pontiffs so named, was born at Bologna in 1675. Before his elevation to the papal chair, he had distinguished himself by extensive learning, and the faithful discharge of his duties in the several offices of *Promotor Fidei*, Bishop of Ancona (1727), cardinal (1728), and Archbishop of Bologna (1732). Succeeding Clement XII., he began his pontificate, in 1740, with several wise and conciliatory measures; founded chairs of physic, chemistry, and mathematics in Rome; revived the academy of Bologna, and instituted others; dug out the obelisk in the Campus Martius, constructed fountains, rebuilt churches; caused the best English and French books to be translated into Italian; and, in many other ways, proved himself the zealous friend and munificent patron of literature and science. His piety was sincere, enlightened, and tolerant, and his doctrines were well exemplified in his practice. He was extremely anxious that the morals of the clergy should be untainted; and, to that effect, established a board of examiners for all candidates to vacant sees. In proof of his toleration, he shewed the

frankest kindness to all strangers visiting his capital, whatever the nature of their religious opinions. The only accusation brought against him by his Roman subjects was, 'that he wrote and studied too much, but ruled too little,' or left affairs of business too much in the hands of the Cardinal Valentine. After a painful illness, B. XIV. died May 3, 1758.—His most important work is that on *Synods*. A complete edition of his writings was published under the care of the Jesuit de Azevedo (12 vols., Rome, 1747—1751), and in 16 vols., Venice, 1777.

BENEDICTINES, the general name of all the monks following the rule of St Benedict. The first Benedictine monastery was that founded at Monte Cassino, in the kingdom of Naples, about 529, by St Benedict himself. The order increased so rapidly, after the 6th c., that the B. must be regarded as the main agents in the spread of Christianity, civilisation, and learning in the west. They are said at one time to have had as many as 37,000 monasteries, and counted among their branches the great order of Clugny, founded about 910; the still greater order of the Cistercians, founded in the following century; the congregations of Monte Cassino in 1408, of St Vanne in 1600, and of St Maur on the Loire, in 1627. To this last congregation all the Benedictine houses in France were affiliated. It had afterwards its chief seat at St Maur, near Vincennes, and more lately at St Germain-des-Prés, near Paris. Its fine conventual buildings at St Maur on the Loire, were destroyed during the revolutionary troubles. Numbering among its monks such scholars as Mabillon, Montfaucon, Sainte-Marthe, D'Achery, Martene, Durand, Rivet, Clemencet, Carpentier, Toussaint, and Tassin, it has rendered services to literature which it would be difficult to over-estimate. Besides admirable editions of many of the fathers, the world of letters owes to the B. of St Maur, the *Art de Vérifier les Dates* (1733—1787, in 3 vols. fol.); a much enlarged edition of Ducange's *Glossarium Medicæ et Infimæ Latinitatis* (1733—1736, in 6 vols. fol.), with a Supplement (1766, in 4 vols. fol.); the *De Re Diplomatica* (1681 and 1709, fol.); the *Nouveau Traité de Diplomatique* (1750—1765, in 6 vols. 4to); *L'Antiquité Expliquée* (1719—1724, in 15 vols. fol.); the *Monuments de la Monarchie Française* (1729—1733, in 5 vols. fol.); the *Acta Sanctorum S. Benedicti* (1688—1702, in 9 vols. fol.); the *Annales Ordinis S. Benedicti* (1713—1739, in 6 vols. fol.); a new and much improved edition of the *Gallia Christiana* (1715—1856, in 14 vols. fol.); the *Veterum Scriptorum Spicilegium* (1653—1677, in 13 vols. 4to); the *De Antiquis Monachorum Ritibus* (1690, in 2 vols. 4to); the *De Antiquis Ecclesie Ritibus* (1700—1702, in 3 vols. 4to); the *Thesaurus Novus Anecdotorum* (1717, in 5 vols. fol.); the *Veterum Scriptorum et Monumentorum Amplissima Collectio* (1724—1733, in 9 vols. fol.); the *Histoire Littéraire de la France* (1733—1749, in 9 vols. 4to). The B. were suppressed in France, along with the other monastic orders, at the Revolution in 1792; and their splendid conventual buildings at St Maur on the Loire were destroyed. They have lately been revived; and the B. of Solesmes, established in 1837, aspiring to follow in the footsteps of the B. of St Maur, have resumed some of the works which that body left unfinished, and entered on literary enterprises of their own, such as the *Spicilegium Solesmense*, in 10 vols. 4to, of which three have already appeared. The chief B. houses in Germany were those of Prüm, Ratisbon, Fulda, Ellwang, and Saltzburg; in Spain, they had Valladolid, Burgos, and Montserrat; in Italy, Monte Cassino, Padua, and Capua. In England, most of the richest abbeys and all the cathedral priories (excepting Carlisle) belonged to this order. In Scotland the B. had the monasteries

of Dunfermline, Coldingham, Kelso, Arbroath, Paisley, Melrose, Newbottle, Dundrennan, and others. In Germany, several Benedictine monks distinguished themselves as promoters of education in the 10th c.; while in the latter half of the 11th c., the B. Lanfranc and Anselm, archbishops of Canterbury, laid the foundation of medieval scholasticism. In Italy, also, the B. gained distinction as literati, jurists, and physicians; but almost everywhere corruption of manners appears to have accompanied increasing wealth, until gradually it became the practice to receive, almost exclusively, the sons of noble and wealthy persons as novices among the 'Black Monks.' Several of the popes attempted a reformation of the order, and at the general Council of Constance, 1416, a plan of reform was laid down, but failed in being carried into practice. In the 15th c., the B. had 15,107 monasteries, of which only 5000 were left after the Reformation, and now not more than about 800 can be counted. As early as 1354, this order could boast of having numbered among its followers 24 popes, 200 cardinals, 7000 archbishops, 15,000 bishops, 1560 canonised saints, and 5000 holy persons judged worthy of canonisation, and 37,000 monasteries, besides 20 emperors, 10 empresses, 47 kings, above 50 queens, 20 sons of emperors, 48 sons of kings, 100 princesses, and an immense number of the nobility. Tanner (*Notit. Monast.*) enumerates 113 abbeys and other institutions of B. in England, and 73 houses of Benedictine nuns. From their dress—a long black gown, with a cowl or hood of the same, and a scapulary—the B. were commonly styled 'Black Monks.' The institution of convents for nuns of this order cannot be traced back beyond the 7th c.

The rule of St Benedict was less severe than that which the eastern ascetics followed. Besides implicit obedience to their superior, the B. were to shun laughter, to hold no private property, to live sparsely, to exercise hospitality, and, above all, to be industrious. Compared with the ascetic orders, the B., both in dress and manners, may be styled the gentlemanly order of monks; and whatever may be said of their religion, they deserve a high tribute of respect for their artistic diligence and literary undertakings. Speaking of the great productions of the B. above noticed, Sir Walter Scott characterises them as 'works of general and permanent advantage to the world at large; shewing that the revenues of the B. were not always spent in self-indulgence, and that the members of that order did not uniformly slumber in sloth and indolence.' Among the chief works on the history of the B., are the *Annales Ordinis S. Benedicti*, and the *Acta Sanctorum S. Benedicti*, already referred to; Reyner's *Apostolatus Benedictinorum in Anglia* (Douai, 1626, fol.); the *Bullarium Cassinense* (Venice, 1650, 2 vols. fol.); Tassin's *Histoire de la Congregation de Saint Maur* (Paris, 1770); *Chronica de la Order de San Benito* (Salamanca, 1609—1615, 7 vols. fol.); *Regula S. Benedicti et Constitutiones Congregationis S. Mauri* (Paris, 1770, 8vo).

BENEDICTION (from the Lat. *benedicere*, to speak well), signifies a solemn invocation of the Divine blessing upon men or things. The ceremony in its simplest form may be considered almost coeval with the earliest expressions of religious feeling. We know from Holy Writ that the Jewish patriarchs before they died invoked the blessing of God upon their children, and at a later period the priests were commanded to implore the Divine blessing upon the people. Christ sanctioned the custom, which was consequently carried forward into the primitive church, where it gradually developed itself in

different forms, till, under the elaborate ritual of the papacy, it has come to be considered an essential preliminary to almost all important acts, and is often performed with great pomp. One of the most superb spectacles that a stranger at Rome can witness, occurs on Easter Sunday, when the pope, in his august robes of office, and attended by his cardinals, pronounces after mass, in the presence of worshipping thousands, a solemn *B. urbi et orbi* (on the city and the world). The B., however, is not confined to a form of prayer, but is accompanied with sprinkling of holy-water, use of incense, anointing, making the sign of the cross, &c. The cases in which a B. is bestowed are too numerous to mention, but the chief are as follows: The coronation of kings and queens, the confirmation of all church dignitaries, and the consecration of church vessels, bells, and sacred robes; the nuptial ceremony, the absolution of the sick penitent (called the Beatific B.), and the last sacrament. Besides these, lands, houses, cattle, &c., often receive a B. from the priest. In the English church-service, there are two benedictions; in the Scotch, only one. In the Greek Church, when the B. is being pronounced, the priest disposes his fingers in such a manner as to convey symbolically to those of the faithful who are close enough to observe the arrangement, the doctrine of the Trinity and the twofold nature of Christ.

BENEDI'CTUS, in Music, a portion of the service of the mass of the Romish Church, also introduced in the service of the Anglican Church, in the morning prayer, but with English words.

BE'NEFICE, or **BENEFICIUM** (Lat. 'a good deed,' also 'a favour,' and hence 'a grant,' or 'a provision' generally, and now more especially, a provision made for an ecclesiastical person), was a term formerly applied to feudal estates, but is now used to denote certain kinds of church preferment, such as rectories, vicarages, and other parochial cures, as distinguished from bishoprics, deaneries, and other ecclesiastical dignities or offices. In this sense a distinction is accordingly taken by the 1 and 2 Vict. c. 106, s. 124, between *benefices* and *cathedral preferments*; by the former being meant all parochial or district churches, and endowed chapels and chapelries; by the latter, all deaneries, archdeaconries, and canonries, and generally all dignities and offices in any cathedral or collegiate church, below the rank of a bishop. See note in 3 Stephen's *Com.*, p. 27. By the 5 and 6 Vict. c. 27, s. 15, which is an act to enable incumbents to devise lands on farming leases, it is enacted that the word B. shall be construed to comprehend all such parochial preferment as we have above described, 'the incumbent of which, in right thereof, shall be a *corporation sole*' (q. v.); and by an act passed in the same session, chapter 108, being an act for enabling ecclesiastical corporations to grant long leases, it is, by section 31, declared that B. shall mean every rectory, *with or without cure of souls*, vicarage, &c., the incumbent or holder of which shall be a corporation sole. But by a later act, the 13 and 14 Vict. c. 98, which is an act to extend a former act, the 1 and 2 Vict. c. 106, against pluralities, the term B. is, by section 3, explained to mean B. *with the cure of souls and no other*, anything in any other act to the contrary notwithstanding. Benefices are also *exempt or peculiar*, by which is meant that they are not to be under the ordinary control and administration of the bishop; but, by section 108 of the 1 and 2 Vict. c. 106, above mentioned, it is provided that such exempt or peculiar benefices shall nevertheless, and so far as relates to pluralities and residence, be subject to the archbishop or

bishop within whose province or diocese they are locally situated.

There are, in general, four requisites to the enjoyment of a benefice. 1st, Holy orders, or ordination at the hands of a bishop of the established church or other canonical bishop (a Roman Catholic priest may hold a benefice in the Church of England on abjuring the tenets of his church, but he is not ordained again); 2d, Presentation, or the formal gift or grant of the B. by the lay or ecclesiastical patron; 3d, Institution at the hands of the bishop, by which the cure of souls is committed to the clergyman; and 4th, Induction, which is performed by a mandate from the bishop to the archdeacon to give the clergyman possession of the temporalities. Where the bishop is himself also patron, the presentation and institution are one and the same act, and called the *collation* to the benefice. In Scotland, the law on this subject is regulated by the 6 and 7 Vict. c. 61, passed in 1843, and commonly called Lord Aberdeen's Act. See **ESTATE**, **LIVING**, **PARISH**, **PLURALITIES**.

BENEFICIARY is a legal term sometimes applied to the holder of a benefice. It may also denote a person who is in the enjoyment of any interest or estate held in trust by others, in which latter sense it is strictly and technically used in the law of Scotland, all having right or interest in trust-funds and estate being in that system called beneficiaries. The technical term in the law of England corresponding to this latter meaning of the word is *cestui que trust* (q. v.). Patent rights and copyrights are denominated B. privileges. See **TRUST** and **TRUSTEE**.

BE'NEFIT SOCIETIES, associations for mutual benefit chiefly among the labouring classes, and of which there are now great numbers; being better known under the name of **FRIENDLY SOCIETIES**, we refer for an account of them to that head. Meanwhile, we confine attention to that peculiar species of associations called **BENEFIT BUILDING SOCIETIES**. These are societies established for the purpose of raising, by periodical subscriptions, a fund to assist members in obtaining small portions of heritable property, freehold or otherwise. They are now regulated by an act of parliament passed in 1836, the 6 and 7 Will. IV. c. 32, which, it is declared, shall extend to all societies established prior to June of the same year. This act declares it shall be lawful to establish such societies, for the purpose of enabling the members to erect and purchase dwelling-houses, or acquire other real or leasehold estate, but which shall be mortgaged to the society until the amount or value of the shares drawn on shall be fully repaid with interest and all other appropriate payments. A share is not to exceed in value £150, and the corresponding monthly subscription is not to be more than twenty shillings. A majority of the members may make rules and regulations for the government and guidance of the society, such rules not being repugnant to the provisions of the act, nor to the general laws of the realm; and for offences against these rules and regulations, fines, penalties, and forfeitures may be inflicted. No member shall be allowed to receive any interest or dividend on his share until the same has been realised, except on the withdrawal of such member according to the rules of the society.

The 4th section of the act appears to suggest, in the present state of the law, something like a difficulty as to the precise legal character and position of these societies, unless it may be held to be removed substantially by the enactments of a recent act, which we shall presently notice. By the 4th section referred to, all the provisions of two previous acts relating to friendly societies, the 10 Geo. IV.

c. 56, and the 4 and 5 Will. IV. c. 40, are extended to these benefit building societies. These two acts, however, are both wholly repealed by the 18 and 19 Vict. c. 63, which consolidates and amends the law relating to friendly societies; and in the latter we do not find any corresponding enactment giving the benefit of its provisions to building societies expressly and by name, nor does it contain any allusion to or recital of the above act of the 6 and 7 Will. IV. But by its 2d, 3d, 4th, and 5th sections, it saves the rights and privileges of societies existing at its date (1855) under former acts; and by section 11, on the preamble 'that many provident, benevolent, and charitable institutions and societies are formed, and may be formed, for the purpose of relieving the physical wants and necessities of persons in poor circumstances, or for improving the dwellings of the labouring classes, or for granting pensions, or for providing habitations for the members or other persons elected by them; and it is expedient to afford protection to the funds thereof,' it is enacted that, if the registrar shall certify that the rules of such institution or society are not repugnant to law, thereupon the following sections of the act shall extend and apply to such institution and society—that is to say, the 17th, 18th, 19th, 20th, 21st, and 22d sections, which relate to the appointment, duties, and responsibilities of the societies' trustees, and to the duty and responsibility of the treasurer. The other sections define the mode of determining disputes according to the rules of the society, either by arbitrators, or by application to the county court of the district in England, the court of the assistant-barrister in Ireland, and the Sheriff's Court in Scotland—the Lord Chancellor being empowered to make such rules and orders, and the judges of the Court of Session in Scotland such acts of Sederunt as may be necessary for regulating the procedure. By an apparent oversight, a similar control over the court of the assistant-barrister in Ireland is not given to the Irish Chancellor, or to any other Irish judicial authority.

Building societies are of two kinds; those which are to terminate at the end of a specified period—usually twelve or fourteen years—and those of a permanent nature. As attended with numerous inconveniences, the terminating are giving way to the permanent associations, and these latter alone need be described. The object which a member has distinctly in view is to be the proprietor of a dwelling-house. Instead of paying rent to a landlord, he proposes to set aside so much of his earnings monthly towards the purchase-money of a property. The advantage of this plan is twofold. Instead of continually paying rents, and never becoming any richer, he finds that his instalments, which are only a little more than what a rent would be, make him his own landlord, and give him an improved social position. In the best arranged societies, members are allowed to pay much or little as instalments, according to their ability; and in cases of sickness or want of work, the payments may be for a time suspended. The method of acquiring a property is as follows: A member fixes on a house which he wishes to buy, and proposes to the society that he wishes to borrow the price of it. The society appoints a surveyor to report as to the value of the building, and if satisfied on that point, makes the purchase in name of the applicant, who, under proper guarantees, enters on possession immediately. A usual period of payment is about thirteen years, a sum equal to 5 per cent. of the principal, and 5 per cent. interest, being paid every year. Mr J. A. Binns, in describing these societies, in a paper read at the Social Science Congress at Bradford, 1859,

spoke of their great value in implanting habits of economy and feelings of self-respect. 'The first payment is productive, and every succeeding one improves the investor's position, while the determination to save is strengthened by every month's deposit. A payment of 10s. per month is worth in one year £6, 3s. 3d.; in five years, £35, 2s. 9d.; in seven years, £50, 7s. 5d.; in ten years, £77, 19s. 3d.; in fourteen years, £121, 16s.—£37, 16s. of which is interest. The total sum which has been deposited in four societies in Bradford, is £1,179,790, of which £222,522 was received last year (1858). The average annual receipts are about £150,000. The total of the advances on mortgage is £632,457.' In London, Birmingham, and other parts of England, there are now numerous benefit building societies, of which these are an example; and the good they have done, and are doing, could scarcely be exaggerated. In Scotland, associations of this kind are less numerous, besides being chiefly composed of persons in the middle ranks of society, who wish to buy and occupy a superior class of houses. While freehold property in England, to the value of 40s. per annum, imparts a qualification to vote for a member of parliament for the county connected with the town in which the property is situated, no such qualification exists in Scotland, where land is held from the crown, or in feudal tenure, not freehold; and perhaps this accounts in some measure for the want, in Scotland, of that general enthusiasm for supporting building societies, which forms a striking feature in the humbler department of urban society in England. See FREEHOLD.

BENEFIT OF CLERGY. This expression relates to happily a former state of the law of England, which at once shews the power of the clergy and the ignorance of the people. It was otherwise called *privilegium clericale*, and in the days of its real meaning and force, the benefit or privilege meant little short of the total exemption of the clerical order, in respect of crimes and offences, from the jurisdiction and authority of the secular magistrate—an exemption pretended to be founded upon the text of Scripture, 'Touch not mine anointed, and do my prophets no harm.' The only exception to this was the priest being held in custody by the king himself; but even in that case, he could only remain in such regal custody with the pleasure and consent of the bishop, who had entire control over his person, and over the inquiry into his offence. If a priest or 'clerk' happened to be imprisoned by the secular arm, on a criminal charge or capital felony, he was, on the bishop's demand, to be instantly delivered up without any further inquiry; not, indeed, to be let loose upon the country, but to be detained by the ordinary, till he had either purged himself from the offence, or, having failed to do so, had been degraded; and this state of things continued till the reign of Henry VI., when it was settled that the prisoner should first be arraigned, and might either then claim his B. of C. by plea declining the jurisdiction, or, as was most usually practised, after conviction, by way of arresting judgment. The test of admission to this singular privilege was the clerical dress and tonsure; and a story is told of one William de Bussy, a serjeant-at-law, 1259 A.D. (the practising lawyers then were all priests), who, being called to account for his great knavery and malpractices, claimed the benefit of his orders or clergy, which till then remained an entire secret, and to this end wished to untie his coif, that he might shew that he had the clerical tonsure; but this was not permitted, and the bystanders seizing him, not by the coif, but by the throat, dragged him to prison. See 1 Stephen, p. 17. But in course of time

a much wider and more comprehensive criterion was established, all who could read, whether of the clergy or laity—a mark of great learning in those days—and therefore capable of becoming clerks, being allowed the privilege. But laymen could only claim it *once*, and upon so doing, were burned on the hand, and discharged; to be again tried, however, by the bishop, whose investigation usually resulted in an acquittal, which, although the offender had been previously convicted by his country, or perhaps by his own confession, had the effect of restoring him to his liberty, his credit, and his property—in fact, the episcopal acquittal so entirely whitewashed him, that in the eye of the law he became a new and innocent person. The mode in which the test of reading was applied was as follows: On conviction, the felon demanded his clergy, whereupon a book (commonly a psalter) was put into his hand, which he was required to read, when the judge demanded of the bishop's commissary, who was present, *Legit ut clericus?* and upon the answer to this question depended the convict's fate: if it were simply *legit*, the prisoner was burned on the hand, and discharged; but if *non legit*, he suffered the punishment due to his offence. But by 5 Anne, c. 6, the B. of C. was extended to all persons convicted of clerical offences, whether they could read or not; and by the same statute and several subsequent ones, instead of burning on the hand, a discretionary power was given to the judge to inflict a pecuniary fine or imprisonment. But all further attempts to modify and improve the law on this subject proving impracticable, the B. of C. was at last totally abolished, by the 7 and 8 Geo. IV. c. 28; and now by the 4 and 5 Vict. c. 22, the same is the law with regard to the peers.

This privilege had never any existence or legal meaning in Scotland; and a learned writer on the law of that country complains of its introduction into a statute applicable to Scotland (Hutchison's *Justice of the Peace in Scotland*, vol. ii., p. 191). See on the subject of this article generally, Kerr's *Blackstone*, vol. iv., p. 452; Hale's *Pleas of the Crown*, part 2, c. 45; and Reeves's *History of the English Law*.

BENEFIT OF INVENTORY, in the Scotch law, was a legal privilege whereby an heir secured himself against unlimited liability for his ancestor, by giving up, within the *annus deliberandi* (q. v.), an inventory of his heritage or real estate, to the extent of which, and no further, was the heir liable. But the *annus deliberandi* is now abolished, and the privilege in question is of the less consequence, seeing that by the 10 and 11 Vict. c. 47, ss. 23 and 25, decrees of service infer only a limited representation of a deceased party, and the heir is only liable to the extent of the inheritance descending to him. See **ANNUS DELIBERANDI**, **HEIR**, **INHERITANCE**, **DEBT**, and **MORTGAGE**.

BENEKE, FREDERIC EDUARD, professor of philosophy in Berlin, was born in that city in 1798, and studied theology and philosophy, first at Halle, and then at Berlin. In 1820, he commenced lecturing in the latter university, but his lectures were soon interdicted by the minister Altenstein, as his philosophical views were quite opposed to those of Hegel. After a few years his lectures were again allowed, and on Hegel's death, in 1832, he was appointed extraordinary professor of philosophy. In March 1854, B. disappeared suddenly from his residence, and nothing more was heard of him until June 1856, when his body was found in the canal at Charlotteburg in the same place in which he had sought his death. B. has more affinity with British thinkers than any other German philosopher. He

holds that the only possible foundation for philosophy lies in a strict adherence to the facts of our consciousness. His system of psychology is therefore what the Germans call 'empirical', and his method is the Baconian as pursued in natural science. Of his numerous writings may be mentioned *Psychologische Skizzen* (2 vols. 1825—1827); *Lehrbuch der Psychologie als Naturwissenschaft* (Text-book of Psychology as a Natural Science, 2d ed. 1845); *System der Logik* (2 vols. 1842); *Erziehungs- und-Unterrichtslehre* (A Treatise on Education, 1842). The best German educationists recommend B.'s psychology as more capable of practical application than the prevailing systems of Germany.

BENEVENTO (ancient *Beneventum*), a city of Southern Italy, capital of the papal delegation of the same name, but situated within the kingdom of Naples. It occupies the site of the ancient city, out of the materials of which it is entirely built, on the declivity of a hill, near the confluence of the Calore and Sabato, about 32 miles north-east of Naples. B. is about two miles in circumference, is surrounded by walls, has a citadel, a fine old cathedral, some noteworthy churches, and a magnificent arch, erected to the honour of the Emperor Trajan, by the senate, 114 A.D., which, with the single exception of that of Ancona, is the best preserved specimen of Roman architecture in Italy. It is an archiepiscopal see, and has a population of about 17,000. B. is a place of very great antiquity. Some writers attribute its origin to Diomed, and in the cathedral is a bas-relief representing the Calydonian boar adorned for sacrifice, said to be the gift of the Greek hero himself. Others give the credit of its origin to Auson, a son of Ulysses and Circe. It was, however, in the possession of the Samnites, when history first takes notice of it, and it appears to have been captured from them by the Romans, some time during the third Samnite war. It was certainly in the hands of the Romans 274 B.C., who changed its name from Maleventum to Beneventum, six years later, and made it a Roman colony. The Carthaginians under Hanno were twice decisively defeated in the immediate neighbourhood, during the second Punic war. It rapidly rose to a place of importance under the Roman empire, and was visited at various times by several of the emperors.

Under the Lombards, who conquered it in the 6th c., B. continued to flourish, and became the capital of a duchy which included nearly the half of the present kingdom of Naples. In the 9th c. the duchy was separated into three states—B., Salerno, and Capua. In 1077, the whole was taken possession of by the Normans, excepting the town and its present delegation, which had previously (1053) been presented to the pope, by the Emperor Henry III. During the 11th and 12th centuries, four councils were held at the city of Benevento. Since that time, with some slight intervals, it has remained under the direct dominion of the popes, who govern it through a resident cardinal with the title of Legate. In 1806, it was erected into a principality by Napoleon, who made Talleyrand Prince of B.; but it was restored to the pope at the peace of 1815. At the revolution of 1848—1849, B. remained faithful to the pope.

BENEVOLENCE, in the history of the law of England, was a species of forced loan, arbitrarily levied by the kings in violation of Magna Charta, and in consequence of which it was made an article in the Petition of Rights, 3 Car. I., that no man shall be compelled to yield any gift, loan, or B., tax, or such like charge, without common consent by act of parliament; and by the statute

BENGAL.

I Will. and Mary, st. 2, c. 2, it is declared, that levying money for or to the use of the crown, by pretence of prerogative, without grant of parliament, or for longer time, or in other manner than the same is or shall be so granted, is illegal. See Hallam's *Constitutional History of England*, and I Stephen's *Com.*, p. 167.

BENGAL, a term used in three distinct senses—as *presidency*, *sub-presidency*, and *province*, in Hindustan. In 1765, the *sonbah* or vicerealty of this name was, along with Bahar and part of Orissa, ceded by the Great Mogul, virtually in full sovereignty, to the English East India Company. As a natural consequence of this acquisition of territory, the presidency of Calcutta, which had been separated from that of Madras in 1707, came to be styled the presidency of Bengal. Moreover, in 1773, this, the youngest of the three distinct governments of British India, was elevated above both its older rivals by an act of parliament, which declared its immediate ruler to be *ex officio* the governor-general of the whole of the Company's dominions. With its commanding position on and around the delta of the Ganges and the Brahmaputra, B., as a presidency, grew almost as uninterruptedly as a tree, alike to the north-west and to the south-east—far beyond the basins of its own mighty rivers. Within less than 90 years, it had overleaped, without a break in its continuity, at once the Irrawaddy and the Indus. Benares in the one direction, was the first considerable increment, having been absorbed in 1775; while the last addition of importance—unless one should except Oude, which, however, had really become British in 1801—was Pegu, in the other direction, the Burmese war of 1852 filling up the gap on the coast which that of 1826 had still left between Assam and Aracan on the north, and Tenasserim on the south. From Tenasserim to the Punjab inclusive, B., as a presidency, embraced about 29° of long., and about 21° of lat. Further, it comprised, to the south-east, the detached settlements of Penang, Malacca, and Singapore; while to the north-west it might, for a time at least, have claimed Afghanistan. The whole of this vast tract was, either directly or indirectly, under the immediate rule of the governor-general, advised, and in some cases, controlled, by a council of 5 members, of whom one was the commander-in-chief, and at least one other was not to be a Company's servant.

Recently, however, the presidency of B., having proved to be too extensive for a consolidated administration, has been divided into three portions—one portion remaining under the governor-general, and two being assigned to subordinate functionaries, the lieutenant-governors respectively of 'The North-western Provinces,' and of 'Bengal.' The first portion, under the direct sway of the governor-general, consists of the Punjab (q. v.); the Cis-Sutlej states, 4 in number—Oude, Nagpoor, Pegu, Tenasserim; and the 3 detached settlements already mentioned in and near the Straits of Malacca. The two other portions, occupying, between them, the entire space from Pegu to the Cis-Sutlej states, meet near the confluence of the Gogra and the Ganges, Patna being situated in 'Bengal,' and Benares in 'The North-western Provinces.' The western section contains the districts of Delhi, Meerut, Allygurb, Rohilkund, Bareilly, Shahjehanpore, Bijnour, Agra, Furruckabad, Allahabad, Cawnpore, Futtehpoor, Benares, Goruckpore, Azimghur, Jounpoor, Mirzapore, Ghazee-pore, &c.; and the eastern section contains the districts of Jessore, Burdwan, Bancorah, Bhagulpore, Monghir, Cuttack, Balasore, Midnapore, Moorshedabad, Rungpoor, Dacca, Silhet, Patna, Bahar, Chittagong, the Snunderbunds, Assam, Aracan, &c. According to official returns of 1857,

the areas and populations of the presidency of B. were as follow :

	Square Miles.	Inhabitants.
Gov.-general's Domain,	246,050	23,255,972
North-west,	105,759	33,655,193
Bengal,	221,969	40,852,397
Totals (British),	573,778	97,763,562
Native Powers,	515,533	38,702,206
Grand totals,	1,089,311	136,465,768

Thus, without reckoning the nominally independent principalities, the three grand divisions of B., as a presidency, present six times the area, and nearly five times the population of Great Britain. In their mutual relations, these three grand divisions still form one and the same presidency of Bengal, as distinguished from the presidencies of Madras and Bombay. They are all, more or less directly, subject to one and the same central authority—an authority which the recent transfer of our eastern empire does not appear, at least in express terms, to have disturbed or modified. They possess also one and the same military organisation to overawe or protect them. Of that military organisation the form and extent are at present under discussion, for the B. native army virtually committed suicide in the summer of 1857. Other features, whether local or universal, of Bengal, either as a presidency or as a sub-presidency, will fall naturally under either more general or less general heads. Bengal Proper alone, the ancient *sonbah* or the modern province, now claims more special notice.

B. Proper, then, is bounded on the N. by Nepaul, Sikim, and Bhotan; on the E. by Assam; on the S. by the Bay of Bengal; on the S.W. by Orissa and Gundwana; and on the W. by Bahar. Taking its widest range, it measures about 350 miles from west to east, by an average of about 300 from south to north, and covers an area, in round numbers, of 100,000 square miles. It embraces about 30 administrative districts; and its population may be stated at 26 millions. Thus, Bengal Proper differs but little, in extent and population, from Great Britain, while of its own sub-presidency, it comprises nearly one-half of the area, and more than three-fifths of the population. Next to Calcutta, the cities of note are Moorshedabad, Dacca, Burdwan, Purneah, Hoogly, Midnapore, Rajmahal, Bancorah, Berhampore, &c. In B. Proper, within the district of Hoogly, there stands also the French settlement of Chandernagore, containing somewhat less than 4 square miles, with a population of 32,670. The Hoogly district, moreover, contained, at one time, two other dependencies of foreign countries, the Dutch Chinsura, and the Danish Serampore, respectively ceded to England in 1824 and 1845. B. Proper, as a whole, may be regarded as almost a dead level. It is only on the south-west frontier that it shews any hill-country, for towards the north it is said nowhere to reach even a single spur of the Himalaya. The principal rivers are the Ganges and the Brahmaputra, the former intersecting the country diagonally from north-west to south-east, and the latter crossing its more easterly portion in a direction to the west of south. During their lower courses, these main channels are so interlaced together as to form perhaps the most singular net-work of waters in the world; and their first point of confluence is said to be Jafferunge—the head also of tide-water—in lat. 23° 52' N., and long 89° 45' E., at a distance of 160 miles from the sea. But the thousand-isled delta commences 120 miles further up the Ganges, where the highest offset, the Bhagirathi, breaks off to the right, afterwards to join a similar offset, the

Jellinghee, in forming the Hoogly of Calcutta. Besides these two grand arteries, the province is watered by many less considerable rivers, chiefly northerly tributaries of the Ganges; so that even in the driest season there is scarcely any spot 20 miles distant from a navigable stream. During the rainy months, almost every water-course in the more level regions inundates the adjacent plains; while, down in the delta, the separate floods sometimes mingle themselves into a breadth of 100 miles. To say nothing of temporary inconvenience and loss, these visitations often inflict permanent damage such as is wholly irreparable. The soil, in most parts of the province, is so decidedly alluvial, that hardly a rock or a stone meets the ascending voyager within a distance of 400 miles from the sea—a soil offering but a feeble barrier to torrents which, besides gathering, as they rise, velocity and momentum, are liable to change their direction with each increase of depth and width. A twofold evil is the result. The Ganges and the Brahmaputra, resuming, as it were, their gifts of a former age, cut for themselves new passages, to the injury of private individuals, while their old ones become so many seething swamps, to the prejudice of the public health. To a partial extent, such calamities have been averted by embankments. In these circumstances, the intercourse is ordinarily carried on by water: the Bengalee, in fact, may be viewed as almost amphibious; and on the Lower Ganges alone, there are said to be—unless in so far as steam may have reduced the number—about 30,000 professional boatmen. Speaking generally, the communications by land are merely beaten paths. The only exception of note—and that certainly a noble one—is the Grand Trunk Road, which traverses the province from Calcutta upwards on its way to Delhi, Lahore, and the Indus. Much of the country is covered by thick woods and impenetrable jungles, which abound in wild animals, such as the jackal, the leopard, the tiger, and the elephant. The last is often tamed for domestic use, the more common beasts of burden being the camel and the horse, the latter of an altogether inferior variety. Lying, as B. Proper does, between the 21st parallel and the 27th, its climate and productions, so far as the latitude alone is concerned, may be expected to be tolerably uniform over the entire province. But other causes intervene to affect the result. Thus, the nearer any place is to the sea, the heavier are the rains, and the broader is the overflow; the difference of moisture, however, being, in the remoter localities, often made up by irrigation. Moreover, in an inverse proportion to the latitude, the alternate monsoons of the Bay of Bengal (see next article), with their respective influences on the thermometer and barometer, are more sensibly felt in the maritime tracts. Lastly, to these special causes must be added a cause of more general character—the difference of elevation. Hence, wheat and barley, for instance, grow only on the higher grounds, while rice cannot thrive unless within the range of the inundations, yielding, too, an endless diversity of varieties, according to the infinitely fluctuating conditions under which it may be cultivated. Besides grains and vegetables in great variety and abundance, B. Proper gives to commerce opium, indigo, silk, sugar, tobacco, coffee, and cotton. See CALCUTTA. Cotton manufactures, once extensively carried on, particularly in the district of Dacca, have latterly given way to British competition. The article of salt, to come up under another head in connection with revenue, claims separate notice. Most of what is consumed in B. Proper is made in deserts on the coast, alternately covered and

abandoned by every tide, where the singularly powerful evaporation—said to be sometimes an inch a day on the depth of the adjacent bay—impairs the health of the labourer in proportion as it facilitates his labour. Of all these commodities, indigo (q. v.) is, in one important view, the most valuable, as being more likely than any other to attract English agriculturists to India. From the earliest times the dye appears to have been cultivated on the Lower Ganges, which for ages enjoyed, in this respect, the monopoly of the European trade. But when once the cultivation of the plant was introduced into America, it gradually engrossed the market—the greater care in the preparation making up for a natural inferiority in the article itself; and it was only when British capital and skill undertook the manufacture, that B. began to resume her original supremacy in this branch of agriculture. The annual rainfall at Calcutta varies from 50 inches to 85, diminishing gradually towards the interior. At Calcutta also the mean temperature for the year, from 1841 to 1850 inclusive, averaged 73°4' F. at sunrise, 87°2' at 2 hours 40 minutes P.M., and 82° at sunset—the largest differences between the several years of the series having been respectively 1°6', 2°9', and 1°4'. Iron and coal are understood to abound, though by no means continuously, in a tract as large as England, running to the west from Rajmahal—a tract, however, not wholly situated in Bengal Proper. The Bengalees are a feeble and unwarlike race. Within the period of authentic history, the province has always been subject to foreigners. Its last change of owners was in 1757, when a single battle, gained against odds of twenty to one, transferred it from the Mogul's viceroy to the English East India Company—the Mogul's own grant of 1765 merely ratifying the decision of Plassy. With respect to education, which is, more or less, of European character, the province numbers about 5000 pupils, who, so far as they have been classified, consist of 31 Christians, 689 Mohammedans, and 4134 Hindus, besides those who are described as 'of other persuasions.'

BENGAL, BAY OF, a portion of the Indian Ocean, of the figure of a triangle, or rather of a quadrangle, for the northern extremity, instead of running to a point, measures about 250 miles from Balasore to Chittagong. Its southern side, drawn from Coromandel to Malacca, so as merely to leave on the right both Ceylon and Sumatra, may be stated at 1200 miles. The Bay of B. receives many large rivers—the Ganges and the Brahmaputra on the north, the Irrawaddy on the east, and on the west the Mahauddy, the Godavery, the Kistna or Krishna, and the Cauvery. On the west coast, there is hardly anything worthy of the name of harbour; while on the east there are many good ports—such as Aracan, Cheduba, Negrais, Syriam, Martaban, Tavay River, King's Island, besides several more in the islands between Pegu and Sumatra. The evaporation, as stated in the previous article, sometimes amounts, in the hottest season, to about an inch a day. The monsoons prevail over the whole of the north part of the Indian Ocean, of which the Bay of B. is a part, and also over the maritime tracts of B. itself. The north-east monsoon is clearly the ordinary trade-wind of the northern hemisphere; while that from the south-west is shewn by Maury, in his *Physical Geography of the Sea*, to be a deflection of the ordinary trade-wind of the southern hemisphere. Generally speaking, the north-east and south-west monsoons prevail respectively in summer and winter. Maury, however, shews that, on different parallels, there are different seasons for the alternate changes.

BENGA'L ARMY. A succinct account of the military forces in India, European and native, will be found under **EAST INDIA ARMY**; including a notice of the changes made consequent on the transfer of the Company's powers to the crown, in 1858.

BENGA'L LIGHT, BLUE LIGHT, or BENGAL FIRE, is a brilliant signal-light used at sea during shipwreck, and in ordinary pyrotechny for illuminating a district of country. It is prepared from nitre, sulphur, and the tersulphuret of antimony. The materials are reduced to fine powder, thoroughly dried, and intimately mixed in the following proportions by weight: nitre, 6; sulphur, 2; tersulphuret of antimony, 1. The mixture constitutes the **B. L.**, and when kindled by a red-hot coal, red-hot iron, or flame, immediately bursts into rapid and vivid combustion, evolving a brilliant, penetrating, but mellow light, which, during the darkness of night, readily overcomes the gloom for a considerable space. As the fumes evolved during the combustion of the **B. L.** contain an oxide of antimony, and are poisonous, the light cannot be used with safety in rooms or enclosed spaces.

BENGALI LANGUAGE. See **HINDUSTAN.**

BENGA'ZI, a seaport town of Barca, North Africa, finely situated on the east coast of the Gulf of Sidra, in lat. 32° 6' N., and long. 20° 2' E. It has a population of about 2500, who carry on a trade with Malta and Barbary in oxen, sheep, wool, and corn. It has a castle, the residence of a bey, who governs it for the pasha of Tripoli. Its harbour is rapidly filling up with sand. **B.** is chiefly interesting to the traveller, as having been the site of the ancient city of Hesperia, in the neighbourhood of which were several singularly luxuriant dells of large extent, enclosed within steep rocks rising to the height of 60 or 70 feet. These were supposed to answer well the description of the fabled Gardens of the Hesperides. It first rose to importance under Ptolemy III., who called it Berenice, in honour of his wife. It had then a large population, chiefly of Jews. Justinian afterwards fortified it, and adorned it with baths.

BENGEL, JOHANN ALBRECHT, a distinguished German theologian and commentator, whose writings have exercised considerable influence in England, was born at Winnenden, in Würtemberg, June 24, 1687. His early life was chequered by many vicissitudes. After completing his theological curriculum in 1707, he became curate of Metzgingen; a year after, he was appointed theological tutor at Tübingen. Later in life, he held several high offices; among others, that of Consistorial councillor and prelate of Alpirsbach, in Würtemberg, where he died 2d December 1752. He was the first Protestant author who treated the exegesis of the New Testament in a thoroughly critical and judicious style. He did good service also in the rectification of the text of the Bible, and in paving the way for classifying the sacred manuscripts into families. The short notes in his *Gnomon Novi Testamenti* (Tübingen, 1742) have been generally regarded as valuable, and translated into various languages. They were especially made use of by John Wesley, in his *Notes on the New Testament*, which forms one of the standards of Wesleyan Methodism. Indeed Wesley's work may be regarded as little more than an abridged translation from Bengel. *An Exposition of the Revelation of St John* (Stuttgart, 1740), and a chronological work—the *Ordo Temporum a Principio per Periodos Economie Divinae Historicis atque Propheticus* (Tübingen, 1741), gained for **B.**, in his time, a great reputation; some regarding him as an inspired prophet, but the majority as a visionary. In these works he calculated, on the basis he

supposed to be laid down in the Apocalypse, that the world would endure for the space of 7777½ years; and that the 'breaking loose and the binding of Satan' would take place in the summer of 1836.

BENGUE'LA, a country of Western Africa, the limits of which are not very definitely fixed. It is usually represented as lying between lat. 9° and 16° S., and long. 12° and 17° E. The river Coanza separates it from Angola on the N., the mountains behind Cape Negro bound it on the S., and the Atlantic Ocean on the W. Its surface is generally mountainous, rising from the coast-line inland, in a series of terraces; several important rivers flow through it in a north-west direction to the Atlantic. These rivers have numerous affluents, and water is everywhere so plentiful, that it may be found by digging two feet beneath the surface. Vegetation of the most luxuriant and varied description is the consequence of this humidity. The fruit-trees, both of tropical and subtropical climates, succeed extremely well. The inhabitants, however, are too ignorant or indolent to take advantage of the productiveness of the soil. Animals of all kinds common to Western Africa abound in **B.**, both on land and in water. Peacocks are said to be accounted sacred in **B.**, and kept tame about the graves of the great chiefs. Sulphur, copper, and petroleum are found in the mountains, and also gold and silver in small quantities. The coast is unusually unhealthy, but the interior is more salubrious. **B.** is inhabited by a variety of petty tribes, some of which are cannibals, and barbarous beyond even the barbarism of Africa. As might be anticipated, religion exists only in the form of Fetichism. The Portuguese claim **B.**, but they exercise no real power in the interior.

BENGUE'LA, St PHILIP DE, the Portuguese capital of the above region, on the Atlantic, near the mouth of the river Catumbella. Lat. 12° 33' S., long. 13° 25' E. It is very unhealthy; so inimical to European life, indeed, that the Portuguese affirm their countrywomen could not live three months in it. It has a miserable appearance, being built of half-baked bricks, and made ruinous-like by a practice that prevails of never repairing the houses, which, whenever they exhibit symptoms of decay, are abandoned for new ones erected in the vicinity. Pop. 3000, chiefly free blacks or slaves. It was a great slave-station at one time, exporting annually 20,000 slaves. The trade has fallen off greatly of late years. The town was, some time ago, invaded by a herd of thirsty elephants in quest of water, and almost entirely destroyed.

BENI', a river of South America, in the state of Bolivia, formed by the junction of all the streams that rush down from the Eastern Andes between 14° and 18° S. lat. Flowing through the province of Moxos, it joins the Mamore to form the Madeira, one of the largest affluents of the Amazon.

BENICAR'LO, a poor, dirty, walled town of Spain, in the province of Valencia. Pop. 6000, who manufacture 'full-bodied' wines for export to Bordeaux, where they are used in cooking clarets for the English market. Bad brandy is also manufactured here; and the town being situated on the Mediterranean, a little fishing is carried on.

BENI-HA'SSAN, a village of Upper Egypt, on the east bank of the Nile, in lat. 27° 53' N., and long. 30° 55' E. The place is remarkable for the numerous grottos in its vicinity, which are among the most interesting in Egypt. These catacombs are excavated in the calcareous bank—apparently, at one time, washed by the Nile, now flowing further west—in which the low hills that rise in this part of the valley terminate. The catacombs are about thirty

in number, and are supposed to have been used as sepulchres by the principal inhabitants of Hermapolis, a city that stood on the opposite side of the river. Some of the grottos consist of three apartments, the largest of which is 60 by 40 feet; and pillars are cut out of the rock in imitation of the columns that support the roofs of buildings. These shafts are polygons of sixteen sides, fluted except on the inner side, which is left smooth for a line of hieroglyphics. They are usually about 16 feet high, and from 3 to 5 feet in diameter at the base. The sides of the caverns are covered with paintings representing the industrial pursuits, sports, pastimes, &c., of the ancient Egyptians. The paintings, though not so artistic as those in the Theban catacombs, are of earlier date, and throw much curious light on the manners and customs of the people.

BENI-ISGUEN, a large town in the interior of Algeria, surrounded by a rampart, flanked with towers, and said to be nearly as populous as Algiers. It has some trade in grain.

BENI-ISRAEL (Sons of Israel), a remarkable race in the west of India, who preserve a tradition of Jewish descent, and have from time immemorial acknowledged the law of Moses, although in many respects conforming to the idolatry of the Hindus by whom they are surrounded. Dr Wilson estimates their whole number at not much more than 5000. Their original settlement was at Navagaum, about 30 miles from Bombay, where they were protected by the native princes; they have spread through the maritime parts of the Konkan, and some of them are now to be found in Bombay itself. Their features exhibit a resemblance to those of the Arabian Jews. Until recently, they were ignorant even of the names of many of the books of the Old Testament; and it was not without hesitation that they consented to receive those of the later prophets. Dr Wilson supposes them to be a remnant of the ten tribes, and to have settled in India long before the Jews of Cochin. See **COCHIN**, **Jews of**. They reject the name of Jews, and deem its application to them a reproach. They have no MS. of the law in their synagogues. Their communities are governed by a *mukadam*, or head-man of their own number; and their religious assemblies are presided over by a *kazi*, who also performs circumcision and other rites.

BENIN, a state in Guinea, Africa, dependent on the kingdom of Ashantee, situated in 4°—9° N. lat., and 4°—8° E. long. It takes its name from the western arm of the Niger—formerly supposed to be a main river, and styled *Benin* or *Formosa*—which leaves the Niger at Kiri, and, after a course of about 115 miles, forms an embouchure two miles wide. The country of B. is bounded on the N.E. and the E. by the Niger; on the S. by the Bay of Benin, into which Cape Formosa is projected; on the W. by Dahomey; and on the N.W. by Yariba. The coast is indented by numerous estuaries, and is generally level; but the land gradually rises towards the north, until it reaches an elevation of 2500 feet in the Kong Mountains. The soil is very fertile, producing rice, yams, palms, sugar, &c. The animals are the same as those in other states of Guinea, but the hippopotamus is more common. The population is so dense that the king—who is worshipped as a great *fetish*—can bring into the field an army of 100,000 men. The government, customs, and superstitions of B. are similar to those prevailing in Ashantee. The capital, Benin, which is situated in lat. 6° 20' N., long. 5° 50' E., with about 15,000 inhabitants, has a considerable trade. Messrs Smith and Moffat, who visited it in 1838, describe its

market-place as very offensive, from the effluvia rising from a heap of human skulls; while in the outskirts of the town they were still more revolted by the sight of turkey-buzzards feeding on bodies of men recently decapitated. At Gato, a harbour lower down the river, where the traveller Belzoni died, European merchants formerly had factories. Warree is another principal place. The export trade of B. consists of palm-oil, salt, blue coral, jasper, wild-beast skins, slaves, &c. B. was discovered by the Portuguese Alfonso de Aveiro, 1486. In 1786, the French founded settlements at the mouth of the river, which were destroyed by the British in 1792.

BENIN, **BIGHT OF**, that portion of the Gulf of Guinea (q. v.) extending from Cape Formosa on the east to Cape St Paul's on the west, a distance of about 390 miles, with a coast-line of 460 miles. Several rivers empty themselves into the B. of B., the three principal of which, Benin, Escardos, and Forcados, are accessible to shipping. The coast along the Bight was blockaded in 1851 by the British fleet engaged in the suppression of the slave-trade. Palm-oil and ivory are the principal articles of trade at the towns on the coast.

BENI-SOU'EF, a town of Central Egypt, on the right bank of the Nile, about 70 miles south-south-west of Cairo, one of the stations where travellers, making the tour of Egypt, usually stay. It is the entrepôt of all the produce of the fertile valley of Fayoum, and has cotton-mills and quarries of alabaster. Pop. 5000.

BENITIERS, or **BENATURA**, the name of the vase or vessel in which consecrated or 'holy-water' is held in Roman Catholic churches. In England, the B. was known by the names of the 'holy-water font,' the 'holy-water vat,' the 'holy-water pot,' the 'holy-water stone,' the 'holy-water stock,' and the 'holy-water stoup.' Benitiers were either movable or fixed. Portable ones, commonly of silver, were used in processions. Fixed benitiers were placed near the doors of churches, so that the people might dip their fingers in the water, and cross themselves with it as they entered or left the church. The learned French ecclesiologist, M. Viollet-le-Duc, is disposed to think that, before the 12th c., there were no fixed benitiers, their place being served by vases of metal set down near the entrance of the church when the doors were opened. The fixed B. is usually placed either against a pillar, or upon a pedestal. It is of all shapes, and is of the most different materials, but often of stone. The benitiers belonging to the church of St Sulpice, in Paris, are remarkable for their beauty. They are formed of magnificent shells, and bordered with gilt copper. In Great Britain, benitiers are found of every style, from Romanesque to late Third Pointed. On the continent, they range from Romanesque to Renaissance, those of the latter style being generally of marble, richly sculptured, and supported by figures.

BENJAMIN (a Hebrew proper name, signifying 'Son of my Right Hand,' or 'Son of Good Fortune'), the youngest and most beloved of the sons of Jacob. His mother, Rachel, who died soon after he was born, called him *Benoni* (Son of my Pain), but his father changed it to Benjamin. He was the head of one of the twelve tribes of Israel. The tribe in the desert reckoned 35,400 warriors above twenty years of age; and on the entrance into Canaan, 45,600. Its territory, which was small but fertile, lay on the west side of the Jordan, between the tribes of Ephraim and Judah. The chief places were Jericho, Bethel, Gibeon, Gilgal, and Jerusalem, the last of which was on the confines of Judah. In the time of 'the Judges,' the tribe of B. became involved in

war with the eleven other tribes of Israel, on account of refusing to deliver up to justice the Gibeonitish ruffians who had brutally abused the concubine of an Ephraimite. The result was dreadful. All the male descendants of B. were put to the sword (Judges xx. and xxi.), excepting 600, towards whom the hearts of their brethren finally relented. Saul, the first king of Israel, was of the tribe of B., which remained loyal to his son, Ishbosheth. After the death of Solomon, B., along with Judah, formed the kingdom of Judah; and on the return from the Captivity, these two constituted the principal element of the new Jewish nation.

BENJAMIN OF TUDELA, a Jewish rabbi, was born in Navarre, Spain. He was the first European traveller who gave information respecting the distant East. Partly with commercial views, and partly to trace the remnants of the 'lost tribes,' he made a journey, in the years 1159—1173, from Saragossa, through Italy and Greece, to Palestine, Persia, and the borders of China, returning by way of Egypt and Sicily. He died in 1173, the last year of his travels. His notes of foreign lands—originally written in Hebrew, and frequently republished in Latin, English, Dutch, and French—are occasionally concise and valuable; but on the whole must be accepted with qualifications. Like all the early travellers, B. had a greedy ear for the marvellous. His errors are also numerous. The latest edition by Asher (London, 1841) contains the original text, with an English translation and learned annotations.

BENJAMIN TREE. See **BENZOIN**.

BEN LAWERS, a mountain in Perthshire, Scotland, about 32 miles west-north-west of Perth, on the west side of Loch Tay. This mountain, which is easy of ascent, is rich in specimens of Alpine plants, and a magnificent view is commanded from its summit, which has an elevation of 3945 feet. Ore of titanium is found in the mountain.

BEN LEDI, a mountain also of Perthshire, 4 miles west-north-west of Callander, with an elevation of 2863 feet. It received its name from the Druids, who are supposed to have had a place of worship on its summit—the Gaelic words *Beinn-le-Dia*, signifying 'Hill of God.' This mountain is celebrated in Scott's *Lady of the Lake*.

BEN-LO'MOND, a celebrated Scottish mountain in the north-west of Stirlingshire, on the east side of Loch Lomond, and about 27 miles west-north-west of Stirling. This mountain, forming the south extremity of the Grampians or Central Scottish Highlands, is 3192 feet high, and consists of mica slate, with veins of quartz, greenstone, and felspar porphyry. The summit is precipitous on the north side, with a gentle declivity on the south-east; it is covered with vegetation to the top. Though considerably surpassed in height by several other Scottish mountains, none are more imposing. Seen from Loch Lomond, it appears a truncated cone, and from between Stirling and Aberfoyle, a regular pyramid. It has perhaps been ascended by a greater number of tourists than any other of the Highland mountains. The magnificent view from the top, in clear weather, includes the whole length (30 miles) of Loch Lomond, with its diversified isles, and wooded and cultivated shores, the rich plains of Stirlingshire and the Lothians, the windings of the Forth, the castles of Stirling and Edinburgh, the heights of Lanarkshire, the vales of Renfrewshire, Ayrshire, Firth of Clyde, Isles of Arran and Bute, the Irish coast, Kintyre, and the Atlantic. The north semicircle of the horizon is bounded by Bens Lawers, Voirlich, Ledi, Cruachan, and Nevis;

while some of the beautiful Perthshire lochs are seen.

BEN MACDHUI, a lofty mountain of Aberdeenshire, belonging to the Grampian range, at one time regarded as the highest in Great Britain, but now ascertained to be the second—its elevation being 4296 feet.

BEN NE'VIS, the highest mountain in Great Britain, is situated in the county of Inverness, Scotland. It has a height of 4406 feet, is exceedingly difficult of ascent, with a tremendous precipice of 1500 feet in depth on the north-east side. Here snow remains throughout the year. Granite and gneiss form the base of the mountain, which in its upper part is composed of porphyry.

BENNETT, **WILLIAM STERNDALÉ**, a modern English pianist and composer, was born at Sheffield, April 13, 1816. After studying under Crotch, Holmes, Potter, and other professors in the Royal Academy, London, he attracted the notice of Mendelssohn at the Düsseldorf Musical Festival, appeared with success at Leipsic in the winter of 1837—1838, and was received with great applause when he returned to London. In 1838, he was elected member of the Royal Society of Music. Besides a great number of compositions for the pianoforte, solo and with other instruments, B. has written quartets for stringed instruments, concertos, and overtures in Mendelssohn's style. He has also published a work entitled *Classical Practice for Pianoforte Students* (Lond. 1841).

BENNIGSEN, **LEVIN AUG. THEOPHILUS**, **COUNT**, one of the most famous Russian generals, was born at Brunswick, February 10, 1745. His father was an officer in the Brunswick Guards; and B. himself entered the Hanoverian service for a time; but having squandered the property left him, he joined the Russian army in 1773, and in the Turkish war soon attracted the notice of the empress, Catherine, who employed him to carry out her designs against Poland. He was one of the leaders of the conspiracy against the Emperor Paul (1801); though he is said not to have been present at the catastrophe, but to have prevented the Empress Maria from rushing to her husband when she heard his cries. He fought with considerable success in the battle of Pultusk (1806), and held the chief command in the obstinate and murderous struggle at Eylau (1807). When Napoleon invaded Russia in 1812, B. commanded the Russian centre on the bloody field of Borodino, and gave his voice for fighting a second battle before the walls of Moscow. Before the French began their retreat, he gained a brilliant victory over Murat at Woronowa (18th October). Differences with Kutusov, who would not adopt B.'s plan to prevent the French from crossing the Beresina, made him retire from the army; but after Kutusov's death, he took the command of the Russian army of reserve, which entered Saxony in July 1813, fought victoriously at the battle of Leipsic, and was created Count by the Emperor Alexander on the field. When Leipsic was taken, it was he that was commissioned by the allies to announce to the king of Saxony that he was a prisoner. Failing health made him retire from the Russian service in 1818 to his paternal estate in Hanover, where he died October 3, 1826.—His son, **ALEX. LEVIN B.**, is now a leading Hanoverian statesman.

BEN-RHYDDING, a celebrated hydropathic establishment in the West Riding of Yorkshire, in a beautiful situation on the right bank of the river Wharf, 16 miles north-west of Leeds. The building, erected 15 years ago at the cost of nearly £30,000, is

a very imposing pile, on an eminence midway up the side of the valley. There is accommodation for 80—100 patients and visitors, and extensive pleasure-grounds around. In addition to the usual appliances of the water-cure, and a variety of gymnastic exercises, Dr M'Leod has introduced the Compressed-air Bath (q. v.); and quite recently a sumptuous Turkish bath has been added to the other attractions of the establishment.

BEN'SHIE, or BA'NSHEE, an imaginary being in the superstitions of the Irish. The B. is a female, who is called the wife of the fairies, and she makes herself known by wailings and shrieks, premonitory of a death in the family over which she is presumed to exercise a kind of guardianship. The name of this tutelary demon is supposed to be from the Irish Celtic *ben* or *bean*, a woman; and *sighe*, a fairy. A similar superstition prevailed, and is perhaps not yet extinct, in the Highlands of Scotland.

BENT GRASS (*Agrostis*), a genus of grasses, distinguished by a loose panicle of small, one-flowered, laterally compressed spikelets; the glumes unequal, awnless, and longer than the palea, which are also unequal, and of which the inner one is sometimes wanting, and the outer sometimes has and sometimes has not an awn; the seed free. (For explanation of these terms, see GRASSES.) The species are numerous, and are found in almost all countries and climates; several are natives of Britain. All of them are grasses of a slender and delicate appearance. Some are very useful as pasture-grasses and for hay, upon account of their adaptation to certain kinds of soil, although none of them is regarded as very nutritious.—The COMMON B. G. (*A. vulgaris*)

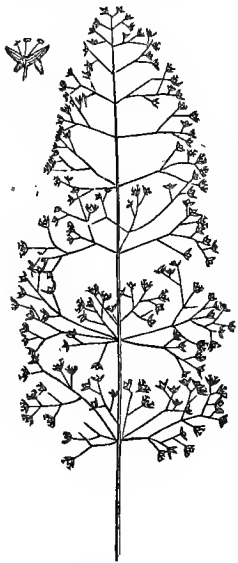

Bent Grass (*Agrostis vulgaris*).

forms a principal part of the pasture in almost all the elevated districts of Britain, and is equally abundant in many parts of the continent of Europe. It resists drought better than almost any other grass, but is only sown by agriculturists on soils unsuitable for the more luxuriant grasses. It is also regarded as very suitable for lawns; but in light, dry, cultivated grounds, it is often a troublesome weed, known as Black Squitch, or Quick-grass, and frequent harrowing is resorted to for the removal of

its creeping perennial roots. It is as frequent on wet as on dry soils, and varies much in size and appearance.—The MARSH B. G. (*A. alba*), also very common in Britain, forming a large part of the natural pasture in many moist situations, is very similar to the species just described, but generally taller and stouter. Of this also there are many varieties, but in all of them, the *ligule* (the little membranous tongue at the junction of the blade of the leaf with its sheathing base) is elongated and acute, whilst in *A. vulgaris* it is very short, and appears as if cut off. A variety, so little different as scarcely to deserve the name, but with somewhat broader leaves and more luxuriant habit of growth, was at one time much celebrated among agriculturists, under the name of FIORIN GRASS, or *Agrostis stolonifera*. It was unduly lauded, and the consequent disappointment led to its being unduly disparaged. It is a useful grass in moist grounds, newly reclaimed hogs, or land liable to inundation. The first three or four joints of the culms lie flat on the damp soil, emitting roots in abundance, and it was formerly propagated by chopping these into pieces, and scattering them, but now generally by seed.—HERD GRASS (*A. dispar*) is a native of the United States, with broader leaves than either of the preceding species, very creeping roots, and large panicles almost level at top. It was at one time strongly recommended for cultivation, but has gone out of repute in Britain. It is, however, more highly esteemed in France, particularly upon account of the great crop which it yields on deep sand and on moist calcareous soils.—BROWN B. G. (*A. canina*), a common perennial British grass, abundant in moist heaths and moorish grounds, is valuable for mixing with other grasses to form permanent pasture on poor wet peaty soils.—SILKY B. G. (*A. Spica venti*) is a beautiful grass, with very slender branches to its ample panicle, which, as it waves in the wind, has a glossy and silky appearance. It is a rare native of sandy grounds in England, common in Southern and Central Europe; an annual grass, occasionally sown in spring to fill up blanks in grass-fields.

BENTHAM, JEREMY, an eccentric but eminent writer on ethics and jurisprudence, was the son of a wealthy solicitor in London, where he was born (in Red Lion Street, Houndsditch) on the 15th February 1748. He received his early education at Westminster School; and when yet a boy, being little more than twelve years of age, he went to Queen's College, Oxford, where he took his Master's degree in 1766. But though his years were so tender, he appears not to have been so unprepared as might be supposed to benefit by the university; for before entering it, he had already, by his precocious tendencies to speculation, acquired the title of 'philosopher.' On graduating, his father, who expected his son to become Lord Chancellor, set him to the study of the law at Lincoln's Inn, where he was called to the bar in 1772. He never practised in his profession, however, for which he had a strong distaste, which is paraded in many of his writings. Turning from the practice of law to its theory, he became the greatest critic of legislation and government in his day. His first publication, *A Fragment on Government*, 1776, was an acutely hypercritical examination of a passage in Blackstone's *Commentaries*, prompted, as he has himself explained, by 'a passion for improvement in those shapes in which the lot of mankind is meliorated by it.' The *Fragment* abounds in fine, original, and just observation; it contains the germs of most of his after-writings, and must be highly esteemed, if we look away from its disproportion to its subject and the writer's disregard of method. The *Fragment* procured him the acquaintance of

Lord Lansdowne, in whose society at Bowood he afterwards passed perhaps the most agreeable hours of his life. It was in the Bowood society that he conceived an attachment to Miss Caroline Fox (Lord Holland's sister), who was still a young lady, when B., in the 54th year of his age, offered her his heart and hand, and was rejected 'with all respect.' In 1778, he published a pamphlet on *The Hard Labour Bill*, recommending an improvement in the mode of criminal punishment; which he followed in 1811 by *A Theory of Punishments and Rewards*. In these two works, B. did more than any other writer of his time to rationalise the theory of punishments by consideration of their various kinds and effects, their true objects, and the conditions of their efficiency. He published in 1787 *Letters on Usury*; in 1789, *Introduction to the Principles of Morals and Legislation*; in 1802, *Discourses on Civil and Penal Legislation*; in 1813, *A Treatise on Judicial Evidence*; in 1817, *Paper Relative to Codification and Public Instruction*; in 1824, *The Book of Fallacies*. These were followed by other works of less consequence. His whole productions have been collected and edited by Dr Bowring and Mr John Hill Burton, and published in eleven volumes. It is well, however, for B.'s reputation, that it does not rest wholly on his collected works; and that he found in M. Dumont, Mr James Mill, and Sir Samuel Romilly, generous disciples to diffuse his principles and promote his fame. In his early works, his style was clear, free, spirited, and often eloquent; but in his later works, it became repulsive, through being overloaded and darkened with technical terms. It is in regard to these more especially that M. Dumont has most materially served his master by arranging and translating them into French, through the medium of which language B.'s doctrines were propagated throughout Europe, till they became more popular abroad than at home. Mr James Mill, himself an independent thinker, did much in his writings to extend the application in new directions of B.'s principles, a work in which, apart from his original efforts, he has achieved a lasting monument of his own subtlety and vigour of mind. Criticisms of B.'s writings will be found in the *Edinburgh Review*, by Sir Samuel Romilly; and in the *Ethical Dissertation*, in the *Encyclopædia Britannica*, by Sir James Mackintosh. But the most valuable contribution in English to his reputation is unquestionably *Benthamiana*, by Mr John Hill Burton, advocate, containing a memoir, selections of all the leading and important passages from his various writings, and an appendix embracing an essay on his system, and a brief clear view of all his leading doctrines.

In all B.'s ethical and political writings, the doctrine of utility is the leading and pervading principle; and his favourite vehicle for its expression is the phrase, 'the greatest happiness of the greatest number,' which was first coined by Priestley, though its prominence in politics has been owing to Bentham. 'In this phrase,' he says, 'I saw delineated for the first time a plain as well as a true standard for whatever is right or wrong, useful, useless, or mischievous, in human conduct, whether in the field of morals or politics.' It need scarcely be remarked, that the phrase affords no guidance as to how the benevolent end pointed at is to be attained; and is no more than a quasi-concrete expression of the objects of true benevolence. In considering how to compass these objects, B. arrived at various conclusions, which he advocated irrespective of the conditions of society in his day, and of the laws of social growth which, indeed, neither he nor his contemporaries understood. He demanded nothing less than the immediate remodelling of the government, and the

codification and reconstruction of the laws; and insisted, among other changes, on those which came at a later day to be popularly demanded as the points of the 'Charter'—viz., universal suffrage, annual parliaments, vote by ballot, and paid representatives. However impossible some of these schemes were, it cannot be denied that B. did more to rouse the spirit of modern reform and improvement in laws and politics, than any other writer of his day. Many of his schemes have been, and many more are, in the course of being slowly realised; the end and object of them all was the general welfare, and his chief error—apart from his over-estimate of the value of some changes which he proposed—lay in conceiving that organic changes are possible through any other process than that of growth and modification of the popular wants and sentiments. It was this error that led the philosopher, in his closet in London, to devise codes of laws for Russia (through which country he made a tour in 1785) and America, the adoption of which would have been equivalent to revolutions in these countries, and then bitterly to bewail the folly of mankind when his schemes were rejected.

In ethics, as in politics, he pressed his doctrines to extremes. It has been said that his doctrine of utility was so extended that it would have been practically dangerous, but for the incapacity of the bulk of mankind for acting on a speculative theory.

By the death of his father in 1792, B. succeeded to property in London, and to farms in Essex, yielding from £500 to £600 a year. He lived frugally, but with elegance, in one of his London houses (Queen Square, Westminster); and, employing young men as secretaries, corresponded and wrote daily. By a life of temperance and industry, with great self-complacency, in the society of a few devoted friends (who, says Sir James Mackintosh, more resembled the hearers of an Athenian philosopher than the proselytes of a modern writer), the eccentric savant attained to the age of eighty-four.

BENTHAMIA, a genus of plants of the natural order *Cornaceæ* (q. v.), consisting of Asiatic trees or shrubs, of which the fruit is formed of many small drupes grown together. *B. frugifera*, a native of Nepal, is a small tree, with lanceolate leaves, and a reddish fruit, not unlike a mulberry, but larger; not unpleasant to the taste. It has ripened fruit in the south of England, and will probably be found to succeed in the open air, wherever the winters are so mild that fuchsias are not cut down by frost. The flowers are fragrant.

BENTINCK, LORD WILLIAM GEORGE FREDERICK CAVENDISH, commonly called Lord George B., at one time the leader of the agricultural Protection party, third son of the fourth Duke of Portland, was born 27th February 1802, and entering the army when young, eventually attained the rank of major. He subsequently became private secretary to his uncle, the Right Hon. George Canning. Elected in 1826 M.P. for Lynn-Regis, he sat for that borough till his death. At first, attached to no party, he voted for Catholic Emancipation and for the principle of the Reform Bill, but against several of its most important details, and in favour of the celebrated Chandos Clause (q. v.). On the formation of Sir Robert Peel's ministry in December 1834, he and his friend Lord Stanley, afterwards Earl of Derby, with some adherents, formed a separate section in the House of Commons. On the resignation of Sir Robert Peel in April following, Lord George openly joined the great Conservative party, which acknowledged that statesman as its head, and adhered to it for nearly eleven years. On Peel's return to power in 1841, Lord George received an offer of office, which he

declined, being at that time deeply interested in the sports of the field and the race-course. When Peel introduced his free-trade measures in 1845, a large portion of his supporters joined the Protection party then formed, of which Lord George became the head, and a leading speaker in the debates. His speeches in the session of 1845—1846 were most damaging to the government of Sir Robert Peel, and contributed in no small degree to hasten its downfall in July of the latter year. Lord George supported the bill for the removal of the Jewish disabilities, and recommended the payment of the Roman Catholic clergy by the landowners of Ireland. In the sporting world he is understood to have realised very considerable gains, and he shewed the utmost zeal at all times to suppress the dishonest practices of the turf. He died suddenly of a spasm of the heart, 21st September 1848; while crossing his father's park at Welbeck Abbey, Nottinghamshire.

BENTINCK, LORD WILLIAM HENRY CAVENDISH, a general officer and statesman, uncle of the preceding, and second son of the third Duke of Portland, was born 14th September 1774, and became an ensign in the Coldstream Guards in 1791. Having served with distinction in Flanders, Italy, and Egypt, he was in 1803 appointed governor of Madras, where he advocated several useful reforms; but his proscription of beards and the wearing of turbans and earrings by the sepoys when on duty, led to the mutiny and massacre of Vellore, and his own immediate recall. In August 1808, he was placed on the staff of the army in Portugal under Sir Harry Burrard. Subsequently selected to proceed on an important mission to the supreme Junta of Spain, he accompanied the army under Sir John Moore in its retreat, and at Corunna commanded a brigade. He next commanded a division of Lord Wellington's army, and shortly after was sent as British minister to the court of Sicily, and commander-in-chief of the British forces in that island. At the head of an expedition, he landed in Catalonia in July 1813, penetrated to Valencia, and afterwards laid siege to Tarragona, but was repulsed at Villa Franca. Early in 1814, quitting Sicily, he repaired to Tuscany, published at Florence a proclamation inviting the Italians to shake off the French yoke, and afterwards made himself master of Genoa. Between 1796 and 1826, he held a seat in parliament as member for Camelford, Nottinghamshire, and Ashburton. In 1827, he was appointed governor-general of India, and sworn a privy-councillor. His policy in India was pacific and popular, and his viceroyship was marked by the abolition of Sutti (q. v.), and by the opening up of the internal communication, as well as the establishment of the overland route. After his return in 1835, he was elected M.P. for Glasgow. He died at Paris, June 17, 1839.

BENTLEY, RICHARD, a distinguished classical scholar, was born at Oulton, in Yorkshire, January 27, 1662. In 1676, he entered St John's College, Cambridge, in the humble capacity of subsizar. Little is known of his university career, except that he shewed early a strong taste for the cultivation of ancient learning. At the usual time, he took the degree of Bachelor of Arts; and on leaving the university, he was appointed head-master of the grammar-school of Spalding, Lincolnshire. About a year afterwards, he resigned this situation to become tutor to the son of Dr Stillingfleet, then Dean of St Paul's, and subsequently Bishop of Worcester. B. accompanied his pupil to Oxford, where he had full scope for the cultivation of classical studies; and, that he succeeded in acquiring there some local reputation, is evinced by his having been twice appointed to deliver the Boyle Lectures on the

Evidences of Natural and Revealed Religion. He entered the church, and owed to the patronage of the Bishop of Worcester various good ecclesiastical appointments, and through the same influence became librarian of the King's Library at St James's. In 1690, he published his *Dissertation upon the Epistles of Phalaris*, which established his reputation throughout Europe, and may be said to have commenced a new era in scholarship. The principles of historical criticism were then unknown, and their first application to establish that the so-called Epistles of Phalaris, which professed to have been written in the 6th c. B. C., were the forgery of a period some eight centuries later, filled the learned world with astonishment.

In 1700, B. was appointed Master of Trinity College, Cambridge; and in the following year, he married Mrs Joanna Bernard, the daughter of a Huntingdonshire knight. The history of B.'s Mastership of Trinity is the narrative of an unbroken series of quarrels and litigations, provoked by his arrogance and rapacity, for which, it must be confessed, he was fully as well known during his lifetime as for his learning. He contrived, nevertheless, to get himself appointed Regius Professor of Divinity, and, by his boldness and perseverance, managed to pass scathless through all his controversies. Notwithstanding that at one time the Bishop of Ely, the visitor of Trinity, pronounced sentence depriving him of his mastership, and that at another the senate of the university pronounced a similar sentence of his academic honours, he remained in full possession of both the former and the latter till the day of his death. This stormy life did not impair his literary activity. He edited various classics—among others, the works of Horace—upon which he bestowed vast labour. He is, however, more celebrated for what he proposed than for what he actually performed. The proposal to print an edition of the Greek New Testament, in which the received text should be corrected by a careful comparison with all the existing MSS., was then singularly bold, and evoked violent opposition. He failed in carrying out his proposal: but the principles of criticism which he maintained have since been triumphantly established, and have led to important results in other hands. He is to be regarded as the founder of that school of classical criticism of which Porson afterwards exhibited the chief excellences, as well as the chief defects; and which, though it was itself prevented by too strict attention to minute verbal detail from ever achieving much, yet diligently collected many of the facts which men of wider views are now grouping together, to form the modern science of comparative philology. B. died in 1742, leaving behind him one son, Richard, who inherited much of his father's taste with none of his energy, and several daughters, one of whom, Joanna, married, and was the mother of Richard Cumberland the dramatist.—Monk's *Life of Richard Bentley*, 1830.

BENUE, or **BI'NUÉ**, or, as Dr Barth prefers to spell it, **BENUWÉ**, called also Chadda and Tchadda; an important river of Central Africa, forming the eastern branch of the Quorra or Niger, which it joins about 230 miles above the mouth of that river in the Gulf of Guinea. At its junction with the Faro, in lat. about 9° 33' N., long. 12° 40' E., the point where Dr Barth crossed, he describes the B. as being 800 yards across, with a general depth in its channel of 11 feet, and 'a liability to rise under ordinary circumstances at least 30 feet, or even at times 50 feet higher.' In 1854, an expedition under the command of Dr Baikie explored the B. as far as Dulti, a place about 350 miles above its confluence with the Niger, and

some 80 or 100 miles from where Dr Barth crossed. Dr Barth regards this river as offering the best channel for the introduction of civilisation into the heart of Central Africa. If not actually connected in some way with the Shari (q. v.), and consequently with Lake Tsad, 'the breadth of the water-parting between these two basins [the Niger and the Tsad], at the utmost, cannot exceed 20 miles, consisting of an entirely level flat, and probably of alluvial soil. . . . The level of the Tsad, and that of the river B. near Gewe, where it is joined by the Mayo Kebbi, seem to be almost the same; at least, according to all appearance, the B., at the place mentioned, is not more than 850 or 900 feet above the level of the sea.' A second expedition to explore the B. has been undertaken by Dr Baikie.

BENYOWSKY, MAURICE AUGUSTUS, COUNT DE, a man of remarkable character and extraordinary fortunes, was born at Verbowa, in Hungary, 1741. He served in the Seven Years' War, and during his youth displayed that restless love of adventure which marked his subsequent career. He went to Dantzic for the purpose of studying navigation, and from thence made several voyages to Hamburg and Plymouth. When about to start for the East Indies in 1767, he received a pressing invitation to join the Polish Confederation, with which he complied, and shared most of the dangers and glories of the campaign against the Russians until he was taken prisoner in May 1769. After being transferred from one Russian prison to another, he was, in December 1769, banished to Siberia, and from thence, in a few months, to Kamtchatka. During the voyage, his exertions and skill saved the vessel that carried him. This recommended the prisoner to the governor, Nilov, who was further pleased by B.'s skill as a chess-player, and made him tutor in his family. In this capacity he gained the affections of Aphanasia, daughter of the governor, by whom he was assisted in his plans for escape; which, however, was not effected without a struggle, in which the governor was killed. B., with ninety-six companions, in a ship well armed and provisioned, and with a considerable amount of treasure, set sail from Kamtchatka in May 1771. Having visited some of the islands of Japan and Formosa, B. arrived at Macao on the 22d of September, where he remained until the 14th January, and then sailed for France. He had not been here long when the French government proposed that he should found a colony at Madagascar, and he at once acquiesced. B. arrived on the island in February 1774, and was made king in 1776 by the chiefs in conclave, he adopting the native costume. Returning to Europe with a view to establish commercial relations between France and Madagascar, B. met with a very cold reception from the French government, and returned to the service of Austria, in the hope that the emperor would assist him in his schemes—a hope not fulfilled. He next made unsuccessful overtures to the British government, but at length receiving assistance from private persons in England and America, departed again for Madagascar, where he arrived in 1785; and, involving himself in contention with the French government of the Isle of France, was killed in battle, May 23, 1786. B. was a man of remarkable resources, great decision of character, courage, and sagacity. He was particularly well versed in human nature, a knowledge which proved of essential service to him during his brief but most remarkable career.—*Memoirs and Travels of Count de Benyowsky, Written by Himself, and Edited by W. Nicholson* (2 vols 4to. London, 1790).

BENZERTA, LAKES OF, the ancient *Hipponitis*

Palus and *Sisara Palus*, two lakes within the dominions of Tunis, from which town they are about 30 miles distant, in a north-west direction. They are each about 9½ miles long, and the larger one, which is clear and salt, is about 5½ miles broad; the smaller, which is turbid and fresh, 3½. They are about two miles apart, but united by a channel with a general depth of 6 feet and breadth of 75. Tunis is supplied with fish mainly from these lakes. So valuable is the fishing, that a wealthy Arab rents it from the Bey of Tunis for £4000 per annum.

BENZILE, BENZOILE, or BENZOYLE, is the radicle or root of the group of substances which comprehends as members the hydride of benzoyle (oil of bitter almonds), benzoic acid, benzoïn, and benzole. It is prepared by passing a stream of chlorine gas through fused benzoïn, or by heating one part of benzoïn with two parts of concentrated nitric acid. B. floats to the upper part of the liquid mixture as a liquid oil, which solidifies on cooling. B. is a tasteless solid, insoluble in water, but readily dissolved by ether and alcohol, and on concentration of the ethereal or alcoholic solution, the B. crystallises in regular six-sided prisms, of a yellow colour. When heated to 194° to 198°, it fuses. Its composition is expressed by the chemical formula $C_{28}H_{10}O_4$, and many chemists name the substance possessing this formula *benzile*, reserving the title *benzoile*, or *benzoyle*, for a substance polymeric (see **POLYMERISM**) with benzile, which has not yet been isolated, but which may be represented by $C_{14}H_5O_2$.

BENZO'IC ACID, or the *Flowers of Benzoïn and Benjamin*, occurs naturally in many balsamiferous plants, and especially in Benzoïn (q. v.), from which it may be readily obtained by several processes, which it is not necessary here to describe. B. A. is always in the form of snow-white, glistening, feathery crystals, with a fairy aspect of lightness. It has a very fragrant and pleasant aromatic odour, due to the presence of a trace of an essential oil, and a hot bitter taste. It is readily dissolved by alcohol and ether, but sparingly soluble in water. B. A. is one of the materials present in *Tinctura Camphoræ Composita*, and has been administered in chronic bronchial affections; but the benefit derivable from its use in such cases is questionable. B. A. taken into the stomach, increases within 3 or 4 hours the quantity of hippuric acid in the urine. It forms a numerous class of compounds with the oxides of the metals, lime, &c., called benzoates. The chemical formula for crystallised B. A. is $HO, C_{14}H_5O_3$.

BENZOIN, BENJAMIN, or BENZO'IC GUM, a fragrant resinous substance, formed by the drying of the milky juice of the Benzoïn or Benjamin Tree (*Styrax*, or *Lithocarpus Benzoïn*), a tree of the natural order *Styracaceæ*, and a congener of that which produces STORAX (q. v.), a native of Siam, and of Sumatra and other islands of the Indian Archipelago. The tree grows to nearly two feet in diameter; the smaller branches are covered with a whitish rusty down; the leaves are oblong, acuminate, and entire, downy and white beneath; the flowers are in compound racemes. B. comes to us in reddish-yellow transparent pieces. Different varieties, said to depend upon the age of the trees, are of very different price; the whitest, said to be the produce of the youngest trees, being the best. There is a variety known in commerce as *Amygdaloidal Benzoïn*, which contains whitish almond-like tears diffused through its substance, and is said to be the produce of the younger trees. B. is obtained by making longitudinal or oblique incisions in the stem of the tree: the liquid which exudes soon hardens by

exposure to the sun and air. B. contains about 10—14 per cent. of Benzoic Acid (q. v.); the remainder of it is resin. B. is used in perfumery, in pastilles, &c., being very fragrant and aromatic, and yielding a pleasant odour when burned. It is therefore much used as incense in the Greek and Roman Catholic Churches. Its tincture is prepared by macerating B. in rectified spirit for seven to fourteen days, and subsequent straining, when the *Compound Tincture of Benjamin*, *Wound Balsam*, *Friar's Balsam*, *Balsam for Cuts*, the *Commander's Balsam*, or *Jesuit's Drops*, is obtained. It is frequently applied to wounds directly; or still better, when the edges of the wound are brought together, and bound with lint or plaster, the tincture of B. may be used as an exterior varnish. In the preparation of *Court-plaster*, sarcenet (generally coloured black) is brushed over with a solution of isinglass, then a coating of the alcoholic solution of benzoïn. The tincture is likewise employed in making up a cosmetic styled *Virgin's Milk*, in the proportion of two drachms of the tincture to one pint of rose-water; and otherwise it is used in the preparation of soaps and washes, to the latter of which it imparts a milk-white colour, and a smell resembling that of vanilla. B. possesses stimulant properties, and is sometimes used in medicine, particularly in chronic pulmonary affections. It may be partaken of most pleasantly when beaten up with mucilage and sugar or yolk of egg. The name *Asa dulcis* (q. v.) has sometimes been given to it, although it is not the substance to which that name seems properly to have belonged.—The milky juice of *Terminalia Benzoïn*, a tree of the natural order *Combretaceæ*, becomes, on drying, a fragrant resinous substance resembling B., which is used as incense in the churches of the Mauritius. It was at one time erroneously supposed that B. was the produce of *Benzoïn odoriferum*, formerly *Laurus Benzoïn*, a deciduous shrub, of the natural order *Lauraceæ*, a native of Virginia, about 10—12 feet high, with large, somewhat wedge-shaped, entire leaves, which still bears in America the name of *Benzoïn*, or *Benjamin Tree*, and is also called *Spice-wood* or *Fever-bush*. It has a highly aromatic bark, which is stimulant and tonic, and is much used in North America in intermittent fevers. The berries are also aromatic and stimulant, and are said to have been used in the United States during the war with Britain as a substitute for pimento or allspice. An infusion of the twigs acts as a vermifuge.

BENZOLE, **BENZINE**, or **PHENE**, is a compound of carbon and hydrogen ($C_{12}H_6$), formed during the destructive distillation of coal (see **GAS**; **COAL**), and found dissolved in the naphtha which is condensed from the vapours evolved from the gas retort. It may be prepared from coal-tar naphtha by subjecting the tar to a temperature of 32° F., when the B. solidifies, while the other naphtha constituents remain liquid. Two gallons of the naphtha yield a pint of pure rectified benzole. It can also be obtained (1) by subjecting oil-gas to a pressure of 30 atmospheres; (2), by the dry distillation of kinic acid (q. v.); and (3) by cautiously heating a mixture of one part of benzoic acid and three parts of quick-lime, when the material which distils over is impure benzole. At ordinary temperatures, B. is a thin, limpid, colourless liquid, evolving a characteristic and pleasant odour. At 32° F., it crystallises in beautiful fern-like forms, which liquefy at 40°; and at 177°, it boils, evolving a gas which is very inflammable, burning with a smoky flame. It readily dissolves in alcohol, ether, turpentine, and wood-spirit, but is insoluble in water. It is valuable to the chemist from the

great power it possesses of dissolving caoutchouc, gutta-percha, wax, camphor, and fatty substances. It is thus of service in removing grease-stains from woollen or silken articles of clothing. When heated, it also dissolves sulphur, phosphorus, and iodine. B., when acted upon by chlorine, nitric acid, &c., gives rise to a very numerous class of compounds.

BENZOYLE, **HYDRIDE OF**, is the volatile or essential oil belonging to the benzoic series. It is represented by the formula $C_{10}H_6O$, and has been already considered under **ALMONDS**, **VOLATILE OIL**, or **ESSENTIAL OIL OF** (q. v.).

BEOWULF, an Anglo-Saxon epic poem, which is one of the greatest literary and philological curiosities, and one of the most remarkable historical monuments in existence. The date of the events described is probably about the middle of the 5th c.; and as the legends refer to the Teutonic races which afterwards peopled England, it is believed that the poem, in its original shape, was brought by the Anglo-Saxons from their original seats on the continent. Only one MS. of the poem is known to exist; that, namely, in the Cottonian Library, which was seriously injured by the fire of 1731. This MS. consists of two portions, written at different times and by different hands, and is manifestly a copy, executed perhaps about the beginning of the 8th c., from an older and far completer version of the poem. But, even in the form in which it came from the hands of its last recaster, B. is the oldest monument of considerable size of German national poetry, and notwithstanding the Christian allusions which fix the existing text at a period subsequent to 597 A. D., a general heathen character pervades it, which leaves little doubt as to the authentic nature of the pictures which it presents of Teutonic life in ante-Christian times. Much learned labour has been bestowed on this strange relic, chiefly by Mr Kemble, of whose beautiful edition, published by Pickering in 1833, and dedicated to James Grimm, the celebrated Teutonic scholar, as also of his subsequent translation and second preface, we shall avail ourselves in the following sketch.

At first Mr Kemble was disposed to regard B. as an historical epic, but his view of it latterly came to be, that though to some extent historical, it must be regarded, in so far as the legends are concerned, as mainly mythological; and this remark he conceived to apply to the hero not less than to the incidents related. But Beowulf, the god, if such he was, occupies only a small space in the poem, and seems to be introduced chiefly for the purpose of connecting Hrothgar, king of Denmark, whom Beowulf, the hero, comes to deliver from the attacks of the monster Grendel, with Sceaf or Scaef, one of the ancestors of Woden, and the common father of the whole mythical gods and heroes of the north. Sceaf is traditionally reported to have been set afloat as a child on the waters, in a small boat or ark, having a *sheaf* (Ang.-Sax. *sceaf*) of corn under his head; whence his name. The child was carried to the shores of Sleswig, and being regarded as a prodigy, was educated and brought up as king. Between Sceaf and Beowulf, Scyld intervened, according to the opening canto of the poem; but when compared with kindred traditions, the whole genealogy becomes involved in extreme obscurity, and Scyld seems sometimes to be identified with Sceaf, and sometimes with Woden. But the view of the connection between Beowulf and Sceaf is strengthened by the following considerations. The old Saxons, and most likely the other conterminal tribes, called their harvest month (probably part of August and September) by the name *Beo* or *Bewod*, in all probability

their god of agriculture or fertility. Whether, or to what extent, this divinity is identical with the mythical hero of the poem, Mr Kemble does not venture to determine, though he indicates a strong leaning to the affirmative; and the identity of the hero of a later tradition with the divinity of an earlier one, as a subsequent translator (Wackerbarth) remarks, need not surprise us when we consider, that it is the usual course, where one religion supersedes another, for the gods of the abandoned system to descend gradually in that which follows, first, into demi-gods or supernatural heroes, and at last into mere traditional heroes.

But in so far as the main points of historical interest are concerned—viz., the date of the legends, and the race and regions to which they belong—the results of the historical and of the mythological view seem to be pretty nearly the same. The poem falls entirely out of the circle of the Northern Sagas, and probably belongs to Sleswig. All the proper names are Anglo-Saxon in form, but not the slightest mention is made of Britain, the Ongle mentioned being manifestly Angeln (see ANGLES), and not Anglia. From these and many other considerations, the learned editor infers that B. records the mythical beliefs of our forefathers; and in so far as it is historical, commemorates their exploits at a period not far removed in point of time from the coming of Hengest and Horsa, and that in all probability the poem was brought over by some of the Anglo-Saxons who accompanied Cerdic and Cyneric, 495 A. D.

The poem opens with an incident which reminds us of one of the most beautiful of Mr Tennyson's earlier poems, the *Mort d'Arthur*, and seems to show a similarity between British and Saxon traditions. We give it in the simple words of Mr Kemble's prose translation.

'At his appointed time then Scyld departed, very decrepit, to go into the peace of the Lord; they then, his dear comrades, bore him out to the shore of the sea, as he himself requested, the while that he, the friend of the Scyldings, the beloved chieftain, had power with his words; long he owned it! There upon the beach stood the ringed-prowed ship, the vehicle of the noble, shining like ice, and ready to set out. They then laid down the dear prince, the distributor of rings, in the bosom of the ship, the mighty one beside the mast; there was much of treasures, of ornaments, brought from afar. Never heard I of a comelier ship having been adorned with battle-weapons and with war-weeds, with bills and mailed coats. Upon his bosom lay a multitude of treasures which were to depart afar with him, into the possession of the flood. They furnished him not less with offerings, with mighty wealth, than those had done who in the beginning sent him forth in his wretchedness, alone over the waves. Moreover they set up for him a golden ensign, high over head; they let the deep-sea bear him; they gave him to the ocean. Sad was their spirit, mournful their mood. Men know not in sooth to say (men wise of counsel, or any men under the heavens) who received the freight.'

The poem, still keeping to the royal house of Denmark, goes on to narrate that Scyld is succeeded by B. (the elder), who is followed by Healfdene and his four children, of whom the second, Hrothgar, becomes king. 'There was success in arms given to Hrothgar, the dignity of war; so that his dear relations gladly obeyed him, until the young people waxed a mighty kindred band.' Hrothgar builds a magnificent palace, called Heorot. Here 'he distributed rings, treasure at the feast; the hall rose aloft, high and curved with pinnacles it awaited the hostile waves of loathed fire.' But Hrothgar is not long

permitted to dwell in tranquillity. 'The grim stranger Grendel, a mighty haunter of the marshes, one that held the moors, fen and fastness, the dwellings of the monster race,' and who seems to be a sort of combination of the man and the monster, 'whose cursed hide reckett not of weapons,' could not endure 'every day to hear joy loud in the hall.' 'He the Grendel set off then, after night was come, to visit the lofty house, to see how the Ring-Danes had ordered it, after the service of beer. He found then therein a troop of nobles, sleeping after the feast: they knew not sorrow, the wretchedness of men, they knew not aught of misfortune; the grim and greedy one was soon prepared, savage and fierce, and in their sleep he seized upon thirty of the thanes. Thence he again departed, exulting in his prey, to go home, with the carcasses of the slain, to visit his own dwellings.' Similar exploits are repeated, and Healfdene's son is continually 'seethed in the sorrow of the time;' nor might the prudent hero turn away the ruin, till Hygelac's thane, chief of the Geats, sends his retainers to his aid. The description of the expedition, and of many other parts of this remarkable poem, remind one strongly of Homer; and were we to describe it, we should do so by assigning it a place somewhere between the *Iliad* and *Hiawatha*. B. is the leader of this friendly band, and the chief incidents of the poem relate to his encounters, first with Grendel, and afterwards with a dragon.

The domestic arrangements which were made for the reception of B. and his companions present a striking, and probably genuine picture of the manners of our ancestors; and convey some information as to a liquor which has not ceased to find favour with their children. "Sit now to the feast, and joyfully eat, exulting in victory among my warriors, as thy mind may excite thee." Then was for the sons of the Geats, altogether, a bench cleared in the beer-hall; there the bold of spirit, free from quarrel, went to sit: the thane observed his office, he that in his hand bare the twisted ale-cup; he poured the bright sweet liquor; meanwhile the poet sang serene in Heorot, there was joy of heroes, no little pomp of Danes and Westerns.'

Further on there is an interesting description of the Danish queen: 'There was laughter of heroes, the noise was modulated, words were winsome; Wealtheow, Hrothgar's queen, went forth; mindful of their races, she, hung round with gold, greeted the men in the hall; and the freeborn lady gave the cup, first to the prince of the East Danes; she had him be blithe at the service of beer, dear to his people. He, the king proud of victory, joyfully received the feast and hall-cup. The lady of the Helmings then went round about every part of young and old; she gave treasure-vessels, until the opportunity occurred, that she, a queen hung round with rings, venerable of mood, bore forth the mead-cup to Beowulf. Wise of words, she greeted the Geat, she thanked God because her will was accomplished, that she believed in any earl, as a consolation against the crimes.'

It seems strange that beer should be the only drink on so great an occasion, seeing that wine is continually mentioned, and the hall is usually called the 'Wine Hall.' A spirited metrical translation of B., by A. D. Wackerbarth, was published in 1849 (Pickering).

BEQUEATH, to leave personal property by will or testament to another. In the case of *real* estate, the proper term to employ is *devise*. But although it is usual and safe so to use these words, neither of them is essential to the validity of an English will, but other words, shewing clearly the intention of the testator, will suffice. In the Scotch law, the term

B. can only apply to *personal* estate. Real estate, indeed, according to the existing regulations of that system, cannot be left or conveyed by will or testament; a testamentary disposition or settlement, expressed in certain technical terms of present conveyance, being necessary for the purpose. See *WILL; TESTAMENT; LEGACY; DISPOSITION (Mortis Causâ); SETTLEMENT; REAL ESTATE; PERSONAL ESTATE.*

BEQUEST, a legacy of personal property left by will. See **BEQUEATH** and its references.

BÉRANGER, JEAN-PIERRE DE, a celebrated French poet, was born in Paris, 19th August 1780, in the house of his grandfather, a tailor in the Rue Montorgueil, to whose care he was left entirely by his father, a scheming and not over-scrupulous financier. After living some time with an aunt at Péronne, to whom he appears to have been indebted for those republican principles which afterwards made him so obnoxious to successive French governments, *B.*, at the age of fourteen, was apprenticed to a printer in that place, where he remained three years, devoting all his leisure hours to the acquirement of knowledge. He now returned to Paris, where his father, a zealous royalist, was engaged in some questionable schemes of money-getting, which were mixed up with conspiracy. *B.* assisted him in his money affairs, so far as he honourably could, and kept his political secrets; but he did not disguise his contempt for the royalist cause, nor fail to express his opposite sympathies. The business, however, was not one to the taste of *B.*, who was throughout the whole of his life a man of the most sensitive honour, and he soon left it. He had ere this begun to write, but his poems were not successful; and reduced almost to destitution, he, in 1804, enclosed some of his verses to M. Lucien Bonaparte, with a letter explaining his circumstances, and with a request for assistance—the one solitary instance of solicitation during a long life of independence, marked by the refusal of numerous offers of lucrative patronage. The appeal was not made to a deaf ear. M. Bonaparte obtained employment for the poet, first as editor of the *Annales du Musée*, and afterwards as a subordinate secretary in the University; a post which he held for twelve years, when the government, provoked at his satire, and alarmed at his popularity, dismissed him. During the 'Hundred Days,' Napoleon offered *B.* the remunerative post of censor—a singular office for such a man. He refused it. But though he scorned to accept favour from, or to flatter Napoleon, at a time when it was alike fashionable and profitable to do so, he was of much too noble a nature to join in the sneers and reproaches which greeted the hero on his fall. Above the fear of power, he was incapable of taking advantage of misfortune. In 1815, *B.* published his first collection of songs, which soon attained a very wide popularity. In 1821, he published another collection, which was followed shortly after by some fugitive pieces, which subjected him to a government prosecution, a sentence of three months' imprisonment, and a fine of 500 francs. In 1825, a third collection, and in 1828, a fourth appeared, still more withering in its sarcasm on those in power; and the penalty of *B.*'s outspokenness was a fine of 10,000 francs, and nine months' confinement in La Force. The fine was soon paid by the poet's friends, and his prison became the resort of the most eminent men in the kingdom, and a very armoury in which he forged those keen-piercing bolts which galled so terribly, and contributed so much to the overthrow of the Bourbons. But *B.* refused to profit by the new state of things he had been instrumental in bringing about. Rejecting the emoluments and honour which his friends, now in

power, were anxious to bestow, he retired to live in privacy at Passy. In 1833, he published a fifth collection of songs, when he took a formal leave of the public; and from that time until the day of his death, twenty-four years after, he remained silent. In 1848, *B.* was elected a member of the Assemblée Constituante by more than 200,000 votes; but after taking his seat, to shew his appreciation of the honour conferred on him, he almost immediately resigned. He consistently rejected all the offered favours of the present Emperor, as well as a graceful overture on the part of the Empress, which he owned it cost him much to refuse. *B.* died at Paris, July 17, 1857. The cost of his funeral was defrayed by the French government, and his remains were attended to the grave by the most distinguished men in all departments of literature. *B.* was as emphatically the poet of the French people as Burns was the bard of the Scottish peasantry. The same stanch and fearless independence, genuine manliness, sound common sense, and contempt for everything mean and hypocritical, characterised both men; and as poets, they differ in excellence only as the sentiments of the French and Scottish people differ in their capacity to be turned into song. 'Neither friend nor enemy has as yet disclosed to us any speck on the heart, the honour, the genius, or the good sense of Béranger.' Since his death, his *Last Songs*, written between 1834 and 1851, have been published, and also *My Biography* (Paris, M. Perrotin; London, Jeffs). See *My Biography*; and *Memoirs of Béranger*, by M. Lapointe (Paris, 1857).

BERA'R, a valley situated locally in the Nizam's territories, but annexed politically to British India, for the maintenance of what is called the Nizam's Contingent. It is bounded on the N. by a detached portion of Scindia's dominions and the Nerbudda provinces; on the E. by Nagpoor; on the W., by Candeish; and on the S., by two of the Nizam's remaining districts—Maiker Bassim and Mahur. It lies between 20° 15' and 21° 40' N. lat., and between 76° and 78° 2' E. long., having an area of about 9000 square miles. It is traversed in its length by the Poornah—itsself a tributary of the Taptee—which, with its numerous affluent, affords an ample supply of water to the valley, and, on other grounds, is peculiarly suitable to the cultivation of cotton. The recent transfer from the Nizam to the British promises likewise to be favourable to this staple production. Not only have the oppressive transit-duties been removed, but a railway is about to connect the cotton district with Bombay. Though Ellichpore is officially the chief town, yet it is inferior in real importance to Comrawattee, the dépôt for the raw cotton.

BERA'T, a town of Albania, European Turkey, in the pashalic of Avlona, situated on the banks of the Tuberathi or Ergent, about 30 miles north-east of the seaport of the same name. It has a population of from 8000 to 10,000, two-thirds of whom are Greeks; the remainder, Turks. The valley in which *B.* stands is very fertile, producing large quantities of grain, oil, and wine. *B.* has a citadel, and traces of ancient Greek buildings, and gives title to a Greek archbishop.

BE'RBERA, a seaport station of Somauli, Eastern Africa, with a good harbour, on a bay of the Gulf of Aden. Lat. 10° 26' N., long. 45° 8' E. It is celebrated as the scene of a large annual fair, which brings nearly 20,000 people together from all quarters in the East. Coffee, grains, ghee, gold-dust, ivory, gums, cattle, ostrich-feathers, slaves, &c., are brought down to this place from the interior on strings of camels, sometimes numbering as many as 2000, and exchanged for cotton, rice, iron, Indian

piece-goods, &c. As soon as the fair—which usually extends from November to April—is over, the huts are carefully taken down, and packed up, and nothing remains to mark the site of the town but the bones of animals slaughtered for food during the continuance of the fair.

BERBERIDEÆ, or **BERBERIDEÆ**, a natural order of exogenous plants, of which the different species of Barberry (q. v.) afford the best known examples. Many of the plants of this order are spiny shrubs; some are perennial herbaceous plants. Their leaves are alternate, their flowers sometimes solitary, sometimes in racemes or panicles. The calyx consists of 3, 4, or 6 deciduous sepals; the corolla, which arises from beneath the germen, consists of petals equal in number to the sepals, and opposite to them, or twice as many; the stamens are equal in number to the petals, and opposite to them; the anthers are 2-celled, each cell opening curiously by a valve which curves back from bottom to top; the carpel is solitary and 1-celled; the fruit is either a berry or a capsule. This order, which is nearly allied to *Vitaceæ* (q. v.). (Vines, &c.), contains more than 100 known species, chiefly belonging to the temperate parts of the northern hemisphere, and of South America.

BERBERS, the general name usually given to the tribes inhabiting the mountainous regions of Barbary and the northern portions of the Great Desert. It is derived, according to Barth, either from the name of their supposed ancestor, *Ber*, which we recognise in the Lat. *A-fer*, an African (see letter B); or from the Greek and Roman term *Barbari*. The name by which they call themselves, and which was known to the Greeks and Romans, is *Amázigh*, or *Mazigh*, *Mazys*, *Amoshagh*, *Imoshagh*, &c., according to locality, and whether singular or plural. These tribes have a common origin, and are the descendants of the aboriginal inhabitants of Northern Africa. They appear to have been originally a branch of the Semitic stock; and although they have been conquered in succession by the Phœnicians, Romans, Vandals, and Arabs, and have become, in consequence, to some extent, a mixed race, they still retain, in great part, their distinctive peculiarities. Till the eleventh century, the B. seem to have formed the larger portion of the population inhabiting the southern coast of the Mediterranean, from Egypt to the Atlantic Ocean; but, on the great Arab immigrations which then took place, they were driven to the Atlas Mountains, and to the desert regions where they now live. In Tripoli, the allegiance they pay to the Turks is little more than nominal; in Algeria, where they usually are termed *Kahyles*, they are yet unconquered by the French; and in Morocco, where they are called 'Shellooh,' they are only in form subject to the emperor. The B. occupying the desert, who are called *Tuarik*, or *Tawarek*, by the Arabs, have become much mixed with the negro race. The number of the B. is estimated at between three and four millions. They are of middle stature, sparsely but strongly built. The complexion varies from a red to a yellow brown, and the shape of the head and of the features has more of the European than the oriental type. The hair is, in general, dark, and the beard small. The eyes are dark and piercing. Their manners are austere, and in disposition they are cruel, suspicious, and implacable. They are usually at war either with their neighbours or among themselves; are impatient of restraint; and possessed of a rude, wild spirit of independence, which makes it impossible for them to unite for any common purpose, or to make the advances in civilisation which one might otherwise

expect from their high physical organisation. They live in clay-huts and tents; but, in their larger villages, they have stone-houses. They have herds of sheep and cattle, and practise agriculture, and are especially fond of the cultivation of fruit-trees. They possess water-mills and oil-presses. The mines of iron and lead in the Atlas are wrought by them, and they manufacture rude agricultural implements, as well as swords, guns, and gunpowder. They formerly professed the Christian religion; but since the Arabs drove them from the fertile plains between the mountains and the sea, they appear to have retrograded in every way, and they are now among the most bigoted adherents of the religion of Mohammed; although their former creed has left a few traces, as in the names *Mesi* for God, and *angelus* for angel, and many curious customs still observed among them. See Barth's *Africa*, vol. i.

BERBICE, the east division of British Guiana, having its middle division, Demerara, on the W.; the Atlantic on the N.; Dutch Guiana or Surinam on the E.; and on the S., the basin of the Amazon, or rather, perhaps, the upper waters of the Surinam. From being a Dutch possession, this part of the coast, between the Amazon and the Orinoco, fell under the power of England in 1796. It was, however, soon restored to Holland at the peace of Amiens, but only to be recaptured in 1803. It stretches in long. between 57° and 58° W., and in lat. indefinitely southward, from about 6° 30' N. E. is subdivided into six parishes. The population, in 1834, was returned at 21,589, of whom 570 were whites; and the principal products are sugar, coffee, and cotton. But details generally of trade and statistics, and of climate also, may be more easily and satisfactorily treated under the general head of **BRITISH GUIANA**, than under the separate divisions of B., Demerara, and Essequibo. New Amsterdam, standing on the right bank of the river near its mouth, is at once the chief town and the seaport of the district. The Berbice river, though by no means the largest in the colony, is navigable certainly to the greatest distance from the sea. While the vastly more considerable Essequibo is interrupted by rapids within 50 miles of the coast, the Berbice admits a draught of 12 feet for 100 miles, and one of 7 feet for 60 more, the influence of the tide reaching nearly the whole way; and even as far as lat. 3° 55' N.—175 miles from its outlet by the crow's flight—it was found to have still a width of 100 feet, with a depth of from 8 to 10.

BERCHEMIA. See **SUPPLE JACK**.

BERCHTA (in Old German, *Peracta*, and the original form of the name *Bertha*, being from the same root as the English word *bright*, and meaning 'shining,' 'white') is, in German mythology, the name given in the south of Germany and in Switzerland to a spiritual being, who was apparently the same as the *Hulda* (gracious, benign) of Northern Germany. This being represented originally one of the kindly and benign aspects of the unseen powers; and so the traditions of *Hulda* (q. v.) in the north continued to represent her. But the B. of the south, in the course of time, became rather an object of terror, and a bugbear to frighten children; the difference probably arising from the circumstance, that the influence of Christianity in converting the pagan deities into demons was sooner felt in the south than in the north. *Lady B.* has the oversight of spinners. The last day of the year is sacred to her, and if she find any flax left on the distaff that day, she spoils it. Her festival is kept with a prescribed kind of meagre fare—oatmeal-gruel, or pottage, and fish. If she catches any persons eating other food on that day, she cuts them up, fills their

paunch with chopped straw and other such agreeable stuffing, and then sews up the wound with a ploughshare for a needle, and an iron chain for a thread. In some places, she is the queen of the crickets. She is represented as having a long iron nose and an immensely large foot. That she was once an object of worship, is testified by the numerous springs, &c., that bear her name in Salzburg and elsewhere. It is likely that many of the Sagas of B. were transferred to the famous Berthas (q. v.) of history and fable. The numerous stories of the 'White Lady' who appears in noble houses at night, rocks and nurses the children while the nurses are asleep, and acts as the guardian angel of the race, have doubtless their root in the ancient heathen goddess Berchta.

BERCHTESGADEN, a village of Bavaria, charmingly situated on a mountain slope, about 15 miles south of Salzburg. Pop. 3000. It has a royal hunting-lodge, but the place is most remarkable for its government salt-mines, from which 16,000 cwt. of rock-salt is annually obtained. During the residence of the court, the mine is sometimes illuminated, and its chambers are then seen to great advantage.

BERCY, a town of France, in the department of the Seine, situated on the right bank of the river of the same name. It forms a suburb of Paris, and has a population of 14,239. It has a large business in wines and other liquors.

BERDIA'NSK, a well-built seaport town of Southern Russia, government of Taurida, on the northern coast of the Sea of Azov. B. has the finest roads in the Sea of Azov, and is a place of great commercial activity, being the entrepôt for the products of surrounding governments. It has a trade in fish, wood, grain, coal, and salt; there are also extensive coal-mines and salt-lakes in its vicinity. Pop. about 7000. In 1855, during the Crimean campaign, Captain Lyons destroyed government property to a large amount, but the town was spared.

BERDITCHEV, a town in the government of Kiev, Russian Poland, famous for its four annual fairs. At these, cattle, corn, wine, honey, leather, &c., are disposed of. The average annual value of the sales is £600,000. Pop. 58,645, chiefly Jews.

BERE'ANS, an almost extinct sect of Christians, who originated in Scotland in the 18th c. Their name is derived from the circumstance that the inhabitants of Berea 'received the word with all readiness of mind, and searched the Scriptures daily.'—Acts xvii. 11. The founder of the B. was the Rev. John Barclay, a native of Perthshire, b. 1734, d. 1798. From him they also received the name of Barclayans. They believe that the knowledge of God's existence and character is derived from the Bible alone, and not from reason or nature; that the Psalms of David do not relate to David at all, but exclusively to Christ; that assurance is of the essence of faith; and that unbelief is the unpardonable sin. In the ordinary points of doctrine, they are Calvinistic.

BERENGAR I., king of Italy, was the son of Eberhard, Duke of Friuli, and of Gisela, the daughter of the Emperor Louis the Pious. He and Guido, Duke of Spoleto, were the two most powerful and ambitious nobles in Italy at the close of the 9th c. After the deposition of Charles the Fat in 887, B., Guido, and Adalbert, Count of Tuscany, became candidates for the Carolingian throne. B. was crowned king of Italy at Pavia in 888, while Guido attempted to secure the realm of France. The former soon irritated the nobles against him by condescending to hold his territory in fief from Arnulf, king of Germany, against whom he found it

vain to maintain his independence; and when Guido returned from his unsuccessful expedition to France, he was persuaded to put himself in opposition to B., and was chosen king of Italy. With the help of Arnulf, however, B. ultimately prevailed. After the death of Guido in 894, his son Lambert compelled B. to share with him the sovereignty of North Italy; but, on the assassination of Lambert in 898, B. contrived to obtain possession of the whole of Lombardy. His influence quickly sank. He could check neither the plundering incursions of the Hungarians across the Alps in the north, nor those of the Arabs, who laid waste the shores of the south. The nobles now called in Louis, king of Lower Burgundy, who was crowned at Rome in 901; but he proved no better, and was finally overpowered by Berengar. In 915, B. was crowned emperor by Pope John X.; but the nobles, who appear to have kept themselves during his reign in a state of chronic disaffection, again revolted, and, in 919, placed themselves under the banner of Rodolf of Burgundy, who completely overthrew B. on the 29th July 923. The latter, in his extremity, called in the Hungarians to his aid, which unpatriotic act alienated the minds of all Italians from him, and cost him his life, for he was assassinated in the following year, 924.

BERENGAR II., the son of Adalbert, Count of Ivrea, and grandson of Berengar I., succeeded to his father's possessions in 925, and married Willa, niece of Hugo, king of Italy, in 934. Incited by his ambitious and unscrupulous wife, he conspired against Hugo, and in consequence was compelled to flee to Germany, where he was received in a friendly manner by the Emperor Otto I. In 945, he recrossed the Alps at the head of an army. The nobles and the townspeople both welcomed him; but, instead of assuming the crown himself, he handed it over to the weak Lothaire, the son of Hugo. On the death of Lothaire, who was probably poisoned by Willa, B. allowed himself to be crowned along with his son Adalbert, in 950. To establish himself firmly in his new position, he wanted Adelheid, the youthful widow of Lothaire, to marry his son. She refused, and was subjected to a most cruel imprisonment, but ultimately found a helper and husband in the Emperor Otto himself, who, at the imperial diet of Augsburg in 952, compelled B. to acknowledge Italy to be a fief of the German empire. B. soon after engaged in war with the emperor, who sent his son Ludolf against him. Ludolf was successful, but died in 957, of poison administered, as was believed, by Willa. B. again mounted the throne, but behaved with such intolerable tyranny that his subjects and Pope John XII. called in the aid of the emperor, who marched into Italy in 961, and took possession of the country. B. took refuge in a mountain-fortress, where he held out till 964, when hunger compelled him to capitulate. He was sent as a prisoner to Bamberg, in Bavaria, where he died in 966. His wife, Willa, retired into a convent, and his three sons died in exile.

BERENGARIUS OF TOURS, a distinguished scholastic theologian, was born at Tours, in France, 998 A. D. His master, Fulbert de Chartres, is reported to have prophesied on his death-bed that B. would prove a dangerous man. In 1030, he was appointed preceptor of the school of St Martin, in Tours, and in 1040, made Archdeacon of Angers. Here he continued to deliver his metaphysico-theological prelections, and drew upon himself the charge of heresy, in reference to the doctrine of transubstantiation. He held the doctrine of Scotus Erigena, that the bread and wine in the sacrament of the eucharist remained bread and wine, and that

the faith of the believer who recognised their symbolic meaning only transformed them subjectively into the body and blood of Christ. This interpretation was condemned by Pope Leo IX., 1049—1050, and also by King Henry I. of France. In 1054, he retracted his opinion before the Council of Tours, but what B. meant by 'retractation' it is not easy to see, for he immediately returned to his conviction, and recommenced the advocacy of it. For this he was cited to appear at Rome, where he repeatedly abjured his 'error,' but never seems to have really abandoned it. Hildebrand, who was then pope, treated him with great moderation; and at last, when he discovered how hopeless it was to bind down B. by abjurations or declarations, he conceived it best to let him alone. Harassed and weakened by the attacks of the orthodox party, headed by Lanfranc of Canterbury, he finally retired to the isle of St Cosmas, near Tours, in 1080, where he spent the last years of his life in devotional exercises. He died in 1088. The greater number of his works are lost; such as are extant have been collected and published by the Vischers (Berlin, 1834).

BERENICÉ, the name of several celebrated women of ancient times.—1. B., daughter of Lagos and Antigone, and the second wife of the Egyptian king, Ptolemy I. (Soter), (323—284 B. C.). She is described by Plutarch as the first in virtue and wisdom of the wives of Ptolemy. Theocritus celebrates her beauty, virtue, and deification in his *Idyls* 15 and 17.—2. B., daughter of Ptolemy II. (Philadelphus) and Arsinoë, was married to Antiochus II. of Syria, after he had divorced his wife Laodice, whom, however, he again took back, putting B. away. Laodice having no faith in her husband, poisoned him, and caused B. and her son to be murdered.—3. B., daughter of Magas, king of Cyrene, granddaughter of B. No. 1, was to have been married to Demetrius the Fair, but he having slighted her for her mother, she caused him to be murdered, and then went to Egypt and married Ptolemy III. (Euergetes), in accordance with the terms of a treaty between her father and Ptolemy II. During the king's wars in Asia, the queen B. made a vow to offer her beautiful hair to the gods when her husband returned safely—a vow which she fulfilled. The hair was suspended in the temple of Venus, whence, it is said, it was taken away to form a constellation, *Coma Berenice*. B. was put to death by her son, Ptolemy IV. (Philopator), when he succeeded to the throne.—4. B., also called Cleopatra, daughter of Ptolemy IX. (Lathyrus), was, on her succession to the throne, married to Alexander II., by whom she was murdered 19 days after marriage.—5. B., daughter of Ptolemy XI. (Auletes), eldest sister of the renowned Cleopatra, was raised to the throne after her father's deposition, 58 B. C., but was put to death when her father was restored, 55 B. C. She was first married to Seleucus, whom she caused to be put to death, and afterwards to Archelaus, who was put to death with her.—There were, besides, two Jewish Berenices—the one, daughter of Salome, sister of Herod the Great and Costobarus, and mother of Agrippa I.; the other, and more famous, was daughter of this monarch. She was three times married: first, at a very early age, to Marcus, son of Alexander the Alabarch; afterwards to her uncle, Herod, king of Chalcis, who dying, left her for the second time a widow, at the age of 20; and again to Polemon, king of Cilicia, whom she soon deserted to return to her brother, King Agrippa II., the same before whom Paul defended himself at Cæsarea. After the capture of Jerusalem, she went to Rome, and Titus, who was much in love with her, would have married her but for the opposition of the people. The intimacy

of B. and Titus forms the subject of a tragedy by Racine.

BERENICÉ (modern name, Sakáyt-el-Kublee, 'Southern Sakáyt'), a town of Egypt, on a bay in the Red Sea, 20 miles south-west of Ras Bernass. It was founded by Ptolemy Philadelphus, and was in ancient times the emporium of the trade with India, but it is now ruined, and interesting only for its antiquities, which include hieroglyphics, sculptures, and a temple dedicated to Serapis. There are emerald mines in its vicinity that have been worked since the time of the ancient Egyptians.

BERESFORD, WILLIAM CARR, VISCOUNT, a distinguished military commander, natural son of the first Marquis of Waterford, was born 2d October 1768, and entered the army in 1785. After serving in various parts of the world, he bore a conspicuous part in the reconquest of the Cape of Good Hope in 1806, and subsequently, with the rank of brigadier-general, was with the British force that took possession of Buenos Ayres. In August 1808, he joined the British army in Portugal, and proceeded into Spain with Sir John Moore's force; was present at the battle of Corunna; and, after covering the embarkation of the troops, returned with them to England. In February 1809, Major-general B. was ordered a second time to Portugal, to take the command of the Portuguese army, with the local rank of lieutenant-general; and he succeeded in improving its discipline so greatly, as soon to render it highly efficient for active service. Appointed Marshal of Portugal in March, at the head of 12,000 men, he attacked the French in the north of that kingdom, crossed the river Douro, drove Loison's division back to Amarante, and uniting with the force under Sir Arthur Wellesley, pursued it in its retreat till it was utterly disorganised. For his services at the battle of Busaco, 27th August 1810, B. was nominated a Knight of the Bath. He commanded at the bloody battle of Albuera, May 16, 1811; and for the victory there gained over Soult, he received the thanks of parliament. He was present at Badajoz; at Salamanca, where he was severely wounded; at the various battles on the Pyrenees; at Nivelles, where he led the right of the centre; at Nive; and at Orthez. He was in command of the British troops which took possession of Bordeaux, and subsequently distinguished himself at the battle of Toulouse. In May 1814, he was created Baron, and in 1823 Viscount Beresford. By the Portuguese government, he was sent, in 1814, to Rio Janeiro, to suppress a formidable revolt there. In the Wellington administration, January 1828 to November 1830, he was Master-general of the Ordnance. He bore the title of Marquis of Campo Mayor and Duke of Elvas in Spain, Conde de Franco in Portugal, and was knight of several foreign orders. He died, without issue, 8th January 1854, when the title became extinct.

BERESINA, or BEREZINA, a river of Russia, having its rise in the north of the government of Minsk. It flows in a southward direction for about 240 miles to the Dnieper, which it joins above Redchitzka. It is connected with the Duna, or Dwina, by a canal, a communication between the Black and Baltic Seas being thus established. The B. is memorable on account of the disastrous passage of the French army, November 1812, during the retreat from Moscow. Two bridges over the B.—one for troops, the other for baggage and artillery—were hastily constructed. Many of the *pontoniers* died from the hardships endured in making these bridges. On the 27th, the passage of the French commenced, and was continued

during the whole of the day. Victor's rear-guard of 7000 men, under Partonneaux, were, however, intercepted by the Russians, and had to capitulate. On the 28th, a vigorous attack was made by the Russians on the French on both sides of the river, but too late to prevent the latter securing the road to Zembin. The Russians, however, established a battery of twelve pieces to command the bridge; and the panic and confusion of their enemies now became dreadful. The artillery bridge broke, and all rushing to the other, it was soon choked; multitudes were forced into the stream, while the Russian cannon played on the struggling mass. On the 29th, a considerable number of sick and wounded soldiers, women, children, and sutlers, still remained behind, despite the warnings of Marshal Victor and General Eblé, until preparations were made for burning the bridges. Then a fearful rush took place; and as the fire seized the timbers, men, women, and children threw themselves in desperation into the flames or the river. 12,000 dead bodies found on the shores of the river, when the ice thawed, attested the magnitude of the French disaster. The Russians took 16,000 prisoners and 25 pieces of cannon.

BERETTYO-UJFALU, a market-town of Hungary, county Bihar, with a pop. of 5500.

BEREZNA, a town of Russia, in the government of Tchernigov, on the Desna, with a pop. of 5500.

BEREZO'V, or **BERESOFF** ('the town of birch-trees'), a town of Siberia in the government of Tobolsk, on the left bank of the Sosva, a branch of the Obi, in lat. 63° 30' N. It is a small place, but important as the sole fur and skin trading station in a vast extent of country. Its annual fair is largely attended. It is the favourite residence of the Ostiaks and Voguls. Prince Menschikoff, the favourite of Peter the Great, who was banished to B., died and was buried here in 1731. His grave was opened 90 years afterwards, when his body, clothed in the uniform of the time, was found as free from decay as on the day it was buried, the frost, which at B. penetrates the soil to the depth of several feet, having preserved it.

BERG, **BURG**, **BURGH**, roots entering into the composition of many names of places. *Berg* (Ger.), *Beorg* (Ang.-Sax.), means 'hill,' 'mountain'; and *burg*, or *burgh*, means 'fort,' 'castle,' 'citadel,' probably from being situated on a hill or eminence. See **BOROUGH**, **BURGH**.

BERG, formerly a duchy of Germany, now incorporated with the Prussian dominions, and divided into the circles of Düsseldorf, Solingen, Elberfeld, Lennep, and Duisburg. After various vicissitudes, B. had merged in the electorate of Bavaria. In 1806, Bavaria ceded it to France; and Napoleon the same year adding to it large adjoining territories, made its area about 6700 square miles, and erected it into a grand duchy, constituting his brother-in-law, Murat, sovereign. Two years afterwards, Murat, being transferred to the throne of Naples, Napoleon's nephew, then Crown Prince of Holland, was made grand duke. The peace of 1815 gave B. to Prussia.

BERGAMA (ancient *Pergamos*), a city of Asiatic Turkey, pashalic of Anatolia, situated in a beautiful and fertile valley, on the right bank of the Caicus, about 40 miles north-north-east of Smyrna. Lat. 39° 4' N., and long. 27° 12' E. In early times, the city was the capital of the kingdom of Pergamus (q. v.). Many ruins still exist to attest the former magnificence of Bergama. The present population of B. is about 15,000, four-fifths of whom are Turks.

BERGAMO (the ancient *Bergomum*), a fortified town of Lombardy, situated on some low hills between the Serio and the Brembo, about 29 miles

north-east of Milan, in lat. 45° 42' N., and 9° 37' E. B. consists of two parts—the upper city, wherein the nobility, a very exclusive class, reside; and the Borgo, a suburb where all business is transacted. B. is well built, has a castle, occupying the most elevated part of the town, and a massive cathedral. Silk, cotton, linen, and woollen fabrics and iron goods, are manufactured. It has also an extensive trade in grindstones, quarried in the vicinity. Annually, in the month of August, the largest fair in Northern Italy is held here, at which money to the estimated amount of £1,200,000 is turned over. Under the Roman empire, B. became a municipal town of importance. It was destroyed by Attila, 452 A. D.; and after the fall of the Roman empire, it became one of the chief towns of the Lombard kings in this part of Italy, and capital of a duchy. After numerous changes, its inhabitants placed themselves under the protection of the Venetian Republic in 1427, and formed an integral portion thereof (with one exception of 9 years) until the subversion of the republic by Napoleon in 1797. Bernardo Tasso, the father of Torquato, and Tiraboschi, author of *The History of Italian Literature*, were natives of Bergamo. B. is the capital of the province of the same name, which has an area of 928 square miles, a population of 364,000, and good pasturage for sheep and goats; iron, marble, lignite, and whetstones, are also found.

BERGAMOT is the name of various kinds of pear, to which, however, no common distinctive character can be assigned. The name is used both in Britain and upon the continent of Europe. The proper B. pear is probably the *B. Crasanne*, a flattish, rough-skinned pear with a long stalk. It has a very juicy pulp, as soft as butter, of an extremely pleasant flavour, and is esteemed as one of the best dessert pears. Metzger, in his work on the pomaceous fruits (*Kernobstsorten*) of the south of Germany (Frankfort, 1847), describes no fewer than 47 kinds of pears, which all bear the name of B., although some of them differ very widely from each other.

BERGAMOT is also the name of a species or variety of the genus *Citrus* (q. v.), also called the **B. ORANGE**, or **MELLAROSA**; by some botanists regarded as a variety of the orange (*C. Aurantium*); by others, as a variety of the lime (*C. Limetta*); and elevated by Risso to the rank of a distinct species, under the name of *C. Bergamia*. Of its native country or origin, nothing can be told, except that it was probably derived, like its congeners, from the East. It is now cultivated in the south of Europe; and from the rind of its fruit, the well-known **OIL OF B.** is obtained, which is extensively used in making pomades, fragrant essences, eau de Cologne, liqueurs, &c. The fruit is pear-shaped, smooth, of a pale-yellow colour, and has a green, subacid, firm, and fragrant pulp. The essential oil is obtained by distillation, or by grating down the rinds, and then subjecting them to pressure, which is the better method. The oil is also obtained from other varieties or species of the same genus. It is of a pale-yellow colour, or almost colourless. One hundred B. oranges are said to yield about 2½ ounces of oil. Oil of B. is frequently employed for diluting or adulterating the very expensive blue volatile oil of chamomile (q. v.).

BERGEN, a seaport town of Norway, in the province of the same name, situated on a promontory at the head of a deep bay, called Vaagen. Lat. 60° 24' N., long. 5° 18' E. With the exception of the north-east side, where lofty mountains enclose it, B. is surrounded by water. It is walled, and additionally protected by several forts, mounting in all upwards of 100 guns. The entrance to

the Sierra de Gador. Agriculture is also prosecuted to some extent.

BERKELEY, a small town of Gloucestershire, 15 miles south-west of the town of Gloucester, on the small river Avon, a mile and a half east of its junction with the estuary of the Severn. Pop. of borough, 949; of parish, 4344. The town lies in the fine vale of B., which is 25 miles long, and 4 broad, between the Severn on the west, and beech-covered hills on the east. This vale consists of rich meadow pasture-land, on a deep, fat loam, and is celebrated for its dairies and cheese. The latter is the far-famed 'Double Gloucester,' of which each cow yields 340 lb. a year. Near B. is the entrance to the B. and Gloucester Canal, navigable for vessels of 600 tons. Some trade exists in timber and malt. B. Castle is an embattled building on an eminence south-east of the town, and which, about 1150, was granted by Henry II. to Robert Fitzhardinge, with power to enlarge and strengthen it. Here Edward II. was murdered in 1327 by Maltravers and Gournay. In the civil wars of Charles I., the castle held out for the king, but was taken after a nine days' siege by the Parliamentarians. In the castle is preserved the cabin-furniture of Drake the navigator. Dr Jenner, the discoverer of vaccination, was a native of B., and is buried in the parish church of St Mary here.

BERKELEY SOUND, the most frequented inlet of the East Falkland Island, near its north-east extremity. It is in lat. 51° 30' S., and long. 57° 56' W. Though it is difficult to enter, yet it contains several excellent harbours. Its shores yield ample supplies of water, cattle, and vegetables.

BERKELEY, GEORGE, Bishop of Cloyne, and a distinguished philosopher, was the eldest son of William B., a cadet of the family of the Earl of Berkeley. He was born on the 12th March 1684, at Kilcrist, near Thomastown, county of Kilkenny, Ireland. As a boy, he studied at the school of Kilcrist, at which Swift also received his early education; and in his fifteenth year he followed his great countryman to Trinity College, Dublin, where, in 1707, he obtained a fellowship. At Trinity, he enjoyed the society of Swift, who patronised him, as he did almost everybody, and who subsequently had a great deal to do in shaping his fortunes.

B.'s career as an author began in 1707 (the year in which he obtained his fellowship) by the publication of a work written three years before, at the age of twenty, entitled *Arithmetica absque Algebra aut Euclide Demonstrata*. This was followed, in 1709, by the celebrated essay, *Towards a New Theory of Vision*, in which he demonstrated the dependence of the perceptions of distance, magnitude, and situation on the sense of touch. This essay led to considerable controversy at the time, though its conclusions may now be considered as not admitting of doubt. In 1733, B. produced a pamphlet in vindication of it—viz., *The Theory of Vision or Visual Language, shewing the Universal Presence and Providence of the Deity Vindicated and Explained*. By this time he had propounded his system of absolute idealism. His *Treatise concerning the Principles of Human Knowledge* appeared so early as 1710. Its object was to undermine the materialism of the age, by denying, on received principles of philosophy, the reality of an external world. If there is no external world, he argued, the phenomena of sense can be explained only by supposing a Deity continually necessitating perception. B. has since been laughed at by many who could not see how the premises laid in the philosophy of the day led to his system; by many he will always be laughed at as an idle dreamer;

but, in point of fact, his system is a monument at once of marvellous subtlety of mind and of the most pious devotion of the intellectual powers to the cause of religion. The object was, as the full title of the book itself sets forth, to inquire into and remove the causes of scepticism, atheism, and irreligion. It is only an illustration of the truth of the old saying, that extremes meet, if, in following out this pious purpose, he prepared the way for a subtler form of scepticism (in Hume's philosophy) than the world had previously known. The reader will find valuable assistance to the apprehension of B.'s system in Sir William Hamilton's *Discussions*, and in his dissertations and notes to Reid's *Philosophy of the Human Mind*. It must suffice to mention here that B. was the first philosopher who proposed a scheme of absolute idealism.

In 1713, B. went to reside in London, where, in the same year, he published a defence of his ideal system, *Three Dialogues between Hylas and Philonous*. Shortly after this he was appointed chaplain and secretary of legation under Lord Peterborough, whom he accompanied to Italy. In 1721, he returned to London; and in 1724, he became Dean of Derry, with an income of £1100, and resigned his fellowship.

B. was not a man to settle in the enjoyment of leisure and opulence. The Dean of Derry set to devising schemes of usefulness, fixing at last on one by which his deamery and income were to be exchanged for exile and £100 a year. This was the Bermudas College scheme for training pastors for the colonies, and missionaries to the American Indians. Swift, failing to induce him to give the project up, made influence with ministers to support it, which they promised to do. Full of hope, B. prepared for his exile; he married in August 1728, Anna Elvert, daughter of Right Hon. John Forster, Speaker of the Irish House of Commons, and soon after sailed for Rhode Island. The support promised by government was never given to him, and, after six years, he returned to England heartbroken with failure, and harassed by creditors. He had barely returned, however, when (1734) he received the bishopric of Cloyne, as a mark of favour from the queen. He was now once more in the enjoyment of leisure for literature. Soon appeared the *Minute Philosopher*, followed by various letters and pamphlets on the state of the country, and in 1749 by *A Word to the Wise*. In 1744, he gave the world his notions of the virtues of tar-water in a book entitled *Siris*. Tar-water appears to have been in his thoughts as in his system—which must have been saturated with it—from this time till his death. His last work was *Farther Thoughts on Tar-water*, published in 1752. The fact is, he was hypochondriacal for many years before his death. He died, 14th January 1753, at Oxford, whither he had gone to live with his son, who was studying at Christ Church. A genial companion, an affectionate and steady friend, he was loved by all of his contemporaries who enjoyed his society; a graceful writer, a subtle philosopher, and an active churchman, his whole life was devoted to usefulness, and ennobled by the purity of his aspirations. The best edition of his works is that published in London, 1784, 2 vols. 4to.

BERKSHIRE, a midland county of England, bounded N. by Gloucester, Oxford, and Bucks; E. by Middlesex; S. E. by Surrey; S. by Hampshire; and W. by Wiltshire. Greatest length, 50 miles; average breadth, 15. It is the thirty-second of the forty English counties in size; area, 752 square miles, nearly one-half of which is under tillage, one-fourth in pasture, and one-sixteenth in wood. B., which is one of the most beautiful of the English counties, lies in the valley of the Thames, and has

an undulating surface, rising in some parts into hills. Older tertiary strata, consisting of the London clay, occupy the east part of the county; cretaceous strata, the middle; and oolitic, the west. A range of chalk-hills, or downs, connected with the Chilterns on the east, and the Marlborough Downs on the west, crosses the country into Wiltshire, from Reading to Wallingford, attaining at White Horse Hill (so called from the gigantic figure of a horse defined in the chalk—a relic of ancient times) a height of 893 feet. Between this range—the west part of which is occupied by sheep-walks—and a smaller oolitic one skirting the valley of the Thames, is the Vale of the White Horse, the richest part of the county, and drained by the Ock. To the south of the Downs is the fertile Vale of Kennet, drained by the river of that name, and its feeder, the Lambourn. To the east is the forest district, comprising Windsor Forest, part of Bagshot Heath, &c. The forest chiefly consists of hazel, oak, beech, ash, and alder. The Thames skirts the whole north border of the county, winding through a course of 100 miles, but in a direct line, only 52, and navigable nearly the whole way. It is the chief river of B., the other rivers of the county being its tributaries; of which the chief are the Kennet, Leddon, and Ock. The Kennet is navigable for 30 miles. The climate of B. is very healthy, being mild in the valleys, and bracing on the high lands. The soil varies greatly: in the valleys, it is generally a fertile loam, with a subsoil of chalk, gravel, or clay. The country between the valleys of Kennet and White Horse consists chiefly of sheep-walks; and along the Thames, and to the west of the Ridge Way, or Downs, it is chiefly dairy and pasture land. Under the meadows, on the Kennet, near Newbury, is a layer of peat, which is extensively burnt, and the ashes applied as a top-dressing to the pastures. The chief crops are oats and wheat. 'Double Gloucester' and 'pine-apple' cheese are exported in large quantities to London. There is a superabundance of horses. Swine are extensively reared, especially near Faringdon, the breed being one of the best in England. Property is very much divided, and the number of gentlemen's seats and villas is very great. The farms are generally of moderate size. The county is traversed by the Great Western Railway and its branch-lines, and by two canals. B. is divided into 20 hundreds, 151 parishes, and 12 poor-law unions. It returns 9 members to parliament, 3 for the county, 2 each for Reading (the county town) and Windsor, and 1 each for Wallingford and Abingdon. Besides these towns, there are the municipal boroughs of Newbury (the scene of two severe conflicts in the civil war) and Maidenhead, and the market-towns of Faringdon, Hungerford, Wantage, Wokingham, East Ilsley, and Lambourn. Pop. 170,065. Education is well provided for: schools, 507; scholars, 22,649. Places of worship, 435 (Church of England, 206; Wesleyan Methodists, 125). The county has no manufactures of any importance. The British and Roman remains are numerous, including Roman roads, and many camps and barrows. Of the old castles, the principal relic is Windsor (q. v.); of monastic establishments, the abbeys of Abingdon and Reading. The churches are small, and from the scarcity of building-stone, are often constructed of chalk and flint. There are many Norman churches, erected in the 12th and 13th centuries.

BERLE'NGAS, a group of rocky islands in the Atlantic, off the west coast of the Portuguese province of Estremadura, 10 miles north-west of Peniche. The principal one, Berlenga, is fortified, and has been used as a state-prison.

BERLICHINGEN, GOETZ or GOTTFRIED VON,

'of the Iron Hand,' a German knight of the 16th c., may, with Ulrich von Hutten, be considered as the last worthy representative of the chivalry of the middle ages, then expiring. He was born at Jaxthausen, in Württemberg, in the ancestral castle of his family, which may be traced back into the 10th c. His education was conducted by his uncle Kuno, with whom he attended the diet of Worms in 1495. He gratified his passion for war at first by taking part in several of the quarrels between German princes, and at the siege of Landshut lost his right hand, which was replaced by one of iron, yet shewn at Jaxthausen. When the general peace of the country had been established under Maximilian I., Goetz retired to his castle. But a restless spirit, and the general turbulence of the time, involved him in continual feuds with the neighbouring barons and free cities, in which he displayed a mixture of lawless daring and chivalrous magnanimity. Having joined Duke Ulrich of Württemberg against the Swabian league, on the duke's expulsion, he was taken prisoner, and had to pay a ransom of 2000 florins. In the Peasants' War of 1525, he took part with the insurgents, and was chosen leader of a part of their forces. In his narrative, he ascribes this step to compulsion; more likely it was his own restless and turbulent spirit, and a desire for revenge on his old enemies of the Swabian league. On the unfortunate issue of the war, he at first made his escape, but was afterwards fallen upon unawares by a band of leaguers, who extorted an oath that he would appear before the league when summoned. Accordingly, he had to appear at Augsburg, where he was kept in arrest for several years, and at last sentenced to perpetual imprisonment in his own castle, and, in case of his breaking this condition, to a fine of 20,000 florins. He passed eleven years in this state, and was only pardoned on the dissolution of the league. He died July 23, 1562, after having still taken part in campaigns in Hungary and in France. He wrote an account of his own life, published by Pistorius (Nürm. 1731; Bresl. 1813), which furnishes an excellent picture of the social life and manners of the period, and on which Goethe grounded his drama of *Goetz von B.*, translated by Sir Walter Scott.

BERLI'N, the capital of Prussia, and one of the largest cities in Europe, is situated on the Spree in lat. 52° 30' N., long. 13° 24' E. It shews throughout evidence of a comparatively modern origin. Although it is ascertained that so far back as the 13th c., the central spot of the present city was inhabited, B. was long little more than a fishing-village, scattered on some small islands in the Spree, and upon its right bank. The derivation of the name is disputed; but it is most probably deduced from a Slavonic word, Berle, indicative of its site in the middle of an extensive sandy plain. The growth of the city is by no means to be attributed to the natural advantages of its situation, for, in winter, it is cold and exposed; and in summer, notwithstanding that the surrounding country is now cultivated, the reflected heat is oppressive, and the clouds of dust which rise render the residence unpleasant enough, without taking into account sundry inconveniences which testify that, on a perfect level, proper sanitary arrangements cannot be efficiently made. It was not till the great elector, Frederick William, had united the separate duchies of which Prussia is now formed, that B. became of consequence as the most central town, and the capital of a large state. His successor, the first king of Prussia, followed the footsteps of his predecessor in enlarging and beautifying the capital; and at the close of his reign, in the end of the 17th c., the population numbered about 50,000. In the next century, it received accessions of French and

Bohemian colonists, driven into exile by religious persecution. Every inducement was then held out to bring foreigners to settle in the rising city. Under Frederick the Great, B. continued to prosper. At his death, the inhabitants numbered 145,000. The rate of progress has been enormously accelerated in the present century. The population, inclusive of a garrison of 15,000 men, amounted, in 1858, to 455,000. The greater number of these are Protestants, there being only some 15,000 Roman Catholics, and about the same number of Jews.

The city is chiefly composed of long straight streets, succeeding each other with monotonous regularity. It occupies a large space in proportion to its population, its area being nearly 7000 acres. The houses and public buildings are built of brick, plastered or stuccoed outside, and they soon acquire a faded appearance. The 'Unter den Linden,' which is the principal street and fashionable promenade, is in design one of the handsomest streets in Europe. Long rows of lime-trees—which bear marks, however, of a not over-fertile soil—extend down the broad street which enters from the public park by the stately Brandenburg gate, built after the model of the Propylæum at Athens, and leads—flanked on either side by many of the principal public buildings, including the palaces of the Prince of Prussia and the Prince Frederick-William, the University, the Arsenal, the Opera-house, the Academy of Arts, and the Russian and English embassies—to the Palace Bridge, with its white marble statues. This bridge crosses a branch of the Spree to a garden bounded on three sides by the Royal Palace, the Cathedral, and the Old Museum. The present Royal Palace, within which are incorporated the remains of older buildings, was begun by Schlüter in 1699, and completed in 1716. It is imposing only from its mass. Within, it contains some fine rooms, and some valuable paintings; but since 1848, has been almost deserted by royalty. The Old Museum, which was designed by the great Prussian architect, Schinkel, has in front a beautiful colonnade, adorned by the frescoes of the painter Cornelius. This museum serves to contain the picture-gallery, which is very rich in paintings by the early Italian and German masters, collected under the art-critic Waagen; and also the collections of ancient sculpture and other antiquities placed under the superintendence of the distinguished archæologist Gerhard. Behind the Old Museum stands the new, not externally attractive, but internally fitted up with great magnificence. The staircase is decorated with frescoes by Kaulbach. The chief part of the contents is formed of the Egyptian antiquities brought home by the expedition under Lepsius, the ethnological collection, and the fine collection of engravings. The cathedral is a building of no beauty. A new cathedral, upon an immense scale, was projected; but after making a little progress, was stopped for want of funds; and its unfinished fragments disfigure the otherwise remarkable island upon which the buildings just mentioned are situated. In the immediate neighbourhood is the Arsenal, considered by the Prussians to be one of the best examples of renaissance architecture. Of Gothic architecture, B. possesses few examples. It has no ancient churches, or other buildings, of any value in an architectural point of view—or even in a historical; and though one or two churches have recently been erected in modern Gothic, their effect is not very successful. Throughout the city, a large number of statues of military heroes are distributed, the most remarkable among them being the equestrian statue by Rauch, erected in 1851 to the memory of Frederick the Great.

Since 1810, B. has been the seat of a university,

which has been the means of bringing within it a literary and scientific circle of unexampled brilliancy. The philosophers Fichte, Hegel, and Schelling; the theologians Neander and Schleiermacher; the jurist Savigny; Humboldt and the geographer Ritter; and the physiologist Müller—all made it their residence. At present, the university cannot boast such great names; but Raumer and Ranke, the historians, still adorn it; and Encke in astronomy; Mitscherlich and Rose in chemistry; Dove in physics; Ehrenberg in natural history; Hengstenberg in theology; Casper in medical jurisprudence; Stahl, Gneist, and Keller in law—are men of high reputation. The number of students exceeds 2000. The largest faculty is that of law, which numbers 600 students. In connection with the university are various museums of natural history, botany, &c.; and the magnificent Royal Library, containing 500,000 volumes, and nearly 5000 MSS. As intermediate schools, there are provided six gymnasia, or high schools; and in special branches, there are provided schools of technology, architecture, artillery, military engineering, and veterinary surgery. Learned societies of all kinds exist, as well as academies for the cultivation of the fine arts. The laws for the censorship of the press prevent newspapers from being numerous; but there are several magazines, and a large number of literary and scientific books are published annually.

The trade and commerce of B. are extensive. The city has long been famous for beautiful castings in iron, and the porcelain manufactured has a good reputation. Manufactures of cotton and linen exist; and paper, carpets, surgical, optical, mathematical, and musical instruments are made in some quantity. These different manufactures, although many of them were much injured during the convulsions of 1848, have recently received a considerable impulse from the railways, which have placed the city in communication with all parts of Central Europe. The charitable institutions are numerous; the most important being the two magnificent hospitals of the Charité and the Bethunien. Since 1808, the city has possessed a municipal constitution; but the powers of the magistrates are very limited.

BERLIOZ, HECTOR, a fertile musical composer, was born December 11, 1803, at La-Côte-St-André, in the department of Isère, France, where his father was a physician. Against his father's wishes, who intended him to follow the medical profession, he devoted himself to music, and proceeding to Paris, studied at the Conservatoire de Musique under Lesueur and Reicha. In 1828 the second prize at the Conservatoire was awarded to him; and in 1830, his cantata of *Sardanapalus* won the first. He now went to Italy, where he resided about two years; and on his return, published several compositions, the merits of which were much canvassed. His works are too numerous for specification; but among the most successful are the symphonies of *Harold*, *Romeo et Juliette*, and the *Symphonie Funèbre et Triomphale*, the requiem for the funeral of General Damrémont, 1837; the overture to *Carnaval Romain*, and the *Hymne à la France*, performed August 1, 1844, by an orchestra of almost a thousand musicians. B. has since conducted many concerts in Russia, Germany, and England. In 1839, he was made a Chevalier of the Legion of Honour; and in 1856, was elected a member of the Institute at Paris. He is also librarian to the Conservatoire. The peculiarity of the compositions of B. consists in their endeavour to make instrumental music the exponent of particular feelings as well as general emotions. Some critics are of opinion that this notion has led the composer into extravagance and

incoherence; while others speak in high terms of the freshness and individuality which characterise his style, and look upon him as the chief of the romantic school of music.

BERM, in Fortification, is a ledge or pathway, from 3 to 8 feet in width, at the bottom of the outside of a rampart, where it joins the scarp or inner side of the ditch. It is almost on a level with the natural surface of the ground; and serves in part as a passage-way for the troops of the garrison, and in part as a means of preventing the ditch from being filled with earth and rubbish, when the rampart is battered by the besiegers.

BERMO'NDSEY, a south-east suburb of London, on the south bank of the Thames, and traversed by the Greenwich Railway. It has extensive tan-yards and wharfs. Pop. of parish, 48,128.

BERMU'DAS, or **SOMMERS'S ISLES**, were so named respectively from Bermudez, a Spaniard, who first sighted them in 1527, and from Sir George Sommers, an Englishman, whose shipwreck here in 1609 was the immediate occasion of their being colonised from Virginia—itsself only 4 years old—in 1611. This low and lonely archipelago is a mere group of specks, for, though it numbers perhaps 500 islets, yet it measures only about 12,000 acres in all; the whole occupying a space of about 20 miles in length by little more than 6 in breadth. The value of this natural fortress, which can hardly be overrated, arises from its situation. In lat. 32° 20' N., and long. 64° 50' W., the B. occupy, commercially and politically, a singularly commanding position. At a distance of 600 miles from Cape Hatteras, in North Carolina, they are about equally remote from the north of Maine and from the south of Florida; again, between the two grand divisions of British America, they form an almost indispensable bond of union; and lastly, they flank, on either side, the two living highways which respectively lead from the North Atlantic to the Gulf of Mexico, and from the Gulf of Mexico to the North Atlantic. The four principal islands are—St George's, 3½ miles in length; Bermuda, 15; Somerset, 3; and Ireland, 3—the breadth ranging between 2 miles and 1 furlong. The minor islands of St David, Cooper, Smith, Long-Bird, Nonsuch, &c., form numerous picturesque creeks and bays of great size and depth, such as the Great Sound, Castle Harbour, Harrington Sound, and others. Most of the other members of the group are individually insignificant, many of them indeed without name or inhabitant. St George's Isle, the military station of the colony, commands the entrance of the only passage for large vessels—the narrow and intricate channel, which leads to its landlocked haven, being defended by strong batteries. From the strange shapes of most of the islands, and the number of spacious lagoons, the communications are almost as necessarily by water as those of Venice; while the cedar-boats glide under the bluest sky, through an element so clear as to reveal, even to its lowest depths, the many varieties of excellent fish sporting among the coral rocks, and the exquisitely variegated shells. On the structure and formation of the archipelago, it is necessary merely to add, that it is the most northerly point on the globe where the living zoophyte still piles up its submarine architecture. The climate may be said to complete the paradise, resembling that of Persia, with the peculiar addition of a constant sea-breeze. Between December and March, the thermometer ranges from 60° to 66°; in June, from 83° to 86°; and between April and September, from 75° to 79°. As the dew-point ranges high, the air is moist at all seasons. With respect to productions, the entire soil presents

under tillage of every description only 1227 acres; in grass for cattle-fodder, 33; and in wood or pasture, 10,339. Of the cultivated grounds, the main crops are potatoes, onions, and other garden-vegetables, arrow-root, maize, &c. Besides being useful as a station for those British vessels of war which are charged with the care of the West Indies on the one side, and the northern provinces on the other, B. forms an important dépôt for convicts, who are lodged in a large prison, and employed in various kinds of labour. Between B. and Halifax, Nova Scotia, there is a regular steamer carrying the mails. In 1851, the total population was 11,092; 4669 white, and 6423 coloured. In both races, the preponderance of females was somewhat remarkable, being 739 in the former, and 759 in the latter. The above census confined itself to residents, excluding the servants, whether civil or military, of the government, and the convicts brought from England; and, as those two classes amounted to 1535, the grand total would reach 12,627—as nearly as possible a mouth to an acre. In the B. emancipation has been decidedly beneficial, though here, as in Antigua, it was carried at once into full effect without the intermediate stage of apprenticeship. The group is under the authority of a governor, a council of 9 members, and an assembly of 36. There are 12 free, and 9 private schools. With regard to religion, more than three-fourths of the population belong to the Church of England, which has 4 clergymen. The Presbyterians, Wesleyans, and Roman Catholics, have one minister each.

BERN, or **BERNE**, the most populous, and next to that of the Grisons, the most extensive canton of Switzerland; its area being nearly 2600 square miles. It lies between lat. 46° 20' and 47° 30' N., and long. 6° 50' and 8° 27' E. It has France on the north; on the other three sides, it is surrounded by its sister-cantons. B. is one of the three governing cantons of the Swiss Confederation (since 1849, it has been the permanent seat of the Swiss government), and had, in 1850, a population of 458,031—about one-fifth of the total inhabitants of Switzerland. Of these, 54,000 were Roman Catholics, the rest Protestants. The fertile valleys of the Aar and the Emmen divide the mountainous Alpine region in the south from the Jura Mountains in the north. The valleys of Simmenthal, Lauterbrunnen, Grindelwald, and Hasli, in the south, called the *Bernese Oberland*, are celebrated for their beauty. The lakes of Thun, Brienz, Neuchatel, and Biemme are in B., which is watered by the Aar and its several tributaries. The climate, from the great difference in the elevations of the territory, is necessarily very variable, and subject to sudden changes, and frequent rains and fogs, but it is generally healthy. The districts of the Aar and the Emmen are the most fruitful, producing corn and fruits of various kinds, and affording excellent pasturage for cattle, which, with dairy produce, form the chief agricultural wealth of Bern. Corn and potatoes are not raised in sufficient quantities for home consumption. The vine grows in some districts, and hemp and flax in small quantities are raised. The horses of the Emmenthal are much prized. The lakes abound with salmon and trout. Iron, lead, and copper are found in the canton, which has also quarries of gypsum, marble, freestone, and granite. Its manufactures, which are not extensive, consist chiefly of linen, coarse woollens, leather, iron and copper wares, articles of wood, and watches. The canton is traversed by good roads, and its lakes and the river Aar are well supplied with steam-packets. The educational condition of the canton is good. B. entered the Swiss Confederation, in which it now

holds the second rank, in 1352. In the 15th and 16th centuries, it added to its possessions Aargau and Vaud, which it lost during the wars of the first Napoleon; but it received in return Bienne and its territory, and the greatest part of the bishopric of Basel. It furnishes a contingent of 5324 men to the federal army.

BERN, capital of the above canton, is situated in lat. 46° 57' N., and long. 7° 26' E., on a lofty sandstone promontory, more than 1700 feet above the sea, formed by the winding Aar, which surrounds it on three sides, and is crossed by two stone-bridges, one of which is a magnificent structure, upwards of 900 feet long, with a central arch 150 feet wide and 93 feet high. The fourth side was defended by fortifications, but these have been converted into public walks. B. has an imposing appearance from a distance, and a nearer view discloses one of the best and most regularly built towns in Europe, as it is the finest in Switzerland. The houses are massive structures of freestone, resting upon arcades, which are lined with shops, and furnish covered walks on both sides of the street. Rills of water flow through the streets, which are also adorned with numerous fountains. There are many fine public promenades in the environs, and the view of the Alpine peaks from the city is magnificent. The principal public buildings are a Gothic cathedral, founded in 1421, with some interesting tablets and relics; a new and magnificent structure, designed to accommodate the Swiss diet and administration; the mint, the hospital, and the university. B. has an interesting museum, and a valuable public library of 40,000 volumes. The manufacturing industry of B. is not great—gunpowder, firearms, leather, straw-hats, and paper, are the chief articles. It has a considerable trade in the produce of the surrounding district. Pop. 27,000. B. was founded by Duke Berthold V., in 1191, who gave it the name B., because he had killed a bear on the spot. A charter from Frederick II., in 1213, made it a free imperial city, and it gradually extended its possessions until it became an independent state; and between 1238 and 1339, successfully resisted the attacks of Rudolf of Hapsburg, Albert his son, and Louis of Bavaria. When the French entered B. in 1798, they found 30,000,000 of francs in the treasury. The corporate property of B. is very large—sufficient to defray all municipal expenses, provide the whole of the citizens with fuel gratis, and besides, to leave a surplus for annual distribution among them. B. is the residence of foreign ministers; and since 1849, the permanent seat of the Swiss government and diet. Haller, the distinguished physiologist, was born at Bern. Owing to a tradition which derives the name of the city from *bären* (the German for *bears*), bears have for several centuries been maintained in B. at the expense of the community. The French, when they captured B. in 1798, took possession of the bears, and sent them to the Jardin des Plantes, Paris; but the Bernese have since secured other specimens of their favourite animals, which are one of the 'sights' of the city.

BERNADOTTE. See CHARLES XIV.

BERNARD, SAINT, of Clairvaux, one of the most influential theologians of the middle ages, was born at Fontaine, near Dijon, in Burgundy, 1091; became a monk of Cîteaux in 1113; founded a new branch of that order at Clairvaux, in Champagne, and himself became its first abbot in 1115; died August 20, 1153; and was canonised by Alexander III., 1174. His ascetic life, solitary studies, and stirring eloquence, made him, during his lifetime, the oracle

of Christendom. He was honoured with the title of the 'mellifluous doctor,' and his writings were termed 'a river of paradise.' He rejected the doctrine of the immaculate conception, which had been introduced into the French Church, and rose above the cruel prejudices of his age in repressing the monkish persecutions of the Jews in Germany. B. is perhaps most widely known in connection with the disastrous crusade of 1146. Charged by the pope to excite the religious zeal of the people of France and Germany, he accomplished his mission with fatally memorable success. Fields, towns, cities, and castles were in many places almost depopulated, and innumerable legions, fired by his prophetic eloquence, hurried to the East, nine-tenths of whom never saw their homes again.

Regarding B. in his more spiritual aspect, we may say that his mystic, but at the same time practical, Christian doctrine was a wholesome antidote to the dry and cold scholasticism which prevailed among the churchmen of his age, although the intolerance with which he treated Abelard (see ABELARD) and Gilbert de Porrée must be reprobated. Luther says of St B.: 'If there ever lived on the earth a God-fearing and holy monk, it was St B. of Clairvaux.' In the course of his life, he founded 160 monasteries. His writings are exceedingly numerous. They consist of epistles, sermons, and theological treatises. Of the first, we possess 439; of the second, 340; and of the third, 12. They are all instinct with genius, though it is difficult for us now to appreciate their extraordinary influence. The best edition of the works of St B. is that of Mabillon, printed at Paris in 1690 (2 vols. fol.), reprinted at Venice in 1750 (6 vols. fol.), at Paris in 1835—1840 (4 vols. 8vo), and again in 1854 (4 vols. 8vo). The monks of the reformed branch of the Cistercians, which he instituted, are often called, after him, Bernardines. He gave name also, in France, to the nuns of the Cistercian order, of which his sister, St Humbeline, is said to have been the founder.

BE'RNARD, GREAT SAINT, *Mons Jovis*, a famous mountain-pass in the Pennine Alps, between Piedmont and the Valais. The pass attains an elevation of more than 8000 feet above the sea-level; and almost on its very crest, on the edge of a small lake, which is frozen over nine months out of the twelve, stands the *hospice*, founded, in 962, by Bernard de Menthon, a Savoyard nobleman, for the benefit of pilgrims to Rome, and now largely taken advantage of by travellers across the Alps. The hospice, said to be the highest habitation in Europe, is occupied by ten or twelve St Augustine monks, who, with their noble dogs of Saint Bernard breed, have rescued many hundred travellers from death by exposure to cold, or burial in the snow, which in winter ranges from 10 to 40 feet in depth. The humanity of the monks shortens their own lives very considerably, the rigorous cold—which has been known to be 29°, and is frequently as low as 18° and 20° below zero F.—and the difficulty of respiration, often compelling them to leave with ruined health before they have completed the period of their vow—fifteen years. They enter on their humane mission at the age of eighteen. The hospice is a substantial stone-building, capable of affording sleeping-accommodation to 70 or 80 travellers, and shelter to about 300. As many as 500 or 600 persons have taken advantage of the hospitality of the monks in one day, and it is calculated that 8000 or 9000 travellers are annually indebted to their kindness. The resources of the monks are mainly derived from voluntary subscriptions and gifts, but they draw some trifle from independent property. Formerly, they had much more

from this latter source, but a forced contribution of £4800 to the government of the canton of Valais impaired their revenues very much. The pass, which was traversed in early times by the Romans, Charlemagne, and Frederick Barbarossa, is celebrated for the passage of 30,000 French troops under Napoleon, in May 1800.—**LITTLE SAINT B.**, which forms part of the chain of the Graian Alps, is the most convenient of the Alpine passes, and is supposed to have been the one by which Hannibal led his forces into Italy. It also possesses a hospice, which is situated 7192 feet above the sea.

BERNARD DOG, GREAT SAINT, a race or variety of dog deriving its name from the hospice of St Bernard, where it has been long kept by the monks for the purpose of assisting them in the rescue of perishing travellers. Dogs of different races are employed in the same manner at other passes of the Alps. The Saint B. dog is remarkable for great size, strength, and sagacity. The dogs not only accompany the monks and servants of the hospice in the benevolent excursions which they regularly make through the most dangerous parts of the pass, but are sent by themselves to search for travellers who may have wandered, and this their extremely acute scent enables them admirably to do. They learn to know what places are most proper to be searched, and some of them shew great alertness when the weather assumes a threatening aspect, as if desirous to be at their work. They carry a small flask of wine or brandy attached to their neck, of which the traveller may avail himself. When they find a traveller benumbed with cold, or discover by the scent that one has been overwhelmed in an avalanche, they endeavour by loud barking to attract the monks to the spot: if they fail in this, and if the traveller is too much exhausted to proceed by their guidance to the hospice, or if they cannot by their own efforts dig away the snow which has covered him, they run to give the alarm by signs which are at once understood. One famous dog, called Barry, in the earlier part of the present century, was instrumental in saving the lives of no fewer than forty human beings. His most memorable achievement was the rescue of a little boy, whose mother had been destroyed by an avalanche, and whom he induced to mount his back, and so carried him safe to the hospice. The skin of this dog is preserved in the Museum of Bern.—The origin of this valuable race of dogs is not well ascertained, although they are supposed to have sprung from the progeny of a Danish dog left at the hospice by a traveller, and of the Alpine shepherds' dogs. Another account represents an English mastiff as one of their progenitors. There are two subvarieties, however; one with rough hair, like that of the Newfoundland dog, and of a white colour, with black or tawny spots; the other, with close, short hair, more or less clouded with gray, liver-colour, and black. Of the former breed, the number is now small. The head and ears resemble those of a water-spaniel, and the Saint B. dog has therefore been sometimes classed with spaniels (q. v.).

BERNARDIN, SAINT, of Sienna, born in 1380 at Massa-Carrara, of a distinguished family, made himself famous by his rigid restoration of their primitive rule amongst the degenerate order of the Franciscans, of which he became a member in 1404, after having already, in 1397, joined the brotherhood of the *Disciplinati Mariae*. In 1438, he was appointed vicar-general of his order for Italy. B. was unwearied and devoted in his activity during the great Italian plague of 1400, both as an impressive preacher and an attendant upon the sick and dying. He founded the *Fratres de Observantia*, a branch

of the Franciscan order, which already numbered more than 300 monasteries in Italy during his day. B. died in 1444, and was canonised by Pope Nicholas V. in 1450, his festival being on the 20th of May. His eminently mystical works were published by Rudolf (4 vols., Venice, 1591), and by De la Haye (5 vols., Paris, 1636).

BERNARDINES. See CISTERCIANS.

BERNAUER, AGNES, the beautiful daughter of a poor citizen of Augsburg, in the 15th c., whose sad story looks liker romance than history. Duke Albrecht of Bavaria, only son of the reigning Duke Ernst, saw the maiden at a tournament at Augsburg, given in his honour by the nobility, and fell violently in love with her. Albrecht was young, handsome, and manly, and Agnes was not insensible to his attractions and his rank; but she was too pure to listen to his overtures, till he promised to marry her. They were then secretly united, and Albrecht carried his young wife to the castle of Vohburg, which he inherited from his mother. Here they enjoyed their matrimonial happiness undisturbed, till Albrecht's father formed the plan of marrying his son with Anna, daughter of Erich, Duke of Brunswick. The determined opposition he met with, soon made him aware of his son's attachment to the Augsburg's daughter, and of the strength of his passion for her; and he resolved to take energetic measures to break it off. He accordingly contrived that, at a tournament at Regensburg, the lists were shut against his son, as one that, against the rules of chivalry, was living with a woman in licentiousness. Albrecht swore that Agnes was his wife, but in vain; he was still excluded. He now made Agnes be openly honoured as Duchess of Bavaria, gave her a numerous retinue of servants as a princess, and the castle of Straubing for a residence. She, full of sad forebodings of a dark fate, erected in the Carmelite convent of the place an oratory and a tomb. As long as Duke William, Albrecht's uncle, lived, who was greatly attached to his nephew, nothing further was attempted against the happiness of the lovers. But after his brother's death, Duke Ernst no longer restrained his anger, and in the absence of Albrecht, ordered Agnes to be arrested and executed without delay. Accused of sorcery, by which she was alleged to have bewitched Albrecht, she was carried, bound hand and foot, by the executioners to the bridge of the Danube, and in the presence of the whole people thrown into the river (October 12, 1435). The current having floated her again to the side, one of the executioners ran with a long pole, and fastening it in her golden hair, held her under the water till she was drowned. Maddened at this atrocity, Albrecht took up arms against his father, and, in league with his other enemies, wasted the country. It was in vain that Duke Ernst entreated his son to relent. It was not till the Emperor Sigismund, and the other friends of the family, united their exhortations, that Albrecht at last returned to his father's court, where, after a time, he consented to marry Anna of Brunswick. To regain the forfeited regard of his son, Duke Ernst had a chapel erected over the grave of the murdered lady, and Albrecht founded in the year of her death daily masses for her in the Carmelite monastery at Straubing; even after twelve years he renewed the foundation, and had the bones of his 'honoured wife' transferred to the tomb provided by herself, and covered with a marble monument. The unhappy loves of Albrecht and Agnes were long the theme of popular song; and the story has been made the subject of at least three tragedies, one by Jul. Körner (Leip. 1821), another by A. Böttger (3d ed. Leip. 1850).

BERNAY, a thriving town of France, in the department of Eure, 25 miles west-north-west of Evreux. It has manufactures of woollens, linens, cotton-yarn, paper, &c., and tanneries. One of the largest horse-fairs in France, attended by upwards of 40,000 jockeys and others interested in horses, is held here annually on the Wednesday of the fifth week in Lent. Pop. 5578.

BERNBURG, capital of the duchy of Anhalt-Bernburg, North Germany, is situated on the Saale, 23 miles south of Magdeburg, in lat. $51^{\circ} 47' N.$, long. $11^{\circ} 45' E.$ Two parts of B., surrounded by walls, lie on the left bank of the river, and are united by a bridge with the third part on the opposite side, which has a castle, but is not walled. B. is well built, has several literary and charitable institutions, and manufactures of porcelain, paper, and starch. Pop. about 7000.

BERNHARD, Duke of Weimar, a celebrated German general, was born 6th August 1604. He was the youngest of the eight sons of John, third Duke of Saxe-Weimar. On the outbreak of the Thirty Years' War, he took the side of Protestantism against the emperor, and first distinguished himself in 1622 at the bloody battle of Wimpfen. Subsequently, he became colonel in the army of Christian IV., king of Denmark; took part in the bold expedition of Mansfield through Silesia to Hungary; and, after the sudden death of the latter, reunited himself with the Danes under the markgraf of Baden-Durlach. At the solicitations of his brothers, however, he now withdrew from the Danish service, and returned to Weimar in March 1628. Three years later, Gustavus Adolphus made his appearance in Germany, and B. was one of the first who flew to his standard. After a brilliant career, he became suddenly ill, and died at Neuburg on the Rhine, 8th July 1639; according to some, of a pestilential disorder then prevalent in the camp; but according to B.'s own opinion, and that of others, of poison, administered by his physician, Blandini, who is supposed to have been in the pay of France.

BERNI, FRANCESCO, called also **BERNA** or **BERNIA**, a favourite Italian poet, from whom comic or jocose poetry has the name of *Versi Berneschi*, was born at Campovecchio, in Tuscany, about 1490. He first entered the service of Cardinal Dovizio da Bibbiena, and was afterwards for several years secretary to Ghiberti, chancellor to Clement VII., and Bishop of Verona. About 1533, he betook himself to Florence, where he was made a canon, and lived in favour with the two Medici, Duke Alessandro, and Cardinal Ippolito, till his death in 1536. His *Opere Burlesche* (2 vols., Flor. 1548; Lond. 1721) are to be found in the *Classici Italiani* (Mil. 1806). His recast or rifacimento of Bojardo's *Orlando Innamorato* was received with such favour that it was thrice reprinted from 1541—1545. A critical edition was published at Florence, 1827. Berni's version, or dilution, is still read in Italy, in preference to the original.—**COUNT FRANCESCO BERNI**, b. 1610, d. 1693, the author of eleven dramas, and some lyric pieces, is not to be confounded with the former Berni.

BERNIER, FRANÇOIS, a French physician and traveller, was born at Angers, in France. Having taken his degree of Doctor at Montpellier, he departed for the East about 1654, and visited Syria, Egypt, Arabia, and India, in the last of which countries he resided for twelve years in the capacity of physician to Aurungzebe. On his return to France, he published an account of his travels in India in 1670—1671. The work is delightful in style, accurate in the delineation of manners and customs, as well as in the descriptions of places,

and clear in the exposition of the causes of those political events that carried Aurungzebe to the throne. He visited England in 1685, and died at Paris on the 22d of September 1688.

The titles of his chief works are as follows: *Voyages de M. Bernier contenant la Description des Etats du Grand Mogol, de l'Indoustan, du Royaume de Cachemire, &c.; Mémoire sur le Quétisme des Indes; Abrégé de la Philosophie de Gassendi; Sentiment de M. Descartes.*

BERNINA, a mountain of the Rhaetian Alps, upwards of 13,000 feet high, in the Swiss canton of Grisons, with a remarkable and extensive glacier, Morteratsch. The B. Pass, which attains an elevation of 7695 feet, and over which a carriage-road has been constructed, unites the valleys of the Engadine and Bregaglia on the north with the Valteline on the south, but is dangerous on account of avalanches.

BERNINI, GIOVANNI LORENZO, a famous Italian sculptor and architect in the time of Pope Urban VIII., was born at Naples, 1598. He early devoted himself to sculpture, and in his eighteenth year finished his admired group of Apollo and Daphne, which gave promise of greater excellence than was afterwards realised by the artist. Pope Urban VIII. employed B. to produce designs for the embellishment of the Basilica of St Peter at Rome. The bronze *baldachino*, or canopy, covering the high-altar of that edifice, the palace Barberini, the front of the College de Propaganda Fide, the church of Sant' Andrea à Monte Cavallo, and numerous ornaments in St Peter's, are by Bernini. His greatest work in architecture is the colossal colonnade of St Peter's. In 1665, B. accepted the flattering invitation of Louis XIV., and travelled to Paris with a numerous retinue and great pomp. In Paris, he resided above eight months; but not wishing to interfere with the designs of Claude Perrault for the Louvre, he confined himself entirely to sculpture. His visit, however, proved a highly remunerative one. Richly laden with gifts, he returned to Rome, where he died, November 28, 1680, leaving a large fortune (about £100,000) to his children. Besides his works in sculpture, B. also left numerous paintings behind him. No artist, perhaps, was ever so much admired and rewarded during his lifetime as B.; but time has rather subtracted from than added to his fame.

BERNOUILLI was the name of a family that produced a succession of men, who became famous over all Europe for the successful cultivation and extension of various branches of mathematical and physical science. The family originally resided in Antwerp, whence, in 1583, its attachment to the reformed religion forced it to seek an asylum in Frankfort. Afterwards, the Bernouillis settled in Basel, where they achieved the highest professional honours. Eight of them became highly distinguished; but special mention can be made here only of the three most celebrated—James, John, and Daniel.

JAMES B. was born at Basel, 25th December 1654, where he also died, 16th August 1705. He devoted his life to the study of mathematics, of which he became professor, in the university of Basel, succeeding in that chair the distinguished Megerlin. Among his first works were, *A Method of Teaching Mathematics to the Blind*, and *Universal Tables on Dialling*. These were followed by *Conamen Novi Systematis Cometarum*, being an essay on comets, suggested by the appearance of the comet of 1680; and an essay *De Gravitate Aetheris*. Besides a variety of memoirs on scientific subjects, he published no other work of importance. *De Arte Conjectandi* was a posthumous work concerning the

extension of the doctrine of probabilities to moral, political, and economical subjects. His memoirs will be found in the *Journal des Savans* and *Acta Eruditorum*; his collected works were published in 2 vols. 4to, at Geneva, in 1744. Among his triumphs are to be recorded his solution of Leibnitz's problem of the isochronous curve, his determination of the catenary, and investigation of the properties of isoperimetrical figures. At his request, a logarithmic spiral was engraved on his tomb, with the motto, *Eadem mutata resurgo*.

JOHN B., brother of the preceding, was born at Basel, 27th July 1667. He and James were the first two foreigners honoured by being elected associates of the Academy of Sciences at Paris, and members of the Academy of Berlin. John devoted himself to chemical as well as to mathematical science. In 1694, he became a Doctor of Medicine, and soon after Professor of Mathematics at Gröningen, whence he only removed to succeed his brother James in the university of Basel. His forte was pure mathematics, in which he had no superior in Europe in his day. He died 1st January 1748. Among his achievements are the determination of the 'line of swiftest descent,' and the invention of the 'exponential calculus.' His collected works were published at Geneva, in 4 vols. 4to, 1742; and his correspondence with Leibnitz, in 2 vols., 1745.

DANIEL B., born at Gröningen, 9th February 1700, died at Basel, 17th March 1782, was the son of John. Like his father, he devoted himself to medicine as well as to mathematics. The family reputation early helped him to the professorship of mathematics at St Petersburg, which he held for several years. Thence, however, he ultimately retired to Basel, much against the will of the czar. At Basel, he occupied in succession the chairs of anatomy and botany, and of experimental and speculative philosophy. He published various works between 1730 and 1756, of which the chief are concerned with pneumatical and hydrodynamical subjects.

BERNSTEIN, GEORGE HEINR., a distinguished orientalist, Professor of Oriental Languages in the university of Breslau, was born, 12th January 1787, at Kospeda, near Jena, where his father was pastor. In 1806 he entered the university of Jena, where he devoted himself to the study of theology, philosophy, and Eastern languages. In 1812 he was appointed extraordinary professor of Oriental Literature in Berlin, and in 1821, regular professor. In 1843, he was appointed to Breslau. Besides a number of lesser treatises, and of contributions to scientific and critical journals, he established his reputation as an oriental scholar by the publication of an Arabic poem of Szafieddin of Hilla (Leip. 1816). But his greatest achievements are in Syriac literature. Besides several pamphlets, expository and critical, which appeared between 1837 and 1847, B. has given in his lexicon to Kirsch's *Chrestomathia Syriaca*, of which he brought out a new edition (2 vols., Leip. 1832—1836), proofs of his diligent and successful research in the domain of Syriac lexicography. He has still in contemplation a Syriac dictionary, which is to extend to several quarto volumes.

BERÔE, a genus of *Acalephæ* (q. v.), of a division distinguished as *Oligograde*, i. e., moving by means of cilia (q. v.), very different from the Medusæ, and of higher organisation. This genus is now the type of a family, characterised by a nearly globular or oval body, of a delicate jelly-like substance, with an alimentary canal passing through its axis, which is vertical as the animal floats in the water; the body strengthened by bands of somewhat firmer texture,

'which run like meridian lines from pole to pole.' These bands are covered with rows of large cilia, the motion of which is extremely rapid, and is evidently controlled by the will of the animal, so that it swims with rapidity, and easily changes its course. The motion of the cilia causes a beautiful iridescence: the animals also are phosphorescent by night. *B.* (or *Cydidippe*) *puleus* (figured in the article *ACALEPHÆ*) is a beautiful little creature, very abundant in the sea on many parts of the British coasts. It is provided with two very long and slender tentacula, which proceed from the sides of the body, and are covered with a great number of still finer filaments. These organs are probably employed for seizing food. This, and other kinds of *B.*, form a great part of the food of whales.

BERO'SUS, an educated priest of Babylon, who had a knowledge of the Greek language, and probably lived about 260 B. C. He wrote, in Greek, three books of Babylonian-Chaldean history, in which he made use of the oldest temple archives of Babylon. The work was highly esteemed by Greek and Roman historians, but unfortunately only a few fragments have been preserved by Josephus, Eusebius, Syncellus, and others. Even these fragments are of great value, as they relate to the most obscure portions of Asiatic history. They have been edited by Richter in his *Berosi Chaldeorum Historia quæ supersunt*, 1825. The *Antiquitatum Libri Quinque cum Commentariis Joannis Anni*, first published in Latin by Eucharis Silber (Rome, 1498) as a work of B., and often republished, was the pseudonymous work of the Dominican, Giovanni Nanni of Viterbo.

BERRE, ETANG DE, an extensive lagoon of France, department Bouches-du-Rhône, with large salt-works and eel-fisheries. It discharges its surplus waters into the sea by the Port-du-Bouc.

BERRY (*Bacca*), the term employed in botany to designate a description of fruit more or less fleshy and juicy, and not opening when ripe. The inner layers of the pericarp (q. v.) are of a fleshy or succulent texture, sometimes even consisting of mere cells filled with juice, whilst the outer layers are harder, and sometimes even woody. The seeds are immersed in the pulp. A B. may be one-celled, or it may be divided into a number of cells or compartments, which, however, are united together not merely in the axis, but from the axis to the rind. It is a very common description of fruit, and is found in many different natural families, and both of exogenous and endogenous plants. As examples, may be mentioned the fruits of the gooseberry, currant, vine, barberry, bilberry, belladonna, arum, bryony, and asparagus, which, although agreeing in their structure, possess widely different properties. Some of them, which are regarded as more strictly berries, have the calyx adherent to the ovary, and the placentas—from which the seeds derive their nourishment—parietal, that is, connected with the rind, as the gooseberry and currant; others, as the grape, have the ovary free, and the placentas in the centre of the fruit.—The orange and other fruits of the same family, having a thick rind dotted with numerous oil-glands, and quite distinct from the pulp of the fruit, receive the name *hesperidium*; the fruit of the pomegranate, which is very peculiar in the manner of its division into cells, is also sometimes distinguished from berries of the ordinary structure by the name *balansta*. See POMEGRANATE. Fruits, like that of the water-lily, which at first contain a juicy pulp, and afterwards, when ripe, are filled with a dry pith, are sometimes designated *Berry-capsules*. The gourds, also, which at first have 3—5 compartments, but when ripe, generally consist of only

one compartment, are distinctively designated by the term *pepo*, *pepontium*, or *peponida*, to which, however, *gourd* may be considered equivalent.

BERRY, or **BERRI**, one of the old French provinces (now forming the departments of Indre and Cher, q. v.), in lat. 46° 10'—47° 40' N., and long. 1°—3° E., its greatest length being about 100 miles, and its greatest breadth 90. Having come into the possession of the French crown, it gave title at various times to French princes, the younger son of Charles X. being the last who held it.

BERRY, **CHARLES FERDINAND**, **DUKE DE**, second son of the Count of Artois (afterwards Charles X.) and of Maria Theresa of Savoy, was born at Versailles, January 24, 1778. In 1792, he fled with his father to Turin; fought with him under Condé against France; afterwards visited Russia, and lived for some time in London and Edinburgh. In 1814 he returned to France, and the following year was appointed by Louis XVIII. commander of the troops in and around Paris. In 1816, he married Caroline Ferdinande Louise, eldest daughter of Francis, afterwards king of the Two Sicilies. On this marriage the continuance of the elder Bourbon line depended. The Duke de B. was assassinated on the 13th February 1820, as he was conducting his wife from the Opera-house to her carriage, by a person named Louvel. He left only one daughter, Louise-Marie-Thérèse d'Artois, Mademoiselle de France, born 1819; but on the 29th September 1820, the widowed duchess gave birth to the prince, Henry, Duke of Bordeaux, afterwards styled Count of Chambord. After the July revolution, 1830, in which the duchess exhibited immense force of character and courage, offering herself to lead on the troops against the insurgents, she, with her son, followed Charles X. to Holyrood, but left a considerable party in France in favour of the pretensions of her son as Henry V. of France. During a visit to Italy, the duchess was so far encouraged in her ambition, that a project was formed for reinstating the Bourbons in France; and, accompanied by several friends, she landed near Marseille, April 29, 1832. After many adventures, she was betrayed, and was imprisoned in the citadel of Blaye. The confession of the duchess, that she had formed a second marriage with the Neapolitan marquis, Lucchesi-Palli, destroyed at once her political importance, and the government restored her to liberty.

BERRYER, **PIERRE ANTOINE**, a distinguished French advocate and party politician, was born in Paris, 4th January 1790, and first distinguished himself by his defence of victims of the restoration. In 1829 he was chosen deputy, and has ever since steadily represented the rights and policy of the elder Bourbons. His legitimist tendencies kept him for a time in the political background under Louis Philippe; but as the legitimist party in the chamber increased, his position grew in importance. He repeatedly undertook the defence of persons prosecuted by the government, not only of his own party, but republican leaders. It was he who defended Louis Napoleon in the Chamber of Peers after the Boulogne *attentat*. With the elder Bourbons he was in constant communication, and was one of the heads of the legitimist party who made a pilgrimage to the Count of Chambord in London, in 1843. After the revolution of 1848, he represented the Bouches-du-Rhône; seemed inclined to support the government of the president, Louis Napoleon; and became a member of his privy-council. But this did not hinder him from going to Wiesbaden, in 1850, to do homage to the Count of Chambord. On that occasion, he was openly spoken of as the future minister of Henry V. When Changarnier

was removed from his command, B. united with Thiers and others to oppose the pretensions of the president, and he was one of the few who boldly protested against the *coup d'état*. In 1854, he was elected a member of the French Academy. His inaugural speech contained some uncomplimentary allusions to the Lower Empire, and its publication was prohibited, the prohibition, however, being removed in 24 hours. B. added greatly to his reputation as an orator by his defence of Montalembert (q. v.) against the government prosecution in November 1858.

BERSAGLIERI is the Italian name for the riflemen or sharpshooters of the Sardinian army. After the disastrous campaign of Charles Albert against the Austrians in 1848—1849, and the abdication of that monarch, his son, Victor Emmanuel, commenced a remodelling of the Sardinian army. One improvement, brought about by General Alessandro della Marmora, was the formation of a corps of bersaglieri. These are light active soldiers, dressed in a picturesque but serviceable dark-green uniform, and armed with long rifles. Two battalions of these riflemen formed part of the Sardinian army during the Crimean war. On the 16th of August 1855, they took part in the battle of the Tchernaya. During the Italian war of 1859, the B. were engaged in many operations requiring dash and brilliancy.

BERSEKER (*ber*, bare, and *serker*, shirt of mail), a redoubtable hero in Scandinavian mythology, the grandson of the eight-handed Starkader and the beautiful Alfhilde. He despised mail and helmet, and, contrary to the custom of those times, went always into battle unharnessed, his fury serving him instead of defensive armour. By the daughter of King Swafurlam, whom he had slain in battle, he had twelve sons, who inherited the name of B., along with his warlike fury.

BERTH, or **BIRTH**, in nautical language, is nearly equivalent to *room* or *space*. A ship's B. is the space which she occupies when at anchor, including a small breadth of sea all around her. The same name is also given to a messing or sleeping room on board ship, in a sense not very different from that of the word *cabin*. To 'B.' a ship's crew, is to allot to each man the place where his hammock, &c., are to be placed. In the third-class cabins of passenger-steamers, where many sleep in one room without partitions or divisions, each one's crib or bed-place is his berth.

BERTHA, the name of several famous women of the middle ages, half-historical, half-fabulous (see **BERGTA**). **ST BERTHA**, whose day is kept on the 4th July, was the beautiful and pious daughter of Charibert, king of the Franks, who having married (560 A. D.) Æthelbert, king of Kent, became the means of his conversion, and of the spread of Christianity among the Anglo-Saxons. In the romances of the Charlemagne cycle, there figures a **BERTHA**, called also Berthrada with the Big Foot, as the daughter of Count Charibert of Laon, wife of Pepin the Little, and mother of Charlemagne. In the romances of the *Round Table*, again, **BERTHA** is the name of a sister of Charlemagne, who makes Milo d'Anglesis the father of Roland. Better known is **BERTHA**, daughter of Burkhard, Duke of the Alemanni, and wife of Rudolf II., king of Burgundy beyond Jura, who, after Rudolf's death (937), acted as regent for her infant son, Konrad; afterwards married Hugo, king of Italy; and died towards the close of the 10th c. This queen had the character of an excellent housekeeper, and is represented on seals and other monuments of the time as sitting on her throne spinning.

BERTHIER, ALEXANDRE, Prince of Neuchatel and Wagram, and Marshal of the French Empire, was born at Versailles, November 20, 1753. His father, a military engineer, trained him for the army, which he entered in 1770, and fought with Lafayette in the American War of Independence. At the outbreak of the French Revolution, he was appointed major-general of the National Guard of Versailles, and rose to be a general of division, and chief of the staff in the Army of Italy, 1795; and in 1798, in the absence of Bonaparte, entered the papal territory, and proclaimed the republic in Rome. He accompanied Napoleon to Egypt in the same year as chief of the staff, a post which he also held in all the subsequent campaigns. At the revolution of 18th Brumaire (1799), he became war-minister, and (till 1808) as such signed many important treaties and truces. He always accompanied the emperor, and often rendered important services; for the part he took in the battle of Wagram, he received one of his many distinctions. B. was Napoleon's proxy in the marriage of Maria Louisa, at Vienna, 1810. In the campaigns of 1812, 1813, and 1814, he was constantly by the emperor's side, and acted both as chief of the staff and as quartermaster-general. It was only B.'s love of order, quick insight, and activity that could have superintended the movements of so many armies. Napoleon did him full justice on this score, asserting at the same time that he was incapable of leading the smallest *corps d'armée* alone.

On the fall of Napoleon, B. hardly shewed due gratitude for the favours heaped upon him. He had to surrender the principality of Neuchatel; and not to lose more, he submitted to Louis XVIII., who made him a peer and marshal, with the title of Captain of the Guards. Napoleon, who never doubted his secret attachment, made overtures to him from Elba: these he neither answered nor yet revealed to Louis, which made him suspected by both. On the return of Napoleon from Elba, in a fit of irresolution B. retired to Bamberg, in Bavaria, to his father-in-law, Duke William, where his mind became unhinged with the conflict. On 1st July 1815, while looking from the balcony of the palace at a division of Russian troops marching towards the French frontier, the bitter sight was too much—he threw himself down into the street, and thus ended his life. His *Mémoires* appeared in 1826.—He had two brothers, Victor Leopold, and Cæsar, who both served with distinction, and rose to be generals.

BERTHOLLET, COUNT CLAUDE LOUIS, one of the most distinguished theoretical chemists of his time, was born at Talloire, a village of Savoy, near Anney, on the 9th December 1748. He studied at the university of Turin, and obtained a medical degree there in 1768. He afterwards went to Paris, where he was appointed physician to the Duke of Orleans. He now applied himself with great assiduity to chemistry; in 1781, he was elected a member of the Academy of Sciences, and, some time after, the government made him superintendent of dyeing processes. In this situation he published a very valuable work on dyeing. In 1785, he announced his adherence to the antiphlogistic doctrines of Lavoisier, with the exception that he did not admit oxygen to be the acidifying principle, and herein he has proved to be right. In the same year, he published a paper on 'dephlogisticated marine acid'—now called chlorine—pointing out its use for bleaching purposes; and following up the experiments of Priestley, he shewed ammonia to be a compound of three volumes of hydrogen gas, and one volume of azotic gas. During the early part of the French Revolution, B. travelled through the country, giving instruction as to the best means

of extracting and purifying saltpetre to be used in the manufacture of gunpowder, and also as to the process of smelting and converting iron into steel. His joining the expedition of Napoleon to Egypt led to the formation of the Institute of Cairo. On his return from Egypt, he was made a senator by Bonaparte, who also conferred on him several marks of honour, and made him a count. Notwithstanding, he voted for the deposition of Napoleon in 1814. On the restoration of the Bourbons, he was made a peer; but all his honours never made him other than a simple and unassuming gentleman. Besides the additions to chemical knowledge already mentioned, he, in conjunction with Lavoisier, and two other chemists, promulgated a new chemical nomenclature which has proved valuable to science. He died at Paris, 7th November 1822.

BERTHOLLE'TIA. See BRAZIL NUTS.

BERTIN, LOUIS FRANÇOIS, called Bertin l'Ainé, an eminent French journalist, was born in Paris, 1766. He began writing for the press in 1793, and in 1799 set on foot the *Journal des Débats* (q. v.). B.'s royalist principles offended the government of Napoleon, and cost him imprisonment and banishment to Elba; whence, however, he escaped to Rome, where he formed a friendship with Châteaubriand. In 1804, he returned to Paris, and resumed the editorship of the *Débats*, but was much hampered by Napoleon, who imposed on the paper the title of *Journal de l'Empire*, and by subjecting it to police revision, gave it almost an official character. When B., in 1814, became free to follow his own bent, the journal reverted to its royalist principles. During the Hundred Days, it fell into other hands, till the return of the Bourbons restored it once more to B., who, in the meantime, had taken part in the *Moniteur de Gand*. Throughout the restoration, B. gave almost constant support to the ministerial party. Though he did not join in the protest of the liberal journals against the *ordonnances*, he gave his adhesion to the July monarchy, and continued faithfully to support it. He continued to edit the *Débats* till his death, 13th September 1841.

BERTIN, LOUIS MARIE ARMAND, son of the former, was born in Paris, 1801, and became, after the restoration, secretary to Châteaubriand during his embassy in England. In 1820, he joined the editorial staff of the *Journal des Débats*, and at his father's death assumed the chief direction. As a journalist, he contrived, as well as his father, to maintain a certain independence of the government. B. died at Paris, January 11, 1854.

BERTRAND, HENRY GRATIEN, COUNT, one of Napoleon's generals, known for his faithful attachment to the emperor through all his fortunes, was born at Châteauroux, 1773, and early entered the armies of the Revolution as engineer. He accompanied the expedition to Egypt, and directed the fortification of Alexandria. Returning with the rank of general of brigade, he distinguished himself at Austerlitz, and became the emperor's adjutant; and, after the battle of Aspern in 1809, for establishing bridges over the Danube, he was created Count and governor of Illyria. After sharing with credit in the subsequent campaigns, he retired with the emperor to Elba, was his confidant in carrying out his return to France, and finally shared his banishment to St Helena. On Napoleon's death, B. returned to France, where, though sentence of death had been pronounced upon him—a sentence which Louis XVIII. had wisely recalled—he was restored to all his dignities, and, in 1830, appointed commandant of the Polytechnic School. He formed

part of the expedition which, in 1840, brought back the remains of Napoleon to France. His death took place at Châteauroux, 31st January 1844.

BERVIC, CHARLES CLEMENT BALVAY, a celebrated French engraver, was born at Paris in May 1756. In 1790, he made himself famous by a full-length engraving of Louis XVI., from the picture by Callet, one of the finest works of the kind ever produced. The engravings of the Laocoon, Regnault's 'Education of Achilles,' and Guido's 'Rape of Deianira,' also from B.'s graver, display equal beauty of manipulation, and fully higher power. B. died March 23, 1822.

BERWICK, JAMES FITZ-JAMES, DUKE OF, was the natural son of James II., by Arabella Churchill, sister of the Duke of Marlborough. He was born in 1670, in France, where he was educated, and entered the army. After serving in Hungary under Charles of Lorraine, he returned to England shortly before the revolution of 1688, which he exerted himself to prevent. In 1689, he accompanied his father in his Irish expedition, and after the death of St Ruth, had the nominal chief command. He next served in Flanders, under Marshal Luxembourg, and afterwards under the Duke of Burgundy and Marshal Villeroi. In 1706, he was created a marshal of France, and sent at the head of an army to Spain, where he established the throne of Philip V. by the decisive victory of Almanza. For this important service, he was made a grandee of Spain, under the title of Duke of Liria and Xerica. After several years of inactivity, he received the command, in 1734, of an army intended to cross the Rhine. While besieging Philipshurg, he was killed by a cannon-ball. Contemporary testimony, confirmed by his military conduct, shews B. to have possessed some of the best qualities of a great commander. His defensive campaign in 1709, in Provence and Dauphiné, against the superior force of the Duke of Savoy, has always been regarded as a triumph of strategic skill. He was twice married. His son by the first marriage succeeded to the dukedom of Liria; his dukedom (De Fitz-james) and estates in France passed to his children by the second marriage.

BERWICK, NORTH, a seaport town in Haddingtonshire, at the entrance to the Firth of Forth, 19 miles east-north-east of Edinburgh. Corn is exported from it, and it is frequented as a bathing-place. It unites with Lauder, Dunbar, Jedburgh, and Haddington, in returning one member to parliament. Pop. of borough, 863; of parish, 1643. The parish includes the Bass Rock, North Berwick Law, and the ruins of Tantallon Castle. The castle is graphically described in Scott's *Marmion*. It is an irregular pile, two miles east of the town, on a high rock, surrounded by the sea on three sides, with a ditch on the land-side, where there was formerly a drawbridge. It was a stronghold of the Douglas family. N. Berwick Law is a conical hill of an elevation of 940 feet, on the south, close to the town.

BERWICKSHIRE, a maritime and border county in the south-east extremity of Scotland, bounded N. by Haddington; W. by Mid-Lothian and Roxburgh; S. and S.E. by Roxburgh and the Tweed, which latter separates it from Northumberland and Durham; E. by the municipality of Berwick-upon-Tweed and the German Ocean. It has an area of about 450 square miles, of which about one half are under cultivation. B. is hilly in the north and west, and slopes to the south and east. It is naturally divided into three districts—Lammermoor, Lauderdale, and the Merse. The first, on the north, consists chiefly of high bleak moorlands. The Lammermoor Hills, consisting

of Silurian slates, run along the north side of the county, and terminate on the east coast in St Abb's Head, 300 feet high. The chief summits—Lammer Law, Crib Law, Sayer's Law, and Clint Hill—are 1500 to 1600 feet high. The second district, which is on the west, is formed by the river Leader or Lauder, and contains much fertile land, with a larger amount of moor and hill. The last, between the Lammermoors and the Tweed, 10 miles long and 8 broad, is a comparatively undulating level, and forms one of the most highly cultivated districts in Britain. Hume Castle, on a rock, 398 feet above the sea-level, 3 miles south of Greenlaw, is a conspicuous and picturesque object over the interior of Berwickshire. Except the Eye, in the north-east, all the considerable streams are tributary to the Tweed; the chief are the Leader, Blackadder, and Whitadder, all excellent fishing-streams. The coast is rocky and bold, with no bays, except at Eyemouth and Coldingham. B., geologically, consists of carboniferous limestone in the south, old red sandstone in the middle, and Silurian strata in the north. Porphyry occurs on the coast, and some trap and syenite in the interior. Ironstone and thin seams of coal occur, as well as gypsum, clay, and shell-marl. The prevailing soil in the valleys is loamy; that in the Merse is a deep and fertile clay, which has been greatly improved by thorough drainage during the last fifty years. In no part of the world is the science of agriculture better understood and exemplified than in Berwickshire. The farms are generally large, and held on nineteen years' leases by men of spirit and intelligence. In 1855, there were 766 tenants who paid £10 rent and upwards. B., though the 20th in size of the Scottish counties, stands about 5th in the amount of wheat and turnips raised. The manufactures are inconsiderable. The Tweed salmon-fisheries are the most valuable in the kingdom, but have declined much of late years. B. returns one member to parliament. In 1851, pop. 36,297; inhabited houses, 6363; day-schools, 91, with 5838 scholars; places of worship, 65 (29 of Established, 16 of United Presbyterian, and 15 of Free Church). The chief towns are Dunse, the largest; Lauder, the only royal borough; Greenlaw, the county town; Coldstream, where General Monk first raised the Coldstream Guards; Eyemouth, the only seaport; Ayton; and Earlstoun, the Erildoune of Thomas the Rhymer. Dunse is the birthplace of Boston, of Dr M'Crie, and less certainly of John Duns Scotus. Berwick-on-Tweed is the chief place of export for the county. The chief antiquities of B. are the ruins of Dryburgh Abbey, of Coldingham Priory, and of Fast Castle. There are many remains of British and Roman camps and barrows.

BERWICK-ON-TWEED, a seaport town on the north bank of the Tweed, near its mouth, 58 miles east-south-east from Edinburgh. It is the frontier town of England and Scotland, and with its liberties, comprising an area of about 8 square miles, used to form a county by itself, separate from England and Scotland; and in acts of parliament applicable to England and Wales, 'the good town of Berwick-upon-Tweed' was always expressly added. But this practice has been abolished, and B., with its liberties, is now considered as forming part of the county of Northumberland. The town is, in general, well built, but has on the whole a decayed appearance. The Tweed is here spanned by an old stone-bridge of 15 arches, and 924 feet long, and by the magnificent viaduct which connects the York and Berwick Railway with the North British Railway to Edinburgh. The old fortifications still girdle the town. The trade and shipping are considerable, the chief exports being salmon, corn,

wool, coal, &c. The Tweed salmon-fishery is less productive than formerly. Coal-mines exist near the town. At Tweedmouth, there are several large iron-foundries for the manufacture of steam-engines and mill-machinery. There are also manufactures of sail-cloth, cordage, and linens. B. has a free grammar-school, and several other free schools. The Berwickshire Naturalists' Club, a very useful society, meets here. Pop. of town and parish (1851), 10,067; of parliamentary borough, including Tweedmouth and Spittal (a fishing-village and watering-place), 15,094. B. returns two members to parliament, and from the corrupt practices which have long prevailed at elections, the town has acquired an unenviable notoriety. In 1857, B. had 40 ships belonging to the port, 2806 tons. In 1858, 675 vessels of 42,710 tons entered and cleared the port. The past history of B. is full of interest, especially in regard to the Border wars. Its authentic records begin with the reign of Alexander I., in the 12th c., when it belonged to the Scottish realm, and was one of the principal seaports in the kingdom. It is described by a writer of the year 1296 as being 'for commerce and population another Alexandria.' From that period it was frequently taken and retaken by the English and the Scotch, its frontier position making it an important possession to either power. In 1482 it came finally into the possession of England, and is now essentially English in its usages, both civil and ecclesiastical.

BERYL, a mineral which scarcely differs except in colour from Emerald (q. v.), never exhibiting the bright rich green which characterises that gem, but colourless, yellowish, greenish-yellow, or blue. The finer varieties, which are transparent and of beautiful colour, are distinguished as *Precious B.*, and are sometimes called *Aquamarine*. These occur in crystals similar in form to those of emerald; but the regular hexagonal prism is more frequently modified by truncation on the angles or edges, acumination, &c. The prisms are often long. Their sides are longitudinally striated, often deeply so; but the

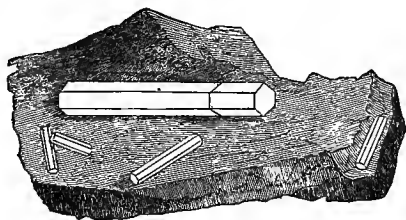

Beryl, in its primary form.

truncating or terminating planes are smooth. The coarser varieties of B. (*Common B.*) are also found crystallised, but often massive. B. occurs chiefly in veins that traverse granite or gneiss, or imbedded in granite; sometimes it is found in alluvial soils formed from such rocks. Common B. is found in a number of places in Europe; Rubislaw, near Aberdeen, is a British locality. The mountains of Aberdeenshire, and those of Mourne in Ireland, yield Precious B., which is also found in several parts of the continent of Europe and of New England, but principally in Brazil and Siberia. It is much valued as a precious stone, although not so much as the emerald.

BERZELIUS, JOHANN JACOB, BARON, one of the greatest of recent chemists, was born at Westerlösa, in East Gothland, Sweden, 20th August 1779. While studying for the medical profession at the university of Upsala, he was more attracted by the

preparatory natural sciences, especially chemistry. After being some time employed in medical practice and lecturing, he was appointed (1806) lecturer on chemistry in the Military Academy of Stockholm, and, in the following year, professor of medicine and pharmacy. He was shortly after chosen president of the Stockholm Academy of Sciences; and from 1818 till his death, 7th August 1848, held the office of perpetual secretary. The king raised him to the rank of baron; other honours from learned societies were conferred on him; and the directors of the Swedish Ironworks, in consideration of the value of his researches in their particular branch of industry, bestowed on him a pension for life. In 1838, he was made a senator; but he took little part in politics. The field of his activity lay in his laboratory, where he acquired a name of which his country is justly proud. His services to chemistry are too vast to be described here. The science of chemistry, as at present organised, rests in a great measure upon the discoveries and views of B., although in not a few points he has been controverted, or found wrong. His multiplied and accurate analyses established the laws of combination on an incontrovertible basis; and to him we owe the system of chemical symbols. He discovered the elements selenium and thorium, and first exhibited calcium, barium, strontium, columbium or tantalum, silicium, and zirconium, in the metallic form. The blowpipe in the hands of B. became a powerful instrument in the analysis of inorganic substances. The multitude and accuracy of his researches in every branch of chemical inquiry make it difficult to conceive how one man could have accomplished so much. Of his numerous writings, the most important is his *Lärobok i Kemien* (Text-book of Chemistry, 3 vols., Stock. 1808—1818), which has since passed through five large editions, on each occasion being almost wholly rewritten. The best known edition is that published in 8 vols. at Brussels in 1835. The book has been translated into every European language. His essay *On the Use of the Blowpipe* exhausts the subject, while his *Annual Reports on the Progress of Physics, Chemistry, and Mineralogy*, undertaken at the request of the Academy of Sciences in 1822, have proved very valuable to science. Scarcely less so have been the *Memoirs Relative to Physics, Chemistry, and Mineralogy*, of which he was one of the originators and conductors, and to which, during the twelve years they were published, from 1806 to 1818, he contributed forty-seven original papers.

BESANCON (*Vesontio*), capital of the French department of Doubs, and formerly capital of Franche-Comté, is situated on the river Doubs, which divides it into two parts, about 45 miles east of Dijon. Lat. 47° 14' N., long. 6° 3' E. It was strongly but irregularly fortified by Vauban, the citadel being considered impregnable. Since that time, the fortifications have been extended and strengthened, and B. is now considered one of the strongest military positions in Europe. It was the ancient Vesontio, Besontium or Visontium, and was a considerable place even in the time of Caesar, who, in 58 B.C., expelled from Vesontio the Sequani, and, in the neighbourhood of the city, gained a victory over Ariovistus. It then became an important Roman military station. In modern times, after undergoing many changes, it finally came into the possession of France in 1674. Several streets and places in B. still bear old Roman names; and in the neighbourhood are found ruins of a triumphal arch of Aurelianus, an aqueduct, an amphitheatre, and a theatre which must have been large enough to contain 20,000 spectators. Among the modern structures, the Cathedral and the churches of St

John and the Magdalen, with the Prefecture, and the half-Gothic, half-Roman palace of Cardinal Granvella, are most remarkable. B. has considerable manufactures, chiefly watches (of which more than 60,000 are made annually), porcelain, carpets, iron-wire, and beer, and is an important entrepôt for the produce of part of Switzerland and the south of France. 600,000 bottles of Seltzer-water are annually manufactured. Pop. 30,000.

BESANTS, or **BEZANTS**, circular pieces of bullion, generally gold, without any impression, supposed to represent the old coinage of Byzantium, brought home by the Crusaders, and hence of frequent occurrence as heraldic charges. B. are generally introduced into the arms of banks, and also into those of individuals who have been specially connected with money. Similar figures, when not coloured *or* (gold), or *argent* (silver), are known in heraldry by the general term of *roundels*. A *bezanty cross*, is a cross composed of B.; and *bezanty*, or *bezantée*, is the term used when the shield, or any particular charge, is strewn with besants.

BESIEGING. See **SIEGE**.

BESSARABIA, a province in the south-west of Russia, in lat. 44° 45'—48° 40' N., and long. 26° 35'—30° 30' E. Area, 17,000 square miles (about 1000 square miles were ceded to Turkey in 1856), with a population, in 1856, of 990,274, composed of Russians, Poles, Wallachians, Moldavians, Bulgarians, Greeks, Armenians, Jews, Germans, and Tatars, with a sprinkling of Gipsies. The Dniester flows along the whole of its northern and eastern boundaries; the Pruth separates it from Moldavia on the west; and it has the Danube on the south. B. is also intersected by several considerable streams; which are, however, much reduced by the summer heats. The climate is, on the whole, mild and salubrious. In the north-west, the country is traversed by offshoots from the Transylvanian branch of the Carpathian Mountains, and mostly covered with wood. Generally, however, B. is flat and fertile; but for want of proper cultivation, the land does not yield the rich returns it is capable of doing. Wheat, barley, and millet are raised to some extent, as well as hemp, flax, and tobacco, fruit and wine; but the breeding of cattle forms the chief business of the inhabitants; consequently, the greater part of the land is in pasturage. The lakes in the district of B., called the Budjak, yield immense quantities of salt; which, together with cattle, wool, tallow, and cheese, form the principal articles of export. The manufacturing industry of B. is confined almost entirely to leather, soap, and candles. B., which formerly belonged to Turkey, was ceded to Russia in 1812 by the treaty of Bucharest.

BESSARION, **JOHANNES**, or **BASILIUS**, born at Trebizond, on the Black Sea, 1395, is remembered as one of the earliest of those scholars who, in the 15th c., transplanted Greek literature and philosophy into the west, and rescued the mind of Christendom from the trammels of scholasticism. B. imbibed his love of Plato's writings from his tutor, Gemistus Pletho. As Bishop of Nicæa, B. accompanied the Greek emperor, John Palæologus, to Italy; and effected, at the council of Florence in 1439, a union between the Greek and the Romish Churches, which, however, was of short duration. Soon afterwards, he joined the Romish Church, but always retained a glowing love of his native land. He was made cardinal by Pope Eugene IV. in 1439. Ten years after, Nicholas V. created him Cardinal-bishop of Sabina, and in the same year Bishop of Frascati. For five years, also, he discharged the duties of papal legate at Bologna. After the fall of

Constantinople, B. visited Germany; and at the diets of Nuremberg, Worms, and Vienna, endeavoured to promote a crusade against the Turks. In philosophy, he professed to be a follower of Plato, but without depreciation of Aristotle. His writings, consisting of Latin translations of Greek authors, defensive treatises on the Platonic philosophy, with discourses and letters, have never been published collectively. Twice he was nearly elected pope; but his partiality for the heathen philosophy was probably regarded as some disqualification by the sacred college. B. died at Ravenna, November 19, 1472, leaving his collection of 600 valuable Greek MSS. to the St Mark's Library, Venice.

BESSEL, **FRIEDRICH WILHELM**, one of the most distinguished of modern astronomers, was born at Minden, July 22, 1784. In 1806 he was, on the recommendation of Olbers, whom he had greatly assisted by his remarkable expertness in calculation, appointed assistant to Schröter at Lilienthal. In 1810, he published his researches on the orbit of the great comet of 1807, which gained for him the Lalande prize of the Paris Academy of Sciences. In the same year he was appointed director of the new observatory to be erected by the king of Prussia at Königsberg; and repairing thither immediately, superintended the erection and the mounting of the instruments. The establishment was completed in three years. In 1818, B. published his *Fundamenta Astronomiæ*—giving the results of Bradley's Greenwich observations—a work upon which he had been engaged for eleven years. This work is one of the highest value to astronomers. It is described by a competent authority as having laid the foundations of the principal improvements which have been made in astronomy since the date of its publication. In 1830 appeared his *Tabula Regiomontanae*, forming a kind of supplement to the above work. Besides numerous papers of an important character (nearly 200 in all) scattered through various scientific journals, he also published an inquiry on the *seconds' pendulum* for Berlin (1828, and again in 1837), *Astronomical Researches* (2 vols., Königsb. 1841—1842). His paper on the precession of the equinoxes gained him the prize of the Berlin Academy. After a series of three years' observations, he succeeded in determining the annual parallax of the fixed star 61 Cygni (see **FIXED STARS**), an achievement honourable not only as the first of its kind, but for the marvellous skill and patience necessary for its accomplishment. In the years 1824—1833, B. made a series of 75,011 observations in 536 sittings, and completed a catalogue of stars (extending to the ninth magnitude) within the zone from 15° N. to 15° S. declination. These were afterwards reduced by Weisse. In one of his lectures, delivered at Königsberg in 1840, B. indicated the existence of the new planet afterwards discovered by Le Verrier, and named Neptune; and but for the death of a favourite son, he in all probability would have undertaken the investigation of the problem. B.'s *Popular Lectures on Astronomy*, given at Königsberg, 1832—1844, were edited by his friend Schumacher, and published at Hamburg in 1848, two years after his death, which took place March 7, 1846. All scientific associations, both on the continent and in England, were eager to confer honour on themselves by enrolling B. as one of their members. He was a thoroughly practical man of science, never allowing himself to be carried away by any theory, however inviting, and particularly remarkable for the precision of his calculations, being satisfied with nothing less than perfect exactness.

BESSEMER'S PROCESS FOR REFINING IRON. In the years 1856 and 1857, the iron world was startled by the announcement of a new and rapid process of purifying *cast* or *pig iron*, and obtaining therefrom *bar* or *malleable iron*, and *steel*. The patentee, Mr Bessemer, takes the liquid iron

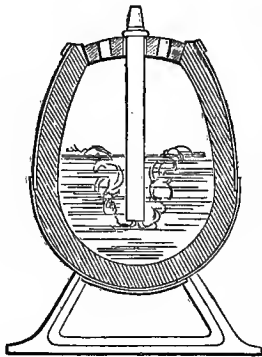

as it flows from the blast-furnace, receives it in a large covered ladle (see fig.) made of malleable iron, lined with loam or clay, and inserts in the molten mass a fire-clay pipe, through which air is driven with great force. The hot blast is preferred to the cold blast, but the latter will do. The oxygen of the air, as it gurgles through the molten iron, combines with the carbon and other impurities, and carries these rapidly away. The ladle being

tilted round, the half-purified iron is then allowed to flow into a shallow iron trough, where it cools and becomes *fine metal*. This part of the operation is the equivalent of the ordinary *finery furnace*. The plate of fine metal is now broken in pieces, and introduced into a *reverberatory* or *puddling furnace*, somewhat similar in shape to that ordinarily employed, but pierced with a number of openings at each side, through which fire-clay nozzles are inserted, and air—hot or cold—driven into or upon the iron, when it becomes molten. Steam is likewise introduced, especially at the commencement of the process. The air being thus brought intimately in contact with the half-purified iron, the remaining impurities are rapidly carried away. Where great purity is required, Bessemer recommends that the spent gases from the fire-grate of the puddling-furnace, which often contain sulphurous acid, should not be allowed to come in contact with the iron; and to obviate this contamination, the iron is enclosed in retorts similar to those used at a gaswork, and the air forced through the molten metal within the retorts.

Bessemer also suggested that the process of refining pig or crude iron should be accomplished by a single operation. For this purpose, an air-furnace is employed, in which there is placed a fire-clay or black-lead crucible, capable of holding, when three-fourths full, about seven cwt. of molten iron. Prior to the introduction of the metal, the crucible is surrounded by fuel; and when the vessel has attained a bright-red heat, the iron is run in by a funnel inserted at the upper part of the crucible, and thereafter the tube conveying the blast is thrust in. The air, or air and steam, act on the impure iron. The free oxygen carries off the carbon as carbonic acid, and the water acting upon the iron is decomposed; its hydrogen is set free, and the oxygen combining with the iron forms oxide of iron; which oxide is again decomposed by the carbon uniting with the oxygen to form carbonic oxide, and liberating the iron in the metallic condition. Besides the changes enumerated, a large amount of iron is converted into oxide of iron by the excess of oxygen thrust in. The sulphur present as impurity is burned away in part as sulphurous acid, by uniting with the oxygen of the air, and is partly acted on by the hydrogen derived from the steam, and carried off as sulphuretted hydrogen. The phos-

phorus is oxidised into phosphoric acid, and in greater part is left still in the iron. After the blast has been on for fifteen or twenty minutes, the jets of flame which issue from the molten mass elongate very much, and continue so for five or six minutes, when they subside by degrees, till they almost cease; and in thirty-five minutes from the commencement, the process is complete. During the progress of the operation, a copious discharge of slag takes place, which mostly remains as a scum on the surface of the pure iron. The tap-hole in the crucible being unstopped by driving an iron rod into the clay-stopper, the liquid iron is run into a mould or foundry's ladle. For castings which require much carbon in the iron, Bessemer first refines the iron by the above operation, and then thrusts into the molten mass some wood, bituminous shale, carbonaceous matters in general, or a stream of carburetted hydrogen, till the requisite amount of carbon is obtained. Bessemer likewise lays claim to the introduction of dry carbonate of soda and dry carbonate of potash into the molten iron by means of the air-blast, whereby the silica is more easily removed, and a slag formed.

Theoretically, the process of Bessemer is a correct one. By the older and ordinary methods the impurities were only slowly carried off, because air was only sparingly admitted to the iron; but without altering the agent which accomplishes the purification, Bessemer expedites the process by thrusting air in great abundance through the impure iron. Practically, however, it does not as yet seem possible by Bessemer's process to burn away the impurities, without at the same time oxidising or wasting much good iron. It is highly probable that the practical skill of our ironmasters will be found sufficient to surmount this difficulty, and that means will be discovered of admitting air in such minimum quantity, and so regulated, that, while it burns away the impurities, it will not be allowed to proceed so far as to burn the iron itself. The present system of *refining* and *puddling* iron is notoriously a primitive, time-devouring, and stationary one; and any inquiry having in view the shortening of the number of hours required, must be of advantage at all times. The process of Bessemer is far from being a perfect one, but it is a step in the right direction, which will doubtless be carried further; and Bessemer ought to receive the thanks of the *iron world* for having given impetus to thought on the subject.

BESSIÈRES, JEAN BAPTISTE, Duke of Istria, and Marshal of the French Empire, was born at Preissac, in the department of Lot, August 1768. After serving for a short time in the constitutional guard of Louis XVI., in November 1792, he entered the army of the Pyrenees as a private soldier. In less than two years, he had attained the rank of captain, and passing into the Army of Italy, he distinguished himself greatly in the battles of Roveredo and Rivoli. Having been made chief of a brigade in 1798, he in that year accompanied Bonaparte to Egypt, and made himself conspicuous at the siege of St Jean d'Acre, and at the battle of Aboukir. Afterwards, he took a prominent part in the battles of Marengo, Olmütz, Austerlitz, Jena, Friedland, and Eylau; and within five years (from 1800 to 1805), he was made successively general of brigade, general of division, and marshal of France. For his gallant behaviour in Spain, he was, in 1809, created Duke of Istria. In the Russian campaign, he commanded the cavalry of the Guard, and during the disastrous retreat from Moscow, the services he rendered were of the utmost importance. In 1813, he received the command of the whole of the French cavalry. On the morning of the battle of Lützen,

while leading on foot the *tirailleurs* to reconnoitre the field from the defile of Rippach, he fell mortally wounded by a bullet. The news of his death was kept concealed from the army throughout the day. Bonaparte lost in B. one of his ablest officers and his most faithful friend.

BESTIAIRES (Fr.), the name given to a class of written books of great popularity in the middle ages, describing all the animals of creation, real or fabled, and generally illustrated by drawings. They were most in fashion during the 11th, 12th, and 13th c. They served as encyclopædias of the zoology of those ages, but they had also another use. The symbolism which was then so much in vogue fastened spiritual meanings upon the several animals, until every quality of good or evil in the soul of man had its type in the brute world. It is in this way to the B. that we must look for explanation of the strange, grotesque creatures which are found sculptured on the churches and other buildings of the middle ages. There were B. both in prose and in verse, in Latin and in the vernacular. A few sentences from *Le Bestiaire Divin de Guillaume, Clerc de Normandie, Trouvère du XIII^e Siècle* (Caen 1852), may help to give some notion of the class of works of which it is a fair example. 'The unicorn,' he writes, 'has but one horn in the middle of its forehead. It is the only animal that ventures to attack the elephant; and so sharp is the nail of its foot, that with one blow it rips up the belly of that most terrible of all beasts. The hunters can catch the unicorn only by placing a young virgin in the forest which it haunts. No sooner does this marvellous animal descrie the damsel, than it runs towards her, lies down at her feet, and so suffers itself to be taken by the hunters. The unicorn represents our Lord Jesus Christ, who, taking our humanity upon him in the Virgin's womb, was betrayed by the wicked Jews, and delivered into the hands of Pilate. Its one horn signifies the gospel truth, that Christ is one with the Father,' &c.

BESTUSCHEW, ALEXANDER, a Russian novelist, born about 1795, was captain in a dragoon regiment, and adjutant to Alexander, Duke of Würtemberg. Having been involved with his friend Rylejew in the conspiracy of 1825, he was degraded to the ranks, and exiled to Yakutzk, but after long entreaty, permitted to enter the army of the Caucasus as a private in 1830. In June 1837, he fell in a skirmish with the as yet unconquered mountaineers. Two years before his exile he, together with his friend Rylejew, who was executed in 1825, had published the first Russian almanac, *The Pole Star*. His later works, consisting chiefly of novels and sketches, written under the name of Cossack Marlinski, bore the impress of his own life and adventures in the Caucasus. They excel in depicting the wilder aspects of nature and the excitements of a soldier's life, but fail in the delineation of character, and are often exaggerated, and sometimes absurd. His principal works are the tale of *Mullah Nur*, and the romance of *Ammalath Beg*, which last relates the treachery of a Circassian chief, and gives interesting pictures of the scenery of the Caucasus. Several of his novels were translated into German by Seebach (Leipsic, 1837), and his collective works appeared at St Petersburg in 1840, under the name of Marlinski's Tales. His three brothers were implicated in the military conspiracy of 1825, and hanged by the special order of the emperor.

BETA'NZOS (anciently *Brigantium Flavium*), a town of Spain, province of Corunna, 10 miles south-east of the city of the same name. Ancient granite gateways still defend its narrow streets. It has

manufactures of linen, leather, and earthenware. Pop. between 4000 and 5000.

BE'TEL, BE'TLE, or PAWN, a narcotic stimulant, much used in the east, and particularly by all the tribes of the Malay race. It consists of a leaf of one or other of certain species of pepper, to which the name of betel-pepper is indiscriminately applied, plucked green, spread over with moistened quick-lime (*chunam*) generally procured by calcination of shells, and wrapped around a few scrapings of the areca-nut (see *ARECA*), sometimes called the betel-nut, and also known as *Pimang*. This is put into the mouth and chewed. It causes giddiness in persons unaccustomed to it, excoriates the mouth, and deadens for a time the sense of taste. It is so burning, that Europeans do not readily become habituated to it, but the consumption in the East Indies is prodigious. Men and women, young and old, indulge in it from morning to night. The use of it is so general as to have become matter of etiquette; a Malay scarcely goes out without his betel-box, which one presents to another as Europeans do their snuff-boxes. The chewing of B. is a practice of great antiquity, and can certainly be traced back to at least the 5th c. B. C. It gives a red colour to the saliva, so that the lips and teeth appear covered with blood; the lips and teeth are also blackened by its habitual use, and the teeth are destroyed, so that men of twenty-five years of age are often quite toothless. Whether the use of B. is to be regarded as having any advantages except the mere pleasure afforded to those who have acquired the habit of it, to counterbalance its obvious disadvantages, is a question upon which difference of opinion subsists. Some have represented it as beneficially promoting the secretion of saliva, strengthening the digestive powers, and warding off the attacks of fever; whilst others pronounce against it an unqualified condemnation. Sir James Emerson Tennent, in his valuable work on Ceylon, recently published, expresses the opinion that it is advantageous to a people of whose ordinary food flesh forms no part, and that it is at once the antacid, the tonic, and the carminative which they require.

The name B. is often given to the species of pepper of which the leaves are ordinarily chewed in the manner just described, which are also called B-PEPPER or PAWN. Some of them are very extensively cultivated, particularly *Chavica Betle*, *C. Siraboa*, and *C. Malamiri*, climbing shrubs with leathery leaves, which are heart-shaped in the first and second of these species, and oblong in the third. They are trained to poles, trellises, or the stems of palms, and require much heat with moisture and shade; upon which account, in the north of India, where the climate would not otherwise be suitable, they are cultivated with great attention in low sheds, poles being placed for their support at a few feet apart. Hooker mentions in his Himalayan Journal, that these sheds are much infested by dangerous snakes, and that lives are therefore not unfrequently lost in the cultivation of betel.—The genus *Chavica* is one of those into which the old genus *Piper* (see PEPPER) has recently been divided. The requisite qualities of B. are probably found in the leaves of numerous species not only of this but of other genera of the same family. The leaf of the Ava (q. v.) is sometimes used.

BE'THANY, meaning a 'boat-house;' called 'Lazariyeh,' or 'Town of Lazarus,' by the natives of Palestine, in reference to the event narrated in Scripture. It is a retired spot, beautifully situated on the southern slope of the Mount of Olives, 3 miles from Jerusalem, with a population of about 500,

principally Latins. There is nothing remarkable about the village except some ruins, among which are some which are said to have been the house of Martha and Mary, and the cave or grave of Lazarus, the descent into which is effected by 26 steps cut in the solid rock, leading to a small chamber, about 5 feet square, also excavated. The appearance of the cave certainly corresponds with what is said about it in Scripture—'It was a cave, and a stone lay upon it' (St John xi. 38). Near to the cave are the ruins of a fort built by Queen Melisinda in 1132, to protect the nunnery founded by her in honour of Martha and Mary.

B'ETHEL, called Betein by the natives, about 10 miles from Jerusalem, mentioned in Scripture as the scene of Jacob's dream. Here also Abraham pitched his tent. Now a heap of ruins, almost entirely deserted, or only inhabited by a few straggling Arabs.

B'ETHELL, Sir RICHARD, an eminent lawyer, born at Bradford, Wiltshire, in 1800, son of a physician at Bristol. From Bristol Grammar School he went, at the age of 14, to Wadham College, Oxford, where he was first class in classics, and second class in mathematics, and took his degree of B.A. at the early age of 18. After being a private tutor at Oxford, he studied law, and was called to the bar at the Middle Temple in November 1823. In 1840, he was made a Queen's counsel. Elected, in April 1851, M.P. for Aylesbury, on the formation of the Aberdeen ministry in December 1852, he was named Solicitor-general, and shortly after knighted. From November 1856 to March 1858 he was Attorney-general. For several years he was Vice-chancellor of the county Palatine of Lancaster, and standing counsel to the university of Oxford. He has also been conspicuous for his exertions in the cause of law reform, in improving the system of education for the bar, and in abolishing the ecclesiastical courts, and facilitating the transfer of land.

BETHE'SDA, POOL OF, meaning 'House of Pity.' The scene of Christ's cure of the impotent man (St John v. 2-9), and resort of the 'impotent, blind, halt, and withered,' once filled with water, 'which an angel went down at certain seasons and troubled,' is now dry and used as a deposit for dirt and rubbish. It is situated within the gates of Jerusalem, near the St Stephen's gate and the Temple of Omar; measures 460 feet in length, by 130 in breadth, and 75 in depth.

B'ETHEHEM, or BEIT-LAHAM, meaning 'House of Bread,' celebrated in Scripture as the birthplace of our blessed Saviour, and of King David, is now a small unwall'd village, situated at a distance of 5 miles south of Jerusalem. The population, about 3000 souls, is wholly Christian—that is, Latin, Greek, and Armenian. The village is situated in the centre of a most interesting country; and the roof of the Latin monastery—the only public building of any importance, enclosing the cave which is the alleged place of our Lord's nativity—commands a beautiful and extensive view of the surrounding country: in the distance, east, are the mountains of Moab and the plains of the Jordan; south, stands the hill of Tekoah, familiar as the scene of the pastoral life of the prophet Amos; beyond, and rather more to the east, lies the wilderness of Engedi, to which David retreated for the purpose of concealing himself against the pursuit of Saul, and where the allied armies of the Amorites, Moabites, and others, encamped when they came forth against Jehoshaphat; north, is the road to Jerusalem, with the mountains of Judea and Rachel's tomb. The Convent of the Nativity,

which encloses the supposed manger, &c., is a large square building, more resembling a fortress than the quiet habitation of the recluse, was built by the Empress Helena, 327 A.D., but destroyed by the Moslems in 1236, and, it is supposed, restored by the Crusaders. Within it is the Church of the Nativity, which, like and in connection with the Church of the Holy Sepulchre at Jerusalem, is subdivided among the Latins, Greeks, and Armenians, each community having a separate portion of the edifice for devotional purposes. The church is built in the form of a cross; the nave, which is by far the finest part of the building, belongs to the Armenians, and is supported by 48 beautiful Corinthian columns of solid granite, each between 2 and 3 feet in thickness, and about 17 in height. The other portions of the church, forming the arms of the cross, are walled up. At the further end of that section, which forms the head of the cross, and on the threshold, is a sculptured marble star, which the Bethlehemites say covers the central point of the earth! Here a long intricate passage descends to the crypt below, where the blessed Virgin is said to have been delivered. The walls of the chamber are hung with draperies of the gayest colours; and a silver star, with the words, '*Hic de virgine Maria Jesus Christus natus est*,' marks the spot of the nativity. The manger stands in a low recess cut in the rock, a few feet from this star.

The other objects of interest in the church are the chapel and tomb of St Jerome, who became a monk of this convent towards the end of the 4th c.; the chapel and tomb of Santa Paula, a Roman lady, and the founder of several nunneries at Bethlehem; the tomb of St Eudisia; and the pit into which it is supposed the bodies of the murdered innocents were cast. B. is under the jurisdiction of the pasha of Jerusalem. The Bethlehemites chiefly gain their subsistence by the manufacture and sale of crucifixes, beads, boxes, shells, &c., of mother-of-pearl and olive-wood. Much wine is made at B. which is considered all over Palestine next best to the Lebanon wine.

B'ETHEHEM is the name of the chief settlement of Moravians or United Brethren in Pennsylvania, U. S.

B'ETHEHEMITE, or B'ETHEHEMITE BROTHERS, the name of an order of monks at Cambridge in the 13th c.; also of an order founded in Guatemala, 1673. The followers of Jerome Huss were styled B., from Bethlehem Church in Prague, where their leader preached.

B'ETHNAL GREEN, an eastern suburb of London, in Middlesex, including Victoria Park. Pop. 90,192, many being silk-weavers.

BETHSA'IDA, on the lake of Galilee, mentioned in Scripture as the city of Peter and Andrew and Philip, now a heap of ruins almost overgrown with grass.

BETHSHE'MESH ('House of the Sun,' or 'Sun Town;,' modern name, *Ain-esh-Shems*, 'Fountain of the Sun,' now distinguishable by neither house nor fountain from which it was likely to derive its name), a ruined city of Palestine, 15 miles west-south-west of Jerusalem, finely situated on the point of a low ridge, commanding an extensive view of the country, rendered interesting by the exploits of Samson. B. was a sacerdotal city belonging to the tribe of Judah, bordering alike on the possessions of Dan and of the Philistines, and fixed by Eusebius ten Roman miles from Eleutheropolis, on the Nicopolis road. It is interesting as the place where the Ark of the Lord first rested, after the Philistines had sent it back (1 Sam. vi.). One of Solomon's twelve purveyors resided at B., where also was

fought the battle between Judah and Israel, in which Jehoash captured Amaziah (2 Kings xiv. 11, 13). B. was taken by the Philistines during the reign of Abaz, and from that time disappears from sacred history.

BETHUNE, a town of France, in the department Pas-de-Calais, situated on a rock overlooking the river Brette, and the canals of Lawe and Aire, 16 miles north-north-west of Arras. It is strongly fortified, part of the works and the citadel having been constructed by Vauban. It has manufactures of linen and cloth, and a considerable trade in the agricultural produce of the surrounding country. Taken by the French in 1645, it was retaken by the allies in 1710, but was restored to France by the Treaty of Utrecht. The first artesian wells are said to have been bored here. Pop. 7273.

BET'ICK, or BET'IK, on the river Oxus, Central Asia, 'one of the greatest ferries between Persia and Turkistan.' Lieutenant Burnes, who in 1834 published an account of his travels in Central Asia, says the Oxus is here 650 yards broad and 25 to 29 feet deep.

BET'JUANS, or BECHUA'NAS, the name of an extensive nation of Southern Africa, occupying the country between 23° and 29° E. long., and extending from 28° S. lat. northward beyond the tropic of Capricorn. The B. are generally of a peaceful, indeed cowardly disposition, and are divided into many tribes under the government of chiefs who exercise a kind of patriarchal authority over them. According to Dr Livingstone, the different tribes take their names from certain animals, 'shewing probably that in former times they were addicted to animal worship. The term Bakatla means, "they of the monkey;" Bakuena, "they of the alligator;" Batlápi, "they of the fish;" each tribe having a superstitious dread of the animal after which it is called. They also use the word "bina," to dance, in reference to the custom of thus naming themselves, so that when you wish to ascertain what tribe they belong to, you say, "What do you dance?" It would seem as if that had been part of the worship of old.' Many tribes formerly existing are extinct, as is evident from names that have now no living representatives. The B. have a vague notion of a Supreme Being, but no intelligent idea of his attributes. Dr Livingstone describes the tribe to which he attached himself—the Bakuena or Bakwains—who are favourable specimens of the nation, as generally slow 'in coming to a decision on religious subjects; but in questions affecting their worldly affairs they are keenly alive to their own interests.' In all agricultural matters they are very acute, exhibiting a wonderful knowledge of the properties of the soil, as well as of the nature and habits of animals. They have a superstitious reverence for a class of impostors calling themselves 'rain-doctors,' who profess to be able to bring down rain in dry seasons by a certain specific, composed of all kinds of disgusting animal and vegetable substances. One peculiarity of the B. is their inability to build their houses square; all erections take a circular form.

BETROTHMENT, a mutual engagement by a man and woman with a view to marriage. This anciently consisted in the interchange of rings, kissing, joining hands, and the testimony of witnesses; and the ecclesiastical law punished the violation of such B. by excommunication; but such a spiritual consequence was abolished by the 26 Geo. II. c. 33. A previous B. had also been regarded as a legal impediment to marriage with another. 'It was not,' says Mr Macqueen, in his *Treatise on the New Divorce Jurisdiction*, 1858, p. 73, 'by the

axe that the promoter of the English Reformation extinguished his marriage with Anne Boleyn. He first carried her into the Ecclesiastical Court, and there obtained a sentence, on the ground of her alleged precontract with Northumberland.' The aggrieved party, since the 26 Geo. II., has been left to the only remedy of an action for breach of promise. In Scotland, there is the same mode of redress consequent on a refusal to proceed to matrimony; but in that country, where the B. or engagement can be shewn to have been a clear, free, and deliberate *present consent* on the part of both the man and woman to form the relationship of husband and wife, such a contract may be enforced against the recusant party; and indeed it constitutes marriage itself. See MARRIAGE, BREACH OF PROMISE TO MARRY, HUSBAND AND WIFE.

BETTERTON, THOMAS, a celebrated actor, for about half a century the chief ornament of the English stage, was born in London, 1635, and died there in 1710. The best contemporary judges, such as Addison, Cibber, &c., bear admiring witness to his dramatic powers, which overcame the natural disadvantages of a low voice, small eyes, and an ungainly figure. His private character was highly estimable, cheerful, modest, and generous. After a retirement of many years, it became known that his circumstances were very straitened, and it was determined to give him a public benefit. On the 6th April 1709, the spirited veteran (then in his 74th year) appeared with immense *éclat* in the youthful part of Valentine in Congreve's *Love for Love*. He acted several times again. Mrs B. took the same rank among contemporary actresses as her husband did among actors.

BETTING, or WAGERING, is an inveterate practice of the English, which is exemplified in almost all classes of society, but more particularly in relation to horse-racing; bets as to which will be the winning horse at a particular race, being entered into by the highest as well as the lowest of the people. Sanctioned by fashion, betting on horses is carried on to so ruinous an extent in the metropolis, that the legislature has interfered to check the evil. The haunts of betters, called BETTING-HOUSES, are suppressed by the 16 and 17 Vict. c. 119. The act declares them to be a common nuisance, and contrary to law, and prohibits them under very severe penalties. But it provides that its enactments shall not extend to stakes or deposit due to the winner of any race, or lawful sport, game, or exercise. The act does not extend to Scotland; but see GAMING.

BETTO'LA, a town of Italy, in the duchy of Parma, about 20 miles south-west of Piacenza. It is situated on the Nure, in a fertile but only partially cultivated district. Pop. 6600.

BET'TULA. See BIRCH.

BETULA'CEÆ, or BETULINEÆ. See AMEN-TACEÆ and BIRCH.

BET'WAH, a river of India, which, after a north-east course of 340 miles, joins the Jumna on the right, about 30 miles to the east-south-east of Calpee. It rises in the Vindhya Mountains, which, uniting the West and the East Ghauts at their northern extremities, form the dividing ridge between the basins of the Nerbudda and the Ganges. It runs through beds of iron ore, and waters the towns of Bileah and Jhansi. The source of the B. is in lat. 23° 14' N. and long. 77° 22' E., and its mouth in lat. 25° 57' and long. 80° 17'. It is described as a very great river, being, even in the dry season, half a mile wide at its junction with the Jumna. It is, however, not navigable in any part of its course.

BEUKELZOON, WILLIAM, a person in humble

lifs, belonging to the small town of Biervliet, in Holland, was the first who succeeded in salting and preserving herrings in a satisfactory manner. This improvement, which is said to have taken place in the year 1386, communicated a great impetus to the industry of the fisheries of Holland. It is related that the emperor, Charles V., made a pilgrimage to the tomb of B., and there ate a herring in expression of his gratitude for the invention. B.'s name, which is otherwise written as Beukels, Bökel, &c., is said to be the origin of the word *pickle*. B. died in 1397.

BE'VEL, a term used by builders to describe a sloped or canted surface. See **SPLAY**.

BE'VELAND, NORTH and SOUTH, two islands in the estuary of the Scheldt, in the province of Zeeland, Holland, separated by a channel on the west from the island of Walcheren. The estimated area is about 120 square miles, with a population of 23,000. South B. is the most extensive and fertile, being about 25 miles in length, and from 8 to 9 broad. Its capital, Goes, on the north side—lat. 51° 30' N., and 4° E.—is a well-built and fortified town, with 5500 inhabitants. North B. is about 13 miles in length; its greatest breadth, 4 miles. South B. produces corn and fruit abundantly, and fish are plentiful on the coast. North B. is low and marshy. Both islands have suffered dreadfully from inundations. In 1532, North B. was completely covered with water, many of the inhabitants perishing; and it remained submerged for several years. At the same time, the flourishing town of Romerswaal was separated from South B., and afterwards so encroached on by the sea, that the whole of the inhabitants had to leave it. The islands also suffered considerably from inundation in 1803. Within recent years, much good has been effected by drainage.

BEVELLED-GEAR. See **GEARING**.

BEVERIDGE, WILLIAM, Bishop of St Asaph, was born at Barrow, Leicestershire, in 1638. Entering St John's College, Cambridge, at the age of fifteen, he at once became remarkable for his diligence and piety, and particularly for his devotion to the study of oriental languages, a treatise on which he published at the age of twenty. In 1660, having obtained his degree of M.A., he was ordained both deacon and priest. After many excellent preferments, in which he was remarkable for his devotion to his pastoral duties, he was, in 1704, appointed to the bishopric of St Asaph, having previously refused to accept that of Bath and Wells, on the deprivation of Dr Thomas Kenn, for not taking the oaths to the government of William III. He died March 5, 1708, leaving the great bulk of his property to the Societies for the Promotion of Christian Knowledge, and the Propagation of the Gospel in Foreign Parts, and a reputation for sincere piety and great learning. His works, which, besides the treatise mentioned, include another on chronology, a collection of canons from the time of the apostles to that when the synod of Constantinople restored Photius, and various sermons and works of a religious kind, with a life, were collected and published in 9 vols. 8vo in 1824, by the Rev. Thomas Hartwell Horne.

BEVERLAND, ADRIAN, a Dutch scholar who, by several of his writings, but more especially by his unorthodox interpretation of the Fall, caused great excitement among the theologians of his day. He was born at Middelburg, in Zeeland, about the middle of the 17th c.; had studied law, visited the Oxford University, and was settled as an attorney in Holland, when, in 1678, he published his pamphlet, *Peccatum Originale*, which was not only burnt at the Hague, but led to his own imprisonment, and to his expulsion from Utrecht and Leyden, whither

he had wished to betake himself. On his return to the Hague, he wrote *De Stolata Virginitatis Jure* (The Hague, 1680), which gave still greater offence than his first work. Soon after, he came to England, where he found a supporter in Isaac Vossius, and probably received his degree as doctor of civil law in Oxford. But it would appear from his virulent attacks against several dignitaries of the English Church, that he met with a good deal of theological opposition in England also. Probably it was the death of his benefactor, Isaac Vossius, in 1689, that led him in 1693 to repudiate his earlier writings, and to regret their tone. Having become insane, he appears to have died in England soon after 1712. In spite of his numerous enemies, B. stood high in the friendship of some of the most distinguished men of his time. His views respecting original sin have been often expressed by others, both before and after his day, though in a less flippant style. His works are now mere bibliographical curiosities.

BE'VEERLEY, the chief town of the E. Riding of Yorkshire, 1 mile west of the river Hull, with which it communicates by canal, and 10 miles north-north-west of the city of Hull. Pop. 10,058. B. returns two members to parliament. Its trade consists in corn, coals, and leather, and there is a large colour and whitening manufactory. The finest object in B. is the superb Gothic minster, or the Collegiate Church of St John, ranking next to York Minster among the ecclesiastical structures of the country, and exhibiting different styles of Gothic architecture; the oldest part being of the 13th c. The choir contains the celebrated Percy shrine, of the most exquisite workmanship. The Grammar School of B. is so old, that the date of its foundation is unknown. B. arose out of a priory founded about the year 700, and received its name from Beverlac, 'lake of beavers,' from the great number of these animals in a neighbouring lake or morass.

BEVERLOO', a village of Belgium, in the province of Limbourg, 12 miles north-west of Hesselst. On the extensive heaths surrounding it, the Belgian army encamps yearly for exercise.

BE'VEERWYK, a town of the Netherlands, North Holland, about 7 miles north of Haarlem. Pop. 2252. It is situated in the midst of what might be described as a vast and beautiful meadow, and is quite a model of Dutch neatness and cleanliness. In his country-house, in the immediate vicinity, the Prince of Orange planned the expedition which resulted in the English Revolution of 1688.

BEW'DLEY (formerly Beaulieu, from its pleasant situation), a town on the right bank of the Severn, in the north-west of Worcestershire, 14 miles north-north-west of Worcester. Pop. 7318. B. returns one member to parliament. It has manufactures of leather, combs, lantern leaves, carpets, and iron and brass wares. The chief transit for goods is by the Severn. Near the town is a public park of 400 acres, with fine groves of elm, oak, and plane.

BEWICK, THOMAS, a celebrated wood-engraver, was born at Cherryburn, near Newcastle-on-Tyne, in 1753. Apprenticed to Beilby, an engraver in Newcastle, he displayed such extraordinary aptitude in his art, that, at the age of 17, he was intrusted with the cutting of the whole of the diagrams in Hutton's treatise on Mensuration. He afterwards illustrated Gay's *Fables*, obtaining in 1775, for one of the cuts, the 'Old Hound,' the prize which the Society of Arts had offered for the best wood-engraving. In 1790, B., who had entered into partnership with Mr Beilby, completed, along with his brother John, who was his pupil, the illustrations

for a *General History of British Quadrupeds*, a work which raised his reputation far above that of any of his contemporaries, and gained for him the honourable and not undeserved appellation of the reviver of wood-engraving. Considered as works of art, these illustrations are still unrivalled in graphic force of expression and fidelity to nature, though the great mechanical improvements in the art introduced since B.'s time have rendered them inferior in clearness and delicacy of execution to some of the best cuts of the present day. Assisted by his brother, B. illustrated Goldsmith's *Traveller* and *Deserted Village*, Parnell's *Hermit*, and Somerville's *Chase*; and in 1797 appeared the first volume of his *History of British Birds*, which was followed in 1804 by the second. This splendid work was entirely B.'s own, his brother having died in 1795. B.'s last work, the unfinished proofs of which he received the Saturday before his death, which took place at Gateshead, November 8, 1828, is called 'Waiting for Death,' and represents an old worn-out horse, with great pathos and truth. It was designed to assist in the prevention of cruelty to animals. A large cut of a bull—of the Caledonian breed—is considered B.'s *chef-d'œuvre*. B. had many pupils, some of whom are now among our best engravers.

BEX, a village of 3000 inhabitants, in the Swiss canton of Vaud, situated on the high road to the Simplon, about 26 miles south-east of Lausanne. It is remarkable for its extensive salt mines, salt works, and sulphur baths. One of the mines, called *Du Bouillet*, has a gallery 7½ feet high, and 5 feet wide, extending horizontally into the mountain a distance of more than 2000 yards. The quantity of salt annually produced at B. is between 2000 and 3000 tons.

BEXA'R, SAN ANTONIO DE, a thriving town of Texas, on the San Antonio River, and at a distance of 110 miles to the south-west of Austin City. It is growing rapidly in population (estimated, in 1853, at 6000), and of course in wealth. The place contains a United States arsenal, with two newspapers and several seminaries and churches. San Antonio de B. was famous in the conflicts between the Mexican authorities and the American adventurers, more especially for the indiscriminate slaughter by the former of Colonel Crockett and his garrison.

BEY'ERLAND, or BEI'GERLAND, an island of South Holland, lat. 51° 46' N., long. 4° 26' E. It is formed by the junction of the Old Maas with Holland Diep on the one side, the river Spui uniting the Old Maas with the Haringvliet on the other. It has several villages, one of which, Old B., is a thriving place of nearly 4000 inhabitants.

BEY'ROUT, or BEIRUT, the Berothai or Berothah of the Old Testament (2 Samuel viii. 8, and Ezekiel xlvii. 16); and the Berytus of the Romans. It was besieged and captured by Baldwin I., king of Jerusalem, in 1111; recaptured from the Christians in 1187. In 1197, it again came into the hands of the Christians, and then successively under the Saracens, Seljukian, and Turkish sultans. In course of the operations to support the Turkish claims against the assumed power of the pasha of Egypt, B., in 1840—1841, was bombarded by the English fleet under Sir C. Napier, taken, and delivered over to the Turks. There are three castles still standing out in the sea, whose battered walls bear witness to the efficacy of the British cannon. There are no ancient monuments worth visiting.

B. is a flourishing commercial town, situated in a most picturesque position on the coast of Syria, and at the foot of Lebanon, 55 miles from Damascus,

and 147 from Jerusalem. It is the chief seaport, market-town, and emporium of all the trade with the shores of Syria, Palestine, and Cilicia; and has a population of 20,000 souls, of which about 600 are Europeans (English, French, Italian, and German). Several British merchants are established in B., and lately a branch of an English bank (the Ottoman Bank) has been set up, the chief office of which is in London. B. supplies the Lebanon, Damascus, and the north of Syria to Antioch and Joppa, with European manufactures and goods. French steamers, carrying mails, leave B. every week for Marseille. British steamers ply between Liverpool and B. every fortnight, bringing Manchester manufactures, prints, chintzes, Birmingham and Sheffield cutlery, &c., and returning to Liverpool with madder roots, wool, silk, valonia, or wheat, of which the country produces considerable quantities. Since 1859, a direct trade has been established between B. and the United States of America, the articles sent to the United States being wool and olive-oil. There is good anchorage in the roadstead, with shelter during stormy weather in the Beyrout River, about 3 miles from the town; about 150 merchant vessels of different nations visit and leave B. every year. The commerce is steadily increasing. In 1848, the imports were only £546,266; in 1853, they had increased to £722,864; and in 1857, to £1,324,550. The exports in 1848 amounted only to £253,648; but in 1853, they had increased to £624,544; and in 1857, to £983,398. In 1853, the imports into B. from Great Britain were £225,875; in 1858, they had increased to £418,750. A commercial tribunal, composed of European and native merchants, to adjudicate all mercantile disputes and bankruptcies, has lately been established; and consuls from all nations reside at Beyrout. Ship-building has begun to attract the attention of the natives, who have built and launched at B. several vessels of fifty to eighty tons within the last few years. At a village called Shezman, a few miles from B., Mr Scott, an enterprising Scotchman, has lately built and established a silk factory, worked by steam; the silk produced is fine, and much esteemed in the London and Lyon markets. In 1859, a line of omnibuses, the first ever seen in Syria, was established at Beyrout. The natives at first regarded them with great astonishment, and crowded from all sides to see them pass. A French company is now (1860) making a good road from B. to Damascus. In the summer months, B. experiences a scarcity of fresh water, which has to be brought in jars on the back of mules and donkeys from the river of B., a distance of about three miles. The town has lately been improved by the removal of the walls which formerly surrounded it. From its proximity to the mountains of Lebanon, on which the climate is most agreeable and salubrious, B. is an attractive place of residence; and it might rise into importance but for its odious Turkish custom-house arrangements and system of government.

BEZA, THEODORE (properly, De Bèze), next to Calvin the most energetic and influential of the Genevese reformers, was born of a noble family at Vezelai, in Burgundy, 24th June 1519. He received an admirable education in Orleans, from Melchior Wolmar, a German, who was especially learned in the Greek language, and also imbued with the principles of the Reformation, which he communicated to his pupil. As early as 1539, B. became known as a writer of witty and elegant but indecent verses, the publication of which (1548) caused him many bitter regrets in after-days, when his heart was purer. In his twentieth year, he obtained his degree as licentiate of civil law, and went to live in Paris, where he appears to have spent several years

in a kind of fashionable dissipation, though he does not accuse himself of any gross profligacy. B. possessed a handsome figure, which, together with his fine talents and good birth, opened to him the most brilliant prospects. Although not a priest, he pocketed the revenues of two benefices, while his income was largely increased by the death of an elder brother. It was the desire of his relatives that he should enter the church, but a private marriage which B. had contracted, rendered this impossible. A severe illness now attacked him, during the lapse of which, the folly and sinfulness of his career vividly presented themselves to his conscience; he repented, and on his recovery, in order to avoid the perils and perplexities of his position, he went to Geneva along with his wife, October 1548. Shortly after, he was appointed Greek professor at Lausanne, an office which he held for ten years. In 1550, he published with success a melodrama, entitled *The Sacrifice of Abraham*, and delivered lectures on the Epistle to the Romans and the Epistles of Peter to crowded audiences. Out of these lectures ultimately sprang his Translation of the New Testament into Latin. In 1559, he went to Geneva, where he became Calvin's ablest coadjutor, and was appointed a theological professor and president of the college. He had already signalled himself by his work *De Hæreticis a Civili Magistratu puniendis*, in which, like many other good but mistaken men, he approved of the burning of Servetus. His diplomatic tact was particularly good. He induced the king of Navarre to exert his influence on behalf of the persecuted French Protestants, and was persuaded by the latter to attend the conference of Catholic and Protestant divines, held at Poissy in 1561. Here his courage, presence of mind, and dexterity made a very favourable impression on the French court. Catherine de Medicis entertained so high an opinion of his abilities, that she desired him to remain in France. While in Paris, he often preached before the king of Navarre and Condé. On the outbreak of the civil war, he accompanied the latter as a kind of military chaplain, and after his capture attached himself to Coligny. In 1563, he once more returned to Geneva. In the following year, Calvin died, and the care of the Genevese church now fell principally upon his shoulders. He presided over the synods of French Reformers, held at Rochelle in 1571, and at Nismes in 1572. In 1574, he was deputed by Condé to transact important business at the court of the Palatinate; and in 1586, measured himself with the Wirtemberg divines, especially Jacob André, at the religious conference held at Montbeliard. In 1588, his first wife died, and although verging on seventy, he married another—an awkward circumstance, it must be confessed, and one which his enemies, the Jesuits, tried to make a handle of; but B., who still retained complete mastery over his faculties, retorted with his accustomed liveliness and skill. In 1597, his calumniators spread the extremely foolish report that B. was dead, and at the last hour had returned to the bosom of the church. The witty patriarch replied in a poem full of sparkling vigour. He died 13th October 1605, at the ripe age of 86.

B. was thoroughly grounded in the principles of his master, Calvin, in whose spirit he vigorously ruled the Genevan Church for forty years, exercising the influence of a patriarch. To secure its unity, strength, and permanence, he spared no pains, sacrificing even his personal possessions. By his abundant learning, his persevering zeal, his acute intellect, his fine eloquence, and his impressive character, he rendered it important services. His numerous theological writings, however, cannot be

said to have proved attractive to posterity. They have almost ceased to be read. The works by which he is best known are his translation of the New Testament into Latin, and his *History of the French Protestants from 1521 to 1563*.

BEZANT. See BÉSANT.

BEZIERS, a city of France, in the department of Herault, lat. 43° 21' N., and long. 3° 13' E. It is pleasantly situated on a hill, in the midst of a fertile country, at the junction of the Orb and the Canal du Midi, about 38 miles south-west of Montpellier. It contains some interesting architectural and antique buildings—the principal being the cathedral, a noble Gothic edifice; the churches of La Madeline and St Aphrodisse; and the ancient episcopal palace. The old citadel has been destroyed, but the walls still remain, and are made use of as a promenade. B. has manufactures of silk stockings, woollens, gloves, parchment, glass, soap, leather, and much esteemed confectionaries. It has also extensive brandy distilleries, and is the centre of most of the trade of the district. The town is supplied with water raised from the Orb by means of a steam-engine. Pop. 19,905.

B. is a place of great antiquity, and still contains Roman remains. It is historically interesting in connection with the massacre of the Albigenes, its inhabitants having been indiscriminately put to the sword by Simon de Montfort and the pope's legate, for having afforded protection to the fugitives in 1209. B. suffered also in the religious wars of the 16th c.

BE'ZOAR (Pers. *pazar*, a goat; or *pa*, against, and *zacher*, poison), a concretion found in the stomachs of goats or antelopes, and formerly much valued on account of imaginary medicinal virtues, particularly as an antidote to poisons. Concretions of various kinds are found in the stomachs of herbivorous quadrupeds, very generally having for their nucleus some small indigestible substance which has been taken into the stomach. Sometimes they are of a radiating structure; sometimes formed of concentric layers; sometimes they are principally composed of superphosphate of lime, sometimes of phosphate of ammonia or magnesia. Other concretions found in the intestines, &c., of various animals are sometimes also called bezoar. See CALCULI. The value of a B. being supposed to increase with its size, the larger ones have been sold, particularly in India, for very great prices.

BHADRINA'TH, a town of Gurhwal, in the subpresidency of the North-western Provinces, India, situated in a valley of the Himalaya, 25 miles to the south of the Manah Pass, which leads into Tibet. Lat. 30° 44' N., long. 79° 32' E. Its highest point is 10,294 feet above the level of the sea; while, about 12 miles to the west, there is a group of summits, called the Bhadrinath Peaks, having the respective elevations of 23,441, 23,236, 22,934, 22,754, 22,556, and 21,895 feet; the east also, and the south-west, presenting detached mountains of similar magnitude. B. is situated on the right bank of the Vishnugunga, a feeder of the Aluknunda, which itself again unites with the Bhageerettee to form the Ganges. The chief attraction of the place is its temple, which, though the actually existing edifice is modern, is said to be an establishment of great antiquity. This temple overhangs a tank of about 30 feet square, which is supplied, by a subterranean passage, from a thermal spring in the neighbourhood. As ablution in these waters is held to cleanse from all past sins, B. is a grand resort of pilgrims, every year bringing large numbers, but every twelfth year, when a periodical festival is celebrated, collecting fully 50,000. From

November to April, the temple and its deity are abandoned even by the attendant Brahmins, on account of the cold.

BHAGAVAD-GĪTĀ (i. e., Revelations from the Deity) is the title of a religious metaphysical poem, interwoven as an episode in the great Indian epic poem of the Mahābhārata (q. v.). Two hostile armies, the nearly related Kurus and Pāndus, are drawn up in opposition, ready for battle; the trumpets sound the opening of the combat; and the Pāndu Ardshuna mounts his chariot, which is guided by the Deity himself, as charioteer, in the human form of Krishna. But when Ardshuna perceives in the hostile army his relatives, the friends of his youth, and his teachers, he hesitates to commence the struggle, held back by the doubt whether it were lawful for him, for the sake of the earthly gain of reconquering his father's kingdom, to transgress the divinely approved ordinances for the government of the state. Upon this, Krishna sets forth, in a series of eighteen poetic lectures, the necessity of proceeding, unconcerned as to the consequences. In the progress of his long discourse, a complete system of Indian religious philosophy is developed, in which the highest problems of the human mind are treated with as much clearness of thought as elegance of language. It is impossible to determine exactly when and by whom the work was composed. It is not, however, one of the first attempts of Indian philosophy, for it is rather of an eclectic nature; and before it could have been composed, there must have been a period of long-continued intellectual cultivation in many philosophic schools. It is not unlikely that it was written in the first century after Christ. The work is looked upon with great reverence in India, and it has accordingly been made the subject of numerous commentaries (the best is that of Śrīdhara-Svāmin, published in Calcutta in 1832), and it has likewise been translated into various Indian dialects. Five different metrical versions in Hindi appeared in Bombay in 1842; a translation into the Telugu dialect in Madras, 1840; into the Canarese, Bangalore, 1846, &c. The best critical edition of the Sanscrit text is that of A. W. von Schlegel (2d ed., Bonn, 1846), to which is added a Latin translation. Among the other translations may be mentioned that into English by Wilkins (Lond. 1785), who had the credit of first making the work known in Europe; that into German, by Peiper (Leip. 1834); and the Greek translation by Galanos (Athens, 1848). W. von Humboldt's treatise, *Upon the Episodes of the Mahābhārata, known under the Name of the Bhagavad-Gītā* (Berlin, 1827), contains an admirable exposition of the philosophy of the poem.

BHAGULPORE, the capital of the district of the same name in the sub-presidency of Bengal, in lat. 25° 11' N., and long. 87° E. It stands on the right bank of the Ganges, which is even here 7 miles wide in the rainy season. A seminary for English instruction has been here established by the British government, which, in 1852, numbered 115 pupils—15 Mohammedans, 70 Hindus, and 30 of other denominations. In the vicinity of the town are two antiquarian curiosities, being round towers of about 70 feet in height, of the origin or object of which nothing is known.—2. B., as a district, contains 5806 square miles, and 2,000,000 inhabitants. It lies south of Nepal, in lat. 24° 17'—26° 20' N., and in long. 86° 15'—88° 3' E. About a fifth of the whole is covered by hills, which, stretching away towards the south-west, connect themselves with the Vindhya Mountains, the grand dividing-ridge between the Nerbudda and the Ganges.

BHAMO', a town of Burmah, on the Upper Irrawaddy, 40 miles to the west of the Chinese frontier, and 180 to the north-north-east of Ava. It contains 2000 houses, and has round it many populous villages. It is the chief mart of the trade with China, the imports being woollens, cottons, and silks, which are brought principally by winter caravans. B. has also a considerable trade with the tribes of the neighbourhood, who resort to the town, exchanging their native produce for salt, rice, and a sauce made of dried fish.

BHANG, the eastern name for Hemp (q. v.).

BHARTRIHARI is the name of a celebrated Indian writer of apothegms. Little is known regarding the circumstances of his life. A legendary story makes him the brother of King Vikramāditya, who lived in the 1st c. B. C., and relates of him, that after a wild licentious youth, he betook himself in later years to the ascetic life of a hermit. His name has been given to a collection of 300 apothegms—whether it be that he actually wrote them, or, as is more probable, that the apothegms were popular works, written by many various authors, but ascribed, according to the Indian custom, to some personage well known among the people in legends and tales. Cheerful descriptions from nature, and charming pictures of love, alternate in these apothegms, with wise remarks upon the relations of life, and profound thoughts upon the Deity and the immortality of the soul. Bohlen has published an excellent critical edition (Berlin, 1833), with a supplement, *Varia Lectiones* (Berlin, 1850), as well as a successful metrical translation into German (Hamburg, 1835). B. has a certain special interest as having been the first Indian author known in Europe, 200 of his apothegms having been translated in 1653, by the missionary, Abraham Roger, in a learned work published at Nuremberg, under the quaint title, *Open Gates to Hidden Heathenism*.

BHAVANI-KUDAR, or **BHOVANI-KUDAR**, a town in the presidency of Madras, in the district of Coimbatore, 58 miles to the north-east of the city of that name. It takes its name from its position at the confluence of the Bhavani or Bhovani, and the Cauvery. It is worthy of notice chiefly for its temples of Vishnu and Siva.

BHAWLPOOR, the capital of the protected state of the same name in India, is situated on a tributary of the Ghara, which, formed by the junction of the Sutlej and the Beas, falls into the Chenab about fifty miles further down, in lat. 29° 24' N., and long. 71° 47' E. It has a circuit of four miles—part, however, of the enclosed space being occupied by groves of trees; and its population is estimated at 20,000. B. has manufactures of scarfs and turbans, chintzes and other cottons, and the immediate neighbourhood is remarkably fertile in grain, sugar, indigo, tobacco, and butter, with an abundance of mangoes, oranges, apples, and other fruits, in perfection. For external commerce, too, B. is favourably placed, standing at the junction of three routes respectively from the east, south-east, and south; while, towards the north, the Hindu merchants, who are very enterprising, have dealings with Bokhara, and even with Astrakhan.—2. The state of B. lies in lat. 27° 41'—30° 25'; and long. 69° 30'—73° 58' E. The area is about 22,000 square miles—the population being perhaps overrated at 600,000, or somewhat more than twenty-seven inhabitants to a square mile. The country is remarkably level: only about one-sixth is capable of cultivation. The fertile portion, skirting the Ghara and the Indus, has a purely alluvial soil; but the remainder, though presenting many traces of former cultivation and population, is now, from want of

water, an irreclaimable desert either of hard dry clay, or of loose shifting sands. Besides beasts of chase, such as tigers, boars, &c., B. abounds in domestic animals, such as camels, kine, buffaloes, goats, and broad-tailed sheep. In few parts of the world are provisions finer or cheaper. The principal exports are cotton, sugar, indigo, hides, drugs, dye-stuffs, wool, ghee or butter, and provisions in general. The principal imports are the wares of Britain and India. The khan and a great majority of his subjects are Mohammedans. But Hindus are treated with much toleration. The annual revenue is about 1,500,000 rupees, or about £150,000.

BHEL, or **BAEL**. See **ÆGLE**.

BHOJ, the capital of Cutch, in India, situated at the foot of a fortified hill of the same name, where a temple has been erected to the cobra da capella, in lat. 23° 15' N., and long. 69° 44' E., about 35 miles from the sea. It contains about 20,000 inhabitants. Its mosques and pagodas, interspersed with plantations of dates, give to the town an imposing appearance from a distance. In 1819 it suffered severely from an earthquake. It is celebrated over India for its manufactures in gold and silver.

BHO'PAL, the capital of the territory of the same name, in India, lies in lat. 23° 14' N., and long. 77° 33' E. It is surrounded by a dilapidated stone-wall of about two miles in circuit. The fort, which is the residence of the nawab, stands on a huge rock outside the town. B. is worthy of notice mainly in connection with two immense tanks in the immediate neighbourhood—one of them being 2 miles in length, and the other measuring 4½ miles by 1½. As each sends forth a river, they have most probably been formed by the embanking and damming up of their respective streams.—The territory of B. is a protected state, under the immediate superintendence of the governor-general. It is situated within the basins of the Ganges and Nerbudda, in lat. 22° 32'—23° 46' N., and long. 76° 25'—78° 50' E.; its area being estimated at 6764 square miles, and its population, on an assumed average for Central India, at 662,872. Though the vast mass of the people are Hindus, yet the government is Mohammedan, and is understood to be more popular in its character than any other in India.

BHOTA'N, or **BOO'TAN**, a territory in the north-east of India, said to be partly dependent on Tibet, in lat. 26° 18'—28° 2' N., and long. 88° 32'—92° 30' E., being bounded on the N. by the main ridge of the Himalaya, on the E. by Assam, on the S. by Bengal, and on the W. by Sikkim. With an area of 64,500 square miles—more than equal to that of England and Wales—it is said to contain only 1,500,000 inhabitants. The whole surface may be described as mountainous, with a gradual slope from north to south. Generally speaking, the middle ranges are the most productive. While the south presents but a scanty vegetation, and the north rises far above the limit of perpetual snow, the central regions, at an elevation of 8000 or 10,000 feet above the sea, are covered with the finest forests of oak and pine. Nearly all sorts of grain—wheat, barley, rice, maize, and huckwheat—are here and there cultivated on favourable spots; but much grain is still imported from Bengal, being obtained, as well as sugar and tobacco, in return for native cloths, rock-salt, rhubarb, Tibet goods, mules, and ponies. The religion is Buddhism, the monastic endowments of its priests absorbing a large part of the national property. The government, almost purely ecclesiastical, is in the hands of an

oligarchy. The Dherma Rajah, the nominal head, is treated rather as a god than as a sovereign; while the Deb Rajah, the actual head, is controlled in almost everything by a council of eight. Polyandry and polygamy equally conspire to keep down the numbers of the population.

BHURTPORE, the capital of the protected state of the same name in India, is a large town, measuring about eight miles in circuit, and containing, it is said, about 100,000 inhabitants, in lat. 27° 12' N., and long. 77° 33' E. It is worthy of notice chiefly on account of its two sieges in 1805 and 1825. The strength of the place lay in a mud-wall, which was practically shot-proof, and a surrounding ditch, which might at any time be filled with water from a neighbouring lake. On the first occasion, Lord Lake's assaults were all baffled by this trench thus flooded. On the second occasion, however, Lord Combermere, having arrived in time to cut off the communications of the garrison with the lake above mentioned, overcame his principal difficulty; but even then the mud-wall would yield only to mining.—2. The protected state of B. is situated in lat. 26° 48'—27° 50' N., and in long. 76° 54'—77° 49' E.—its area being estimated at 1978 square miles. The population has been assumed to average 300 to a square mile, giving a total of about 600,000. The country suffers from want of water, having only three perennial streams, of which two, however, are mere rills in the dry season; and yet, in many parts, the soil is rendered highly productive by means of irrigation. The principal crops are grain, cotton, and sugar. In the height of summer, the climate has been compared to the extreme glow of an iron-foundry, the thermometer having been known to stand at 130° F. in the shade. The rajah's revenue is stated at £170,000 a year; and his military force is said to amount to 5400 men of all arms.

BIA'FRA, **BIGHT** or, a large bay of the Atlantic Ocean, on the west coast of Africa, at the head of the Gulf of Guinea, between Cape Formosa (which divides it from the Bight of Benin) on the north, and Cape Lopez on the south. Its extreme width between these two points is nearly 600 miles, its depth, to the mouth of the Old Calabar River, about 250 miles. The northern shores of the Bight, comprehended under the general name of the Calabar coast, and the eastern coast, south of Cape St John, are low and flat. Near Old Calabar, the country becomes hilly, and opposite Fernando Po, it rises into the lofty range of the Cameroons. The principal rivers flowing into the Bight are the Niger, or Quorra, the New and Old Calabar Rivers, the Rio del Rey, the Cameroon, and the Gaboon. The creeks and estuaries of the rivers are generally lined with dense thickets of mangrove, which sometimes grow in the water, their lower branches covered with oysters. In the Bight of B. are the three islands of Fernando Po, St Thomas, and Prince's Island. The chief European stations on the coast are Duke Town, in Old Calabar, where there is a flourishing missionary station, and Naango, or George's Town, a small commercial town on the estuary of the Gaboon.

BIALYSTOK, a fortified town of Western Russia, in the government of Grodno. It is situated on the Bialy, an affluent of the Narew, 45 miles south-west of Grodno, in lat. 53° 8' N., long. 23° 18' E. B. is well built; lime-trees border several of the streets, and give it a very pleasant aspect. It has a palace and park, now belonging to the municipality, but formerly belonging to the Counts of Braniski, and called the 'Versailles of Poland,' a commodious market, and several churches. It has manufactures

of woollens, hats, leather, soap, tallow, &c. Pop. 11,467.

BIANCAVILLA, a town of Sicily, in the province of, and about 14 miles north-west of the city of Catania. It is about 10 miles distant from Mount Etna, on the south-west declivity of which mountain it is situated. It has a trade in grain, cotton, and silk. Pop. about 6000.

BIANCHINI, FRANCESCO, celebrated for his antiquarian and astronomical investigations, was born December 13, 1662, at Verona, where he received his early education in the Jesuits' College. At Padua he studied theology, mathematics, and above all, botany; and then proceeded to Rome, where he became intimate with the most distinguished savans of the day, and devoted himself to the study of jurisprudence and foreign languages. Alexander VIII. bestowed upon him a rich benefice, and Clement XI. appointed him secretary to the commission for reforming the calendar. B. was employed to draw a meridian line in the church of Santa Maria degli Angeli, in Rome, which he successfully accomplished. After travelling through France, Holland, and England, he returned to Italy, with the design of drawing a meridian line from the Adriatic to the Mediterranean like that drawn by Cassini across France. The operations connected with this project occupied him eight years; but a variety of other labours, as well as want of means, prevented its completion. Besides several memoirs and dissertations on antiquarian and astronomical subjects, we may mention his *Istoria Universale Provata coi Monumenti e Figurata coi Simboli degli Antichi* (Rome, 1694), and his fine edition of the work of Anastasius, *De Vitis Romanorum Pontificum*, which was completed by his nephew Giuseppe B. (4 vols., Rome, 1718—1734). B. died in March 1729, and a monument was erected to his memory in the cathedral of Verona.

BIARD, AUGUSTE FRANÇOIS, a French painter, known in almost every department of his art, but chiefly distinguished for his animated and often comical representations of ordinary life and manners (*peinture de genre*). B.'s merits, and the school to which he belongs, will be sufficiently understood when we mention that his countrymen have styled him the Paul de Kock of painting! He was born at Lyon in 1800, and was at first destined for the church; but subsequently educated at the School of Art of his native city. He travelled in early life in Malta, Cyprus, Syria, and Egypt, where he made sketches, and stored his memory with images which he used in after-years. In 1839, he visited Greenland and Spitzbergen, and of this journey one of the fruits was his famous picture of a battle with polar bears. The first picture which gained him distinction was his 'Bahes in the Wood' (1828); and one of his best is the 'Beggar's Family,' exhibited in 1836; both of which pictures were purchased by the town of Lyon. Many other continental galleries possess examples of B.'s pictures, and in England they have always been much sought after.

BIARRITZ, a maritime village of France, in the department of the Basses-Pyrénées, about 5 miles south-west of Bayonne. The French emperor and empress, attracted by its pleasant situation and salubrity, have, within recent years, made it a summer residence; and the presence of the court has of course tended to increase greatly the fame of its baths and singular grottoes. Pop. 1928.

BIAS, one of the seven sages of Greece, lived in the time of the Lydian king, Alyattes, and his son, Croesus, about 570 B.C. He was generally employed as a political and legal adviser in difficult questions.

At the overthrow of Croesus, when the Ionians dreaded an invasion by Cyrus, they were advised by B. to take their personal property and colonise Sardinia; but this advice was rejected, and the Ionians, after a vain defence, were subjugated by the generals of Cyrus. When the people of Priene—the birthplace of B.—were making preparations to escape from their besieged city, B., in reply to one who asked why he was not occupied like other citizens, employed the words which have become a Latin proverb, *Omnia mea mecum porto*, 'I carry all my goods with me.'—Orelli, *Opuscula Græcorum Veterum*, &c., 1819.

BIB, POUT, or WHITING POUT (*Gadus luscus* or *Morrhua lusca*), a fish of the same genus with the Cod (q. v.) and Haddock (q. v.), pretty common on many parts of the British coasts, found also on those of Norway, Sweden, Greenland, &c. It is seldom more than a foot long, but remarkably differs from all other British fishes of the same family (*Gadida*, q. v.) in the great depth of its body, which equals at least one-fourth of the entire length. The back is arched, and the nape exhibits a rather sharp ridge. The eyes and other parts of the head are invested with a singular loose membrane, which the fish can inflate at pleasure. There is a dark spot at the origin of each of the pectoral fins, as in the Whiting (q. v.). The names Bih and Pout, both originally local English names, were at one time supposed to belong to distinct species (called *G. lusca* and *G. barbata*), but it appears now to be pretty certain that these are really one. In Scotland, this fish is generally called *Brassy*. It is well known in the London market, is in best condition in November and December, and is much esteemed for the table.

BITBERACH, a town of Würtemberg, in the circle of the Danube. It is situated on the Reiss, in the charming valley of the same name, about 23 miles south-south-west of Ulm; and is surrounded by a ditch and by walls flanked with towers. It has manufactures of paper, linen, and fustians, leather, children's toys, &c. Pop. about 5000. In October 1796, Moreau won a great victory over the Austrian general Latour at B., the latter losing 4000 prisoners and 18 pieces of cannon. Here also, in 1800, Moreau again defeated the Austrian general Kray. B. fell into the possession of Baden in 1802, but four years afterwards, was ceded to Würtemberg. Wieland the poet was born in the immediate vicinity.

BITBERICH, a village in the duchy of Nassau, on the right bank of the Rhine, and about 4 miles south from Wiesbaden, is noted for its splendid palace. The views of the river-scenery from B. are unrivalled. Pop., including Mosbach, about 3000.

B'I'BIRI, B'I'BIRI BARK, AND B'I'BIRINE. See GREENHEART.

BIBLE (Gr. *Ta Biblia*, 'The Books'—see Book) is the name given by Chrysostom in the 4th c. to that collection of sacred writings recognised by Christians as the documents of their divinely revealed religion. Both as regards language and contents, they are divided into two parts—the Old and New Testament, or rather, the Old and New Covenant; for the word *testamentum* is only a translation into the later Latinity of the 2d c. of the Greek *diatheke*, 'covenant.' The history of the Old Testament is connected with that of the New by a series of writings not received by Protestants as canonical, and collectively styled the *Apocrypha* (q. v.).

The OLD TESTAMENT is a collection of 39 books, written partly in the Hebrew, and partly in the Chaldaic language, and containing all the remains



**MAP
OF THE COUNTRIES
mentioned in the
BIBLE.**

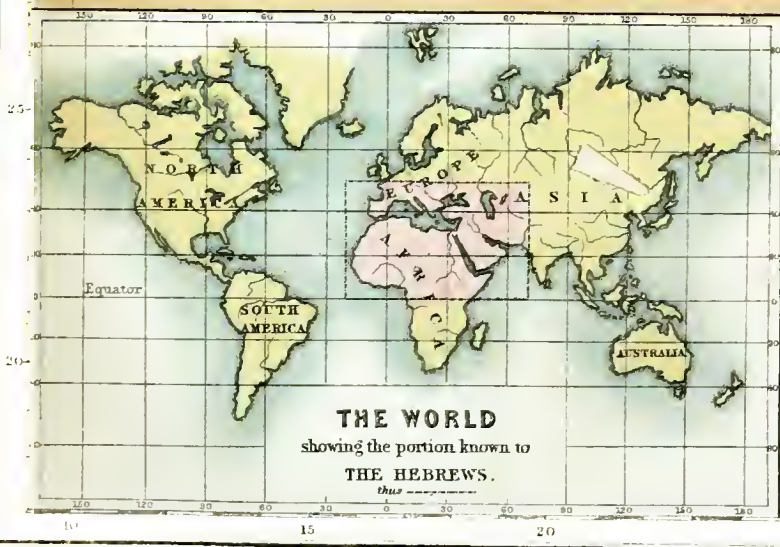

**THE WORLD
showing the portion known to
THE HEBREWS.
thus -----**



**THE
as pe
DESCEN**



of Hebrew-Chaldaic literature down to the middle of the 2d c. B. C. By an artificial arrangement under the letters of the Hebrew alphabet, the number of books has been limited among the Jews to 22. These writings were spoken of in the time of Christ as *graphé*, Scripture, or Holy Scripture, or, more distinctively, with regard to their principal contents, as 'the Law and the Prophets.' Sometimes the Psalms and the remaining holy writings (*hagiographa*) are distinctively noticed. The Law includes the Pentateuch, or the first five books. The Prophets are subdivided into earlier and later: the former—which, however, are not properly prophetic—including the books of Joshua, Judges, Samuel, and Kings; and the latter containing the three great prophets, Isaiah, Jeremiah, and Ezekiel—to whom the Christians, in accordance with the Alexandrine translation, add Daniel, as well as the minor prophets. The third division of the Old Testament includes the *hagiographa*, consisting of the books of Job, Proverbs, Psalms, the Song of Solomon, Ecclesiastes, Ruth, Lamentations, and Esther. With regard to the order of these several books, the Alexandrine translation, the Fathers of the Church, and Luther on one side, differ from the Jews; again, among the Jews, the Talmudists differ from the Masoretes, while a difference is also found between Spanish and German MSS. Hence have sprung the different arrangements of the books of the Old Testament.

The Septuagint is generally adduced in proof of the existence of these books in a collected form as early as 285 B. C., but as most scholars now doubt whether at that period more than the Pentateuch was translated into Hellenistic Greek, we cannot safely build upon such evidence. The earliest indubitable notice is found in the prologue to the Alexandrine translation of the book of Jesus Son of Sirach, written by his grandson probably about 130 B. C., and which not merely demonstrates that the Law and the Prophets then existed in a collective form, but that they must have so existed for a considerable time. His language, however, does not prove that the third division was then concluded, though neither does it disprove it. This conclusion is first definitely ascertained from the catalogue given by Josephus, who flourished after the middle of the first century of the Christian era, while Philo, who flourished 41 A. D., quotes casually from nearly the whole of them.

As regards the genuineness and authenticity of the Old Testament, there has been much discussion in modern times. The generally received opinion is, that the various books were *originally* written wholly or chiefly by the persons whose names are affixed to them, except Judges (Samuel), Ruth (Samuel), Esther (Mordecai), Kings and Chronicles (Ezra and Jeremiah), and perhaps Job (Moses?); but that these MSS. having perished in the destruction of the first temple, when Nebuchadnezzar took Jerusalem, the members of the great synagogue—which included Ezra, Nehemiah, Haggai, Zechariah, Malachi, and afterwards Simon the Just—50 years after the building of the second temple, acting in accordance with a divine commission, rewrote the Old Testament; or rather made a recension of other existing copies, to which were subsequently added the books of Ezra and Nehemiah. Thus the canon was concluded. This was the belief of the Jews themselves at a later period; the *Pirke Aboth* (Sayings of the Fathers), one of the oldest books of the Talmud, as well as other Jewish records, distinctly assert it. It is, however, simply a tradition, and though possibly true, is necessarily incapable either of demonstration or refutation. In the absence of any direct and conclusive evidence on this point, the contents of the Old Testament have been

minutely analysed by modern German critics, who have attempted to shew that they bear internal evidences of having been composed generally at a later period than is ordinarily believed. This opinion, however, has met with little acceptance out of Germany, as it is considered to be incompatible with the view of inspiration which has been, and still is, commonly held both by Jewish rabbis and Christian divines.

The Samaritans, who were at enmity with the Jews, recognised only the five books of Moses, and a corrupt version of the book of Joshua, as canonical. On the other side, the Egyptian Jews, for whom the Alexandrine version of the Old Testament was made, received as canonical several writings which were rejected, or subordinated as apocryphal (see Apocrypha), by the Jews of Palestine. The primitive church, in the period which elapsed before the canon of the New Testament was completed, referred to the Old Testament for proof of doctrines; but, on account of the prevalent ignorance of the Hebrew and Chaldee languages among the early Christians, the Alexandrine Greek version was the authority employed. As this included the apocryphal books, rejected by the Jews of Palestine, the earliest Christian Fathers made the same use of these writings as of the others; but the growth of criticism during the next two centuries was fatal to their reputation, or at least to their authority. We do not find, however, that they were formally designated 'apocryphal' until the time of Jerome (5th c.), though the Greek Church, in the previous century, had approximated to this mode of viewing them, by affirming them to be *not* canonical, but only edifying, and also by issuing lists or catalogues of those books which were recognised as canonical. In the Latin Church, on the other hand, these writings were received as canonical after the 4th c., though Jerome, Hilarius, Rufinus, and Junilius wished to distinguish them from the canonical books by the name of *libri ecclesiastici*. The Protestants, at the Reformation, returned to the distinction originally made by the Palestinian Jews between the Hebrew Scriptures of the Old Testament and the apocryphal works included in the Alexandrine version and the Latin Vulgate. Luther, in his translation of the B., included the Apocrypha as 'books not to be placed on a level with the canonical Scriptures; but profitable for reading.' The Council of Trent, which seemed to think that the only safe path for Catholicism to pursue was the exact opposite of that on which Protestantism moved, declared that whoever denied the canonical character of the Apocrypha should be *anathema*.

The NEW TESTAMENT, or the collection of canonical scriptures containing the history and doctrines of Christianity, may be divided into three chief sections: 1. The historical books, or the four gospels, and the Acts of the Apostles. 2. The didactic and pastoral writings, which include the Epistles of Paul to the Romans, Corinthians, Galatians, Ephesians, Philippians, Colossians, Thessalonians, Timothy, Titus, Philemon, the Hebrews, the two Epistles of Peter, the three epistles of John, the Epistles of James and Jude. 3. The prophetic section, consisting only of one book, the Apocalypse, or Revelation of St John the Divine. The primitive Christians referred for proof of doctrine, &c., only, so far as we are aware, to the Old Testament, and quotations from it by the apostolic Fathers are numerous enough; but we find few clear and certain references to the didactic portions of the New Testament. The reason of this appears to be, that the lapse of time had hallowed the Old Testament, and given to it that superior authority which springs from venerable age. The generation which immediately

succeeded that of the apostles—and indeed, so far as we can see, the same may be said of the apostles themselves—did not consider the apostolic writings of equal importance as *writings* with the sacred books of the Old Testament. Besides, most of the epistles were of little use in controversy, for the earliest heretics denied the apostleship of St Paul; while both parties admitted the authority of the Septuagint, and found in it their common weapons of argument. Nevertheless, we occasionally find references to the didactic portions of the New Testament, such as those to Romans, 1st Corinthians, Ephesians, Hebrews, and James, in Clemens Romanus; to 1st Corinthians and Ephesians, in Ignatius; to Romans, 1st Corinthians, 2d Corinthians, Galatians, Philippians, 1st Timothy, 2d Timothy, 1st Peter, and 1st John, in Polycarp. Still more uncertain are the references of the apostolical Fathers to the gospels. The notices found in Barnabas, Clemens Romanus, Ignatius, and Polycarp are only sufficient to indicate that all the great facts of Christ's life were known to the churches, and that the doctrinal significance of these had begun to be realised. They do not, however, demonstrate the existence of written gospels, but they prove that Christianity rests on a historic basis. Their silence in relation to the written gospels now constituting a portion of the canon of the New Testament, is at first sight singular; but when we reflect that the facts of the Saviour's life and teaching were apparently quite familiar to the churches—so familiar, indeed, that no explanation was needed in alluding to them—we see that the necessity of the apostolic fathers quoting from the Evangelists ceases. It is contended, that any specific quotations would have been a work of supererogation; whereas, in the case of the didactic epistles, which were written originally for the benefit of particular churches, and conditioned by their special circumstances, and the contents of which, therefore, could not be so well or widely known, quotations or allusions might more naturally be looked for. But evidence of this *negative* character for the existence of the evangelical records, however probable, is very uncertain, and its uncertainty is increased by the use made of writings which, at a later period, were rejected as apocryphal. First, in the second half of the 2d c., more distinct references to the gospels are found in Papias (died 163), in Justin Martyr (died 166 A.D.), in his pupil Tatian (died 176), in Athenagoras (died 180), and in Theophilus, who wrote about the year 180. None of these writers, however, name the authors from whom they quote, though Papias—the earliest, but not the most trustworthy of them—bears direct and minute testimony to the existence of gospels by St Matthew, St Mark, St John, the catholic epistles, and the Apocalypse, whence it has been concluded that the authenticity of the apostolic memoirs was not then settled, and perhaps not even investigated; but anonymous quotation seems to have been a characteristic carelessness of the time, for of this kind are 117 of Justin Martyr's references to the Old Testament. The great fact on which a constructive Christian criticism leans in regard to the evidence of these writers is, that they do not speak of the gospels or apostolic memoirs as things which had only recently made their appearance, but as well known and long established. Justin even states that the 'apostolic memoirs' were regularly read in the churches for the edification of believers—a fact which clearly indicates their superior sanctity and universal reception. The Tübingen school contend, that these apostolic memoirs could not have been the canonical gospels, but must rather have been the primitive evangelical

records out of which the canonical gospels were formed; but this opinion appears to be utterly untenable, when we remember that only twenty or thirty years can be allowed for the transmutations to take place in, and that the churches must have silently consented to the change, for there is no murmur of complaint or hint of opposition expressed in the whole history of the time.

Nevertheless, the idea of a strict and pure New Testament canon (see CANON) is not discernible in the church in Justin Martyr's time. There is no positive evidence in favour of its existence; but this is not to be wondered at, for the consciousness of freedom in the Holy Spirit, which penetrated the Christians of the 1st c.; the opposition of what in continental theology are termed the Petrine and Pauline (q. v.), i. e., the Judaising and anti-Judaising parties, which does unquestionably appear to have existed, though not in that exaggerated form in which it is apprehended by the Tübingen school, who consider it an unanswerable proof of the non-existence at the time of a catholic church; the still living tradition of the apostles; the difficulty of diffusing apostolic writings sent only to particular churches; the absence of criticism; the vacillation in determining the point where the apostolic men ceased; the use in the worship of God of the Old Testament, and, in particular churches, of casual Christian writings, not now looked upon as canonical: all these causes together operated in hindering, till the middle of the 2d c., a formal collection of New Testament writings of any compass or critical value, though it seems quite clear that they existed separately, and were regarded as the most authoritative records of the new dispensation. The earliest trace of such a collection (the ten Pauline epistles without the pastoral epistles) appears after the middle of the 2d c., in opposition to that gnostic perversion of primitive Christianity which had been introduced by Marcion of Pontus. In the close of the 2d, and in the beginning of the 3d c., Irenæus, Clemens Alexandrinus, and Tertullian bear testimony to the recognition of the four gospels, the Acts of the Apostles, the thirteen Pauline epistles, the 1st Epistle of Peter, the 1st Epistle of John, and the Apocalypse, as canonical writings. But they do even more than bear testimony to their recognition—they appeal to antiquity for proof of the authenticity of the books which they used as Christian Scriptures. On this point, Tertullian is especially precise, and his most convincing argument on behalf of the 'surety of the gospels' is, that 'the very heretics bear witness to them.' They did not, it is admitted, acknowledge the whole of the New Testament canon, but this is explicable on the hypothesis, which is justified by investigation, that the portions rejected were those that seemed alien to their own opinions. Two distinct collections of writings are now noticed—the *Instrumentum Evangelicum*, containing the four gospels; and the *Instrumentum Apostolicum*, containing the Acts of the Apostles, along with the Pauline and other epistles. Respecting several parts of the New Testament canon, differences of opinion prevailed in early times, nor was the war of criticism closed until the 6th c., for considerable difference of opinion existed in regard to the value of the testimony of the early apologetic authors. Origen doubted the authority of the Epistle to the Hebrews, of the Epistle of James, of Jude, of the 2d of Peter, and the 2d and 3d of John; while, at the same time, he was disposed to recognise as canonical certain apocryphal scriptures, such as those of Hermas and Barnabas, which were decidedly rejected by the Church. The Apocalypse was treated as a dubious part of the canon down to the 7th c. The learned and

circumspect Father, Eusebius, in the 4th c., in a passage of his *Church History*, distinguishes three classes of New Testament scriptures: 1. Universally recognised scriptures (*homologoumena*), the four gospels, the Acts of the Apostles, the fourteen Pauline epistles, the 1st Epistle of John, and the 1st of Peter. 2. Scripture not universally recognised (*antilegomena* or *notha*), including the Epistles of James and Jude, two Epistles (2d and 3d) of John, the 2d of Peter, and the Apocalypse of John; also the Acts of Paul (afterwards universally rejected), the Book of the Shepherd (Hermas), the Revelation of Peter, the Epistle of Barnabas, the Doctrines of the Apostles, and the Gospel of the Hebrews. 3. Absurd and heretical scriptures.

The Western Church, which was more conservative and less critical than the Eastern Church, completed the canon with greater rapidity. Although the eastern Council of Laodicea (360—364), in determining the canon of the New Testament, excluded the Apocalypse, the western synods of Hippo-Regius (393), Carthage (397), the Roman bishop, Innocent I. (in the beginning of the 5th c.), and the *Concilium Romanum* under Gelasius I. (494), recognised the entire canon of the New Testament as we find it in the present day. The doubts entertained by individuals respecting some parts of the canon had become exceptional and unimportant at the close of the 7th c. Owing to the want of Greek scholarship, as also, perhaps, to the growing idea of an infallible church papacy, there was no criticism worthy of the name during the middle ages. Doubts, therefore, respecting the Epistle to the Hebrews and the Epistles of James and Jude were first revived, after a long quietude, at the time of the Reformation. Luther himself ventured to declare the Epistle to the Hebrews and the Apocalypse 'apocryphal.' The spirit of orthodox dulness which ruled the Protestant Church from the latter part of the 16th to the middle of the 18th c., had a deadening effect on true biblical criticism. This was first revived by a liberal Catholic writer, Richard Simon (died 1712), who first conceived the plan of 'an historic-critical introduction' to the B.; afterwards, the labours of Lowth, Semler, Herder, Griesbach, Michaelis, Eichhorn, and others, gave a new impulse to scriptural exegesis. In Germany, we may name among writers on the conservative and orthodox side, the Catholic divines, Jahn and Hug, with the Protestant writers, Hengstenberg, Hävernick, Guerike, Delitzsch, and Caspari: on the other side, Berthold, De Wette, Credner, Reuss; and since the publication of the *Life of Jesus* by Strauss, the 'New Tübingen school,' with F. Baur (q. v.) at its head, has questioned the authenticity and apostolical antiquity of all the New Testament scriptures, except the four larger Epistles of Paul—to the Romans, the Corinthians (1st and 2d), and the Galatians; while recently, Bruno Bauer (q. v.) has even denied the authenticity of the Epistle to the Galatians. The German controversy respecting the New Testament canon—one class of critics asserting that the majority of the New Testament scriptures were written (in their present form) after the middle of the 2d c.; the opposite class ascribing to these scriptures an apostolic origin—still remains in agitation; but, excluding the 'Tübingen' and 'Young Hegelian' schools of criticism, it may be asserted that a majority of the biblical critics of Germany now recognise the substantial authenticity of the whole New Testament canon, except the 2d Epistle of Peter, leaving, however, at the same time, a wide margin for supplementary interpolations, both in the Old and New Testaments.

But, as might have been expected, the effects of the

strife could not always remain confined to Germany. They have been felt more or less over all Protestant countries; and even Catholic France, which has no theology to contend for, shews the influence of the new movement in those departments of art and science which are most nearly allied to theology. In England, during the 18th c., several valuable apologetic works were published, such as Lardner's *Credibility of the Gospel History*, and Paley's *Horæ Paulinæ*. In the early part of the 19th c. appeared Horne's *Introduction to the Study of the Scriptures*, which has been frequently reprinted. Since then, Tregelles, Davidson, Westcott, and numerous other scholars, have entered the field; and it is not too much to affirm, that, at least among the higher, more philosophic, and more earnest class of British theologians, there exists at this moment a keener spirit of impartial inquiry, as regards the foundations of biblical criticism, than Britain has ever previously witnessed. The practical tendencies of the Anglo-Saxon mind long restrained it from interfering in what seemed to be a mere maze of unprofitable speculation; but now that its deep and vital relations to the groundwork of men's actual and possible beliefs have begun to be felt, these same practical tendencies are manifestly asserting themselves, and we may confidently anticipate that a large measure of attention on the part both of the clergy and laity will soon be given to this most important of all branches of knowledge.

EDITIONS OF THE BIBLE: HISTORY OF THE TEXT.—As both the Old and the New Testament were written in ancient languages, and transcribed in times when philological criticism hardly existed, the examination and comparison of various editions, with a view to obtain the greatest possible purity of text, forms an important part of theological study.

Text of the Old Testament.—The first duty of an impartial critic of this question is to lay aside both of the extreme and untenable opinions regarding the Hebrew text of the Old Testament, viz.—1st, that it has come down to us in an absolutely faultless condition, by miraculous preservation; and 2d, that it has been wilfully and unscrupulously falsified by the Jews. That there are erroneous readings, nobody doubts. The real task devolving on a student of this branch of the theological science is to explain these on natural principles, and by collating the various recensions, to endeavour to obtain a pure text, or as close an approximation to that as may be possible. The following is a tolerably complete classification of the causes of errors. 1. Errors arising from *imperfect sight* or *occasional inattentiveness*; as when transcribers substituted one letter for another similar in appearance, transposed letters, words, and sentences, and omitted the same; of which there are various examples. 2. Errors arising from *imperfect hearing*, of which there are not many examples. 3. Errors arising from *defective memory*; as when a transcriber fancied that he knew certain words, phrases, or clauses, on account of their having occurred before; of these there are occasional examples. 4. Errors arising from *defective judgment*; as when words were wrongly divided, or abbreviations wrongly resolved; also from the *custodes linearum* (i. e., the letters which filled up the occasional vacant space at the end of lines) and marginal remarks being sometimes incorporated with the text. These not unfrequently happen. 5. Errors arising from a *well-meant desire* on the part of the transcriber to explain or amend a text, really or apparently obscure. In this respect the Samaritans are greatly to blame. See SAMARITAN VERSION OF THE PENTATEUCH. A very knotty point is, the condition of the text before and at the close of the canon. The opinion of Eichhorn, De

Wette, and others is, that while the books circulated singly in a sphere of uncertain authority, they were greatly corrupted; in support of which, considerable evidence is adduced, but still the probabilities are, on the whole, against such a supposition, and it is better to suppose that the conflicting accounts of the same events which are to be met with, especially in the historical books, arise not from the carelessness or corruptions of copyists, but rather from the original authors or compilers having consulted different documents.

From recent investigations, it appears clear that the strict dogmatic Jews of Palestine and Babylon were generally far more careful in their preservation of sacred records than the Samaritans and the Alexandrines, the latter of whom were remarkable for their free, philosophising, non-textual spirit. In the schools of learning in Jerusalem at the time of Christ, presided over by Hillel, who had come from Babylon, and Shammai, and in those which flourished elsewhere in Palestine, after the fall of the metropolis, for instance, at Lydda, Cæsarea, Tiberias, &c., as also in the academies of Sora, Pumpedita, and Nahardea, near the Euphrates, at a later period, the text of the Old Testament was defined with great care, first by the Talmudists, who seem to have adhered very closely to the ancient text, and after the completion of the Talmud at the close of the 5th c. by the *Masorites*. See MASORA. This care was at first bestowed only on the consonants of the Hebrew text. The Masoretic vowel system, which sprang from that already existing among the Syrians and Arabians, was developed from the 7th to the 10th centuries at Tiberias. By the 11th c. it appears to have been completed, while the Spanish rabbis of the next century seem ignorant of its then recent origin (Davidson's *Text of the Old Testament Considered*, Lond. 1856). After the 11th c., the Masoretic text, with its perfected system of vowels and accents, became the standard authority among Jewish scholars. The comparative values of the different readings in the various MSS., had by that time been carefully determined, and the chief business of copyists, henceforth, was to make faithful transcripts.

The earliest printed editions of the Hebrew B. bear a close resemblance to the MSS. 'They are without titles at the commencement, have appendices, are printed on parchment with broad margin, and large ill-shaped type, the *initial* letters being commonly ornamented either with wood-cut engravings or by the pen. These letters, however, are often absent. With vowels, the editions in question are very imperfectly supplied. Separate parts of the B. were first printed.¹ The Psalms appeared in 1477, probably at Bologna; the Pentateuch at Bologna in 1482; the Prophets in 1486; the Hagiographa in 1487. To most of these were subjoined the rabbinical commentary of Kimchi. The whole of the Old Testament appeared in small folio at Soncino, 1488, and appears to have been followed by the edition of Brescia (1494), which was used by Luther in his translation of the Old Testament. The *Biblia Polyglotta Complutensia* (1514—1517), the *Biblia Rabbinnica* of Bomberg, edited by Rabbi Jacob-Ben-Chayim (Venice, 1525—1526), which has been adopted in most of the subsequent editions—the Antwerp *Biblia Polyglotta* (8 vols., 1569—1572), also the editions by Hutterus (Hamburg, 1587, and frequently reprinted), Buxtorf (Basel, 1611), and especially that by Jos. Athias (Amsterdam, 1661—1667)—all these are celebrated, and have supplied the basis of later editions by Simon, Hahn, Theile, and others. In the 17th c., a vehement controversy arose regarding the integrity of the Hebrew text; one party maintained that the Masoretic text was

greatly corrupted, and contrasted it unfavourably with that of the Samaritan Pentateuch. The chief advocates of this view were Vossius, Whiston, Morin, and Capellus. On the other hand, Buxtorf, Arnold Bootius, Wasmuth, and others, defended the absolute purity of the Masoretic text, even to the inspiration of the vowel-points, which Buxtorf, in the preface to his grandfather's *Tiberias*, gravely asserts to have been first invented by Ezra. This controversy had at least one good result. It led to an extensive examination of Hebrew MSS. in the next century. Kennicott collected 630, 258 throughout, the rest in part; De Rossi, 751, of which all but 17 were collated for the first time. Many still remain uncollated. The result of this elaborate investigation has been to convince scholars that the Masoretic text is substantially correct. All known codices confirm it; the oldest of the professedly literal versions, as well as the Targums of the time of Christ, furnish similar satisfactory evidence; and when we consider the *bibliolatrous* tendencies of the Jews after their return from exile, whatever may have been the case before, we may safely conclude that we now possess the text of the Old Testament much in the same condition as it was at the close of the canon.

At first, there were no intervening spaces between Hebrew words; afterwards, small intervals appear to have been occasionally allowed. With the introduction of the *square* character, the use of small interstices to separate words became general. The Talmud prescribes how much space should be between words in sacred MSS. designed for the synagogue. Various divisions according to the sense were also introduced at an early period. In the Pentateuch there were two, termed respectively *open* and *closed*. The former were intended to mark a change in the matter of the text; the latter, slight changes in the sense. Of these, the Pentateuch contained 669, named *perashioth* (sections). This division is probably as old, or nearly so, as the practice of reading the Law. It is found in the Talmud, while the division into 54 *great perashioth* is first found in the Masora, and is not observed in the rolls of the synagogues. The poetical books were also subjected, from a very early period, to a stichometrical division, according to the peculiarities of Hebrew versification. In order to facilitate the reading and understanding of the prose books, a division into logical periods was also made, which is mentioned in the Mishna, while in the Gemara its authorship is ascribed to Moses. From it sprang our present division of the Scriptures into verses. It is highly probable that these divisions were long handed down orally. Our present division of the Old Testament into chapters is a later invention, and, though accepted by the Jews, is of Christian origin: it may be dated as far back as the 13th c., some assigning it to Cardinal Hugo, others to Stephen Langton, Archbishop of Canterbury. It was first employed in a concordance to the Vulgate, whence it was borrowed by Rabbin Nathan in the 15th c., who made a similar concordance to the Hebrew Bible. Nathan's divisions are found in Bomberg's Hebrew B. of 1518. Verses were first introduced into editions of the Hebrew B. by Athias of Amsterdam, 1661, but were employed in the Vulgate as early as 1558. The first *English B.* divided into verses was published at Geneva in 1560.

New Testament.—The original MSS. of the New Testament were probably all written on papyrus, the cheapest, but least durable material that could be obtained for the purpose. It was therefore impossible, considering the constant handling to which the documents must have been subjected by the

eager converts, that they could have lasted for any length of time. Indeed no authentic notices of them have come down to us, but we know that a very large number of copies were in existence from an early period. Norton states the number at about 40,000. The text of these, however, did not always agree. Variations originated, to a considerable extent, from the same causes as operated in the case of the Old Testament, viz., imperfect vision or hearing, misunderstanding, carelessness, or an uncritical judgment on the part of transcribers; but it is natural to suppose that, on account of the greater freedom of spirit and thought which characterised primitive Christianity, compared with Judaism, a latitude of conviction in regard to the value of the *letter* of Scripture, also influenced the churches. The *idea* of inspiration (q. v.), it is now admitted by the most enlightened theologians, was progressively developed. In the earliest ages it did not exist in any dogmatic form whatever. Christians were content to believe that the evangelists and apostles spoke *truth*, by the help of the Holy Spirit, without perplexing themselves with the question, whether the words were purely divine or purely human in their origin. They had a gospel to preach, and a world to convert, and were therefore not in a mood to discuss mechanical notions. This also must have operated in producing the textual variations referred to, many of which are of such a nature as to clearly prove that the commentators or transcribers thought themselves at liberty to alter, or improve the expression. Nor must we overlook the fact, that the different culture and tendencies of the Eastern and Western Churches also caused very considerable changes. Modern criticism reckons no less than 80,000 variations in the existing MSS. Nevertheless, one fact stands out, solid and imperishable, amid all the tiny fluctuations of verbal criticism, viz., that, with one or two exceptions, no material difference exists, or in all probability ever did exist, in New Testament MSS. The general Christian consciousness, which was the real guardian of their integrity, had been grounded too deeply in the facts, doctrines, and ethics of a historic Christianity to follow in the wake of sectarian or heretical modifications of the truth. It instinctively turned, as it were, from a sense of affinity to those apostolic records, the tone of which most closely corresponded to its own spiritual character and development, and thus unconsciously prevented any incongruous changes from being effected in the mass of MSS. Of these MSS., upwards of 1400 are known to scholars, and have been collated, and no essential discrepancy has been detected. Of course, it can be urged that all the MSS. belong to a period when the Church had gathered itself up into two great wholes—the Latin and Greek, and when, therefore, a general conformity in MSS., as in other things, is only to be expected; but the fragments which are found in the earliest Church Fathers exhibit substantially, though not verbally, the same text, and we may therefore fairly infer that this unintentional harmony in part argues the general harmony of the earlier and later MSS.

Some slight attempts seem to have been made, during the early history of the Church, to obtain a correct text. One Lucian, a presbyter of Antioch, and Hesychius, an Egyptian bishop, are said by Jerome to have undertaken a recension of the New Testament, and both Origen and Jerome himself were of considerable service in this respect. It is to modern criticism, however, that we owe almost everything in regard to the regulation of the text. Bengel and Semler first started the idea of arranging the MSS. of the New Testament into *families* or

classes. After these came Griesbach, who, following out the idea, propounded his famous threefold division of the MSS. into Western, Alexandrian, and Byzantine. The first two he considers the oldest; the third, a corrupt mixture of both. Griesbach himself preferred the Alexandrian: he believed that the Byzantine transcribers had taken great liberties with the text, and held that a few Alexandrian MSS. outweighed, in critical value, a large number of the other. The accuracy of Griesbach's division has subsequently been questioned by many eminent German scholars, among whom may be mentioned Hug, Matthiæ, Scholz, and Eichhorn, each of whom has in turn favoured the world with a theory of his own in regard to the probable value of the various families of MSS. Recently, Lachmann has applied, with excessive strictness, a principle first hinted by Bentley, viz., that no weight ought to be attached to any MSS. except those written in the old or uncial (q. v.) character. The chief advocate for the application of this principle in England is Tregelles; but it is rejected by the vast majority of biblical scholars, for the simple reason, that a MS. of the 10th or 11th c., if faithful to that from which it is copied (a thing not impossible), may exhibit a really older and purer text than one of the 4th or 5th c. Impressed with this fact, Tischendorf, the latest, and, in the opinion of many, the most judicious editor of the Greek Testament, has attempted to combine whatever is sound in Lachmann's plan with a discriminative use of later MSS.

The whole of the New Testament was first printed in the Complutensian Polyglott, 1514. From 1516 to 1535, five editions appeared at Basel, under the care of Erasmus, but without any great pretensions to critical accuracy. The subsequent numerous editions were, for the most part, either founded on the editions of Erasmus or on the Complutensian, or on a collation of both. Among these editions we may mention that by Colonii (Paris, 1534), by Bogard (Paris, 1543), the third by the elder Stephens (1550), and that by the younger Stephens (Geneva, 1569). Beza was the first who, by several collations founded on the third edition by Stephens, made any considerable progress in the critical treatment of the text, and thus supplied a basis for the present received text (*textus receptus*), which was first printed by Stephens with the Vulgate and critical annotations at Geneva, 1565; afterwards was frequently reprinted by Elzevir (Leyden, 1624) and others. The labours of the English scholar, Walton, in the London Polyglott (1657), of Fell (Oxford, 1675), and especially Mill (Oxford, 1707), were of great importance for the criticism of the New Testament. Bengel exhibited great tact and acumen in his edition of 1734. Wetstein much industry and care in the editions of 1751—1752, as also Semler, 1764. But all these recensions were surpassed in value by the labours of Griesbach (1774). The more recent contributions to the criticism of the New Testament by Scholz, the *Lucubratio Critica* (Basel, 1830), and the critical edition by Rink (2 vols., Leip. 1830—1836), the edition by Lachmann, with especial use of oriental MSS., and, subsequently, the labours of Buttmann (1842—1850) and Tischendorf (1841 and 1850), are also worthy of high praise.

Among the MSS. of the New Testament, the oldest are not traced back further than the 4th c., and are written in the so-called *uncial* characters. The modern MSS., dating from the 10th c. downwards, are distinguished by the *curious* characters in which they are written. The most important MSS. are the *Codex Alexandrinus* (in the British Museum), *C. Vaticanus* (in the Vatican at Rome), *C. Ephræmi* (in the Imperial Library

at Paris—a fac-simile of which was edited by Tischendorf, Leip. 1843), and *C. Cantabrigiensis*, or *C. Beza* (given by Beza to the university of Cambridge, a fac-simile being issued by Th. Kipling, 1793). Of these, the *Codex Vaticanus* is considered to be the oldest, but Tischendorf has recently brought before the notice of biblical scholars a Sinaitic MS., which he believes to belong, 'beyond a doubt, to the first half of the 4th c., and to be, therefore, the oldest now extant in the world.' The point is still in dispute among German critics. The publication of this MS. is expected soon. A fac-simile of the *Codex Vaticanus*, edited by Cardinal Mai, was published at Rome in 1858.

The earliest division of the New Testament into verses of which we read is that made by Euthalius, Deacon of Alexandria, 462 A.D. He arranged those words that were related to each other by the sense into *stichoi* or lines. Subsequently, to save space, a colon or point was substituted, until, finally, a complete system of punctuation arose. In the 13th c., as we have already seen, the division into chapters took place, and in the 16th the versicular division was perfected by Stephens. The arguments or contents prefixed to the several chapters are also of modern origin.

B. Versions or Translations.—These may be divided into ancient and modern. The *ancient translations* of the Old Testament from the original Hebrew may be classed as follows: 1. *Greek.*—The earliest of these is the Alexandrine or Septuagint (q. v.), after which come respectively the translations by Aquila (q. v.), Theodotion (q. v.), and Symmachus (q. v.). The whole of these, with fragments of others by unknown authors, were given by Origen in his *Hexapla* (q. v.). The *Versio Veneta*, a Greek translation of several books of the Old Testament, made in the 14th c., and preserved in the St Mark's Library, Venice, was published by Villoison at Strasburg, in 1784. Several early versions were also based on the Septuagint; but for that reason do not possess an independent value, being for the most part simply translations of a translation. Among these may be mentioned the old Latin version or *Italic* (q. v.), improved by Jerome (382 A.D.); the Syriac, including the *Versio Figurata*, made some time before Christ, but only partially preserved and collated by Jacob of Edessa, in the beginning of the 8th c.; and that by Paul, Bishop of Tela (617 A.D.); the *Ethiopic*, made by certain Christians in the 4th c.; the *duplex Egyptian* (3d or 4th c.), the one being in the language of Lower Egypt, and termed the *Coptic* or *Memphitic*, and the other in the language of Upper Egypt, and termed the *Sahidic* or *Thebæic*; the *Armenian*, by Miesrob and his pupils in the 5th c.; the *Georgian*, of the 6th c.; the *Slavonian*, commonly ascribed, but for unsatisfactory reasons, to the missionaries Methodius and Cyrillus in the 9th c.; *lastly*, several Arabic translations of the 10th and 11th centuries.—2. The *Chaldaic translations* or *Targums*. These had an early origin; but, with the exception of those of Onkelos and Ben Uzziel, are unsatisfactory in a critical point of view. See TARGUM.—3. The remarkably literal translation into the Aramaic dialect of the later Samaritans, of the ancient copy of the Pentateuch, possessed by the Samaritans, and supposed to be derived from MSS. in use among the Israelites in the days of Rehoboam. It is of unknown age and authorship, but certainly older than the 3d c. after Christ. The later Samaritans conceived Nathanael, the high-priest, to be the author (20 B. C.), while Gesenius considers it to have been executed shortly after the time of Christ.—4. The Church translation, known as the *Peshito* ('true or literal'), received by all the Syriac

Christians. It originally included only the canon of the Old Testament, and was probably the work of some Christian author or authors—though Simon, Frankel, and others maintain that the Pentateuch must have been translated by a Jew—living near the close of the 2d c. It was undoubtedly executed from the original Hebrew text, to which it closely adheres. Several Arabic versions were founded on the *Peshito*.—5. The later Arabic versions, executed during the middle ages, partly from the Hebrew text, and partly from the Samaritan Pentateuch.—6. The Persian translation of the Pentateuch, made by a Jew named Jacob, not earlier than the 9th c.—7. The Latin Vulgate (q. v.).

Among ancient versions of the New Testament we may notice three in Syriac: the first is the *Peshito*, with a twofold secondary translation of the four gospels into Arabic and Persian. It does not, however, contain 2d Peter, 2d and 3d John, Jude, or the Apocalypse, which, at a later period, were classed among the *antilegomena*, or disputed books. The second, or *Philoxenian*, prepared, in 508, under the direction of Philoxenus, Bishop of Hierapolis. It no longer exists, but a counterpart of it does, in the translation made in the following century (616 A.D.) by Thomas of Harkel or Heraclea, the successor of Philoxenus. The best MS. of this version is one which belonged to Ridley, and is now in the archives of the New College, Oxford. It includes all the books of the New Testament excepting the Apocalypse. The style is slavishly literal. It was edited by White, Oxford, 1778. The third, or Jerusalem-Syriac version, preserved in a Vatican MS. of 1030, but which is probably a copy from an older version of the 7th c. With the above Syriac versions we may class the Ethiopic translation; the Egyptian duplex version, made probably in the latter part of the 3d c., and of considerable critical value; the Armenian, Georgian, Persian, and Coptic-Arabic. Besides these may be mentioned the old Italic; the Vulgate by Jerome; the Gothic translation by the Arian Bishop Ulfilas (about the middle of the 4th c.), of which the most famous MS. is preserved in the library of Upsal, in Sweden (this has only the four gospels, and not even these in perfect condition); the various Anglo-Saxon versions of parts of Scripture, which seem to have been executed during the years 709—995 A.D.; and the Slavonic.

Modern Translations.—During the middle ages, when the laity were considered by the priesthood unfit to be intrusted with the B. as a whole, various poetical versions—such as the Gospel History, by Otfried von Weissenburg, and the version of Job and of the Psalms by Notker-Labeo (980 A.D.)—served a very important object, and stimulated the desire for more biblical information. As early as 1170, Petrus Waldus caused the New Testament to be translated into the Provençal dialect by Etienne d'Anse. This important work was followed by the translations made under Louis the Pious (1227) and Charles the Wise (1380), the B. Histories (*Bible ystoriques*) by Guyars of Moulins (1286), the Spanish version under Alfonso V. in the 13th c., the English by Wickliffe, and the Bohemian version of John Huss. After the invention of printing—especially after the latter part of the 15th c.—the harbingers of a new ecclesiastical era appeared in numerous republications of the translated B.—the Bohemian (Prague, 1448); the Italian, by the Benedictine Nic. Malherbi (1471); the French, by Des Moulins (1477—1546); the Dutch (Delf, 1477); the Spanish (1478—1515); but, above all, in the seventeen German translations before Luther, of which five were printed before 1477, and the remainder in the Low-German dialect during 1477—1518.

Luther's translation of the B. is universally esteemed by the best German scholars as a masterpiece of genial interpretation. It displays qualities far superior to those ordinarily expected in a translation—deep insight, true sympathy with the tone of the Hebrew Scriptures, and a perfect command of clear, popular language; indeed, every one who can thoroughly appreciate the merits of this great work, will be ready to excuse the boldness of the assertion, that 'it was rather a re-writing than a mere translation of the B.,' a transfusion of the original spirit into a new language, rather than a mere version of the letter. The New Testament was finished by Luther at Wartburg, and appeared in September 1522. In the following year, the five books of Moses appeared; and, in 1534, the remaining part of the Old Testament canon was completed along with the Apocrypha. With wonderful rapidity, this translation was circulated throughout Germany. In the course of forty years, one bookseller, Hans Luft of Wittenberg, sold 100,000 copies; an astonishing number, when we consider the price of books in the 16th c. It was reprinted thirty-eight times in Germany before 1559, and meanwhile, the New Testament had been separately printed in seventy-two editions. Numerous other translations in Dutch, Swedish, &c., were based upon the work of Luther.

English Translations of the Bible.—England was very late in commencing to print even portions of Scripture. Long after Germany, France, Spain, Italy, Holland, and other countries, had issued vernacular versions of the B., that land continued to sit in darkness. The earliest attempt was a translation of the *seven penitential psalms* in 1505. No doubt, a very considerable number of MSS. circulated among the people; but still we may well ask: 'What were these among so many?' Such a question the noble martyr, William Tyndale (q. v.), seems to have put to himself, and bravely he answered it, vowing that 'if God would spare his life, ere many years he would cause the boy who driveth the plough to know more of the Scriptures than did all the priests.' To accomplish his purpose, he passed over to the continent. Before 1526, he had completed an English translation of the New Testament, which appeared both in quarto and duodecimo. In the beginning of 1526, the volumes were secretly conveyed into England, where they were bought up and burned, which, however, only stimulated Tyndale to greater exertions. Of the admirable character of his translation, we have a sufficient testimony in this fact, that in our present version a very large portion of the New Testament is taken almost *verbatim* from Tyndale's Testament. Tyndale next proceeded to prepare a version of the Old Testament out of the original Hebrew, and in 1530, he published the Pentateuch, and in the following year, the book of Jonah. The first English version of the whole B. was that published by Miles Coverdale, a friend of Tyndale. It is dated 1535, and dedicated to Henry VIII., but where printed, is unknown. It is much inferior to Tyndale's. The next English B. issued was called *Matthew's B.*, from the circumstance that the editor assumed the name of Thomas Matthew, but was simply Tyndale's version revised by his friend John Rogers, who also translated those books in the Old Testament which the martyr had not been able to overtake. It was finished in 1537, and Cranmer obtained for it the patronage of Henry, though that monarch had persecuted Tyndale some years before. Matthew's B. soon superseded Coverdale's. In April 1539 appeared the *Great B.*, usually called Cranmer's, because he wrote a preface to it. It was a large volume for use in churches. The text was Tyndale's revised. In the same year, Richard Taverner, a learned but eccentric

layman belonging to the Inner Temple, published an edition, the text of which is based on that of Matthew's Bible. In 1557 appeared the famous *Geneva B.*, so called because the translation was executed there by several English divines, who had fled from the persecutions of the bloody Mary. Among these may be mentioned Gilby and Whittingham. This edition—the first printed in Roman letter and divided into verses—was accompanied by notes, which shewed a strong leaning to the views of Calvin and Beza. It was, in consequence, long the favourite version of the English Puritans and the Scotch Presbyterians. It is, however, best known as the *Breeches B.*, on account of the rendering of Genesis iii. 7: 'Then the eyes of them both were opened, and they knew that they were naked, and they sewed fig-tree leaves together, and made themselves breeches.' In 1568, the *Bishops' B.* was published at London. The text of this was compared with the original by eight bishops, and several other scholars of reputation, who appended their initials to their respective tasks; the whole being under the superintendence of Matthew Parker, Archbishop of Canterbury. In 1582 appeared at Rheims, in France, an English version of the New Testament, prepared by several Roman Catholic exiles; and in 1609—1610, a similar version of the Old Testament at Douay. Both were taken from the Vulgate, and form the standard English Scriptures of the Roman Catholics, being generally known as the *Douay Bible*.

We now come to the version which has been in common use for nearly 250 years, generally called *King James's Bible*. At the Hampton Court Conference in January 1604, Dr Rainolds, an eminent Puritan, suggested a new translation as a great national want; and this, though opposed by the Bishop of London, was sanctioned by the king. Arrangements were at once made for carrying out the project. In July, the king wrote a letter, intimating the appointment of 54 scholars for the preparation of the version, and instructing the bishops that whenever 'a living of twenty pounds' became vacant, they should inform his majesty of the circumstance, in order that he might recommend one of the translators to the patron. This was all that James did on behalf of the translation which bears his name. The expenses seem to have been borne by Barker, the printer and patentee, who paid the sum of £3500. Of the 54 scholars who had been nominated to the work, only 47 undertook it. These were divided into six companies, two of which were to meet at Westminster, two at Cambridge, and two at Oxford. The *first* company at Westminster translated the Pentateuch and the historical books to the end of 2d Kings; the *first* at Cambridge, from the beginning of Chronicles to the end of Canticles; and the *first* at Oxford undertook the remaining books of the Old Testament canon. The second company at Westminster translated the apostolic epistles; the second at Cambridge, the Apocrypha; and the second at Oxford, the gospels, the Acts of the Apostles, and the Apocalypse. According to Selden, 'they then met together, and one read the translation, the rest holding in their hands some B., either of the learned tongues, or French, Spanish, Italian, &c. If they found any fault, they spoke; if not, he read on.' When a portion was finished by one of the company, it was sent to all the others in succession for their deliberative examination; and whenever a difference of opinion was elicited, reference was made to a committee. The final revision of the whole was conducted in London by two delegates from each of the six companies. These twelve scholars, in the discharge of their critical functions, met daily

in the old hall of the Stationers' Company for nine months. The work of translation and revision occupied from 1607 to 1610. The superiority of the authorised version soon proved itself; for though there were several rivals in the field, and no steps were taken to secure for it a preference, it quickly gained the foremost place, and in the course of forty years from its publication, all others had quietly succumbed to it; it became, and has ever since remained the *English Bible*. Its ascendancy, and its exclusive use among all classes in Great Britain, and in her vast colonies, can only be traced to its intrinsic excellence. Of late, however, there has been an agitation for the preparation of a new English version.

The exclusive right to print the present authorised version has been claimed by the Crown, ever since the date of its first publication, and under this royal prerogative, the B. is printed in different forms, and sold wholesale by certain patentees and licensees in England, Scotland, and Ireland. This claim, which does not practically affect Bibles with notes, has lately been much remonstrated against as a monopoly injurious to the free circulation of the Scriptures at a moderate price, and a modification is now looked for (see BOOK TRADE).

The more liberal Catholics—especially the Jansenists De Sacy, Arnauld, and Nicole; the enlightened Richard Simon and Quesnel—also shared in the common zeal for diffusing a knowledge of the Scriptures; but though many versions have been prepared by Catholics, the Romish Church has consistently maintained an opposition to the general circulation of Holy Scripture without ecclesiastical comments.

The numerous recent translations of the Scriptures into languages beyond the pale of Christendom, have been executed chiefly under the auspices of Missionary and Bible Societies (q. v.).

As to the *contents* of the B., its one grand object, under whatever form it may appear in the various books, is, to give an account of this world, both in its origin and government, as the work of an Almighty Creator, always and everywhere present; and especially to exhibit the relation of man to this Creator, and, in consequence of that relation, in what manner, and with what hopes he ought to live and die—subjects undeniably the most momentous that can occupy human thought. The sacred books of other religions have all an analogous aim; to account, namely, for the origin of all things, and to explain the nature and human relations of that something *divine*, which it is an instinct of the human mind to conceive as actuating and controlling all that moves. But so different—so immeasurably superior to all other sacred books is the B. in the conception it unfolds of the Divine nature as one personal God, exercising towards men the love and care of a parent to his offspring, and in the system of human duties springing therefrom, that on this consideration alone many rest its claim to being received as a direct revelation from heaven. The questions regarding the B., considered in this point of view, fall to be treated under the heads of Inspiration and Revelation. To attempt to analyse or give any detailed account of the contents of the Scriptures, is beyond the scope of this article. The leading features of the doctrines and precepts, as a system, will be briefly sketched under the head of Christianity; while the chief individual doctrines receive notice under their respective names, and in the accounts of the controversies to which they have given rise.

BIBLE, PROHIBITION OF. This is one of the main points of opposition between the Roman Catholic and the Protestant Church. In the earliest times, we find no evidence of any prohibition of

B.-reading by the laity. On the contrary, as the foundation on which the Church was built, and the sole source of religious knowledge, the reading of the B. formed an essential part of the instruction communicated by pastors to their congregations; and the greatest orators of the Church—especially Chrysostom and Augustine—continually reminded their hearers that private reading and study of the Scriptures should follow attendance on public services. This great fact is by no means contradicted by the warnings found, here and there, in the Fathers against abuse or mistake of the meaning of Scripture; these warnings rather imply that Scripture-reading was common among the laity. The gradual widening of the distinction, or rather the separation, between the clergy and the laity, was the work of the middle ages; and, among other means of preserving traditions inviolate and maintaining the exclusive character and sacred authority of the hierarchy, the B. was held in the background, even while there was no direct prohibition of its common use. In 1080, Gregory VII. ordained that Latin should be the universal language of Catholic worship, and consequently excluded all vernacular readings of Scripture in public assemblies. Again, with regard to the Waldenses, Innocent III., in 1199, prohibited the private possession and reading of Scripture (excepting the portions contained in the Breviary and the Psalter) without priestly permission and supervision. Similar prohibitions were repeated at Toulouse (1229), at Béziers (1233), and with regard to Wickliffe, at the synod of Oxford (1383). Ultimately, the recognised Latin version, or Vulgate, was more and more decidedly made the sole authorised Church version. Indeed, as early as 1234, the synod of Tarragona denounced as a heretic any one who, having a translation of the B., refused to surrender it to be burned within the space of eight days. As, however, it soon appeared plain that little could be effected by such prohibitions, milder measures were employed. The Tridentine Council, being required to pronounce on the question of B. translations, purposely employed a word of ambiguous meaning in styling the Vulgate simply 'authentic;' but nothing was determined on B.-reading among the laity. This was first done in the publication of the first *Index Librorum Prohibitorum* soon after the Tridentine Council. Afterwards, the rules of the Church, placing the use of the Scriptures under the supervision of the bishops, were more and more strictly defined. The publication of the New Testament with practical annotations by Paschasius Quesnel (1687), gave occasion to the Roman Catholic Church to speak more definitely on the reading of the B. by the laity in the bull *Unigenitus Dei Filius*, 1713. New ordinances were issued by Pope Pius VII. in his Brief to the Archbishop of Gnesen and Mohilew (1816) against translations formerly authorised; again, by Leo XII., in his condemnation of B. societies (1824), and by Pius VIII. All these ordinances of the Roman Catholic Church imply that it is dangerous to give the B. freely to the laity, and that, therefore, no vernacular versions ought to be used without interpretations taken from the Fathers, and an especial papal sanction.

BIBLE SOCIETY, an association having exclusively for its object the diffusion of the sacred Scriptures. Such associations must be regarded as a natural form or expression of Christian benevolence, acting according to the principles of Protestantism, and seeking to take advantage of the facilities afforded by the art of printing; but a long period elapsed after the Reformation before a B. S. was formed; during which, however, an extensive diffusion of the Scriptures took place, and partly by the

agency of associations which included it among other means for the advancement of Christianity. It necessarily became, along with the translation of the Scriptures, one of the objects to which missionary societies directed their energy. But perhaps the first association ever formed for the sole and specific purpose of providing copies of the Scriptures for those who were destitute of them, was that founded by Baron Hildebrand von Canstein, an intimate friend of Spener, in conjunction with Francke at Halle, and which, down to 1834, when other Bible Societies had begun to be established in Germany, had distributed 2,754,350 copies of the Bible, and about 2,000,000 copies of the New Testament.—The impulse, however, to the formation of the Bible Societies now existing in all parts of Protestant Christendom proceeded from England, where, in 1780, an association was formed for the distribution of Bibles among soldiers and sailors. It was at first simply called *The B. S.*; it exists to the present day, is now known as the *Naval and Military B. S.*, and confining itself to its original specific object, has accomplished much good. It is not an uninteresting circumstance, that the first ship in which Bibles were distributed by this Society was the ill-fated *Royal George*.—In the beginning of 1792, a similar association was formed in London, under the name of the *French B. S.*, with a similar limited and specific object of distributing Bibles in the French tongue. It was probably the attitude assumed by infidelity in France which gave occasion to the formation of this Society, but the greater part of its funds having been remitted to Paris for the printing of the Bible there, were lost, and everything belonging to the Society destroyed in the tumult of the Revolution.—It was not till 1802 that the first steps were taken towards the formation of the BRITISH AND FOREIGN B. S., the parent of a multitude of similar institutions, and the establishment of which must be regarded as the great epoch in the history of this branch of Christian beneficence; nor was the Society fully organised and established till March 7, 1804. Its formation took place in consequence of the deep impression made upon the mind of the Rev. Thomas Charles of Bala, in Wales, by the destitution of the sacred Scriptures which he found to exist in the sphere of his labours, and particularly by a circumstance strikingly illustrative of that destitution. Meeting a little girl in one of the streets of the town, he inquired if she could repeat the text from which he had preached on the preceding Sunday. Instead of giving a prompt reply, as she had been accustomed to do, she remained silent, and then weeping told him that the weather had been so bad she could not get to read the Bible. She had been accustomed to travel every week seven miles over the hills to a place where she could obtain access to a Welsh Bible. Mr Charles, on his next visit to London, brought the subject of the want of Bibles in Wales under the notice of the committee of the *Religious Tract Society* (q. v.), when it was suggested by Mr Hughes, a member of the committee, that a Society might be formed for the purpose of supplying Bibles not only in Wales, but wherever destitution existed throughout the world. The Society was constituted on the widest possible basis, churchmen and dissenters being alike included in it; and soon attained a greatness corresponding with that of the other two religious societies, the *London Missionary Society* (see MISSIONARY SOCIETY), and the *Religious Tract Society* (q. v.), which had been formed on similar principles, a few years before. It was indeed able to expend only about £619 in the first year of its existence; but its annual income gradually increased to an

average of £70,000, and in 1859 amounted to £78,047, derived from donations, legacies, collections, &c., and applicable to the general purposes of the Society, besides £5156 for special objects (a 'Chinese New Testament Fund,' and an 'India Fund'), and £75,918 derived from sales of Bibles and New Testaments. Auxiliary and branch societies and dependent associations rapidly sprang up in all parts of Britain, and in the colonies, the number of which at present amounts to more than 8000. Much more than one-half of the expenditure of the British and Foreign B. S. has been devoted to the diffusion of the authorised English version of the Bible, the only English version with which its fundamental rules permit it to have anything to do; it has also spent large sums in printing and circulating the Scriptures in the different Celtic languages spoken in Great Britain and Ireland, and a very important branch of its operations has been the printing of translations of the Bible prepared by missionaries. The number of translations of the Scripture—in many cases complete, in others extending only to the New Testament, in some only to particular books—which have been printed at the expense of the Society, amounts to not less than 157, the greater part being translations never before printed, and many in languages possessing no previous literature.—The British and Foreign B. S. now issues annually more than a million and a half of copies of the Bible, the New Testament, or such portions of sacred Scripture as have been printed in languages not possessing complete translations. The whole number issued, from the formation of the Society to 31st March 1859, was 35,609,931. This Society has also employed, besides the officials necessary for the management of its funds and its extensive business, agents of high education and Christian character, who have visited different countries for the promotion of its great object. The names of Dr Henderson and Dr Pinkerton must be familiar to many readers, and perhaps no instance could be mentioned more happily illustrative of the character of this branch of the Society's operations than the visit of Dr Henderson to Iceland, an account of which is given in his well-known and very interesting volume of travels in that country.—A controversy concerning the circulation of the books of the Apocrypha along with the canonical Scriptures by the British and Foreign B. S. (see APOCRYPHA), led to a resolution in 1826—not, however, till after the withdrawal of some of its most zealous supporters—that its funds should be devoted, according to its original design, to the diffusion of the canonical books alone.—The EDINBURGH B. S. has from that time to the present subsisted as an entirely separate Society.

The AMERICAN B. S. is, in the magnitude and importance of its operations, next to the British and Foreign Bible Society. It was founded at New York in 1817, and still has its head-quarters in that city, in the '*Bible House*,' a very large and magnificent building, erected by special subscription. It reckons fully 1200 auxiliary societies, in all parts of the United States. Its income now amounts to about 400,000 dollars (£82,000) a year, rather more than one-half being derived from sales of Bibles and Testaments, and the rest from donations, collections, &c. The American B. S. has for some time issued annually more than 250,000 Bibles, and nearly twice that number of New Testaments and other portions of Scripture. The funds of the Society have been chiefly expended in supplying the wants of the inhabitants of the United States, amongst whom the Indian tribes have not been neglected; but considerable sums have also been devoted to other countries, particularly those in which American missionaries have been carrying on their labours.

Of the numerous Bible Societies of Germany, the most important and extensively ramified is the Prussian Central B. S. (*Hauptbibelgesellschaft*) in Berlin. It was founded in 1814, and has branches in all parts of the Prussian dominions. More Bibles, however, are annually supplied to the people of Germany by the agents of the British and Foreign B. S. than by all the German Bible societies together, and there still exists a great and acknowledged destitution.—Bible societies were prohibited by the Austrian government in 1817, and some which had already been established in Hungary were dissolved.—The RUSSIAN B. S., founded at St Petersburg in 1813, through the exertions of Dr Paterson, and under the patronage of the Emperor Alexander I., entered upon a career of great activity and usefulness, co-operating with the British and Foreign B. S. for the printing of the Scriptures in the numerous languages spoken within the Russian dominions; but its operations were suspended in 1826 on the accession of the Emperor Nicholas, its stock of Bibles, and the whole concern, being transferred to the *Holy Synod*, under the pretence that the sacred work of supplying the people with the Holy Scriptures belonged to the Church, and not to a secular society. The Bibles and Testaments in stock were indeed sold, and very large editions were thus disposed of, but the activity of a society which had no equal in continental Europe was at an end. A Protestant B. S. was then, however, formed, for the purpose of providing editions of the Scriptures and circulating them among the Protestants of all parts of the empire, which now reckons 277 auxiliary societies. But the action of this Society 'does not touch the members of the Greek Church, or, if at all, only slightly and incidentally, and it makes no provision of the Scriptures in the language spoken by the great mass of the people. It is merely designed to meet the wants of colonists and others, who do not use the Russian language.' Of the translations of the Scriptures published by the original Russian B. S., the greater number have never been reprinted since its suppression.

There can be no doubt that Bible societies have contributed very much to the progress of Christianity and civilisation since the beginning of the 19th c., and their influence is continually increasing and extending.

BIBLIA PAUPERUM, or Bible of the Poor, was a sort of picture-book of the middle ages, giving, on from forty to fifty leaves, the leading events of human salvation through Christ, each picture being accompanied by an illustrative text or sentence in Latin. A similar and contemporaneous work on a more extended scale, and with the legend or text in rhyme, was called *Speculum Humane Salvationis*, i. e., the 'Mirror of Human Salvation.' Before the Reformation, these two books were the chief text-books used, especially by monks, in preaching, and took the place of the Bible with the laity, and even clergy; and as the lower orders of the regular clergy, such as the Franciscans, Carthusians, &c., took the title of 'Pauperes Christi,' Christ's Poor, hence the name. Many manuscripts of the *B. P.*, and of the *Mirror of Salvation*, several as old as the 13th c., are preserved in different languages. The pictures of this series were copied in sculptures, in wall and glass painting, altar-pieces, &c., and thus become of importance in the art of the middle ages. In the 15th c., the *B. P.* was perhaps the first book that was printed in the Netherlands and Germany, first with blocks, and then with types. The chief proof for the discovery of printing in Haarlem rests on the first impressions of the *Speculum Humane Salvationis*. See COSTER.

BIBLICAL ANTIQUITIES, or **BIBLICAL ARCHÆOLOGY**, is a study which has for its objects the social and political constitution, the manners, customs, geography, &c., of the Jews and other peoples mentioned in the Scriptures. A knowledge of these is essential to a right understanding of many passages of Scripture. The antiquities of the ancient Jews themselves undoubtedly form the most important part of such a study; but an examination of the laws, customs, &c., of the neighbouring Semitic nations is likewise indispensable. The principal sources of such knowledge are the Old and the New Testament; the books of Josephus on *Jewish Antiquities* and the *Wars of the Jews*; the writings of Philo, the Talmud and Rabbinical works; and, lastly, Greek, Roman, and Arabian writers, with medals, monuments, and other works of art, the accounts of travellers, &c. The first work on Hebrew archæology was Thomas Goodwin's *Moses et Aaron, seu Civiles et Ecclesiastici Ritus Antiquorum Hebr.* (Oxford, 1616). Among later treatises we may especially notice—Jahn's *Biblical Archaeology* (5 vols. Vienna, 1796—1805); Bauer's *Manual of Hebrew Antiquities* (Leip. 1797); De Wette's *Manual of Hebrew-Jewish Archaeology* (Leip. 1814); Rosenmüller's *Manual of Biblical Antiquities* (Leip. 1823); and Winer's *Biblical Dictionary* (3d ed. Leip. 1847). A convenient work of reference on this subject is Dr Kitter's *Cyclopædia of Biblical Literature*, which numbers among its contributors many of the ablest British and continental scholars; or *The Pictorial Bible*, edited by the same writer, and containing original notes explanatory of passages connected with the History, Geography, Natural History, Literature, and Antiquities of the Sacred Scriptures (newest edition published by W. and R. Chambers, 1856).

BIBLIOGRAPHY, a term applied to the description and proper cataloguing of books. It is derived from *bibliographia*, which was employed by the Greeks to signify the transcription of books, while *bibliographos* was merely a copyist. The introduction of the term in the meaning which we now attach to it may be dated from the appearance of the first volume of De Bure's *Bibliographie Instructive* in 1763.

The bare enumeration of the works that have been written on this branch of literature would more than fill an ordinary volume; we shall here confine ourselves to the more important of them.

A favourite dream of bibliographers has been the production of a general catalogue, embracing the whole range of printed literature; and one attempt at least has been made to realise it. In the year 1545, Conrad Gesner published at Zurich, in one folio volume, his *Bibliotheca Universalis*, in which are described, under the names of the authors, arranged alphabetically, all the books in the Hebrew, Greek, and Latin languages about which the compiler could obtain information. This restriction as to language, of course, does away to some extent with the idea of universality indicated by the title-page; still, as the three which are included were in Gesner's time almost the only ones employed by men of learning, his work may be regarded as a nearly complete account of the state of printed literature as it then existed. The only other effort in this direction which we have to record is the *Bibliotheca Britannica* of Dr Robert Watt, 4 vols. 4to (Edinburgh, 1824). Its object will be best described by the following extract from the preface to it: 'The account given of British writers and their works is universal, embracing every description of authors, and every branch of knowledge and literature. What has been admitted of foreign publications, though selective, forms a very considerable

BIBLIOGRAPHY.

and valuable portion of the work, and as none of note have been purposely omitted, the *Bibliotheca Britannica* may be considered as a universal catalogue of all the authors with which this country is acquainted, whether of its own or of the continent.' This great work was compiled under very adverse circumstances, and its author did not live to see it through the press. It thus labours under all the disadvantages of a posthumous publication; but with all its faults both of omission and commission, which are neither few nor small, it deservedly maintains a high character as a work of reference, and is indispensable to the library of every bibliographer.

The other labourers in this field of literature, whose works we are about to notice, have confined themselves within narrower limits. Some, proceeding upon a principle of selection, endeavour to furnish the inquirer with the information he seeks in regard to books which are rare, curious, or valuable; others, again, aiming at greater completeness within certain bounds, restrict themselves to the description of a special class of works—the literature, for example, of a particular country or language; the productions of a celebrated press; the books published within a given period; those of which the authors have withheld their names, or have veiled them under a pseudonym; and the treatises that have been written on a specific subject; and so on, together with a few which hardly admit of classification, but of which some examples will be given.

Bibliographical works on the selective principle form a numerous class; the following are amongst the more important: Vogt, *Catalogus Historico-criticus Librorum Rariorum*, 8vo (Francfurti, 1793). This is the fifth edition; the four preceding appeared successively at Hamburg in 1732, 1738, 1747, and 1753. David Clement, *Bibliothèque Curieuse, ou Catalogue raisonné de Livres difficiles à trouver*, 9 vols. 4to (Göttingen, 1750—1760). The expression *catalogue raisonné* is usually, but erroneously, applied in this country to classified catalogues; yet the work of Clement, who was the son of a Frenchman, and certainly understood the language in which he wrote, is arranged alphabetically. It is simply what it professes to be, a descriptive and methodised account of the books which it includes; but unfortunately it was never completed. It terminates with the article 'Hesiodus,' and the seven or eight volumes required to finish it have not been published. The *Bibliographie Instructive* of De Bure has already been mentioned; it extends to seven volumes 8vo, the last of which appeared in 1768. To these, however, should be added the *Catalogue des Livres de Gaignat*, 2 vols. 8vo (Paris, 1769), and the *Table destinée à faciliter la Recherche des Livres Anonymes*, 8vo (Paris, 1782). Ebert's *Bibliographisches Lexicon*, 2 Bde. 4to (Leip. 1821—1830), is an accurate and useful work. It has been translated into English, 4 vols. 8vo (Oxford, 1837). Lowndes's *Bibliographer's Manual* contains an account of rare, curious, and useful books, published in or relating to Great Britain, from the invention of printing, and may always be consulted with advantage. It appeared originally in 4 vols. 8vo (Lond. 1834); but a new edition, with many improvements, is now (1860) in course of publication under the editorship of Mr H. G. Bohn. One of the most interesting and important works in this department of B. is the *Manuel du Libraire et de l'Amateur des Livres* of J. C. Brunet, of which it is hardly possible to speak in terms of too high commendation. It was first published in 1810, in 3 vols. 8vo; and the fourth edition, in 5 vols. 8vo (Paris, 1842—1844), is now out of print. It is understood that the author is occupied with a fifth edition. A new work of a

similar character, entitled *Trésor des Livres Rares et Précieux*, by J. G. T. Graesse, is now making its appearance at Dresden. The sixth *livraison*, coming down to the end of the letter 'B,' has just been issued. To these may be added the amusing and instructive bibliographical works of the Rev. Dr Dibdin.

Turning to special B., and taking the subjects of which it treats in the order given above, we have to notice first the works which confine themselves to the literature of a particular country or language. As regards Great Britain, we have besides Watt and Lowndes, already mentioned, the *Typographical Antiquities* of Ames and Herbert, 3 vols. 4to (Lond. 1785—1790). A new and improved edition was projected by Dibdin, but was not completed. Volumes 1 to 4 only have appeared, 4to (Lond. 1810—1819). The latest contribution to British B. is the *Critical Dictionary of English Literature and British and American Authors*, by S. A. Allibone, vol. 1, 8vo (Philadelphia, 1859). Of this work, we regret that we cannot speak favourably. It faithfully reproduces most of the errors of Watt, with the addition of not a few for which the compiler is himself responsible. Moreover, the titles of many of the books mentioned are so abbreviated as to be only recognisable by those who are already acquainted with them. Our French neighbours possess a treasure in *La France Littéraire* of J. M. Querard. It embraces only the 18th and 19th centuries, but within this limit, it leaves nothing to be desired in point of accuracy and fulness. The continuation, begun by Querard, and afterwards carried on by Lonandre and Bourquelot, forms 6 vols. 8vo (Paris, 1846—1857). For the literature of Italy we can only notice Gamba's *Serie de Testi*, 4th ed. (Venice, 1839); and for that of Spain, the *Bibliotheca Hispana Vetus*, and the *Bibliotheca Hispana Nova*, of Antonio, the latest and best editions of which appeared at Madrid (1783—1788) in folio. The authors of the Low Countries are enumerated in the *Bibliotheca Belgica* of Foppens, 2 vols. 4to (Brussels, 1739); and those of Scandinavia in the *Almindeligt Litteraturlæxicon for Danmark, Norge, og Island*, of Nyerup and Kraft, 4to (Copenhagen, 1820). For Germany, we have Heinsius, *Allgemeines Bücherlexicon*, with supplements (10 vols. 4to, 1812—1849), and Ebert's *Handbuch der Deutschen Litteratur*, 4 vols. 8vo (Leip. 1822—1840). To this class also belong the *Bibliotheca Græca*, *Bibliotheca Latina*, and *Bibliotheca Latina Medicæ et Infimæ Etatis* of Fabricius; Harwood's *View of the various Editions of the Greek and Roman Classics*; and Moss's *Manual of Classical Bibliography*. The Oriental student will find much to interest him in the *Lexicon Bibliographicum* of Haji Khalfa, edited in the original Arabic, with a Latin translation by Fluegel, 7 vols. 4to, 1835—1858.

Of works descriptive of the productions of particular presses, we can only notice Renouard's *Annales de l'Imprimerie des Alde* (3d ed., 8vo, 1834); the *Annales de l'Imprimerie des Estiennes*, by the same author, 8vo (Paris, 1837—1838); and Bandini, *Juntarum Typographicæ Annales*, 2 vols. 8vo (Luccæ, 1791). The student may also consult with advantage the *Notice de la Collection des Auteurs Latins, Français, et Italiens Imprimés en petits Formats par les Elzeviers*, at the end of the 5th volume of Brunet's *Manuel*.

The bibliographers who have confined themselves to books printed within a given period are chiefly Panzer, *Annales Typographicæ ab Artis Inventæ Origine ad Annum M.D.* (continued, however, to 1536), 11 vols. 4to (Norimbergæ, 1793—1803); and Hain, *Repertorium Bibliographicum*, 4 vols. 8vo,

1826—1838. The death of the author before the completion of this work, was the cause of the comparative inaccuracy observable in the 3d and 4th volumes. The article 'Virgil,' for example, is omitted altogether.

One of the earliest attempts to reveal the authorship of anonymous works was the *Theatrum Anonymorum et Pseudonymorum* of Vincent Placcius, folio (Hamburg, 1708); to which Mylius added a supplement in 1740. So far as France is concerned, these have both been superseded by the admirable and well-known *Dictionnaire des Ouvrages Anonymes et Pseudonymes* of Barbier, 2d ed., 4 tom. 8vo (Paris, 1822—1827). Italy, too, has the *Dizionario di Opere Anonime e Pseudonime di Scrittori Italiani* of Melzi, vols. 1 and 2, 8vo (Milano, 1848—1852); and we may also mention here the *Pseudonomia* of Lancetti, 8vo (Milano, 1836), as the work of an Italian, though not confined to the authors of his native country. No work specially devoted to the anonymous and pseudonymous literature of Britain has yet been published; but it is understood that the present keeper of the Advocates' Library has been for some time engaged in collecting materials for this purpose. The most recent additions to this branch of B. are Weller's *Maskirte Literatur der älteren und neueren Sprachen*, Iter Theil; *Index Pseudonymorum*, 8vo (Leip. 1856), 2ter Theil; *Die falschen und fingirten Druckorte*, 8vo (Leip. 1858).

Bibliographies which describe treatises on special subjects are very numerous; we have only space to notice the following: Lipenius, *Bibliotheca Realis Theologica*, 2 vols. folio (Francofurti, 1685); *Bibliotheca Philosophica*, 1682; *Bibliotheca Medica*, 1679; *Bibliotheca Juridica*, 1672—a new edition of the last of these was published at Leipsic in 1757, and supplements have been successively added by Scott, Senkenberg, and Madihn—Marvin's *Legal Bibliography*, 8vo (Philadelphia, 1847); Orme's *Bibliotheca Biblica*, 8vo (Edin. 1824); Fürst's *Bibliotheca Judaica*, 8vo (Leip. 1849—1851); Vater, *Literatur der Grammatiken, Lexica und Wörter-sammlungen aller Sprachen der Erde*, 2te Ausg. von B. Jülz, 8vo (Berlin, 1847); Upcott's *Bibliographical Account of the Principal Works relating to English Topography*, 3 vols. 8vo (Lond. 1818); Oettinger's *Bibliographie Biographique Universelle*, 8vo (Bruxelles, 1854); *The Literature of Political Economy*, by J. R. McCulloch, 8vo (Lond. 1845); *Arithmetical Books from the Invention of Printing to the Present Time*, by Augustus de Morgan, 12mo (Lond. 1847); the *Biographia Dramatica*, by Baker, Reed, and Jones, 3 vols. 8vo (Lond. 1812); and the *Bibliotheca Anglo-poetica*, 8vo (Lond. 1815).

As examples of other works not included in the above classification, we have only space to mention Van Praet's *Catalogue des Livres Imprimés sur Vélin*, 9 vols. 8vo (Paris, 1822—1828); Peignot's *Dictionnaire des Livres condamnés au Feu*, 2 vols. (Paris, 1806); and Martin's *Bibliographical Catalogue of privately printed Books*, 2d ed., 8vo (Lond. 1824).

The student desiring further information, will find copious lists of works on B. in Watt's *Bibliotheca*, and in Brunet's *Manuel*.

BIBLIOMANCY (Gr. *ta biblia*, the Bible, and *manteia*, divination), a mode of divination much practised during many ages, by opening the Bible, and observing the first passage which occurred, or by entering a place of worship and taking notice of the first words of the Bible heard after entering it. The application was often very fanciful, and depended rather upon the mere sound of the words than upon their proper signification, or the scope of the passage. Prayer and fasting were sometimes used as a preparation for a mode of consulting the divine oracles, than which nothing could be more

contrary to their purpose and spirit, and which was in harmony only with the notions and practices of heathenism. B. was prohibited, under pain of excommunication, by the Council of Vannes, 465 A. D., and by the Councils of Agde and Orleans in the next century. It continued, however, to prevail for many centuries thereafter, and is said to have been introduced into England at the Norman Conquest. It was essentially the same as the *Sortes Virgilianæ*, the only difference being in the book employed.

BIBLIOMANIA, or book-madness, is a word recently formed from the Greek to express the passion for rare and curious books, which has manifested itself to such an extent during the last century. While the ordinary collector is satisfied with the possession of works which are valuable either on account of their established reputation, or as assisting him in his literary or professional pursuits, the bibliomaniac is actuated by other motives. With him utility is of secondary importance, rarity being the first and great requisite. Thus even a common book becomes valuable in his eyes, if it be one of a few copies thrown off on vellum or on large paper, or if it has been bound by Derome, Bozerian, Lewis, or Payne; and for the same reason, he sometimes prefers an inferior to a better article. The fac-simile reprint of the Giunta edition of Boccaccio's *Decameron* (Florence 1527) fetches hardly as many shillings as the original does pounds, yet the great distinguishing difference between them is, that the former is the handsomer and more correct of the two.

The formation of complete sets of such books as the *Elzevir Republics* (see *ELZEVR*), or of the works of a single author, provided they be scarce, is a favourite pursuit with many. The editions of the classics most prized by collectors are those of the Elzevirs and of the Foulises (q. v.). The original editions of Defoe's numerous productions are eagerly sought for at present.

B. seems to have reached its climax at the sale of the library of the Duke of Roxburghe in 1812. Amongst the treasures which that library contained, was the only perfect copy, known to exist, of the first, or at least the first dated edition of Boccaccio's *Decameron* (Venice, Christ. Valdarfer, 1471). After a spirited competition with Lord Spencer, this volume was purchased by the Marquis of Blandford for the sum of £2260, the highest price perhaps ever paid for a single book. When the collection of the marquis came under the hammer in 1819, Lord Spencer secured this precious tome at the large yet more moderate cost of £918, 15s. It is now, we believe, in his lordship's library at Althorp.

One of the results of the Roxburghe sale was the establishment of the Roxburghe Club, the object of which was to reprint, for the use of the members only, works hitherto unedited, or of extreme rarity. The example thus set was speedily followed by the Bannatyne and Maitland Clubs in Scotland, and by many more in other parts of the kingdom. Some of these are defunct, and others are in a moribund state. It remains to be seen in what new form the B. of the present day will develop itself.

BICANERE, capital of the protected state of the same name in Rajpootana. India, is situated in a singularly desolate tract, 1175 miles to the north-west of Calcutta, in lat. 28° N., and long. 73° 22' E. Pop. about 60,000. It is surrounded by a battlemented wall of 3½ miles in circuit; and from a distance presents a magnificent appearance, but inside, the people are found to be extremely filthy. Immediately to the north-east is a detached citadel, of which the rajah's residence occupies the greater part.—The state of which B. is the capital, lies in

lat. 27° 30'—29° 55' N., and long. 72° 30'—75° 40' E., thus measuring, in its extremes, 160 miles by 200. It contains 17,676 square miles, with an estimated population of 539,250. The Rajpoots are the predominant race; but the Jauts form the great body of the inhabitants. Though the people find their principal resource in pasturage, yet water appears to be remarkably scarce. In the whole territory, there is not one perennial stream; while wells, as precarious and scanty as they are brackish and unwholesome, average perhaps 250 feet in depth; even the lakes or *sirrs*, which the periodical rains leave behind them, are generally saline, yielding, in fact, at the close of the dry season, a thick crust of salt. But the peculiar feature of the country is the range of its temperature. In the beginning of February, ice is formed on the ponds; and in the beginning of May, the thermometer stands at 123° F. in the shade. Again, in the beginning of November, according to Elphinstone's experience, each period of 24 hours, according as the sun was above or below the horizon, presented such extremes of heat and cold as often to be fatal to life.

BICE (Ger. *Beis*, Ital. *Biadetto*), the name of two pigments of a blue and green colour respectively, known to artists from the earliest times—blue B. as *mountain blue*, *ongaro*, *azzurro di terra*, &c.; and green B. as *chrysocolla*, *Hungarian green*, *verde de Mimiera*, *verde de Spagna*, *verdeto*, &c. Green B. is now usually called *malachite green* and *mountain green*. Both are native carbonates of copper, but are also prepared artificially. In its native state, however, B. is more durable, and in the case of mountain green especially, much more brilliant. Artificial blue B. is known as *Hambro' blue*, *mineral blue*, &c.; artificial green B., as *mountain green*, *Paul Veronese green*, and *emerald green*.

BICEPS (double-headed) is the muscle which gives a full appearance to the front of the arm. Above, it consists of two portions or heads—whence its name—one being attached to the coracoid process of the scapula, the other to the margin of the depression on that bone which lodges the head of the humerus. The former is the short, the latter, the long head of the biceps. They unite to form a fleshy belly, which terminates in a rounded tendon.

The B. tendon is inserted into the tubercle of the radius (see ARM). Before passing to this insertion, it gives off an expansion (see SPONEUROSIS), which separates the median basilic vein from the brachial artery in the situation generally selected for venesection. The action of the B. is rapidly to bend the forearm, and also to supinate the hand.

BICÈTRE, originally the name of a very old castle, situated on a little eminence in the neighbourhood of Paris, and commanding one of the finest views of the city, the Seine, and the environs. In 1632, it was destroyed, because it had become a hiding-place of thieves. Afterwards, it was rebuilt by Louis XIII., and made a hospital for old soldiers. When Louis XIV. had built the *Hôtel Royal des Invalides*, the B. was made a civil hospital for septuagenarians. It also serves as a prison for 2000 culprits, mostly condemned to the galleys, as well as a hospital for incurable lunatics. Wool-spinning and glass-polishing are carried on in the building. There is a well sunk in the rock to the depth of 183 feet.

BICHAT, MARIE FRANÇ. XAVIER, one of the most famous anatomists and physiologists, whose discoveries make an epoch in biology, was born at Thoirette, in the department of Ain, France, November 11, 1771. He studied chiefly in Paris under Desault,

who adopted him as his son, and whose surgical works he edited. In 1797, he began giving lectures on anatomy, along with experimental physiology and surgery, and in 1800 was appointed physician in the Hôtel-dieu. Two years after, July 22, 1802, he fell a victim to intense and unremitting labour, before he had completed his thirty-first year. He was the first to simplify anatomy and physiology by reducing the complex structures of the organs to the simple or elementary Tissues (q. v.) that enter into them in common. This he has done in his *Anatomie Générale* (2 vols., Par. 1801, often reprinted). In his *Recherches Physiologiques sur la Vie et la Mort* (Par. 1800), he develops another luminous idea—the distinction between the organic and the animal life.

BICKERSTAFF, ISAAC, author of numerous comedies and light musical pieces produced under Garrick's management, which had at one time a great popularity, was born in Ireland about the year 1735, and became page to Lord Chesterfield, who was made Lord Lieutenant of Ireland in 1746. B. afterwards became an officer of marines, but was dismissed the service for some discreditable offence. Nothing is certainly known regarding his after-life, nor the time of his death, which would seem to have taken place on the continent. His best known pieces are, *The Maid of the Mill*; *The Padlock*; *He would if he could*; *Love in a Village*; *The Hypocrite*; and *The Captive*.

BICKERSTETH, REV. EDWARD, an influential clergyman of the Church of England, was born at Kirkby Lonsdale, in Westmoreland, March 19, 1786. He commenced life as a post-office clerk; and afterwards, having served an apprenticeship to a London attorney, established a lucrative solicitor's business in Norwich. Here, he took great interest in all meetings of a religious nature, and soon became so deeply impressed with the importance of religious truth, that he resolved to devote himself to the ministry. Being admitted to orders, he was sent by the Church Missionary Society to re-organise their mission stations in Africa. Having most satisfactorily accomplished his mission, B. was, on his return, appointed secretary to the Church Missionary Society, and continued to discharge the duties of the office with an unwearied energy and devotion that won for himself a high reputation and extensive influence, as well as great prosperity for the institution he represented, until 1830, when he resigned on acceptance of the rectory of Watton, in Hertfordshire. Here, until his death, which took place February 24, 1850, he took an active part in promoting, both by tongue and pen, almost every work having for its object the spread of religious truth whether at home or abroad. B. belonged to what is known as the Evangelical section of the Church of England, and took a decided part against the endowment of Maynooth, and in opposition to the spread of Tractarianism in his own church. He was also one of the founders of the Evangelical Alliance. Of his religious writings—which were extensive, and which have been collected in 16 vols. (Lond. 1853)—the most popular are, *A Help to the Study of the Scriptures* (written before he was ordained), *The Christian Student*, and *A Treatise on the Lord's Supper*. B. also edited a work called *The Christian Family Library*, which extended to 40 or 50 vols.

BIDASSO'A, a river which, rising in Spain, forms the boundary between that country and France, and falls into the Bay of Biscay at Fuenterrabia. The treaty of the Pyrénées was concluded on an island in its mouth in 1659. The B. was the scene of several conflicts during the Spanish campaign.

In April, May, and June 1793, the Spanish crossed the river, and defeated the French, who occupied a line extending from St Jean Pied-de-Port to the mouth of the B., in three successive encounters, capturing a considerable quantity of ammunition and several pieces of cannon. In July of the following year, however, the French captured the intrenched camp and all the fortified posts of the Spaniards—defended by 200 pieces of cannon—on the river. Napoleon, in June 1811, had a *tête-du-pont* constructed on the B. at Irun. In August 1813, the French under Soult were defeated at San Marcial on the B. by the allies; and in the October of the same year, Wellington surprised and drove the French from their strongly fortified positions on its northern side.

BIDDING PRAYER is a form of exhortation, always concluding with the Lord's Prayer, enjoined by the 55th canon of the Anglican Church, in 1603, to be used before all sermons and homilies. Except in cathedrals and the university churches, it is now but seldom used. The term 'B.' is from the Saxon 'Bede,' signifying a prayer. The form is of extreme antiquity, and we have a similar one in the Apostolical Constitutions (q. v.), the original of which was probably that used in the Church of Antioch. It was anciently used for the communicants or believers after the dismissal of the catechumens, and was pronounced by the deacon, each petition beginning with the words: 'Let us pray for —,' and the people responding at the end of each with 'Kyrie Eleison,' or some such words.

There is another very ancient example in the Ambrosian Liturgy; and St Chrysostom alludes to such a form in one of his sermons. It must have been, and even now in its abridged shape still is, very impressive, allowing each individual to supply from his own thoughts special cases of necessity under the different heads. There is some resemblance between these B. Prayers and the Litany, and prayer for the church militant, now used in the Anglican Church.

BIDDLE, JOHN, the founder of English Unitarianism, was born in 1615, at Wotton-under-Edge, in Gloucestershire, and, in 1632, entered Magdalen College, Oxford, where he took his degree of M.A. In 1641, he was elected master of the free school in the town of Gloucester, the duties of which function he discharged with such zeal, that the character of the institution was greatly improved; but having embraced certain opinions—which he printed for private circulation—in regard to the personality of the Holy Spirit, at variance with those held by the majority of Christians, he was thrown into jail, December 1645. Being at length summoned before the parliament at Westminster, on account of his heresy, he was formally tried, and condemned to imprisonment for five years. The famous Westminster Assembly of Divines undertook to 'settle' B.'s case, but unfortunately their arguments—as is usual in disputation—had only the effect of strengthening his previous convictions. In 1648, while still in prison, he published a *Confession of Faith concerning the Holy Trinity*, &c., which was followed by another tract containing the opinions of the Church Fathers on the same question. In consequence of this attempt to combat the orthodox doctrine, the Westminster Divines called upon the parliament to pass an act declaring the denial of the Trinity a crime punishable by death. The *army*, however, strange to say, proved on this occasion less cruel than the *church*, for it manifested such strong opposition that the act remained a dead-letter. Under the liberal rule of Cromwell, B. was released. He now commenced to gather a congregation of those

whom he had converted to his opinions—namely, that there was but one person, as there was but one nature, in the Godhead. The members were first called Bidellians, then Socinians, and finally assumed for themselves the name of Unitarians. Twice, however, after this, during the Commonwealth, B. suffered severely for his creed, and even the iron-willed Protector himself, in order to save his life, was compelled to banish him to one of the Scilly Isles. Three years of imprisonment having elapsed, he was permitted to return, and continued to preach in London till the death of Cromwell, and also after the restoration, until June 1662, when he was again apprehended and fined in £100, and being unable to pay, was committed to jail, where he died in September of the same year. His personal character was highly esteemed by those who knew him.

BIDDLE, NICHOLAS, an American financier, born at Philadelphia in 1786, graduated at Princeton College, and became an energetic member of the legislature of Pennsylvania. In 1823, he was appointed president of the United States' Bank, and held that post till 1839. He conducted its affairs at first with great skill, integrity, and prudence; but, in 1838, the bank became insolvent, and in October of that year suspended cash-payments. The commercial panic and distress which at that time prevailed in the United States, spread dismay far and wide, and involved multitudes in ruin. In December 1841, the grand-jury for the county of Philadelphia made a presentment against B. and some others for entering into a conspiracy to defraud the stockholders of the bank of 400,000 dollars in 1836, and endeavouring to conceal the same by a fraudulent and illegal entry in 1841; the presentment, however, was never followed up. B. had considerable literary taste, and for some time edited *The Philadelphia Portfolio*, contributing many articles to its pages. By request of the president of the United States, he compiled from the original papers a *History of Lewis and Clarke's Expedition to the Pacific Ocean*; also *The Commercial Digest*, a volume put forth by congress. A number of his essays, speeches, &c., were published. He died in January 1844.

BIDEFORD, a seaport town of Devonshire, on both sides of the Torridge, near its confluence with the estuary of the Taw, 30 miles north-west of Exeter. A bridge of 24 arches, and 677 feet long, unites the two divisions of B., which has manufactures of ropes, sails, earthenware, and leather. These it exports, together with oak-bark, corn, flour, linens, woollens, iron, and naval stores. Pop. (1851) 5775. In 1857, 130 vessels, of 10,889 tons, belonged to the port; and in 1853, 1135 vessels, of 59,336 tons, entered and cleared it. Vessels of 500 tons can get up to the quay in the centre of the town. Sir R. Granville, the naval hero and discoverer of Virginia, was born in Bideford.

BIDPAI, or **PILPAI**, is the reputed author of a collection of fables and stories which have been widely current both in Asia and Europe for nearly 2000 years, passing as a compendium of practical wisdom. Scarcely any book except the Bible has been translated into so many languages; and its history deserves attention as part of the history of human development. The researches of Colebrooke, Wilson, Sylvestre de Sacy, and Loiseleur des Longchamps (*Essai sur les Fables Indiennes*, 1838), have successfully traced the origin of the collection, its spread, and the alterations it has undergone among different nations. The ultimate source is the old Indiau collection in Sanscrit, with the title *Pantcha Tantra*, i. e., 'Five Sections' (edited by Kosegarten, Bonn, 1848). An analytical account of the Sanscrit

Pantcha Tantra, by H. H. Wilson—who determines the date of its production to be subsequent to the 5th c. A. D.—is printed in the *Transactions* of the Royal Asiatic Society, vol. i.; but an abridgment of it, called the *Hitopadesa*, is better known than the original. A critical edition of the *Hitopadesa* has been published by A. W. von Schlegel and Lassen (Bonn, 1829), and translations have been made into English by Wilkins and Jones, and into German by M. Müller (Leip. 1844).

Under the Persian king, Nushirvan (531—579), the *Pantcha Tantra* was translated into the Pehlvi tongue by his physician Barsuyeh, under the title of *Calilah and Dimnah* (from two jackals that take a prominent part in the first fable). This Pehlvi version has perished with all the profane literature of ancient Persia; but under the Calif Almansur (754—775), it was translated into Arabic by Abdallah-ibn-Almokaffa (published by De Sacy, Par. 1816). From Almkaffa's Arabic translation—in the introduction to which the author of the collection is called Bidpai, the chief of Indian philosophers—have flowed all the other translations and paraphrases of the East and West. Several Arabic poets worked it up into complete poems; and in the new Persian literature a great variety of versions and paraphrases, some in verse, some in prose, were made. From the Persian of Vaez (about the end of the 15th c.), the work was translated into Turkish about 1540 by Ali Chelebi, under the title of *Homayun-nâmeh*, the Imperial Book. There are also translations into the Malay, Mongol, and Afghan languages.

Towards the end of the 11th c., a translation had appeared, from the Arabic of Almkaffa, into Greek, by Simeon Sethus; and later, a Hebrew translation by Rabbi Joel, which John of Capua, a converted Jew, in the last half of the 13th c., retranslated into Latin with the title of *Directorium Humanae Vitae* (published first at Augs. 1480, and repeatedly since). A version from this was made into German by Eberhard I., Duke of Würtemberg (died 1325), which appeared with the title of *Examples of the Ancient Sages* (Ulm, 1483). Under Alfonso X. of Castile (1252—1284), Almkaffa's work was translated into Castilian, and afterwards from that into Latin by Raymond of Veziers, a learned physician. The other European translations follow, some the Latin of John of Capua, some that of Raymond of Veziers; Spanish (Burgos, 1498), Italian (Flor. 1548), English (Lond. 1570), Dutch (Amst. 1623), Danish (Cop. 1618), Swedish (Stock. 1743), German (most recent, Leip. 1802).

BIEL. See **BIENNE**.

BIÉLÉFELD, a busy town of Westphalia, in Prussia, picturesquely situated on the Lutter or Lutterbach, at the foot of the Sparrenberg Mountain, and about 26 miles south-west of Minden. The broad ditch, which formerly surrounded B., is now converted into pleasant walks. The old walls of the town have been put to a similar use. The castle of Sparrenberg, erected in 1545 on the site of an old Guelphic fortress, and which now serves as a prison, is in the immediate neighbourhood. B., which is the centre of the Westphalian linen-trade, has extensive bleaching-grounds, manufactures of woollen thread, soap, leather, &c., and its meerschau pipes are celebrated. Pop. 10,000.

BIÉLÉV, an ancient town of European Russia, in the government of Tula, situated on the left bank of the Oka, in lat. 53° 45' N., and long. 36° 5' E. It has a large trade, and manufactures of soap, hardware, leather, &c. Pop. 11,000.

BIÉLITZ, a town of Austrian Silesia, on the left bank of the river Biala, about 18 miles north-east of Teschen. A bridge over the river connects it with

the town of Biala, which is situated in Galicia. It has dye-works and print-fields, and carries on a large trade in woollens and kerseymeres with Russia, Poland, Hungary, and Italy. B. belongs to the Princes Sulkowsky, whose castle, now converted into public offices, is situated here. Pop. 6000.

BIÉLLA, a town of Piedmont, capital of the province of the same name, about 38 miles north-east of Turin, with which it is connected by railway. It is pleasantly situated on the Cervo, an affluent of the Sesia, and has manufactures of woollens, hats, paper, &c. Pop. about 9000.

BIÉLO-OZÉRO (the White Lake), a lake in the government of Novgorod, Russia, lat. 60° 10' N., long. 37° 30' E. It is elliptical in shape, its length being about 25 miles, and its breadth 20. Its bottom is composed of white clay, which, during stormy weather, gives to the water a milky appearance; hence, doubtless, the name White Lake. B. is fed by numerous small streams, is pretty deep, and abounds with fish. Its surplus waters are conveyed by the Sheksna River into the Volga. Canals unite it with the Onega, Sukona, and Dwina.—**B.-OZERSK**, an old wooden town on the south shore of the lake, formerly capital of an ancient principality of the same name, has a trade in cattle, corn, and pitch, and manufactures of candles. Pop. 3000.

BIÉLOPOL, a town of Russia, in the government of Kharkov, from which city it is distant 106 miles north-west. It has a considerable general trade and extensive distilleries. Pop. 10,500.

BIÉLSHÖHLE, a singular cavern in one of the Harz Mountains, called Bielstein, on the right bank of the Bode, in the duchy of Brunswick, Germany. It was discovered in 1768. The entrance to it is more than 100 feet above the bed of the stream. The cavern is divided into eleven main compartments, and contains a great deal of that curiously freakish work which nature delights to execute in stalactites, when she sometimes condescends to imitate the inventions of human art, as in the eighth division, where she has contrived to fashion the framework of an organ out of the slow drip of ages. In the ninth, there is also a picture of a sea, as it were, arrested in its motion, its waves silent, but in act to roll.

BIÉLSK, a town of Russian Poland, 25 miles south of Bialystok. It is situated in a very fertile district, watered by the Narew and Nurzek, was formerly capital of a Polish palatinate, is well built, and has a fine custom-house. Pop. 12,000.

BIÉLNNE, or **BIEL**, a town of Switzerland, in the canton of Bern, 17 miles north-west of the city of Bern, beautifully situated at the foot of the vine-clad Jura, at the mouth of the valley of the Suze, and at the northern extremity of the lake of Biemme. It is surrounded by old walls, and approached by shady avenues. Pop. 4248, who are engaged in the manufacture of watches, leather, cotton, &c. B. is a place of great antiquity. It belonged to the Bishop of Bâle, or Basel; but as early as 1352, it entered into an alliance with Bern, for the protection of its liberties, and for this display of independence was burned by its ecclesiastical ruler. The Reformation, however, so weakened the power of the clerical governors of B. that in the beginning of the 17th c. it had become merely nominal; and B. was essentially a free and independent city until 1798, when it was annexed to France. In 1815, it was united to Bern.—**B., LAKE OF**, extends from the town of B. along the foot of the Jura Mountains in a south-west direction, until within 3 miles of Lake Neuchâtel, its length being about 10 miles, and its greatest breadth 3. It is situated at an elevation of

1419 feet above the level of the sea, 8 feet lower than Lake Neuchâtel, whose surplus waters it receives at its south extremity by the Thiel, by which river it again discharges its own. Its greatest depth is 400 feet. Towards its southern extremity is situated the island of St Pierre, crowned with a grove of fine old oaks, to which Rousseau retired for two months after his proscription at Paris in 1765.

BIENNIALS, or **BIENNIAL PLANTS**, are plants which do not flower in the first season of their growth, but flower and bear fruit in the second season, and then die. Many of our cultivated plants are B., as the carrot, turnip, parsnip, parsley, celery, &c., and many of the most esteemed flowers of our gardens, as stock, wallflower, &c. But plants which in ordinary circumstances are B., often become annuals (q. v.), when early sowing, warm weather, or other causes promote the earlier development of a flowering stem, as is continually exemplified in all the kinds already named. If, on the other hand, the flowering of the plant is prevented—or, in many cases, if it is merely prevented from ripening its seed—it will continue to live for a much longer period: the same bed of parsley, if regularly cut over, will remain productive for a number of years.

BIERVLIE'T, a village of the Netherlands, province of Zeeland, 13 miles east-north-east of Sluis. It is deserving of mention as the birthplace of William Beukels (q. v.), who in 1386 invented the method of curing herrings. In 1377, B. was detached from the mainland by an inundation, and still remains insular.

BIES-BO'SCH, a marshy sheet of water of the Netherlands, between the provinces North Brabant and South Holland, formed in November 1421 by an inundation which destroyed 72 villages and 100,000 people, and forming that part of the estuary of the Maas called Holland's Diep. It is interspersed with several islands.

BI'FFIN. See **APPLE**.

BIG HORN, a navigable river of the United States, rises near Fremont's Peak in the Rocky Mountains, about 42° 20' N., and 110° W. It has a north-east course of about 400 miles, being the largest affluent of the Yellowstone, which, again, is the largest affluent of the Missouri.

BIG SANDY RIVER, a fine navigable affluent of the Ohio, flows through extensive beds of coal. It is formed by the junction of two branches—the east and west forks—which both rise in Virginia. The latter traverses several counties of Kentucky, and the former is, during the latter part of its course, the boundary between the two states. Their united waters lose themselves in the Ohio, nearly opposite to Burlington, in the state of Ohio.

B'IGA, a Roman term applied in ancient times to vehicles drawn by two horses abreast; and commonly to the Roman chariot used in processions or in the circus. In shape it resembled the Greek war-chariot—a short body on two wheels, low, and open behind, where the charioteer entered, but higher and closed in front.

B'IGAMY. This is an offence which, although perfectly intelligible in itself to the popular and unprofessional understanding, is yet, with a due regard to the strict meaning of the word, extremely difficult, legally, to define. Blackstone objects to the use of it as a term descriptive of the offence in view; for he says it is corruptly so called, because B. properly signifies being *twice married*, which a man or a woman may legally be; and he therefore prefers the term *polygamy*. B., however, even according to the literal meaning, was an offence, or

rather disqualification, according to the canonists, who explained it to consist in marrying two virgins successively, one after the death of the other, or in once marrying a widow; and persons so offending or disqualified were held to be incapable of holy orders, and therefore B. was anciently considered a good counterplea to the claim of *benefit of clergy* (q. v.), although the law in that respect was afterwards altered by a statute passed in the reign of Edward VI., when, bigamists or no bigamists, the clergy resumed their strange privilege. Different views prevailed in more modern times, and at a period, too, when the restraints of ecclesiastical dogmas had been thrown off. It is known that certain of the leaders of the German reformation, including Luther, Melancthon, Bucer, and Melander did not withhold their consent from Philip, Landgrave of Hesse, champion of the Reformation, who, having lost conceit of his wife, had applied to the Protestant doctors for licence to have another, and which licence was not withheld, for the marriage took place, and was performed by Melander in presence of Melancthon, Bucer, and others; and *privately*, as the marriage-contract hears, 'to avoid scandal, seeing that, in modern times, it has not been usual to have two wives at once, although in this case it be Christian and lawful.' Whether Luther and the other Protestant doctors actually held views favourable to polygamy has been the subject of warm controversy (see Sir William Hamilton's *Discussions on Philosophy and Literature*, 1852, 2d ed., 1853; and Archdeacon Hare's *Vindication of Luther*, 1855). Sir William Hamilton asserts that Luther believed in 'the religious legality' of polygamy, and wished it to be sanctioned by the civil authorities—an assertion, however, of which the promised proof never appeared. Archdeacon Hare, on the other hand, maintains that Luther and Melancthon only held that in certain extraordinary emergencies dispensations from the usual law of marriage might be granted. Be that as it may, the conduct of the Reformation leaders in this matter has been universally condemned, even by Protestants. The ideas referred to never gained ground in Germany; while in Great Britain 'monogamy' not only continued an institution, but its violation was regarded as a serious offence, which continues to be treated in statutes, law-books, and in the practice of the criminal courts in the three kingdoms, under the name of *bigamy*. Nor, indeed, have the ideas referred to been followed by the Germans as a nation.

The first statute which distinctly treated this offence as a felony was the 1 James I. c. 11, which enacted that a person so convicted should suffer death. What now constitutes the English law regarding the crime of bigamy, is the 22d section of 9 Geo. IV. c. 31, passed in 1828. B. is there declared to be committed by 'any person who, being married, shall marry any other person during the life of the former husband or wife, whether the second marriage shall have taken place in England or elsewhere'—a definition that appears to be adopted by the recent Divorce Act, the 20 and 21 Vict. c. 85, where, for the purpose of that act, B. is to be taken to mean 'marriage of any person being married, to any other person during the life of the former husband or wife, whether the second marriage shall have taken place within the dominions of her Majesty, or elsewhere.' More correctly, however, the offence of B. may be said to consist in going through the *form* or *appearance* of a second marriage, while a first subsists, with a man or woman, against whom the most odious deceit and fraud is thus practised, and upon whom, especially in case of a woman, the deepest injury is inflicted; for the second marriage is merely a marriage in form

—no real marriages at all, because a man cannot have two wives, or a woman two husbands, at one and the same time. In prosecutions under this act, the first wife is not admissible as a witness against her husband, because she is the true wife; but the second may, because she is not only no wife at all, but because she stands in the position of being the party peculiarly injured by the bigamy. The same is the procedure in the case of a second husband. The act following the 1 James I. makes B. a felony, and prescribes as the punishment, upon conviction, transportation for seven years; now changed (by the 16 and 17 Vict. c. 99, amended by the 20 and 21 Vict. c. 3) to penal servitude for the same period, or not less than three years; or to be imprisoned, with or without hard labour, in the common jail or house of correction for any term not exceeding two years.

The act, however, excepts from its provisions the following four cases: 1. That of a second marriage contracted out of England, by any other than a subject of the realm. 2. That of any person marrying a second time, whose husband or wife shall have been continually absent from such person for the space of seven years then last past; and shall not have been known by such person to be living within that time. 3. That of a person who, at the time of such second marriage, shall have been delivered from the bond of the first marriage. 4. That of a person whose former marriage shall have been declared void by the sentence of any court of competent jurisdiction. The third of these exceptions deserves notice, in consequence of its bearing on a curious question that arose before the passing of the act, and which shewed a serious conflict which then existed, if it does not still exist, between the laws of England and Scotland. The case referred to is known among lawyers as *Lolley's case*; it occurred in 1812, and may be shortly stated as follows: Lolley and his wife, two English persons, being tired of each other's conjugal society, and unable to bear the expense of the then English ordeal, went to Scotland, where, after acquiring a domicile, they applied to the Scotch Consistorial Court for a divorce, which was speedily (although it is said collusively) obtained, on the ground of the husband's adultery. Relying on such sentence of the Scotch court, Lolley returned to England, where he married again. He was immediately indicted for B., tried, convicted, and sentenced to seven years' transportation, and that in the face of the Scotch decree of divorce, which he reasonably pleaded by way of defence. The point, however, was reserved for further consideration before the full court (Court of Exchequer), who, however, shortly after gave a unanimous judgment, holding that Lolley had been rightly convicted; or, in other words, that the Scotch court had no authority to dissolve an English marriage, and that the decree of divorce which Lolley had obtained, although good in Scotland, was of no force whatever in England. Many distinguished English lawyers were of opinion that the judgment of the English court was wrong, and that the Scotch divorce afforded him a complete defence. But it is to be observed that the prosecution was founded on the 1 James I. c. 11, to which we have referred, the 3d section of which only excepts from its provision persons divorced by 'any sentence had in the Ecclesiastical Court;' meaning, of course, the English Ecclesiastical Court; and thus some colour at least is given to the view taken of Lolley's case by the Court of Exchequer. But it may well be doubted whether such a conviction could take place in the face of the above third exception in the 9 Geo. IV., which excepts persons who shall have been divorced, not by any particular court or

jurisdiction, but simply divorced from the bonds of the first marriage.

It remains to be added, that under the 9 Geo. IV., not only the actual bigamist, but every person counselling, aiding, or abetting the offender, is held equally guilty, and may be sentenced to the same punishment; and by section 31, accessories before and after the fact are also severely punishable.

The 9 Geo. IV. does not extend to Scotland, but the law there on the subject of this particular offence is very much the same in principle, although the punishment there is not so severe as in England. There is an old Scotch statute, passed in 1551, which declares the punishment of B. to be the same as that of perjury; but the offence is also indictable at common law in Scotland, and in modern practice, it is usual so to deal with it, and to limit the punishment to imprisonment. See MARRIAGE, DIVORCE, POLYGAMY.

BIGG. See BARLEY.

BIGHT (from the same root as the verb 'to bow') is a sailor's name for the bent or doubled part of a rope. Thus, one anchor may 'hook the B.' of the cable of another, and thereby cause entanglement. In Geography, B. has much the same sense as 'bay.'

BIGNONIAÆ, a natural order of exogenous plants, containing trees, shrubs, and herbaceous plants, generally with compound leaves. The flowers are generally showy, and are among the most striking ornaments of tropical forests. The corolla is of one petal, generally more or less trumpet-shaped and irregular; the stamens are five in number, or four, with the rudiment of a fifth, and unequal. The ovary is free, seated on a disk, 1—2-celled; the fruit sometimes capsular, sometimes drupaceous; with few or many seeds. There are about 500 known species; which, however, are often regarded as forming three distinct orders—*Bignoniaceæ*, *Crescentiaceæ*, and *Pedaliaceæ*. Of these the *Bignoniaceæ* are by far the most numerous,



Bignonia picta.

and are almost all tropical or subtropical, although a few are found in the United States of North America. See TRUMPET-FLOWER. They are in many cases noble trees, and some of them afford

valuable timber, among which are *Bignonia leucocorylon*, a tree of Jamaica, the green or yellow wood of which is sometimes brought into the market under the name of Ebony; and the Ipe-tobacco and Ipe-una of Brazil, species of the same genus, the former of which is used for ship-building, and the latter is accounted the hardest timber in Brazil. Not a few of them are climbing shrubs, and the tough shoots of *Bignonia Cherere* are used for wicker-work in Guiana. *Bignonia alliacea*, a native of the West Indies, is remarkable for its strong alliaceous smell; the leaves of *Bignonia Chica* afford the red colouring matter called Chica (q. v.).—The *Crescentiaceae* chiefly abound in Mauritius and Madagascar. The Calabash Tree (q. v.) is the best known example.—The *Pedaliaceae* are tropical or subtropical; many of them herbaceous plants. The most important is *SESAMUM* (q. v.). The fleshy sweet root of *Cranioilaria annua* is preserved in sugar as a delicacy by the Creoles.

BIHA'CH, or **BICHA' CZ**, one of the strongest fortress-towns of Croatia, European Turkey, is situated on an island in the Una, in lat. 44° 43' N., and long. 15° 53' E., near the frontier of Dalmatia. It has been the scene of frequent contests during the Turkish wars. Formerly, it was possessed of a Christian church, but that has been completely destroyed by fanatic Mussulmans. Pop. 3000.

BIJANAGHU'R, meaning, it is said, *the City of Triumph*, is a ruined city within the presidency of Madras, being in lat. 15° 19' N., and long. 76° 32' E. It stands about 40 miles to the north-west of Bellary, in a plain encumbered with granite rocks, many of which have been rudely sculptured into a variety of forms. After having been for two centuries the metropolis of a powerful Hindu kingdom, B. was sacked and ruined by the Moham-medans of the Deccan in 1564. Even now it presents traces of its grandeur, being 8 miles in circuit, and containing many edifices, both temples and palaces, of granite.

BIJBABA'R, the largest town of Cashmere, next to the capital Cashmere itself. It is situated on the banks of the Jailum, about 25 miles to the south-east of the metropolis, being in lat. 33° 47' N., and long. 75° 13' E. The only particular worthy of notice is a wooden bridge across the Jailum, which, notwithstanding its simplicity and fragility, has endured for centuries, in consequence of the tranquil and equable weather of the valley.

BIKH. See **ACONITE**.

BI'LANDER, or **BILANDRE**, is a small two-masted merchant-vessel, distinguished from others chiefly by a peculiar shape and arrangement of the main-sail. Of these vessels, which were probably French in origin, there are not many now remaining.

BILBA'O, a seaport town of Spain, capital of the province of Vizcaya (Biscay), is situated in a mountain gorge on the Nervion, about 6 miles from its mouth at Portugalete, in lat. 43° 14' N., long. 2° 56' W. B. is well built; the principal streets are straight, and the houses substantial and imposing. Two suspension bridges, and a stone bridge of the 14th c., cross the river, which divides the old town from the new. There are several fine public walks, numerous fountains, but no public buildings of any note. The city is purely commercial. It has many extensive rope-walks and manufactures of hardware, leather, hats, tobacco, and earthenware. Pop. 15,000. Small vessels can navigate the river quite up to the town, but large vessels have to anchor at Portugalete. The number of ships entering B. in 1856 was 379, with a capacity of 27,657 tons; clearing outwards, 535 vessels, tonnage, 34,117. In the same year, the value of the imports, which consist chiefly of cotton

and woollen manufactures, colonial produce, fish, &c., was 85,586,888 reals (£855,868); and the value of the exports, consisting of wool, iron, fruits, oil, &c., 24,604,572 reals (£246,045). As compared with 1855, both the shipping and exports exhibited a decrease. There are more than 200 commercial houses in B., among which are several German, Bohemian, and Irish. The women here do almost all of the heavy portage. B. was founded in the year 1300 by Diego Lopez de Haro, under the name of Belvao, i. e., 'the fine fort,' and being well situated, and little disturbed by the civil wars of Spain, it soon attained great prosperity. In the 15th c., it was the seat of the most authoritative commercial tribunal in Spain. It suffered severely in the wars with France, first in 1795, and again in 1808, when 1200 of its inhabitants were slaughtered in cold blood. During the Carlist civil war, B. was exposed to two severe sieges.

BI'L BERRY. See **WHORTLEBERRY**.

BI'L BILIS, an old Iberian city of Spain, about two miles east from the modern town of Calatayud, in the province of Saragossa, chiefly celebrated as the birthplace of the poet Martial, but also famed for its highly tempered steel blades. Quintus Metellus won a victory over Sertorius here; and B., under the Romans, was a municipal town with the surname of Augusta. Several of its coins, struck off during the reigns of Augustus, Tiberius, and Caligula, are still in existence—some in the British Museum.

BI'LBOES are long bars or bolts of iron, with shackles sliding on them, and a lock at one end. When an offender on shipboard is 'put in irons,' it implies that B. are fastened to him, more or less ponderous according to the degree of his offence. The B. clasp the ankles in some such way as handcuffs clasp the wrist.

BI' L COCK. See **RAIL**.

BILDERDIJK, **WILEM**, a Dutch poet and philologist, of much repute in his day, was born at Amsterdam, 7th September 1756. While studying law at Leyden, and afterwards, when practising at the Hague, he devoted himself assiduously to literature and poetry. On the invasion of Holland by the French, he repaired to Brunswick, and afterwards visited London, where he supported himself by lecturing and teaching. In the year 1806, he returned to Holland, where he was received as one who had done his country honour; and the newly elected king of Holland (Louis Bonaparte) appointed him president of the Institute at Amsterdam, just then organised after the fashion of the one at Paris, and also made him his own instructor in the Dutch language. B. afterwards resided at Leyden, and then at Haarlem, where he died 18th December 1831. His contributions to poetic literature were very numerous; but though they contain many beauties, yet, with one or two exceptions, none of his poems display any remarkable originality, or any great wealth of imagination. With his poetical pursuits he combined the theoretical study of his native language; and his writings on this subject are valuable contributions to the exposition of the older monuments of Dutch literature.

BILE is a fluid secreted from the blood by the liver. One part of it is destined to serve in the process of digestion; the other to be eliminated from the system. It is coloured yellow in man; that of graminivorous animals seems coloured by the leaves they feed upon. The primary cells of the liver (the hepatic cells) separate the B. from the blood of the portal vein, and discharge it into small ducts, which unite to form larger ones, and eventually the right and left hepatic ducts.

The latter unite to form the common hepatic duct, which is soon joined by that of the gall-bladder (the cystic duct). This junction forms the common B. duct, which pierces the second part of the duodenum, and running obliquely in its wall for a short distance, opens on its mucous surface.

The secretion of B. is constantly going on, and if there is food in the intestine, the bile mingles with it, and dissolves the fatty portions, preparatory to their absorption, the excrementitious portion of the B. passing out of the body with the other indigestible materials. When the bowel is empty, the B. ascends the cystic duct, and is stored for future use in a small flask-like bag (the gall-bladder) situated under the liver.

Should, from any cause, the elements of the B. be in excess in the blood, or should the liver suspend the function of secreting it, not only is digestion imperfectly performed, but the general health suffers from the impure condition of the blood, and the patient is said to be *bilious*. On the other hand, the B. may be secreted, but its escape interfered with, and then its reabsorption will produce jaundice (q. v.). Its solid portions, again, especially the cholesterine, may be in excess, solidify, and produce biliary calculi or gall-stones (q. v.).

In *chemical composition*, B. is essentially a soap analogous to resin-soap, and as obtained from the ox, contains in 100 parts,

Water,	90.44
Biliary and fatty bodies, including } resinoid acids, }	8.00
Mucus,	0.30
Watery extract, chlorides, phos- } phates, and lactates, }	0.85
Soda,	0.41

The soap is formed from the union of the resinoid acids (*Glycocholic* and *Taurocholic Acids*) with the soda. Human B. has the specific gravity of about 1026 (water = 1000), is of aropy consistence, with a yellowish-green colour; does not readily mix with water, but sinks therein, and only after repeated agitation becomes diffused through the water, which then assumes a frothy appearance resembling soap-suds. B. has a bitter taste, and a very sickening musky odour. It is interesting to observe that the B. of salt-water fishes contains potash in place of soda; although, from their being surrounded by much common salt (chloride of sodium) in the sea-water, we should naturally expect to find soda in abundance; and the B. of land and fresh-water animals contains soda, while, considering diet and habitat, potash might more naturally be looked for in largest quantity. B. performs important functions in the animal economy, which will be considered under NUTRITION; see also LIVER.

BILEDULGERID. See BELED-EL-JERID.

BILGE, sometimes spelled **BULGE**, is the part of the bottom of a ship nearest to the keel, and always more nearly horizontal than vertical. A ship usually rests on the keel and one B. when aground. The name of *bilge-water* is given to any rain or sea water which trickles down to the B. or lowest part of a ship, and which, being difficult of access, becomes dirty and offensive.

BILGEWAYS are timbers which assist in the launching of a ship; for which, see LAUNCHING.

BILIARY CALCULI. See GALL STONES.

BILIMBI. See CARAMBOLA.

BILIN, a town of Bohemia, beautifully situated in the valley of the Bila, 17 miles west of Leitmeritz, and famous for its mineral springs, the waters of which it exports to the extent of 500,000 jars

annually. It has a manufactory of cotton yarn, and two castles, an old and a new one. In its vicinity, there is a remarkable isolated clinkstone rock, called Borzenberg, or Biliner Stein; and the Tripoli earth found at B. has been shewn by Professor Ehrenberg to be the remains of infusoria. Pop. about 3000.

BILIOUS FEVER. See LIVER.

BILL, in Natural History, the hard, horny mouth of birds (q. v.). It consists of two *mandibles*, an upper and a lower, into which the upper and lower jaws are respectively produced, all appearance of lips being lost. It is not furnished with proper teeth, although rudiments of them have been observed in some of the parrot tribe in the foetal state, and the marginal laminae with which the bills of many water-fowl are furnished, partake of the same character, being secreted by distinct pulps. The resemblance of these marginal laminae to teeth is particularly marked in the Goosander (q. v.). The bills of birds differ much, according to their different habits, and particularly according to the kind of food on which they are destined to live, and the manner in which they are to seek it. In birds of prey, the B. is strong; the upper mandible arched or hooked, and very sharp; the edges sharp, often notched, and the whole B., or *beak*, adapted for seizing animals, and tearing and cutting to pieces their flesh. A powerful, short, hooked beak, sharp edged and notched, indicates the greatest courage and adaptation to prey on living animals. The beak of the vulture is longer and weaker than that of the eagle or falcon. In birds which feed on insects and vegetable substances, the hooked form of the B. is not found, or it is in a very inferior degree; those birds which catch insects on the wing, such as the Goat-suckers, are remarkable for the deep division

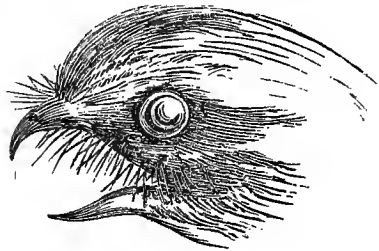

Bill of Goat-sucker (Insect-eating bird).

of the B., and their consequently wide gape, and an analogous provision to facilitate the taking of prey is to be observed in herons, kingfishers, and other fishing-birds; but the object is attained in their case by the elongation of the B., whereas birds which catch insects on the wing have the B. very short. Birds which feed chiefly on seeds have the B. short and strong, for bruising them; whilst the B. of insectivorous birds is comparatively slender. Many aquatic birds have broad and comparatively soft and sensitive bills, with laminae on the inner margin for straining the mud from which much of their food is to be extracted;



Bill of Bunting (Seed-eating bird).

other birds, as snipes, avocets, &c., seeking their food also in mud, have slender bills of remarkable sensibility. The modifications of form are

very numerous, and the peculiarities of the bills of toucans, hornbills, spoonbills, crossbills, parrots, humming-birds, &c., are very interesting, and intimately connected with the habits of the different creatures. (See these articles.) At the base of the upper mandible, a portion of the B. is covered with a membrane, called the *cere* (Lat. *cera*, wax, from the waxy appearance which it presents in some falcons, &c.), which in many birds is naked, in others is feathered, and in many is covered with hairs or bristles. The nostrils are situated in the upper mandible, usually in the *cere*, but in some birds they are comparatively far forward, and in some, as puffins, they are very small, and placed so near the edge of the mandible, as not to be easily detected. They are more or less open, or covered with membrane, or protected by hairs or feathers. Besides their principal use for seizing and dividing or triturating food, the bills of birds are employed in a variety of functions, as dressing or preening the feathers, constructing nests, &c. They are also the principal instruments used by birds in their combats.

The mouths of some fishes and reptiles assume a character somewhat analogous to that of the B. of birds.

BILL, in its general acceptation, means a formal written paper or statement of any kind; originally, it was applied to any sealed document, being derived from Lat. *bullā*, a seal. It has a number of technical applications, for which see the articles that immediately follow.

BILL OF ADVENTURE is a writing by a merchant, stating that goods shipped by him, and in his name, are the property of another, whose *adventure* or chance the transaction is—the shipping merchant, on the other hand, undertaking to account to the adventurer for the produce. Generally, in commercial law, an adventure may be said to be a speculation in goods shipped under the care of a *supercargo*, to be disposed of by him to the best advantage, for the benefit of his employers.

BILL OF ATTAINDER, and BILL OF PAINS AND PENALTIES, are bills in parliament, introduced for penally enacting the attaind and punishment of persons who have criminally offended against the state and public peace. Such a legislative proceeding was had recourse to generally in times of turbulence, when, either from the peculiar nature of the offence, or in consequence of difficulties in the application of the ordinary laws, it became necessary to resort to parliament. During the reign of Henry VIII., persons of the highest rank were frequently brought to the scaffold by such means; among whom may be mentioned the Earl of Surrey, the Earl of Essex, and others, who suffered for denying the king's supremacy; and during other reigns, both before and after that of Henry VIII., these bills were more or less had recourse to. There were greater facilities for conviction by this penal legislation than by the ordinary judicial procedure at law; because, while in the latter the strict rules of legal evidence must have been observed, the inquiry under a bill of attainder, or of pains and penalties, was entirely in the hands of parliament, who might dispense at their pleasure with such rules and forms of law as appeared inconvenient or unsuitable to the purpose in hand. Accordingly, in most of the cases to which we have referred, the bills were passed upon evidence which could never have been received as sufficient, or even admissible in a court of law; and there are even instances where parties were attainded, and punished, without there being any evidence against them at all, and even without

their being heard in their defence. Under the Stuarts, this extraordinary mode of proceeding in parliament was seldom had recourse to in England, and it has been still seldomer used since the accession of the House of Hanover. The Jacobite movement in Scotland, after the union with that country, was productive of several instances of parliamentary attainder, which, however, resulted merely in the forfeiture of the estates of the attainted parties, and these attainders were likewise unattended with the harsh, and in too many instances, capital consequences, which were formerly the inevitable results of treason so discovered. In regard to bills of pains and penalties, perhaps the two most remarkable instances are those of Bishop Atterbury, in 1722 (see **ATTERBURY**), and of Queen Caroline, wife of George IV., in 1820.

The proceedings of parliament in passing bills of attainder, and of pains and penalties, do not vary from those adopted in regard to other bills. But the parties who are subjected to these proceedings are admitted to defend themselves by council and witnesses before both Houses. In the best of times, this summary power of parliament to punish criminals by statute, should be regarded with jealousy; but whenever a fitting occasion arises for its exercise, it is undoubtedly the highest form of parliamentary judicature. In impeachments, the Commons are but accusers and advocates; while the Lords alone are judges of the crime. On the other hand, in passing bills of attainder, the Commons commit themselves by no accusation, nor are their powers directed against the offender; but they are judges of equal jurisdiction, and with the same responsibilities as the Lords; and the accused can only be condemned by the unanimous judgment of the Crown, the Lords, and the Commons.—*May's Proceedings of Parliament*, 3d edition, p. 509. In passing bills of attainder, the bishops, contrary to the practice in capital impeachments, take part in the proceedings, and vote.

In such parliamentary attainders, the bill sets out, by way of preamble, the facts and evidence on which it is founded, and concludes, by way of enactment, that the accused 'is hereby convicted and attainded of high treason, and shall suffer the pains of death, and incur all forfeitures as a person attainded of high treason.' In the case of pains and penalties, again, the preamble generally assumes the facts as proved, and proceeds to enact the pains and penalties; that is, the deprivations, indignities, and other punishment awarded. See **ATTAINDER, PAINS AND PENALTIES, BILL IN PARLIAMENT**.

BILL, or BILL OF COMPLAINT, IN CHANCERY, is the formal statement in writing or pleading, by which a plaintiff in the Court of Chancery seeks its equitable redress or relief. It is in the style of a petition addressed to the Lord Chancellor, Lord Keeper, or Lords Commissioners for the Custody of the Great Seal, unless the seals are at the time in the Queen's hands, or the chancellor himself be the suitor, in which case, the bill is addressed to the Queen herself; for, according to the theory of the Court of Chancery, it is the conscience of the sovereign that is there addressed. The crown itself, however, may be the suitor, either on behalf of its own prerogatives, or of those rights which are under its particular protection; such as the objects of a public charity, and then the matter of complaint is submitted to the court, not by way of bill or petition, but of *information*, which the proceeding is accordingly technically called.

In stating the plaintiff's case, the bill was formerly exceedingly prolix and tedious, but it has been very much simplified, and now contains merely a full and distinct account of the case, the material

BILL OF COSTS—BILL OF EXCHANGE.

facts and circumstances relied on; and it should pray specifically for the particular relief which the plaintiff conceives himself entitled to, and also for general relief, or, as the bill itself usually states, 'for such further and other relief as the court may think proper;' the object and advantage of which general prayer is, to decree equity and justice without regard to the particular equity sought for. It is indispensable that the bill be signed by counsel, in order to guard against irrelevant and improper matter. It is indeed usually not only signed but drawn by counsel, from instructions laid before him by the plaintiff's solicitor.

Where the object is the administration of the estate of a deceased person, the procedure is by *summons*, and is of a simple and very summary nature. In cases of this description, without either formal pleading or any direct application to the court itself, a summons may at once be obtained, and the estate thereupon put in a course of administration. There are also cases where the chancellor's aid is sought for in the form of a *petition*.

Generally speaking, the modern English bill in Chancery very much resembles the Scotch *summons* and *condescendence*. See on the subject of this article, **EQUITY, SUIT IN; CHANCERY; CHANCELLOR, LORD; PLEADING; SUMMONS; CONDESCENDENCE.**

BILL OF COSTS is an account stating articulately and in detail the charges and disbursements of an attorney or solicitor in the conduct of his client's business; and which costs may be recovered under the regulations of the Attorneys' and Solicitors' Act, 6 and 7 Vict. c. 73. See **COSTS.**

BILL IN CRIMINAL CASES is the formal name of an indictment for a crime or misdemeanour, when preferred before a grand jury. If that body finds 'a true bill,' the prisoner or party accused is thereupon tried before a petty jury, whose verdict determines his guilt or his innocence; but if the grand jury 'ignore the bill,' the accused is at once set at liberty. In the latter event, however, other bills may be sent up against him, with or without the same result. See **ARRAIGNMENT, GRAND JURY, INDICTMENT, PROSECUTION, TRIAL.**

BILL OF EXCEPTIONS is a statement of objections, by way of appeal, against the ruling or charge of a judge in a civil cause. See **TRIAL.**

BILL OF EXCHANGE, a document purporting to be an instrument of pecuniary obligation for value received, and which is employed for the purpose of settling a debt in a manner convenient to the parties concerned. The original and simple idea of a bill is this: Two parties residing at a distance from each other can settle their transactions without the trouble or risk of sending money direct from the debtor to the creditor. Thus, A and B are two parties in business in London; and C and D are merchants in Cadiz. A owes C £1000; and D owes B a like sum. Instead of A sending cash to C, and D to B, A pays B and receives B's bill on D, which he sends to C, who receives the amount from D; so that the transaction throughout is settled, without a farthing in money being sent from Cadiz to London, or from London to Cadiz. Another simple idea of a bill is this: One person owes another £100 for goods, for which he is to have credit for three months. The creditor, however, not being able conveniently to be without the money for that length of time, gets from the debtor an obligation or bill bearing that the £100 is to be paid in three months. This bill, being a negotiable instrument, will be discounted by a banker, or other capitalist, who now stands in the position of the creditor, and receives payment when the bill is due. Thus, a bill of

exchange performs two kinds of offices in commerce—it saves the transmission of coined money, and it enables creditors not only to fix down debtors to a day of payment, but to get the use of a sum equivalent to the debt (less a small discount) before it is properly due.

The origin of this important mercantile instrument is attributed by Montesquieu and others to the Jews and Lombards, when banished from France and England in the 13th c., for their usury and other alleged vices, in order the more easily to recover the effects they had left behind in these countries; but Blackstone shews its earlier use in the Mogul Empire in China; and Depauw, in his *Philosophical Researches respecting the Greeks*, has attempted to prove that bills of exchange were in use among that people, and particularly among the Athenians. However this may be, it is certain that hitherto no trace of them has been discovered either in the Roman code, or in any other system of ancient jurisprudence. The first notice of them in modern times occurs about the middle of the 12th c., and by the end of the 14th they had got into general use in all the commercial states of Europe. In England, from about the middle of the 14th c. down to the time of James I., and for many years after, bills of exchange were restricted to the purposes of foreign commerce. What are called inland bills—that is, bills drawn by and upon persons resident in this country—were not employed much earlier than the reign of Charles II., and even then they were regarded with distrust and jealousy by the English judges. Another restriction upon bills of exchange was, that the privilege of their use was confined to parties that were merchants; and there is an old case tried by the Court of King's Bench, in the days of William and Mary, where it was decided that an action on a foreign bill of exchange could not be maintained, because the defendant was a *gentleman*, and not a merchant! But all restraints on such instruments gradually yielded to the wants and conveniences of society, and now any one capable of making a contract can be a party to a bill transaction, without regard to position, calling, or occupation. In Scotland, inland bills were put on the same footing with foreign bills, by an act of the Scottish parliament passed in 1696.

A bill of exchange, as distinguished from a *promissory-note* (q. v.), is defined in law-books to be a written and open letter of request, addressed by a person who is called the drawer, to another person called the drawee, desiring him to pay a certain sum of money, either to the drawer himself, or to a third party called the payee, within a certain time after its date, or after it is presented for payment, or on demand. If the drawee signs the bill in token of his agreeing to this request, he is called the *acceptor*. For the constitution of the bill itself, no particular form of words is necessary, provided its characteristic qualities clearly appear on the face of it, as an essentially pecuniary instrument; a bill of exchange is only good for a certain sum in money: such an instrument for the delivery of *goods* or property other than money, would be invalid. But although no particular words are required in a bill or note, it is always advisable to adhere, as much as possible, to their customary form. To this general rule, however, there are exceptions: thus, by the 48 Geo. III. c. 88, negotiable bills or notes for less than 20s. are void; and by the 17 Geo. III. c. 30, s. 1—made perpetual by the 27 Geo. III. c. 16, and 7 Geo. IV. c. 6—such bills and notes under 20s. are illegal, and above this amount and less than £5, are also void, unless they specify the name and place of abode of the

BILL OF EXCHANGE.

person to whom, or to whose order they are made payable, and are attested by one subscribed witness at the least, and bear date at or before the time when they are issued, and are made payable within twenty-one days after the date, and are in the form prescribed by the act. There are also certain forms prescribed with respect to cheques, and with respect to bills and notes issued and reissuable by bankers at certain distances.

In regard to foreign bills, the risk of miscarriage to which they are liable in their transmission to distant countries has given rise to the custom of drawing them *in sets*; that is, writing out two or three of the same form and tenor, and transmitting them to the payee by different channels, so that if one or two of the individuals of any set are lost, the other might reach its destination. The first of the set that is presented and accepted is alone entitled to payment, and payment of it discharges the acceptor; but foreign bills, of course, may also be drawn singly.

Besides the other requisites mentioned, bills of exchange must be duly *stamped*. The regulations on this subject are contained in the 17 and 18 Vict. c. 83, and are to be found in almanacs and other publications in common use. By sections 3 and 5 of the Act, it is provided that the duties on bills drawn out of the United Kingdom shall be denoted by adhesive stamps, to be affixed by the holder of the bill before negotiating it, under a penalty of £50.

The following are the usual forms of the bills of exchange.

FORM OF A FOREIGN BILL.

£1000. JAMAICA, 1st January 1860.
Fifty days after sight of this First of Exchange (second and third unpaid) pay to the order of A. B. One Thousand Pounds sterling, value received.

To E. F., London.

C. D.

FORM OF AN INLAND BILL.

£100. LONDON, 1st January 1858.
(Stamp.) Two months after date [or 'at sight,' or 'on demand,' or 'at — days after sight'], pay to Mr —, or order, One Hundred Pounds, for value received.

To MR —, Merchant, }
Bristol, payable at —. }

C. D.

FORM OF A BILL ABOVE ONE AND UNDER FIVE POUNDS.

As prescribed by Stat. 17 Geo. III. c. 30. [Insert the place, day, month, and year, when and where made.]

Twenty-one days after date, pay to A. B. of —, or his order, the sum of —, value received.

To E. F. of — }
Witness, G. H. }

E. D.

From the first form it will be seen that there are usually three parties to a Bill of Exchange, these three being: 1st, The *drawer* (C. D.); 2d, The *payee*, or party in whose favour the bill is drawn, and who is entitled to receive the contents (A. B.); and 3d, The *acceptor* or *drawee* (E. F.). The transaction, however, may be simply between the drawer and acceptor, without the interposition of a third party; and there are other modifications and changes of form, according to the circumstances of the case, and the mode in which it is desired to have the bill negotiated. The bill being thus in proper form, and duly authenticated, is then presented for acceptance, which may be defined to be the act by which the drawee evinces his consent to comply with, and be bound by, the request contained in the Bill of Exchange directed to him; or, in other words, it is an engagement to pay in money the bill when

due. While the bill is in the possession of A. B. he is the holder, but if he pass it to G. H., A. B. is the indorser and G. H. the indorsee or ultimate holder. Acceptance in the case both of inland and foreign Bills of Exchange must now be in writing on the bill, and signed by the acceptor, or some person duly authorised by him. In England, the mode of acceptance is by the acceptor simply signing his name across the bill, or with the word 'accepted' before his name; but in Scotland acceptance is usually made by the acceptor signing his name immediately under the drawer. There are certain precautions to be observed before accepting. The drawee should, upon presentment for acceptance, and before he accepts, assure himself that the signature of the drawer is genuine, and that there has not been a fraudulent substitution of a larger sum than that originally inserted in the bill by the drawer. And if the drawee accept a forged bill, or a bill for a larger amount than that originally named by the drawer, he will nevertheless be liable to pay a *bona-fide* holder; nor will he have any right to recover against the drawer for the larger amount. There is also acceptance *supra protest*, which takes place where, after a foreign bill has been protested for non-acceptance, but not before, the drawee or any other person may accept it *supra protest*, which acceptance is so called from the manner in which it is made. And where the drawee of a foreign bill cannot be found, or is not capable of making a contract, or refuses to accept, this description of acceptance is frequently made in order to save the credit of all or some of the parties to the bill, and prevent legal proceedings. In this country it is called an acceptance for the honour of the person or persons for whose use it is made, and in France an acceptance *par intervention*. It had been a question in England what amounted to a qualified acceptance, but that was set at rest by the 1 and 2 Geo. IV. c. 78 for England, and 9 Geo. IV. c. 24 for Ireland, which required an acceptance, in order to be a qualified acceptance, to express that the bill is 'payable at a banker's house or other place only, and not otherwise or elsewhere.' And now, as against the acceptor, the absence of these words from the acceptance leaves it at large, an unqualified acceptance, not requiring presentment at a particular place, notwithstanding that, in the body of the instrument, a particular place of payment is expressly specified by the drawer. There may likewise be conditional acceptance—that is, acceptance in such a form as will subject the acceptor to payment of the bill on a contingency only, of which there are numerous examples in the law reports; for instance, to pay 'as remitted for,' or on account of the ship *Thisis*, when in cash, for the said 'vessel's cargo,' or on condition of getting a certain house by a given term, or when certain goods are sold, or when certain funds come to hand.

The bill as a negotiable instrument being thus complete in all its parts, may either be held by the drawer or other payee till due, when it may be presented for payment to the acceptor, or it may at once be transferred by *indorsement* (q. v.), the indorsee taking it for its value at maturity, and in the meantime cashing or discounting it to the holder. There may be a succession of indorsees, the last of whom is entitled to payment; and to him all the other indorsees, as well as the drawee and drawer, are bound.

When the bill comes to maturity—that is, when the period arrives for its presentment—it must either be at once paid, or the parties must arrange for its *renewal* (q. v.). If the latter course is not agreed on, and the necessary funds are not forthcoming, the holder can only then proceed to recover at law; and this is now done in a very speedy form under

BILL—BILL OF SALE.

a recent act, the 18 and 19 Vict. c. 67. This act, however, does not extend to Ireland, where the old form of action still prevails. But in Scotland payment of bills may be enforced even more summarily without any action, under the severe provisions of two old Scotch acts passed in 1681 and 1696. See **INDORSEMENT**, **PROMISSORY-NOTE**, **RENEWAL**. Bills are sometimes drawn 'at sight,' 'on demand,' or at 'one day's date;' and in these cases it is doubtful whether the three days of grace allowed for payment beyond the literal time specified in the document are applicable. Unless in special cases, bills, by the Statute of Limitations (q. v.) in England, and by Prescription (q. v.) in Scotland, do not cease to be valid documents for six years.

In the United States there has sprung up a method of dealing with bills of exchange which is not much known in England. This consists in selling bills without a concurrent obligation by indorsement to make them good. Instead of discounting his bills in the usual form through a banker, a merchant in New York will sell his bills to a broker or dealer in this kind of instrument, the price paid being according to the state of the money-market and the creditworthiness of the acceptor. In such cases, the purchaser stands in the place of the drawer, undertakes all risks, and as custodian of the bill, has the power of legally exacting payment. This method of transacting with bills is called discounting *without recourse*.

ACCOMMODATION BILL. A bill in its legitimate sense is a document constituting a debt, and as such is beneficial to all parties connected with its negotiation. A owes B £100. A cannot conveniently pay the amount, while B is in need of it; B draws on A, and C (a banker) discounts, i. e., for a consideration pays the amount to B. B thus gets his money at once, A obtains time, while C makes a profit for advancing. These facilities have had the effect of inducing bills to be resorted to for raising money where no value is given, and in which one party gives the use of his name for the *accommodation* of another. In the above case, for example, let us suppose that A does not owe B, but yet accepts B's draft. If C discounts the bill, it is immaterial whether he knows that A has got value or not—as an onerous holder, he can compel payment from A if B cannot pay the bill. But if merely in B's hands, the amount is not recoverable from A if the latter can prove that no value was received by him. Accommodation bills give rise to much fraud and rash speculation, and many attempts have been made to suppress the system; but it is difficult to do so without unduly interfering with the negotiation of *bona-fide* bills.

BILL, EXCHEQUER. See **EXCHEQUER BILL**.

BILL OF HEALTH, a certificate or instrument, signed by consuls or other proper authorities, delivered to the masters of ships at the time of their clearing out from all ports or places suspected of being particularly subject to infectious disorders, certifying the state of health at the time that such ship sailed. A *clean* bill imports that at the time the ship sailed no infectious disorder was known to exist. A *suspected* bill, commonly called a *touched* patent or bill, imports that there were rumours of an infectious disorder, but it had not actually appeared. A *foul* bill, or the absence of a clean bill, imports that the place was infected when the vessel sailed. See *M'Culloch's Commercial Dictionary*.

BILL OF INDEMNITY, an act of parliament, passed every session, for the relief of those who have unwittingly or unavoidably neglected to take the necessary oaths, &c., required for the purpose of

qualifying them to hold their respective offices. See **ACT OF INDEMNITY**, and **ABJURATION**.

BILL OF LADING is a receipt from the captain of the vessel to the shipper (usually termed the *consignor*), undertaking to deliver the goods—on payment of freight—to some person whose name is therein expressed, or indorsed thereon by the consignor; and the delivery of this instrument— independently of the actual delivery of the goods— will suffice to pass and transfer to the party so named (usually termed the *consignee*), or to any other person whose name he may think fit to indorse thereon, the property in such goods; and by a recent statute, 18 and 19 Vict. c. 111, it is now expressly provided that every consignee and every indorsee of a B. of L. shall also have transferred to him all rights of suit, and be subject to the same liabilities in respect of the goods as if the contract in the B. of L. had been made with himself. It is also provided that every B. of L. shall be conclusive evidence of the shipment made. The act, however, declares that nothing contained in it shall prejudice or affect any right *in transitu*, or any right to claim freight against the original shipper or owner, or any liability of the consignee or indorsee, by reason or in consequence of his being such consignee or indorsee, or of his receipt of the goods, by reason or in consequence of such consignment or indorsement. See **STOPPAGE IN TRANSITU**.

BILLS OF MORTALITY are accounts of the births and deaths within a certain district; and they were an expedient, with the view of communicating to the inhabitants of London, to the court, and to the constituted authorities of the city, accurate information respecting the increase or decrease in the number of deaths. These bills were commenced in 1592, during a time when the plague was busy with its ravages; but they were not continued uninterruptedly until the occurrence of another plague in 1603, from which period, up to the present time, they have been continued from week to week, excepting during the great fire, when the deaths of two or three weeks were given in one bill. In 1605, the parishes comprised within the B. of M. included the 97 parishes within the walls, 16 parishes without the walls, and 6 contiguous out-parishes in Middlesex and Surrey. In 1662, the city of Westminster was included in the bills; in 1636, the parishes of Islington, Lambeth, Stepney, Newington, Hackney, and Redriff. Other additions were made from time to time. At present, the weekly B. of M. include the 97 parishes within the walls, 17 parishes without the walls, 24 out-parishes in Middlesex and Surrey, including the district churches, and 10 parishes in the city and liberties of Westminster. The parishes of Marylebone and St Pancras, with some others, which, at the beginning of last century, had only 9150 inhabitants, but now contain a rapidly increasing population, were never included in the bills.

But these bills are now, from want of proper machinery, of little or no value, and the only true bill is now that prepared at the Registrar-general's office, under the new Registration Act. The first of these weekly bills was commenced January 11, 1840, and the series has been continued from that time without interruption. See *Wharton's Law Dictionary*, 2d edition, 1860, and *Knight's London*.

BILL IN PARLIAMENT. See **ACT OF PARLIAMENT** and **PARLIAMENT**.

BILL OF RIGHTS. See **RIGHTS, BILL OF**.

BILL OF SALE is a writing under seal, evidencing a grant or assignment of chattels personal. The occasions to which these instruments are commonly made applicable are sales of fixtures and furniture

BILL OF SIGHT—BILLARDIERA.

in a house, of the stock of a shop, of the good-will of a business, of an office, or the like. But their most important use is in the transfer of property in ships, which being held in shares, cannot, in general, be delivered over on each change of part-ownership. Such B. of S. may be either absolute or conditional; in the former case, operating as a conveyance, and in the latter, as a security. By the 17 and 18 Vict. c. 36, passed to prevent frauds upon creditors by secret bills of S., it is provided that every B. of S. must be filed in the Court of Queen's Bench within 21 days after its execution, together with an affidavit of the time of such B. of S. being given, and a description of the residence and occupation of the deponent, and of every attesting witness of such B. of S., otherwise it will be void, as against assignees in bankruptcy and insolvency, and creditors. The residence and occupation of each attesting witness should appear in the B. of S., and also in the affidavit.

Notwithstanding these precautions, the practice of disposing of various kinds of movable property, more particularly household furniture and stocks of goods in trade by B. of S., leads to great and injurious deceptions; for as the seller, by an arrangement with the buyer, sometimes retains possession, and is in the eye of the world as much the proprietor as ever, he is enabled to carry on his affairs and get credit as usual. See REPUTED OWNERSHIP.

BILL OF SIGHT. The law on this subject is regulated by the Customs Regulation Act, 3 and 4 Will. IV. c. 52, s. 24 and 25, and is to the effect that when a merchant is ignorant of the real quantities or qualities of any goods assigned to him, so that he is unable to make a perfect entry of them, he must acquaint the collector or comptroller of the circumstance; and the collector is authorised, upon the importer or his agent making oath that he cannot, for want of full information, make a perfect entry, to receive an entry by B. of S. for the packages, by the best description which can be given, and to grant warrant that the same may be landed and examined by the importer, in presence of the officers; and within three days after any goods shall have been so landed, the importer shall make a perfect entry, and shall either pay down the duties, or shall duly warehouse the same. In default of perfect entry within three days, such goods are to be taken to the Queen's warehouse; and if the importer shall not within one month make perfect entry, and pay the duties thereon, or on such parts as can be entered for home-use, together with charges of moving and warehouse rents, such goods shall be sold for payment of the duties.

BILL OF STORE, a licence under the Customs Regulation Act, the 3 and 4 Will. IV. c. 52, granted by the Custom-house to merchants to carry such stores and provisions as are necessary for a voyage, custom-free.

BILL OF VICTUALLING, or VICTUALLING BILL, is a document relating to the stores put on board a ship when leaving a British port; it is a safeguard in reference to customs' duties, and is regulated by a clause in an act passed in 1853. The master of a ship, on leaving a British port, for a voyage which (out and home) will not occupy less than 40 days, receives from the customs' authorities an order or permission for the shipment of such stores and victuals as may be required—the data being the number of crew and passengers, and the probable duration of the voyage. When these are shipped, the master prepares a correct account of them, and of any other stores at that time in the vessel; and this account, when approved and countersigned by the customs' officers, constitutes the victualling bill. No stores are allowed to be taken on board the ship,

nor any articles taken on board to be deemed as stores, unless they be specified in this document.

BILL-BROKERS are persons who, being skilled in the money-market, the state of mercantile and personal credit, and the rates of exchange, engage, either for their own profitable adventure, or that of their employers, in the purchase and sale of foreign and inland bills of exchange, and promissory-notes. They are to be distinguished from discount-brokers, or bill-discounters, whose business consists in discounting bills of exchange and notes which have some time to run before they come due, by means of the funds, or on the faith of the credit of capitalists or other persons having the command of money. See BROKER, BILL OF EXCHANGE, PROMISSORY-NOTE.

BILL-CHAMBER is a particular department of the Court of Session in Scotland (coeval with the establishment of that court itself in 1532), the business of which corresponds, in many respects, to the practice of the Judges' Chambers in England. It is called the B., because, formerly in Scotland, judicial proceedings were for the most part commenced by a writ called a bill, which was the skeleton or draft of the legal process which it was sought to have issued, and which bill was obtained in this particular department of the court. For such purpose, as well as for other matters which do not admit of delay, the B. accordingly sat, as it continues to sit, all the year round, and as in England, it is presided over by a single judge. This judge, to whom for the time are delegated the whole powers of the court, is called the Lord Ordinary on the bills, and during the sittings of the Court of Session, the duty is taken by the junior or last appointed judge of the court; but in vacation-time, the business of the B. is performed in rotation by the six judges of the court who are not justiciary or criminal judges. In case of the indisposition or absence of any of these six judges, any judge of the Court of Session may act for him. A recent act, the 20 and 21 Vict. c. 18, now regulates many of the details of the procedure.

The business of the B. consists of all matters of a summary nature; and generally all cases requiring the immediate interposition of judicial authority are proceeded with, in the first instance, in the Bill-chamber. Applications for interdict or injunction, and for warrants necessary for the execution of process, are there at once made. The preliminary procedure by way of appeal from inferior courts, and in order to stay execution on the judgments of these tribunals, also takes place, in the first instance, in the Bill-chamber. Matters of bankruptcy or sequestration are also adjudicated on in this department. But the decision of the judge or lord ordinary officiating in the B., may, with some exceptions, be brought under review of the court; and the judgment of the court itself thus sitting on B. cases, may be brought before the House of Lords by appeal, as in ordinary cases. See COURT OF SESSION, JUDGES' CHAMBERS.

BILLARDIERA, or APPLEBERRY, a genus of twining Australian shrubs of the natural order *Pittosporaceæ* (q. v.). They have simple alternate evergreen leaves, and axillary pendulous flowers. The flowers have a calyx of five sepals, and a bell-shaped corolla of five petals. The fruit is a soft, spongy pericarp, with inflated cells, and many seeds which lie loose in the cells, terminated by the style, and generally bluish when ripe. It is eatable, although not destitute of a resinous character, which prevails in the order. *B. longiflora* and *B. ovalis*, the former with nearly globose, the latter with oval fruit, are frequent ornaments of British greenhouses.

The fruit of *B. mutabilis* is larger, cylindrical, and of a pleasant subacid taste.

BILLAUD-VARENNE, JEAN NICOLAS, a leader in the Reign of Terror in the French Revolution; took an active part in the September massacres; entered the Convention, where he distinguished himself for his violence against the king and the royal family, and his general unfeeling cruelty. He was the author of the Revolutionary Tribunal, and it was on his proposal that the Duke of Orleans, the queen, and a host of others became its victims. He joined in the end in bringing about the fall of Robespierre, but could not ward off his own accusation as one of the Terrorists, and was transported to Cayenne, where he lived about 20 years, rejecting the pardon offered by the First Consul. In 1816, he came to New York, but was coldly received, and then sought an asylum in Hayti, where he died, 1819.

BILLET, in Architecture, an ornament belonging to the Norman style. It was formed by cutting a moulding—generally a round moulding—into notches, so that the parts left resembled billets of wood. When used in several rows, the billets and



Billet.

empty spaces are placed interchangeably, as in the accompanying illustration.

BILLET, in Heraldry. Billets are small oblong figures, sometimes taken to represent bricks, but more commonly *billets doux*. The latter interpretation, which is that of Guillim, is generally adopted by English heralds, and is supported by the authority of Colomiere. The former, again, which has the *Trésor Héraldique* and Sir George Mackenzie on its side, is further strengthened by the fact that in German they are called *Schindeln*, shingles.

BILLETING is a mode of provisioning and lodging soldiers when not in camp or barrack. It is one of the many vexed questions connected with the organisation and administration of the British army. When in camp or barrack, the soldier is supplied with hot food daily by the commissariat officers; or rather, with undressed food, and the means for cooking it. But when it is necessary to keep soldiers for one or more days in a town unprovided with barracks, a difficulty occurs which has never yet been properly surmounted; a burden is sure to rest on some one who is unwilling to bear it. In the early times of our history, monarchs were often wont to quarter their troops on the monasteries. In later times, the soldiers often compelled the inhabitants of towns to receive and support them; and the authorities were either unable or unwilling to prevent this. The Mutiny Act, passed for the first time in 1689, put a stop to this pernicious practice, by declaring that no housekeepers should be compelled to accommodate soldiers except on some recognised and fairly administered system. The chief civil magistrate of a town, on requisition from the military authorities, quartered the soldiers on the inhabitants as fairly as he could. This continued in England until 1745, when all kinds of persons were exempted from this burden except certain traders; and the new system has been maintained with minor alterations ever since. The alteration was not made in Scotland until 1857.

At present, the persons liable to have soldiers billeted on them, are the keepers of public-houses, hotels, inns, ale-houses, beer-shops, wine-shops,

spirit-vaults, livery-stables, and such-like licensed houses. There are certain exceptional cases provided for; and in and near London there are special regulations concerning the B. of the Guards; but the general rule is as here stated. The persons liable are bound to accommodate soldiers, under a system that may be described in a few words. When troops are on the march from one barrack or station to another, and cannot cover the distance in one day's railway or foot travelling; or when they are to remain for a few days in a town unprovided with barrack accommodation, or where the barracks are already occupied—the commanding officer sends previously to the chief civil magistrate, and demands *billets* for a certain number of men for a certain time. The magistrate has a list of all the houses subjected to the B. system, and he quarters the men on those houses as fairly as he can. Rules are laid down to prevent the magistrate from B. too many soldiers on one house; any excess in this way is remediable at the hands of a justice of the peace. The billets are pieces of paper prepared under these rules. On the evening before the arrival of the troops, two or three non-commissioned officers enter the town, and present an order for the delivery of the billets to them, in order that no delay may arise when the main body enter. After the arrival, the soldiers go to the houses on which they are billeted: all those belonging to one company being quartered as near together as may be, for convenience of muster; and the sick are billeted near headquarters. The licensed victualler, or other person, is bound to provide each billet-holder with food, drink, bed, and accommodation, either in his own house or somewhere near at hand. A specified sum of 10*d.* per day is allowed for this; or, under other circumstances, a trifling sum per day is allowed for fire, candles, cooking-utensils, salt, and vinegar. About 8*d.* or 9*d.* per day is allowed for hay and straw for a horse. The officers visit the houses, to see that the men really have one hot meal per day, instead of taking the value of it in money, which might otherwise be offered to them. The soldier may demand facilities for cleaning his arms and accoutrements. The financial officer of the regiment makes the payments. There are often unpleasant disputes between the innkeeper or others, on the one side, and the officers of the regiment on the other, concerning the occupancy of the 'best room,' and on minor details relating to fire, candles, cooking, bedding, towels, table-linen, service, &c. The militia, when called out for actual training, are frequently billeted like the regulars.

There being many untoward circumstances connected with this system, a committee of the House of Commons, in 1858, sought how best to remove them. In their report, the committee could not recommend the cessation of the B. system altogether, but they pointed out certain possible ameliorations.

BILLIARDS (in Fr. *billard*, which meant originally the stick or staff with which the ball is struck, and is allied to Fr. *billot*, a block or billet of wood). It seems doubtful whether we are indebted for the discovery of this elegant game to France or Italy; but it is certain that it was imported hither from the former country. It must have been known, at all events by name, to Englishmen as early as the 16th c., since Shakespeare speaks of it; although, when he represents Cleopatra as amusing herself with B. in Egypt, it is probable that he commits an anachronism. It is certain that the rectangular slate-table, with its resilient sides, covered with green cloth, and furnished with the six brass-bound pockets, the three ivory balls, and that long array of cues with leathern tops, so familiar now-a-days to almost every eye, are

BILLIARDS.

paraphernalia of quite modern production. For two centuries, B. was played with only two balls; and when the third or red ball was imported from France, the red winning hazard—that is to say, the holing of the red ball—was almost the sole object of the performers. The cushions also, now universally constructed of india-rubber, up to a recent date were lined with felt. In no game are knowledge and manual dexterity so combined as in B., nor can the spectacle of first-rate play be appreciated, or the difficulties which it overcomes be understood, except by those who have a scientific as well as practical acquaintance with the game.

A billiard-table varies in size, but it is generally about 12 feet long and 6 feet wide. It is covered with fine green cloth, and set round with cushions, to keep the balls upon the table and make them rebound. The six holes or pockets are placed at the four corners and in the middle, opposite to each other, to hold the balls, which, when played into them, are called 'hazards.' The cues are long smooth sticks, with one end thick, and the other pointed; and the small end is covered with leather. The maces—slender sticks with a club at one end, adapted for pushing—are rarely taken in hand except by tyros and ladies, the but-end of the cue, when the point cannot conveniently be used, being commonly employed instead. The three balls are of ivory, ranging from an inch to an inch and a half in diameter, and two of them are white, and one is red. One of the former has a spot upon it; and when two persons are playing, he who uses the spot ball is called Spot, and he who uses the plain ball, Plain. The cue is held in the right



Bridge.

hand, and supported, in playing, by the forefinger and thumb of the left so placed as to form a 'bridge;' and the ball is struck with the point of the cue, which is chalked, to prevent its slipping. On a certain mark on the cloth, at the distance of about a foot from one end of the table, and exactly in its centre, the red ball is placed before commencing the game. At the other or lower end, and at the distance of about two feet from it, a line is drawn across the table; and from the centre of this line a semicircle is described between it and the lower end, of about 20 inches diameter. The space within this semicircle is called *bauk*. The object of the player is, by striking his own ball against the red ball or his adversary's, to drive either it or them into the pockets, or else to make 'a cannon'—that is to say, to strike both balls with his own. The score is usually recorded by a third person, by means of a marking-board. The game of B. can be played by two, three, or four persons, and in a great many different fashions; but it is most commonly played by two, and the ordinary game is that called *Carambole*, which was introduced from France at the same time with the third or red ball. The technical term 'cannoning' may perhaps have arisen from 'caramboling,' which was the old word for striking both balls with your own. The method of play is as follows:

1. The limit of the game is properly 21, though it is sometimes made 24, 50, 63, and 100, as may be agreed upon before commencing. The shorter games were probably used when billiard-tables were rarer, so that persons waiting for the use of them might sooner have their turn; 50, or '50 up,' as it is called, is now the most usual limit.

2. For the lead and choice of balls, the players *string*—that is to say, placing their balls within the semicircle, they strike them against the furthest cushion, in order to see which will return nearest the cushion next to them: the owner of the ball so placed, provided it does not strike the other ball, has then the option; but after the first match, the winner of each game leads.

3. The red ball on the spot at the upper end is replaced there on being put into a pocket, knocked off the table, or when the balls are 'broken' (see 19) after a foul stroke; but should any ball be on the spot, or so near to it as to prevent the red being placed there without touching the ball, the red must be placed in the centre of the table.

4. The points of the game are these: 1 for a miss, 2 for a cannon, 2 for a white hazard, 3 for a red hazard, and 3 for 'running a coo;' but the miss and the coo count for the adversary.

5. A white winning hazard is made when you play at the white ball and pocket it; a white losing hazard, when you pocket your own ball off the white. These names of 'winning' and 'losing,' were used in the old game of B. with two balls, but their meaning is now reversed, it now being commonly a disadvantage to make a winning hazard; and *vice versa*.

6. A red winning hazard is when you pocket the red; a red losing hazard, when you pocket your own ball off the red.

7. A cannon is when your ball strikes the other two.

8. A miss is when your ball strikes no other.

9. A coo is when your ball goes into a pocket, or jumps off the table without striking another.

10. A four-stroke is made by playing at the white, making a cannon, and pocketing your own or adversary's ball; or by pocketing his and your own without the cannon, or by playing at the red, making a cannon, and pocketing your opponent's ball.

11. A five-stroke is made by playing at the red, making a cannon, and pocketing your own or the red; or by pocketing the red and your adversary's ball without the cannon; or by pocketing your own and adversary's ball off the red; or by playing at the white, making a cannon, and pocketing the red; or by playing at the white, and pocketing your own and the red.

12. A six-stroke is made by playing at the red, and pocketing it and your own; or by striking the white first, making a cannon, and pocketing your own and adversary's ball.

13. A seven-stroke is made by playing at the red, making a cannon, and pocketing your own and adversary's ball; or by playing at the white first, making a cannon, and pocketing your own or adversary's and the red; or by striking the white, and pocketing all the balls without a cannon.

14. An eight-stroke is made by playing at the red ball, making a cannon, and pocketing your own and the red; or by striking the red, and pocketing all the balls without the cannon.

15. A nine-stroke is made when you cannon by striking the white first, and pocket all the balls.

16. A ten-stroke is made when you cannon by playing at the red first, and pocket all the balls. This is the greatest number that can be made.

17. If the striker, in making a cannon or hazard, should by accident touch either of the balls with his cue, hand, or otherwise, the adversary can, if he thinks proper, claim the stroke as foul, and have the balls broken; in which case, the points made by such stroke are not scored, and the person claiming the foul stroke leads off.

18. Foul strokes are made as follows—namely,

BILLINGSGATE—BILLINGTON.

by the striker's ball touching either of the others; by touching any ball whilst rolling; by moving another ball in any way while taking aim or in the act of striking; by pushing the balls together when playing with the *butt* of the cue; by playing with both feet off the floor; by playing at a ball before it has done rolling; or by playing with the wrong ball: in this last case, should a hazard or cannon be made, the adversary can have the balls broken and lead off; or should no score be made by such stroke, he can take his choice of balls and play.

19. In 'breaking' the balls, you take them all off the table, place the red on the spot, and both parties play from the baulk as at commencing.

20. If the balls have been changed, and it cannot be ascertained by whom, the game must be played out with them as they then are; or even if two strokes have been made before the mistake is discovered, it must still be played out in the same way.

21. Should the striker, in making a cannon or hazard, knock his own or either of the balls off the table, he cannot score the points made by such stroke, and the opponent plays, but the balls are not broken.

22. If a ball stops on the edge of a pocket, and afterwards falls in, either through the shaking of the room, or table, or by any other accident, it must be replaced as near the original place as possible.

23. Should the striker, when in hand (i. e., when his ball is off the table), play at a ball in baulk, his adversary has the option of scoring a miss, or of having the balls replaced, and the stroke played again, or of breaking the balls.

24. If the striker's ball touch another, he must play, and should he make a cannon or hazard, the adversary can claim it as foul, or he can allow points to be scored and the person to play on; but should the striker not score, it is at the option of the opponent to break them or not.

25. Should the marker, whilst marking for the players, by accident touch either of the balls, while rolling or not, it must be put as near as possible to the place it would have otherwise occupied.

26. If the last player should alter the direction of the balls while rolling, with cue, hand, or otherwise, the striker may place it where he thinks proper.

27. A line-ball is when either the white or red is exactly on the line of the baulk, in which case it cannot be played at by a person whose ball is in hand, it being considered in baulk.

28. If the striker's ball is over the pocket, and he should, in the act of striking, miss it, but in drawing his cue back knock it into the pocket, he will lose three points, it being a *coo*.

29. If the red ball has been put into a pocket, it must not be placed on the spot till the other balls have done rolling, should there be a probability of either of them touching it again, as the stroke is not finished till the balls stop.

30. If the striker should touch his ball by accident when taking aim, it is not a stroke, and the ball is to be replaced; but should he touch it in the act of striking, then it is a stroke.

31. If either of the balls lodge on a cushion, it is off the table, and should a cannon or hazard be made, it does not score, and the ball must be placed on the spot, or played from the baulk, according to whether it is white or red.

32. Any person refusing to play the game out after he has played one stroke, loses it.

33. In a match of four, each person is at liberty to offer his partner advice.

34. All disputes in the game to be decided by the marker or majority of the company, but no person

has a right to interfere until appealed to by one or both players.

35. It is called a love-game when no hazard has been made by the loser.

As evidence of what may be done in the way of swift and sure performance by masters of this art, we may mention that two of them (one of whom was the celebrated Kentfield) actually played thirty games of '24 up'—that is to say, supposing they were well-contested matches, they scored about 720 *each*—within an hour. The greatest achievement of the player above mentioned, and perhaps of any player, was the making a hazard off the red ball from three different cushions.

The only other game played upon a billiard-table which it seems necessary for us to notice, is that called Pool. It is quite different from that above described, nor is it necessary that a good player at the one should greatly distinguish himself at the other. Pool is the game pursued at all the public billiard-rooms, and is the sole profession of many persons who might otherwise employ themselves to more advantage, if not to greater profit, since the requisites for forming a first-rate player are really high—namely, steadiness of hand and eye, imperturbable temper, and exact dynamical calculation. Pool is played by any number of persons—when between two only, it is called 'single pool,' and is nothing else than the old game at B. before the introduction of the red ball—and after various methods, such as playing at the last player, playing at the nearest ball, and playing at any ball whatever. The most common is that of playing at the last player, the rules of which game are to be found, by those whom they concern, upon the walls of every room where it is played. The best billiard-tables, furnished with slate bed and India-rubber cushions, cost from £70 to £80.

BILLINGSGATE, a gate, wharf, and fish-market, a little below London Bridge, to the west of the Custom-house. It was opened in 1558 as a landing-place for provisions; and in 1699 was made 'a free and open market for all sorts of fish.' It is the only wholesale fishmarket in London; and fish of every kind, fresh or cured, is admitted free of duty, if taken by British subjects and imported in British vessels. Lobsters and turbot, also, are admitted free, though in foreign vessels. All fish are sold by tale, except salmon and eels, which are sold by weight; and oysters and other small shell-fish, which are sold by measure. The influx of salmon about the beginning of autumn is sometimes above 1000 boxes per day. The market opens daily at 5 A.M.; no fish is sold on Sunday, except mackerel. The fishermen consign their cargoes to the dealers, or 'salesmen,' who occupy stalls in the market; and these supply the retail-dealers. An officer called the clerk has the general superintendence of the market, and the quality of all fish offered for sale is tested by inspectors. The unpolished phraseology native, though not peculiar, to this quarter of London, has given rise to the proverbial use of the name.

BILLINGTON, ELIZABETH, the most celebrated English female singer of her day, was the daughter of a German musician named Weichsel, and born in London, 1769. She early came forward as a performer on the piano and as a composer; and having married her music-master, Thomas B., appeared with brilliant success on the Opera stage in Dublin in 1786. Returning to London, she was engaged at Covent Garden at the then unheard-of salary of £1000 for the season. She perfected her musical education under Sacchini in Paris, who wrote for her his opera, *Inez de Castro*, while she was singing in Naples 1794. She appeared subsequently in Venice

and Rome with the greatest applause. In 1799, her first husband being dead, not without suspicion of poison, she married a Frenchman of the name of Florissant, and returned to London, 1801, where she received £4000 for six months, playing alternately at Covent Garden and Drury Lane. She retired from the stage in 1809, and died (1818) at her villa, near Venice. Her character as a wife was the reverse of exemplary; but as a singer she was unrivalled. To a voice of the largest compass and richest tone, trained in all the art of the Italian school, she added a fascinating personal beauty and grace. In illustration of her spirit, it is told that Catharine II. proposing, through her London ambassador, to engage Mrs B. for the theatre of St Petersburg, the vocalist demanded a sum that seemed to the ambassador exorbitant. 'The Empress of all the Russias does not give more to her ministers.' 'Then let her make her ministers sing,' was the reply.

BILLITON, an island in the Dutch East Indies, between the south-east of Banca and the south-west of Borneo. It is separated from the former by Clement's Strait, and from the latter by the Caremata or B. Passage. Its north-west point is in lat. 3° 13' S., and long. 108° 7' E. It is said to contain 1150 square miles and 6000 inhabitants. It is rich in iron and timber, and imports rice, trepang, edible birds' nests, sea-weed, tortoise-shell, and wax. Its coasts are beset with rocks and islets.

BILLOM, a town of France, in the department of Puy-de-Dôme, situated on a hill 14 miles east-south-east of Clermont. It is one of the most ancient towns of Auvergne, and was formerly surrounded by walls, which have now disappeared; its commerce and manufactures have also declined. So early as 1455, a university was founded at B., which a century later passed into the hands of the Jesuits, and was governed by them until the suppression of their order. Pop. 3500, chiefly engaged in the manufacture of earthenware.

BILLON (see **BULLION**) is an alloy of copper and silver, in which the copper predominates, and which is used in some countries for the smaller denominations of money. The *Groschen* of North Germany—e. g., corresponding nearly to an English penny—is of B., and is about the size of an English fourpenny silver-piece. The object is to avoid the bulkiness of copper coin; but B., besides affording facilities for counterfeits, is dirty and inelegant.

BILMA, a town of the Sahara, Central Africa, situated in lat. 18° 40' N., long. 14° E., on an oasis called the Wady Kawas, on the route between Murzuk and Lake Tsad. It is the capital of the Tibu country, and important as a resting-place of caravans crossing the desert. Dates grow abundantly here; and large quantities of salt are collected from lakes in the vicinity for export to Bornu and Sudan.

BILSTON, a town in South Staffordshire, situated on a rising-ground about 3 miles south-east of Wolverhampton. Pop. 23,527. It forms a part of the parliamentary borough of Wolverhampton. It has extensive iron and coal mines, iron smelting-works, iron-foundries for making machinery, besides works for manufacturing tinplate goods, japanned and enamelled wares, nails, wire, screws, and coarse pottery. It is the centre, indeed, of the hardware trade, and consequently a very busy place. Fine sand, adapted for metal-casting, is found here. Upwards of 700 persons died of cholera here both in 1832 and 1849.

BIMA, a seaport in Sumbawa, one of the Sunda Isles, and capital of a state of the same name, in lat. 8° 30' S., and long. 119° E. It is on a bay of

the north coast, being 100 miles to the east of Sumbawa, a town feudally dependent on its sultan. Its chief exports are horses and timber.

BIMANA (Lat. two-handed), in some zoological systems, the first order of *Mammalia* (q. v.), an order containing the human species alone. See **MAN**. Others reject this order altogether, reclaiming against this classification of man with brutes, and maintaining that the distance between him and them is too great to be represented as that between two orders in one class, or even between two classes of a zoological system. In assigning a place in this manner to man among animals, naturalists of course consider exclusively or chiefly his animal nature and bodily frame. The name B. has reference to the hands (q. v.) which terminate his anterior limbs; monkeys and lemurs, which, having opposable thumbs in all the four extremities, may be regarded as having four hands, although much less perfect than the human, are called *Quadrumana* (q. v.); but none of the inferior animals are *two-handed*, as man is.

BINA'B, a town of Persia, in the province of Azerbaijan, charmingly situated on the banks of the Sofi Chai (a feeder of Lake Urumiyah), in the midst of orchards and vineyards, about 55 miles south-south-west of Tabriz. B. contains about 1500 houses; the streets are very clean, many of them having a stream of pure water, which is here very plentiful, flowing down the centre. B. forms a dependency of Marāghah, paying 4000 *tōmāns* of revenue, and furnishing a quota of 400 men to the Azerbaijan army.

BINARY COMPOUND. See **BINARY THEORY**.

BINARY THEORY, in Chemistry, takes cognizance of the mode of construction of salts. It assumes that all salts contain merely two substances, which either are both simple, or of which one is simple, and the other a compound playing the part of a simple body. The best and most familiar illustration of the B. T. is common salt or chloride of sodium (NaCl), which is constructed of the metal sodium (Na) and the non-metal chlorine (Cl), and is at a glance seen to be a *binary compound* (a compound of two). In like manner, fluor-spar, or the fluoride of calcium (CaF), consists of the metal calcium (Ca) and the non-metal fluorine (F); iodide of potassium (KI), largely employed in photography, of potassium (K) and iodine (I); and bromide of silver (AgBr), also useful in photography, of silver (Ag) and bromine (Br). Considerable difficulty is experienced in including all salts under the B. T., but in many cases the apparent difficulty may be got over. Thus, saltpetre, or the nitrate of potash (KO,NO₃), according to the ordinary mode of representing its composition in symbols, naturally breaks up into potash (KO) and nitric acid (NO₃); but in this form it cannot be correctly included in the binary theory. If, however, the same elements be arranged differently, as when the nitrate of potash (KNO₃) is represented as containing the metal potassium (K) and the compound non-metal nitrationide (NO₃), the latter playing the part of chlorine or other simple substance, the apparent barrier to the introduction of such salts into the list of those comprehended under the B. T. to a great extent disappears. The following table will represent this more clearly:

SYMBOLS.

	Ordinary Way.	Binary Theory.
Chloride of Sodium,	Na,Cl	Na,Cl
Nitrate of Potash,	KO,NO ₃	K,NO ₃
Sulphate of Soda,	NaO,SO ₃	Na,SO ₃
Carbonate of Lime,	CaO,CO ₂	Ca,CO ₂

Much, however, remains to be cleared up, and in very many cases the B. T. does not answer the purpose of including all salts under one class. See **SALTS**.

BINA'SCO, a town of Lombardy, about 11 miles north-west of Pavia. It is defended by a castle, where, in September 1418, Beatrice di Tenda, wife of the Duke Filippo Maria, was beheaded by order of her husband, who unjustly suspected her of infidelity. Pop. 5000.

BIN-BIR-KILISA' (One Thousand and One Churches), the name of extensive ruins in the pashalic of Karamania, Asia Minor, and 20 miles north-north-west of the town of Karaman. The ruins consist chiefly of the remains of Byzantine churches, evidently of great antiquity, and some of very considerable size. B. is supposed to be the ancient Lystra, where the cripple was healed by St Paul.

BINCHÉ, a town of Belgium, province of Hainaut, on the Haine, about 10 miles east-south-east of Mons. It is well built and walled, with a fine square, ornamented with a fountain, and has manufactures of leather, cutlery, pottery, glass, &c., and a considerable trade in lace, paper, marble, and coal. Pop. about 5500.

BINDRABA'N, a town on the right bank of the Jumna, is situated in the district of Muttra and sub-presidency of the North-west Provinces. It is in lat. $27^{\circ} 34' N.$, and long. $77^{\circ} 45' E.$, being 823 miles to the north-west of Calcutta, and 92 to the south of Delhi. The population of B., almost exclusively Hindu, has been returned at 19,776 inhabitants. Superstition appears to be the principal business of the place. Crowds of pilgrims come from all parts of India, more particularly in honour of Krishna; and, through the munificence of wealthy devotees, sacred edifices are constantly becoming more numerous and costly. Here, as at Benares, the immediate margin of the river is occupied by flights of steps, or ghauts, as they are called. These extend for about a mile along the bank, being constructed of red stone, which is brought from Jeypore, nearly 150 miles distant.

BINDWEED. See **CONVOLVULUS**.

BINGEN (the ancient *Vincum* or *Bingium*), a town in the grand-duchy of Hesse-Darmstadt, Germany, is situated in a charming country on the left bank of the Rhine, and on the right of the Nahe, here crossed by a bridge, generally supposed to have been built by the Romans, and called the Bridge of Drusus. Pop. about 7000, who are chiefly engaged in the manufacture of fustian, leather, flannel, and tobacco. The vine is extensively cultivated in the surrounding country. The celebrated Scharlachberger wine is produced in the vineyard of the same name, near the village of Rüdesheim. In the vicinity of the town is the Rochusberg, with a chapel, to which annual pilgrimages are made. On the declivity of the hill are still to be seen the ruins of the old castle (blown up by the French in 1689), in which the Emperor Henry IV. was detained a prisoner by his son in the year 1105. On the other side of the Nahe is the Rupertsberg, with the ruins of a monastery, in which St Hildegarde resided in the 12th c. Below the town is the celebrated *Bingerloch*, formerly a very dangerous point in the navigation of the Rhine, on account of the sunk rocks which, with the exception of a narrow passage through which the waters rushed loud and furious, stretched across the river; but in the year 1834, these rocks were partially blown up, so that there is no longer any great danger. In the middle of the river stands the tower, in which, according to the legend, Bishop Hatto

was devoured by rats in the year 969. History, however, fixes the date of the erection of the tower in the 13th c., as a toll-house for the collection of duties on goods passing this point in the river.

B'INGLEY, a town in the West Riding, Yorkshire, 15 miles west-north-west of Leeds, situated on an eminence in a well-wooded district, on the west bank of the Aire, between that river and the Leeds and Liverpool Canal. It chiefly consists of one long street. It has considerable worsted manufactures. Pop. (1851) 5019.

B'INNACLE, formerly called *Bittacle* (Fr. *habitable*), is a wooden box or case for containing a ship's compass, together with other apparatus (especially a lamp) essential to its use. In large ships, there are generally two binnacles, one for the steersman, and one for the officer or seaman who 'cons' or superintends the steering. Sometimes a lamp is so placed as to illuminate two compasses at night, sometimes only one. Many improvements have recently been made in binnacles. See **COMPASS**, **MARINER'S**.

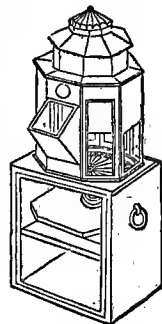

Usual form of Binnacle.

BINNEY, REV. THOMAS, one of the most distinguished preachers of the Independent body in England, is a native of Newcastle-on-Tyne. After officiating as a clergyman in Newport, Isle of Wight, he, in 1829, removed to London, where he soon acquired extensive popularity. The hall in which he preached becoming too small for his congregation, Weigh-house Chapel, near London Bridge, was erected for him by his hearers in 1833. Here he continued to labour with great success for about a quarter of a century, attracting around him a large number of the more intelligent class of young men in the metropolis. An address delivered at the inauguration of the new chapel, in which certain expressions rather derogatory of the influence of the English Church were used, brought B. into notoriety from the replies it called forth from many of the English clergy, including the Bishop of London. Within recent years, he took the more liberal side in the *Rivulet* controversy, as it has been called, regarding the orthodoxy of certain hymns of a high order of poetic merit, written by the Rev. T. Lynch of London; and the malignant attacks to which he was in consequence subjected, are generally understood to have injured his health, to recruit which he went to Australia in 1858. He has since returned to this country. As a preacher, B. is remarkable less as an orator than for breadth of view, originality of thought, and masculine force of expression. He is the author of several religious works, of which the one entitled *How to Make the Best of Both Worlds* is the most popular.

BINO'MIAL, in Algebra, is a quantity consisting of two terms or parts—e.g., $a + b$, or $9 - 5$; a *trinomial* consists of three terms, as $a + b + c$, or $10 + 5 - 8$. The **BINOMIAL THEOREM** is that remarkable series or analytical formula by which any power of a B. can be expressed and developed. Thus, the 8th or any other power of $a + b$ can be at once written down without going through the actual multiplication of $a + b$ by itself for the given number of times. The older mathematicians were acquainted with this theorem in the case of integral exponents, though the actual discoverer is unknown. Newton was the first to demonstrate its truth for all exponents—fractional and negative, as

well as integral. It is one of the finest of his discoveries, and is engraved on his tomb. Among its many applications, it affords the means of finding any root of any number much more conveniently than by the usual method of extraction.

BINTA'NG, an island of the Dutch East Indies, about 40 miles south-east of Singapore, and in lat. 1° 5' N., long. 104° 29' E. Area, 600 square miles. Pop., including that of small adjacent isles, 13,000. It is calculated that not less than 4000 tons of the astringent gum called gambir are obtained here annually. This, along with rice and pepper, forms its chief exports.

BINTURONG (*Ictides*), a genus of quadrupeds nearly allied to Racoons (q. v.), from which the chief distinction is in the smaller and less tuberculated back molar (grinder) teeth. Only two species are known, natives of Malacca, Java, Sumatra, &c.

BIOBIO, the largest river of Chili, has a west-north-west course from the Andes to Concepcion on the Pacific, being 2 miles wide at its mouth, and navigable for boats from the sea to the mountains. Its lower stream separates the province of Concepcion on the north from independent Araucania on the south.

BIOGRAPHY (from the Gr. *bios*, life, and *graphie*, writing) is the term applied to that department of literature which treats of the lives of individuals. The mode of treatment, especially in modern times, is far from uniform. In some cases, B. approaches the sphere of philosophy; in others, that of history; while in the majority it assumes, to a large extent, the character of analytic or descriptive criticism. To none of these modes, theoretically considered, can there be any valid objection; everything depends on the judiciousness of the biographer. The great points which he must keep perpetually in view are the personality and characteristics of his subject. If these are buried under a load of digressive dissertations, his book, however valuable or interesting, ceases to be a B., except in name. Anciently, B. was more of a mere *curriculum vite* than it is now; that is to say, the leading incidents of a man's life were narrated in their historical sequence, without any elaborate attempt to analyse the character from which they emanated. Like ancient history, it was possessed of a simple greatness, a stately dignity of narrative, coloured here and there but sparingly with grave eulogy or censure. Modern B., on the other hand, like modern history, is full of elucidations, criticism, and disquisition; and if wanting in the severe grace of its classic predecessor, it is much more lively, acute, and expansive.

Biographical literature appears to have existed from a very early period. The oldest historical books of the Jews abound with beautiful examples of it, such as the lives of the patriarchs and the story of Ruth. But what, indeed, are the mythologies of all ancient nations, except a chaos of heroic or divine biographies written not on walls of stone or rolls of parchment, or leaves of papyrus, but on the tablets of the memory? Of purely biographical works, the most valuable that has come down to us from the Greeks is the *Parallel Lives* of Plutarch, a composition of the 2d c. after Christ. Roman literature also possesses an admirable specimen in the *Life of Agricola* by his son-in-law, Tacitus. Besides these may be mentioned the *Life of Alexander the Great* (in Latin) by Curtius, and of *Apollonius of Tyana* (in Greek) by Philostratus, *Lives of the Sophists* (in Greek) by Philostratus, and a *Life of Plato* (in Greek) by Olympiodorus of Alexandria.

Coming later down, we encounter St Jerome's

Lives of the Fathers; while biographies, more or less complete, of saints, martyrs, bishops, &c., are scattered profusely through primitive ecclesiastical literature. The monks of the middle ages also worked hard at the manufacture of absurd and superstitious legendary biographies, in which the hunger for the marvellous characteristic of that credulous time was hugely gratified. Modern biographical literature may be said to date from the 17th c., and has since developed itself to an unmanageable extent. Among the most valuable works belonging to this class, written since the Reformation, may be mentioned Vasari's *Lives of the Painters* (Florence, 1550); the *Acta Sanctorum* (q. v.); Tillemont's *Mémoires pour servir à l'Histoire Ecclésiastique des six Premières Siècles de l'Eglise* in 16 vols. 4to (Paris, 1693); Thomas Stanley's *History of Philosophy, containing the Lives, Opinions, Actions, and Discourses of Philosophers of every Sect* (1655—1662); Bayle's *Dictionnaire Historique et Critique* (Rotterdam, 1697); Johnson's *Lives of the Poets* (completed in 1781); the *Biographie Universelle* (1810—1828); *Conversations-Lexicon* (10th edition, 1851—1855); Charles Knight's *English Cyclopædia*, Biographical Section (1856—1857). As for individual biographies in modern times, it would be endless to enumerate them. It having unhappily been discovered that these constitute the most attractive form of literature, the world is annually inundated with an intolerable flood of lives of nobodies. At present, the most insignificant literary, clerical, or philanthropical personages are not permitted to pass quietly away. Nevertheless, amid the desert of commonplace, the choicest cases may be found; works so rich in pleasant or profound thought, so copious in agreeable gossip, so valuable in unexpected glimpses and revelations of character, so abundant, in short, in everything that can stimulate, elevate, or enlighten, that it is not wonderful they should be read and re-read with avidity. Chief among such in our own country is Boswell's *Life of Johnson* (1790). During the last decade also appeared the *Life of John Sterling*, by Thomas Carlyle, a work which is considered a model of its kind; and the *Life of Goethe* by G. H. Lewes, which has been universally accepted, both in Germany and England, as an adequate B. of the illustrious monarch of continental literature. In France, where B., at least in the shape of 'Memoirs,' has attained perfection, we may specify among others the *Life of Descartes* by Baillet, of *Charles XII.* by Voltaire, of Voltaire by Condorcet, of *Fénelon and Bossuet* by Cardinal de Bausset, of *Molière and Corneille* by M. Taschereau, and of *Monk* by Guizot. In Germany, among others, we have the *Life of Heyne* by Heeren, of *Reinhard* by Poelitz, and of *Dorothea, Duchess of Courland*, by Tiedge; while America has contributed the valuable *Life of Christopher Columbus* by Washington Irving.

An *Autobiography* is the life of a person written by him or her self. This branch of literature, also, has become superabundant in this egotistic and self-conscious age. Unquestionably the highest work in this department of literature is Goethe's *Dichtung und Wahrheit*, a kind of idealised autobiography, in which the outward and inward truth, the fact and poetry of the author's life, are strangely but beautifully interwoven.

BIOLOGY (Gr.), or the science of life, embraces properly all knowledge regarding organised beings as distinguished from the inorganic world. But in a narrower sense it designates much the same as human physiology (q. v. and LIFE).

BIOT, JEAN BAPTISTE, a distinguished French

physicist and astronomer, was born at Paris 21st April 1774. He at first entered the artillery, but forsook the service for science; and in 1800 became Professor of Physics in the Collège de France. He was made a member of the Institute in 1803; and in 1804, it was solely through him that the Institute voted against making Napoleon emperor. Along with Arago, he was made a member of the Bureau of Longitude, and (1806) sent to Spain to carry out the measuring of a degree of the meridian, preparatory to the introduction of the present French system of weights and measures. On his return, he devoted himself to physical researches and to lecturing. In 1815, the Royal Society of London elected him one of their 50 foreign members. In 1817, he visited England, and went as far north as the Shetland Islands, in order to make observations along the line of the English arc of meridian, which had been extended by Colonel Mudge. His most valuable contributions to science are on the polarisation of light; and his researches connected with ancient astronomy are also very valuable. Of his numerous writings may be mentioned *Traité Élémentaire d'Astronomie Physique*, 3 vols. (Paris, 1805); 3d ed., considerably augmented (1850), 6 vols., with vol. of plates—translated into English. *Traité de Physique*, 4 vols. (1816); *Précis de Physique*, an abridgment of the former in 2 vols. (1817), often republished; *Recueil d'Observations Géodésiques, &c.* (1821). B. has also contributed many excellent biographies of scientific men to the *Biographies Universelles*. The 'Mémoires' of the Institute, and similar publications, contain many valuable contributions from Biot. Of the more recent is a *Mémoire sur la Constitution de l'Atmosphère Terrestre* in the *Connaissance des Temps* (1841). In 1849, B. was made a commander of the Legion of Honour. He is also a member of most of the learned societies in Europe.

BIOT, EDUARD CONSTANT, son of the former, a distinguished Chinese scholar, was born at Paris 2d July 1803. He was one of the first to promote the introduction of railways in France; but his health failing, he retired from the public service, and devoted his leisure to the study of Chinese, and the history of the social organisation of the Celestial Empire. He died March 1850. He wrote a *Dictionnaire des Villes, &c., de l'Empire Chinois* (1842), and a multitude of *Mémoires* on Chinese subjects of scientific and social interest, printed in the *Journal Asiatique, &c.* His interesting work, *De l'Abolition de l'Esclavage Ancienne en Occident* (1840), was awarded a gold medal by the Institute.

BIPED (Lat.), *two-footed*, a term sometimes applied, as descriptive, to man, more frequently to birds, and which scarcely admits of application to any other animal except a very few species of reptiles, some of which are batrachian (see BATRACHIA and SYREN), and some saurian (see SAURIA). The two-footed saurians may be regarded as forming a link between that order and serpents, the two-footed batrachians as connecting batrachians with fishes, other characters of resemblance being in both instances associated with this.

BIPENNIS, a double-headed axe, the weapon which, according to ancient historians and artists, particularly distinguished those fabulous female warriors, the Amazons.

BIQUADRATIC. See EQUATIONS.

BIR (ancient *Birtha*, Turkish *Birch-jik*), a town of from 1800 to 2000 houses of Asiatic Turkey, in the pashalic of Diarbekir. It is situated on the east bank of the Euphrates, in lat. 37° 3' N., long. 38° E., on a steep hill above the river, the passage of which is here commanded by a castle. B. is

surrounded by a strong wall flanked with towers; its streets are narrow, but clean; it has several mosques with tall minarets, a caravansary, a bazaar, and a ruined citadel and castle. Travellers and caravans from Aleppo to Diarbekir, Bagdad, Persia, &c., cross the Euphrates at this point. From B. Colonel Chesney proposed to navigate the Euphrates by small steamers to its mouth in the Persian Gulf, a distance of 1143 miles. *B.*, which signifies 'well,' is also the prefix of several other small towns in Arabia.

BIRCH (*Betula*), a genus of plants of the natural order *Amentaceæ* (q. v.), sub-order *Betulineæ*, the natural order *Betulaceæ* of some botanists. In this order, or sub-order—which contains only the two genera, Birch and Alder (q. v.)—the flowers have merely small scales for their perianth; the ovary is two-celled, but the fruit—a small achenium (q. v.)—is by abortion one-celled; the fruits and scales united form a sort of cone; and the leaves have stipules

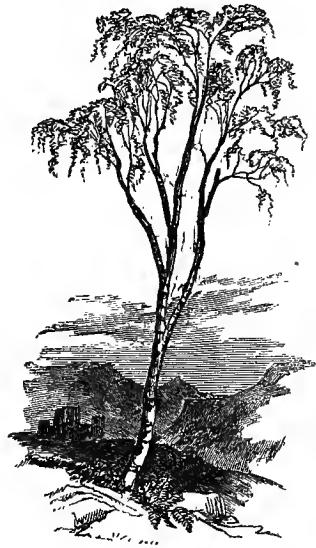

Common Birch (*Betula alba*).

which soon fall off. They are all trees or shrubs, natives of temperate and cold regions.—The genus *Betula* is distinguished by 10–12 stamens, and winged achenia.—The COMMON B. (*Betula alba*) has small ovate-triangular doubly serrated leaves. It is a very beautiful forest-tree, abounding in the North of Europe and of Asia, often forming large groves by itself. In the south of Europe, it is found only upon mountains of considerable elevation. It is a tree of rapid growth. In favourable situations, it attains the height of 60 or even 70 feet, with a diameter of 1½ or 2 feet; whilst on the northern, or utmost alpine limits of vegetation, it only appears as a stunted bush. The bark is smooth and silvery white, and its outermost layers are thrown off as the tree advances in age. The smaller branches are very slender and flexible, and in a particularly graceful variety called the WEEPING B. (*B. pendula* of some botanists), they are still more slender, elongated, and pendulous. Some of the finest Weeping Birches in Britain stand on the banks of the river Findhorn, near Forres, in Morayshire; they are 60 feet high, and exhibit pendent masses of spray 10 feet

BIRCH.

in length. The bark and leaves of the B. are, in some northern countries, used medicinally in cases of fever and eruptions. They are also used for dyeing yellow. The bark is sometimes used for tanning, and is preferred to every other kind of bark for steeping nets, sails, and cordage. See BARK FOR TANNING. It is in some countries made into shoes, hats, drinking-cups, &c., and it is even twisted into a coarse kind of ropes. Portable boats made of it are used on the Volga. It is remarkable for durability. In many parts of the north of Europe, it is used instead of slates or shingles by the peasantry; and in Russia—the outer or white layers being subjected to distillation—there is obtained a reddish empyreumatic oil called B. OIL; it yields also the B. TAR, or *Degutt*, which is employed in the preparation of Russia leather. Dried, ground, and mixed with meal, B. bark is used in Norway for feeding swine; and, in times of scarcity, has even served for human food. The wood is in universal use in northern countries for the most various purposes. It is white, firm, and tough, and is employed by wheel-wrights, coopers, turners, &c. It is very much employed in the manufacture of barrels for fish. It is much employed for smoking hams, herrings, &c., because of the flavour which it imparts. Much of it is made into charcoal for forges. The twigs are in general use for besoms. In the Highlands of Scotland, and in many other countries, the sap is not only used as a beverage in a fresh state, but is converted by fermentation into a kind of wine. To obtain it, a hole is bored in the stem, in spring, in an oblique direction, one or two inches deep, and a small tube is introduced to carry the sap into a vessel. From a strong stem, there often flows as much as from four to six quarts in a day. If the hole is again



Common Birch:
Shewing catkin and leaves.

closed up each time with a wooden plug, covered over with clay or rosin, and the tapping is annually renewed in the same place, the tree sustains very little injury. B. sap is very beneficial in diseases

of the kidneys and in cases of urinary calculus. It contains more than 2 per cent. of sugar.—The WHITE B. of North America (*B. populifolia*) very nearly resembles the common B., but is of much less value. It is found as far south as Pennsylvania. The wood is scarcely used.—The BLACK B. of the same country (*B. nigra*), also sometimes called RED B., and very similar to the common B., produces very hard and valuable timber. It attains the height of 70 feet. It is not found further north than New Jersey. The bark is of a dark colour, the epidermis in the younger trees reddish.—But the name BLACK B. is also given to another species found in the more northern parts of North America, and sometimes called the SWEET B. or CHERRY B. (*B. lenta*), also a tree of 70 feet or upwards in height, and of which the timber is fine-grained, and valuable for making furniture, and for other purposes. Its leaves, when bruised, diffuse a sweet odour, and when carefully dried, make an agreeable tea. It is remarkable that this tree has been little planted in Britain.—The YELLOW B. of North America (*B. excelsa*) is a tree of 70–80 feet high, destitute of branches for 30–40 feet, remarkable for its large leaves, which are 3½ inches long, and for the brilliant golden yellow colour of the epidermis. It is found in Nova Scotia, New Brunswick, Maine, &c. Its timber is used in ship-building. The young saplings of all these American species are much employed for making hoops for casks.—The PAPER B. (*B. papyracea*) is found in the northern parts of North America. It attains the height of 70 feet. The bark of the young trees is of a brilliant whiteness. The bark is capable of division into very thin sheets, which have been used as a substitute for paper. It is used by the Indians for canoes, boxes, buckets, baskets, &c. Large plates of it are curiously stitched together with the fibrous roots of the White Spruce, and coated with the resin of the Balm of Gilead Fir. The wood is used for the same purposes with that of the common B.—The mountainous districts of India produce several species of this genus. Thin, delicate plates of the bark of *B. Bhojputra*, a native of the mountains of Kumaon, are used for lining the tubes of hookahs, and are carried in great quantities to the plains of India for this purpose. They were formerly used instead of paper for writing. *B. acuminata*, a native of the mountains of Nepaul, is a tree of 50–60 feet high, covered with branches from the base, and of an oval form. Its wood is strong and durable.—The DWARF B. (*B. nana*) is a mere bushy shrub, seldom more than two or three feet high, and generally much less. It has orbicular crenate leaves. It is a native of the whole of the most northern regions of the globe, and is found in some parts of the Highlands of Scotland. It is interesting because of its uses to the Laplanders and other inhabitants of very northern regions, to whom it supplies their chief fuel, and the material with which they stuff their beds. Its seeds are the food of the ptarmigan, on which the Laplanders in a considerable degree depend. A similar shrubby species (*B. antarctica*) occurs in Tierra del Fuego.

BIRCH, THOMAS, D.D., an industrious historical writer, son of a coffee-mill maker, a Quaker, born at Clerkenwell, November 23, 1705, was at first an usher in different schools. Having taken priests' orders in 1731, he was presented in 1732 to a living in Essex, and in 1734 became chaplain to the Earl of Kilmarnock, who was beheaded in 1746. Appointed in the latter year Rector of St Margaret Pattens with St Gabriel, Fenchurch Street, London, B. was elected in 1752 one of the secretaries of the Royal Society, a history of which he published in 4 vols., 4to, in 1756–1757. In 1761, he was preferred to the Rectory of Deepdene, Surrey. His first

literary undertaking, in which he was assisted by others, was *The General Dictionary, Historical and Critical*, 10 vols., 1734—1741, founded on Bayle's celebrated work. He next edited the collection of state-papers of Thurloe, secretary to Oliver Cromwell, 7 vols., folio, 1742. His other works are *Life of the Hon. Robert Boyle, 1744*; *Lives and Characters of the Illustrious Persons of Great Britain*, the engravings by Houbraken, Gravelot, and Vertue (London, 1743—1752); *Inquiry into the Share which King Charles I. had in the Transactions of the Earl of Glamorgan, 1747*; *Historical View of the Negotiations between the Courts of England, France, and Brussels, 1592 to 1617, 1749*; *Life of Tillotson, 1752*; *Memoirs of the Reign of Queen Elizabeth, 2 vols., 1754*; *Life of Henry Prince of Wales, 1760*; &c. He likewise edited the works of Sir Walter Raleigh, Bacon's works, and various others. He was killed by a fall from his horse in the Hampstead Road, 9th January 1766. He left an extensive MS. collection, with his library, to the British Museum, of which he was a trustee. From these MSS. were compiled *The Courts and Times of James I. and Charles I.*, 4 vols. 8vo, (London, 1848).

BIRCH-PFEIFFER, CHARLOTTE, a German actress and writer of plays, was born at Stuttgart in the year 1800. Her passion for the stage displayed itself so strongly, that after encountering much opposition on the part of her parents, she made her debut at Munich at the age of thirteen, and afterwards played with great success at Berlin, Vienna, and Hamburg. In 1825, she married Dr Christian Birch of Copenhagen, and afterwards performed at Petersburg, Pesth, Amsterdam, and other places. In 1837, she undertook the direction of the theatre at Zurich. At a later period, she acquired even greater renown as a writer for the stage than as an actress. Her principal theatrical pieces are *Pfefferrösel*; *Hinko*; *Die Günstlinge*, perhaps her best piece; *Der Glöckner von Notre Dame*; &c. In 1843, Madame B. resigned the direction of the Zurich theatre, and after visiting professionally most of the cities in Germany, made an engagement with the theatre-royal at Berlin. Since that time, her works have displayed marked progress. The chief productions of what may be termed her later manner are *Die Marquise von Villette* (1845), *Dorf und Stadt* (1848), *Eine Familie* (1849), *Anna von Osterreich* (1850), *Ein Billet* (1851). In 1847, Madame B. commenced to publish a complete edition of her dramatic works, which are about 70 in number.

BIRD, EDWARD, an English 'genre' painter of considerable celebrity, was born at Wolverhampton in 1772. He having early displayed a strong inclination for drawing, his father thought he was consulting his son's taste when he apprenticed him to a Birmingham tea-board manufacturer, his duty there being to paint flowers, shepherds, &c., on the boards. On the expiration of his apprenticeship, B. established himself as a drawing-master in Bristol; and two of his pictures, the 'Choristers Rehearsing,' and 'The Will,' having been bought by the Duke of Clarence, afterwards William IV., and the Marquis of Hastings, his reputation was secure. He was elected a Royal Academician, and soon obtained some good commissions. The 'Field of Chevy Chase the Day after the Battle' is generally considered his master-piece. His 'Death of Eli' obtained the British Institution prize of 300 guineas. In 1813, B. was appointed painter to the Princess Charlotte. He now became ambitious to excel in Scripture subjects, and painted several, none of which, however, added to his fame. His

last picture, the 'Embarkation of Louis XVIII. for France,' which was never finished, was the least satisfactory of all his works. He died in 1819. His most popular works are—'The Blacksmith's Shop,' 'The Country Auction,' 'The Village Politicians,' 'The Young Recruit,' &c.

BIRD-BOLT. Stevens, in his note on *Much Ado about Nothing*, says the B. is 'a short, thick arrow, without point, spreading at the extremity so much as to leave a broad flat surface, about the

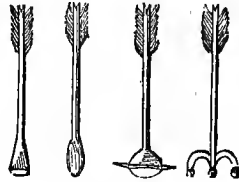

Bird-bolts.

breadth of a shilling. Such are to this day in use to kill rooks with, and are shot from a cross-bow.' The annexed illustration is copied from Douce's *Illustrations of Shakspeare*.

BIRD-CATCHING SPIDER, a name originally given to a large spider, *Mygale avicularia*, a native of Cayenne and Surinam; but which is now more extensively applied, being equally appropriate to a number of large species of *Mygale* (q. v.) and *Epeira* (q. v.), perhaps also of other genera. It has, indeed, been denied by some observers that the name is truly appropriate, but the positive evidence is too strong to be easily set aside by evidence merely negative. The *Mygale avicularia* is nearly two inches long, very hairy, and almost entirely black; its feet, when stretched out, occupy a surface of nearly a foot in diameter. The hooks of its mandibles are strong, conical, and very black. This great spider forms a tube-shaped cell, widening

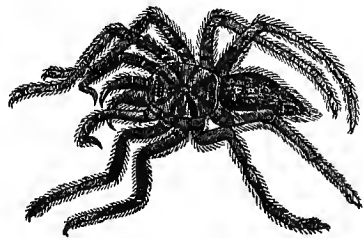

Bird-catching Spider.

towards the mouth, of a fine white semi-transparent tissue, like muslin, in clefts of trees or hollows among rocks and stones. From this it issues only at night, to prey upon insects, and, it is said, upon humming-birds. It does not construct a net for the capture of its prey, but takes it by hunting, as do other large species of *Mygale*, natives of the warm parts of America, the East Indies, and Africa. It is probably a species of this genus that Dampier mentions as found in Campeachy, the fangs of which, 'black as jet, smooth as glass, and, at their small end as sharp as a thorn,' are said by him to be worn by some persons in their tobacco-pouches, to pick their pipes with; and to be by others used as tooth-picks, in the belief of their having power to expel the toothache. The bite of the large species of this genus is said to be dangerous.

It appears that spiders of the genus *Epeira* feed

upon small birds caught in their webs, which have even been described as in some cases large enough to arrest the flight of a bird the size of a thrush, and to impede the traveller in tropical forests.

BIRD-CHERRY (*Padus*), a subdivision of the genus *Cerasus* (see **CHERRY**), itself very generally regarded as a sub-genus of *Prunus* (see **PLUM**). The Bird-cherries are distinguished by racemes of small flowers and deciduous leaves.—The **COMMON B.** (*Prunus* or *Cerasus Padus*), called in Scotland *Hagberry*, is a tall shrub or small tree, sometimes reaching the height of 40 feet, growing wild in moist woods in Britain, and in most parts of Europe and the north of Asia. Its younger branches are of a very dark or reddish-brown colour. The drupes are small, of a sweetish subacid taste, combined with a degree of what many regard as nauseous bitterness; but to some palates they are not disagreeable. A well-flavoured spirituous liquor is prepared from them in the north of Europe. In Siberia, the juice expressed from the ripe fruit is drunk either alone or mixed with milk, and the remaining mass is kneaded into cakes, and used as food.—Very nearly allied to this species is the **VIRGINIAN B.** (*P.* or *C. Virginiana*), a tree of 80—100 feet in height, found from Tennessee to Upper Canada, and now frequent in Britain as an ornamental tree, although never attaining the size which it does in the United States. The wood is compact, fine-grained, takes a fine polish, and is much used in America by cabinet-makers. The bark is used in the United States as a febrifuge. The fruit is not agreeable; but a cordial is made from it by infusion in spirits with sugar, and, when dried and bruised, it forms an esteemed addition to *pemmican* (q. v.).

BIRD ISLAND, the north-west island of the Sandwich Archipelago, in lat. 22° 20' N., and long. 160° W. It is, as its name implies, a mere haunt of sea-fowl—the links of the chain increasing pretty regularly in size and elevation from B. I. on the north-west to Hawaii on the south-east.

BIRD-LIME is a viscid and adhesive substance, which is placed on twigs of trees or wire-netting, for the purpose of catching the birds which may alight thereon. A common practice is to place a decoy or tame bird in a cage near where the B. is spread; the wild birds, attracted to the spot by the song of the tame bird, get entangled with the bird-lime. The substance is generally prepared from the middle bark of the holly, mistletoe, or distaff-thistle, by chopping up the bark, treating it with water, boiling for several hours, then straining; and lastly, concentrating the liquid by evaporation, when the B. assumes a gelatinous consistence resembling that of moist putty. It mainly consists of a substance named by the chemist *viscin*. A second mode of preparing B., is to employ ordinary wheat-flour; place it in a piece of cotton cloth; tie up the ends, so as to form a bag; immerse the whole in a basin of water, or allow a stream of water to flow upon it; and repeatedly squeeze the bag and its contents. The result is, that the starch of the wheat-flour is pressed out of the cloth bag, and an adhesive substance named *gluten* is left on the cloth. This substance resembles that prepared by the previous process in its properties; but the former mode of preparing B. is a much cheaper plan, and is that generally followed.

BIRD OF PARADISE, the common name of a family of birds, *Paradisæideæ* of ornithologists, found chiefly in New Guinea and neighbouring islands, and remarkable for splendour of plumage. In all other respects, however, they are very closely allied to the crow-family, *Corvidæ* (q. v.), to which

they exhibit a great similarity, not only in the characters of the bill, feet, &c., and in general form, but also in their habits, and even in their voice. They have been the subject of many fables. The state in which their skins are usually exported from their native islands, gave rise to the notion that they were destitute of feet; and free scope being allowed to fancy, it became the prevalent belief that they spent their whole lives floating in the air, except when perhaps they suspended themselves for a little by their long tail-filaments from the uppermost branches of trees. As for their food, it was supposed to be either mere dew and vapours, or nectar obtained from the flowers of trees, climbers, and plants growing on the branches of trees, in the high regions of bright sunshine above the shade of the tropical forests. Antony Pigafetta, indeed, who accompanied Magellan in his voyage round the world, described them as having legs, and stated that these were cut off as useless in the preparation of the skins; but his statement was not credited, and Aldrovandus went the length of accusing him of an audacious falsehood. It would seem that the fables concerning the Birds of P. are in part to be ascribed to the desire of the inhabitants of those islands in which they are found to increase the value of their skins as an article of merchandise; and a sort of sacred character being attached to them, they were employed not merely for ornament, but as a charm to secure the life of the wearer against the dangers of battle. The people of Ternate call them *Manuco-Devata*, or Birds of God; which name Buffon modified into *Manucode*. In different languages they are known by names signifying Birds of the Air, Birds of the Sun, &c.

The males alone are birds of splendid plumage, that of the females possessing neither brilliancy of colours nor remarkable development. The plumage of the males is not only characterised by great brightness of tints, but by a glossy velvety appearance, a metallic lustre, and a singularly beautiful play of colours. Tufts of feathers generally grow from the shoulders, and these, in some of the kinds, are prolonged so as to cover the wings; in the species sometimes called the Common B. of P., and sometimes the Great Emerald B. of P. (*Paradisæa*



Bird of Paradise (*Paradisæa apoda*)—male.

apoda), the prolongation of these shoulder tufts is so great, that they extend far beyond the body, and even far beyond the tail. They constitute the most magnificent part of the well-known B. of P. plumes. They are exquisitely light and delicate. It has

been supposed that they may be of use to the creature in enabling it, with less exertion of wing, to float in the air, but this notion is perhaps sufficiently confuted by the total absence of them in the female. —In other species, there are elongated feathers on the back of the neck, which the bird can erect, and even in some measure throw forward at pleasure; and these, in the genus *Lophorina*, assume a form resembling that of a pair of outspread wings, and rise far above the head. The tail is, in general, not unlike that of a crow in its shape; but in many species there arise, from the rump, at the sides of the tail, two very long feathers, or rather filaments, covered with a sort of velvety down: of these, the Common B. of P. affords an example. In the King B. of P. (*Cinnamurus regius*), these long tail-filaments terminate in a sort of disk, as the tail-feathers of the peacock do. —

Birds of P. are, in general, more or less gregarious. They sometimes pass in flocks from one island to another, according to the change of seasons, from the dry to the wet monsoon. Owing to their plumage, they fly more easily against than with the wind, and by high winds they are sometimes thrown to the ground. They are lively and active, and in confinement pert and bold. They bestow great care upon their plumage, and sit always on the perches of the cage, so that no part of it may reach the floor, or get in the least degree soiled. It has seldom been found possible to bring them alive to Europe, and they seem very incapable of enduring any other than a tropical climate. In confinement, they are easily fed on rice, insects, &c. In a wild state, their food consists in great part of the fruit of the teak-tree, and of different species of fig, and also of the large butterflies which abound in their native islands.

The Papuans kill Birds of P. by shooting them with arrows, and employ various other means of taking them for the sake of their skins. The skins are dried in smoke, and fumigated with sulphur, to preserve them from insects; and in this way the brilliancy of the colour is impaired, so that the most gorgeous plumes which are ever seen in Europe are inferior, in this respect, to those of the living bird. The skin, to which great part of the flesh is allowed to remain attached, is always much contracted by this drying process, and a very erroneous notion is therefore often formed of the size of the bird. The common B. of P. is as large as a jay. It is of a cinnamon colour, the upper part of the head and neck yellow, the front and throat emerald green, the shoulder-tufts yellow. The whole length to the extremity of these is not less than two feet. Another nearly allied species (*Paradisæa rubra*) has these long feathers of a brilliant carmine colour.

BIRDE, WILLIAM, a distinguished ecclesiastical composer, was born about the year 1540, and educated at Edward VI.'s Chapel. In 1563, he was appointed organist in Lincoln Cathedral, and twelve years afterwards organist to Queen Elizabeth. He published numerous compositions exhibiting great musical learning, and contributed many pieces to Queen Elizabeth's *Virginal Book*; but his fame rests on the canon, *Non Nobis Domine*, which, amid all changes in musical taste, has retained its popularity, and still continues to challenge admiration. B. died in 1623.

BIRDS (*Aves*), the second class of Vertebrated (q. v.) Animals, and the first of oviparous vertebrated animals, including all the oviparous animals which have warm blood. B. exhibit great similarity in their general structure, and are sharply distinguished

from all other classes of animals. To this class belong all animals, except Bats (q. v.) alone, which have an internal skeleton, and are capable of true flight. The anterior extremities of B. serve them only as wings or organs of flight, and never in any degree as arms or legs; those few birds in which the wings are too small to raise the body in the air, generally employ them to aid their swift running upon land, as the ostrich, or for swimming under water, as the great auk and the penguins. The body is covered with feathers (q. v.), and this is one of the characters in which all birds agree, and by which they are distinguished from all other animals. The general form is adapted to motion through the air, and the trunk is compact, and somewhat boat-shaped. The vertebral column possesses little flexibility; indeed, the vertebræ of the back generally become ankylosed or firmly united together by cementing bone, the solidity which is thus acquired being of evident use for the support of the ribs, and these also are proportionately stronger than is usual in quadrupeds; each of them is provided in the middle with a flattened bony process, directed obliquely backwards to the next rib, so that they support one another, whilst instead of being united to the sternum, or breast-bone, by cartilages, as in quadrupeds, they are continued to it in the form of bone; all these things combining to give strength to that part of the body in which it is particularly needed, both in order to the powerful action of the wings, and the perfect freedom of respiration during flight. In those birds, however, which do not fly, the vertebræ of the back retain some power of motion. The hinder part of the vertebral column exhibits a solidity even greater than the anterior part of it, the lumbar vertebræ (q. v.) being consolidated into one piece with the pelvis (q. v.), which furnishes attachment to strong muscles for the support of the trunk upon the legs, and for the motion of these organs. The vertebral column, however, terminates in a number of small movable (*coccygeal*) vertebræ, the flexibility of this part being necessary to the motion of the tail, which is itself supported by a short and generally much elevated bone, regarded as consisting of ankylosed vertebræ, called the rump-bone, or, from its peculiar form, the ploughshare-bone.

In contrast to the general stiffness of the vertebral column in the trunk, it is remarkable for great flexibility in the neck, enabling a bird to make ready use of its bill, or to bring its head into such positions as suit the adjustment of the centre of gravity in flying, standing, &c.

The number of vertebræ in the neck varies from ten to twenty-three, the smallest number being greater than is found in any quadruped. The head, also, is so articulated to the neck, by a single *condyle*, or pivot, that a bird can turn its head round in a manner impossible to the mammalia. The skull itself is formed of bones corresponding with those of man and quadrupeds; but they can only be distinguished when the bird is very young, soon becoming consolidated together. The jaws are much elongated, so as to form the bill, the organ chiefly employed in seizing food, as well as for fighting, nest-building, dressing or preening the feathers, and instead of a *hand* for every purpose which bird-life requires. The upper mandible of the bill is so connected, however, with the bone of the skull, by elastic plates, that it possesses some power of motion, and any shock which it may receive is much deadened before reaching the skull. The bill affords many of the most important distinctive characters of B., differing very much according to the mode of life of different orders and tribes. See BILL.

The following illustration will serve to indicate

the principal bones of a bird's skeleton; we borrow it from M'Gillivray's *British Birds*.

The sternum or breast-bone in B. is remarkably large and strong, serving for the attachment of the

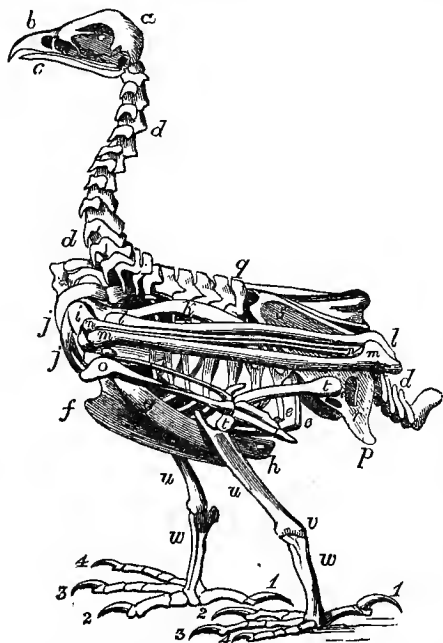

Skeleton of Golden Eagle:

a, cranium; *b*, upper mandible; *c*, lower mandible; *d*, *d*, vertebrae; *e*, *e*, ribs; *fgh*, sternum; *i*, coracoid bone; *j*, furcula; *k*, scapula; *l*, humeral bone; *m*, ulna; *n*, radius; *o*, metacarpal bones; *p*, *q*, united sacrum and pelvis; *r*, ischium; *s*, ilium; *t*, thigh-bone; *u*, tibia; *v*, ankle-joint; *w*, tarsus; 1, first or hind toe; 2, second or inner toe; 3, third or middle toe; 4, fourth or outer toe.

powerful muscles which depress the wings, and receives great attention from naturalists, because its variations correspond with the differences in some of the most important characters and habits of birds. It generally exhibits a projecting ridge along the middle, which is proportionately largest in birds of

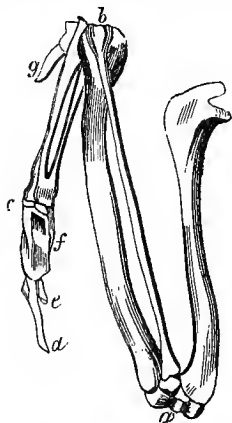

Skeleton of Bird's Wing.

most powerful flight, and is wanting only in ostriches and a few other birds of allied genera which do not

fly. The clavicles or collar-bones, also, are generally united to form the fourchette (*furcula*) or merry-thought bone, serving, along with two bones called the coracoid bones, to keep the shoulders separated, and to resist the compressing tendency of the action of the wings. The bones of the wing itself are regarded as corresponding to those of the anterior extremities in man and quadrupeds; the bones of the hand, however, being much disguised, and some of them wanting or rudimentary. In the accompanying cut of the bones of a bird's wing, *a* is regarded as the elbow-joint, *b* as the wrist-joint, *c* as the knuckle-joint, *d* being the representative of a finger, *e* and *f* the rudimentary representatives of two others, whilst the *winglet*, *g*, formerly regarded as representing the thumb, is now rather supposed to be homologous to the forefinger. The wings, therefore, exhibit a structure entirely different from those of bats, in which the fingers are extremely elongated. The surface necessary for striking the air is provided by feathers larger and stronger than those of other parts of the body, called *wing-feathers*, *quill-feathers*, or *quills*. Of these, which exhibit an admirable combination of strength with lightness and elasticity, some spring from the part of the wing between *b* and *d* (in the figure of the bones of the wing); these are always the largest, and are called the *primary* wing-feathers, or simply *primaries*; those which spring from the part between *a* and *b* are called *secondaries*; and those which spring from the part between *a* and the shoulder-joint, are called *tertiaries*. At the base of the quills, on both sides of the wing, are feathers called *wing-coverts*, and these are likewise distinguished as primary, secondary, &c. The feathers which grow over the shoulder-blades are called *scapulars*. The feathers of the wings vary in length and strength, according to the mode of life

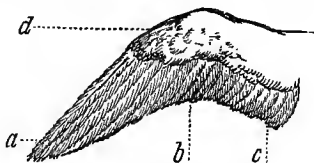

Bird's Wing, shewing Quills:

a, primaries; *b*, secondaries; *c*, tertiaries; *d*, winglet.

and power of flight in different B.; narrow, sharp, and stiff wings being indicative of swift and enduring flight. The tail-feathers serve the purpose of a rudder to guide the bird, and also that of balancing it in the air; they resemble in character the quills of the wings. They are also furnished with *coverts* above and below. Some B. have the tail rounded at the extremity; in some, it is square; in others, notched or forked. In many land B., the tail exhibits ornamental plumes, and remarkable developments of the plumage take place also in other parts of the body, in the form of crests, ruffs, shoulder-tufts, &c.

The legs of B. consist of parts corresponding to those found in man and quadrupeds; but the thigh is short, and so concealed within the body, that it is not apparent as an external portion of the limb; the next division, often mistaken for the thigh, being the leg strictly so called, or *ibia*, which ends at what is really the heel-joint, although popularly regarded as the knee; and beneath this is the shank, or *tarsus*, which in some B. is very long, serving as a part not of the foot but of the leg, and formed by a single bone which represents both the tarsus and metatarsus. The feet are divided into toes, which are generally four in number, three before and one behind, differing from each other in length and in the number of joints or phalanges of which they

BIRDS.

are composed, the toe, which is directed backward, being in general comparatively short, and consisting only of two joints. A fifth toe or tarsal spur is found in some of the gallinaceous B.; and in some B., as Bustards, the hind-toe is wanting; the ostrich has only two toes, both directed forward, with the obscure rudiment of a third; and numerous B. classed together in the order of Climbers (q. v.) or Yoke-footed B., including Parrots, Cuckoos, Woodpeckers, &c., have two toes before, opposed by two toes behind, the foot being thus particularly adapted for grasping, so that parrots, as is well known, even use it as a hand.—The feet of B. vary considerably according to their mode of life; and naturalists therefore depend very much upon them in classification. In some the claws are strong and hooked; in others short, straight, and weak; in some the toes are all separate, in others more, or less connected; in B. specially adapted for swimming, they are generally *webbed* or united by a membrane; in other swimming-B., however, a membrane only extends along the sides of each toe. In most B. the tarsus is feathered to the heel-joint; in some, however, and particularly in *waders*, the lower part of it is bare; the shank and toes are generally, although not always, destitute of feathers, and are covered with a scaly skin. Almost the only other parts of a bird often destitute of feathers, are the *cere* at the base of the bill, and the combs and wattles of gallinaceous birds.

In order to flight, it is indispensable that the centre of gravity of a bird should be under the shoulders; and when a bird stands, the feet are brought forward, and the head thrown back, so that the claws project beyond a vertical line passing through the centre of gravity of the whole body. This is generally accomplished so that the trunk is in an almost horizontal position, the fore-part only a little elevated; but in some B., which have a short neck and short legs, an erect attitude is necessarily assumed, so that the penguins of the southern seas present to navigators a somewhat ludicrous resemblance to regiments of soldiers on the beach. B., when they sleep, very generally place their head under their wing, and some of them also stand upon one foot, their equilibrium being thus more easily maintained. A remarkable contrivance, particularly to be observed in storks and other long-legged B., renders this posture unfatiguing; a locking of the bone of one part of the limb into a sort of socket in the bone of the part above it, so that it retains its place without muscular exertion; whilst a similar purpose is served by the tendons of the muscles which bend the claws passing over the joints of the leg in such a manner as to be stretched by the mere pressure there when the weight of the bird rests upon the legs, so that without any effort the claws retain a firm hold of the branch upon which it is perched.—Flying is accomplished by the action of the wings upon the elastic and resisting air; the muscles by which the stroke of the wing is given are powerful, those by which it is retracted are comparatively weak. Owing to the manner in which the first strokes of the wing must be given, few B. rise with facility from a level surface; and some of them, as swallows, and particularly swifts, rise from a perfectly level surface with great difficulty, and comparatively seldom alight where they cannot find an elevation from which, as it were, to throw themselves.

The digestive apparatus of B. resembles that of mammalia; exhibiting, however, various modifications, according to the different kinds of food—some B. feeding on flesh, others on fish, others exclusively on insects, others on seeds, others more indiscriminately on a variety of animal and vegetable substances.

Few B. masticate their food in any degree, although parrots do; upon being swallowed, it enters the *crop* or *craw*, sometimes called the first stomach, an enlargement of the œsophagus or gullet, situated just before the breast-bone, and here it is moistened by a secretion, which is also by some B.—particularly by pigeons—employed as the first food for their young, the glands of the crop enlarging very much, so as to produce it in large quantity at the time when it is wanted for that purpose. The crop is wanting in the ostrich, and also generally in B. that feed on fish; and is of greatest size in those of which the food consists of seeds or grain. It is generally single, and on one side of the gullet; sometimes, as in pigeons, it is double. A second stomach, or dilatation of the œsophagus, called the *proventriculus* or *ventriculus succenturiatus*, is generally largest in those B. in which the crop is wanting or small; and in this the food is further softened and changed by a secretion which is mixed with it. The third and principal stomach is the *gizzard*, which in B. of prey, fish-eating B., &c., is a mere membranous sac; but in B. which feed on grain or seeds is very thick and muscular, so that it acts as a sort of mill, and with extraordinary power. In these B., also, a remarkable provision is made for the perfect grinding down of the contents of the gizzard, by the instinct which leads them to swallow small rough pebbles or grains of sand, an instinct well exemplified in the common domestic fowl.—The liver of B. is, in general, very large. The kidneys are large, but there is no urinary bladder, and the urine is at once poured into the *cloaca*, an enlargement of the intestine, at its termination, with which also the organs of generation communicate in both sexes. We are again indebted to M'Gillivray's excellent work for the following cut.

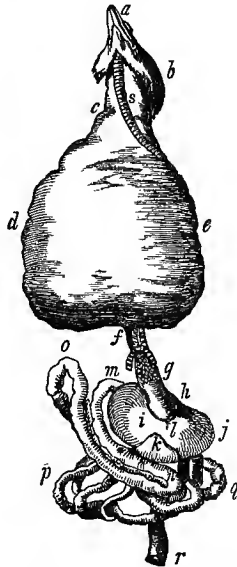

Digestive Organs of Domestic Pigeon :

a, bill; b, head; c, œsophagus; d, crop of extreme size; e, continuation of œsophagus; f, proventriculus; g, gizzard; h, upper muscle; i, j, lateral muscles; k, lower muscle; l, tendon; m, intestine; n, trachea.

The respiration of B. is very perfect, and their blood is from 12° to 16° warmer than that of mammalia; its circulation more rapid, and the energy of all the vital processes proportionally great. B., consequently, exhibit great liveliness; and upon the

BIRDS.

admirable provision for the aëration of their blood they depend also for their powers of flight, which enable some of them to travel hundreds of miles with great rapidity and without exhaustion, whilst others soar to a prodigious height in the air. The heart resembles that of the mammalia in its form and structure; but the right ventricle, instead of a mere membranous valve, is furnished with a strong muscle, to impel the blood with greater force into the lungs. The lungs are small, and communicate with large air-cells (q. v.) in the cavities of the body, and even in the bones, so that the aëration of the blood takes place not only in the lungs but during its circulation through the body. An extraordinary proof of the use of these air-cells in respiration was afforded in a recorded instance of a large sea-fowl, which, when an attempt was made to strangle it, was kept alive by the air entering in a forcible current through a broken wing-bone. (Gosse, *The Ocean*, quoting Bennett's *Whaling Voyage*.) B. consume much more oxygen in proportion to their size than quadrupeds.

The organs of the senses are similar to those of mammalia. In the senses of touch and taste, it is generally supposed that there is an inferior development, although parrots appear to possess the sense of taste in considerable perfection; and the bills of some B., which search among the mud for their food, are certainly very delicate organs of touch. But the sight is remarkably keen, and the eye possesses great powers of accommodation to different distances. B. perceive even small objects distinctly, at distances at which they would be quite indistinguishable to the human eye, and thus are enabled to seek their food. B. of prey also appear to possess in great perfection the sense of smell. The nostrils of all B. open on the upper surface of the bill. Hearing is acute in B., and particularly in nocturnal B., although the organs of this sense are less complicated than in mammalia, and there is seldom any vestige of an external ear. Singing-B. are extremely sensitive to differences of pitch. The voice and musical powers depend upon the conformation of the windpipe and larynx, which differs very much in different birds.

Reproduction takes place by eggs (see REPRODUCTION and EGG), which are hatched after they have passed from the body of the mother. B. generally sit upon their eggs, their bodies supplying the warmth necessary to hatch them (see HATCHING); and this office is usually undertaken by the female alone, but sometimes is shared by the male. In very warm climates, the ostrich leaves her eggs to be hatched by the heat of the sun, but in colder climates sits upon them. A very few B., as the cuckoo, deposit their eggs in the nests of other B., to be hatched by them. Some B. construct no nest, but lay their eggs on the bare rock, as many sea-fowl do, or in holes rudely scratched in the earth or sand; many, however, shew in the construction of their nests the most admirable instincts. See NESTS OF BIRDS. The number of eggs varies, in a state of nature, from 1 to about 20, being generally smallest in the larger B., and particularly in B. of prey. B. generally breed only once a year, but some B. twice. The care which B. take of their young is as admirable as the ingenuity which they display in nest-building, and more universal. Some B. are able to run about, and pick up food as soon as they leave the shell; others remain in the nest for days, or even weeks, and must be supplied with food by their parents. Many species are social, particularly at the breeding-season, and form large settlements, which they guard in common; and some even unite in the construction of large nests, which belong to a whole community.

The rapacious B., and particularly the larger ones, are very solitary in their manner of life.

B. change their feathers (*moult*), in general, once a year, and the colours of the plumage in many cases vary much in summer and winter. The change of colour, however, often takes place without change of feathers, and in B. which moult, both in spring and autumn, the autumn moulting is much more complete than that of spring. The gayest plumage of many B. is assumed at the breeding-season, with which, also, the song of B. is connected. See SONG OF BIRDS. The plumage of the male is, in general, more gay than that of the female, all the young at first resembling the female in plumage. The plumage usually characteristic of the male is occasionally assumed by the female, and most frequently by females which have become unfit for the ordinary functions of their sex.

The brain in B. differs in some important respects from that of mammalia (see BRAIN), presenting resemblances to the brain of reptiles and fishes; but it is of large size, often larger than even in quadrupeds. The manifestation of intelligence is not, however, usually so great in B. as in quadrupeds. Their nest-building, their migrations (see BRDS OR PASSAGE), and many other things of greatest interest, must be ascribed to instinct.

In the geographical distribution of B., the limits of species are not so exactly circumscribed by mountains, seas, and rivers, as in other classes of animals, their powers of flight enabling them to pass over these obstacles. Yet some species, and even groups, are found exclusively in certain regions: thus humming-birds are all American, penguins are found only in the southern seas, and B. of paradise are confined to New Guinea and the neighbouring islands. See SPECIES, DISTRIBUTION OF.

The free movements of B. through seemingly boundless space, the joyous song of many, and the characteristic tones of all—their brilliant colours, their lively manners, and their wonderful instincts—have from the earliest ages made a strong impression on men's minds, and in the infancy of intellect gave rise to many peculiar and mysterious associations with this class of creatures. Hence the flight of B. was made the foundation of a particular art of divination. See AUGURIES and AUSPICES. Religion borrowed many of its symbols from them, and poetry many of its ornaments.

In an economical point of view, B. are very important. The flesh and eggs of almost all B. may be eaten, although those of B. of prey and of fish-eating B. are generally reckoned unpleasant. Their feathers are employed for various purposes of use and ornament; their dung is valuable for manure, and guano (q. v.) is nothing else than the accumulated dung of sea-fowls. Many B. are extremely useful in preventing the multiplication of insects and worms, and compensate in this way for the mischief which they occasionally do in fields and gardens. Domestic poultry are a source of considerable profit, upon account of their eggs, flesh, and feathers. See POULTRY. Some kinds of B. of prey have been tamed, and trained to the use of the sportsman. See FALCONRY.

About 5000 existing species of B. are known. As to their systematic arrangement, see ORNITHOLOGY.

The order of B. presents in the Dodo (q. v.) a remarkable and well-ascertained instance of the recent extinction of a species, and even of a genus. It is also a remarkable and interesting fact, that the greater part of the remains of extinct B. hitherto discovered are those of land-B. destitute of the power of flight, like the dodo, and the still existing ostrich, cassowary, emu, and apteryx. A particular interest

is attached to those of the gigantic *Dinornis* (q. v.) of New Zealand. See next article.

BIRDS, FOSSIL. While the animal and vegetable kingdoms of the paleontologist extend to as wide, or rather a wider, range than those of the historian of modern life, yet several divisions are scantily represented in the petrified remains preserved in the stony records of the earth's crust. This was to be expected from the conditions under which these fossiliferous strata were deposited. As these rocks are aqueous, chiefly marine, the relics of plants and animals whose natural habitats were in or near the water, must be common in a fossil state, whilst the remains of others with different habits will be comparatively rare, if present at all. Birds belong to this latter class. Their power of flight would save them from numerous casualties which would prove fatal to quadrupeds; and even if they did perish in water, the lightness of their bodies, produced by their internal cavities and the quantity of their feathers, would keep them floating until they decomposed, or became the food of predaceous animals.

The earliest traces of birds consist of footprints on red argillaceous sandstones in the valley of Connecticut river, North America. These sandstones, though long considered of a much older date, have

been, on the best evidence, referred by the brothers Rogers to the oolitic period. The beds had formed an ancient sea-beach, and over it, during the recession of the tide, had marched the animals, which have left on them their footsteps. Before the return of the tide, the inequalities had been filled up with dry air-drifted sand and mud, and on this was deposited a new layer of silt. The beds often exhibit ripple-marks, and occasionally small circular depressions, which have been formed by drops of rain. The traces of thirty-three species of B. have been distinguished; with them are associated the impressions of various lizards, chelonians, and batrachians. The size of the *Ornithichnites* (Gr. *ornis*, a bird, and *ichnon*, a trace or footprint), as the bird-tracks are called, so far exceed those that would be made by the largest living birds, that it was doubted whether their origin had been satisfactorily explained, until the discovery, in New Zealand, of the remains of the *Dinornis*. In one species, the imprint of the foot measures fifteen inches in length, and ten inches in breadth, excluding the hind claw, which is two inches long. The distance of the impressions from each other varies from four to six feet. These measurements indicate a bird about four times the size of an ostrich, but probably not much larger than some species of *Dinornis*. The footprints are for the

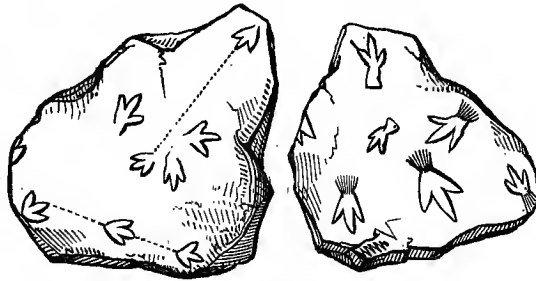

Bird-tracks in New Red Sandstone.

most part trifold, and shew the same number of joints as exist in the living tridactylous birds.

No indications of the existence of birds have been discovered in the rocks of the cretaceous period. It does not follow, however, that the class *Aves* had no representatives during the ages when the chalk was being deposited. This is a deep-sea formation, and for the reasons already stated, it is not to be expected that the remains of this class should be found in these measures. And so also it would be rash to conclude, that the oolitic footprints give the date of the first appearance of B. on the globe. The bone of *Cimiliornis Diomedeus*, found in the chalk, which was described by Professor Owen as part of the humerus of a bird, is now believed to belong to a Pterodactyle.

No true fossil remains of B. have been discovered in rocks older than the Eocene-gypseous deposits of Montmartre, where ten species have been found. Seven species have been described from strata of the Miocene period, the most important of which have been found in the Sewalik beds, associated with the remains of huge proboscidea. But the Pleistocene deposits have supplied more than half of the known fossil birds. The most remarkable of these are the bones of huge struthious B. of the genera *Dinornis* (q. v.), *Palapteryx* (q. v.), and *Aptornis*. Dr. Mantell mentions the fossil eggs and bones of a bird still larger, called the *Aepyornis*, from Madagascar.

BIRD'S-EYE LIMESTONE is a division of the Trenton group of the Lower Silurians of North America, apparently equivalent to the Llandeilo flags, and containing, besides the remains of brachiopods, many enormous orthoceratites.

BIRD'S-EYE VIEW is a term applied generally to modes of perspective in which the eye is supposed to look down upon the objects from a considerable height. If the eye is considered as looking perpendicularly down while it sweeps over each point of the scene in succession, we have an exact ground-plan; no object covers another, horizontal angles and distances are exactly represented; while, on the other hand, no vertical angles or side-views appear. In sketching or drawing a locality for military or economical purposes, this kind of perspective is always used. The great difficulty is to represent at the same time the relative heights of mountains and steepness of acclivities. But the more usual kind of bird's-eye views differ from common perspective only in the horizontal line being placed considerably above the picture. In the 16th c., the only kind of views known were of the nature of ground-plans, and the artists of the 17th c. tried to combine this method with side views.

BIRD'S FOOT (*Ornithopus*), a genus of plants of the natural order *Lepuminosae*, sub-order *Papilionaceae*, deriving both its popular and its botanical name from the resemblance of the curved pods to

birds' claws; the leaves are pinnate, with a terminal leaflet. One species (*O. perpusillus*) is a native of Britain, growing on dry, sandy, or gravelly soils—a small plant of little importance, the flowers of which are white, striated with red. But *O. sativus*, an annual growing to the height of two or three feet, a native of Portugal, is cultivated in that country as green food for cattle, and is very succulent and nutritious. Like its British congener, it grows well on very poor soils. Its Portuguese name is Serradilla.

BIRD'S FOOT TREFOIL (*Lotus*), a genus of plants of the natural order *Leguminosæ*, sub-order *Papilionaceæ*. The pods are cylindrical, somewhat spongy within and imperfectly divided into many cells. The name B. F. T. is derived from the resemblance of the clusters of pods to a bird's foot. It has received the name *Lotus* from botanists, because a species of this genus is supposed to have been one of the plants so named by the Greeks. See *LOTUS*. The species, which are pretty numerous, are natives of the temperate and colder regions of the old world. The COMMON B. F. T. (*L. corniculatus*) is very abundant everywhere in Britain in pastures. It has a stem 6-12 inches in length,

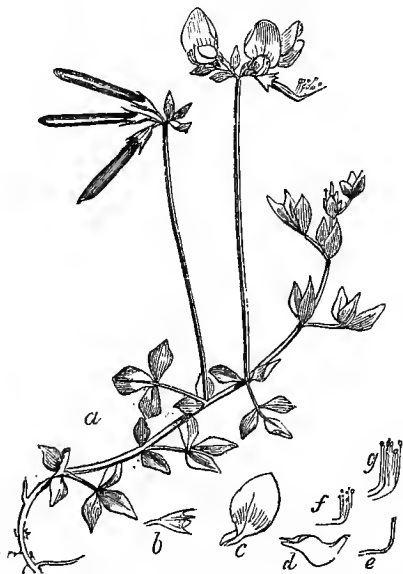

Bird's Foot Trefoil (*Lotus corniculatus*).

a, a stem with leaves, flowers, and pods; b, calyx; c, standard of flower; d, keel of flower; e, style; f, stamens.

decumbent, and bearing umbellate heads of 8-10 yellow flowers, which have a rich honey-like smell. The leaves have three obovate leaflets, like those of the true Trefoils or Clovers, but at the base of each leaf-stalk there are also two large leaf-like ovate stipules. The plant is by some regarded as the shamrock (q. v.) of Ireland. It is eaten with great avidity by cattle, and its deeply penetrating roots adapt it well for very dry situations.—A larger species, otherwise very similar, by many regarded as merely a more luxuriant variety of this, with stem nearly erect, more compact heads of smaller flowers, and much smaller seeds, is the GREATER or NARROW-LEAVED B. F. T. (*L. major*), which also is a common native of Britain, generally found in moist, bushy places. The characteristic differences remain under

cultivation in every variety of soil and situation.—A species called the Winged Pea (*L. tetragonolobus*), remarkable for four membranous wings which run along its pods, a native of the south of Europe, is frequently cultivated in gardens in Britain amongst other annual flowers; but in some parts of Europe it is cultivated for its seeds, which are used as a substitute for coffee.

BIRDS OF PASSAGE are those birds which spend one part of the year in one country or climate and another part in another, migrating according to the season. No species of bird is known to hibernate (see *HYBERNATION*); and although many naturalists were at one time inclined to believe in the hibernation of swallows, this opinion has been entirely relinquished, and their annual migrations are fully ascertained. Birds avail themselves of their powers of wing to seek situations adapted for them in respect of temperature and supply of food, and even within the tropics there are birds which migrate as the seasons change from wet to dry, or from dry to wet. See *BIRD OF PARADISE*. The migration of birds, however, is more generally from north to south, or from south to north, in the temperate and colder regions of the globe, as winter passes into summer, or summer into winter; and B. of P. are commonly distinguished into Summer B. of P. and Winter B. of P., as they are summer or winter visitants; but, of course, those which are Summer B. of P. in one country are Winter B. of P. in another. They breed in the country in which they are Summer B. of P. The arrival of Summer B. of P. is always among the welcome signs of advancing spring, and is associated with all that is cheerful and delightful. In winter, flocks of swans, geese, and other waterfowl seek the British coasts and inland lakes and marshes from the frozen north; and at the same time, woodcocks, fieldfares, redwings, and many other birds which breed in more northern regions, regularly appear. Some birds come almost at the same date annually; others are more influenced by the character of the season, as mild or severe. Many sea-fowl are migratory, and the inhabitants of St Kilda and other isles, to whom they are of the greatest importance, depend with confidence upon their return almost at a particular day. The migrations of pigeons in North America are extraordinary, from the vast numbers of which the migrating flocks consist. See *PIGEON*. The whole subject of the migration of birds is one of great interest, particularly in reference to the instinct by which they appear to be guided. Birds of migratory species, which have been reared in confinement, become restless when the season for migration arrives, and in many species the migration seems to be little influenced by the state of the weather. It would seem that the youngest swallows are left behind, to follow the first migrating hosts of their species. The number of B. of P. is very considerable, nor are they all or mostly birds of long wing and powerful flight, but many short-winged birds are included among them. Some B. of P., as woodcocks, have, however, been found in a very exhausted state after their arrival; and it is to be considered that, both in the old and new world, distant migrations are possible without long flights. Some birds possess such powers of wing, that they may easily pass over wide seas; and the rapidity of the flight of birds—from 50 to 150 miles an hour—partly explains the possibility of their migrations between distant parts of the world. It is believed that B. of P. habitually return to the same localities which they have inhabited in former years, and this seems to have been sufficiently established by proof, at least in regard to swallows.

BIRDS OF PREY, a common English appellation of the order of birds called *Accipitres* (q. v.) by Linnaeus. Some birds, however, which do not belong to this order, frequently pursue and prey upon other birds. If those which make fishes, insects, and worms their food, were also reckoned, great part of the whole class of birds must be considered predaceous. B. of P. are very commonly divided into two sections—*Diurnal* and *Nocturnal*; the latter consisting exclusively of owls.

BIRIOUTCHÉ, or **BIRIUTCH**, a town in the government of Voronej, Russia, on the left bank of the Sosna, a tributary of the Don. It is surrounded with earthen ramparts and a ditch, and has four annual fairs. Pop. 5500. A stream of the same name in its immediate vicinity is noted for its pearl-oysters; and the teeth of elephants are often found exposed on its banks.

BIRKBECK, GEORGE, M.D., distinguished for the leading part he took in founding mechanics' institutions, and for his general interest in the education of the working-classes, was born at Settle, in Yorkshire, January 10, 1776. He commenced his medical studies at Leeds, and afterwards pursued them at Edinburgh, where he made the acquaintance, among others, of Sidney Smith, Brougham, Jeffrey, and Horner. Appointed to the chair of the Andersonian Institution in Glasgow, he delivered his first course of lectures on Natural and Experimental Philosophy in the winter of 1799. There being at that time no philosophical instrument-maker in Glasgow, B. was forced to fall back on ordinary mechanics for the apparatus he needed for his illustrations; and their ignorance of the articles they constructed appears to have suggested to him the desirableness of a gratuitous series of scientific lectures, divested, as far as possible, of all technicality, for 'persons engaged in the practical exercise of the mechanical arts.' He commenced these lectures in 1801; and though the first one was but thinly attended, when he had reached the fifth, the hall was filled to overflowing by an audience intensely interested in what they heard; and who, on the termination of the course, shewed their appreciation of B.'s thoughtful interest in them by presenting him with a silver cup. B. continued those gratuitous lectures through two other seasons, when he resigned his professorship; and in 1806, settled in London as a physician. What leisure an extensive practice in his profession left him, was devoted to the promotion of the spread of education among those who in youth had had few or no opportunities of acquiring knowledge. He took a leading and active part, along with Brougham and others, in the formation of the London Mechanics' Institution—the first of its kind in the kingdom—and was chosen its president for life. He died in London, December 1, 1841.

BIRKENHEAD, a seaport town in the north-west of Cheshire, on the left bank and near the mouth of the Mersey, opposite Liverpool. B. owes its origin to a Benedictine priory founded here in the 12th c., of which some remains still exist, but it was for centuries nothing but a fishing-village, and its rapid growth as a town has been due to the important public works executed within the last few years. Pop. 1821, 236; 1841, 8223; 1851, 24,285. Of the works alluded to, the chief are the docks, begun in 1824, and greatly extended since 1844, the largest of which covers a space of 120 acres. The town is governed by twenty-one commissioners. It has wide streets, good sanitary regulations, respectable buildings, a fine public park of 226 acres, and an elevated cemetery near it. Handsome villas, built by Liverpool and B.

merchants, are continually springing up. In St Aidan's College, founded 1846, candidates are trained for the English Church. B. communicates with Chester (16 miles) by rail, and with Liverpool by small steamers, which leave each side at least every fifteen minutes, from an early hour in the morning up to a late hour at night.

BIRKIE, a simple game at cards usually played by two persons, between whom the cards are divided. Holding their cards with the backs upwards, the players lay down a card alternately, and when a card is played of the same suit as that which preceded it, it wins the trick. B. is an old game in Scotland, but is now played only by children.

BIRLEY-MAN, a person who acted as petty officer on an estate, or in a village, in Scotland, and who was inferior in importance to a baron-bailie. The duty of the B. was to keep order, and attend to the interests of the proprietor. The office, at least in name, is now extinct or nearly so. Formerly, there were Birley Courts for determining petty cases. The term Birley, or Burlaw, is traced to *byr*, Icelandic, signifying a villager or husbandman. See Jameson's *Scot. Dict.*

BIRMAH. See **BURMAH**.

BIRMINGHAM, the chief town in Britain for metallic manufactures, and supplying much of the world with hardwares, stands near the centre of England, in the north-west of Warwickshire, with suburbs extending into Staffordshire and Worcestershire, 112 miles north-west of London. Built on the east slope of three undulating hills, on the Rea and the Tame, on a gravelly foundation overlying clay and new red sandstone, and supplied with plenty of water, it is one of the best drained towns in England, but the smoke and dust of a thousand forges give it a grimy aspect. The lower part of B. is old and crowded with workshops and warehouses, and the upper is new and regular. B. began very early to be the seat of iron manufactures, from its vicinity to a forest and extensive iron-mines; but its industry and trade were long small. Its high commercial importance dates from the 17th c., when the restoration of Charles II. brought from France a fashionable rage for metal ornaments, and B. supplied the demand with unexampled vigour. From being the 'toyshop of Europe' of Burke's time, B. now constructs steam-engines, hydraulic-presses, and Crystal Palaces, and its hardwares are unequalled in the world for quantity, variety, and value. Pop. 1690, 4000; 1801, 60,822; 1851, 232,841. B. returns two members to parliament. It produces upwards of £4,000,000 worth of goods yearly, chiefly of articles made of gold, silver, iron, brass, steel, mixed metal, plated metal, glass, papier-maché, japanned and electrotyped articles; including firearms, swords, metal ornaments, toys, jewellery, buttons, buckles, lamps, pins, steel-pens, tools, locks, steam-engines, and all sorts of machinery. In B. 1000 ounces of gold are made into chains weekly; at least 70 ounces of gold-leaf are used weekly; 30,000 gold rings are made yearly; 150,000 ounces of silver are used yearly; a billion of steel-pens are made yearly, 90 tons of iron being used; above 80,000 copper coins are struck daily; 20,000,000 nails are made weekly at one work; 5,000,000 firearms were made between 1804 and 1818; and during the Crimean war the government were supplied with 3000 muskets weekly. The button manufacture of B. is very large. The steam-engines employed in B. in 1859 were equal to 9000 horse-power, or to the labour of 144,000 men, and they consumed 520 tons of coal daily. Most of the work is done not in factories, but in independent workshops, the owners

being workmen themselves. In B. above 20,000 families are engaged in trade, manufactures, and handicraft. B. is well provided with religious, educational, and charitable institutions. It has 100 churches, 30 belonging to the Establishment; a grammar-school, founded in 1552, with a yearly revenue of £11,000; a Queen's College connected with the London University; a well-conducted literary and scientific institute (chiefly for the working-classes); a free public library; a Roman Catholic college and cathedral; a botanic garden; and several public parks. The town hall is seated for 4000 persons, and has a magnificent organ, and a musical festival is held in it once every three years. Of the many ways of spelling the name of this city, the oldest is that given in *Doomsday Book*—namely, Bermingeham. This afterwards became Brummagem, a term of reproach, implying pinchbeck, or hinting at fraudulent processes to make things glitter like gold. B. took the Parliament side in 1643, supplying swords, and using them well against Prince Rupert and his lancers. In 1791, a B. mob denounced the distinguished Dr Priestley as an atheist and Jacobin, and destroyed his house, library, and apparatus, besides much other property. Near Handsworth, a little to the south of B., are the famous Soho and Smethwick Works, founded by Watt and Boulton, where steam-engines were first made. Handsworth church has a statue of Watt by Chantrey, and one of Boulton by Flaxman. Darwin, author of *Zoonomia*, and Withering the botanist, lived in Birmingham. Thomas Attwood originated the Political Union here, which greatly hastened the passing of the Reform Act of 1832, and the enfranchisement of Birmingham.

BIRNAM, a hill 1580 feet high, in the east of Perthshire, near Dunkeld, 12 miles north-west of Perth, and 12 miles west-north-west of Dunsinnan hill, one of the Sidlaws. It commands a fine view of the valley of the Tay. It was formerly covered by part of an ancient royal forest. Shakspeare has immortalised B. wood in his tragedy of *Macbeth*.

BIRNEE, Old and New, the name of two towns of Bornu, central Africa. Old B., which was formerly the chief city of the empire, walled and of vast extent, is situated on the banks of the Yeu, about 70 miles north-west of the modern capital Kuka, or Kukawa, and about 75 miles west of Lake Tsad, in lat. 13° N., and long. 13° 15' E. It is now greatly deserted and decayed, but it has still a population estimated at 10,000, and considerable markets. New B. is about 20 miles south of Kuka, is walled, and has a large mud palace. Pop. about the same as that of Old Birnee.

BIRON, or **BIREN**, ERNEST JOHN DE, Duke of Courland, born 1687, was the son of a landed proprietor in Courland, of the name of Bühren. He studied at Königsberg, and in 1714 visited St Petersburg, where his handsome person and cultivated mind soon gained him the favour of Anna Ivanovna, niece of Peter the Great. When Anna ascended the throne of Russia in 1730, Biron repaired to court, and was loaded with honour. He assumed the name and arms of the French dukes De Biron, and soon swayed all Russia through his royal mistress. Proud and despotic by nature, he hated every one who stood in the way of his ambition. The princes Dolgorucki and their friends were his first victims. More than a thousand persons were executed by his orders, and a still greater number sent into banishment. The empress is said to have often thrown herself at his feet to induce him to relent, but her prayers and tears were of no avail. It is, however, undeniable, that by the strength of his character he

introduced vigour and power into every branch of the public administration throughout Russia. In the year 1722, he married a Courland lady, and in 1737, the Courlanders were compelled to choose him as their ducal ruler. By his desire the empress, on her death-bed, appointed him guardian and regent during the minority of her presumptive heir, Prince Ivan. On the death of the empress (25th October 1740), Biron assumed the regency, and acted with great prudence and moderation. A secret conspiracy was, however, soon formed against him, and on the night of the 19th November he was arrested, by the orders of Field-marshal Münnich, and conveyed to the fortress of Schlüsselburg, where he was tried and sentenced to death. His sentence was afterwards commuted to imprisonment for life, and confiscation of his property. He was now, along with his family, conveyed to Pelim, in Siberia. When, in the following year, Elizabeth ascended the throne of Russia, B. was recalled, and Münnich sent to occupy his prison in Siberia. The sledges met at Kasan; the two enemies looked at each other, but continued their journeys without exchanging a word. During the remainder of Elizabeth's reign, B. continued to reside with his family at Jaroslaw. The Empress Catharine II. restored to him the Duchy of Courland, and he died 25th September 1772.

BIRR. See **PARSONSTOWN**.

BIRS, a small but famous affluent of the Rhine. It rises in the canton of Bern, Switzerland, near the pass of the Jura called Pierre Pertuis, flows in a north-easterly direction through the Münsterthal, and enters the Rhine near Basel. In a narrow gorge through which the stream breaks, at a little distance from that city, 500 confederate Swiss died heroically, on the 26th August 1444, in battle against the French army under the Dauphin Louis. On the same river, near the village of Dornbach, about a mile and a half south of Basel, 6000 confederate Swiss gained a splendid victory over 15,000 Austrians, under Fürstenberg, on the 22d of July 1499; in consequence of which, the Emperor Maximilian signed a peace at Basel on the 21st of September following.

BIRTH. The act of coming into life has an important legal bearing in regard to the evidence of its legitimacy or illegitimacy. These qualities are variously determined by the regulations of different systems of jurisprudence. The ancient Roman law, as well as the modern Prussian and French Codes, in particular, contain anxious provisions on the subject. In England, no precise time appears to be prescribed for fixing legitimacy or illegitimacy of birth. Forty weeks is considered, in practice, the more usual time for legitimate births; but a discretion to allow a longer time is exercised, when, in the opinion of medical men, or under the peculiar circumstances of the case, protracted gestation may be anticipated, or is likely to occur. In Scotland, the law is more distinct. There, in order to fix bastardy on a child, the husband's absence must continue till within six lunar months of the birth, and a child born after the tenth month is accounted a bastard. The fact of legitimacy or illegitimacy may be judicially determined by an Action of Declarator in the Court of Session, which concludes, according to the nature of the case, for the legitimacy or illegitimacy of the party whose birth is the subject of the legal inquiry. In England, legitimacy may be ascertained by proceedings in the Court for Divorce and Matrimonial Causes, under the 21 and 22 Vict. c. 93, called the 'Legitimacy Declaration Act, 1858;' but there the remedy is not so complete as that afforded by the Scotch declarator, which may decree not only legitimacy, but also *illegitimacy*. See **BASTARDY**, **HEIR**, **INHERITANCE**.

BIRTH, CONCEALMENT OF, is an offence against the public economy, and punishable as a misdemeanour. By the 9 Geo. IV. c. 31, s. 14, it is enacted, that any woman endeavouring to conceal the birth of a child, shall be liable to be imprisoned, with or without hard labour, for any term not more than two years: and it shall not be necessary to prove whether the child died before, at, or after its birth. It is also provided, that if any woman tried for the murder of her child shall be acquitted thereof, it shall be lawful for the jury, so acquitting her, to find her guilty (if the case be so) of concealing the birth: upon which the court may pass the same sentence as if she had been committed upon an indictment for the concealment.

In Scotland, the law on this subject appears to be regulated by the 49 Geo. III. c. 14, by which it is enacted, that if a woman shall conceal her being with child during the whole period of her pregnancy, and shall not call for, or make use of help or assistance in the birth; and if the child shall be found dead, or be amissing, she shall be imprisoned for a period not exceeding two years. It has, however, been decided, that disclosure by the mother to the putative father is a sufficient defence. The punishment usually awarded for this offence in Scotland, is imprisonment from three to six, and in aggravated cases, from nine to eighteen months. See **PREGNANCY, CONCEALMENT OF**.

BIRTHRIGHT. See **INHERITANCE**, and **PRIMOGENITURE**.

BIRTHS, REGISTRATION OF, as also that of *Burials and Marriages* (q. v.), is regulated by the 6 and 7 Will. IV. c. 86, amended by the 7 Will. IV. and 1 Vict. c. 82, by which a general registrar-office for the whole of England is established. The registrar-general shall, under the act, furnish a sufficient number of strong iron-boxes to hold the register-hooks, and every such box shall be furnished with a lock and two keys, one of which shall be kept by the registrar, and the other by the superintendent-registrar; and while the register-books are not in use, they are to be kept in the register-box, which shall always be left locked. The form for general registration of births, comprises the time of birth, name, and sex of the child; the name, surname, maiden surname, and profession of the parents; the signature, description, and residence of the informant (who must be the father or mother, or in case of their inability, the occupier of the house, s. 20); the date of registration and signature of the registrar; and also the child's baptismal name (if any be given after registration, within six months). Searches may be made, and certified copies obtained, at the general registrar-office, or at the office of the superintendent-registrar of the district, or from the clergyman, or registrar, or any other person who shall for the time being have the keeping of the register-books. By 3 and 4 Vict. c. 92, provision is made for depositing with the registrar-general a number of non-parochial registers and records of births, baptisms, deaths, burials, and marriages, which had been collected by a commission appointed for that purpose, and for rendering such registers and records available as evidence. For other regulations on the subject of this article, see 21 Vict. c. 25.

The Scotch law relating to the registration of births is contained in the 17 and 18 Vict. c. 80, by which a registrar-general, parochial registrars, and other officers are appointed with suitable machinery for carrying out the provisions of the act. It is the duty of the local registrar to ascertain and register all births within his parish or district, without fee or reward, save as provided by the act; but parents,

or persons in charge of children after their birth, are required to give information of such births, and to sign the register; and after the expiration of three months following the day of birth, it shall not be lawful for the registrar to register the same, except as provided by the act. The act declares that the sheriff of the county shall have the care and superintendence of the parochial registrars; and, as in England, the registrar-general is directed to furnish strong iron-boxes to hold the registers and other documents, such box to have a lock with two keys, one of which shall be kept by the registrar, and the other by the sheriff. The 36th section contains the noticeable provision, that in the case of children legitimated by subsequent marriage of the parents, but who were originally registered as illegitimate, such registration shall be corrected by an entry of the marriage on the margin. The act contains other provisions, more or less corresponding to the enactments of the above English statutes, and generally the practice in the two countries may be said to be assimilated. See **REGISTRATION**.

BIRTHS, DEATHS, AND MARRIAGES. See **VITAL STATISTICS**.

BIRTHWORT. See **ARISTOLOCHIA**.

BIRU', BEEROO', or BEROO', a kingdom of Sudan, Western Africa, in lat. 15°—16° N., long. 5° 30'—7° 15' W. It is bounded on the N. by the Sahara, on the E. by the Niger, and has Bambarra on the S. Its western limits are not clearly defined. The capital town, Walet, is about 260 miles west-south-west from Timbuctu.

BIS, in Music, denotes that the passage over which it is placed is to be played twice, or repeated. Such passages generally have a slur or bow over them, and the word 'bis' written below it, thus $\overbrace{\hspace{1cm}}^{\text{Bis}}$

BISA'CCIA, a town of the Neapolitan province of Principato Ultra, situated on a hill about 30 miles east-north-east of Avellino, with a population of about 6000. Numerous ancient remains discovered here appear to fix B. as the site of the old *Romulea*, captured by the Romans in the third Samnite war.

BISACQUINO, or **BUSACCHINO**, a town of Sicily, about 27 miles south of Palermo, with a population of 8000, who carry on an extensive trade in grain and oil.

BISCAY, or **VIZCAYA**, the most northerly of the Basque Provinces (q. v.), is bounded N. by the Bay of Biscay; E. and S. by its sister-provinces, Guipuzcoa and Alava; and W. by Santander. It has an area of about 1300 square miles, and a population, in 1857, of 160,000.

BISCAY, **BAY OF**, that portion of the Atlantic Ocean which sweeps in along the northern shores of the Spanish peninsula in an almost straight line from Cape Ortegal to St Jean de Luz, at the western foot of the Pyrenees, and thence curves northward along the west shores of France to the island of Ouessant. Its extreme width is about 400 miles, and its length much about the same. The depth of water varies from 20 to 200 fathoms, being greatest along the north shores of Spain. The whole of the south coast is bold and rocky, in some places rising to a height of several hundred feet, and interspersed with short inlets, some of which form safe and commodious harbours. From the mouth of the Adour to the Gironde, the shore presents a totally different aspect, being low and sandy, with numerous lagoons, the embouchures of these two rivers forming the only harbours. For 200 miles north, the coast is still low, but marshy instead of sandy; and from the peninsula of Quiberon northward to Ouessant, it is moderately

elevated and rocky in some places, with several good harbours. The rivers falling into the Bay of B. on the Spanish shores are unimportant, none of them having a course of more than 30 or 40 miles. On the coast of France, it receives, through the rivers Loire, Charente, Gironde, and Adour, the waters of half the surface of the whole country. Its chief ports are Gihon, Santander, Bilbao, San Sebastian, and Passages, in Spain; and Bayonne, Bordeaux, Rochefort, La Rochelle, and Nantes, in France. Its chief islands—which are all situated north of the Gironde—are Belleisle, Ré, and Oléron. Navigation is rendered difficult and dangerous by the prevalence of north-west winds (which drive in through the wide mouth of the bay large volumes of water from the Atlantic, to be again thrown back from the long regular line of coast towards the centre, thus causing great commotion, and high, short, broken waves), and by the existence of a current—called Rennel's Current—which sweeps in from the ocean round the north coast of Spain, along the west and north-west coasts of France, then shooting across the British Channel, brushes the Scilly Isles, and after approaching the coast of Ireland, turns west and south, till it joins the north African current.

BISCHOF, KARL GUSTAV, a distinguished chemist and geologist, was born at Nürnberg (1792), and became professor of chemistry in Bonn in 1822. Having obtained the prize of the Scientific Society of Holland for his treatise on Internal Terrestrial Heat, he published in England, in connection with it, *Researches on the Internal Heat of the Globe* (Lond. 1841), which was followed by a number of papers on connected geological subjects. The results of his researches (1837—1840) on inflammable gases in coal-mines, and on safety-lamps, appeared in the *Edinburgh New Philosophical Journal* and other periodicals. His chief work is his *Manual of Chemical and Physical Geology* (Bohn, 1847—1850).

BISCHOFF, THEOD. LUDW. WILH., anatomist and physiologist, was born in Hanover, 1807, became professor of anatomy in Heidelberg in 1836. From Heidelberg he removed, in 1843, to the university of Giessen, and in 1854, to that of Munich. He has devoted himself specially to embryology, to which he has made many contributions. His *Entwicklungsgeschichte des Kanincheneies* (Brunn, 1843) received the prize from the Berlin Academy. Of his numerous writings in Müller's *Archiv*, and published separately, may be singled out the *Beweis der von der Begattung unabhängigen periodischen Reifung und Loslösung der Eier der Säugethiere und der Menschen* (Giess, 1844), in which he establishes the important doctrine of the periodic ripening and detachment of the ova in mammalia and man, independently of generation. Being called upon, in 1850, along with Liebig, to give his opinion in the famous Görlitz process (q. v.), which involved the question of the possibility of spontaneous combustion, he took occasion to give a dissertation *Über die Selbstverbrennung* (on Spontaneous Combustion), demonstrating its impossibility, which is published in Henke's *Annals of Legal Medicine* (1850).

BISCHWILLER, a town in the department of the Bas-Rhin, France, situated on the Moder, about 14 miles north of Strasburg. B. was formerly fortified, but was dismantled in 1706. It has manufactures of earthenwares, coarse woollens, linens, and gloves, and a trade in beer, leather, and the agricultural produce of the district. Pop. about 7000.

BISCUIT, in Pottery, is the term applied to porcelain and other earthenware after the first firing, and before it has received the glaze and embellishments. See **PORCELAIN** and **POTTERY**. In this condition, the ware is very porous, adheres to

the tongue when placed upon it, and allows water very slowly to percolate through its pores. The unglazed bottles employed in cooling water are examples of *Biscuit-ware*.

BISCUIT, MEAT, a preparation of the substance of meat combined with a certain quantity of flour, made into the form of biscuits, by which process the nutritive qualities of the meat are preserved for any length of time. One way of preparing these biscuits is as follows: Large pieces of beef are placed in a quantity of water sufficient to cover them, and are subjected to slow ebullition. The fat being skimmed off, evaporation is allowed to take place, until the liquid is about the consistency of sirup, when it is mixed with fine wheaten flour, rolled out to the thickness of ordinary ship-biscuit, cut into any shape required, baked, and dried in the ordinary manner. One pound of biscuit usually contains the soluble part of 5 lbs. of meat, and half a pound of flour. The meat-biscuits can be eaten like ordinary biscuits; but boiled in about twenty times their own weight of water for half an hour, with the usual condiments, they make excellent soup, and for this they were chiefly intended. Meat-biscuits were first introduced into Britain from America by Mr Borden, in the year of the Great Exhibition of 1851. They have been spoken highly of by medical men as food; they are also important as a means of preserving from waste much animal food, which the inhabitants of the Australian colonies and the Argentine Republic, having no market for, while it was fresh, were before forced to throw away.

BISCUITS (Fr. twice-baked), small, flat bread, rendered dry and hard by baking, in order to their long preservation. They are divided into two classes—the *unfermented* and the *fermented*. *Unfermented* or *unleavened B.*, generally known as *common sea-biscuits* or *ship-bread*, are made of wheaten-flour (retaining some of the bran), water, and common salt. The materials are kneaded together, either by manual labour—that is, by the hands and feet of the workmen—or by introducing the materials into a long trough or box, with a central shaft, to which a series of knives is attached, and which is made to revolve rapidly by machinery. The mass of dough so obtained is then kneaded and thinned out into a sheet the proper thickness of the B., by being passed and repassed between heavy rollers. This sheet being placed below a roller with knife-edge shapes, is readily cut into hexagonal (six-sided) or round pieces of dough of the required size of the biscuits. The indentation of the slabs of dough, in the case of the hexagonal B., is not complete, so that all the B. cut out of each slab remain slightly adhering together. These slabs of B. are then introduced into an oven for about 15 minutes, and are placed in a warm room for 2 or 3 days, to become thoroughly dry. The more modern oven is open at both ends, and the B. being placed in a framework, are drawn by chains through the oven. So rapidly is this operation conducted, that about 2000 lbs. weight of B. are passed through one of these ovens every day of ten hours.

Captains' B. are prepared from wheaten-flour, water, with common salt, and butter, with an occasional small dose of yeast to cause partial fermentation. Milk is also sometimes employed. *Water* or *hard B.* are made of flour, water, with variable quantities of butter, eggs, spices, and sugar. *Soft B.* contain increased quantities of butter and sugar. *Yeast B.* are those the dough of which is mixed with a small quantity of yeast, yielding more porous biscuits. *Buttered B.* are made with much butter and a little yeast. Other varieties of B. are named in

the following table, which gives the materials added to the sack of flour, 280 lbs. in weight :

	Water or Milk. quarts.	Butter. lbs.	Sugar. lbs.	Flavouring. Caraway seeds in ounces.	Eggs.
Captains,	10	15			
Abermethy,	8½	17½	17½	17½	
Machine,	5½	58	14		
American,	10	40			
Jamaica,	8½	17½	17½		
Coffee,	8½	17½			140

Great care must be taken in the manipulative part of the process to incorporate the ingredients in a systematic manner. Thus, the butter is mixed with the flour in a dry condition, and then the water or milk added; and when eggs are used, they are thoroughly beaten up with water, and the sugar (if the latter is required) and the egg-paste added to the dough, which has been previously prepared with butter, or without butter. The various kinds of B. in the preparation of which yeast is employed, present a more spongy aspect than the unyeasted biscuits. Occasionally a little sesquicarbonate of ammonia (volatile salt) is added, to assist in raising the dough, and make a lighter biscuit. There are three principal varieties of the yeast or fermented B., and the following table gives the ingredients used in their manufacture from a sack of flour, or 280 lbs. :

	Water or Milk. galls.	Dried Yeast. lbs.	Butter. lbs.	Sugar. lbs.
Oliver,	10½	4½	35	
Reading,	...	4½ to 5	25 to 30	
Cheltenham,	10½	5

Soft or spiced B. are prepared from flour, with much sugar, a great many eggs, some butter, and a small quantity of spices and essences. The eggs tend to give a nice yellow cream-colour to the B., which is occasionally imitated by the admixture of a chromate of lead (*chrome yellow*); but this is dangerous, and has given rise to several cases of poisoning. Several of the soft or spiced B. are referred to in the following table, a sack, or 280 lbs., being the amount of flour employed in each instance :

	Eggs. lbs.	Sugar. lbs.	Butter. lbs.	Flavour.
Tunbridge Cakes,	930	140	23	Orange flower, Water-currants, Citrons and Cara- ways.
Shrewsbury,	93	93	93	
Ginger Wafers,	600	112	112	Volatile salt, Cinnamon, Nutmeg or Mace. Ginger.
Victoria,	750	70	80	
				Essence of lemon.

The extent to which B. are now consumed may be learned from the fact, that several of the largest biscuit-manufactories each prepare and throw into market every week from 30,000 to 50,000 lbs. weight of B. of various kinds. One of the largest and most complete biscuit-manufactories in England is that of Carr at Carlisle, whose biscuits, sold in tin-hoxes, are well known. Another bakery of this kind is that of Harrison of Liverpool.

BISEGLIE, a fortified town of Naples, in the province of Bari. It is built on a promontory in the Adriatic, about 21 miles west-north-west of Bari, the district around being studded with handsome villas and country-houses, and famous for its production of currants, which are considered equal to those of the Ionian Islands. The vine and olive are also cultivated in the neighbourhood. B. has a cathedral, numerous churches, two monasteries, a hospital, an ecclesiastical college, &c., with the ruins

of a hospital founded by Bohemond for pilgrims from the Holy Land, and celebrated during the Crusades. Pop. 17,600.

BISHOP, the title of the highest order of clergy in the Christian Church. The name is in the Saxon, *biscop*, and is from the Greek *episcopos*, an overseer. The Athenians used to send officers called *episcopoi* to their subject states. The word was adopted by the Romans; and Cicero speaks of himself as an *episcopus* in Campania; it was also applied by them to the officers who inspected the provision-markets. There are two theories as to the functions of a B. in the primitive church, which may be described as the Episcopalian and the Presbyterian theories.

According to the former, the first bishops in the Church of Christ were his apostles; 'for the office whereunto Matthias was chosen is termed (Acts i. 20) *episcopos*—i. e., an episcopal office, which being spoken expressly of one, agreeth no less unto them all; and therefore St Cyprian, speaking generally of them all, calls them *bishops*.' The form of government at first established by the apostles was, that the laity or people should be subject to a college of ecclesiastical persons appointed for that purpose in every city. These, in their writings, they term sometimes 'presbyters,' sometimes 'bishops.' Thus St Paul to the elders at Ephesus says: 'Take heed to the flock over which the Holy Ghost hath made you *overseers*.'—i. e., bishops. This explains the Presbyterian view of the office. But as the apostles could not themselves be present in all churches, and as in a short time strifes and contentions arose, they appointed, after the order began at Jerusalem, some one president or governor over the rest, who had his authority established a long time before that settled difference of name took place whereby such alone were called bishops; and therefore, in the book of Revelation, we find that they are entitled 'angels.' St Irenæus, martyred in the 2d c., says: 'We are able to number up them who by the apostles were made bishops.' In Rome, he tells us, they appointed Linus; and in Smyrna, Polycarp. St Ignatius witnesses that they made Evodius B. of Antioch. St Jerome says: 'All bishops are the apostles' successors;' and St Cyprian terms bishops '*præpositos qui apostolis vicaria ordinatione succedunt*' (presidents who succeeded to the apostles by vicarious ordination). Hooker says, in his usual judicious manner: 'Such as deny apostles to have any successors at all in the office of their apostleship, may hold that opinion without contradiction to this of ours, if they will explain themselves in declaring what truly and properly apostleship is. In some things, every presbyter, in some things only bishops, in some things neither the one nor the other are the apostles' successors.' And he adds, what fairly states the Episcopal theory on this subject: 'The apostles have now their true successors, if not in the largeness, surely in the kind of that episcopal function whereby they had power to sit as spiritual ordinary judges, both over laity and over clergy, where churches Christian were established.' We find, also, that throughout those cities where the apostles did plant Christianity, history has noted a succession of pastors in the seat of one, not of many; and the first one in every rank we find to have been, if not some apostle, yet some apostle's disciple. By Epiphanius, the bishops of Jerusalem are reckoned down from St James to his own time; and Tertullian, writing in the 2d c., has the following: 'Let them shew the beginnings of their churches, let them recite their bishops one by one, each in such sort succeeding other that the first B. of them have had for his author and predecessor some

apostle, or at least some apostolical person who persevered with the apostles; for so apostolical churches are wont to bring forth the evidence of their estates.' The judgment of the Church of England as to the primitive existence of bishops is to be found in the preface to the ordination service, drawn up in the reign of Edward V., where it is said: 'It is evident unto all men diligently reading the Holy Scripture and ancient authors, that from the apostles' time there have been these orders of ministers in Christ's church—bishops, priests, and deacons.'

According to the other or Presbyterian theory of bishops, the origin and general history of the institution are thus sketched. In the earliest churches, no traces of a hierarchy, it is affirmed, are to be found. The superintendents or directors appointed over the first churches by the apostles, or chosen by the members of the congregations, were unquestionably styled indifferently presbyters or bishops—the former title being borrowed from the Jewish synagogue, the superintendent or director of which was called the Elder (Gr. *presbyter*); the latter (*episcopus*) being familiar to the heathen converts as the title of a civil office corresponding in function to that of a Christian pastor. But this original equality did not last long. As new churches multiplied, those formed round the original church, though each having its own bishop or presbyter, remained in confederacy; and in the meetings of the pastors to regulate the common affairs, one must of necessity preside, most likely determined by age, superior piety, or other qualification. From this simple circumstance, as is indicated by Clemens Alexandrinus in the beginning of the 3d c., sprang the habit of looking upon one of the bishops as superior to the others; and this superiority, at first personal and accidental, soon came naturally to be regarded as attached to the B. of a particular congregation. In his case the word B. came to signify an overseer of pastors rather than an overseer of people. The monarchical form of state government favoured this tendency, and converted the president of a presbytery into the privileged superintendent of his brother-pastors. The assumption was resisted by the presbyters at first, but from the middle of the 5th c., Episcopacy, or the domination of bishops, continued to gain the upper hand over Presbyterianism, or equality of all pastors.

In the 3d c. bishops appear still dependent on the advice of their presbyters, and the consent of the people, and shared with the former the office of teaching and the cure of souls. As yet their exclusive privileges or functions were limited to confirmation, ordination of ministers, consecration of sacred things, settlement of secular differences among Christians, and management of the revenues of the church. But the tendency to subordination and unity did not rest here. Among the bishops, at first all equal, those of the larger and more important cities began gradually to acquire a superiority over those of inferior cities. When Christianity was made the religion of the Roman empire, the bishops became more and more monarchical, and put themselves on the footing of ecclesiastical princes. The chief cities of the larger civil provinces rose to be seats of extensive dioceses, the bishops of these assuming the distinctive titles of *patriarch*, *metropolitan*, *papa*—titles of courtesy that had long been applied to all bishops; while the less important provinces, with their capitals and bishops, became subordinate. Among these provincial bishops, again, three, from obvious causes, acquired a prominence that cast all the rest into the background.—namely, Alexandria, Constantinople, and Rome. The beginnings of the ascendancy of the Roman B. are discernible as

early as the end of the 2d century. While ancient Rome sought her secular dominion more in the south and east, modern ecclesiastical Rome turned herself chiefly to the nations of the west and north; and round the B. of Rome has grown a power—the Roman Catholic Church—not less important than that of imperial Rome.

In the Roman Catholic Church the episcopal office is the foundation of the whole system. Christ's apostles are held to have transferred their functions to the episcopacy as a body. Every B., therefore, exercises within his own diocese, first, the *jus magisterii*—i. e., the right of maintaining and propagating the orthodox faith; and second, the *jus ordinis*, or regulation of the sacred and mysterious rites of the priestly office, some of which are transferred to the inferior clergy, as *jura communia*, while others remain the privileges of the bishop (*jura propria*). Among episcopal prerogatives, in addition to those already mentioned as assigned to them in the 3d and 4th c., are anointing of kings, consecration of abbots, preparation of the chrism, &c. They have also the management of the church-property in their respective dioceses, and the oversight of all ecclesiastical institutions. Election to the office of B. rests generally with the presbyters of the diocese assembled in chapter, with the sanction of the secular power and of the pope. This is the case in Prussia. Where the sovereign is a Catholic, the appointment is mostly made by him, but subject to papal approbation. At consecration, which requires the presence of three bishops, the new B. takes an oath to the sovereign and to the pope, and signs the articles of belief, on which he receives the episcopal insignia—the mitre (q. v.); crosier (q. v.), or staff; a gold ring, emblematic of his marriage to the church; the cross upon the breast; the dalmatica (q. v.), tunic, pallium (q. v.), and peculiar gloves and chaussure; and being enthroned, as formal installation into office, he then pronounces the blessing on the assembled people. In the discharge of his office, the B. has a number of subordinate assistants; sometimes, in case of age or weakness, a coadjutor, but ordinarily deans, archdeacons, &c. (q. v.)

In the Greek church, the office of B. is essentially the same, though less influential. Greek bishops, however, are always chosen from the monkish orders, and generally from the archimandrites—i. e., abbots or priors.

As Protestantism met with its chief resistance from the bishops, and, besides, laid the chief stress on doctrine rather than on church order, the episcopal order, in most of the reformed churches, either disappeared or sank into comparative insignificance. Of the continental Protestant churches, episcopacy has kept the foremost hold in Sweden and Norway. The Scandinavian bishops acceded to the reformation in 1531 only on compulsion from Gustavus Vasa, who confirmed them in their revenues and prerogatives. The B. of Upsala is primate, and has the prerogative of crowning the king, consecrating the other bishops, &c. The bishops are named by the king out of three proposed by the chapters. They preside in consistories, hold synods, visit the churches, examine and ordain ministers, consecrate churches, and watch over purity of doctrine and the property of the church. They have seats in parliament, and wear the pallium, mitre, crosier, and cross. There are only six bishops in Sweden and Norway, with an additional B. of the order of the Seraphim.

In Denmark, the Catholic bishops opposed the reformation, and were (1536) deposed by Christian III., and their extensive possessions confiscated. The king appointed in their stead a general superintendent and 9 Protestant bishops, with a fixed stipend. They are under the secular government,

and have very limited authority over the clergy under their charge. The first in rank is the B. of Seeland.

In Protestant Germany, the episcopal dignity and rights passed into the hands of the secular sovereigns, who, down to quite recent times, assumed the title of supreme bishops, and exercised the prerogatives of such. Where the sovereign, as in Saxony, was of a different confession from the majority of his subjects, the episcopal authority was delegated to a minister. The bishoprics, however, were gradually secularised, and with the nominal or titular bishops of Osnabrück and Lubeck (1803) the old episcopal dignities became almost extinct on the Protestant soil of Germany. The Lutheran Church, however, never formally abolished the office of B., and Melancthon endeavoured to get it expressly recognised. In Prussia, accordingly, the title of B. has had a fluctuating fate. The bishops in office at the time having acceded to the reformation in 1525, were continued; but in 1554 the revenues were confiscated, and the duties assigned to superintendents. In 1587 this last remnant of the episcopal office also disappeared; till Frederick I. conferred the title of B. on two of his court-preachers on occasion of his coronation. At their death it again ceased, and was not revived until at the peace-festival in 1816 Frederick-William III. raised two clergymen to the dignity of bishops. One of them, the B. of Königsberg, received in 1829 the title of Evangelical Archbishop. Several have since received the title of B., along with that of superintendent-general, entitling them to the first place in the consistories, a certain civil rank, insignia, and salary. Of the other German states, only Nassau has followed the example of Prussia, by naming (1818) a B. for the united evangelical churches of the duchy. Elsewhere, the episcopal authority, mostly in very limited form, is exercised by consistories, ministries of worship, superintendents-general, inspectors, &c.

In the Church of Scotland, and other Presbyterian churches on the Geneva model, the episcopal office is not recognised. Roman Catholic Scotland was divided into eleven dioceses or bishoprics.

In none of the Protestant countries have the prerogatives and revenues of bishops remained so little impaired as in England, where the reformation was taken into his own hands by the king, and being propagated from above downwards, was effected in a very conservative spirit. Episcopacy was abolished about the time of the Commonwealth, but at the restoration the bishops were restored, and have since retained their position in church and state.

The practice and history of the Church of England in the matter of bishops may be given somewhat more in detail. The B. is the head of the clergy in his diocese; he ordains them, whereby he calls them into existence as ecclesiastical persons; he institutes them to benefices, and licenses them to cures, and to preach; visits them, and superintends their morals; and enforces discipline, for which purpose he has several courts under him, and can suspend or deprive them for due cause.

Over the laity he exercises a general pastoral authority, but they are more particularly brought under his notice at the time of their confirmation. The style, title, and privileges of the B. are inferior to those of the archbishop (q. v.). He is said to be *installed* in his bishopric; he writes himself, By Divine Permission; and has the title of Lord, and Right Rev. Father in God; and he may retain six chaplains. A bishop must be at least 30 years of age; the reason for which is, that Christ began his ministry at that age. For many centuries after the Christian era, the B. received all the profits of his diocese, and paid salaries to such as officiated under

him. The mode of election, confirmation, and consecration is the same in the case of bishops and archbishops, for each archbishop is also B., and has his own diocese. The B. is elected by the chapter of his Cathedral church by virtue of licence from the crown. The laity used to take part in the election, but from the tumults that arose, the different sovereigns of Europe took the appointment, in some degree, into their own hands by reserving to themselves the right of confirming these elections, and of granting investiture to the temporalities which now began to be annexed to these dignities. This right was acknowledged in the Emperor Charlemagne by Pope Hadrian I., 773 A.D., and the Council of Lateran. The right of appointing to bishoprics is said to have been in the crown of England even in Saxon times. But when, by length of time, the custom of electing by the clergy only was fully established, the popes began to object to the usual method of granting these investitures, which was *per annulum et baculum*—i.e., by the prince delivering to the prelate a ring and pastoral staff or crosier. In the 11th c., Pope Gregory VII. published a bull of excommunication against all princes who should dare to confer investitures. There were long and eager contests occasioned by this papal claim, but at length the matter was compromised, the Emperor Henry V. agreeing to confer investiture for the future, *per sceptrum*; and the kings of France and England consented to receive only the homage for the temporalities, instead of investing them by the ring and crosier, the pope keeping in his hands the power of confirmation and consecration. This concession was obtained from Henry I.; but King John, in order to obtain the pope's protection against his barons, gave up, by a charter to all monasteries and cathedrals, the free right of electing their prelates. This grant was confirmed in Magna Charta, and was again confirmed by statute 25 Edward III. But by statute 25 Henry VIII. the ancient right of nomination was in effect restored to the crown. The sovereign, on the vacancy being notified, sends to the dean and chapter a letter missive, or *congé d'élire*, containing the name of the person to be elected; and if they do not elect in the manner appointed by the act, or if the archbishop or B. appointed for the purpose refuse to confirm, invest, and consecrate the B. elect, the recusants incur the penalty of a *præmunire* (q. v.). A bishop is not consecrated more than once, and he cannot be *deposed*, as it is supposed that the order itself cannot absolutely be taken from him; he may, however, be *deprived*, as was done to the B. of Clogher in 1822; he may also resign his see; and he may be removed from one see to another, which is called *translation*; but this practice is now less frequent than it used to be. The Dean and Chapter of Canterbury claim it as an ancient right of that church, that every B. of the province is to be consecrated in it, or the archbishop to receive from them a licence to consecrate elsewhere; and it is said that a long succession of licences to that purpose are regularly entered in the registry of that church. When elected and confirmed, a B. may exercise all spiritual jurisdiction, but he is not completely B. until consecration. Bishops, upon their election, become peers of the realm, and are summoned to the parliament as well as the other nobles; but the right under which they sit there, whether in respect of their baronies, or by usage and custom, is a matter of uncertainty. It appears, however, that the bishops sat in the Wittenagemote, under the Saxon monarchs, as spiritual persons; for they were not barons until William the Conqueror turned their possessions into baronies, and subjected them to the tenure of knights' service. The bishops created by

Henry VIII.—viz., Bristol, Gloucester, Chester, Oxford, and Peterborough, as also the lately created bishops of Ripon and Manchester—sit in parliament, though they do not hold their lands by baronial tenure. The bishops withdraw from the House (under protest, however) when any capital charge is to be decided. The bishops sit in parliament next to the Archbishop of York; first, London; second, Durham; third, Winchester; and then the rest according to their antinities. In respect of their persons, bishops are not peers with the nobility; and in cases of alleged crimes, they are tried by a jury in the same manner as commoners, as was the case with Cranmer and Fisher. When a see is vacant, the archbishop of the province is guardian of the spiritualities; but he cannot as such consecrate or ordain or present to vacant benefices. The sovereign has custody of the lay-revenues during a vacancy. Queen Elizabeth kept the see of Ely vacant nineteen years.

All the bishops of a province, with respect to their archbishop, are called his suffragans; but originally this term denoted the bishops who were consecrated to assist and help the other bishops, and to supply their places when absent. They were also called *chorepiscopi*, or bishops of the country.

The B. of Durham had formerly a *palatine* jurisdiction, as it was called, in the county of Durham; and the B. of Ely had a similar secular authority in certain places; but these powers were transferred to the crown in 1836. The houses of bishops are called their palaces. In old times their palaces in London were extra-diocesan; and while residing there, they exercised jurisdiction in the same manner as in their own dioceses. This personal privilege is now extinct in the bishops; but Lambeth House, Croydon, Winchester Place, and Ely House retain the privilege. A bishop makes a triennial visitation of his diocese.

The conferring of orders rests, in a great measure, with the discretion of the bishop. He can refuse to ordain without giving any reason, but he can ordain no person who does not subscribe to the Queen's supremacy, the Book of Common Prayer, and the Thirty-nine Articles. A candidate for orders must be first examined and approved; and the person to whom the right of performing this duty belongs, is by the Canon Law the archdeacon of the diocese. A B. may give letters dimissory to another B., licensing the latter to ordain a candidate. No person under 23 can be ordained deacon, and none can be ordained priest under 24 years of age. See ORDINATION.

In England, there are 28 bishops, including the two metropolitans—viz., Canterbury; York; London; Durham; Winchester; Bangor; Rochester; Exeter; Peterborough; St David's; Worcester; Chichester; Lichfield; Ely; Oxford; St Asaph; Manchester; Hereford; Chester; Llandaff; Lincoln; Salisbury; Bath and Wells; Carlisle; Gloucester and Bristol; Ripon; Norwich; Sodor and Man. Two of these, the B. of Sodor and Man, and the junior of the rest (provided he be not either of the archbishops, or London, Durham, or Winchester), have no seat in parliament.

In Ireland, there are twelve, including the two metropolitans, whose sees stand first—viz., Armagh and Clogher; Dublin and Kildare; Meath; Killaloe, Kilfenora, Clonfert and Kilmacduagh; Tuam, Killala, and Achoury; Ossory, Ferns, and Leighlin; Cashel, Emly, Waterford, and Lismore; Down, Connor, and Dromore; Derry and Raphoe; Limerick, Ardfer, and Aghadoc; Kilmore, Elphin, and Ardagh; Cork, Cloyne, and Ross.

In British North America, there are nine sees; in the West Indies, four; in South America, one; in

Africa, six; in Asia, six; in Australasia, twelve; and in Europe, one—that of Gibraltar. There is also a B. of the United Church of England and Ireland at Jerusalem. There are seven bishops of the Episcopal Church in Scotland (q. v.)—viz., of Edinburgh; Argyle and the Isles; Brechin, Glasgow, and Galloway; Moray and Ross; St Andrews and Aberdeen. In the United States, there are thirty-nine bishops of the Protestant Episcopal Church.

There are fourteen Roman Catholic bishops in England, four in Scotland, and four Roman Catholic archbishops in Ireland. The assumption of territorial titles by Roman Catholic bishops in England and Scotland is illegal, but they are, nevertheless, commonly ascribed to them by members of that communion. See Hooker's *Ecclesiastical Polity*, Burn's *Ecclesiastical Law*, Cripps's *Laws of the Church*, and Blackstone. See also ARCHBISHOP.

BISHOP, BOY. See BOY BISHOP.

BISHOP, a favourite beverage composed of red wine (claret, Burgundy, &c.) poured warm or cold upon ripe bitter oranges, sugared and spiced to taste, and drunk either hot or cold. The quality of the B. depends upon the excellence of the wine employed in its preparation. The oranges must be carefully selected, and the white part between the peel and pulp must be thrown away. If white wine be used, the beverage is called *cardinal*; and with Tokay it becomes *pope*. Taken in moderation, B. is a wholesome drink; but if partaken of too freely, the æthereal oil contained in the orange-peel is apt to occasion headache. The beverage was known under other names in Germany during the middle ages, having been imported into that country from France and Italy; its present name seems to have been bestowed during the 17th c.

BISHOP, SIR HENRY ROWLEY, an eminent English composer of music, was born in London in 1780. His principal musical instructor was Signor Francisco Bianchi, an opera composer settled in London. In 1806 B. was appointed composer of ballet music at the Opera. His most popular operatic entertainments were *Guy Mannering*; *The Slave*; *The Miller and his Men*; *Maid Marian*; *Native Land*; *The Virgin of the Sun*; &c.—all remarkable for their long flowing melodies, animated style, and true musical power. From 1810 to 1824, he was director of the music at Covent Garden Theatre. One of the first directors of the Philharmonic Society, he for many years conducted the concerts of Ancient Music. He arranged several volumes of the *National Melodies*, and succeeded Sir John Stevenson as arranger of the airs selected by Moore for his *Melodies*. In June 1839 he received the degree of Bachelor of Music from the university of Oxford, and in November 1841, was elected Reid Professor of Music in the university of Edinburgh. In 1842 he was knighted. In December 1843 he resigned his Edinburgh chair, and in February 1845 was elected professor of music in the university of Oxford. In his later years he was in very necessitous circumstances. He died April 30, 1855.

BISHOP'S CASTLE, a town in the south-west of Shropshire, 19 miles south-west of Shrewsbury. It is irregularly built on a hill slope. Pop. 1851, 1961. The bishops of Hereford had formerly a castle here, now destroyed. During the civil wars of the 17th c., the inhabitants took shelter in the church, which was demolished over their heads.

BISHOP'S STORTFORD, a town of Hertfordshire, on the Stort, 10 miles east-north-east of Hertford. It chiefly consists of two streets in the form of a cross. It carries on a trade in grain and malt, and has several tan-yards. B. S. was in Saxons times the property of the bishops of London. Pop. 5280.

BISHOP'S WALTHAM, a town of Hampshire, about 10 miles east-north-east of Southampton. Pop. of parish (1851), 2265. Corn, leather, and malt form the chief trade of the town. It has been immemorially the property of the see of Winchester. There are the remains of a bishop's castle, built in 1135 by Henry de Blois, King Stephen's brother, and which was reduced to ruins during the civil wars of the 17th c. A gang of 'Waltham Blacks,' or deer-stealers, infested the forest in this vicinity in the early part of the 18th c. The *Black Act* (q. v.) was passed in 1723, to put them down.

BISIGNA'NO, a town of Naples, in the province of Calabria Citra, is situated on a hill near the junction of the Mucone with the Crati, about 15 miles north of Cosenza. It has a cathedral, a castle, and a trade in silk, and gives the title of prince to the existing branch of the Sanseverino family. Pop. 5000.

BISLEY, a town of Gloucestershire, 11 miles south-east of Gloucester. Pop. of parish, 4801. The chief manufacture is coarse clothing. The church contains some interesting monuments, a cross-legged knight in armour, and an ancient stone font. There is also an ancient octagonal stone-cross in the churchyard. The canal uniting the Severn and the Thames passes through the parish, the highest part being 370 feet above the sea level.

BIS'MUTH is a brittle metal of a crystalline texture, and of a white colour tinged with a faint red hue. It is found native in Cornwall, Germany, France, and Sweden, where it occurs in veins or fissures passing through other rocks. The principal natural source is an impure metal; but it is likewise found in combination with oxygen, sulphur, and arsenic. The pure metal is generally obtained by heating the impure native B. in iron tubes in a furnace, when the metal volatilises, and the vapour, condensing into a liquid in a somewhat cool part of the tube, runs into a receiving-vessel, and is ultimately transferred to moulds, where it solidifies with a crystalline texture. B. is represented by the chemist by the symbol Bi; has the atomic weight or equivalent of 213, and has the specific gravity of 9783 to 9833 (water = 1000). The metal B. is seldom employed by itself in the arts. The

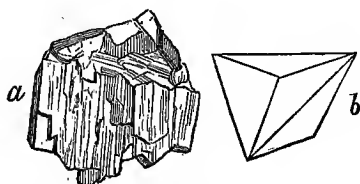

Bismuth :

a, example of native bismuth from Redruth, in Cornwall ;
b, crystal of bismuth.

alloys of B. are of considerable commercial importance. In combination with tin, B. forms an alloy possessing great sonorousness, and therefore suitable for bells. The alloy of 8 of B., 5 of lead, and 3 of tin, readily fuses at 202° F., and therefore melts in boiling water; and the alloy of 2 of B., 1 of lead, and 1 of tin, at 200·75° F. Either of the latter alloys is entitled to the term *fusible alloy*, and when mixed with some mercury, becomes still more fusible, and may then be used in forming moulds for toilet-soaps, and in taking casts.

B. forms several compounds of service in the arts and in medicine; it combines with oxygen to form

several oxides, of which the teroxide (BiO_3) is the most important. It may be prepared by evaporating the solution of the ternitrate of B. ($\text{BiO}_3 \cdot 3\text{NO}_5$) to dryness, and then heating, when the nitric acid (3NO_5) escapes, and leaves the teroxide of B. (BiO_3) as a yellowish powder. It is employed in the porcelain manufacture as an agent for fixing the gilding, and for increasing the fusibility of fluxes, at the same time neutralising the colours which are often communicated by them. The ternitrate of B. is prepared by acting upon the metal B. with a mixture of one part of commercial nitric acid and one part of water, and applying heat. The subnitrate or basic nitrate of B. receives the names of *Pearl White*, *Pearl Powder*, *Blanc de Fard*, *Blanc d'Espagne*, *Majestery of B.*, and *Perlweiss* and *Schminkweiss* (German). It is used as a cosmetic, but is apt to become gray in tint, and even brown or black, when sulphuretted hydrogen, often evolved from sewers, cesspools, and drains, comes in contact with it.

The subnitrate of B., the only medicinal preparation formed from this metal, acts as a local irritant and caustic poison on animals. On man, when given in small doses, it acts locally as an astringent, diminishing secretion. On account of the frequent relief given by it in painful affections of the stomach, where there is no organic disease, but where sickness and vomiting take place, accompanied by cramp or nervous disorder, it is supposed to act on the nerves of this viscus as a sedative. It has also been denominated tonic and antispasmodic. Vogt says, that when used as a cosmetic, it has been known to produce a spasmodic trembling of the face, ending in paralysis.

BISON, a name given by the ancients to an animal of the same genus with the ox (q. v.), still called the B., or the European B. (*Bos Bison* of some naturalists, *Bos Urus* of others); also known as the Aurochs (Germ., wild animal, or wild ox). This animal at one time abounded in most parts of Europe, but is now found only in the forests of Moldavia, Wallachia, Lithuania, and Caucasus. Herds of bisons, carefully protected by the emperor of Russia, and believed to amount to about 800 in all, roam through the great forest of Bialowicza, in Lithuania. The B. differs from all varieties of the common ox, in the arched line of the back, which rises in a sudden elevation behind the neck; the hump which is formed not consisting, however, of mere fat, but in great part of the very thick and strong muscles which support the large head. It is remarkable for strength in the fore-parts, and trees of five or six inches in diameter cannot withstand the thrusts of old bulls. It is capable of repelling all the attacks of the wolf or bear, rushing upon, overthrowing, and then trampling an adversary. Its horns are short, tapering, very distant, spreading, a little curved inwards at the point. They are affixed not at the extremities of the most elevated salient line of the head, as in the ox, but considerably in front of it. The figure of the forehead differs also from that of the ox in its greater breadth, and in its convex profile. Another important anatomical difference is in the number of ribs, of which the B. has fourteen pair, whilst the ox has only thirteen; and the vertebrae of the tail are fewer, being only nineteen instead of twenty-one. The hair of the forehead is long and shaggy; that under the chin and on the breast forms a sort of beard; and in winter the neck, hump, and shoulders are covered with long woolly hair, of a dusky brown colour, intermingled with a short, soft, fawn-coloured fur. This long hair is gradually cast in summer. The legs, back, and hinder-parts are covered with short dark-brown hair. The tail

terminates in a large tuft. The females are not so large as the males, nor do they exhibit the same shagginess of the fore-parts. The B. is the largest quadruped now existing in Europe, although within the historic period there appears to have existed along with it an ox exceeding it in size; and it appears to have been this ox, and not the B., which was called *Urus* (q. v.) by the ancients, although their *Bomasus* (or *Bonassus*) was probably the same with the bison.—The food of the B. consists of grass and brushwood, and the leaves and bark of young trees. Its cry is peculiar, 'resembling a groan or a grunt, more than the lowing of an ox.' It does not attain its full stature till after its sixth year, and lives for about thirty or forty years. The period of gestation appears to be the same with that of the ox. The B. has never been reduced to subjection by man, and the domestication even of individuals taken young, has been very partial. It generally shews a great aversion to the domestic ox. The common statement, however, that the B. calf invariably refuses to be suckled by the domestic cow, is contradicted on the excellent authority of the master of the imperial forests in the Russian government of Grodno.—The B. is generally very shy, and can only be approached from the leeward, its smell being very acute. It is easily provoked, and is not approached without danger. It runs very swiftly, although it cannot long continue its flight, galloping with its head very low, so that the hoofs are raised higher than the head.

There is no historical evidence that the B. ever existed in Britain; but remains of this, or of a very closely allied species, are found in pliocene fresh-water beds in several parts of England, as well as on the continent of Europe. The size of these B. bones is, however, so great as of itself to cause a doubt of the identity of the species, and the horns are longer in proportion. The fossil B. has been called *Bison prisicus*; *Bison* being by some naturalists separated as a genus from *Bos*, upon the ground chiefly of the osteological differences in the head.

The American B. (*Bos Americanus* of some naturalists, *B. Bison* of others) is interesting as the only species of the ox family indigenous to America, except the Musk Ox (q. v.) of the subarctic regions. It is commonly called *Buffalo* by the Anglo-Americans, although it is very different from the Buffaloes (q. v.) of the old world. It is found in vast numbers in the great prairies between the Mississippi and the Rocky Mountains; it occurs as far north as the vicinity of Great Marten Lake, in lat. 63° or 64°; extensive level and marshy tracts there affording it suitable food, although it is nowhere else to be met with in so high a latitude. Its southern limit appears to be in New Mexico. It is comparatively rare to the west of the Rocky Mountains, and appears to have been rare to the east of the Appalachians, even on the first settlement of Europeans. Within the present century, however, it was found in the western parts of the State of New York, and in large numbers in that of Ohio; but it has now disappeared from the whole region east of the Mississippi, and it is necessary to advance about one hundred miles to the westward of that river before considerable numbers are anywhere to be found. In the western prairies, enormous herds still congregate; great plains are sometimes spotted and darkened with them as far as the eye can reach; 'countless thousands' are described as coming to refresh themselves in stagnant pools; and their paths are said to be, in some parts of the wilderness, as frequent and almost as conspicuous as the roads in the most populous parts of the United States.

About 300,000 Indians are supposed to subsist almost entirely on the flesh of the B. The spear and the bow and arrow are still much employed by them in hunting it, although many of them also use firearms. They frequently pursue it on horseback; but the hunter, whether on horseback or on foot, has often much difficulty in getting within shot, upon account of its keenness of scent, and the speed with which it runs. The chase of the B. is also very dangerous, as it is apt to turn upon an adversary, and even a fleet horse cannot always escape it. Great numbers, however, are sometimes killed when the hunters can succeed in throwing the herds that are scattered over the plains into confusion, so that they run wildly, without heeding whither. Another expedient of the Indians is to set fire to the grass of the prairies around them, when they retire in great consternation to the centre, and are easily killed. A sort of pound or enclosure is sometimes made, with a long avenue leading to it, and an embankment of snow, such that when the animals have descended over it they cannot return, and by this means great numbers are often captured and killed. Livingstone describes a similar expedient as in use for killing wild animals in South Africa. Sometimes, also, the Indians contrive to throw them into consternation, and to make them run towards a precipice, over which many of the foremost are driven by the crowds which throng up behind.

The American B. is very similar to the European. In general, it is of rather smaller size, but this does not appear to be always the case, and it is said sometimes to attain a weight of 2000 lbs. Its limbs and tail are shorter, and the tail consists of fewer vertebrae. The horns are shorter and more blunt. The fore-parts are still more shaggy, and retain more of their shagginess in summer. The ground upon which many naturalists have rested their chief confidence of specific difference has been, however, the presence of an additional pair of ribs, the

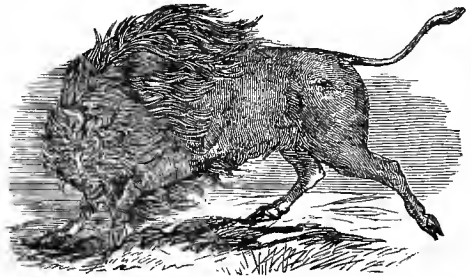

American Bison.

American B. being said to have fifteen pair; but Mr Vasey has recently ascertained that, like the European B., it has only fourteen. The more gregarious habit may perhaps be accounted for, like that of the American beaver, by difference of circumstances.

The wolf is quite unable to contend with the B., but many wolves often hang around the herds, to devour calves which may stray, or aged animals which have become too weak to keep up with the rest. These have sometimes been seen assailed by whole packs of wolves, and dealing death to many of their assailants, before they were compelled to yield to numbers and hungry pertinacity. The only American animal that is singly capable of overcoming the B. is the grisly bear. See BEAR.

The flesh of the B. is very good, and differs from

that of the ox in having a sort of venison flavour. The hump, in particular, is esteemed a delicacy.—*Pemmican* (q. v.), so much the food of fur-hunters and northern *voyageurs*, is made of the flesh and fat of the bison.—The tallow forms an important article of trade. One bull sometimes yields 150 lbs. The skins are much used by the Indians for blankets, and when tanned, as coverings for their lodges and beds. A blanket of B.'s skin is not unfrequently sold for three or four pounds sterling in Canada, to be used as a travelling cloak or wrapper. The Mandan Indians make canoes of B. skins spread upon wicker-work frames. These canoes have the round form of the Welsh *coracle* (q. v.). The long hair or fleece is spun and woven into cloth; and some of it which has been brought to England has been made into very fine cloth: stockings, gloves, &c., are also knitted of it. A male B. yields from six to eight pounds of this long hair.

The few attempts which have been made to domesticate the American B., have been so far successful, that they afford encouragement to further experiments. The size and strength of the animal make it probable that, if domesticated, it would be of great use.

BISSA'GOS or BIJU'GA ISLANDS, a group of small volcanic islands, about 20 in all, off the west coast of Africa, in lat. 10° 2'—11° 42' N., and long. 15°—17° W., opposite the mouth of the Rio Grande. The islands are enclosed by a reef, and, with a few exceptions, are thickly wooded. Many of them appear to be densely peopled by a savage, thievish, negro race, who cultivate maize, bananas, and palms, and feed cattle and goats, which constitute their chief wealth. There are several fine ports. On one of the islands, Bulama, the British formed a settlement in 1792, but were obliged to abandon it the following year, on account of its unhealthiness. Bissao, one of the group, on which there is a Portuguese settlement, has a population of 8000. It carries on a large trade in slaves, nearly all its European inhabitants being engaged in the traffic. It has also a trade in rice, wax, hides, &c., and imports annually about £20,000 worth of British manufactured goods.

BISSÉN, WILHEM, a distinguished Danish sculptor of the present time, was born near Schleswig in 1798, and studied his art for ten years in Rome, under the guidance of his countryman, Thorwaldsen. Returning home, he executed a number of excellent works (a bust of Oersted, Atalante hunting, &c.). In 1841, he returned to Rome, being commissioned by the government to make 18 statues larger than life. Along with these he produced a Venus, and a charming piece, 'Cupid sharpening his Arrow.' Being recalled to Copenhagen, he was commissioned to execute a frieze of several hundred feet long for the great hall of the palace, representing the development of the human race according to the Greek mythology. Thorwaldsen, in his will, appointed B. to complete his unfinished works and have charge of his museum. In 1850 he was made director of the Academy of Arts, Copenhagen. At the Paris Exhibition in 1855, he was the only sculptor who represented Danish art.

B'ISTORT (*Polygonum Bistorta*), a perennial plant, 1—1½ ft. high, with a simple stem, ovate subcordate and wavy leaves, the radical leaves tapering into a long footstalk, and one dense terminal cylindrical spiked raceme of flesh-coloured flowers. The root is about the thickness of the little-finger, blackish brown externally, reddish within, and tortuous (whence the name bistort). The whole plant is astringent, containing much tannin; the root is one of the strongest vegetable astringents, and is

much employed in medicine, both internally and externally, in hemorrhages and many other complaints. B. is a native of meadows in Europe, and

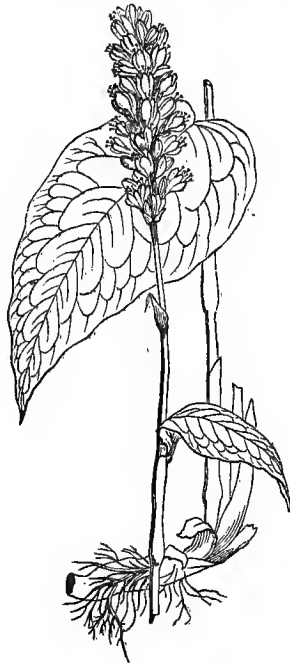

Bistort (*Polygonum Bistorta*).

is found in Britain, but is by no means common. See POLYGONUM.

B'ISTRE, or B'ISTER, is a pigment of a warm brown colour, prepared from the soot of wood, especially beech. It is used in water-colours after the manner of Indian ink.

B'ISTRITZ, a fortified town of Transylvania, beautifully situated on the Bistriz River, in a fine valley about 50 miles north-east of Klausenburg. In its vicinity are the remains of an ancient castle, once the residence of the illustrious Hunyads. It has several large cattle-fairs, but the extensive general trade it once carried on is now entirely gone. Forming, as it does, the last strong position in the north-east of Transylvania, it was repeatedly during 1848—1849 the scene of hot strife between the Hungarian and Austrian generals. Pop. 6500.—B. is also the name of a river which, rising in East Hungary, flows south-east through Bukowina and Moldavia, and joins the Sereth near Baku, after a course of 110 miles, and is called the Golden B., on account of the auriferous character of its sands.

B'IT, or B'ITT, in ship-building, is a frame composed chiefly of two short but strong vertical timbers, fixed into or upon the deck in the fore-part of the vessel. Its main purpose is for fastening the cable when the ship rides at anchor, and for 'leading' the principal ropes of the rigging. To 'bit the cable,' is to fasten it round the bit. Various kinds are called 'riding-bits,' 'Elliot's bits,' 'Carrick-bits,' 'paul-bits,' 'jeer-bits,' 'topsail-sheet-bits,' &c. Having to resist great strains, the bits are strongly bolted to the beams that support the deck.

B'ITCHE, a town of France, in the department of the Moselle, in a wild and wooded pass of

the Vosges, about 16 miles east-south-east of Sarreguemines. Its citadel, which is built on a precipitous and isolated rock, in the middle of the town, is well supplied with water, defended by 80 cannons, has accommodation for a garrison of 1000 men, and is considered all but impregnable. The Prussians under the Duke of Brunswick attempted to surprise it in 1793, but failed. Pop. of town, 2456, who are engaged in the manufacture of paper, glass, and porcelain.

BITHOOR, a town in India in the district of Cawnpore and sub-presidency of North-west Provinces, stands on the right bank of the Ganges, about 12 miles to the north-west of Cawnpore itself. B., particularly devoted to the worship of Brahma, has numerous pagodas. It is, of course, a favourite resort for pilgrims, who here, as at Benares and Bindraban, have access to the sacred stream for purposes of ablution, by means of elaborately constructed ghauts. During the mutiny of 1857, B. acquired an unenviable notoriety as the stronghold of Nena Sahib. Here also Havelock more than once exacted retribution, however inadequate, defeating the Nena in the field, and burning his fort. B. is said to contain 8217 inhabitants.

BITHYNIA, an ancient division of Asia Minor, was separated from Europe by the Propontis (Sea of Marmora) and the Thracian Bosphorus (Strait of Constantinople), and was bounded N. by the Euxine, and S. by Galatia, Phrygia, and Mysia. Its eastern limits were not very clearly defined, but they at least extended as far as Paphlagonia. It contained the famous Greek cities or colonies of Chalcedon, Heraclea, &c.; and at later periods, Nicomedia, Nicæa, and Prusa, were flourishing cities of Bithynia. The inhabitants of B. were supposed to be of Thracian origin. The country was subdued (560 B.C.) by Croesus of Lydia, and five years later, fell under the Persian dominion. But about 440 or 430 B.C., it became an independent kingdom under a dynasty of native princes, who made Nicomedia their capital. The last king, Nicomedes III., made the Romans his heirs, and with a large addition from the Pontic kingdom, B. became a province of the empire (74 B.C.). Under Trajan, B. was governed by Pliny the Younger, whose letters to the emperor on the administration and condition of the province contain the well-known passage respecting the Christians. The Emperor Diocletian made Nicomedia his habitual residence. In 1298, Osman the Turk broke into the country; and in 1328, Prusa, or Brusa, then the chief town of B., became the capital of the kingdom of the Osmanli.

BITLIS, a town of Asiatic Turkey, in the pashalic of West Van, in lat. 38° 24' N., and long. 42° 5' E., about 120 miles south-east from Erzurum. It is situated at an elevation of 5156 feet above the level of the sea, in a deep ravine traversed by the river Bitlis, one of the head streams of the Tigris. B. is a straggling, irregular place, covering a large surface of ground, and surrounded by bare limestone mountains, rising to a height of about 2000 feet above the valley, which is filled with orchards and gardens, and watered by numerous streams and springs. It has 3 mosques, about 12 convents belonging to the howling dervishes, who appear to have made B. their head-quarters, several well-stocked bazaars, and extensive manufactures of cotton cloths, which are celebrated for their bright red dye. It has also a very extensive trade. The import of British goods is small. The population consists of about 2000 Mohammedan, and 1000 Armenian families. The Persians defeated Solyman the Magnificent near B. in 1554.

BITO'NTO (ancient *Butuntum*), a town of Naples, in the province of Bari, and 10 miles west-south-west of the city of Bari. It is situated in a fruitful plain about 5 miles from the sea, is well built, is conjointly with Ruvo, the see of a bishop, and has a fine cathedral, monasteries, and a nunnery. Pop. 16,000, who carry on an extensive trade in a wine called *Zagarello*, which is largely cultivated in the environs. B. is the birthplace of Giordani, the mathematician. In its vicinity, the Spaniards, under Count de Montemar, gained a splendid victory over the Austrians on the 25th of May 1734, the result of which was that Spain re-obtained possession of the kingdom of Naples.

BITTER CRESS. See **CRESS.**

BITTER KING (*Soulaurea amara*), a shrub or small tree of the natural order *Polygalaceæ* (q. v.), a native of the Indian Archipelago, which has received its name from its intense bitterness. The genus differs from the usual structure of the order in its regular flowers. The B. K. has large oval leaves and axillary racemes of flowers. It is used medicinally in fevers and other diseases.

BITTER SPAR, a name given to Dolomite (q. v.), from the magnesia contained in it, which the Germans call *Bitter Salt*.

BITTER VETCH. See **OROBUS.**

BITTERN (*Botaurus*), according to some modern ornithologists, a genus of the Heron (q. v.) family (*Ardeideæ*); but regarded by others as a mere sub-genus of Heron (*Ardea*), and not a very well defined one. Bitterns are indeed chiefly distinguished from herons by the long, loose plumage of the neck, which they have the power of erecting at pleasure, along with the rest of their clothing feathers, so as greatly to increase their apparent size. The back of the neck, however, is merely downy, or almost bare, the long feathers being on the front and sides. Bitterns also differ from herons in the greater length of their toes, the middle toe being as long as the shank. They are almost all solitary birds, inhabiting reedy and marshy places, where they lie hid during the day, and will almost allow themselves to be trodden upon ere they take wing; they feed during the night, and then, also, often rise spirally to a great height into the air, and emit loud resounding cries. Their food consists chiefly of frogs, and partly, also, of fish, lizards, water-insects, &c., and even of small birds and quadrupeds. The claw of the middle toe is serrated on the inner edge, probably to aid in securing slippery prey.—The COMMON B. (*B. stellaris*, or *Ardea stellaris*) is a bird very widely diffused over the old world, being found in almost all, at least of the temperate, parts of Europe, Asia, and Africa, which are sufficiently marshy for its manner of life. It is now rare in Britain, owing to drainage; but was formerly more common, and in the days of falconry, was carefully protected by law in England, on account of the sport which it afforded. Its flesh also was in high esteem, and is not rank and fishy, like that of the herons generally. In size, it is rather less than the common heron; the bill is about four inches long, the feathers on the crown of the head are greenish black, and the plumage in general of a dull yellow colour, beautifully and irregularly marked and mottled with black. The B. makes a rude nest of sticks, reeds, &c., in its marshy haunts, and lays four or five greenish-brown eggs. It has a peculiar bellowing cry, which has obtained for it such English provincial names as Mire-drum, Bull of the Bog, &c., and many of its appellations in other languages, perhaps even its name B. (*Bitour*, *Botur*, *Botaurus*). Some naturalists used to assert that the booming cry of the B. was produced by the bird inserting its bill into a

BITTERN—BITTERSWEET.

reed; that notion, however, has long since been exploded. When assailed, it fights desperately with bill and claws; and it is dangerous to approach it incautiously when wounded, as it strikes with

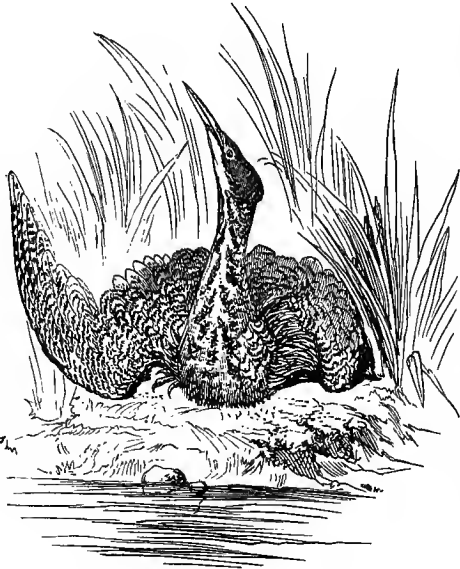

Common Bittern (*Botaurus stellaris*).

its long sharp bill, if possible, at the eye.—The LITTLE B. (*B. minutus*, or *Ardea minuta*) is common in some parts of Europe, but rare in Britain. Its whole length is only about thirteen inches.—The AMERICAN B. (*B. lentiginosus*, or *A. lentiginosa*), a species almost equal in size to the common B., and very similar to it in habits and voice, has occasionally been shot in Britain. It is common in many parts of North America, migrating northward and southward, according to the season. The crown of the head is reddish brown, and the colours and markings of the plumage differ considerably from those of the common B.—The LEAST B. (*B.* or *A. exilis*) is another North American species, of very small size, which is also migratory, and somewhat social in its habits. The AUSTRALIAN B. (*B.* or *A. australis*) is generally diffused throughout Australia, wherever marshes or sedgy rivers occur. In habits it closely resembles the B. of Europe. The head and upper parts generally are purplish brown, except the wings, which are buff, conspicuously freckled with brown; the throat, breast, and belly mottled brown and buff.

BITTERN, BITTER LIQUID, or SALT OIL, is an oily liquid obtained during the preparation of common salt (q. v.). When the mother-liquor of the evaporating pans ceases to deposit crystals of common salt, there is left behind in the boilers the material called bittern. It consists principally of a strong solution of common salt, along with Epsom salts, and other compounds of magnesia.

The B. at our salt-works is generally run into tanks, and during winter, it is employed as a source of Epsom salts. The B. is treated with a little sulphuric acid, which converts the chloride of magnesia ($MgCl$) into sulphate of magnesia ($MgOSO_3$), and on the liquid being allowed to cool, the crystals of Epsom salts (or sulphate of magnesia) separate.

BITTERS are prepared from an infusion of herbs containing bitter principles. The plant generally used for the purpose is *Archangelica officinalis*, or the *Garden Angelica*. See ANGELICA. The roots or seeds, or both, are placed in water, and the whole is left to simmer for several days, when the infusion will be strong enough. The B. from Angelica are not much used by physicians, having been superseded very much by infusions of gentian, &c.; but they are still used as a household medicine in town and country by elderly people. The chemical composition of the root is:

Bitter extractive,	27·06
Volatile oil,	0·70
Acrid soft resin,	6·02
Gum and common salt,	31·75
Starch,	5·40
Woody fibre,	8·60
Albumen,	0·97
Water and loss,	19·50
	100·00

The medicinal properties of B. are mainly those of a mild tonic and pungent aromatic stimulant, and hence they are serviceable as a stomachic in cases of weakness of the digestive organs. The taste is at first sweetish, rapidly becoming hot, aromatic, and bitter, and the odour is rather pleasant. The Angelica root yields a larger amount of the bitter principle than Angelica seeds. Camomile flowers, coriander-seeds, and other vegetable tonics and stimulants, are occasionally employed in the preparation of bitters.

BITTERSWEET, or WOODY NIGHTSHADE (*Solanum Dulcamara*), a plant found in hedges and thickets in Britain, and in most parts of Europe, also in Asia and in North America. The root is perennial; the annual stems climbing and shrubby,



Bittersweet (*Solanum Dulcamara*): a, branchlet with flowers and fruit, reduced; b, a flower, reduced.

many feet in length; the leaves ovate-heart-shaped, the upper ones spear-shaped; the flowers purple, in drooping corymbs, much resembling those of its congener, the potato, but much smaller, followed by ovate red berries of tempting appearance, which, being poisonous, are not unfrequently the cause of serious accidents, particularly to children. The

twigs, collected in autumn after the leaves are fallen, are used in medicine as a diaphoretic and diuretic, and as a remedy for leprosy and other cutaneous disorders. See SOLANUM.

BITTERWOOD, a name given to certain species of the genus *Xylopa*, trees and shrubs remarkable for the bitterness of their wood, particularly the West Indian *X. glabra*. Furniture made of this wood is safe from the attacks of insects.—The genus *Xylopa* belongs to the natural order *Anonaceæ* (q. v.). The fruit of some of the species, particularly *X. sericea*, is highly aromatic and pungent like pepper. *X. sericea* is a large tree, a native of Brazil; its bark is used for making cordage, which is excellent.

B. is also the name of *Pterocarya excelsa* (formerly *Quassia excelsa*), a tree of the natural order *Simarubaceæ* (q. v.), a native of Jamaica, the wood of which is used in medicine for the same purposes as *Quassia* (q. v.), and often under that name; indeed, it is probable that all the present quassia of the shops is really this wood. It is, botanically, very nearly allied to the true quassia, and possesses very similar properties, containing the crystallisable bitter principle called Quassite or Quassin. The wood, which is intensely bitter, is a very useful stomachic and tonic; an infusion of it is a well-known and useful fly-poison; and it appears to act as a powerful narcotic on many quadrupeds.

BITUMEN, a mineral substance, remarkable for its inflammability and its strong peculiar odour; generally, however, supposed to be of vegetable origin. The name, which was in use among the ancient Romans, is variously employed, sometimes to include a number of the substances called *Mineral Resins* (see RESINS, MINERAL), particularly the liquid mineral substances called *Naphtha* (q. v.) and *Petroleum* (q. v.) or Mineral Oil, and the solid ones called *Mineral Pitch*, *Asphalt* (q. v.), *Mineral Caoutchouc*, &c.—sometimes in a more restricted sense it is applied by mineralogists only to some of these, and by some mineralogists to the solid, by others to the liquid ones. All these substances are, however, closely allied to each other. Naphtha and petroleum consist essentially of carbon and hydrogen alone, 84—88 per cent. being carbon; the others contain also a little oxygen, which is particularly the case in asphalt, the degree of their solidity appearing to depend upon the proportion of oxygen which they contain, which amounts in some specimens of asphalt to 10 per cent. Asphalt also contains a little nitrogen. Bituminous substances are generally found in connection with carboniferous rocks, in districts where there is, or evidently has been, volcanic agency. See the articles already referred to. Indeed, most kinds of coal contain B., and a substance essentially the same is produced from all kinds of coal by distillation; and whether before existing actually formed in the coal, or produced at the time by the action of heat, B. may often be seen bubbling from pieces of coal after they have begun to burn on an ordinary fire. Some of the shales of the coal-measures are very bituminous, as is also a kind of marl-slate abundant in some parts of the continent of Europe. See SHALE and MARL.—One of the most interesting of the bituminous minerals is that called *Mineral Caoutchouc* or *Elastic B.*, and for which the new name of *Elasterite* has been devised, as if to support the dignity of its exaltation to the rank of a distinct mineral species. It is a very rare mineral, only three localities being known for it in the world—the Odin lead-mine in Derbyshire; a coal-mine at Montrelais, near Angers, in France; and a coal-mine near South Bury, in Massachusetts. It is elastic and flexible like caoutchouc, and may be used, like it, for effacing pencil-marks. It is easily cut with a

knife. Its colour is blackish, reddish, or yellowish-brown; and its specific gravity is sometimes a little less, and sometimes a little more than that of water. It has a strong bituminous odour, and burns with a sooty flame.

BITUMINOUS COAL is a term applied to the varieties of coal which contain a large percentage of volatile matter. They yield, on their destructive distillation, a considerable quantity of gas, remarkably pure, and with good illuminating qualities, and are consequently largely used for that purpose. See COAL.

BITUMINOUS LIMESTONES are limestones impregnated and sometimes deeply coloured with bituminous matter, obtained from decaying vegetables, or, more probably, from the decomposed remains of those animals, the hard parts of which form so large an amount of the rock.

BITUMINOUS SHALES are indurated beds of clay occurring in the coal-measures, and containing such an amount of carbon and volatile matter that they are able to keep up combustion when mixed with but a little coal. They are indeed impure coal, with a large percentage of ash or earthy matter, which after burning retains the original form. See COAL.

BITZIUS, ALBERT, better known under the *nom de plume* of Jeremias Gotthelf, a Swiss author, was born at Morat, in the canton of Freiburg, 4th October 1797. He was educated for the church; and after holding several cures, was appointed, in 1832, pastor of Lützelfüh, in Emmenthal, canton of Bern, which office he retained till his death. His first work was entitled *The Mirror of Peasants* (Burgsdorf, 1836). It is the touching history of a poor villager, Jeremias Gotthelf, which pseudonym B. ever after retained. In 1838 appeared his *Sorrows and Joys of a Schoolmaster*; in 1839, *Dursli, the Brandy-drinker*, and *How Five Maidens miserably perish in Brandy*; in 1842—1846, *Scenes and Traditions of the Swiss*, in six vols., in which B. narrates, with great art, the old national legends, among which the most remarkable is the *Reconciliation*. The best and most popular of his stories, however, are *Grandmother Katy* (Berlin, 1848); *Uli, the Farm-servant* (Berlin, 2d edition, 1850); its continuation, *Uli, the Farmer* (2d edition, Berlin, 1850); and *Stories and Pictures of Popular Life in Switzerland* (Berlin, 1851). Subsequently, he wrote several pamphlets against the German democrats, without, however, violating those popular sympathies and liberal convictions which pervade his writings, and which at an earlier period led him vehemently to oppose the family government of the Bernese aristocracy. His last work was *The Clergyman's Wife*, which appeared in 1854. Its author died on the 22d October of the same year. B.'s writings are greatly relished in Switzerland. They are characterised by simplicity, inventiveness, a wonderful fidelity in the delineation of manners and habits, great vigour of description, and raciness of humour, while their tone is strictly moral and Christian.

BIVALVE SHELLS, or **BIVALVES**, are those testaceous coverings of mollusks which consist of two concave plates or *valves*, united by a hinge. So long as molluscous animals, provided with shells, were considered by naturalists almost exclusively with respect to these, the order of B. S., originally established by Aristotle, retained its place (see CONCHOLOGY); and indeed the external character upon which it is founded is closely connected with some of the important structural characters according to which mollusks are now classified. See MOLLUSCA. A vast majority of recent B. S. belong to Cuvier's *Testaceous* order of *Acephalous Mollusca*, the *Lamel-*

libranchiate (q. v.) *Mollusca* of Owen, although with them are classed some which were placed among *Multivalves* (q. v.) by conchologists, on account of accessory valves which they possess, and some which have a calcareous tube superadded to the true valves, or even taking their place as the chief covering of the animal. There are also mollusks of the class *Brachiopoda* (q. v.), or *Pallibranchiata*, which possess B. S., as the *Terebratulæ*, or Lamp-shells (q. v.), &c. The structure of the shell, however, when closely examined, is found to be different in these two classes (see SHELL), although its general appearance is much the same. A very large proportion of the B. S. of the older fossiliferous rocks belong to the class *Brachiopoda*.

In the *Brachiopoda*, one valve is ventral, and the other dorsal; in the *Lamellibranchiata*, the one is applied to the right side, and the other to the left side of the animal. The valves of ordinary B. S. consist of layers, of which the outermost is always the smallest; and each inner one extends a little beyond it, so that the shell becomes thicker and stronger as it increases in length and breadth. The valves are connected at the hinge by an elastic ligament; and in general this consists of two parts, more or less distinct—one on the outside, to which the name *ligament* is sometimes restricted, and which is stretched by the closing of the valves; another, sometimes called the *spring*, more internal, which is compressed by the closing of the valves, and tends to open them when the compressing force of the *adductor* muscle or muscles is removed, the effect of which is to be seen in the gaping of the shell when the animal is dead. The hinge is often furnished with teeth which lock into each other; sometimes it is quite destitute of them; sometimes the hinge-line is curved, sometimes straight. Conchological classification has been much founded upon characters taken from this part. The valves of some B. S. are equal and symmetrical, in others they

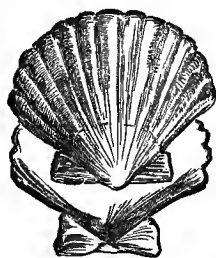

Pecten.
A bivalve shell.

are different from one another, particularly in those mollusks which, like the oyster, attach themselves permanently by one valve to some fixed substance, as a rock. Sometimes the valves of B. S. close completely at the pleasure of the animal; those of others always gape somewhere.

The point at the hinge, from which the formation of each valve has proceeded, is called the *umbo*. On the side of the *umbo* opposite to the ligament there is usually a small depression called the *humble*. The marks, familiar to every one, upon the inside of a bivalve shell, are the impressions of the *mantle* of the (*lamellibranchiate*) mollusk, and of the *adductor* muscle or muscles.

BIVOUAC (from the German *beiwacht*, or *beiwachen*, to watch over) is the encampment of soldiers in the open air, without tents, where every one remains dressed, and with his weapons by him. Even during the Seven Years' War it was no uncommon thing for the whole army, when in the vicinity of the enemy, to pass the night in their ranks, each lying down in his place, in order to be ready to stand to their arms at a moment's notice. But the French revolutionary armies introduced the practice of dispensing with tents altogether, and regularly passing the night *en bivouac*. Hence in a great measure that rapidity in their motions which long made them uniformly successful; and the practice

was afterwards imitated by the other armies of Europe, though less by the English. Soldiers in B. light fires, and improvise, where it is possible, huts of straw, branches, &c. But this mode of encampment, though favourable to celerity of movement, is purchased at the expense of the soldiers' health, besides being destructive of discipline, by leading to plundering and destroying of houses, fruit-trees, &c., in the vicinity. Accordingly, the tent is again coming into use, and for permanent encampments, regularly constructed wooden huts have been introduced. There are still, however, many cases where the B. is the only resource.

BIXA. See **ARNOTTO**.

BIZERTA, or **BENZE'RTA** (ancient *Hippo Diarrhytus*, or *Zaritus*), a seaport town of Tunis, at the bottom of a deep gulf or bay of the Mediterranean, and at the mouth of a lagoon, united to the gulf by a narrow channel. It is the most northerly town in Africa, being about 38 miles north-west of Tunis, in lat. 37° 17' N., and long. 9° 51' E. It is surrounded by walls, and defended by two castles; which, however, as they are commanded by the neighbouring heights, are quite useless against a land-attack. Its port, formerly one of the best in the Mediterranean, has been suffered to fill up, until now only small vessels can be admitted, though very little labour is required to give a uniform depth of 5 or 6 fathoms to the channel leading to the inner harbour or lagoon, which has a depth varying from 10 to 50 fathoms, and is extensive enough to afford accommodation to the largest navies. The adjacent country is remarkably fertile, but its cultivation is neglected. Pop. variously estimated at from 8000 to 14,000. Agathocles, between the years 310 and 307 B.C., fortified and provided B. with a new harbour; and under the Romans, it was a free city.

BIZIU'RA. See **MUSK DUCK**.

BJÖRNSTJERNA, **MAGNUS FRIEDRICH FERDINAND**, Count, a Swedish statesman and author, was born 10th October 1779 at Dresden, where his father then resided as secretary to the Swedish legation. He received his education in Germany, and entered Sweden for the first time in 1793 to join the army. In 1813 he was appointed lieutenant in the Swedish army that went to aid the allies in Germany; took part in the conflicts at Grossbeeren and Dennewitz; was present at Leipsic, and concluded the formalities of capitulation with the French at Lübeck and Maestricht. Subsequently, he fought in Holstein, and in Norway, where he concluded the treaty that united that country with Sweden. In 1826, he received the title of count; and in 1828 was appointed ambassador to the court of Great Britain, which office he held till 1846, when he returned to Stockholm, where he died, 6th October 1847. As a politician, B.'s opinions were liberal. In addition to some political writings, he published a work on the Theogony, Philosophy, and Cosmogony of the Hindus in 1843.

BLACK may be considered as the negation of colour, resulting from the absorption of the rays of light by certain substances. Painters produce it by an unequal combination of the three primary colours. In mediæval art, B. was symbolical of evil, error, and woe; thus we find Christ, when the old illuminators wished to represent him as wrestling against the Spirit of Evil, arrayed in black drapery; and Byzantine painters, to express the sorrow of the Virgin Mary, gave her a black complexion. 'All faces shall gather blackness,' is the expression of Joel, when he wishes to convey the idea of the trouble of the people when the calamities which, with prophetic eye, he sees brooding over Jerusalem, should come to pass. B. clothing

among some oriental nations was regarded as a badge of servitude, slavery, or low birth; among the Moors, it has several significations—obscurity, grief, despair, constancy. B. in blazonry, under the name of sable, denotes constancy, wisdom, and prudence. For B. as a funereal colour, see FUNERALS, and MOURNING.

BLACK PIGMENTS, used in painting, are derived principally from animal and vegetable substances. They are very numerous, and of different hues and degrees of transparency; but the most important are vegetable blue-black—obtained from beech-wood burned in close vessels—ivory-black, cork-black, and lamp-black, the principal constituent of all being charcoal or carbon. A fine-toned B. pigment is obtained by burning German or French Prussian blue. Combined with white, B. P., which are slow driers, yield grays of several tints.

BLACK, JOHN, an eminent newspaper editor, and classical scholar of some reputation, was a native of Berwickshire, his father being a shepherd, or farm-labourer, in the Lammermoors, near Dunse. Born in 1783, and left an orphan at twelve years of age, B. commenced life in the office of a Dunse writer, but he soon left that place for Edinburgh, where he was engaged for several years as a writer's clerk. While in this capacity, B. was assiduous in the work of self-education; and besides considerable progress made in classical studies at this time, he acquired German from a German musician in an Edinburgh band, and Italian from a refugee. Finding Edinburgh too limited a sphere for his energies, he went to London about the year 1810, and was immediately engaged as a parliamentary reporter for the *Morning Chronicle*, of which paper he afterwards became editor. Under his management the *Morning Chronicle* was celebrated for its independence and fearless advocacy of progress, and that at a time when subserviency was so common that it was regarded as little or no disgrace. He retired from the editorship in 1843, and continued to reside, until his death, which took place June 25, 1855, in a pleasant cottage on the Kentish estate of one of his friends. Among those who acted on the *Morning Chronicle* under Mr Black was Mr Charles Dickens, the eminent novelist. B. was author of a *Life of Tasso*, with a *Historical and Critical Account of his Writings*, 2 vols. (Edin. 1810), and the translator of the lectures of the brothers Schlegel on *Dramatic Art and Literature* (since republished by Bohn), and on the *History of Literature Ancient and Modern*, as well as of one or two works from the French and Italian.

BLACK, JOSEPH, an eminent chemist, was born in 1728, at Bordeaux, where his father was engaged in the wine-trade. Both his parents were of Scotch descent, but natives of Belfast, to which their son was sent for his education in 1740. In 1746 he entered the university of Glasgow, and studied chemistry under Dr Cullen. In 1751 he went to Edinburgh to complete his medical course, and in 1754 took his degree. His thesis, on the nature of the causticity of lime and the alkalis, which he shewed to be owing to the absence of the carbonic acid (called by him fixed air) present in limestone and in what are now called the carbonates of the alkalis, contained his first contribution to chemical science, and excited considerable attention. In 1756, on the removal of Cullen to Edinburgh, B. succeeded him as professor of anatomy (which branch he afterwards exchanged for medicine) and lecturer on chemistry in Glasgow. Between 1759 and 1763, he evolved that theory of 'latent heat' on which his scientific fame chiefly rests, and which formed the immediate preliminary to the next great stride in discovery by his pupil and assistant James

Watt. In 1766, Cullen was appointed to the chair of theoretical medicine in Edinburgh, and B. succeeded him in the chair of chemistry. Thenceforth he devoted himself chiefly to the elaboration of his lectures, in which he aimed at the utmost degree of perspicuity, and with perfect success. His class became one of the most popular in the university; it occasioned, however, some disappointment that one so capable of enlarging its territory made no further contributions to chemistry. Though of an extremely delicate constitution, he prolonged his life, by care and temperance, to the age of 71. He died on the 26th November 1799. His lectures were published in 1803 (Edin. 2 vols. 4to), edited, with a biographical and critical preface, by Professor Robison.

BLACK ACTS are the acts of the Scottish parliament of the first five Jameses, those of Queen Mary's reign, and of James VI., down to 1586 or 1587. They were called the B. A. because they were all printed in the black or Saxon characters. Several of these acts were afterwards left out in the later additions, most of them because they were private acts, and a few from reasons of state.

In English law-books, the expression 'black act' is applied to the 9 Geo. I. c. 22, because it was occasioned by the outrages committed by persons with their faces blackened or otherwise disguised, and associated, as we are told in the preamble of the act, under the name of Blacks, who appeared in Epping Forest, near Waltham in Essex, and destroyed the deer there, and committed other enormities. This act was, however, along with numerous other statutes, repealed in 1827, by the 7 and 8 Geo. IV. c. 27.

BLACK ART. See MAGIC.

BLACK ASSIZE, the popular name commemorative of an extraordinary and fatal pestilence which broke out at Oxford at the close of the assizes, July 6, 1577. The contemporary accounts describe it as having broken out in the court-house, immediately after the passing of sentence on Richard Jencks, a bookbinder, condemned for alleged sedition to lose his ears. It was popularly interpreted as a divine judgment on the cruelty of the sentence, but the phenomenon is satisfactorily explained by the pestilential atmosphere of the adjoining jail, then, as it was until long after, a seat of misery, filth, and disease. From the 6th of July to the 12th of August, 510 persons are said to have died in Oxford and the neighbourhood of this terrible malady, among whom were the chief officials who sat on the assize, most of the jury, and many members of the university. Women, poor people, physicians, visitors, and children are said to have escaped the infection. A similar event is recorded as having taken place at Cambridge at the Lent Assizes in 1521 (*Holinshed's Chron.*, *Stow's Annals*, *Wood's Athen. Oxon.* &c.).

BLACK-BAND IRONSTONE is an ore of iron found very extensively in Scotland and elsewhere. It occurs in the carboniferous system of geologists, in regular bands, layers, or strata, and generally associated with coal and limestone. It is mainly a carbonate of iron accompanied by much coaly matter. The following is the composition of several samples:

	A.	B.	C.	D.	E.	F.
Carbonate of Iron,*	51.58	50.40	40.62	29.14	53.38	63.80
Carbonate of Lime,	3.78	3.12	1.68	1.52	1.44	1.64
Carbonate of Mag- nesia,	0.11	0.09	0.06	0.04	0.03	0.05
Alumina,	0.74	0.82	trace	trace	trace	trace
Silica,	20.96	26.56	8.48	19.84	2.76	4.48
Coaly Matter,	22.64	18.64	49.16	49.46	42.39	30.03
Water and Loss,	0.21	0.37				
	100.00	100.00	100.00	100.00	100.00	100.00
* Metallic Iron, per cent.,	25.20	25.79	19.61	14.06	25.77	30.80

The B. I. is easily reduced. It does not, however, yield a first-class iron when smelted by itself, and is therefore generally mixed with a small quantity of hematite (red iron ore), which communicates strength and hardness to the iron obtained.

BLACK BEETLE. See **BLAPS** and **COCKROACH**.

BLACKBERRY. See **BRAMBLE**.

BLACKBIRD, or **MERLE** (*Turdus Merula* of some naturalists, *Merula vulgaris* of others), a well-known species of Thrush (q. v.), common in all parts of Britain, and throughout Europe generally; found also in the north of Africa and in the Azores. In Asia, it gives place to a closely allied species, *Turdus pœcilopterus*. In size, the B. is intermediate between the missel-thrush and the song-thrush or mavis. The plumage of the adult male is wholly of a deep black colour, the bill and orbits of the eyes yellow; the female and the young are of a dark rusty brown, with dusky bill and eyelids. The B. frequents hedges, thickets, and woods; is shy, restless, and vigilant, keeping much under cover of evergreens or shrubs; and when disturbed, takes wing with a vociferous chattering of alarm, seeking refuge in some neighbouring thicket. Its food consists of worms, snails, insects, berries, &c. Its fondness for fruit makes it often annoying to the gardener; but probably it would in general be better to protect cherries and pears by nets than to shoot the B., which is of great use as a destroyer of insect larvæ. Like some of the other thrushes, it also devours great numbers of small snails, dexterously breaking the shell against a stone. It is not usually a gregarious bird, although great flocks sometimes appear upon the British coasts in winter, on their passage from more northerly to more southerly countries (*Selby*, quoted by *Yarrell*). Otherwise, the B. is not in Britain a bird of passage. It pairs very early in spring; the male and female are indeed very often seen together during winter; it builds its nest early, and generally has two broods in the year. The nest is generally placed in some thick bush; it is of ruder workmanship than that of the song-thrush, which, however, it resembles, and is usually formed of strong stems of grass, with a finer lining of dry grass inside, and a massive plastering of clay outside. The eggs are four or five in number, of a pale blue colour, generally speckled with brown. The voice of the B. is very powerful, and its song more mellow than that of the thrush, but with 'much less variety, compass, or execution.' The B. is often kept as a cage-bird, and would be much more frequently so, but for the too great loudness of its song: it is very susceptible of being trained, exhibits considerable powers of imitation, and has even been taught to speak.—The **RING OUZEL** (q. v.), a bird very nearly allied to the B., is sometimes called the Ring Blackbird.—The **CROW BLACKBIRDS** (q. v.) of America are entirely different.—The **SAVANNA B.** of the West Indies is also of a different family. See **CROTOPHAGA**.

BLACKBURN, a manufacturing town in the middle of Lancashire, on the B. stream now called simply 'the Brook,' 21 miles north-north-west from Manchester. It is much improved of late years, and has a very beautiful Gothic parish church. Coal and lime abound in the vicinity. The great business of the town is the manufacture of cotton stuffs, chiefly coarse calicoes, valued at more than £2,000,000 yearly, and employing 10,000 persons. Above two hundred years ago, a kind of linsey-woolsey was well known as the 'B. Checks,' afterwards superseded by the 'B. Grays,' so called from their being printed unbleached. Here James Hargreaves (q. v.), a native of the town, invented the

spinning-jenny in 1767. He was driven out of the country, and it was more than forty years before B. followed in the general track of improvement introduced by his invention. Pop. in 1851, 46,536. B. returns two members to parliament. It has plenty of schools, but they are little used, and in 1853 the great majority of the population could neither read nor write. Some years ago, the Elizabethan Free Grammar-school, with fifty governors, a master, and an income from endowment of £120 per annum, had not a single pupil!

BLACKCAP, **BLACKCAP WARBLER,** or **BLACKCAP FAUVE'TTE** (*Curruca atricapilla*), a bird of the great family of the *Sylviadæ*, or Warblers, and of the same genus to which the nightingale is commonly referred. See **FAUVERTE**, **WARBLER**, and **SYLVIADÆ**. It is regarded as the sweetest song-bird in Britain, or indeed in Europe, except the nightingale, to which it is said to be even superior in 'its shake or trilling note.' Very often, however, the strain is desultory, and of short continuance; but it is loud, rich in tone, and has a 'great variety of sweet and gentle modulations.' White says, in his *Natural History of Selborne*, that

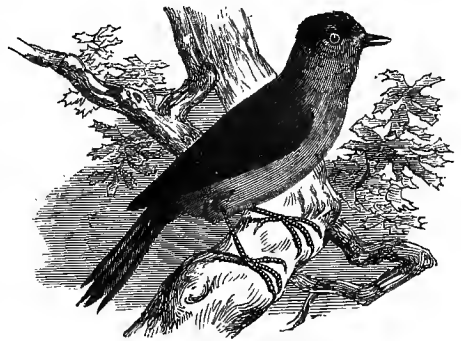

Blackcap (*Curruca atricapilla*).

while the B. warbles, its throat is wonderfully distended. It is a rather smaller bird than the nightingale; the female is larger than the male. The back, wings, and tail are of an ash-brown colour; the chin, throat, and breast are gray; the belly, white. The upper part of the head in the male is jet-black; in the female, of a dull rust colour. The feathers of the head, both in the male and female, are somewhat erected, giving the bird a hooded appearance, on account of which it is called, in Germany, *the monk*. In Britain, the B. is a bird of passage, arriving early in spring, and retiring in September. The males, as in the case of the nightingale, arrive a few days before the females. The B. is not a common bird in Britain: it is most frequent in the southern counties of England, but is found even in Scotland; on the continent, it extends its migrations as far north as Lapland. In the south of Europe, it is found both in summer and winter. As a cage-bird, it is pleasing not only on account of its song—which, however, is sometimes partly spoiled by its too successful imitation of other birds—but also on account of its manners, the intelligence which it displays, and its strong attachment to those who are accustomed to feed and caress it.

BLACKCAP TITMOUSE, or **CHICKADEE'**, a North American bird. See **TITMOUSE**. The Marsh Titmouse, a British bird, is sometimes called Blackcap, or Blackcap Titmouse.

BLACK CHALK is a variety of Clay-slate (q. v.), containing a considerable proportion of carbon. It is used for drawing, and is also ground down to form a black paint. It is found as a rock of a slaty texture and bluish-black colour in the island of Ilay and in Caernarvonshire, also in Spain, and other parts of the world.

BLACKCOCK, HEATH-FOWL, or BLACK GROUSE (*Tetrao Tetrix*), a species of Grouse (q. v.), abundant in Britain wherever there are moors of considerable extent, and more particularly where there are bogs and morasses with rank herbage, or, adjacent to the moors, natural woods or young plantations of pine and fir. Comparatively rare in the south of England, the B. becomes more common towards the north, and is very plentiful in the mountainous parts of Scotland. It is found in some of the Hebrides, but not in the Orkney or Shetland Isles. On the continent of Europe, it occurs both in mountainous and marshy countries, as on the Alps and in Holland; it is found as far south as the Apennines, and as far north as the forests of Lapland; it abounds in most parts of Scandinavia, where it is carefully protected, the males only being killed, great numbers of which are sent to the London market; it is diffused over almost all parts of Russia, and is found in Siberia. The male is much larger than the female, sometimes weighing as much as four pounds, whilst the female weighs only about two pounds; they also differ very much in plumage. The male is of a shining bluish-black colour, with a conspicuous white bar on the wings below the ends of the great wing-coverts, and a mixture of black and white on the legs; there is a piece of bare scarlet skin over the eye; the outer feathers on each side of the tail are elongated and curve outwards, giving it a very peculiar appearance. The female, called the *Gray Hen*, is of a rust colour,



Blackcock (*Tetrao Tetrix*).

darkest on the upper parts, everywhere barred and mottled with a darker colour; the tail is straight and even at the end. The young males resemble the females in plumage. The shank in this species is feathered, but not the toes. It is a gregarious bird, the different sexes, however, in winter, generally keeping in flocks by themselves. In spring, the males resort to elevated and open spots, where they crow, and also make a sound which has been likened to the whetting of a scythe, thus inviting the females to repair to them; they strut and trail their wings like turkey-cocks, and fierce contests often take place among them. They are polygamous, and pay no attention to the females during incubation, nor do they take any part in rearing the young.—The nest is of the simplest construction, a few straws or

the like, placed together among tall heath, or under the shelter of a low thick bush. The eggs, six to eight in number, are yellowish-white, speckled with orange-brown, and about two inches long. The food of the B. consists of the seeds of rushes and other plants, berries, insects, the tender shoots of heath, leaves, &c.; it sometimes visits cornfields and stubbles to feed on corn; is frequently to be found in turnip-fields in the neighbourhood of plantations in hilly districts; and, at least in winter, eats the young shoots of pines, firs, birches, and alders. It is highly esteemed for the table.

It seems to be well established that hybrids are occasionally produced between the B. and other species of grouse; and also between the B. and the pheasant; but this subject, although regarded with much interest by some of the greatest naturalists, has not yet received the investigation which it deserves, and nothing appears to be known concerning any offspring of such hybrids. See Yarrell's *British Birds*, ii. 289—314. It can only be deemed probable, not certain, that the bird called *Tetrao hybridus*, sometimes found in the Scandinavian peninsula and other parts of Europe, is a hybrid between the B. and the Capercailzie (q. v.).

BLACK DEATH was one of the names given to an oriental plague marked by inflammatory boils and tumours, which in the 14th c. desolated the world. It took this name from the black spots, symptomatic of a putrid decomposition, which, at one of its stages, appeared upon the skin.

Our information as to the symptoms and course of this terrible malady is far from perfect. So much is clear, that they varied somewhat from case to case, and in different countries, and greatly changed towards the close of the period of its ravages in Europe (1348—1351). Among them may be noticed great imposthumes on the thighs and arms—what are called huboes—and smaller boils on the arms and face; in many cases, black spots all over the body; and in some, affection of the head, stupor, and palsy of the tongue, which became black as if suffused with blood; burning and unslakable thirst; putrid inflammation of the lungs, attended by acute pains in the chest, the expectoration of blood, and a fetid pestiferous breath. On the first appearance of the plague in Europe, fever, the evacuation of blood, and carbuncular affection of the lungs, brought death before the other symptoms could be developed; afterwards, boils and huboes characterised its fatal course in Europe as in the East. In almost all cases its victims perished in two or three days after being attacked. Its spots and tumours were the seals of a doom which medicine had no power to avert, and which in despair many anticipated by self-slaughter.

If the symptoms of the B. D. have been only imperfectly handed down to us, the history of its rise and progress is still more obscure. But while fable enters largely into its history, it would seem to be safe to assign its birthplace to China; and there is a strong concurrence of testimony, that the causes which co-operated to produce it are to be sought for as far back as 1333—15 years before its outbreak in Europe—in a series of great convulsions of the earth's structure, which commenced in that year, and which, for 26 years thereafter, continued powerfully to affect the conditions of animal and vegetable life. The precise date of the appearance of the plague in China is unknown, but from 1333 till 1348, that great country suffered a terrible mortality from droughts, famines, floods, earthquakes which swallowed mountains, and swarms of innumerable locusts; and in the last few years of that period, from the plague. During the same time, Europe manifested sympathy with the changes

which affected the East. The order of the seasons seemed at various times to be inverted; storms of thunder and lightning were frequent in the dead of winter, and there occurred great earthquakes and eruptions of volcanoes conceived to have become extinct. The theory is, that this great tellurian activity, accompanied by the decomposition of vast organic masses, myriads of bodies of men, brutes, and locusts, produced some change in the atmosphere unfavourable to life; and some writers, speaking of the established progress of the plague from East to West, say that the impure air was actually visible, as it approached with its burden of death. 'A dense and awful fog was seen in the heavens, rising in the East, and descending upon Italy' (*Mansfeld Chronicle in Cyriac Spangenberg*, chap. 287, fol. 336). With this view of the plague it is to be conjoined another regarding the causes which produced a predisposition of the inhabitants of Europe to become its victims, and which are referred to the effects on the popular health partly of scarcity, and partly of the prevalent bad habits of living. There is much probability in the theory, that the plague was owing to an atmospheric poison acting on the organs of respiration, which, it will be recollected, were always those first attacked. But while impurity of the air and the state of the public health may have largely contributed to the mortality, it may be doubted whether the disease did not owe its extension almost wholly to infection and contagion, whatever causes may have originally produced it. It appears that the pestilence had in a milder form appeared in Europe in 1342, but it had passed away, and there is little reason for holding that, in the interval, it remained merely latent. The invasion of 1348 may actually be tracked from China in its advance by the various caravan routes towards the West. The northern coast of the Black Sea sent the plague by contagion to Constantinople. By contagion it reached the seaports of Italy, and thence, as from so many foci of contagion, it soon established itself over Europe. Its advance may be traced through Germany and France to England, from which it was transmitted to Sweden. It was three years from its appearance at Constantinople, before it crept, by a great circle, to the Russian territories. This fact of its spread by contagion has led to speculations as to whether, by rigid rules of quarantine, it might not have been excluded from Europe. Such rules are now at many points in force as securities against oriental plagues.

There are no proper materials for estimating the mortality which this plague produced, for it occurred before the value of statistics was appreciated. But in China, 13,000,000 are said to have died, and in the rest of the East nearly 24,000,000. These numbers appal the imagination. Coming to Europe, the horror is increased by the greater exactness of the details. London alone lost over 100,000 souls; 15 European cities lost among them about 300,000; Germany is calculated to have lost 1,244,434; Italy, one half of its population. On a moderate calculation, it may be assumed that there perished in Europe 25,000,000 human beings. Africa suffered with the rest of the known world. Everywhere was death. All animal life was threatened. Rivers were consecrated to receive corpses, for which none dared perform the rites of burial, and which in other places were cast in thousands into huge pits made for their reception. Death was on the sea, too, as well as on the land, and the imagination is quickened to the realisation of the terrible mortality by accounts of ships without crews—the crews dead and putrefying on the decks of the aimless hulls—drifting through the Mediterranean, the Black and the North Seas, and cursing with the contagion the

shores on which winds or the tide chanced to cast them.

The mortality caused by the plague was, however, only one of the evils to which it gave rise. Its moral effects on the survivors and the frame of society were no less momentous. Many died of fear, which among the living dissolved the ties of kindred; mothers forsook their plague-stricken children; the worldly became quickened to a maddening sense of sin; the religious fixed their eyes more steadily on futurity; all rushed to sacrifice their means to the church, while the ecclesiastics drew back from the gold showered over their walls, as being tainted with death. Superstition finally banded multitudes together by common means to work out the common safety. In Hungary, and afterwards in Germany, rose the brotherhood of the Flagellants, who undertook to expiate the sins of the people, and avert the pestilence by self-imposed sufferings. Originally of the lower classes, they gathered to their order, as it extended, crowds of the highest, both men and women, and marched from city to city, robed in sombre garments, with red crosses on the breast, back, and cap, and with their heads covered as far as the eyes; they went chanting in solemn processions with banners, with down-turned faces, and bearing triple scourges with points of iron, with which, at stated times, they lacerated their bodies. They at last pervaded nearly all Europe; Germany, Hungary, Poland, Bohemia, Silesia, and Flanders did them homage. This, however, is not the place to give their history, for which the reader will refer to the article under the head FLAGELLANTS. Suffice it that the order was not suppressed till the pope, at the instigation of several crowned heads, prohibited throughout Christendom their pilgrimages, on pain of excommunication. While the wanderings of the Flagellants threw society into confusion, and helped to spread the plague, the horrors of the time were further heightened by the fearful persecutions to which the Jews were subjected, from a popular belief that the pestilence was owing to their poisoning the public wells. The people rose to exterminate the Hebrew race, of whom, in Mayence alone, 12,000 were cruelly murdered. They were killed by fire and by torture wherever they could be found, and for them, to the terrors of the plague were added those of a populace everywhere infuriated against them. In some places, the Jewish people immolated themselves in masses; in others, not a soul of them survived the assaults of their enemies. No adequate notion can be conveyed of these horrors. To aggravate the pestilence, the panic made the people shut up their wells. With terror of poison and of plague in a state of society rude at the best, but now disorganised, what means were available to mitigate or prevent the sufferings of the people were rendered altogether nugatory.

It would be useless to attempt to give any notion of the effects on society of this plague; how during it some, like people in sieges, came to be callous, and some, like thieves under the gallows, to regard the desolation only as it afforded opportunities for plunder and indulgence. The whole phenomena would form a fine study for the social philosopher and psychologist. We must content ourselves here with referring the reader to the *Decameron* of Boccaccio for a description of the plague at Florence, which, for vividness and particularity of observation, almost equals Thucydides's account of the plague at Athens. In Bulwer's *Rienzi*, also, an account of the plague will be found. The reader should also consult Hecker's *Epidemics of the Middle Ages*, translated for the Sydenham

Society. Accounts of the plague have been left us by the physicians Guy de Chauliac and Chalin de Vinario. But perhaps Boccaccio's is the best of the whole. The B. D. afterwards more than once appeared in Europe, but never with the same virulence or duration.

BLACKFISH (*Centrolophus Moris*), a fish of the family of the *Scomberidae* (q. v.), very nearly allied to the beautiful *Coryphenes* (q. v.), so frequently called dolphins. It is found both in the Mediterranean Sea and on the western coasts of Europe, occasionally on the southern coasts of Britain, but is everywhere rare, perhaps because it is an inhabitant chiefly of deep waters. It is known to attain a length of more than thirty inches, and a weight of fourteen pounds. The general form is not unlike that of a perch; there is a single elongated dorsal fin with short rays, rising from a thin elevated ridge; the body is covered with minute scales, the skin is tough and can be stripped off like that of an eel; there is no air-bladder. The colour is black, that of the fins intensely so. The B. is remarkable for great strength and velocity. As an article of food, it is described as delicious.

BLACK FLUX is prepared by heating in a covered crucible ordinary or crude cream of tartar, or the bitartrate of potash ($\text{KO}, \text{HO}, \text{C}_2\text{H}_4\text{O}_{10}$); when the tartaric acid ($\text{C}_4\text{H}_4\text{O}_{10}$) is decomposed, and charred, forming carbonic acid (CO_2), which remains in combination with the potash (KO) as carbonate of potash (KO, CO_2), accompanied by much free carbon. This very intimate mixture of carbonate of potash and carbon, otherwise called B. F., is a fine black powder of great service in the fluxing of metallic ores, as of lead (q. v.), and the separation of the metal therefrom. The B. F. is likewise employed as the raw material from which, on the application of heat in iron vessels, the metal potassium can be obtained.

BLACK FOREST (Ger. Schwarzwald), a wooded mountain-chain in Baden and Württemberg, running from south to north along the western side of Swabia, parallel with the course of the Rhine after its great bend near Basel, and often only a few miles distant from it. The Rhine also bounds it on the south, and the level country between the Enz and the confluence of the Neckar with the Rhine borders it on the north; lat. $47^\circ 30'$ — $49^\circ 30'$ N., long. $7^\circ 40'$ — 9° E. The chief rivers rising in the B. F. are the Danube, Neckar, Murg, Kinzig, Elz, Enz, and Wiessen. The B. F. attains its greatest elevation in the Feldberg (variously stated at from 4600 to 4892 feet high), which rises near the source of the Wiessen and the celebrated Hölle (Hell) Pass, a narrow valley shut in by mountains in the vicinity of Neustadt. The great mass called the Kaiserstuhl (Emperor's Chair), situated near Breisach, is quite isolated. As to the geological character of the B. F., primitive granite and gneiss form its core; porphyry is found on its sides, and sandstone along its highest ridges, as well as at its base. Silver, copper, cobalt, lead, and iron are found in greater or less quantity in its principal chain, which is luxuriantly wooded, its name Schwarzwald being derived from the dark-tinted foliage and immense number of its fir-trees. The B. F. is also rich in mineral waters, as, e. g., the baths of Baden-Baden and Wildbad (q. v.). On the Rhine side, the descent is precipitous, but towards the Danube and the Neckar it is gradual. Among its numerous valleys, the Murgthal is the most famous for its natural beauties. The western slopes are studded with vineyards. Summer rye, oats, and potatoes are cultivated in some parts of the B. F.; but it is with difficulty, and the rearing of cattle is

prosecuted with much greater success. This, and the manufacture of articles of wood, forms the chief industry of the inhabitants. Above 180,000 wooden clocks alone, many of them of an ingenious automatical character, are made every year in the B. F., and exported to all parts of Europe and America, their value being estimated at half a million gulden, or about £40,000.

Two of the passes of the B. F., the Kniebis and the Hölle, acquired considerable celebrity during the wars of the French Revolution. The first, situated on the borders between Baden and Württemberg, at the source of the Murg, was taken by the French in 1796 and in 1797; the Hölle is known in connection with Moreau's retreat in 1796.

BLACKHEATH, a high-lying open common, in the county of Kent, five miles south-east of London, near Greenwich Park. It commands a fine view of great extent, and being a healthy tract, many villas have been built on its margin. It is a favourite holiday resort for Londoners. The Roman road to Dover crossed it. B. is one of the few places in England where the ancient Scottish game of golf is practised. On it stands Morden College, founded in 1695 by Sir J. Morden for decayed merchants, and with a revenue of £5000. B. was formerly the scene of several insurrections, including those of Wat Tyler, 1381, and Jack Cade, 1450. Here the Danes encamped in 1011; the Londoners welcomed Henry V. from Agincourt; and Charles II., on his way from Dover, met the army of the Restoration. B. was also a noted place for highwaymen.

BLACK HOLE, an appellation familiarly given to a dungeon or dark cell in a prison, and which is associated in the public mind with a horrible catastrophe in the history of British India—namely, the cruel confinement of a party of English in an apartment called the 'Black Hole of Calcutta,' on the night of the 18th of June 1756. The garrison of the fort connected with the English factory at Calcutta, having been captured by the nabob Suraja Dowlah, this barbarian caused the whole of the prisoners taken, 146 in number, to be confined in an apartment 20 feet square. This cell had only two small windows, and these were obstructed by a veranda. The crush of the unhappy sufferers was dreadful; and after a night of excruciating agony from pressure, heat, thirst, and want of air, there were in the morning only 23 survivors, the ghastliest forms ever seen on earth. See HINDUSTAN.

BLACKIE, JOHN STUART, Professor of Greek in the university of Edinburgh, was born in Glasgow in 1809, but received his early education in Aberdeen, where his father was agent for a bank. After going through the usual course of a Scotch university education—partly at Marischal College, Aberdeen, partly at Edinburgh—with a view to the church, he went in 1829 to Germany, and studied for some time both at Göttingen and Berlin. He then proceeded to Rome, where he spent more than a year. During this period, he acquired a mastery of German and Italian, and an acquaintance more extensive than ordinary with the literature of those countries, especially with that of Germany. On his return from the continent, having abandoned the thought of entering the church, he began the study of law, and passed as advocate at the Edinburgh bar in 1834. But he soon found the practice of the profession uncongenial, and devoted himself henceforth to literary pursuits. Among his earliest productions was his translation, in English verse, of Goethe's *Faust*, which, notwithstanding considerable ruggedness, is preferred by G. H. Lewes to any other of the metrical translations. He

wrote also about this period numerous articles in the *Foreign Quarterly Review*, the *Westminster*, *Blackwood*, and *Tait*, chiefly on German subjects. In 1841, he was appointed by the crown to the chair of Humanity in Marischal College, which he held until, in 1852, he was elected to the Greek chair in the university of Edinburgh. Ever since he became professor, he has been incessant, by means of pamphlets, lectures, and addresses, in calling public attention in Scotland to the importance of educational reform, more especially to the necessity of raising the standard of the schools preparatory to the universities. He took an active part in the movement that led in 1859 to the remodelling of the Scottish universities. Of works of a professional and philological kind may be mentioned two lectures *On the Studying and Teaching of Languages*; a contribution to the *Classical Museum*, published separately, *On the Rhythmical Declamation of the Ancients*; *The Pronunciation of Greek*; *Accent and Quantity*, 1852. Perhaps the most matured and scholarly of B.'s productions is his metrical translation, with notes, of the dramas of Æschylus, published in 1850. B. has also contributed the articles 'Æschylus' and 'Homer' to the *Encyclopædia Britannica*. In 1853, he paid a visit to Greece, and spent about three months in Athens, acquiring a complete mastery of the language as now spoken; and as fruits of the visit, there appeared an introductory lecture *On the Living Language of Greece*, together with articles in the *North British* and *Westminster Reviews*. Not content with educational and philological subjects, the versatile activity of Professor B. has led him to make incursions into the fields both of abstract speculation and of poetry. Besides an essay on 'The Philosophy of Plato,' in the *Edinburgh Essays*, 1856, he published in 1858 a treatise on *Beauty*, in refutation of Lord Jeffrey's association theory, and containing an exposition of the æsthetic philosophy of Plato. In 1857 appeared *Lays and Legends of Ancient Greece, with other Poems*; and in 1860, *Lyrical Poems*. B. is also understood to be far advanced with a metrical translation of *Homer*.

BLACKING is the material employed for producing a black glazed shining surface on leather. The main ingredient in the various kinds of B. is bone-black (q. v.), which is mixed with an oil, some sugar, and a little sulphuric acid. The materials in Day and Martin's B. are finely powdered bone-black ground with sperm-oil, raw sugar or molasses, a little vinegar, and some concentrated sulphuric acid (specific gravity 1850). The substances are incorporated together one by one in the order in which they are stated, and the action of the sulphuric acid is to convert much of the lime in the bone-black into sulphate of lime, which causes a thickening of the mixture, and a tenacious paste results. This paste, diluted with weak vinegar, is put, while warm, in stoneware bottles, and is then ready for the market. See **SHOE-BLACK**.

BLACK JACK, the name given by miners to Blende (q. v.). It was also the name applied in former times to a kind of drinking flagon.—**B. J.** (tree), see **OAK**.—**B. J.** or **NIGGER CATERPILLAR**, see **TURNIP SAWFLY**.

BLACK LEAD, **GRAPHITE**, or **PLUMBA'GO**, a mineral consisting chiefly of carbon, but containing also more or less of alumina, silica, lime, iron, &c., to the extent of 1 to 47 per cent., apparently mixed rather than chemically combined. B. L. is the popular name, and that by which it is generally known in the arts; Graphite is that generally preferred by mineralogists.—The name **B. L.**,

however, ought, perhaps, to be regarded as an unfortunate one, as no lead enters into the composition of the mineral. It sometimes occurs crystallised in short imbedded hexagonal prisms; but generally massive, and more or less radiated, foliated, scaly, or compact. It is of a grayish-black colour, with a somewhat metallic lustre, and is perfectly opaque. It is greasy to the touch, and is a perfect conductor of electricity. It is found in primary and transition rocks, as in gneiss, mica-slate, quartz-rock, greenstone, and clay-slate, and pretty abundantly in various parts of the world. It is much more incombustible than even anthracite (or *blind-coal*), burning with much difficulty even before the blow-pipe, on which account it is much used for the manufacture of crucibles or 'melting-pots,' which withstand a great heat. These are not, however, made of mere B. L., but of B. L. in powder, mixed with half its weight of clay. B. L. is employed for making pencils (q. v.). It is also extensively employed to give a black gloss to iron grates, stoves, railings, &c., and to diminish the friction of the belts and other parts of machinery. Lately it has been suggested as a lubricating agent in the cartridges of rifles, instead of lard or tallow.—Much B. L. is obtained at Borrowdale, in Cumberland, where it occurs in nests in green stone.

BLACK LETTER (**Black Letter**), the name commonly given in this country to the types which on the continent are most generally known as Gothic. The first printed books imitated every peculiarity of the contemporary manuscripts; and as printing was first practised in Germany and the Netherlands, the first types were copies of the letters in use in those countries in the middle of the 15th c. Two sorts of letters have been employed in the writings of Western Christendom. What have been called Roman letters prevailed from the 5th to about the close of the 12th c., when they gradually began to pass into what have been called Gothic letters, which continued till the 16th c., when, in most European countries, they were superseded by Roman letters. The first types, as has been said, were Gothic, and they spread with the art of printing into various European states. In France and Italy, they were slightly modified by cutting off some of their rougher points; and when thus trimmed, they came to be known in the former country as *lettres de somme*, being so called, it is said, from their use in an edition of the *Summa* of St Thomas Aquinas. The classic taste of Italy could not long tolerate the Gothic character even of the *lettres de somme*; and they were still further modified, until they assumed the shape to which the name of Roman letters has since been given. The first works printed with these new types were two beautiful editions of Pliny's *Natural History*: the one by John of Spira at Venice in 1469; and the other by his disciple, Nicholas Jenson, also at Venice, in 1472. Another Venetian printer—the first Aldus Manutius—attempted in 1501 to supersede the Roman letters by what have been called Aldine (q. v.), or Venetian, but are best known as Italic characters. These can scarcely be said to have come into much more than temporary or exceptional use; but the Roman letters in no long time spread from Venice all over the west of Europe. Although thus supplanted in general use, the Gothic or B. L. was long retained for special purposes, such as, in this country, the printing of Bibles, prayer-books, proclamations, and acts of parliament. Books in B. L. being the earliest, are highly prized by antiquaries and bibliomaniaes, who are hence sometimes spoken of as 'black-letter' devotees. Thus, Matthias, in his *Pursuits of*

Literature (published in 1796), alluding to the commentators on Shakspeare, writes:

On Avon's banks I heard Aetæon mourn,
By fell *black-letter dogs* in pieces torn;
Dogs that from Gothic kennels eager start, &c.

The Gothic or B. L. still continues in general use in Germany, but of late has begun to give way in some quarters to the Roman.

BLACK LIST. Such is the name familiarly applied to printed lists connected with insolvency, bankruptcy, and other matters affecting the credit of firms and individuals, and which are circulated for the private guidance of the mercantile community. These lists, which serve an important purpose, are well known by commercial men in the United Kingdom. One called *The Mercantile Test*, consisting of 8 pages 4to, is published every week in London. In its contents are embraced the bankruptcies of England, Scotland, and Ireland; Scottish registers of protested bills; judgments for debt in the Irish courts; offers of composition; dissolutions of partnership; warrants of attorney and cognovits; judges' orders; bills of sale, &c. Another published list in London, is called *Perry's Bankrupt and Insolvent Weekly Gazette*. The legality of issuing information of this kind has been challenged, but it has been determined that it is quite lawful. In point of fact, the lists are only extracts from public registers, as are the ordinary lists of bankruptcies in the newspapers. Private lists of a more searching kind are furnished to subscribers by Mr Thomas Percy of Cornhill, the proprietor of the 'Original Bankrupt and Insolvent Registry Office, for Protection against Fraud, Swindlers,' &c.; and also by the Scottish Trade Protection Society, Edinburgh. See **TRADE PROTECTION SOCIETY**. In the United States, printed lists of forgeries of bank-notes are similarly issued. In one of these *Counterfeit Detectors*—which is certainly *black* enough—may be reckoned up some thousands of varieties of forged bank-notes in circulation; the whole revealing a frightful state of commercial and moral depravity.

BLACKLOCK, THOMAS, D.D., a remarkable example of the power of the mind to overcome the most oppressive disadvantages, was born at Annan in 1721, and died at Edinburgh in 1791. The child of humble parents, and deprived before he was six months old of the power of sight, he won for himself before he reached middle age the designation of an accomplished scholar, a cultivated thinker, and, for those times, a respectable poet. After going through the necessary course of academic study in Edinburgh, he was licensed as a preacher of the Established Church in 1759, and in 1762 was ordained minister of Kirkcudbright. The determined resistance of the congregation to the appointment, based apparently on his too philosophical and 'moderate' style of preaching (joined perhaps to the fact that he was the intimate friend of David Hume), led to a litigation, to his sensitive mind extremely distressing, and he resigned the charge in consideration of a small annuity. After this, he resided in Edinburgh till his death, occupied chiefly in superintending the education of a limited number of boarders, a charge for which his varied accomplishments and benign manners peculiarly qualified him. He will, however, be best remembered in connection with that famous letter of his which happily arrested Robert Burns on the eve of his departure for the West Indies, and thus, to all human appearance, saved from oblivion the greatest lyricist that the world has seen. A collected edition of his poems was published in 1793, with a biographical sketch by Henry Mackenzie.

BLACK-MAIL, a scarcely voluntary impost submitted to, in the earlier half of the 18th c., by the people of the Highlands, and of parts of the Lowlands bordering on the Highlands, as a kind of compromise with robbers. The districts in question, being then in an extremely barbarous state, enjoyed but an imperfect protection from the law. Owing, moreover, in part, to political and social circumstances, theft and robbery were not then regarded in the Highlands as they are now: to carry off the cattle of a neighbour was perhaps only wreaking out an old family quarrel or clan dispute, or making reprisals for some severity of persons in power. Certain it is that men of good standing gave a certain degree of protection to notorious cattle-lifters. In these circumstances, a class of men rose up who professed to take upon themselves the duty of protecting the property of individuals, on the payment by them of a percentage on their rents, generally 4 per cent. They were not low men who did so; nearly all of them had good Highland pedigrees, and passed externally as honourable persons, though there was only too great reason to suspect that they encouraged and profited by robberies, in order to make the B. a necessity. The celebrated Rob Roy was, about 1730, a notable levier of B. in the southern Highlands and adjacent Lowland districts. A little later, Coll M'Donell of Barrisdale, a cadet of the Glengarry family, was equally noted further north. When one of the payers of the B. suffered what was called a *her ship*, the levier of the impost, being quickly informed of what had happened, busied himself to recover the lost cattle, and if he failed, he held himself bound to pay an equivalent. We are informed by Mr Lapslie, the minister of Campsie, Stirlingshire, in his Statistical Account of the parish, 1795, that his father, John Lapslie, was a farmer who paid B. in 1744 to M'Gregor of Glengyle, the nephew of Rob Roy. The engagement was that he should make good losses, if the number of sheep stolen exceeded seven, for anything less was held as not a *her ship* or *lifting*, but merely a *picking*. Early in 1745, fifteen were stolen, and M'Gregor was honourably preparing to replace them, when the breaking out of the rebellion, in which he became involved, deprived him of the power of fulfilling his engagement, and likewise put an end to his self-created wardenship of the Highland borders. After that period, law was vigorously enforced in the Highlands, and B. ceased to be heard of.

BLACKMORE, SIR RICHARD, one of the court physicians in the reigns of William III. and Anne, is remembered as the most heavy and voluminous poetaster of his own or any other age. He appears to have been a good and well-meaning man, and the merciless ridicule of contemporary wits was due, in some part at least, to the moral and religious tone of his works, and to his free censures of the libertinism of the time. But the worthlessness of the poems has been amply confirmed by the judgment of posterity. *The Creation*, considered his best, Addison pronounces 'one of the most useful and noble productions in our English verse;' but few modern readers are likely to examine the grounds of this judgment, still less to agree with it. B. wrote six epics (choosing always the loftiest themes)—viz., *Prince Arthur*, in 10 books; *King Arthur*, in 12; *Eliza*, in 10; *Creation*, in 7; *Redemption*, in 6; *Alfred*, in 12; besides *The Nature of Man*, 3 books; a new version of the Psalms, paraphrases of Job, and other parts of the Bible, and a long list of theological, medical, and miscellaneous treatises.

BLACK PRINCE, the name usually given in

history to Edward Prince of Wales, son of Edward III. (q. v.).

BLACK QUARTER, syn. *Black Spald*, *Black Leg*, *Quarter Evil*, *Blood Striking*; incorrectly termed by some English writers *Inflammatory Fever*—termed by others *Hæmatosepsis* (Simonds) *Hæmatoclysis*.

Definition.—An apoplectic disease peculiar to cattle; a form of carbuncular disease, or anthrax—enzootic, i. e., limited to districts; not spread by contagion, but attended, especially in warm climates, and in Great Britain in hot weather, with the development of a blood-poison destructive to man and the lower animals. See MALIGNANT PUSTULE.

Causes.—Rich pasture on stiff, retentive, and undrained soil; sudden changes from poor to rich keep, particularly with animals in good health, predisposed to make blood or fatten fast. Youth predisposes to the disease, from the greater activity of the nutritive functions in early life. It is a disease confined almost entirely to yearling and two-year old animals; the writer has, however, seen it in aged cows, &c. A young animal, thriving fast, may suddenly be seized with B. Q., if exposed to cold, showers, or a storm. A check thus induced to the organs of secretion, and particularly to the action of the skin, at once produces the blood-charge and apoplectic effusion peculiar to the disease. In various countries where calves are reared by the hand, and not allowed to suckle their mothers, there are many cases of quarter ill when the young animals are transferred from the stable or bare fields to rich grass-lands. The malady is chiefly witnessed in spring and autumn, particularly when animals are fed on strong autumn grass.

Symptoms.—The premonitory signs are often very insignificant, and usually overlooked. The healthy thriving aspect of a young steer, in a district where the disease prevails, excites the suspicion of the farmer. The animal may be observed with a sleek coat, voracious appetite, quick staring look, suddenly to stop feeding; the eyes become bloodshot; there is slight salivation or foaming at the mouth; and in the space of an hour or less, it will fall helpless, having manifested slight lameness in one of the limbs before dropping. In other cases, the animal suffers from swelling and pains, suddenly developed in one of the joints, whether the fetlocks, knees, or hocks, elbow, shoulder, or stifle. The swelling extends, and the animal falls. In both cases, the limb or *quarter* of the animal affected swells, the skin is bluish, the veins of the part are distended by black blood, and the creature is perfectly helpless. The suffering is unusually acute; but in many instances the respiration is tranquil, the pulse, however, oppressed and frequent. Animals in this state are costive at first, but occasionally violent diarrhoea supervenes, and the excrement is tinged by black extravasated blood. Death almost invariably supervenes in from 4 to 48 hours. Some cases prove lingering, especially if active and proper treatment be employed early; but recovery is rare. The symptoms of approaching death are convulsive twitchings of the muscles, fixed haggard look, grinding with the teeth, and spasmodic breathing. In some cases, the animal appears quite paralytic, and quietly breathes its last.

Post-mortem Appearances.—The quarter affected is found, when cut into, soaked in black semi-coagulated blood. Similar blood is found in all the vessels of the body, and all the tissues have consequently a black congested appearance, particularly the lungs. The heart, as in all blood-diseases, is stained both externally and internally by black blood, effused beneath its serous covering or lining; and this appearance has led some veterinarians to

believe the immediate cause of death to be inflammation of the heart. Such is not the case. The blood extravasations indicate the peculiar condition of the circulating fluid. In some cases in which a joint has been affected some hours before severe constitutional symptoms have appeared, the tissues around the joints are infiltrated by a yellow semi-solid exudation or lymph, which is capable of producing malignant pustule if inoculated in man or animals. Abscesses and sloughs are occasionally met with in and around the diseased joints.

Treatment.—In the earliest stage, blood-letting to the extent of 5 or 6 quarts. Administer half-ounce doses of nitre in solution every half-hour for 4 or 5 hours. Give the animal much water to drink, and if chances of recovery are observed, 4-ounce doses of Mindererus's spirit, or solution of the acetate of ammonia, must be given every 4 hours. As the animal rallies, it may be desirable to administer a mild purge of Epsom or Glauber salts. The local treatment consists in incisions into the swollen parts, care being taken that the joints are not penetrated. The incisions must be washed with the following lotion: Chloride of zinc, 1 drachm; water, 12 ounces; dissolve and apply with linen rag or lint, confining the moisture by gutta-percha or oil-silk. Treatment is not often successful, but we have the greatest facilities for

Prevention by deep draining, whereby many pasture-lands have been rendered perfectly safe—after having repeatedly ruined tenant-farmers—from destruction by black quarter. In some hill-lands, where drainage does not appear the cause, the malady may be prevented by giving to all the cattle on the farm a weekly dose of an ounce of nitre. The animals that thrive most rapidly should have the medicine rather more frequently, though not to such an extent as to reduce their condition.

The flesh of animals dying from this disease should not be used for human food. It has destroyed whole families, and though in this cold climate accidents are rare, nevertheless they have occurred. Butchers have lost their arms, and persons have lost their lives from being inoculated in cutting up meat from oxen that have died of quarter ill.

BLACK ROD, USHER OF THE, an officer of the House of Lords, appointed by letters-patent. He is chief gentleman-usher to the sovereign, and belongs to the order of the Garter. His principal duty is to summon (himself, or by his deputy the yeoman-usher) the House of Commons to the Peers when the royal assent is given to bills, or when royal speeches are read; and to take into custody any peer guilty of breach of privilege. His income is derived from certain fees under the regulation of the House; and the appointment of messengers, door-keepers, servants, &c., rests with him. This patronage was at one time very lucrative, but new arrangements have made it much less so.

BLACK ROOD OF SCOTLAND. When the Anglo-Saxon princess who became the wife of King Malcolm Ceanmohr landed in Scotland, about the year 1070, she brought with her what was regarded as a priceless relic—a cross of gold, elaborately wrought, in the form of a casket, about a span long, containing what was believed to be a piece of the true cross, set in an ebony figure of the Saviour, richly decorated with gold. Of its earlier history, nothing is known; but St Margaret bequeathed it as an inheritance to her children, and as she herself was at the point of death, we are told by her confessor, that she had it brought to her bedside, when she pressed it to her eyes and lips, and expired clasping it with both her hands. The contemporary biographer of

her son, King David I., relates that 'the Black Rood of Scotland,' as it was called, received the dying adoration of that saintly prince, and that it had then (in the middle of the 12th c.) come to be regarded by the whole nation of the Scots with mingled feelings of love and awe. It was kept as an heirloom of the kingdom, in the royal treasury in the castle of Edinburgh, and along with the other regalia and muniments of Scotland, was delivered up to King Edward I. in 1291. The irreverent scrutiny of the officers of the English king discovered that the outer case, which to the eyes of St Aelred, in the previous century, seemed to be of the purest gold, was only silver gilt. But the relic itself was not the less venerable on that account; and it was used by King Edward to give increased solemnity to the oaths of fealty which he exacted from the magnates of Scotland. Thus, when the bishops of St Andrews and of Glasgow sided with Bruce, it was urged as a heinous aggravation of their guilt, that they had sworn 'upon the body of Christ (i. e., the sacrament of the eucharist), and upon the holy gospels, and upon the cross of St Neot, and upon the B. R. of S., to be true and faithful to the English king and his heirs for ever. When the long struggle between England and Scotland was at last ended by the peace of Northampton in 1328, the B. R. was restored to Scotland as one of the national treasures. But it was not destined to remain long in the north. When the hapless King David II. invaded England in 1346, he carried the B. R. with him, in the belief (common in that age) that such a holy relic would insure safety to his person or victory to his arms. On his defeat and capture under the walls of Durham, the B. R. of S. became the prize of his conqueror, Sir Ralph de Neville, Lord of Raby, by whom, along with other spoils of the battle, it was offered up at the shrine of St Cuthbert, in the cathedral of Durham. There it hung till the Reformation, when all trace of it disappears.

BLACK or EUXINE SEA (the *Pontus Euxinus*, or 'hospitable sea,' of the ancients, the Kara Deniz of the Turks, the Mauri Thalassa of the modern Greeks, and the Tschernoje Moré of the Russians) is an inland sea lying between Europe and Asia, extending from lat. 40° 45' to 46° 45' N., and from long. 27° 30' to 41° 50' E. In shape it bears a certain resemblance to the human foot. Its greatest length from east to west, on the 42d parallel, is about 700 miles, and its greatest breadth, near the west end, about 380 miles. Area, 172,000 square miles. On the south-western extremity it communicates by the Bosphorus, the Sea of Marmora, and the Dardanelles, with the Mediterranean, and on the north-east by the Straits of Yenikale with the Sea of Azof. The B. S. drains nearly one-fourth of the surface of Europe, and also about 100,000 square miles of Asia. Throughout its whole extent it has but one island, and that a small one, lying opposite the mouths of the Danube, called *Adassi*, or Isle of Serpents, on which is a light-house. The continued occupation of this island by the Russians, in defiance of the stipulations of the treaty signed at Paris after the termination of the Crimean war, occasioned considerable uneasiness in Turkey, and detained a British fleet in the B. S. for several months. In the centre of the B. S. there are no soundings at 150 fathoms, nor are there shoals along the shores, except at the entrance of the Bosphorus; the navigation of the B. S. ought, therefore, to be particularly easy and safe. It is so in summer; but in winter, being enclosed on every side, it becomes the scene of conflicting winds, and of storms which, though of

short duration, are terrible while they last. Such a storm it was on the 14th of November 1854, in which about forty vessels of the allies were either totally wrecked or very seriously injured, nearly 1000 lives were lost, and property worth some millions destroyed.

All the coasts are high, with good harbours, except between the mouths of the Danube and the Crimea; there the land is low, and the danger of navigation greatly increased in winter by the presence of floating ice; for, from the many large rivers which flow into the B. S. and Sea of Azof (Danube, Dniester, Bug, Dnieper, Don, and Kuban, in Europe; and the Kizil-Irmak and Sakara in Asia), the waters are fresher, and consequently more easily frozen than those of the Mediterranean. The specific gravity of the water of the B. S. is 1014 (water being = 1000), while that of the Mediterranean is 1028. The shores from Odessa to the Crimea are ice-bound during January and February; and although the harbour of Odessa is never frozen up, yet the drift-ice frequently renders the entrance to it dangerous.

There is no tide in the B. S., but the large rivers flowing into it give rise to currents, which are particularly strong in spring when the snows melt, and the accumulated moisture of the whole winter is drained off the land. The great current which, passing out of the Sea of Azof round the Crimea, flows first in a south-westerly, then in a north-westerly direction, and again due west, is turned southwards by a current from the Dnieper and Dniester; the two currents are afterwards met by another from the Danube, and then, all united, rush towards the Bosphorus. The Bosphorus, however, is not wide enough to admit the entire volume of water pressing into it; and a portion of the main current is consequently diverted to the coast of Asia, where it is strengthened by new accessions. This, which is the normal course of the currents in the B. S., is modified by the winds, and by local circumstances. In some bays of Roumelia and Bulgaria counter-currents have been observed.

The most important ports on the B. S. are those of Odessa, Kherson, Eupatoria, Sebastopol, Batum, Trebizond, Samsun, Sinope, Varna, &c.

The depth of the water is unfavourable to the extensive establishment of fisheries, but several kinds of sturgeon are caught in considerable quantities in the straits of Yenikale. Other fish of various kinds are said to be abundant.

The ancients believed that the B. S. was at one time much more extensive, and that it had no connection with the Mediterranean. They accounted for its decrease and communication with the larger sea by the supposition that the Thracian Bosphorus had been burst through by an earthquake, or by the great deluge known as the Deucalion deluge, which inundated Greece. The B. S. being higher than the Mediterranean, the latter, of course, through the newly created channel, became the basin for much of its waters. Certain geological and other appearances have led some modern geographers to entertain an opinion similar to that of the old Greeks, which, however, is not shared in by others.

The B. S. has been navigated from a very early period. Its original name (supposed to have arisen from the dangers such an expanse of sea offered to early navigation, as well as from the fact that savage tribes dwelt upon its coasts) was *Axine*, or 'inhospitable' sea, afterwards changed by the Greeks to *Euxinus*. In the time of Xerxes, large quantities of corn were exported from its ports to Athens and the Peloponnesus. The Romans and Byzantine emperors, and also the Genoese, had large traffic on the Black Sea. When the Turks captured

Constantinople, all but their own ships were excluded from its waters until the treaty of Kinarji, 1774, when the Russians obtained the right to trade in it. Ten years after, Austrian ships were privileged to trade here; and by the Peace of Amiens, in 1802, British and French ships were admitted. The undue preponderance of Russia in the B. S. was the main cause of the Crimean war.

BLACK SNAKE (*Coluber constrictor*, see COLUBER), a species of snake common in the United States of America from Louisiana to Connecticut. It is of an almost uniform leaden colour, is one of the largest serpents in North America, and is remarkable for its great agility. It moves along the ground with a swiftness equal to that of a horse, glides over bushes, and climbs trees. It feeds on small quadrupeds, birds, frogs, &c.; frequently plunders poultry-yards of eggs; and enters dairies to drink milk or cream, of which it is very fond, but compensates for these depredations by killing rats and mice. It has no poison-fangs, but is not slow to bite. It is very capable of domestication.

BLACKSTONE, SIR WILLIAM, a commentator on English law, was the posthumous son of a silkmonger in London, and was born there on the 10th of July 1723. At the age of 15, having obtained a scholarship from the Charterhouse school, where he was educated, he was sent to Pembroke Hall, Oxford. There he was fortunate enough to obtain a second scholarship, and remained till, in 1744, he was admitted a fellow of All Soul's College, when he removed to London, to attend the courts of law with the view of qualifying himself for his future profession. In 1746, at the age of 23, he was called to the bar, but failed to attract either notice or practice. Upon the death of an uncle in 1749, he was appointed recorder of Wallingford, in Berkshire; but in 1753 he went to Oxford, where he delivered a course of academic lectures upon the law of England. A few years later, a Mr Viner having left a sum of money to endow a chair of English law in the university of Oxford, B. was, in 1758, appointed first Vinerian professor. The following year, B. returned to Westminster; and as the doctrines which he had taught as a lecturer had been such as to commend him to the notice of the Tory government of that day, he obtained its patronage, and in 1761 was made a king's counsel. Shortly after, he was appointed principal of New Inn Hall, Oxford. Other honours followed fast, and he became successively member of parliament, bencher of the Middle Temple, and solicitor-general to the Queen. In 1765, B. published the first volume of his lectures, and the remaining three volumes between that date and 1769. These lectures form his celebrated *Commentaries on the Laws of England*. His practice continuing to increase, he resigned, in 1766, his Oxford appointments. Four years later, he was offered the solicitor-generalship, and after declining it, was knighted, and made a justice of the Court of Common Pleas. The remaining years of his life were spent in the discharge of his duties as a judge. He died on the 14th of February 1780, at the age of fifty-seven.

The fame of B. rests entirely upon his *Commentaries*. His other literary works were inconsiderable, and his merits as a pleader or judge were not such as, of themselves, to have made his reputation outlive himself. As a commentator, he had many excellences. His style was in general clear and gracefully ornate, and his illustrations pleasing and felicitous. While he confined himself to exposition—to the accurate statement in scholarlike English of what had heretofore lain buried in the cumbersome language of lawyers like

Littleton—B. was unsurpassed, and rendered an important service to the country. But he was ambitious of combining with this exposition the higher task of explaining the reasons for the law, as well as its merits and defects. For this survey of the law, from the legislator's point of view, he had not the requisite qualifications. His knowledge of English history was, as Hallam tells us, superficial, and his study of the philosophy of law had been imperfect. With the works, indeed, of Montesquieu and Beccaria he was acquainted; but the mode in which he quotes them shews that he had imbibed nothing of their spirit. The method followed in the *Commentaries* was as unscientific as could be imagined, and had not even the merit of originality. It was taken, with little alteration and no improvement, from Sir Matthew Hale's *Analysis of the English Law*. Possibly the haste with which the *Commentaries* must have been composed, being originally in the form of lectures, may have led to some of their imperfections. Since B.'s death, the *Commentaries* have been very frequently reprinted, perhaps the best editions being those of Christian. As a century has elapsed since they were composed, so many alterations are requisite to adapt them to the existing state of the law, that it may be said that their purpose has been served, and that they are now valuable chiefly as materials for history.

BLACK STONE EXAMINATION. See GLASGOW UNIVERSITY.

BLACK WAD is a name given by miners to the native black oxide of manganese, and principally to an impure and earthy variety of the ore. See MANGANESE.

BLACKWALL, a suburb of London, in Middlesex, at the junction of the Lee with the Thames, 4 miles east-south-east of the metropolis. Pop. in 1851, 28,384. It has foundries, ship-building yards, and the East and West India Docks. A railway, four miles long, mostly on a brick viaduct above the streets, connects B. with the city of London. To avoid the dangers and delay of the 'Pool,' many passengers proceed by this railway to embark in steamers at B., instead of going on board at London Bridge.

BLACK WARRIOR, a river formed, in the north of Alabama, by the junction of the Mulberry and the Locust. Almost from the very point of confluence it is navigable for steam-boats, till, after a course of more than 150 miles, it enters the Tombigbee, which, again, is navigable for large vessels all the way to Mobile on the Gulf of Mexico, a stretch of nearly 200 miles more. Its banks yield coal, iron, and other valuable minerals.

BLACK WATCH, the appellation given to certain armed companies employed to watch the Highlands of Scotland. The term *black* arose from the dress of this species of militia, which was composed of tartans of dark colours. Some Highlanders had been armed by government as early as 1725, when General Wade was appointed commander-in-chief in Scotland; but it was not till about 1729 or 1730 that the companies assumed a regular form. The companies were six in number—three comprising 100 men each, commanded by a captain; and three of 70 men each, commanded by captain-lieutenants. Stationed in different parts of the Highlands, and acting independently of each other, they were styled the Independent Companies of the Black Watch. The body was raised chiefly from the Whig or loyal clans—Campbells, Grants, Munros, &c.—and many men of good station in society joined it, not only for the sake of good pay, but the valued privilege of bearing arms. The

duties of the B. W. were to enforce the disarming act, to overawe the disaffected, to prevent political meetings of a seditious kind, and to check depredations among the clans, or on the Lowland frontier. After being of considerable use for these local purposes, the whole of the companies were formed into the 42d Regiment, under the command of the Earl of Crawford, in 1739—their removal giving facility, no doubt, for the outbreak of the rebellion in 1745. Retaining its original Highland character, the 42d Regiment became one of the most distinguished corps in the British army; the whole of its history, for which we would refer to the work of Colonel Stewart on Highland Regiments, being a series of brilliant achievements. Embodied under the Earl of Crawford, the regiment would have adopted the tartan of that nobleman, if he had possessed such a cognizance; the earl, however, being a Lowlander, it was necessary to adopt an arbitrary pattern of tartan, which has ever since been known as the 42d or B. W. tartan. See TARTAN.

BLA'CK-WATER, a disease in cattle. See DARN.

BLA'CKWATER, the name of five Irish rivers, two of which deserve notice.—1. The B. of Cork county rises in the west of Kerry county; runs east across Cork county and the west part of Waterford county, in a carboniferous limestone basin, past Millstreet, Mallow, Fermoy, Lismore, and Cappoquin, and enters the sea at Youghal harbour. High mountains bound it on the south, and its chief feeders come from the north. It has a course of 100 miles, and is the seventh in size of the Irish rivers. The scenery along its banks is highly beautiful and picturesque, with ruins, mansions, and woods. It is navigable for barges for the last 15 miles of its course. It abounds in salmon.—2. The B. of Ulster rises on the confines of Tyrone and Fermanagh counties; runs first south-east, and then north-west through Tyrone; and then between Tyrone, Monaghan, and Armagh, past Caledon and Charlemont, and falls into the south-west corner of Lough Neagh.

BLACKWELL, ELIZABETH, M.D., a medical practitioner in New York, U.S.—the first woman that ever obtained a medical diploma—was born at Bristol, where her father carried on an extensive business as a sugar-refiner, in the year 1821. Circumstances afterwards induced the family to emigrate to New York, and then to push west to Cincinnati, where in 1838 the father died, leaving a widow and family of nine children but scantily provided for. Miss B., who was at this time in her 18th year, and who had already been distinguished by unusual decision of character, immediately, along with two elder sisters, opened a boarding-school, which soon gained a reputation, and had a large attendance. But the spirit of Miss B. chafed at the limitations which society had imposed on the energies of women, and she often took counsel with her sisters as to the practicability of storming the learned professions, and thus enlarging woman's sphere. At length, in 1844, the school was given up, Miss B. determining to become the medical apostle of her sex. After three years' further work as a salaried teacher, which she undertook in order that she might have the pecuniary means wherewith to prosecute her medical studies, and during which time she devoted the whole of her leisure to the study of medical and anatomical books, she went to Philadelphia, where she applied in vain for admission into the medical schools. Failing this, she entered on a course of private anatomical study and dissection and of midwifery with Professor Allen and Dr Warrington of Philadelphia. After strenuous efforts, she at last obtained admission to a university—that of Geneva, in New

York State—and thither she accordingly repaired in the November of 1847. Here she remained until January 1849, when she graduated with the highest honour. During the two years of her study, she conducted herself with a propriety and discretion that gained for her the esteem and respect of all her fellow-students. Only once was an insult offered to her. It was in the class-room, and she repelled it with so quiet a dignity as to bring down the applause of the students on herself, and their hisses on her despicable assailant. Her presence had a beneficial effect upon the students; her 'brilliant example,' as the president called it, had stimulated them to greater effort, and their general conduct and attainments during the sessions she was at college were better than usual. Shortly after her graduation, Miss B. visited Europe, in order to the further prosecution of her medical studies. At Paris she was told that it would be impossible for her to gain entrance to the schools or hospitals there, unless she adopted male attire; a suggestion which she refused to act on, as it was alike repugnant to her taste, and to the great object she had in view—viz., the recognition of female doctors. After much perseverance, she was at length admitted into the extensive lying-in hospital of the *Maternité*, and was permitted to visit other hospitals. After studying at St Bartholomew's Hospital, and the Woman's Hospital, London, she returned to New York in 1851, and there established herself in practice. At first difficulties were thrown in her way by physicians of the opposite sex refusing to meet her in consultation; but these were soon overcome, and Miss B. is now established in excellent practice. In 1852, she delivered a series of lectures to ladies on health and physical development; in the following year she published a work, entitled *The Laws of Life, considered with Reference to the Physical Education of Girls*, and also established a dispensary for women and children, which proved so successful that she was induced, in 1857, to open a small hospital for women. Miss B.'s sister, now Dr Emily B., has followed in the footsteps of Elizabeth.

BLACKWELL, ALEXANDER, a physician of great natural genius, son of the Rev. Thomas B., one of the ministers of Aberdeen and Principal of Marischal College, was born in that city in the beginning of the 18th c. He studied physic under Boerhaave at Leyden, where he took the degree of M.D. He was afterwards a printer in London, but becoming bankrupt in 1734, was supported in prison by his wife, who prepared and published a *Herbal* (2 vols. folio, 1737—1739) with 500 cuts of plants, drawn, engraved, and coloured by herself, her husband adding their Latin names, with a brief description of each. The work, patronised by the College of Physicians, met with great success, and B. obtained his release. A work on Agriculture, published by him, falling under the notice of the king of Sweden, B. was invited to Stockholm in 1740, and received apartments in the house of the prime minister, with a pension. Having cured the king of a dangerous illness, he was appointed one of the royal physicians; but while in the full enjoyment of court favour, he was charged with being concerned in a plot with Count Tessin against the king and government, and after being subjected to the torture, was broken on the wheel, August 9, 1748, protesting his innocence to the last. A genus of plants, *Blackwellia*, is named in honour of Mrs Blackwell.

BLACKWELL, THOMAS, a scholar of some eminence, brother of Alexander B. (q. v.), born at Aberdeen, August 4, 1701, studied Greek and philosophy in Marischal College, and took the degree of M.A.

in 1718. In December 1723, he was appointed professor of Greek in Marischal College, and in 1737 published anonymously at London an *Inquiry into the Life and Writings of Homer*, 8vo, 2d edition, 1746, and shortly afterwards, *Proofs of the Inquiry into Homer's Life and Writings*. In 1748 he published, also anonymously, *Letters concerning Mythology*, 8vo. The same year he was made principal of Marischal College; and at the commencement of the session 1752, on his recommendation, a new order in teaching the sciences was introduced into the college. In 1753 he published the first volume of his *Memoirs of the Court of Augustus*, 4to. The second volume appeared in 1755; and the third, left unfinished by him, was completed by John Mills in 1764. He died March 8, 1757. A chemical professorship was founded by his widow in Marischal College in 1793, and also a biennial award of £20 (the 'Blackwell Prize'), open to any one, for the best essay on a subject proposed by the principal and professors of Marischal College.

BLACKWOOD, WILLIAM, a distinguished Edinburgh publisher, the originator of *Blackwood's Magazine*, was born in Edinburgh, November 20, 1776. After serving his apprenticeship to the book-selling business in his native city, and prosecuting his calling in Glasgow and London, he settled in Edinburgh as a bookseller—principally of old books—in 1804. In 1817, at which time he had become a publisher on his own account, he issued the first number of *Blackwood's Magazine*. The literary ability displayed in this periodical was so much in advance of the monthly magazines then existing, that from the first it was a great success. Its remarkable popularity was sustained by the papers of John Wilson (q. v.) and J. G. Lockhart (q. v.), also of James Hogg (q. v.), and other spirits, whom B. had the liberality and tact to attract to his standard. Overwhelming its political and literary opponents, now with the most farcical humour, and now with the bitterest sarcasm—sometimes with reckless injustice—the Magazine secured for itself a prodigious reputation, more particularly among the Tories, of whose political creed it has always been a resolute adherent. We believe it can hardly be said that *Blackwood's Magazine* has ever had any distinct editor. William Blackwood himself, who added literary tastes and acquirements to his profession of a bookseller, was the chief manager of his Magazine, and conducted the whole of the correspondence connected with it until his death, which took place September 16, 1834. Under his sons, the Messrs B., who succeeded him in the business, *Maga* has not only sustained but increased its reputation; the places of its old contributors are supplied by many of the most distinguished men of letters in the country. In the conduct of the Magazine, Mr W. E. Aytoun is understood to occupy a position in relation to the publishers somewhat analogous to that which Wilson held under their father. The publishing business, which includes that of printing the works issued, has been greatly extended by the Messrs B., who have now a name second to none in the kingdom.

BLACKWOOD RIVER, in West Australia, enters the Hardy Inlet, 6 miles to the north-east of Augusta, in lat. 34° 14' S., and long. 115° 12' E. It flows through the counties Durham and Nelson, first to the west, and then to the south, traversing a district of wood and pasturage. It is navigable for boats to a distance of 20 miles from the sea.

BLADDER (urinary) is a bag formed of fibrous membrane externally, muscular fibres in the middle, and mucous membrane for an internal lining. The peritoneum (see ABDOMEN) covers its back. The

shape of the B. is somewhat conical, the apex being upwards, and the anterior part of the base constricted at the commencement of the urethra, called the neck of the bladder. On each side, rather below its middle, open the two ducts from the kidneys (the ureters); an imaginary line drawn between them, and from each end of this line others drawn to the neck of the bladder include an equilateral triangle. In this space, which is called the *trigone*, the mucous membrane is not thrown into folds, but is smooth and very sensitive, the slightest touch upon it giving rise to a desire for micturition. The habit of some children to empty their bladders when sleeping on their backs, is supposed to be due to the urine accumulating in this part, as is also the distressing pain of stone.

The B. is situated in the pelvis in adults, but much higher in the young. It is kept in position by four true or membranous ligaments, and false ligaments formed of folds of the peritoneum. The neck of the B. is surrounded by the prostate gland, and here the urethra (q. v.) begins. Like all cavities lined by mucous membrane, the B. is subject to catarrhal inflammations, which are accompanied by an increased secretion of mucus, rendering the urine turbid, frequent and painful desire to micturate, and very great constitutional disturbance. The symptoms may be acute, and must be relieved by local bleeding, and hot fomentations along with opiates; or they may be chronic, when some medicines, as the *Uva-ursi* (see ARBUTUS), bucku (q. v.), the preparations of iron, and the mineral acids, are found useful. If there is much mucus, or decomposed urine in the B., it may be washed out with warm water, in which a minute quantity of nitric acid has been dropped. Of course, if there is any known cause for this inflammation, as a stone, it must be removed.

Irritable B. resembles the former disease, but is produced by various causes unaccompanied by inflammation. Some persons, from mere nervousness, are frequently troubled with a desire to pass water; and strange as it may seem, many in this condition never effectually empty their bladders, always leaving a portion, which keeps up the irritation. This condition frequently arises from the habit of retaining the urine so long as to over-distend and weaken the muscular walls of the B.; but it may be induced by general debility, the irritation of worms, cold, or an irritating state of the urine itself. The best treatment is tonics, and soothing the irritability with sedatives. When this irritability is nocturnal, it may be from the patient lying on the back, as explained above; it generally occurs in delicate children, and is more a habit than a disease.

Paralysis of the B. may be the result of accident, or disease of the nervous centres, or over-distension; in this condition the urine accumulates and dribbles away, and must be drawn off by the catheter (q. v.). This dribbling, or *incontinence*, must be carefully distinguished from irritable B., as it is in nearly every case the sign of a distended bladder. *Retention* of the urine may be caused by mechanical obstacles to its exit, by paralysis, or by an absence of volitional power over the muscles. This last is termed *Hysterical retention*, and is common in young girls, in persons suffering from sea-sickness, from being in a strange place, an accident, such as a broken leg, &c. If the affection is not encouraged by an officious use of the catheter, the power generally soon returns. Any long continued difficulty in passing water is generally followed by a thickening of the walls of the B. itself, or *Hypertrophy*. The mucous membrane may form pouches in these thickened walls, which is called *Sacculated B.*, and

cancerous diseases, and tubercle, may also attack this organ.

The B. is liable to be ruptured by accident from without, as, for instance, by a blow or hurt from a saddle; and as this accident is usually fatal, it cannot be too carefully guarded against. If the B. is ruptured posteriorly, the accident is always fatal.

BLADDER CAMPION. See **SILENE**.

BLADDER GREEN. See **BUCKTHORN**.

BLADDER-NUT (*Staphylea*), a genus of plants which, according to some botanists, is the type of a small natural order, *Staphyleaceae*, by others, united with *Celastraceae*. See **SPINDLE TREE**. The *Staphyleaceae* have usually opposite pinnate leaves, the leaflets of which, as well as the leaves themselves, have deciduous stipules. The sepals, petals, and stamens are equal (five) in number. Only about fourteen species are known, which are found in very different climates, and scattered over the world. They are mostly small trees of rather elegant appearance. The seeds contain a considerable quantity of a fixed oil, which is slightly purgative. The common B. (*Staphylea pinnata*) is a native of the east of Europe, and of temperate parts of Asia, which has been admitted into the British flora, but has in all probability been introduced as an ornamental tree. It is frequently planted in shrubberies, as is also *S. trifolia*, a North American species with ternate

for the expansion of their flowers above water, although the whole plant is ordinarily submerged. The roots, stems, and even leaves, are furnished with numerous little bladders or vesicles, which are filled with water till it is necessary that the plant should rise for the expansion of the flowers, when they become filled with air; and this again gives place to water after flowering is over, so that the seeds are ripened at the bottom. The bladders, at least of *U. vulgaris*, have an orifice closed by a very thin elastic valve opening inwards. Aquatic insects sometimes enter them, and are imprisoned.

BLADENSBURG, a post-town of Maryland, on the east branch of the Potomac, and on the Washington and Baltimore Railway. It is six miles to the north-east of Washington; and it was here that the battle which decided the fate of that city was won by the British on the 24th August 1814.

BLAEBERRY. See **WHORTLEBERRY**.

BLAES, a Scottish colliers' name for the shale of the coal-measures, originating apparently from the 'blae' or bluish colour sometimes noticed in the shale. The term is occasionally used by geologists.

BLAEU, also **BLAEUW** and **BLAUW** (Lat. *Cesius*), the name of a family of learned Dutch publishers who have rendered as important services to literature and art as Aldus, Giunti, Stephanus, or Elzevir, and whose activity spread itself over Europe for a century.

BLAEU, WILH., a mathematician, map-drawer, and publisher, was born at Alkmaar, in Holland, in 1571. He belonged to the school of Tycho Brahe, and secured a considerable reputation by publishing a Terrestrial and a Celestial Globe, excelling in beauty and accuracy everything that had preceded them; and also several maps, which indicated a comparatively precise knowledge of geography. As a printer, he did not attain the elegance and completeness of Elzevir, but nevertheless his chief publications are marked by a fine external finish, and a praiseworthy correctness. He died 21st October 1638, and left two sons, John and Cornelius, who carried on the business together until the death of the latter in 1650.

BLAEU, JOH., the son of the preceding, was born at Amsterdam about the beginning of the 17th c. He commenced business on his own account at Amsterdam, but afterwards entered into company with his father. His *Atlas Major*, in eleven volumes of the size in which atlases are published at the present day, is a splendid work. It is full of archæological and geographical information, supplied for each country by men of eminence connected with it. There are many curious plates—among them a representation of Tycho in his observatory—and the maps are extremely valuable from the light they throw on local history. Besides this, he published a series of singularly rich topographical plates and views of towns, which are consulted even to the present day. He died about 1680, leaving three sons, Joh., Wilh., and Peter, the second of whom became a member of the Amsterdam council, while the other two carried on with distinction and success the paternal business. Some of their classical publications, especially Cicero's *Orationes* (1699), are still highly prized.

BLAINVILLE, HENRI MARIE DUCROTAY DE, a distinguished French zoologist and anatomist, was born 12th September 1778, at Arques, near Dieppe. At an early period, he went to Paris, where he devoted himself to the study of medicine and the physical sciences, and took the degree of doctor in 1808. Through Cuvier chiefly, he was induced to study natural history and comparative anatomy. In 1812, he was appointed assistant-professor of



Bladder-nut (*Staphylea pinnata*):
a, a branch with leaves and raceme; b, fruit.

leaves. The wood of both is firm and white, well suited for the purposes of the turner. The seeds may be eaten, but act as a mild aperient. The flower-buds are pickled as capers. The name B. has reference to the curious inflated membranous capsule, and the hard bony *testa* of the seed. The name *Staphylea* is from the Greek *staphylé*, a bunch of grapes, and has reference to the racemed flowers.

BLADDERWORT (*Utricularia*), a genus of plants of the natural order *Lentibulariaceae* (q. v.), containing a large number of species, the bright blossoms of which, along with those of water-lilies, &c., adorn the surface of lakes, ditches, and marshes in almost all parts of the world. They are particularly abundant within the tropics, and many are natives of Australia. Britain produces only three species, all of which have yellow flowers. These plants are very interesting from the provision made

Comparative Zoology, Anatomy, and Physiology, in the university of Paris, as well as Professor of Natural History at the Athenæum; in 1825, a member of the Institute; and in 1832, successor of Cuvier in the chair of Comparative Anatomy in the Museum of Natural History. He died May 1, 1850. B. achieved great success, not only as a teacher, but as an author. Besides various small treatises which appeared in scientific journals, he published many large and valuable works, all of which have greatly advanced our knowledge of the various sciences they treat of; such as *Faune Française* (1821—1830), *De l'Organisation des Animaux* (1822), *Cours de Physiologie Générale et Comparée* (1833), *Ostéographie* (1839—1849), *Manuel de Malacologie et de Conchyliologie* (1825—1827), *Manuel d'Actinologie et de Zoophytologie* (1834—1837).

BLAIR, HUGH, an eminent Scotch divine and man of letters, was born at Edinburgh, April 7, 1718. He entered the university of his native city in 1730, where he soon became noted for his diligence; and an *Essay on the Beautiful*, which he wrote when a student, gave his preceptors a high idea of his ability and taste. In October 1741, B. was licensed as a preacher of the Established Church; and after occupying successively the churches of Colesie in Fifeshire, Scongate Church in Edinburgh, and Lady Yester's, he was promoted in 1758 to the highest position attainable by a Scotch clergyman—one of the charges of the High Church, Edinburgh. His discourses, which display little power or originality of thought, and which derived nothing from the delivery of their author, were greatly admired by 'persons of the most distinguished character and eminent rank' in Scotland on account of their polished style. In 1759, B. commenced a series of lectures on *Composition* to classes in the university; and three years afterwards, a new chair of Rhetoric and Belles-lettres, with a salary of £70 a year, being created by the crown, B. was made professor. He held this appointment until 1783, when he resigned; and in the same year published his *Lectures*, which obtained a reputation far beyond their merits, and one that time has by no means sanctioned. His first volume of *Sermons* appeared in 1777, with the approval of Dr Johnson, who had read them, and proved a great success. George III. shewed his appreciation of them by bestowing on B., in 1780, a pension of £200 a year. B. also published three other volumes of *Sermons*, and prepared a fourth, which was printed after his death, which took place December 27, 1799. They were all as successful as the first one. Opinion about their merits has much changed since the date of their publication; they are now considered as moral essays rather than sermons. B.'s critical acumen was not great; he believed in the authenticity of Ossian's poems, which he strenuously defended.

BLAIR, ROBERT, author of *The Grave*, was born at Edinburgh, where his father was a clergyman, in 1699. After completing his education for the church, and travelling on the continent, he received licence, and in 1731 was ordained minister of Athelstaneford, Haddingtonshire, where he lived in easy circumstances till his death, in 1746. He was an accomplished and thoughtful man, devoted considerable attention to natural science, particularly botany, and corresponded on friendly terms with several eminent contemporaries, among others, Watts and Doddrige. To them he submitted the MS. of his poem, which he had written before his ordination. Watts offered it to two publishers, who thought it too heavy for the times, and it remained several years unprinted. It afterwards attained an honourable

place in the esteem of those capable of appreciating a masculine, though somewhat gloomy force of thought and imagery, applied to a profoundly suggestive and serious theme. It found a congenial illustrator in William Blake (q. v.). B. was succeeded in his ministerial charge by the author of *Douglas*. His son, Robert Blair, of Avontoun, became Lord President of the Court of Session.

BLAIR-A'THOL, a village in the county of Perth, Scotland, situated at the confluence of the Tilt and Garry, about 30 miles north-north-west of the city of Perth. Blair Castle, the seat of the Duke of Athol, is situated here. The larch-trees surrounding it are remarkable alike for their enormous size, and for the fact of their being among the first planted in Scotland.

BLAIR-GOW'RIE, a village in Perthshire, very picturesquely situated on the east side of a range of hills, on the right bank of the Erich, 16 miles north-north-east of Perth. It consists chiefly of one winding street. Pop. in 1851, 2194. It has flax-spinning and weaving factories, driven by the Erich, and employing 700 to 800 hands. Pure white marble is found in the vicinity.

BLAKE, ROBERT, a celebrated English admiral, who, more than any other, contributed to render England mistress of the sea, was born at Bridgewater, in Somersetshire, where his father was a merchant, in 1598. An ardent republican, and a man of blunt, straightforward manners, singularly devoid of fear, and of inflexible character, he was much respected by Cromwell, with whom, however, he had no very intimate intercourse. When the civil war broke out, he raised a troop in Somersetshire, and took part in all important actions fought against the royalists in the western counties. In 1644, he surprised Taunton, of which place he was made governor, and in that capacity gave proof of no mean military skill. In 1649, in conjunction with two other officers of equal rank, he was appointed General of the Sea, the two services at that time not being distinct, as they are now. This was B.'s true sphere, and in it he soon exhibited transcendent ability. After destroying, with the exception of two vessels, the squadron of Prince Rupert, which had sought safety in the Tagus in 1651, B. forced the royalists to surrender Guernsey, Jersey, and the Scilly Isles. In March 1652, he was made sole admiral of the fleet for nine months, and during this year he fought four engagements with Dutch fleets under Tromp, Ruyter, and De Witt. In the first, on the 19th May, the Dutch retreated under cover of darkness, with the loss of one man-of-war captured, and another sunk. In the next engagement, a squadron of 12 ships, sent to protect the herring-vessels from the attacks of B., were captured; and in the third, on the 28th September, 3 Dutch vessels were destroyed, and the rear-admiral taken. On the 29th November, a fleet of 80 vessels, under the command of Van Tromp, encountered B. with only 40 off the Goodwin Sands. The courageous Englishman scorned to fly even from odds so overwhelming, and the result of the action was the loss of 6 of his ships—2 captured, and 4 destroyed; the rest, in a shattered condition, sought safety in the Thames. Van Tromp now had recourse to that foolish act of bravado with which his name is associated; he tied a broom to the mast-head of his vessel, and sailed through the Channel, thus intimating that he had swept English vessels clean out of it. Tromp little knew the indomitable character of B., or of the nation of which he was the worthy representative on the seas. By February 1653, B. was at sea again with 80 ships, and falling in with Van Tromp with about an

equal force, he at once attacked him, and after a three days' running-fight, the Dutchman was fain to seek shelter in the shallow waters of Calais—where the greater draught of the English ships did not admit of their following—with a loss of 11 men-of-war, and 30 of a fleet of merchantmen he had in convoy. The English lost only one ship. On the 3d and 4th of June, B. and his coadjutors, Deane and Monk, won another victory over Van Tromp; but ill-health prevented B. from taking part in the engagement of the 29th July, which finally shattered the naval supremacy of Holland. In 1654, B. was appointed by Cromwell to command an English fleet in the Mediterranean, where he soon made the British flag respected by Dutch, Spanish, and French alike. The Dey of Tunis refused to do it reverence. B. attacked his capital, burned the Turkish fleet of nine ships which lay before it, accomplished a landing, and with a body of about 1000 men, annihilated an army of 3000 Turks. He next sailed to Algiers and Tripoli, landed, and set free all the English who were detained as slaves. He concluded alliances highly favourable to England with Venice and Tuscany. In 1657, he defeated the Spaniards at Santa Cruz. This was perhaps one of the most daring actions in B.'s memorable career. With a wind blowing right into the bay—which was very strongly defended—B. dashed in, attacked and destroyed the Spanish galleons and shipping in the harbour, and, the wind fortunately changing, sailed out again with a loss of only one ship and 200 men. The Spanish loss in men and property was immense, and the terror the action inspired insured increased respect to the English flag. His health now failed; he returned to England, and died, as his ship entered the harbour of Plymouth, in the year 1657. Cromwell honoured his memory by a solemn funeral procession, and caused him to be interred in Westminster Abbey. His skill and courage were equalled only by his disinterested patriotism, sterling honesty, and love of justice; he not only gained a decided superiority over England's mightiest naval opponent, but, by the bold tactics he introduced, infused that intrepidity and spirit of enterprise by which the British navy has ever since been distinguished.

BLAKE, WILLIAM, a celebrated engraver and poet, was born in London, 1757. In 1789, he published *Songs of Innocence and of Experience, shewing the Two Contrary States of the Human Soul*, with about 60 etchings, remarkable for their peculiar and original manner. The poems were equally singular, but many of them exhibited true pathos. Some marginal designs for Young's *Night Thoughts*, executed by B., were greatly admired by Flaxman. B. lived in the full belief that he held converse with the spirits of the departed great—among others, with those of Moses, Homer, Virgil, Dante, and Milton, and that some of these spirits came to him to have their portraits taken! He published numerous etchings, chiefly of religious and cognate subjects, among the best of which are his *Illustrations of the Book of Job*, and the illustrations of Blair's *Grave*. He died (August 12, 1828) in poverty and obscurity, with the conviction that he was a martyr to poetic art. Charles Lamb regarded him as 'one of the most extraordinary persons of the age;' and Mrs Jameson, in her *Sacred and Legendary Art*, speaks of his conception of angels in the highest terms of praise.

BLANC, LE, a town of France, in the department of the Indre, with a beautiful situation on the Creuse, which divides the town into two parts, about 32 miles west-south-west of Châteauroux. Above B., the river expands so as to form a lake, but at

the town it contracts, and breaks into cascades with sufficient fall to turn the machinery of several manufactories. B. is a thriving place, with cloth and linen yarn mills, potteries, tanneries, vinegar-works, forges, &c. It is very ancient, having been frequented by the Romans. Pop. about 5000.

BLANC, MONT. See MONT BLANC.

BLANC, JEAN JOSEPH LOUIS, a celebrated French Socialist and historian, was born at Madrid, 28th October 1813. In 1820, he was placed in the college at Rhodéz; in 1830, he went to Paris, and became a clerk in an attorney's office for a short time; but in 1832 he was intrusted with the education of the son of M. Hallette, mechanic of Arras. Here he resided for two years, contributing largely, on literary and political subjects, to the *Progrès du Pas-de-Calais*. He afterwards went to Paris, where he contributed to various political papers, and where in 1838 he founded the *Revue du Progrès Politique, Social et Littéraire*, in which he laid down in a more quiet and leisurely way his Socialistic theory. In this he brought out his chief work on Socialism, the *Organisation du Travail*, which, in 1840, appeared in a separate form. The book obtained for its author a wide, enthusiastic popularity among the French *ouvriers*, who were captivated by the brilliancy of the writing, the symmetrical simplicity of the scheme, and the freshness of the views advocated. The book denounces the doctrine of individualism—i. e., individual and competitive efforts in labour—and advocates the absorption of the individual in a vast 'solidarity,' where 'each would receive according to his needs, and contribute according to his abilities.' B. next published (in 1841—1844) a historical work, entitled *Révolution Française: Histoire de Dix Ans, 1830—1840*, which produced a deadly effect on the Orleans dynasty. Louis Philippe afterwards declared that 'it acted like a battering-ram against the bulwarks of loyalty in France.' It owed its success partly to the exposure it gave of the scandalous jobbery and immorality of the crown and its advisers, partly to that passionate ardour which changed the tranquillity of history into the vehemence of a pamphlet, and partly to its academic pomp of style. This was followed by the first volume of a *Histoire de la Révolution Française*, in which the author's aim is not only to describe, from his own point of view, the incidents of the first revolution, but the social history of the 18th c. On the breaking out of the February revolution of 1848, B. seemed likely to play an important part. His connection with the party of the *Réforme* journal, and his popularity with the working-classes, led to his being appointed a member of the Provisional Government. He was placed by government at the head of the great commission for discussing the problem of labour. At the same time, Marie, Minister of Public Works, began—but without B.'s co-operation—to establish the so-called national workshops, which were to bring about the realisation of the Socialistic principle, but which only proved the hazardous and impracticable character of B.'s doctrines. The national workshops led to the arrest of the 15th May 1848, when B. nominally, if not actually, again played a prominent part. A proposal was made to prosecute him, but it was negated by the National Assembly. After the June insurrection, he was again accused, and prosecuted for conspiracy, but contrived to escape to London, where he still resides. During his exile, he has devoted himself to political and historical literature. In 1849 appeared his *Appel aux Honnêtes Gens*, and *Catéchisme des Socialistes*; in 1850, *Pages d'Histoire de la Révolution de Février*; and in 1851, *Plus de Girondins; la République Une*

et Indivisible. The work which is likely to secure him the most enduring reputation, is his *History of the French Revolution*. It is characterised by extensive and original research, which has frequently enabled the author to reverse the common verdicts on historical personages, and to explode many of the extravagant stories of the stormy period of which it treats. In style, it is eloquent, bold, and dignified; and if its sentiments do not always commend themselves to the sober judgment of English readers, there can be but one opinion in regard to its candour, impartiality, and power. It is intended to consist of 12 vols. of which 10 have been already published. In occasional letters in the *Times*, B. displays a mastery of the English language that few Frenchmen attain.

BLANCH or **BLENCH HOLDING** is one of the ancient feudal tenures in the law of Scotland relating to land, the duty payable to the superior or lord being in general a trifling sum, as a penny Scots, or merely illusory, as a peppercorn, 'if asked only,' although it may happen that the duty is of greater value. Anciently, many estates in Scotland were held, both of the crown and other superiors, by this tenure; but it is now seldom adopted in the constitution of an original right of property. See **CHARTER, TENURE**.

BLANCHE-LYON, the title of one of the English pursuivants-at-arms. See **PURSUIVANT**.

BLANCHING is a process resorted to by gardeners, to prevent certain secretions which in ordinary circumstances take place in the leaves of plants, and to render them more pleasant and wholesome for food. The action of light is indispensable to the decomposition of carbonic acid by the leaves of plants, and, consequently, to the elaboration of many of the substances from which they derive their peculiar qualities: the exclusion of light, therefore, renders them white, or nearly so, and deprives them of much of their natural coarseness and bitterness—as in the familiar examples of lettuce, celery, sea-kale, &c. B. is accomplished in various ways, as by drawing up earth to the plants, when the lower part

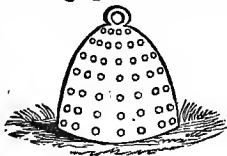

Blanching-pot.

of the leaf or leaf-stalk alone is to be blanched; tying the whole leaves together, by which the inner ones are blanched in a somewhat imperfect way, as is commonly done with lettuce; covering with boxes, pots, or the like, as the practice is with sea-kale; causing the leaves to grow up through litter, &c. The figure represents a very convenient B. pot, of French invention; it is made of earthenware, and perforated with many holes. B., although so simple and easy, is of great importance in the art of gardening, and the usefulness of many plants very much depends upon it. In cabbage, and some other cultivated plants whose leaves form themselves into compact heads, there is a natural B. or etiolation.

BLANC-MANGE, so called from its white appearance, is a jelly made of isinglass and milk. The following is the ordinary recipe for making it. Take a quart of sweet milk or cream, and put in it two ounces of the best isinglass, with the rind of a lemon, a blade of mace, and white sugar to taste. Put the whole in a saucenpan, and let it boil a quarter of an hour; then mix with 6 bitter almonds and 24 sweet ones, beaten into a paste with a little water; strain through a piece of muslin; and having let the composition settle a little, pour into a mould, and turn it out when cold. Soyer gives one ounce of isinglass to a quart of milk, a

quarter of a pound of sugar, a quarter of an ounce of cinnamon, a little grated nutmeg, half of the peel of a lemon, and a bay-leaf, prepared as above. B. is also made of calf's-foot jelly and eggs, of arrow-root and milk, &c.; and the flavour is modified to taste.

BLANCO, CAPE, a remarkable headland on the west coast of Africa, in lat. 20° 47' N., and long. 16° 58' W., the extremity of a rocky ridge (called *Jebel-el-Bied*, or *White Mountain*) which projects from the Sahara in a westerly direction, and then bending southward, forms a commodious harbour called the *Great Bay*. The bay and town of *Arguin*, which is supposed to have been the limit of ancient navigation in this direction, lie some miles to the southward. Southward to the mouth of the *Rio Grande* the shores are of a low sandy character, with a current tending south-west, and prevalent north-east trade-wind; northward from *Cape B.* to *Cape Geer*, the coast is rocky, with a moderate elevation. On account of the deficiency of good harbours, the prevalence of west winds, and other causes, the casualties to shipping are very numerous. The constancy of west wind on a coast almost wholly within the sphere of the trade-winds, is very remarkable, and is accounted for by the rarefaction of the air by the heat of the sands of the Sahara. The natives of the *Canary Islands* carry on a pretty lucrative fishery in the bay in boats of from 100 to 150 tons burden. *Cape B.*, which is composed of mixed calcareous and silicious sandstone, was first discovered by the Portuguese in 1441.—*Cape B.* is also the name of several less important headlands in Spain, Greece, America, and the Philippines.

BLAND, a beverage which is—or formerly was—a common drink among the inhabitants of the *Shetland Islands* during the summer months. It is prepared from the whey or serum of churned milk, and is said to be an agreeable beverage. *Dr Edmondston*, in his *View of the Zetland Islands*, describes B. as being, when twelve months old, perfectly good and transparent; its flavour then bearing a strong resemblance to lemon-juice.

BLANDFORD-FORUM, or **MARKET BLANDFORD**, a town in Dorsetshire, on the right bank of the *Stour*, 16 miles north-east of *Dorchester*. It lies in a fine tract of pasture-land, famed for its multitude of cows. It suffered much in 1579, 1677, 1713, and 1731, from fire. It is built of brick, and is neat and regular. It was formerly famed for its manufactures of bandstrings and lace, the point-lace bringing £30 a yard. *Shirt-buttons* are made here. Pop. in 1851, 2504.

BLANDRATA, GIORGIO, the founder of Unitarianism in Poland and Transylvania, was a native of *Saluzzo*, in Italy. He had established himself as a physician at *Pavia*, when he was compelled, on account of his heretical opinions, to fly to *Geneva* in 1556, where at first, and to avoid further molestation, he feigned to agree with *Calvin*. In 1558, he went to *Poland*, hoping to find there greater freedom of thought and speech; and in 1563 he betook himself to the court of *John Sigismund*, Prince of *Transylvania*, whose favourite physician he became. Here he exerted himself prudently but assiduously to spread his doctrines, and succeeded in forming a considerable party. In his old age, however, the heat of his proselytising zeal died out; and it is asserted that, to preserve his worldly interests, he even forsook the cause of the Unitarians, and favoured that of the *Jesuits*, who were in high esteem with the prince. He was murdered in 1590 by his nephew, whom he had threatened to disinherit on account of his attachment to the *Catholic Church*. B.'s religious treatises are entirely destitute of importance.

BLANE, SIR GILBERT, a distinguished physician, was born at Blanefield, Ayrshire, August 29, 1749. He studied at Edinburgh University, and afterwards became private physician to Lord Rodney, whom in that capacity he accompanied in 1780, when Rodney assumed the command of the West Indian Squadron. On one occasion, when all the officers were wounded, B.'s bravery was so conspicuous, that Lord Rodney immediately obtained for him the appointment of physician to the fleet. In 1785, he was elected physician to St Thomas's Hospital, London, having previously been appointed physician-extraordinary to the Prince of Wales. In 1795, he was chosen head of the Navy Medical Board, and was greatly instrumental in introducing the use of lemon-juice, so effective in preventing scurvy, into every vessel in the navy; and in many other ways he was active in promoting measures for the prevention or remedy of diseases on board ship. In 1809, he was employed to report on the cause of the unhealthiness of the Walcheren army, and the following year he was sent to inquire into the expediency of establishing a naval arsenal and dockyard at Northfleet. In 1812, he had a baronetcy conferred upon him, and in the same year the Prince Regent made him his physician in ordinary. When the Duke of Clarence ascended the throne as William IV. in 1830, he made B., then 81 years old, his first physician. B. died June 26, 1834. He published several valuable works, characterised by varied knowledge and originality of thought, the most popular and useful of which are, *Observations on the Diseases of Seamen*, a lecture on *Muscular Motion*, and *Elements of Medical Logic*.

BLANÈS, a town of Spain, in the province of Gerona, and 22 miles south of the city of that name, with a port on the Mediterranean. Pop. 5000.

BLANK BONDS were Scotch securities, in which the creditor's name was left blank, and which passed by mere delivery, the bearer or holder being at liberty to insert his name in the blank space, and sue for payment. The intention originally was to save the expense of conveyances, and to facilitate the transmission of the obligation; but experience having proved that they were capable of being used for fraudulent purposes, these bonds were, by a Scottish act, passed in 1696, declared void. The act, however, excepts from its provisions the notes of trading companies, and indorsements of bills of exchange. See **BOND, SECURITY**.

BLANK CARTRIDGES. The distinction between *blank* and *ball* cartridges will be found noticed under **CARTRIDGE**.

BLANKENBURG, a town in the duchy of Brunswick, 37 miles south-south-east of the capital, is situated on the Harz Mountains, at an elevation of 732 feet above the sea. It is walled, has a gymnasium, and several charitable and educational institutions. Pop. 3500, who are chiefly engaged in mining; iron, marble, and dye-earths being plentiful in the surrounding districts. On the Blankenstein, a rocky height immediately adjoining the town, there is a palace belonging to the Duke of Brunswick; and on the lofty summit of the Regenstein, about half a mile distant, there are the remains of a large castle, with many chambers, hewn out of the rock by Henry the Fowler in 919. Louis XVIII. resided at B. as Comte de Lille, 1796—1798.

BLANK VERSE is verse without rhyme (q. v.), and depending upon metre (q. v.) alone. The classical productions of the Greek and Roman poets—at least such of them as have come down to us—are composed on this principle; and accordingly, when the passion for imitating classical models set in, rhyme came to be looked upon as an invention of Gothic barbarism, and attempts were made in

most countries to shake it off. The first specimen of blank verse in English is a translation of the Second and Fourth Books of Virgil's *Aeneid*, by the Earl of Surrey, who was executed in 1547; but it had been used by Italian and Spanish writers as early as about the beginning of that century. In England, its adaptation to the drama was at once felt, and in that department of poetry it soon became and has continued dominant—if we except the effort made by Dryden and others, after the Restoration, to return to rhymed plays; but in other kinds of poetry, it was not till the appearance of *Paradise Lost* (1667) that it could be said to have taken root; and even then the want of rhymes was felt, as the poet expected it would. Many poets have since followed Milton's example; and English narrative, didactic, and descriptive poetry, is partly in B. V., partly in rhymed couplets. It is chiefly in 'heroic' metre, as it is called—that is, in verses or lines of ten syllables—that blank verse has found a firm footing. Some, in fact, would restrict the name blank verse to lines of ten syllables, not considering it applicable to such metres as those of Southey's *Thalaba* and Longfellow's *Hiawatha*.—Dramatic B. V. is characterised by the frequent occurrence of a supernumerary syllable at the end of the line:

To be | or not | to be, | that is | the question :
Whether | 'tis nobler | in | the mind | to suffer.

In Italian and Spanish, B. V. never became popular, and still less in French. The German language seems to admit every variety of blank metre.

BLANQUI, JÉRÔME ADOLPHE, one of the first French economists, was born at Nice, 28th November 1798, and educated at the Lyceum of that city. In 1814, his family quitted Nice, and young B. went to complete his studies at Paris, where he became acquainted with J. B. Say, who induced him to turn his attention to the study of political economy. In 1825, by Say's recommendation, he was appointed Professor of History and of Industrial Economy in the Commercial School at Paris. On the death of Say, he was appointed Professor of Industrial Economy in the Conservatoire des Arts et Métiers, and was one of the editors of the *Dictionnaire de l'Industrie Manufacturière, Commerciale, et Agricole*. In June 1838, he became a member of the Academy of Moral and Political Science. The Academy sent him to Corsica, to study the condition of that country, and in 1839, to Algiers for the same purpose. In 1841, he visited Turkey. In 1851, the Academy, which highly valued his abilities, requested him to furnish a complete account of London in its financial and other aspects. This task he executed to the satisfaction of the *savans* who employed him. He died at Paris on the 28th January 1854. B., as a national economist, was somewhat inclined to Socialism. Like his master, Say, he was in favour of free-trade. In method, he is ingenious; in style, transparent; and even the driest discussions become interesting, from his lively mode of treating them. His principal works are—*Voyage d'un Jeune Français en Angleterre et en Ecosse* (Paris, 1824); *Résumé de l'Histoire du Commerce et de l'Industrie* (Paris, 1826); *Précis Élémentaire d'Économie Politique, précédé d'une Introduction Historique, et suivi d'une Biographie des Économistes, &c.* (Paris, 1826); and, most important of all, the *Histoire de l'Économie Politique en Europe, depuis les Anciens jusqu'à nos jours, suivie d'une Bibliographie raisonnée des Principaux Ouvrages d'Économie Politique*.

BLANQUI, LOUIS AUGUSTE, the brother of the economist, was born at Nice in 1805. He has made himself conspicuous chiefly by his rabid advocacy of the most extreme political opinions.

From an early age, he dabbled in conspiracy, and submitted to its penalties with the pride of a martyr. After the revolution of February, he formed the Central Republican Society, which menaced the very existence of the Provisional Government. He it was also who organised the revolutionary *attentat* of the 15th May, the aim of which was to overthrow the Constituent Assembly, although it has been alleged that he was driven to this step by the impatience and violence of his party, or, more properly, his *club*. At the head of an excited mass, he made his appearance before the national representatives, and with that melodramatic love of liberty which makes a French patriot fancy it to be his first and most sacred function to emancipate the world, demanded the *resuscitation of the Polish nationality!* His coadjutor, M. Huber, went a step further, and theatrically imitating the desperate promptitude of the great Revolution, pronounced the dissolution of the assembly. The latter fortunately proved itself strong enough to crush this insolence. B. was arrested, tried, and condemned to ten years' imprisonment in Belleisle.

BLAPS, a genus of insects, of the order *Coleoptera*, the type of a tribe called *Blapsides*, the species of which are numerous, all of a dark colour, destitute of wings, and having the elytra or wing-cases united together. They run slowly, however, in comparison with many kinds of beetles, and inhabit dark and damp situations, feeding chiefly on dead vegetable matter. They have the power of secreting and emitting a brownish, acrid, irritating fluid, of a peculiar and penetrating odour, with which they appear to be furnished for the purpose of self-defence, and which some of them are capable of throwing to a distance of six or eight inches. *Blaps mortisaga* is a common

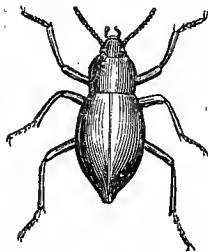

Blaps mortisaga.

British species, of about an inch long, and of a shining black colour. It is sometimes called **DARKLING BEETLE**, and **CHURCH-YARD BEETLE**, sometimes seems to share with the Cockroach (q. v.) the appellation of **BLACK BEETLE**. It is a frequent companion of the cockroach in pantries and cellars.—*Blaps sulcata* is 'cooked' with butter, and eaten by Turkish women in Egypt, under the notion that it will make them fat, this being, in their estimation, one of the chief points of beauty.

BLA'SIUS, a saint and martyr, was Bishop of Sebaste, in Cappadocia, when Licinius began a bloody persecution of the Christians. B. left the town, and concealed himself in an unknown chasm in the rocks, but his abode was discovered by Agricola, while out hunting. The saint was conveyed to Sebaste, and as he steadfastly refused to deny Christ, and worship the heathen gods, he was put to death (316 A. D.) with circumstances of the most horrid cruelty. At one period, his worship must have been widely diffused, judging from the extent of territory over which his relics were scattered. The wool-combers claim him as their patron, for the singular reason that he was tortured, among other instruments, with a wool-comb. At Bradford, in Yorkshire, there is a septennial procession of that craft on his day. The practice of invoking St B. in cases of sore throats, is said to have originated in the circumstance that, when young, he saved the only son of a rich widow from being choked by a fish-bone. It has been conjectured, however, that the wool-

comb has probably been mistaken for a fish-bone, and that the story of the rich widow's only son is simply a myth elaborated in explanation of the circumstance. St B.'s day is the 3d February.

BLA'SPHEMY is an offence against God and religion, by denying to the Almighty his being and providence; or by contumelious reproaches of our Lord and Saviour Jesus Christ; also all profane scoffing at the Holy Scriptures, or exposing them to ridicule and contempt. Seditious words, moreover, in derogation of the established religion may be proved under a charge of blasphemy. These all are offences punishable at common law by fine and imprisonment, or other infamous corporal punishment; for Christianity is held to be part of the laws of England; and a blasphemous libel may be prosecuted as an offence at common law, and punished with fine and imprisonment. In Gathercole's case, tried at York in 1838, where the defendant, a clergyman of the Church of England, was prosecuted for a libel on a Roman Catholic nunnery, and in which he also made a violent attack on the tenets and the morality of the Roman Catholic Church, it was laid down by the judge who tried the case (the late Baron Alderson), that a person may, without being liable to prosecution for it, attack Judaism, or Mohammedanism, or even any sect of the Christian religion, save the established religion of the country; and the only reason why the latter is in a different situation from the others is, because it is *the form established by law*, and is therefore a part of the constitution of the country. But any general attack on *Christianity* is also the subject of criminal prosecution, because Christianity is the public religion of the country. Thus, as an offence against religion, B. may assume one of two forms: first, either as against the articles and creeds of the Established Church; or secondly, as against a dissenting community, in the libel against whom, a general attack on the Christian religion is involved. The B. must in some manner have been overtly and publicly declared, either by a speech on some public occasion, or by the act of publication in print.

The Scotch law regarding this offence is now very much the same. The old severe Scotch acts, one passed in 1661, and another in 1695, which provided capital punishment for offences of this description, were repealed by the 53 Geo. III. c. 160. The punishment is now arbitrary at common law; and by the 6 Geo. IV. c. 47, the punishment of B. is further restricted, and made the same as in England. It is also enacted by the second section of that act, that a person convicted of a second offence may be adjudged, at the discretion of the court, either to suffer the punishment of fine or imprisonment, or both, or to be *banished* the country; but the provision as to the punishment of banishment is repealed by the 7 Will. IV. c. 5. The latest and most remarkable illustration of the Scotch law regarding this offence, is a case that was tried before the High Court of Justiciary in 1843. The prisoner, who defended himself, was accused, convicted, and sentenced to imprisonment for fifteen months, for publishing profane, impious, and blasphemous books, containing a denial of the truth and authority of the Holy Scriptures and of the Christian religion; and devised, contrived, and intended to ridicule and bring into contempt the same. In the course of the trial, the prisoner endeavoured to justify his conduct by quotations from the Bible, which, he maintained, warranted the language of the blasphemous works in question. But the court would not allow such a line of defence, and the Lord Justice-clerk (the late Right Honourable John Hope), in charging the jury, pointed out that the indictment charged, that the wicked and felonious publication of such

BLAST FURNACE—BLASTING.

works is a crime, and that therefore the jury were not to consider themselves engaged in any theological discussion, but simply in trying whether a known and recognised offence against the law had been committed. His lordship proceeded further to expound the law as follows: 'Now, the law of Scotland, apart from all questions of church establishment or church government, has declared that the Holy Scriptures are of supreme authority. It gives every man the right of regulating his faith or not by the standard of the Holy Scriptures, and gives full scope to private judgment, regarding the doctrines contained therein; but it expressly provides, that all "blasphemies shall be suppressed," and that they who publish opinions "contrary to the known principles of Christianity," may be lawfully called to account, and proceeded against by the civil magistrate. This law does not impose upon individuals any obligations as to their belief. It leaves free and independent the right of private belief, but it carefully protects that which was established as part of the law, from being brought into contempt.' The learned judge also observed: 'I think it also my duty to add—as a part of the [prisoner's] address was directed against the policy and expediency of this prosecution—that I think it was a most proper and fit prosecution. I have no doubt of the effect that will result from this prosecution; because, though, in his advertisement and address, this individual declares that he addresses himself chiefly to the working-classes of Scotland, yet I am sure that he deceives himself if he imagines that that is a class which would easily part with their belief in those truths, which are perhaps more valuable to them in this life than to any other class in the community. There may, indeed, be a class of persons, like the prisoner at the bar, in situations above that of the working-classes, young men whose education is imperfect, and their reading misdirected; and it is to save them from the mischief of these opinions that it is necessary the law should take its course.' See RELIGION, OFFENCES AGAINST.

BLAST FURNACE is the apparatus employed in the smelting of iron ores. Internally, it is shaped

in the construction of these furnaces, so that the high temperature to which they are subjected may not fissure or destroy them. The upper part of the B. F. (fig.), A, is named the *cone* or *body*, and is cased in a double firebrick lining; between the inner lining or *skirt*, and the outer, a space intervenes, which is filled in with coarse sand or small pieces of scorie; and outside of these, a thick wall, *a*, of common stone or strong bricks, is placed, which, in its turn, is often surrounded by a strong thick casing of wrought iron. On the top of this erection there is a short shaft, B, with doors or openings for feeding the furnace, and a terrace, round which fuel, &c., may be conveyed to the different sides. The lower cone of the furnace, C, usually named the *boshes*, is surrounded with very refractory firebrick. The junction of the body and boshes is rounded off, so as to prevent a sharp angle in which material might lodge, and the part is named the *belly*. Below the boshes is a quadrangular or cylindrical space, D, which slightly narrows as it approaches the *bottom* or *hearth* of the furnace. The latter is made up of firestone, supported on masonry. The space between the cylindrical or quadrangular space, D, and the hearth, is called the *crucible*, and is intended for the collection of the reduced metal and slag. The building on three sides is carried down to the hearth; but on the fourth side it stops short with a heavy block of stone, called the *tympan*. In front of the tympan-stone, and a little below it, is placed the *dam-stone*, which is covered externally, and kept in its proper place by a strong piece of cast iron, called the *dam-plate*. On the three sides of the B. F. which are built down to the hearth there are several openings, through which pipes called *tuyeres*, F (q. v.), are introduced, and through which the air is blown into the furnace from a large air-condensing apparatus similar in principle to an ordinary pair of bellows. The B. F. varies in size according to amount of work to be done, and the kind of raw material to be operated upon; but in height it ranges from 30 to 70 feet.—The mode of working the B. F. will be described under Iron.

BLASTING. Before gunpowder was invented, the separation of masses of stone from their native rock could only be effected by means of the hammer and wedge, or by the still slower method of fire and water. In soft and stratified rock, wedges are still used for quarrying stones for building purposes; but in hard rock, or where regularity of fracture is no object, gunpowder is universally employed. There are two kinds of B.—first, the small-shot system; and second, that of large blasts or 'mines.'

The small-shot system consists of boring holes into the rock, of from one to six inches in diameter, and of various depths, according to circumstances. In hard rock, this is done by a steel-pointed drill, struck by a hammer, and turned partly round after each blow, to make the hole cylindrical. In soft rock, whenever the hole is to be vertical, a 'jumper' is used; this is a weighted drill, which acts merely by its own weight, when let fall from about a foot in height. The powdered stone is removed at intervals by a 'scraper.' The depth of hole drilled in a given time varies, of course, with the hardness of the rock, and the diameter of the hole. At Holyhead, the average work done by three men in hard quartz rock, with 1½ inch drills, is 14 inches in depth per hour; one man holding the drill, and two striking. After the hole is bored, it is cleaned out, and dried with a wisp of hay, and the powder poured down; or, where the hole is not vertical, pushed down with a wooden rammer. A wad of dry turf or hay is put over the charge, and the rest of the hole 'tamped,' or filled with broken stone, clay, or sand. The shot

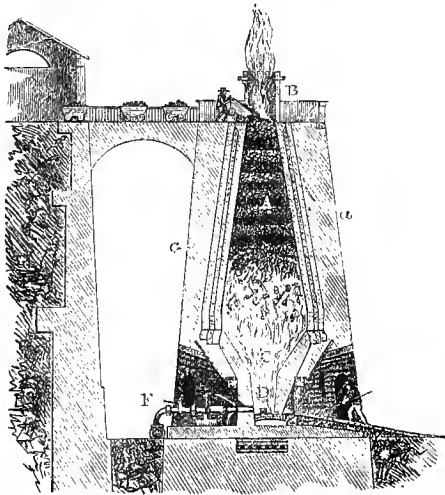

Blast Furnace.

like a sugar-loaf with its apex cut off, placed on a flower-pot; externally, it resembles a sugar-loaf alone, with the apex taken off. Great care is taken

is fired by a length of Bickford's patent fuse, or by a series of oaten straws filled with powder, and a slow match of paper steeped in saltpetre.

When it is desirable to prevent the stones from flying about, when the shot is fired, a shield of boiler-plate, or of brushwood weighted, may be laid over the hole. To lessen the danger of the tamping being blown out, plugs or cones of metal of different shapes have been inserted in the hole; but the practice is neither general nor effective. This object would be much better attained, were it easy to enlarge the bottom of the hole, and form a chamber for the powder. At Marseille, this has been done in calcareous rock by pouring dilute nitric acid down the hole, and thus eating out an enlargement at the bottom.

Small shots may be fired, even under water, by enclosing the charge in a tin case, with a tube of powder reaching to the surface; or in a canvas bag, well tarred, tied at the neck round a length of Bickford's fuse, which burns under water. The charge is inserted in the drill-hole; and the weight of the superincumbent water acts as tamping.

In removing the wall between the old and new Shadwell basins of the London Docks, shots were fired under water within a few yards of vessels lying in the basin, by using moderate charges, and by keeping a raft of timber floating over the hole, as a shield to prevent anything flying upwards.

The voltaic battery has been used for firing shots, chiefly under water, since 1839, in which year it was employed at the wreck of the Royal George and at the Skerryvore Light-house.

When a large mass of rock has to be removed at once, or where a steady supply has to be daily furnished of irregularly broken stone, for breakwater or other purposes, recourse must be had to large blasts, or 'mines.' The greatest isolated example of this kind of blasting was the overthrow, in 1843, of the Rounddown cliff at Dover, by 18,500 lbs. of powder, in three separate charges, fired simultaneously by voltaic electricity. But by far the grandest system of B. by mines is to be seen at the quarries for supplying stone to the breakwater at Holyhead, where small shots having been found inadequate, large mines were introduced in 1850. These large blasts are of two kinds—'shafts' sunk from the top of the rock; and 'headings,' or galleries driven in from the face.

The shaft-holes are 6 feet long by 4 feet wide, of various depths, according to the height of the rock, but seldom much exceeding 60 feet. The deal-box, with the charge of powder, *p*, is placed in a chamber

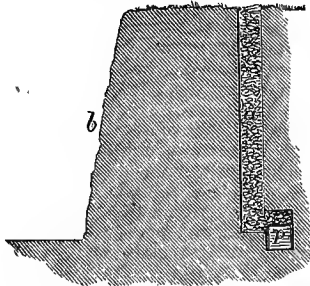

Vertical Section of Shaft :
a, tamping; *b*, face of the rock; *p*, box for charge.

cut on one side of the shaft, so that the tamping may not be in the direct upward line of fire. The tamping consists of the stone and débris which have come out of the shaft; and the wires from the

battery are protected from injury by being laid in a groove cut in a batten placed up one angle of the shaft.

It is evident that the same point, *p*, in the rock may be reached as well by a heading or gallery driven in from the face of the rock, as by a shaft from the top, and often by a shorter route. Headings are made 5 feet high by 3 feet 6 inches wide, and are driven, if possible, along a natural joint in the rock. The direction of the gallery is changed and sunk at parts, to prevent the tamping from being blown out. Four men can, on the average, drive 5 feet run of heading per week; but cannot sink above 3 or 4 feet of shaft, which has a greater sectional area, and is more inconvenient to work in.

The charge of powder may be divided and placed in two or more separate chambers, as *p* and *p'*; and

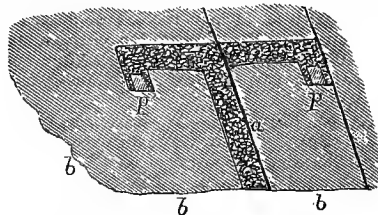

Sectional Plan of a Double Heading.

it is better thus to spread a heavy charge over a length of face, than to have it in one spot, at a greater distance from the face than about 30 feet.

The charges for these mines vary from 600 lbs. to 13,000, and even more, pounds of powder; and the produce is from 2 to 6 tons of stone to the pound of powder, according to the density of the rock and the position of the mine; the most favourable position being the centre of a projecting column of rock; and the least favourable, at a re-entering angle. Many of the mines furnish enough cubic feet of stone to build a large block of a street; and a proper succession of them enables 4000 tons a day to be tipped into the sea.

The charges for large blasts are regulated with reference to the lines of least resistance, or the shortest distance of the mine from the face of the quarry. In the chalk rock at Dover, $\frac{1}{3}$ of the cube of this line in feet equalled the charge in pounds of powder; but at Holyhead, more is required, as the rock is harder, and the complete breakage up of it into stones of not more than 11 tons is desiderated. For shafts, therefore, the charge in pounds of powder is from $\frac{1}{10}$ to $\frac{1}{5}$ of the cube of the line of least resistance in feet; for headings, $\frac{1}{15}$, and even $\frac{1}{10}$, is found necessary.

When a mine is successful, there is very little noise; the column of rock is seen to heave slowly forward, and crumble to pieces amidst a shower of smoke and dust.

Besides the quarrying of stone, B. is used for military objects, or where total destruction is aimed at, and an excess of powder is little or no objection. The use of powder for these purposes is, however, very limited in comparison with what has been treated of in connection with the arts of peace.

BLA'TTA. See COCKROACH.

BLAYE (ancient *Blavia*), a fortified seaport of France, in the department of the Gironde, 20 miles north-north-west of Bordeaux. It is built on the right bank of the river Gironde, which at this point is about 2½ miles in breadth, at the base of the

rocky eminence crowned with a strong citadel. The town is further defended by the two forts of Paté and Médoc, which command the passage of the river. The port of B. is a very busy one, all inward vessels being required to anchor and deliver the manifests of their cargoes; and many outward-bound vessels lay in their provisions here. B. has manufactures of linen and woollen, glass and earthenware; a considerable export-trade in corn, wine, brandy, oil, fruits, soap, &c., and tribunals of jurisdiction and of commerce. Pop., exclusive of garrison, 3389.

BLAZON, BLAZONRY (Ger. *Blasen*, to blow, as with a horn). These heraldic terms originated in the custom of blowing a trumpet to announce the arrival of a knight, or his entrance into the lists at a joust or tournament. The blast was answered by the heralds, who described aloud and explained the arms borne by the knight. B. and B. thus came to signify the art of describing, in technical terms, the objects (or charges, as they are called) borne in arms—their positions, gestures, tinctures, &c., and the manner of arranging them on the shield.

Rules of Blazoning.—As heraldry, though an entirely arbitrary, is a very accurate science, the rules of blazoning are observed on all occasions with the most rigid precision. The following are the most important: 1. In blazoning or describing a coat of arms, it is necessary to begin with the field, mentioning the lines by which it is divided—*per pale, per fess, &c.*, if such there be—and noticing if they are *indented, engrailed, or the like*, it being taken for granted that they are straight, unless the contrary be mentioned. 2. There must be no unnecessary repetition in blazoning; thus, where the field is blue, and the charges yellow, we should say, *azure, a crescent between three stars, or*, thereby implying that both the crescent and the stars are *or*. 3. For the same reason, where a colour has been already mentioned, and it is necessary, in order to avoid ambiguity, to repeat it in describing a subsequent charge, we say, *of the first, or of the second*, as the case may be. Thus, we should say, *azure, on a saltire argent, three water bougets of the first*, thus avoiding the repetition of the word *azure*. 4. Again, recurring to our first example, it would be an error to say, *three stars with a crescent between them*, because we must always begin with the charge which lies nearest the centre of the shield. 5. Where the charges are of the natural colour of the objects or animals represented, in place of describing the colour, you simply say *proper*—i. e., of the proper or natural colour. 6. Another general rule in blazoning, or rather in marshalling coat-armour, is, that *metal shall never be placed upon metal, nor colour upon colour*.

The rules for blazoning separate charges, whether animate or inanimate, are indicated in the descriptions which will be found of them under their respective heads. See **ORDINARIES**; also **BAR, BEND, &c.**

BLEACHING (Ang.-Sax. *blæcan*, from *blæc*, pale, bleak) is generally understood to mean the process of whitening or decolorising cloth; but the term is also applied to the decolorising of such substances as the fixed oils, Irish moss, &c. Until about the close of the 18th c., B. depended upon the natural bleaching agencies present in the atmosphere and in the sun's rays. The usual plan was to spread out the cloth on a grass field, called a bleaching-green, and to continue sprinkling it with water several times a day. After being thus exposed for several months to the action of air, light, and moisture, the cloth was rendered white. The process

was necessarily tedious and occupied much valuable land, and for this reason a large quantity of the cloth required to be bleached was sent to Holland for that purpose. A particular kind of linen, which was regularly sent to Holland, received on that account the name of *Holland's*; and another variety of linen, which, from its fineness, was generally spread on the better grass-fields or lawns, received the title of *lawn*. An improvement in the preceding process was to dip the cloth occasionally in a weak *alkaline lye*, or solution of an alkali, such as soda in water, which step was called *bucking*; after which, the cloth was spread out on the grass for some weeks, and regularly moistened with water, this stage being styled *crofting*; the cloth was then soaked in sour milk and water, which was called *souring*, and again exposed on grass to the action of air and sun-light. By repeating the bucking, crofting, and souring operations several times, the bleaching was very much hastened, and the amount of land occupied in bleaching-greens lessened. The next improvement was the introduction of dilute sulphuric acid instead of sour milk, as the souring agent; and this was so effectual, that it lessened the time required for B. from about eight months, which was the original time, to about four months.

Till very recently, it was thought that the agent in this natural mode of B. was entirely resident in the sun's rays, but the discovery of the substance called *Ozone* (q. v.), which possesses very powerful B. properties, and which in greater or less quantity exists in the air of country districts at all times, has led to the opinion, now held by chemists, that the B. which takes place when cloth is moistened and exposed to the air is mainly due to the ozone present therein; though the chemical rays which accompany the luminous rays of the sun may assist in the B., and also aid in the formation of the ozone. That the ozone has very much to do in open-air B., is observable from the fact that in town districts, where little or no ozone exists in the air, cloth is never bleached white.

In the year 1785, Berthollet, a distinguished French chemist, discovered the powerful B. properties of *Chlorine* (q. v.), and immediately thereafter it was suggested that chlorine would be useful in the B. of cloth. At the first, the gas chlorine was employed, and being diffused in the atmosphere of a vessel or small apartment, cloth hung therein was speedily bleached. It was found, however, that the chlorine, which bleaches, or destroys colour by uniting with the hydrogen of the colouring principle and thus decomposing the colour, could also unite with the hydrogen of the fibre (see **LIGNIN**) and destroy or render tender the textile fabric. So long as chlorine was employed in the gaseous state, it was very difficult to use it of such strength as only to destroy the colour, without also rotting the cloth. It was then suggested, that as chlorine was soluble in water, to the extent of two volumes of chlorine gas in one volume of cold water, the solution of chlorine might be employed. But although chlorine water was found to act efficiently and safely when the solution was of the proper strength, it was very difficult always to make it of the same strength, and more so to preserve it when made; as the least exposure to light causes more or less of the chlorine to unite with the hydrogen of the water, forming hydrochloric acid, which does not possess B. properties. After attempts to fix the chlorine in alkaline solutions, it was found that dry slaked lime was an admirable absorber of chlorine gas. The material produced from the union of chlorine with dry slaked lime is known as the *chloride of lime*, or *Bleaching powder* (q. v.), and this is the substance which has continued from 1799 up

BLEACHING.

to the present time to be the great artificial bleacher of cotton and linen fabrics. It is not serviceable in the destruction of the colour of wool, silk, or the oils and fats; such materials being bleached by the employment of other agents, as will be afterwards noticed.

BLEACHING OF COTTON AND LINEN FABRICS.—The substances requiring to be got rid of in the purification of cotton and linen cloth, are (1) the organic colouring matter naturally present in the fibre; (2) resinous and fatty bodies, also inherent in the fibre; (3) weavers' dressing and perspiration taken up during the process of spinning; and (4) certain saline or earthy substances. The *first stage* in the B. is the singeing of the cloth, which is accomplished by drawing the cloth rapidly over a red-hot iron cylinder, or a numerous series of gas jets, which burn off the minute particles of fibre, resembling in appearance short hairs or down, and leave the cloth perfectly smooth. The *second stage* is the washing or scouring of the cloth, which consists in rolling up the pieces of calico or linen into bundles like coils of rope, and throwing a number of pieces into a large vat among lukewarm water, and allowing them to lie till fermentation begins, and proceeds some length, when the cloth is taken out, and thoroughly washed in the dash-wheels; which are large horizontal cylinders divided into several compartments, into each of which a stream of water keeps running while the wheel is turning. The *third stage* is boiling with lime-water, or *bucking*. The apparatus employed is called the *Bucking* or *Bucking Kier*, and consists of two compartments. The lower part is a boiler containing the lime-water, and the upper part is a capacious circular tank, into which the cloth in bundles, as it comes from the dash-wheels, is placed. By an ingenious arrangement, the lime-water is alternately forced up, by the compression of the steam, through a pipe into the upper compartment, and falls in a shower upon the cloth, through which it percolates and sinks again through perforations into the boiler, to be again propelled into the upper compartment. Instead of using lime alone, a mixture of lime and carbonate of soda (Na_2CO_3) is occasionally employed, which acts by forming the inert carbonate of lime or chalk (CaCO_3) and caustic soda (NaO), which possesses high detergent properties. The chemical action which the boiling lye exerts on the cloth is in the formation of a soap with the resinous and fatty substances naturally inherent in the cotton or linen fibre, or communicated to it in the process of weaving, the greater portion of which is detached by the lye in the *bucking kier* and ultimately removed by a subsequent washing with water. This takes place either in the dash-wheels, or in a more effectual washing arrangement, consisting of a series of boxes or vats of different depths, placed side by side, into which the cloth is made to dip successively by passing over and under two sets of rollers. As the cloth moves on from the lower vats to the higher, it is passing from the soiled water to the more pure, as a stream of pure water is kept constantly running through the vats from the higher to the lower. The *fourth stage* in B. is the *souring* or *chemicking* in dilute sulphuric acid, of the strength of one gallon of the acid to from 25 to 30 gallons of water. The weak acid liquid is put into a large stone vat, and the goods are steeped in it. The acid acts beneficially in removing the remaining traces of the lime-soap which have adhered to the cloth, and a second washing in water, followed by bucking or scouring in soda lye, and a third washing in water are generally found necessary to obtain the cloth in

the condition best suited for the subsequent operations. The *fifth stage* is *chemicking with B. liquor*, obtained by dissolving B. powder (q. v.) in water, and allowing the impurities or insoluble matter to subside. The B. liquor is much diluted with water, and the cloth is steeped in it for about six hours, then taken out, and allowed to soak for other six hours in a second vat containing water, after which it is drawn out and exposed to the atmosphere, when the carbonic acid of the air sets free a portion of the chlorine from the B. powder, imbibed by the cloth. The *sixth stage* is another *souring* process, during which the cloth is immersed for about four hours in a steeping vat, containing dilute sulphuric acid of the strength ranging from 1 to 8 gallons of acid in 200 gallons of water. This acid liquid, as it soaks the cloth, encounters the B. liquid which previously saturated the fibre of the cloth, and the acid combining with the lime of the B. liquid, liberates the chlorine, which attacks the remaining traces of colour and removes them from the cloth.

The cloth, on being removed from the souring-vat, is boiled with soda lye, washed, and again treated with dilute sulphuric acid, which more effectually removes the decomposed colouring matter. It is thereafter thoroughly washed, passed through rollers to remove some of the water; then introduced into the *Hydro-extractor* (q. v.), to get rid of the water more effectually; and lastly, the cloth is dried by being suspended in the air, or by being passed over a series of heated tin rollers, called *Steam Cans* (q. v.). In the ordinary course of B., cotton loses about one-twentieth of its weight, and linen about one-third.

After the B. operations have been successfully performed, it is customary to proceed to the *finishing* of the cloth, which consists in, firstly, passing it through a large mangle, where the crumpled piece of cloth becomes smooth; secondly, drawing the cloth over rollers, which cause it to dip in a trough containing starch; thirdly, drying the starched cloth; and, fourthly, passing it through a large mangle or calender, consisting of a series of rollers, alternately of polished cast iron and solid paper, and which not only smooth out the cloth, but communicate a fine glazed surface, such as is generally exhibited in bleached cloth when purchased. The cloth intended to be printed upon or to be dyed is not starched or calendered.—The operations connected with the B. of cloth by chlorine exert no injurious effect on the health of men and women engaged in them. Some of the bleach-works near Glasgow are of long standing, and give regular employment to several hundred women. The rapidity with which the B. by chlorine can be carried on, may be understood from the fact, that when pressed for time, it is no uncommon thing to bleach, finish, and return to town 1000 pieces of cloth within 48 hours. Valuable in many respects, however, as is the rapidity of B. by means of chemical agents, it must be admitted that the process exerts a certain weakening effect on the cloth, and that, after all, B. according to the old method on the grass is preferable. Grass-B. is therefore still in use where time admits, as also for clearing linen and cotton apparel in domestic washing. See WASHING.

BLEACHING OF WOOL is never accomplished by B. powder, but recourse is had to sulphurous acid, which disguises the colour of the wool by combining with it to form a colourless compound. Originally the wool is contaminated with a greasy substance called the *yolk*, which naturally exudes from the skin of the sheep, and this unctuous matter mainly consists of a kind of soap soluble in water. The *first stage* in the B. of W. is to get rid of the yolk, which can be done by long-continued washing

BLEACHING—BLEACHING POWDER.

in water; but as this is tedious, the general plan is to steep the wool in a vat containing one part of stale urine and five parts of water, then boil for some time, and ultimately strain the wool and wash well. The agent in the stale urine which acts upon the yolk is carbonate of ammonia, and this acting upon the oily matters forms a soap which can be readily washed away. When woollen cloth is to be bleached, it is customary to substitute carbonate of soda (washing soda) for the stale urine, and this forms an alkaline lye, which performs the same part as the carbonate of ammonia. Soap is sometimes used as an auxiliary. The *second stage* of bleaching wool is the *sulphuring*, which takes place in a small wooden apartment, in which the damp cloth is suspended in regular folds from the roof to the floor, and a small pan of ignited sulphur being introduced, the doors, &c., are firmly closed. There are little openings round the sides of the chamber, for the admission of air, which can be closed at pleasure. The sulphur (S) in burning takes up two atoms of oxygen from the air, forming sulphurous acid (SO₂), which is the bleaching agent; and in about 24 hours the operation is finished, and the woollen material only requires to be thoroughly washed with water, which may contain a little potash or soda. Where the wool is naturally high-coloured, it is necessary to repeat the various stages of the process several times before the bleaching is complete. Instead of applying sulphurous acid in the gaseous form, a solution of it in water is sometimes used. An economical method of preparing the solution of sulphurous acid is to introduce a mixture of sulphate of iron and sublimed sulphur into an earthenware retort, and apply a low red heat, when sulphurous acid is disengaged, which is passed through a vessel containing some porous matter, such as moss, to retain mechanical impurities, and then transmitted through a series of bottles containing water, where it is dissolved to the extent of forty volumes of the gas for every one volume of the water. The bleaching of wool by sulphurous acid is not so complete as the bleaching of cotton or linen by chlorine. In the latter case, the colour is destroyed, but in the former, the sulphurous acid merely combines with the colouring matter to produce a colourless compound, from which the colour can again be revived, either by soaking the wool in a dilute acid, such as sulphuric acid, or a dilute alkali, such as soda. Hence it is that new woollen cloth or garments, such as flannel, blankets, and underclothing, though almost colourless when purchased, yet after being washed several times, return to their natural yellow; for the soda used, as well as the soap which contains potash or soda, destroys the colourless compound formed in the texture of the wool during the sulphuring, and resuscitates the original colour.

BLEACHING OF SILK is carried on in a manner very similar to that pursued in the bleaching of wool. The silk has naturally a good deal of wax, accompanied by oil and colouring matter, enveloping the fibre, and the silk stuffs are repeatedly boiled in water containing a little soap or carbonate of soda, the alkaline nature of the solution being occasionally tempered by the admixture of some bran, which contains an acid. When well scoured and washed, the silk is obtained white enough for many kinds of printing; but where it is desirable that a pure white be obtained, the silken stuffs are introduced into a very weak solution of sulphurous acid, and thereafter thoroughly washed.

Other substances employed in the arts and manufactures are subjected to a process of bleaching; as the rags which are being manufactured into PAPER (q. v.), the palm-oil which is being converted into CANDLES (q. v.) and night-lights, and the STRAW

(q. v.) of which hats or bonnets are made; but the details of the processes followed in these and other operations, will be described more properly under their respective headings.

BLEACHING POWDER, a combination of chlorine and dry slaked lime (see BLEACHING), was first manufactured on a large scale in Glasgow by Mr Charles Tennant, who obtained a patent for its preparation in 1799. The substances employed in preparing the chlorine are common salt (chloride of sodium), black oxide of manganese, and sulphuric acid. The operation may be conducted in one or in two stages. The vessel used is a still. The whole apparatus is made of strong sheet lead, or of cast iron, or of grooved stones fitting closely. The more general plan is to have the upper part of lead, and the under part of cast iron. The lower third of the still has usually a double jacket, or double walls, between which steam is admitted through a pipe for heating the contents of the still. In using the apparatus, 100 parts of black oxide of manganese (MnO₂) and 150 parts of common salt (NaCl) are introduced by an opening in the top, which is closed by a water-joint; 185 parts of sulphuric acid (SO₃), of specific gravity 1600, are then poured in by a funnel, and on the admission of steam into the jacket, chlorine is evolved, and issues by a tube at the head of the still. The theory of the changes that occur in the still is represented in the following table, there being two equivalents or atomic weights of sulphuric acid for one equivalent of each of the other ingredients:

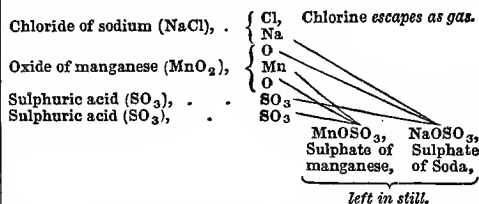

The pipe which carries away the chlorine gas is connected with a stone or leaden chamber, into which it enters at one or more points, and the chlorine entering, comes in contact with dry slaked lime in fine powder, with which the floor of the chamber is covered to the depth of some inches. The chlorine is rapidly absorbed by the lime, which, when the absorption flags, is stirred from time to time by wooden rakes. The process must not be allowed to proceed too quickly, as much heat is evolved during the combination of the chlorine with the lime; and if the temperature of the chamber rises beyond 110° F., the power of combination is very much lessened.

The material which is left in the still as a residuum, consisting of the sulphate of manganese and the sulphate of soda mixed together, is comparatively worthless, and accordingly it is found more economical in large chemical works to divide the process of the manufacture of B. P. into two stages, at each of which the residuum is of commercial use, and can be worked up into marketable products. The first stage is to heat the common salt and sulphuric acid together, when hydrochloric acid (q. v.) is disengaged in the gaseous state, and is received in proper vessels, and the sulphate of soda—from which common soda (q. v.) is prepared—is left in the retort or still. The hydrochloric acid thus obtained, is then placed along with the black oxide of manganese in the still, and on the steam-heat being applied, chlorine is evolved and is conducted to the lime chamber, while chloride of

BLEAK—BLEEDING.

manganese and water are left in the still. The decomposition is stated thus :

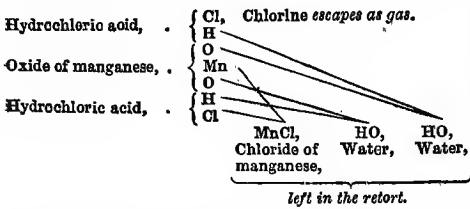

The chloride of manganese can be returned to the condition of black oxide of manganese, and used again and again. See MANGANESE. The B. P., prepared either in one or two stages, contains, when freshly and fully manufactured, generally between 30 and 40 per cent. of chlorine, and the strength of any sample is determined by the process of Chlorimetry (q. v.). The composition of B. P. is expressed by the formula $\text{CaCl} + \text{CaOClO}$, and it is regarded as a double salt of the chlorides of calcium and hypochlorite of lime. For its employment as a decolorising agent, see BLEACHING.

BLEAK (*Leuciscus Alburnus*), a small fresh-water fish of the family of *Cyprinidae* (q. v.), of the same genus with the Roach, Dace, Minnow, &c. See LEUCISCUS. It is seldom more than six or seven inches long; in general form it resembles the dace, but is more elongated; the dorsal fin is placed further back, and the base of the anal fin is longer; the nose is pointed, the under jaw the longest; the scales are of moderate size, and beautifully striated; the back is of an olivaceous green colour; the sides, belly, cheeks, and gill-covers, shining silvery white; all the fins nearly white. The tail is forked for half its length. The B. is found in

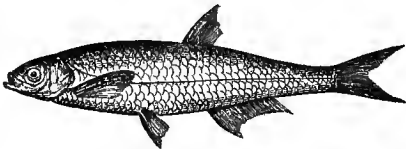

Bleak (*Leuciscus Alburnus*).

many of the rivers of Europe. On the inner surface of the scales of the B., as of whits-hait, roach, dace, &c., a silvery substance, from which they derive their beautiful lustre, is found in such abundance as to be much used for making artificial pearls (q. v.), the white beads so common in ladies' head-dresses, and similar ornaments. That obtained from the scales of the B. is preferred to that of the roach and dace, but is inferior to that of the white-bait. It readily separates from the scales when they are soaked for a time in water, and settles to the bottom of the vessel. Small glass tubes are then dipped in it, and it is injected into thin hollow glass beads of the requisite forms and sizes, which are placed in a current of air to dry, and are sometimes further filled with wax.—The B. is singularly liable to be infested by a species of tape-worm.

The B. is an inhabitant of most of the English rivers which contain roach and dace. It is a very restless, active, little fish, constantly playing about the top of the water, in search of small flies or other food. A small piece of bread cast into the water becomes speedily surrounded by a shoal of them, and it is amusing to watch them darting to and fro at it with increasing pertinacity. It is not only a pretty little fish, but is, withal, delicate

eating; and a dish of well-cooked B. is scarcely inferior to gudgeons. They should be cooked in the same manner as sprats, which they rather resemble in shape and appearance. The best way to catch B. is to angle for them with a single gentle and a light quill-float, the bait being about a foot under water; they may be caught with very small flies, and all the more easily, if the hook be pointed with a gentle. They are so active, that the angler cannot strike too quickly, and where they abound, they form good preliminary practice for the young fly-fisher. The neighbourhood of running drains are very favourite resorts for B., and the angler can soon determine if there be any about, by casting on the water a handful of bran, when, if there be any, they will immediately rise at it.

BLEBS (allied to *bull*—Lat. *bulła*, a bubble) are transparent bladders or blisters of the cuticle, which make their appearance in some forms of fever, in erysipelas, and in disorders of the digestive apparatus. There are three varieties of B. recognised by physicians: 1. The mild B., which vary in size from a pea to a hazel-nut, occur on the face, neck or arms, and legs of teething infants, and of young persons who have indulged in unripe fruit. They generally burst, discharge the clear fluid they contain, and heal up again in three or four days. 2. The tedious B., which most commonly affect aged and weakly persons, are seen as an eruption of numerous red elevations, which enlarge to the size of a pea, containing pale yellow serous fluid. These vesicles multiply to such an extent that the sufferer is disturbed at night from the irritation, and slight febrile attacks further debilitate him. 3. The solitary bleb generally selects old women for its victims, and appears, after much tingling of the skin, as one large vesication, and bursts in 48 hours, leaving a superficial sore.

The treatment consists in correcting the secretions, limiting the diet to what is farinaceous and easy of digestion, cooling drinks and tonics. For local treatment, the irritated surfaces are to be soothed by poultices and water-dressings.

BLEEDING (*hemorrhage*) is one of the most serious accidents which can happen to an animal, and constitutes the most anxious complication in surgical operations. As there is but a limited quantity of blood in the body, and as the sudden escape of a large portion of it is sufficient to cause death, every one should be instructed as to the measures which experience has shewn to be the most efficient for preventing a dangerous loss of blood.

B. may be either from a wounded artery or vein, or from a raw surface; and it may be in the form of a general oozing from the surface of a sore or a mucous membrane. We shall consider these varieties separately.

Arterial B. is recognised by the florid redness of the blood, and by its issuing from the cut vessel *per saltum* or by jerks. There are exceptions to this, however. When an artery has been tied, and bleeding occurs from below the ligature, the flow of blood is continuous, and of a dark colour.

If a large artery be wounded, the first gush of blood may prove fatal, but in general the patient faints, and nature takes advantage of the respite to place the cut artery in circumstances as favourable as possible to the preservation of life; viz., the artery draws up within its sheath (see ARTERY); the blood, no longer impelled vigorously by the heart, clots between the cut end and the cellular tissue surrounding it; the inner and middle coats not only retract but contract, and another clot forms within the arterial tube. These clots—which, with the faintness and the contraction and retraction of the artery, are termed natural *hemostatics* (blood-

BLEEDING.

stoppers)—are sufficient in many cases to prevent a recurrence of the B. ; but such a happy concurrence is not to be depended on, and we must be prepared to adopt some of the many surgical or artificial means for restraining the flow of blood till adhesion (q. v.) can occur between the cut surfaces of the coats of the artery. The principal surgical means are :

Immediate pressure, which may be applied by pressing the finger-tip on the place whence the blood is seen to flow, and may be kept up by pads of lint, or a coin of convenient size wrapped in cloth, and secured with a handage to the part.

Pressure on the artery above, or as it comes to the cut part. This requires some knowledge of anatomy, but not more than any intelligent person may easily acquire. Thus, pressure on the inside of the arm, about midway between its front and back, will press the brachial artery (q. v.) against the bone, and arrest any bleeding from wounds of the forearm and hand. Pressure on the middle of the groin with a thumb placed crosswise will control the stream of blood in the femoral artery, so that none can escape from any wound below where the pressure is made.

Pressure on the course of the vessel may be very efficiently effected by tying a handkerchief round the limb above where it is injured, and then inserting a stick, and twisting it sufficiently tight. This is the principle of the original tourniquet, which was invented by Morel, a French surgeon, at the siege of Besançon in 1674. He got the idea from seeing how carriers tightened the ropes which secured bales of goods on their carts. It has been modified from time to time. At present it consists of a strap and buckle, a pad which may be adjusted over the course of the artery wounded, or likely to be cut in an operation, and a screw by which the strap may be tightened as the surgeon may deem necessary. See **TOURNIQUET**. The objections to *pressure* as a means of arresting hæmorrhage, are, that it is very painful, that it includes the vein, and thereby engorges the limb with blood, and may cause mortification, if continued for any length of time.

'Actual' cautery, or hot iron, is occasionally useful in bleeding from a bone, or at some points where pressure cannot be efficiently applied. It is the oldest method of stopping bleeding, and until the 18th c. was much in use; but its abuse, and the natural horror felt for it by both patient and surgeon, have almost banished it from the list of surgical hæmostatics. If used, the iron should be at a white heat, the wound pressed for an instant, and then the iron should be held in contact with the bleeding vessel. It causes an eschar or slough, with shrivelling of the artery; and if the latter be small, it effectually stops the bleeding, until the eschar drops off, when the vessel may be found still pervious at the wounded part, and the danger of bleeding be as great as at first.

Ligature, or tying the artery, is a very old method of arresting hæmorrhage, and certainly the best. It was not used generally, however, in operations until improved anatomical knowledge and more efficient tourniquets allowed surgeons the time necessary for its application. See **LIGATURE**.

Another method has been recently introduced by Professor Simpson of Edinburgh, and already extensively used. He terms it *act-pressure*, or pressure from a long needle or pin inserted from without, so as to press the artery between it and the tissues. The pins are removed after twenty-four or forty-eight hours, the period being proportioned to the size of artery to be secured. This new plan promises to supersede the ligature, in amputations especially, where the vessels can be easily secured, and where occasionally they are found so brittle from disease

(see **ATHEROMA**) as to break under the pressure of a thread.

Venous B. is recognised by the dark colour of the blood, and its continuous flow. Pressure is generally found sufficient to arrest it, and it should be applied directly over the wounded part. Ligatures are not used to secure cut ends of veins, as inflammation of the lining membrane of these vessels is apt to spread along them towards the heart (see **PHLEBITIS**), and produce dangerous symptoms, and very frequently fatal results. There is not the same objection to the use of *act-pressure* plus. Of course, if a large vein is wounded in a part where compression cannot be readily applied, the surgeon should have no hesitation as to tying it; and if it is not cut quite through, he may pick up the cut edges in a forceps, and tie them so as to still permit a flow of blood through the vein.

Oozing from cut surfaces of course partakes of the characters of venous and arterial B., but there is no vessel sufficiently large to demand a ligature pressure. The actual cautery and cold may then be used, or one of the many styptics, the strong perchloride of iron may be specially recommended; it may be applied on lint or a sponge; or astringents, such as alum and tannin; there are also the puff-ball, mushroom, agaric, and matico leaves, cob-webs, felt, &c., which act mechanically, and owe their reputation chiefly to the pressure used in their application. Some persons have a congenital tendency to bleed (the hæmorrhagic diathesis); if such a one have a trifling cut, or have a tooth pulled, he bleeds perhaps to death. A prudent surgeon will not perform cutting operations on one of a hæmorrhagic family.

B. from the free surfaces of mucous membranes occurs when they are much congested. One may have fatal hæmorrhage from the stomach, and yet no open vessel may be found after death, even on the most careful examination. In such a case, we must trust to cold and internal remedies, such as acetate of lead combined with opium.

BLEEDING OR BLOODLETTING.—Blood may be drawn from a vein (phlebotomy—*venæsectio*), or from an artery (arteriotomy).

The veins most commonly opened for this purpose are those at the bend of the elbow (see **ARM**), but those of the lower limbs are occasionally selected. The patient should be placed sitting up in bed, as he may lose a dangerous amount of blood without shewing the usual premonitory symptoms, if his head be kept low.

The venous return should now be obstructed by a bandage, and when the veins swell, one should be selected, steadied with the left thumb, and slit obliquely with a lancet; the blood allowed to flow till the desired quantity has escaped, or till faintness comes on. The surgeon's thumb should now be replaced on the cut in the vein, and kept there till the handage is removed, when a small pad of lint and figure of 8 bandage will sufficiently prevent the bleeding, and the wound will speedily heal.

Phlebotomy was at one time habitually resorted to in inflammatory diseases, or such as were thought so; and even when there was no positive disease, it was often applied periodically at particular seasons, as spring and autumn, as a hygienic precaution. A great change in this respect has taken place in medical practice; as physiological knowledge advances, the opinion seems gaining ground that abstracting blood from a sick man gives him but temporary relief, and renders him less able to combat with the disease. When there is a wound of the cavities of the body with internal hæmorrhage, *venæsection* is very useful in lowering the heart's action, and, perhaps, according to the old theory,

in exercising a *derivative* influence on the wounded vessels. Local B. is effected by cupping and leeches. See articles on these.

Arteriotomy is generally performed on the temporal artery, by a transverse cut about half-way through the vessel. When the required amount of blood has been abstracted, it ought to be completely cut across, to allow of its ends retracting and healing. If this precaution is neglected, an aneurism (q. v.) would form. A compress and bandage should be put on the head for a day or two.

BLEIBACH, a town of Austria, province of Carinthia, in the circle of, and about 8 miles west of Villach, pleasantly situated in the valley of the Drau, or Drave, near the celebrated Bleiberg (Lead Mountain). The population, 5600 in number, are chiefly engaged in the mines of the Bleiberg—from which 1500 to 1800 tons of lead are annually obtained—and in washing and smelting the ore.

BLLENDE (Ger. *blenden*, to dazzle), a name given to a number of minerals composed chiefly of sulphur and of certain metals, all or almost all of splendid lustre, at least in fractures and the faces of crystals. It is also very often popularly applied more exclusively to one of these minerals, to which alone, perhaps, it originally belonged, ZINC B., or GARNET B.; also called, according to its chemical composition, *Sulphuret of Zinc*. Among English miners, it is known as *Black Jack*. It is abundant both in primitive and in secondary rocks in many parts of the world, and is often associated with Galena (q. v.), or Lead-glance. It contains about 66 parts of zinc and 33 of sulphur, and is used as an ore of zinc (q. v.); but the reduction of it is attended with difficulty, which much diminishes its value. It is usually brown or black, sometimes red, yellow, or green. It occurs both massive and crystallised in rhomboidal dodecahedrons, octahedrons, and tetrahedrons. Macles, or twin crystals, are remarkably common. It is very brittle; before the blow-pipe, it decrepitates violently, but only fuses on thin edges.—**MANGANESE B.** is a rare mineral, composed of sulphur and manganese.—**ANTIMONY B.**, or *Red Antimony*, is also a rare mineral, composed of sulphur and antimony.—**RUBY B.** is a name sometimes limited to Pyrrargyrite, or Red Silver (see SILVER, ORES OF); sometimes extended as a sort of generic term to include a number of other minerals composed of sulphur and metals, among which are Cinnabar (q. v.), Realgar (q. v.), and Orpiment (q. v.).

BLLENEAU, a village of France, in the department of the Yonne, about 29 miles west-south-west of Auxerre, celebrated as the place where Turenne gained a victory over the Prince de Condé in 1652. Pop. 1313.

BLE'NHEIM (Ger. *Blindheim*), a village of Bavaria, 23 miles north-north-west of Augsburg, memorable in connection with Marlborough's great victory over the French and Bavarians, August 13, 1704. The battle, however, did not actually take place here, but at a village in the vicinity called Höchstädt, and is known to the Germans by that name. France and Bavaria, on the one hand, stood opposed to Holland, England, Austria, Savoy, Portugal, and the German empire, on the other. The French and Bavarian army consisted of 56,000 men, commanded by Tallard, Marsin, and the Elector of Bavaria. Opposed to it was an army of 52,000 men, under the command of Marlborough and Prince Eugene. The French and Bavarian generals had no idea that the allies would act on the offensive, and accordingly, when, about two o'clock in the morning, on the 13th August, the line of the allies put itself in motion,

they believed that it was about to retreat. Even at seven o'clock, when the heads of the eight columns advancing under Eugene and Marlborough became visible, Tallard regarded the whole proceeding as a stratagem to cover the retreat. When the mistake was discovered, the army was hastily drawn up in battle-array, and fought with dauntless courage; but at five in the afternoon Marlborough broke through the line of battle, and won a victory most complete and decisive. The French and Bavarians left about 10,000 killed and wounded on the field, vast numbers were drowned in the Danube, and about 13,000, including Tallard, were taken prisoners. Altogether their loss was estimated at between 30,000 and 40,000; 120 pieces of cannon, and 300 standards, were captured. The loss of the victors amounted to about 5000 killed and 8000 wounded. Near to B., also, the French defeated the Austrians in 1800.

BLE'NHEIM DOG, or **MARLBOROUGH DOG**, a small and very beautiful variety of spaniel, much resembling the Cocker (q. v.) in form and general appearance, but generally of a black colour, with flame-coloured spots above the eyes and on the breast and feet. The muzzle is also fuller. The B. spaniel is the *Pyrame* of Buffon. It derives its English name from Blenheim Palace, in Oxfordshire, the seat of the Dukes of Marlborough, where the breed has been preserved since the beginning of the 18th c. These dogs are sometimes sold at an enormous price.

BLE'NHEIM HOUSE, near Oxford, the seat of the Duke of Marlborough, erected at the public expense in the reign of Queen Anne as a testimony of gratitude to the victor of Blenheim (q. v.). £500,000 was voted for the purpose, but that sum did not suffice for the completion of the work. The royal estate of Woodstock, in which it stands, was granted at the same time. The building was designed by Sir John Vanbrugh, and is a grand though heavy monument of his powers as an architect. The length of the principal front from wing to wing is 348 feet. The interior is proportionally magnificent, and the collection of paintings is one of the most valuable in Britain. Among the objects of interest in the grounds are a triumphal arch, and a column 130 feet high, surmounted by a statue of Marlborough. An inscription on the pedestal, written by Bolingbroke, recites the public services of the hero. The manor of Blenheim Park embraces a circuit of about 12 miles.

BLENNORRHOEA (*blenna*, mucus; *rheo*, to flow) is a medical term for an unusually copious discharge from any mucous membrane; but as it does not completely express the nature of such fluids, modern writers do not often make use of it. *Mucus* is a pellucid, ropy substance, which, according to Mr James Paget, 'has no corpuscles or organised particles' of its own. In those discharges termed blennorrhoeal, on the other hand, there is a mixture of epithelial scales shed in large quantities from the mucous membrane (mucus cells), and occasionally pus cells. In B. of the lachrymal sac, or what is called 'watery eye,' if the inner corner of the eye be pressed by the fingers, an opaque, milky fluid will appear between the lids, instead of the transparent tears which are present when the lachrymal apparatus is in health. After inflammations of the genito-urinary mucous membrane, a gleet discharge frequently occurs, and continues for a long period. The treatment consists in establishing a robust state of health by tonics and the preparations of iron, fresh air, and careful regimen, with astringent lotions applied directly to the mucous membrane, such as alum, tannin, &c., to lessen the

quantity of the secretion, and occasional caustic stimulants, as the nitrate of silver, to alter the depraved condition of the secreting membrane.

BLE'NNY (*Blennius*), a genus of Acanthopterygious (q. v.) fishes, the type of a family, *Blenniidae*, very nearly allied to the family of *Gobiidae* (see Goby), and by many naturalists included in it. To the B. family, the Wolf-fish (q. v.) and the Gunnel (q. v.) or Butterfish are referred. The fishes of this family are generally remarkable for the abundance of slimy matter with which their skin is covered.

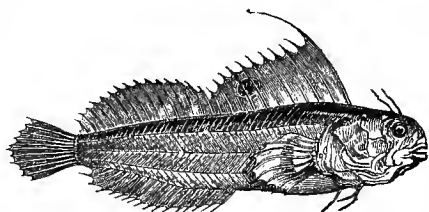

Ocellated Blenny or Butterfly Fish (*Blennius ocellaris*).

Many are destitute of scales. The body is generally of an elongated form. They have only one dorsal fin, which, however, seems in many of them as if composed of two parts. They are distributed in the seas of all parts of the world.—The true blennies are small fishes, living in shoals, which do not consist of great numbers, frequenting rocky coasts, and often found in pools left dry by the tide, or even among the wet sea-weeds, among which they are capable of subsisting for a much longer time than that of the absence of the tide. They possess the power of using their ventral fins to aid them in moving about among rocks and sea-weeds. They have a fringed appendage over each eye. They are seldom thought of as an article of food, but are much in request for the aquarium, on account of their tenacity of life and their activity. They feed chiefly on small crustaceans. Several species are found on the British coasts.—Many of the B. family retain their eggs within the oviduct until they are hatched, so that the young are produced alive, and capable of seeking food for themselves. An example of this is found in the Viviparous B. (*Zoarces vivipara*) of the British coasts.

BLÉ'RE, a town in the department of the Indre-et-Loire, France, is situated on the left bank of the Cher, which is here crossed by a bridge, said to owe its origin to Henry II. of England, about 15 miles east-south-east of Tours. B. is the entrepôt for most of the traffic on the Cher. Pop. 2000. In its vicinity is the castle of Chenonceaux, the residence purchased by Henry II. of France for the celebrated Diana of Poitiers, who lavished much money on its embellishment, as did also Catherine de Medicis, after she had dispossessed Diana. In 1733, it became the property of M. Dupin, whose wife, by her beauty and wit, attracted to the castle almost all the distinguished literary and scientific men of that day, including Montesquieu, Voltaire, Fontenelle, Buffon, Bolingbroke, and Rousseau. The castle escaped the fury of the revolution, and is still in a good state of preservation. Among the curiosities shewn to the visitor is the mirror used by Mary Stuart (Queen of Scots) on her marriage with the Dauphin.

BLE'SSÉD THY'STLE. See THY'STLE.

BLE'SSINGTON, MARGARET, COUNTESS OF, born September 1, 1789, at Knockwiet, near Clonmel, Tipperary county, Ireland, where her father, Edward Power, was settled. At the early age of fifteen

she was married to Captain Farmer, and shortly after his death, to Charles John Gardiner, Earl of Blessington. With him she took several extensive journeys on the continent, where, as well as in London, she gathered around her all the most distinguished men of the time. In Genoa, she formed an intellectual friendship with Lord Byron, and afterwards resided in Paris, until the death of her husband, in 1829. The latter left her a good fortune, which enabled her to gratify her literary tastes. She held a little court of her own, at her family mansion, Gore House, Kensington, a suburb of the west end of London. Her celebrated soirées were frequented by many of her distinguished contemporaries. Her subsequent connection with Count d'Orsay placed her in an equivocal position as regards society, and consequently, on the accession to power of Louis Napoleon, with whom both were intimate, they left England for France. Her ladyship died at Paris, 4th June 1849. She was the authoress of two works of little importance, the *Idler in France*, and the *Idler in Italy*. Her only valuable production is her *Conversations with Lord Byron* (1834), which helped to place the poet in a more favourable light before his countrymen.

BLE'TCHINGLEY, a town in the south-east of Surrey, 20 miles south of London. Pop. in 1851, 1553, chiefly agriculturists. Many Roman coins have been found in the vicinity. Near B., 2000—3000 tons of fuller's-earth are raised annually. In cutting the B. railway tunnel, the fossil bones of the iguanodon, an extinct reptile, were found.

BLETS, rotten spots in apples, pears, and other fruits. The rotting of such fruits is often called *bletting*. It takes place chiefly by the decomposition of the protein (q. v.) compounds which the fruits contain, and the fermentation of the sugar; carbonic acid is formed; and the fibres of a fungus can be discovered by the microscope pervading the bletted part, to the rapid extension of which they no doubt greatly contribute, although it by no means follows that the presence of the spores or seeds of the fungus should be regarded as the original cause of the decay.

BLICHER, STEN STENSEN, one of the most distinguished of modern Danish poets and novelists, was born in 1782, at a village of Viborg; and took his theological degree at Copenhagen in 1809. He remained with his father, himself a pastor in Jutland, till 1819, when he obtained a living, which he exchanged, in 1825, for a better. Independent in character, and belonging neither to the poetical nor scientific circles of the capital, he was long known only as the successful translator of Ossian, 2 vols. (1807—1809). His *Sneeklokken*, published in 1826, and still more, his contributions to the monthly periodical *Nordlyset*, brought him into fuller notice; and in 1829, his *Iydske Romanzer* had a great measure of success, and his *National Noveller*, giving an equally poetical and faithful picture of country life in Jutland, were even better received. As a poet, B. is thoughtful, tender, and eminently national, but he lacks objectivity. His novels appeared in 5 vols. (Copen. 1833—1836), his poems in 2 vols. (Copen. 1835—1836), and these have been followed by other works of the same kind, such as *Samlede Noveller og Dichte* (Copen. 1840), and *Gamle og nye Noveller*, 6 vols. (Copen. 1847—1848).

BLIDAH, a town of Algeria, in the province of Algiers, about 30 miles south-west of the city of that name. It is beautifully situated on the borders of the fine plain of Metidjah, is surrounded by gardens, and is a prosperous and rapidly growing place. It was occupied by the French in 1838. Pop. about 9000. It is a station on the first line of railway in

Algeria. The foundation-stone of the railway station was laid in 1869, in the presence of a large number of Arabs, who regarded the ceremony with intense interest.

BLIGH, WILLIAM, an English admiral, born 1753, celebrated in connection with the mutiny of the *Bounty*. Having made a voyage round the world under Captain Cook, he was sent out, December 23, 1787, by the British government, as commander of the ship *Bounty*, to Tahiti, there to collect bread-fruit-tree plants, and thence sail with them to the West India colonies, where government was anxious to introduce them. The ship arrived at her destination in October of the following year, and in six months after was ready to sail for Jamaica, with 1015 plants on board. Partly on account of their demoralisation by their lengthened residence on so charming and productive an island, and partly owing to the harsh and tyrannical treatment they met with from their commander, a part of the crew mutinied, after they had been twenty-four days out, on the 28th April, and forced the captain and eighteen men into the ship's launch, which they cast adrift, turning their own course back to Tahiti, and ultimately settling on Pitcairn's Island (q. v.). The captain and his companions, who had very little provision, and no sextant or map, arrived, after almost incredible hardship, at the island of Timor, on the 14th June, a distance of 3600 nautical miles from the point where they were abandoned. To the skill and prudence of B. the fact that not a single life was lost, is chiefly to be attributed. On B.'s arrival in England, a man-of-war, under Captain Edwards, was sent, at his instance, to capture the mutineers. Some of them were seized; the rest had escaped to Pitcairn's Island, with Fletcher Christian, the leader of the mutiny. Their place of refuge, however, was not discovered until 1808, when an American ship accidentally touched at the island. At that time, drunkenness, debauchery, and unbridled passion had left only one of the mutineers, John Adams, remaining. Their fortunes here were made the subject of a poem by Byron, entitled *The Island; or Christian and his Comrades*. B. was again sent out to collect bread-fruit trees, and convey them to the West Indies, in which he was completely successful. In the French revolutionary war, B. commanded a ship of the line, but again exciting the disaffection of his men by his harshness, they mutinied, and ran the ship into a French harbour. In 1806, B. was appointed governor of New South Wales, but his conduct here was so tyrannical as to cause universal dissatisfaction; and in 1808, unable to tolerate his rule, the civil and military officers of the colony summarily terminated his government by arresting him. He died in 1817.

BLIGHIA. See AKEE.

BLIGH ISLANDS, that portion of the Feejee Archipelago originally discovered by Tasman, in 1643, which was seen by Captain Bligh of the *Bounty*, during his wonderful voyage in an open boat. The group lies in nearly 180° of long. and 15° 30'—19° 30' S. lat.

BLIGHT, a diseased state of the cultivated grasses, especially of the cerealia. The term has been very vaguely and variously used, having, in fact, been applied to almost every disease of plants caused by the condition of the atmosphere, or of the soil, the attacks of insects, parasitic fungi, &c. It is frequently limited to the disease in wheat and other grains, which is also called SMUT-BALLS, BUNT, PEPPER BRAND, or STINKING RUST, in which, while the grain retains its usual form and appearance, the interior of it is filled with a powder of a very fetid odour, consisting of balls so minute that it is

calculated that four millions of them may exist in a single grain. These are a parasitic fungus, *Uredo caries* (*U. fetida* of some botanists). See SMUT.—The name B. has been frequently applied to diseases which seem to be caused by errors in the manuring of land, by which crops are often seriously injured. Unhealthy plants are most liable to be attacked by parasitic fungi, and by aphides and other insects, to which the origin of the evil has often been, in all probability, erroneously ascribed. Mr Berkeley, a high authority on such subjects, also states that 'there is a kind of B. sometimes very prevalent, which has been referred to fungi, but which is, in fact, nothing more than an excessive development of the epidermal cells, which are no longer kept within bounds by the real cuticle,' but become 'elongated and frequently branched in various ways, so as to form spongy or mealy patches, which are sometimes in such abundance as from their bright colour or peculiar aspect to attract general notice.' He adds that this is most common on woody plants, as vines and hawthorns, but that something analogous is to be seen on a few herbaceous species, 'a mere hypertrophy of the epidermal cells, or, indeed, mere fascicles of pubescence.' This kind of B., however, does comparatively little injury.

BLIND, THE, those who are without eyesight from birth, or who have lost their sight afterwards, and of whom jointly there are about 30,000 in the United Kingdom; this is about the ratio of 1 blind to 1000 persons who see, but on examining the census tables, it appears that while in the Channel Islands and the Isle of Man, the ratio is as high as 1 in 837, it falls to 1 in 1231 in the West Riding of Yorkshire. Local circumstances, not yet well understood, are doubtless the cause of this remarkable difference. The subject is eminently worthy of patient inquiry. Of the total number of 30,000 blind, a large proportion belong to the lower rank of life, such as labourers, soldiers and pensioners, domestic servants, weavers, and miners. All these are more or less exposed either to the inclemencies of the weather, or to incessant and continuous toil, involving considerable strain on the organs of vision, which, weakened by overwork, or, as in the case of the soldier, too often by intemperance and vicious life, soon give way. To these causes, the upper and richer classes are not nearly so broadly exposed, and therefore among them cases of blindness are comparatively rare. Another remarkable statistical fact is, that at the census in 1851, only one-seventh of the whole number of B. were found to be under 20 years of age; while 47 per cent., or nearly one-half, were 60 years of age or above it. The proportion of the whole population that attains that advanced age is only from 6 to 10 per cent. Of blind persons, on the other hand, under 20, a large majority are found to have lost their sight in infancy.

Blindness is *not* the mere absence or loss of vision, as one is apt at first to imagine it to be; it is far more. Blindness is a condition which few but those who practically know it can ever comprehend. The cloud which descends on the physical sight,

And renders all the world a darkened maze,

is far more deep and absolute than we are at first inclined to imagine. The loss of mere bodily vision alone is a fearful calamity; but far deeper is that inner dulness and deadness which so often follows the bodily affliction. The reader may know what it is to be plunged suddenly into darkness for a few minutes in a railway tunnel, and disagreeable enough is that amount of darkness; but he can form no conception of what the burden would be

if such blackness of darkness were to be continual. He does not know what it is to *hear* of things which the rest of the world *see*; to be driven to feel painfully and slowly what the eye surveys with ease and rapidity. 'The world of the blind,' says Prescott, the most famous B. man of modern times, 'is circumscribed by the little circle which they can span with their own arms. All beyond this has no real existence.' External, physical darkness is too often, therefore, not the only or the chief calamity in blindness, though it is in some measure an actual type of the gloom, doubt, and inability which befall it; and they who dwell in this region of darkness are to some extent actually cut off and divided from those who enjoy the light of heaven. And a border-line will ever separate the two regions; to efface which must be one aim of all education for the blind. Its grand object must be to connect them more and more with their fellow-men; to lead them into the same channels of thought, speech, and action with the rest of the world, and to save them, as far as possible, from the appearance of singularity. Some subjects in the domain of knowledge will always be beyond the B. man's reach. Light, colour, and space must ever be words which he cannot fully realise. Cheselden once favourably operated on a boy for blindness. 'It was two months before he discovered that pictures represented solid bodies; he thought them planes differently coloured;' and when he began to have some notion of the truth, in touching the canvas of a picture, he expected to find something solid upon it. 'I am told,' said a poor B. man to us, 'that the ocean is like an *immense green field*. But of what use is that? How do I know what *immense* is like, or what *green* is?' The words sea and sky do not convey the same image to the B. which they convey to us, and there must be a large class of words which falls under the very same category. But, on the other hand, though the circle of which Prescott speaks is a narrow one, yet within it the vision of the B. student has full sway. If Malebranche closed his shutters, and Democritus actually put out his eyes, in order to think and philosophise the more intently, the B. man always possesses the advantages for which they sought. The object of his thoughts rises from within, and the fact of its isolation renders his vision all the more keen and concentrated, as the rays of common sunshine once gathered into a focus, burn the hand on which they before fell harmlessly.

These facts are corroborated by the scanty reports of foreign B. schools, which, although they may differ slightly from our own in details of industrial work, are endeavouring, as a whole, to carry out the same systems as those pursued in Britain, excepting only the prominence given by us to religious instruction. The following list gives the names of the chief schools in Europe and America, with the dates of foundation, to which may be added those of Munich and Lausanne—famous for wood-turning—Christiania, and Madrid. America alone contains seventeen institutions for the B., all prosperous.

	FOUNDED		FOUNDED
Paris,	1784	Barcelona,	1820
Liverpool,	1790	Naples,	1822
Edinburgh,	1791	Gemund,	1823
London,	1800	Lintz,	1824
St Petersburg,	1806	Perth,	1825
Berlin,	1806	Freisingen,	1828
Vienna,	1804	Bruehal,	1828
Prague,	1804	Hamburg,	1830
Amsterdam,	1804	Boston,	1831
Zurich,	1809	New York,	1831
Dresden,	1809	Philadelphia,	1833
Copenhagen,	1811	Columbus,	1836
Stockholm,	1817		

Paris claims the high honour of having been first in the field.

One great characteristic of the B. is everywhere found to be their concentration and individuality of purpose. The loss of *external objects* in forming certain conceptions or ideas is compensated for by the gain of not being liable to their intrusion in tangible reality when not wanted. Whatever the B. man really undertakes, he does with all his might. It may be the making of a basket, or a pair of shoes—the learning of a new psalm, or the use of a knife—finding his way through some new territory, tuning a piano, or mastering a piece of music—but the one pursuit is carried on with steady, unremitting zeal. 'There is,' says Coleridge, 'in the heart of all men a working principle, the instinct and necessity in each man of declaring his particular existence, and thus of singularising himself.' Such consciousness of power may in some cases be closely allied to what we call vanity, but far oftener it is the root of a far different plant. The B. man believes that he *can do*, and therefore *does*. 'Work without hope draws even nectar in a sieve,' and this seed of self-confidence is often to him as a mainspring of hope.

If we sum up the characteristics of the B. as a class, we shall find them to be thoughtful and diligent, with peculiar sensitiveness of mind and feeling; shy of expressing their thoughts before strangers, grateful for every little kindness; equally tenacious in remembering the least affront; yet often self-willed, conceited, and opinionative. These are but the natural results of such education as they get, of scanty information, and a narrow field of observation and acquirement. Of the thirty thousand in Great Britain, it is said by Mr E. C. Johnson, in his *Tangible Typography*, that two-thirds cannot even now read, after all that has been done for them, and that certainly more than a half are without any education. The educational movement on behalf of the B. began at the close of the last century; first, it is said, at Liverpool, then in London, and then in the other great towns and cities of England. Schools are now established in almost every district of the country, the chief ones being in London, Manchester, Liverpool, York, Exeter, Bristol, Newcastle, Birmingham, Glasgow, Bath, and Edinburgh. At the Liverpool School, the whole time is all but entirely devoted to industrial work, any chance leisure that the teachers can spare being given to reading; but in almost all the other schools, a portion of each day is given to instruction in the school-room, and that with the best results; for, independent of the intellectual gain thus accruing to the pupils themselves, the mere change of employment gives a zest and freshness to the industrial work, which it is most desirable to cultivate. As soon as a B. boy begins to take an interest in his work, he is likely to do it as well as he can.

Basket-making, mat-making, weaving worsted rugs and cocoa-nut matting, shoe-making, brush-making, knitting netting, and hair-work are chief among the trades which the B. practise with success, even after they leave the school at which they have been trained; as may be judged from the fact that goods of this kind to the amount of upwards of £1200 are annually sold at the School for the Indigent Blind in St George's Fields, London. At this institution, probably the largest and most efficient B. school in Europe, about two-thirds of the working-day of eight hours are given to industrial work, and the remainder to the study of music, religious instruction, reading, writing, and ciphering, exclusive of course of the time spent at morning and evening prayers in the chapel, as well as exclusive of a portion of the leisure hours devoted to the instruction and practice of a large instrumental

band of about thirty performers. The examiner of the boys' school, at Christmas last, reported favourably as to their proficiency in reading, religious knowledge, ciphering, embossed writing, English history, and geography. A few also worked some problems in Euclid for him in very good style.

The study of music is the blind man's passion and delight; he gives to it, where he has real musical genius, all his best energy and heart, and in this pursuit he is, least reminded of his special infirmity. He finds in it scope for the highest imagination, as well as the deepest and holiest aspirations. Some few B. men have even become truly famous as musicians, two of them so famous, that even Handel himself expressed great delight at their wonderful skill. Yet, a pleasing mediocrity is the average attainment of B. players, rendered more remarkable by the extreme difficulties under which it has been acquired. The thirty performers above alluded to gave a public concert at the Hanover Square Rooms in the year 1858, and cleared upwards of £120, after all the heavy expenses were paid; but the same report which chronicles this achievement goes on to say that, 'though an attractive feature in the school, it is difficult to assign the band a higher office than that of supplying to the pupils a most pleasant and welcome recreation in their leisure hours.' It is true that some musical pupils obtain situations as village organists, but it is also true that a large number do not; while it is asserted that devotion to music almost always precludes a mastery at any industrial work; so that the clever organist is very rarely able to earn anything towards his living as a basket-maker or mat-maker, &c., and if he can obtain no musical employment, his past labour proves a mere waste of time, unless his friends can provide him with an organ or piano. Embossed music, palpable to the touch, has been tried in instructing the B., but without success, so that all depends on the pupil's power of memory, quickness in catching the articulation of a passage of music which is read over to him, just as an ordinary sentence to a boy writing from dictation. Fingering is gradually acquired from the teacher's explanation, strengthened by practice, and at last so far mastered that no ordinary 'phrase' presents any difficulty. In this way, many a B. boy and girl has been known to learn the whole of the accompaniments of such works as the *Messiah* and the *Blijah*, as well as some of the intricate fugues of Bach. Once learned, they are rarely, if ever, forgotten by the B. musician, if he has but an instrument for occasional practice.

We now have to speak of the different systems of embossed printing (in raised type) by which the B. are taught to read. These are divided into two distinct classes, which may be named, 1. *Alphabetical*, and 2. *Arbitrary*. These two great classes comprise the following subdivisions: *Alphabetical*.—1. Alston's System of Roman capitals. 2. The American, a smaller capital with serrated edges. 3. The French Alphabetical. 4. The Roman Letter, modified, as at Bristol, by use of lower-case type; or by a slight alteration in the shape of the letters, as in the books of the Printing Society for the Blind. *Arbitrary*.—1. Lucas's System. 2. Frere's System. 3. Moon's. 4. Le Systeme Braille. 5. Le Systeme Carton.

The invention of the arbitrary, short-hand, or symbolic systems has done more to impede the cause of real education among the B., than almost any calamity that could have befallen them. Not only do they throw unnecessary obstacles in the way of the B., but the increase in the number of systems has divided the friends of the cause, and the funds at their disposal, into so many distinct

channels, as utterly to mar the success which all desire, and which unity of purpose and action alone can give. Each system has its own band of unwearied advocates, and no 'Battle of the Books' was ever fiercer than that waged between the separate partisans. The consequence is, that few as the books for the B. have hitherto been, they are likely to become practically fewer. Few B. persons among the poor ever master more than one system; and the books in all other systems but the one he has learned are as unintelligible to the B. man's touch as if in another language. Mr Alston of Glasgow was the first to adapt the Roman letter in embossed printing to the use of the B.; and we entirely agree with him that arbitrary characters, however ingeniously constructed, throw unnecessary obstacles in the way of the blind. He therefore chose the ordinary Roman capital letters, as being at once the simplest and most easily felt, and on every other ground the best, for the following reasons: 1. The system of printing for the B. should expressly aim at drawing them more and more into closer connection with the rest of the world. As far as possible, they should read the same books in the same type as those who have eyes, in order that the blind scholar, in learning to read, may have every possible help from words which he may *formerly* have seen, but which *now* his fingers must decipher; and also because that, if puzzled, he may get help from any one who can read an ordinary book, or if needful, that his friend may read to him. 2. It should present the words correctly spelled in full, that when he learns to write, it may be in such a manner that others can read. 3. The raised characters must be sharp and well defined, such as the finger hardened by work, and the soft touch of the child, may be able to discern. No other system but Alston's can offer such requisites as these.

To the same effect speaks the Rev. W. Taylor of York, one of the highest authorities on all points connected with the blind. 'No alphabet,' he says, 'possesses so many advantages as the Roman alphabet.' 'I would discourage all systems of embossing,' says the late Mr Hughes, governor of the B. school at Manchester, 'which could not be read and taught by seeing persons.' And in accordance with these opinions is the belief of the great majority of B. persons themselves. As a class, the B. wish to learn to read, and all parties are anxious that they should do so, and yet eager and unwearied partisans are disputing on the very threshold of the work as to how it shall be done.

The *American* books are all printed on a modification of Alston's plan, and, as a whole, may be regarded as successful, being smaller in bulk and cheaper in cost than those published in England. But the smallness of the type prevents its being felt by any but the most skilful of those used to the larger Roman capital. The books printed at Paris by M. Dufau, before the employment of an arbitrary system of dots, were in rounded lower-case letters with Roman capitals, and liable to the same objection as the *American* books. The Printing Society for the Blind (St George's Fields, Southwark) has published several thousands of volumes in the Roman capital, which have met with a ready sale, as the books are sold at far less than cost-price, and include the gospels of St John, St Matthew, and St Mark, the book of Job, the Psalms, *Robinson Crusoe*, *Sunlight in the Clouds*, an English grammar and history, besides some smaller tracts; but though the type and paper are excellent, the work flags for want of funds.

Lucas's System professes to be to the B. reader what short-hand would be to a seeing person

ignorant of the alphabet; but unlike other stenography, it is no savor of space. The New Testament in American type occupies 430 pages; in Alston's, 623; in Lucas's, 841. His omissions increase the bulk of his productions. All letters, he says, not necessary to the sound are omitted; as, *da* for *day*, *mit* for *might*, *no* for *know*. The reader has but to think of such words as *fit* and *fight*, *wight* and *wit*, *lit* and *light*, to discover at once what fearful results must ensue in the blind man's spelling from a score of similar laws of omission. *No* may certainly stand for *know*, or *e i r* for *heir*; but what can be said of such a rule as No. 2?—*When the sound of a word is decidedly different from the spelling, the spelling is altered.* Thus, *surely* becomes *shurly*, *said* is turned into *sed*; and if a *laugh* results, it must be clipped into a *laf*. But this is not all; single letters stand for words; thus, *q* stands for *queen* and *question*, *y* for *yet* and *yesterday*, *m* for *me* or *my mother*, *P H* for *six*, or *Pharisee*, or *sixth*. One example more, and we have done with this poor attempt at stenography. If we turn a common sentence into *Lucasian dialect*, such as, *He may yet save me with patience*, it becomes—*H. ma. y. sav. m. w. p.;* but unfortunately for the B. man, it may also stand for *Have may yesterday save mother world upon;* or have a third interpretation—*Hither may ye save amongst world put.* Yet books are printed in this extraordinary mongrel system, and though no hornbook ever devised presented such horrors to the child with eyes, are actually prepared for the edification of people without sight. Extraordinary as this system may appear in ordinary type, still more mysterious does it become to the B. when printed, in Lucasian symbols; the above passage assuming this form :

The entire alphabet is as follows :

A B C D E F G H I

J K L M N O P Q R

S T U V W X Y Z

Well, therefore, may Mr Frere say of this system: 'It is neither orthographical nor phonetic; it accords neither with spelling nor speech, and when made intelligible by being rendered into common characters, is equally offensive to the eye and ear.'—*Letter to Lord Lansdowne.*

Of Mr Frere's own system, also stenographic, we can speak more favourably. Instead of letters, we are now introduced to sounds hissing, sounds guttural, gushings, breathings, and aspirations, which are represented by thirty-six characters. 'This system,' says its author, 'may be denominated a scientific representation of speech, the alphabet containing one character, and but one, for each of the simple sounds of the English language, whose only names are the sounds they represent; each word being embossed according to its actual pronunciation, the names of the characters combined give the word; and the pupil is thus *nearly enabled to read as soon as he has learned his alphabet.*' In the one word '*nearly*' lies the fallacy of the whole matter. There is no royal road to learning to read

—for pupils with or without eyes—by virtue of any system whatever. Mr Frere meant and should have said: 'The pupil will in due time, if he persevere, learn to read as soon as he has learned his alphabet.' But this may be safely predicated of the plain old Roman letter. Alston's system is far more easily learned, and far more easily taught than the phonetic, in spite of all Mr Frere's ingenious combinations, his twelve rules in verse, and his laborious *memoria technica*. One single example will prove the truth of our remark. A certain sign, \sphericalangle , represents the sound *Ch*; to imprint which fact on the B. child's mind he is required to learn by heart (and to repeat every time he meets \sphericalangle *ch*) the following pleasant morsel: '*An angle, the points forwards, the straight line downwards, the same as a half circle, the points forwards, the dot downwards, is ch; ch is CHanged from a crescent by a dot on its lower limb; atch, utch, utch.*' It is only necessary to add that there are twenty-nine such little refreshers as this, and that Rule 12 says:

When'er the proper rule don't yield you satisfaction,
On trial you will find the word is a contraction.

But many B. persons have learned to read by Frere's system, for both he and his advocates are most skilful and unwearying teachers. The ingenious and kind-hearted author of this system has devoted a life to the cause of the B., whose warmest thanks he most truly deserves. His books, admirably embossed, and not so dear as Moon's, are most valuable as an adjunct to, but not a substitute for, Alston's.

A few words as to Mr Moon's, and our brief notice of the systems is concluded. Mr Moon, himself a B. man, has invented a system. 'In order to avoid the complicated form of the Roman letter, he has invented,' he says, 'an alphabet, each letter of which is formed of two lines only,' and most of them partially resembling those in common use. The following specimens of Mr Moon's alphabet do not, it must be confessed, furnish any great proof of his success in preserving resemblance:

ROMAN.				
P	Q	R	S	T
MOONISH.				
ROMAN.				
H	I	J	K	L
MOONISH.				

This system claims the freedom of an arbitrary character, and the advantages of an alphabetical one; it professes to be at once like and unlike the same thing, and proves its title to neither claim. It is among the bulkiest and most expensive of all the systems, and can never be adopted by any but its own partisans. If the Printing Society complete their New Testament, it will sell for less than £2, while Mr Moon's costs £4, 10s.

Looking at all that has been done for the B., it may be safely asserted that much yet remains to be done for them intellectually. There is no reason why their education should not take a far wider stretch; if well taught, they are debarred from few sections of knowledge but the special ones affected by their special calamity, such as light and colour. The men of genius among them

may not become poets, but they may learn to understand and enjoy poetry. To cite Homer and Milton as blind poets, is utterly beside the question; they enjoyed years of light, and became poets ere darkness fell on them. The B. man's other senses cannot compensate for the one gone; but they may do double duty, and grow keener by use. His judgment, his reason, his intelligence, his passions of love, admiration, and curiosity, if shattered by the blow which deprives him of sight, are not destroyed. They may be quickened, roused, and cherished into new life, and he will surely find that God has still left to the B. man a thousand avenues of pleasure, wisdom, and inward light, which will yield true and golden fruit.

BLINDAGE. When a besieged town has little or no bomb-proof shelter, screens are sometimes used called B., made of timber and earth; or of trees inclined towards each other, or placed in an inclined position against walls.

BLIND COAL. See ANTHRACITE.

BLINDNESS may arise from any cause intercepting the rays of light on their way to the optic nerve, or from disease of the optic nerve, or of that part of the brain connected with it. B. may vary in degree; it may exist from birth, or be the result of extreme old age. It may only be present during the day or the night, or a few weeks of the year, or it may be permanent.

Congenital B. is generally from some deficient development of the nervous apparatus, and is detected by the child being indifferent to light, and throwing its head from side to side. Occasionally, but very rarely, the power of vision is subsequently developed. Amaurosis has been already described.

Opacity of the vitreous humour, or of the crystalline lens—the latter is generally known as cataract—causes B., which comes on gradually. The patient with cataract can see best in the evening, or when the pupil is dilated, as then some rays of light are able to enter by the side of the opacity. The B. from cataract is seldom so complete as to prevent the person from distinguishing day from night, or from being aware of opaque bodies passing between him and the light (see CATARACT). Opacities of the cornea, if extensive, or in the axis of vision, produce some degree of B., whether they are on or in its substance. In general, these are irremediable; but if there is a spot, an artificial pupil may be made. Some years ago, Mr Bowman, of London, met with a case in which the opacity consisted of a layer of phosphate and carbonate of lime: he removed it, and restored the vision, which had been totally lost for several years.

Night B. is a rare condition, in which a person finds, towards evening, that objects are becoming less and less distinct, and at last that he is totally blind. This may occur without previous warning, and cause great alarm, but next morning he finds that his sight is restored. This is repeated every night, but at last the eyes become weak during the day also, and may finally become amaurotic. This strange affection may be epidemic; it has attacked bodies of troops exposed to great fatigues and the glare of the sun's rays. If there are no symptoms of disease within the brain, recovery generally results from protecting the eyes from the light, entire repose, such remedies as correct any constitutional defect in the individual attacked, and repeated blistering.

Day B. is characterised by inability to see in a bright light; the subjects of it see more than usually well at night, but during the day have to be led about. Captives who have been long immured in dark cells

are often affected with it, as a galley-slave mentioned by Larrey, who had for thirty-three years been shut up in a subterranean dungeon, and when liberated could only see by night.

The structural causes of B. will be better understood when the eye (q. v.) is described, when it will be seen that advances in our knowledge of its anatomy have enabled surgeons to restore sight in cases which, some years ago, would have been considered hopeless; but it can never be too strongly impressed, especially on the young, that overwork wears out the eyes, whatever be the pursuit, and that, without being wholly dark, a degree of blindness may be induced, such as to render the eyes useless for practical purposes. This condition, asthenopia or weak sight, is frequently met with in young lads with sedentary occupations, students, dressmakers; and, says Dr Mackenzie of Glasgow, 'what may be called the hot-house education of modern times is a fruitful source of it.' The only cure is avoiding the evident causes.

BLINDNESS, COLOUR. See COLOUR BLINDNESS.

BLINDSTORY, another name for the *triforium* (q. v.), the second or middle arcade in the wall which separates the body from the aisles of a church. It is so called obviously as opposed to the *clearstory* or *clerestory* (q. v.), the third and uppermost arcade, the apertures of which admitted light into the church, while the apertures of the triforium were dark—*obscuræ fenestrae*, as they are termed by Gervase of Canterbury. The B., which is most common in cathedral, conventual, and collegiate churches, served to give access to the various parts of the building, and to suspend tapestry and banners on high holidays. Viewed aesthetically, the gloom of the B. contrasts well with the lustre of the clerestory.

BLINDWORM (*Anguis fragilis*), a small reptile, which, although it has commonly been ranked among serpents by naturalists, in consequence of agreement in general form, exhibits remarkable points of difference from the true serpents, and constitutes one of an interesting series of links by which they are connected with lizards. Mr Gray has therefore recently united this, and other nearly allied genera, with the Scink and Seps family of saurian reptiles under the name of *Sauvrophidia* (Lizard-serpents), amongst which the gradation from the lizard to the serpent structure is marked by the more and more complete disappearance of limbs, and the increasing elongation of the

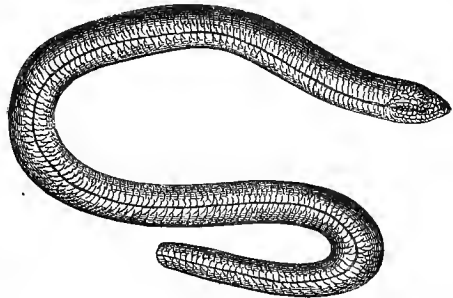

Blindworm.

body. In the genus *Anguis* there is no trace of limbs externally, but the bones of the shoulder, the sternum or breast-bone, and the pelvis still exist in a rudimentary condition: the bones of the head, also, connect it with lizards, and do not

BLISTERED STEEL—BLOCK.

admit of that dilatation of the gape which characterises true serpents. The common B. is the only species of this genus known in Britain. It is found also in almost all parts of Europe. In some districts of Britain it is plentiful; in others, it is very rare or even unknown. It is a perfectly inoffensive creature, although it has very generally been persecuted by the ignorant as extremely venomous. Its teeth are so small that even when it attempts to bite, which it only does upon much irritation, it cannot pierce the skin. No species of the group to which it belongs has poison-fangs. It is very timid, and when alarmed, contracts itself forcibly, and then becomes remarkably brittle, so as to be easily broken in two by a blow or by an attempt to bend it. This character of fragility is found also in other animals of this group. The name B. has apparently originated in a mistake caused by the smallness of the eyes, which, however, are very quick and brilliant. Another common name, *Slow-worm*, is more accurately characteristic. The length varies from 11 to 15 inches, and sometimes even exceeds this; the thickness is almost equal throughout, the tail is blunt at the end; the scales are small, and nearly equal; the tongue is notched at the extremity, but not bifold as in snakes; the colour is generally silvery gray, a dark line runs along the back, and frequently rows of dark spots along the sides. The food of the B. consists of slugs and insects. It retires in autumn under masses of decayed wood and leaves, or into soft dry soil. It changes its skin. It is viviparous (ovoviviparous), the number of young varying from 7 to 12 or 13 at a birth. The name B. is sometimes given to *Cæcilia* (q. v.).

BLISTERED STEEL is the variety of steel employed in the manufacture of files, tools, and other articles generally comprehended under the term *hardware*. The B. S. is prepared by a process of *cementation*, which consists in heating bars of malleable iron in fire-brick or stoneware boxes, along with cement powder. The latter is made up of 9 parts of charcoal, and 1 part of common salt and wood ashes; and this mixture is first placed in the bottom of the boxes to the depth of about an inch, then the bars of iron, more cement, another series of bars, and so on till the box is nearly full, when the remaining space is filled up with cement-powder, and above all there is placed a three-inch layer of damp sand. The box is then gradually heated to redness, at which temperature it is kept for six or eight days, when the process is complete. When the bars of iron are taken out of the cementation box, they are found covered with *blisters* or *blebs* on the surface. The chemical changes that occur during the heating are, that the almost pure malleable iron absorbs and combines with about 1½ per cent. of carbon, which is retained in the steel, while a small amount of carbon, combining with a trace of oxygen in the iron, forms carbolic oxide (CO), which, escaping from the iron bar, occasions the blisters or blebs. When malleable iron is converted into B. S., it becomes more fusible, ceases to be fibrous in texture, and when a bar is snapped across, it exhibits a close fine-grained metal. *Cast Steel* (q. v.), *Silted Steel* (q. v.), and *Shear Steel* (q. v.), are prepared from blistered steel.

BLISTERING FLIES. See **CANTHARIDES**.

BLISTERS are medicinal agents which, when applied to the skin, raise the cuticle into small vesicles filled with serous fluid. They are applied either in the form of plasters or in a fluid state, as suits the convenience of the person or part, and have for their object the establishing of a counter-irritation or diversion of inflammatory action from a part in which it cannot be reached by remedies,

or from some organ where it may do permanent mischief, to some more superficial part of the body.

The most common blister in use is made of cantharides (q. v.) or Spanish fly (*Cantharis vesicatoria*). Cantharides, mixed with a convenient proportion of lard and wax, form the blistering ointment of ordinary use; the only objection to this preparation being, that if applied too long it produces distressing affections of the urinary bladder. In young children and very thin-skinned persons, a layer of silver paper, or thin gauze wet with vinegar, may be laid between the blister and the skin. But under no circumstances should a blister be left long upon children, as it may produce sores which are apt to take on an unhealthy action, and are difficult to heal.

Mustard (*Sinapis nigra*) is frequently used, but seldom left on sufficiently long to produce blistering. Tincture of cantharides, croton oil, and strong liquor ammonia, tartar emetic ointment, and many others are used in practice.

If the occasion for the blister passes off, the vesicles should be pricked, and their fluid contents allowed to trickle away, the vesicated surface being then dressed with some cold cream or lard. But if it should appear desirable to promote a discharge from the skin, the raised cuticles may be snipped off, and the blister either applied again at intervals, or some stimulating ointment as the savine (*Juniperus sabina*) made use of. Great cleanliness should be observed in dressing the part.

Of late years, B. have been much used for the dispersion of glandular tumours, and are also applied over the surfaces of indolent ulcers, with the view of increasing the vascularity of the part. For old diseases of joints, B. ought to be placed at a little distance from the affected joint.

BLOCH, MARCUS ELIESER, a celebrated ichthyologist, born of poor Jewish parents, at Anspach, in Bavaria, 1723. He was allowed to grow up in extreme ignorance. At 19, he had read nothing except a few useless rabbinical treatises. About that age, however, he became assistant to a Jewish surgeon at Hamburg, where he took the opportunity of learning German and Latin. A slight knowledge which he had acquired of anatomy inspired him with an extraordinary desire to study that science thoroughly. For this purpose he went to Berlin, and devoted himself to it and other branches of natural history with indefatigable zeal. He took the degree of Doctor of Medicine at Frankfurt-on-the-Oder; and returned to Berlin to practise his profession, where he died 6th August 1799. His great work is the *Allgemeine Naturgeschichte der Fische* (12 vols., Berlin, 1782—1795, with 432 coloured plates), long the most comprehensive work on ichthyology, and still valuable especially for its pictures. His *Systema ichthyologicæ iconibus CX illustratum*, which was left in an unfinished state, was published by Schneider (Berlin, 1801). After his death, his collection of fishes was purchased by government, and forms a part of the Berlin zoological museum.

BLOCK, in the rigging of a ship, is an important part of the apparatus necessary for raising sails and yards, tightening ropes, &c. The B. comprises both the frame or shell, and the pulley or pulleys contained within it. In seamen's language, a *tackle* includes the rope as well as the B. through which it works. The uses of blocks are very numerous on shipboard; and to subserve these uses, they are distributed about the masts, yards, sails, and ropes. They vary greatly in size, shape, power, and designation; but nearly every B. comprises a *shell* or wooden exterior, a *sheave* or wheel on which the

rope runs, a *pin* or *axle* on which the sheave turns, and a *strap* (of rope or iron) to fasten the B. to any particular station (see *PULLEY*). A single B. contains only one sheave; a double B., two; and so on. Besides the designations of blocks according to the number of sheaves they contain (*single, double, treble, fourfold*), ships' blocks receive numerous other names—such as *bee-B., cut-B., cheek-B., clew-garnet B., clew-line B., &c.* Some of these names depend on the kind of service, others on the place of fixing; while the rest are examples of the odd nomenclature adopted by seamen.

Block-making.—Ships' blocks were made by hand until about 80 years ago. But mere workers in wood could not produce them; it required unusual skill and practice to fashion the several pieces, and put them together so as to possess the requisite strength and facility in working. The trade was either carried on alone, or in conjunction with mast-making. More than 1400 such blocks were required for one of the old 74's, and a proportionate number for vessels of larger or smaller size.

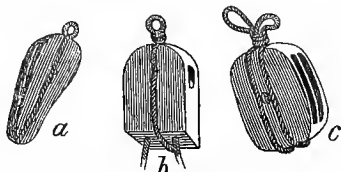

Various forms of Ships' Blocks :

a, long-tackle block; *b*, clew-line block; *c*, double block.

In 1781, a Mr Taylor began to make the sheaves and shells of blocks by a process which he had invented. He made all the blocks for the royal navy until the expiration of his patent rights. The Admiralty then commenced the manufacture on their own account. In 1801, Mr (afterwards Sir) Mark Isambard Brunel submitted to the Admiralty a working-model of a very beautiful system of machinery for block-making; it was accepted, and the inventor engaged to set up the apparatus at Portsmouth. So intricate was the machinery, and so great the difficulty in procuring the several working-parts from the machinists of those days, that it was not until the year 1808 that the system was put into effective operation. It was then, however, so perfect, that very few additions or improvements have since been needed. The machinery made blocks more accurately than they had ever been made by hand, and with the aid of ordinary workmen only. It could effect £50,000 worth of work in a year, or 140,000 blocks, by the assistance of ten men attending the machine. Duplicate machinery was made for Chatham. Brunel received £20,000 for his invention and for his personal superintendence until the machinery was brought into working-order; this sum was money well laid out, for the machine saved to the country more than £20,000 a year, in the busy warlike period from 1808 to 1815. The machinery itself is too complicated to be described except at a length incompatible with the limits of this work; but it may be stated in a general way, that the system is made up chiefly of saws and lathes, combined with great ingenuity. The blocks are made of elm, and the sheaves of *lignum vitæ*; the pins are of iron, carefully prepared to avoid friction as much as possible.

BLOCKADE, in military tactics, is an operation for capturing an enemy's town or fortress, without a bombardment or regular siege. The attacking party throws up works on the neighbouring heights and roads; these works may be redoubts, for 200 or 300 men each, raised around at distances of 1000 or 1500 yards asunder; or they may assume

other forms, according to the circumstances of each case. The rest of the besieging force remains under cover in villages, or in a temporary camp, ready to repel any sortie attempted by the besieged. The whole purpose in view is to prevent the besieged from receiving supplies of any kind, in order that, when the food or the ammunition is exhausted, they may be compelled to surrender. Fortresses situated on steep and rocky eminences, difficult to conquer by bombardment or assault, may often be reduced by B.; because the roads or paths for the reception of supplies are few, and can be watched by a small number of troops. Towns situated on a plain are less frequently invested. If the inhabitants be numerous and commercial, they will soon be impatient of the restraint produced by a B., and may compel or induce the governor to adopt a plan opposed to his wishes as a soldier. If, however, a resistance be determined on, the governor sends out of the town as many non-combatants as possible; all the stores are collected in bomb-proof receptacles; economy is observed in the consumption of food; all the people within the walls are placed under military rules; and the governor endeavours, by frequent sorties, to prevent the besiegers from making too close an investment of the place.

Blockading, in a naval sense, is the prevention of the entrance or exit of the enemy's ships at a particular port. It occurs sometimes as an auxiliary to military operations by land; but on others it is limited to a maritime investment.

BLOCKADE, in international Law, is the means, in time of war, of rendering intercourse with an enemy's port unlawful on the part of neutrals; and it is carried into effect by an armed force (ships of war), which blocks up and bars export or import to or from the place blockaded. This right is described by all writers on the law of nations as clear and incontrovertible, having its origin in the soundest principles of maritime jurisprudence, sanctioned by the practice of the best times. It is explained on the reasonable theory, that if a potentate or government lays siege to a place, or simply blockades it, such potentate or government has a right to prevent any other power, or representative or subject of such power, from entering, and to treat as an enemy any one who attempts to enter the blockaded place, or in any way assist the besieged, for such a person opposes the undertaking, and contributes to the miscarriage of it.

Lord Stowell laid it down that there are two sorts of B.—one by the simple fact only, the other by a notification accompanied with the fact. In the former case, when the fact ceases—otherwise than by accident or the shifting of the wind—there is immediately an end of the B.; but where the fact is accompanied by a public notification from the government of a belligerent country to neutral governments, the B. must be supposed to exist till it has been publicly repealed. This notification it is the duty of the belligerent country to make immediately. His lordship also explained that, on the question of B., three things must be proved: 1st, The existence of an actual B.; 2d, The knowledge of the party; and 3d, Some act of violation, either by going in or coming out with a cargo laden after the commencement of blockade. On this last point, the time of shipment is very material; for although it might be hard to refuse a neutral liberty to retire with a cargo already laden, and by that act already become neutral property, yet, after the commencement of a B., a neutral cannot be allowed to interfere in any way to assist the exportation of the property of the enemy. After the commencement of a B., a neutral is no

longer at liberty to make any purchase in that port. But the most essential element is *actual* B., and this state of things can only be proved to the satisfaction of a court of justice by the ships stationed on the spot to maintain the B. using their force for that purpose. A B., therefore, is only to be considered as actually existing when there is a power to enforce it.

To be valid, a B. must be accompanied by actual investment of the place, and it may be more or less rigorous, either for the purpose of watching the operations of the enemy, or, on a more extended scale, to cut off all access of neutral vessels to that interdicted place, which is strictly and properly a B.; for the former is, in truth, no B. at all, as far as neutrals are concerned. But to be binding on neutrals, it ought to be shewn that they have knowledge, or may be presumed to know of the B.; and this knowledge may arise in two ways—either by such a public and formal notification as we have already described, or by the notoriety of the fact. Yet it is at all times most convenient that the B. should be declared in a public and distinct manner, instead of being left to creep out from the consequences produced by it; and the effect of such notification to the neutral government is clearly to include all the individuals subject to the latter.

The breach of B. may be either by coming out of the blockaded port, or going in; such breach, however, may sometimes be excusable. It has been decided that intoxication on the part of the master of a ship will not be received as an excuse. The breach of B. subjects the property so employed to confiscation; there is no rule of the law of nations more established than this, and it is universally acknowledged by all civilised governments. The violation of B. by the master, however, affects the ship, but not the cargo, unless the cargo is the property of the same owner, or unless the owner of the cargo is cognizant of the intended violation.

On the proclamation of peace, or from any political or belligerent cause, the continuance of the investment may cease to be necessary, and the B. is then said to be *raised*. The blockading force then retires, and the port is open as before to all other nations.—See the law on the subject of this article extremely well stated in *A Manual of the Law of Maritime Warfare*, by William Hazlitt and Henry Philip Roche, Barristers-at-law, 1854; see, also, ORDERS IN COUNCIL, BRITISH.

BLOCKHOUSE is to a temporary fortification what a tower is to one that is permanent. In a wooded country, it is easily and quickly made, and the enemy cannot readily bring guns to bear upon it; on flat open ground it is less useful. The B. is always a covered defence, unlike a battery; sometimes with only one story, sometimes with two, of

ditch, *d*; and *e*, a mass of earth to cover the roof. The loopholes for musketry are shewn at the side. The defence is usually by musketry. If opposed to infantry only, single rows of trunks of trees, either upright or horizontal, make a very good B., loopholed at intervals of about three feet; and if there be earth enough quickly obtainable, by digging a ditch or from any other source, to embank it all round and to cover the roof, it will bear a great deal of rough usage. If opposed to artillery, the B. requires to be formed with double rows of trunks three feet apart, with well-rammed earth between them. The American backwoodsmen build blockhouses with great quickness and efficiency; several of these, with a curtain or continuous wall of stockading, may be made to enclose a large space, capable of accommodating a great number of defenders, and of repelling a considerable hostile force. The base of a wind-mill, on a hill, has in European countries often formed a good blockhouse. A regular B. should have a ditch, not only to supply earth, but to keep the enemy from approaching near enough to fire the timber of the blockhouse. There must be, at least, four feet of well-rammed earth on the roof, to resist the effect of artillery. Such a structure without a roof is not a B., it is simply a stockade.

BLOCK-PRINTING. See PRINTING.

BLOCKSBURG, the name given to various mountains and hills in Germany, but pre-eminently to the Brocken, the highest point of the Harz Mountains, and, indeed, of the north of Germany. According to the popular belief, it is the favourite haunt of the witches, where they celebrate the night of the 1st of May, *Walpurgisnacht* (q. v.), with wild orgies. Almost all mountains thus haunted, are known to have been famous places of sacrifice in the ages of paganism.

BLOCK-SHIP, is a ship of war too old or too slow in sailing to render efficient service in action out at sea, but useful as a defence in great ports and naval arsenals. At the present time, when war-steamer are coming more and more into use, some of the old sailing men-of-war are nearly valueless except as block-ships. At the beginning of 1859 the English block-ships were about ten in number; at the present time there is a still greater number available for no other purpose.

BLOCK TIN is an inferior variety of tin. When the metal is reduced from its ores, it is first poured into moulds, and the ingots thus procured are heated to incipient fusion in a reverberatory furnace, when the pure tin first fuses, and is withdrawn; and the less pure tin which is left behind being melted at a higher temperature, is poured into moulds, and is known as block tin. See TIN.

BLOIS, a town of France, capital of the department of Loire-et-Cher, has a remarkably fine situation on the acclivity of a hill, and is built chiefly on the right bank of the Loire, over which there is here a good stone bridge. It is about 35 miles south-west of Orleans, on the railway between that place and Tours. The houses, in the upper part of the town especially, are mean and ill built, and the streets are crooked and narrow, but they are kept clean by water from the public fountains, which are supplied by a splendid aqueduct, supposed to have been constructed by the Romans. B. has a handsome cathedral; but its chief glory is its old castle, which has been the scene of many interesting historical events. Louis XII. was born in it, and under its roof Charles, Duc d'Alençon, and Margaret of Anjou, and Henri IV. and Margaret of Valois were married. Here also were sometimes held the courts of François I., Henri II., Charles IX., and Henri III. Here also

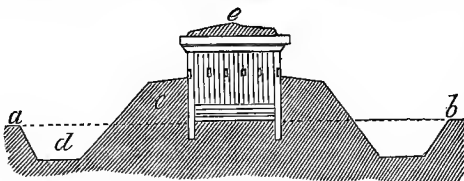

Elevation of Blockhouse.

which the lower forms a barrack for a few men. It is usually either rectangular or shaped like a Greek cross; the latter is preferred, as enabling the fronts of fire to flank each other. One among the many kinds of B. is shewn in the annexed cut: where *ab* denotes the natural level of the ground; *c*, a mound or parapet formed from the earth obtained out of the

the Duc de Guise and his brother were murdered, by order of Henri III., on the 23d December 1588. Isabella, queen of Charles VI., here found a retreat; it served as a prison for Mary de' Medici; Catharine de' Medici died within its walls; and Maria Louisa here held her court in 1814, after Paris had capitulated. B. is a place of great antiquity. Stephen, who usurped the crown of England on the death of Henry I., was a son of one of the counts of B., by Adela the daughter of William the Conqueror. B. is an archbishop's see, has a tribunal of commerce, a communal college, a public library of 20,000 vols., a botanic garden, &c., and manufactures of porcelain and gloves, with a trade in brandy, wine, and wood. Pop. 13,552.

BLOMFIELD, CHARLES JAMES, Bishop of London, a learned and influential prelate of the Church of England, was born in 1786, at Bury St Edmund's, in Suffolk, where his father was school-master. Being well grounded by his father in the classics, B. went to Cambridge, where he took high honours. After he had filled several curacies, the Bishop of London appointed him his chaplain, in recognition of his acknowledged philological and theological acquirements. Shortly after, he was called to the living of St Botolph; in 1824, he was made Bishop of Chester; and in 1828, he was promoted to the see of London, on the translation of Bishop Howley to Canterbury. B.'s reputation for classical scholarship rests chiefly on his editions of *Callimachus* (Lond. 1815), and of several of the dramas of *Æschylus*. In connection with Rennel, he published the *Musæ Cantabrigienses*; and with Monk (1812) the *Posthumous Tracts of Porson*; and in 1814, the *Adversaria Porsoni*. He also published *Lectures on the Acts of the Apostles*. B. was exceedingly active in the superintendence of his diocese, and was a prime mover in the agitation for the erection of new churches. Under his presidency, more churches were erected in London than under any bishop since the Reformation. His conduct in regard to the controversies that latterly agitated his diocese was much animadverted on by both parties. He was accused at one time of leaning to Puseyism, and yet he proceeded against his clergy for alleged crypto-catholic practices. He died August 1857.

BLOMMAERT, PHILIP, one of the most prominent of living Flemish authors, was born in 1809. In 1834, he published a volume of verse, characterised by much simplicity and earnestness, but so inartistic in form that it met with little success. He rendered better service to literature and to the patriotic cause by the publication (1836—1841) of *Theophilus*, an old Flemish poem of the 14th c., and of the *Oude Vlaemische gelichte* (Old Flemish Poems) of the 12th, 13th, and 14th centuries. Both works are enriched with glossaries and learned annotations. B. shews a predilection for middle-age literature generally, and has translated the *Nibelungen* into Flemish iambics. His most important work is a *History of the Belgians* (Brussels, 1849), in which he attempts to shew that the political destiny of the Low Countries has ever been identical with that of Germany, and that it is with the latter country, and not with France, she should seek to ally herself. B. has also contributed extensively to several Belgian journals, especially to the *Messenger des Sciences Historiques*.

BLONDEL, a celebrated French minstrel of the 12th c., and the favourite of Richard the Lionheart, king of England, whom he accompanied to Palestine. When Richard, on his return, was seized and imprisoned by Leopold, Duke of Austria, B. (according to the exquisitely romantic myth of an old chronicler) resolved to find out the place in

which his master was confined. He wandered through Germany in disguise, and at length coming to the castle of Löwenstein, in Austria, he heard that it contained some illustrious captive. Feeling assured that this was no other than the king, he tried all means to get a sight of him, but to no purpose. He then placed himself opposite to the tower in which he learned the unknown was imprisoned, and commenced singing one of those Provençal songs which Richard and he had composed together. Hardly had B. finished the first stanza, when a well-known voice from the tower took up the second, and carried it on to the end. So the minstrel discovered his monarch, and, returning with all speed to England, was the means of his being ransomed by his subjects. Only a few of B.'s poems have come down to us; these are preserved in the Library of the Arsenal at Paris.

BLOOD, the nutritive fluid of the tissues, consists of a fluid, the *liquor sanguinis*, in which float corpuscles or globules. The liquor sanguinis consists of water, in which are dissolved *fibrine*, albumen, chlorides of sodium and potassium, phosphates of soda, lime, and magnesia. There are also in the B. some fatty, and what are called vaguely by chemists, 'extractive matters.' The corpuscles are of two kinds—white and red; the white are larger and less numerous than the red. They contain small molecules. The red, which seem to have their origin in the white or colourless corpuscles, are peculiar to vertebrate animals, and to them the B. owes its characteristic colour.

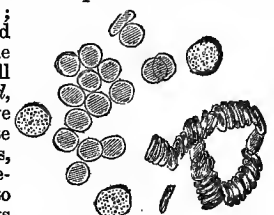

Blood Corpuscles highly magnified.

They are flat disks, oval in birds, reptiles, and fishes, circular in man and most mammalia. They are concave on both sides, so that their edges are thicker than the centres, and hence the dark appearance of the latter under the microscope, which, for some time, led observers to believe that they possessed a nucleus. The size of a red corpuscle in man is from $\frac{1}{4000}$ of an inch to $\frac{1}{2500}$ of an inch. They are largest in reptiles. Those of that singular animal, the proteus, are $\frac{1}{337}$ of an inch in long diameter, and can almost be seen with the naked eye. When examined by the chemist, the red globules of the B. consist of about 312 parts in 1000 of solid matter, fatty and extractive, with a small quantity of mineral matters. They owe their colour to a mixture of two distinct compounds, *globuline* and *hematine*, the former of which crystallises, on being separated, into various forms. 'The B. crystals of man and the carnivora have a prismatic form, whilst those of the rat and mouse are tetrahedral, and those of the squirrel hexagonal.'—*Carpenter*. The following is the formula of *hematine*: carbon, 44; hydrogen, 22; nitrogen, 3; oxygen, 6; and iron, 1.

When drawn from the body, or if it has escaped in any way from the blood-vessels, B. undergoes some singular changes. The fibrine coagulates, or becomes solid, and in so doing, entangles the corpuscles, thus forming a *clot* (crassamentum); the water, still retaining the albumen and the saline matters, drains away, and is termed *serum*. The rapidity with which this change takes place, the relative bulk of the serum and the clot, and the firmness of the latter, vary with circumstances; the more fibrine, the longer does the clot take to form. Moderate heat and exposure to the air favours it, cold and exclusion from the air retards it; it is also

retarded in those cases where death has occurred from some sudden shock, as from lightning, and the B. remains fluid in the veins for some time after death. But even during life, B. escaped from the vessels coagulates nearly as rapidly as if out of the body. In some forms of malignant fever, or when the poison of glanders or malignant pustule has entered the B., the latter remains fluid, also in cases where the blood is what is termed *poor*, as in scurvy, and in those suffocated. The size and firmness of the clot depends on the amount of fibrine in the B., which in health averages about 2 parts in 1000. In inflammations it is much increased, and the B. forms slowly into a tough clot, which is almost destitute of red globules on its surface, and drawn in towards the centre, this colourless layer is termed the 'buffy coat,' and the physicians of bygone times used to attach great importance to it, believing that it was a phenomenon peculiar to inflammation, and bleeding repeatedly, with the view to its removal; whereas anything which delays coagulation, great poverty of B., as in Chlorosis (q. v.), green-sickness, or any condition in which the fibrine is in greater proportion than the red blood globules, will cause this appearance; the clot of the impoverished blood will, however, be small and loose, and floating in an excessive quantity of serum.

The colour of the B. varies, as it happens to come from the venous or arterial side of the heart. The florid scarlet arterial B., passing through the capillaries, loses its oxygen, becomes loaded with carbonic acid, and appears in the veins of a dark purple colour, which it changes again for scarlet, when it is sent to the lungs, there to part with its carbonic acid and to absorb a fresh supply of oxygen. See CIRCULATION OF THE BLOOD.

It seems probable that this change is owing to the effect of the oxygen on the corpuscles, contracting them, and altering their reflecting surfaces; carbonic acid, on the other hand, rendering them thinner and more flaccid. The changes in colour can be effected in B. drawn out of the body by the application of the gases mentioned.

The red B. corpuscle performs important duties in our bodies. Possessing great powers of absorbing oxygen, it hurries away from the left side of the heart, and bears that life-giving stimulus to the tissues; takes from them nearly as readily the carbonic acid, which would poison the whole body if allowed to remain; carries it away, and gets rid of it in the lungs, where it again absorbs oxygen; and again goes on its useful circuit through the body till, following the laws which govern all cells and bodies composed of them, it wears out, degenerates, and dies. The most important differences in the blood of different classes of animals, are noticed in the articles on these classes. See also RESPIRATION.

BLOOD, AVENGER OF. In the early ages of society, the infliction of the penalty of death for murder did not take place by the action of any tribunal or public authorities administering law, but, in accordance with the rude social condition, was left to the nearest relative of the murdered, whose recognised duty was to pursue and slay the murderer. He was called the Avenger of B., in Hebrew, *Goël* (q. v.), which term, however, was of wider signification. The Mosaic law (Numb. xxxv.) did not set aside this universal institution of primitive society, but placed it under regulations, prohibiting the commutation of the penalty of death for money, which appears to have become frequent, and appointing *cities of refuge* for the manslayer who was not really a murderer. See CITY OF REFUGE. The Koran sanctions the avenging of B. by the nearest kinsman, but also sanctions the pecuniary

commutation for murder. The primitive institution or custom subsists in full force among the Arabs at this day. Many of the hereditary feuds of families, clans, and tribes in all barbarous and semi-barbarous countries, have always been connected with the avenging of blood.

BLOOD, CORRUPTION OF (in Law). See CORRUPTION OF BLOOD.

BLOOD, EATING OF. The eating of B. was prohibited under the Old Testament dispensation, obviously for reasons connected with the use of animals in sacrifice. Christians, with a few exceptions, have always regarded the prohibition as having ceased with the reason for it; and the exhortation of the apostolic council of Jerusalem to the Gentile converts, to abstain 'from things strangled and from blood,' to have been merely an application of the great law of Christian charity to the circumstances of a transition period, with reference to the prejudices of Jewish converts.

BLOOD OF OUR SAVIOUR, was an order of knighthood in Mantua, instituted by Duke Vincent Gonzaga in 1608, on the occasion of the marriage of his son with a daughter of the Duke of Savoy. It consisted of 20 knights, the Mantuan dukes being sovereigns. The collar had threads of gold laid on fire, and interwoven with the words *Domine probasti*. To the collar were pendent two angels, supporting three drops of blood, and circumscribed with the motto *Nihil isto triste recepto*. The name originated in the belief that in St Andrew's Church, in Mantua, certain drops of our Saviour's blood are kept as a relic.

BLOOD OF ST JANUARIUS. See JANUARIUS, ST.

BLOOD, THOMAS, a most daring, unscrupulous, and successful adventurer, was born in Ireland about 1628, and served there in the parliamentary army. After the Restoration, he put himself at the head of an insurrectionary plot, which was to begin with the seizure of Dublin Castle, and of Ormond, the lord-lieutenant. On its timely discovery, he fled, while his chief accomplices were seized and executed. Escaping to Holland, he was received there with high consideration. He soon found his way back to England, to try what mischief might be brewed among the fifth-monarchy men. Finding no prospect of success, he repaired to Scotland, invited by the turbulent state of affairs, and was present at the fight of Pentland, November 27, 1666. On the night of the 6th December 1670, the Duke of Ormond was seized, in his coach in St James's Street, by a gang of braves, tied on horseback behind one of them, and hurried away towards Tyburn. The timely approach of his attendants at the moment that he had succeeded in struggling with his riding-companion to the ground, probably saved him from hanging. The leader in this daring villainy was B., and so well had he contrived it, that he did not even incur suspicion. His next enterprise was still more wild and dangerous. On the 9th of May 1671, disguised as a clergyman, and accompanied by his former accomplices, he entered the Tower with the determination to carry off the regalia of England. After nearly murdering the keeper of the jewels, he actually succeeded in carrying off the crown under his cloak, while one of his associates bore away the orb. They were immediately pursued, however, seized, and committed to the Tower jail. Now came a singular turn of fortune. At the instigation of Buckingham, who was accused of having hired B. to attack the Duke of Ormond, King Charles visited the dauntless miscreant in prison, and, dreading the threat that there were hundreds of B.'s associates banded together by

oath to avenge the death of any of the fraternity, pardoned him, took him to court, gave him an estate of £500 a year, and raised him so high in favour that for several years Colonel B. was an influential medium of royal patronage. This scandalous disregard of public decency was heightened by the fact, that the old jewel-keeper, who had risked his life in defence of his charge, applied in vain for payment of a small reward for his devotion. After the fall of the 'cabal' ministry, B. became hostile to Buckingham, and for a scandalous charge against him was committed to prison. He was bailed out, and died in his own house in 1680.

BLOOD-BIRD of New South Wales (*Myzomela sanguinolenta*), a beautiful little species of Honey-sucker (q. v.), which receives its name from the rich scarlet colour of the head, neck, breast, and back of the male. It inhabits thickets. A very similar species is found in Bengal.

BLOOD-FLOWER (*Hemantulus*), a genus of bulbous-rooted plants, of the natural order *Amaryllidaceæ* (q. v.), mostly natives of South Africa, some of which are among the prized ornaments of British green-houses. They take their name from the usual colour of their flowers, which form a fine head or cluster, arising from a spathe of a number of leaves. The fruit is a berry, usually with three seeds. The leaves of the different species exhibit considerable diversity of form, in some almost linear, in others almost round; in some, also, they are erect, in others appressed to the ground. The bulbs of some of the finest species of B. being very slow to produce offshoots, a curious method of propagating them is

BLOOD-HOUND, a variety of Hound (q. v.) remarkable for its exquisite scent and for its great sagacity and perseverance in tracking any object to the pursuit of which it has been trained. It derives its name from its original common employment in the chase, either to track a wounded animal or to discover the lair of a beast of prey. It was also formerly called, both in England and Scotland, *slout-hound* or *slouth-hound*, from the Saxon *slout*, the track of a deer. The B. was formerly common and much in use in Britain, as well as on



Blood-hound.

the continent of Europe, but is now rare. The poetical histories of Bruce and Wallace describe these heroes as occasionally tracked by blood-hounds, when they were skulking from their enemies. The B. was at a later period much used to guide in the pursuit of cattle carried off in Border raids; it has been frequently used for the pursuit of felons and of deer-stealers; and latterly, in America, for the capture of fugitive slaves, an employment of its powers which has contributed not a little to render its name odious to many philanthropists. Terrible ideas are also, probably, suggested by the name itself, although the B. is by no means a particularly ferocious kind of dog, and when employed in the pursuit of human beings, can be trained to detain them as prisoners without offering to injure them. The true B. is taller and also stronger in proportion, and of more compact figure than a fox-hound, muscular and broad-chested, with large pendulous ears, large pendulous upper lips, and an expression of face which is variously described as 'thoughtful,' 'noble,' and 'stern.' The original colour is said to have been a deep tan, clouded with black. The colour appears to have been one of the chief distinctions between the B. and the Talbot (q. v.), but it is not improbable that this name was originally common to all blood-hounds. Many interesting anecdotes are recorded of the perseverance and success of blood-hounds in following a track upon which they have been set, even when it has led them through much frequented roads.—The CUBAN B., which is much employed in the pursuit of felons and of fugitive slaves in Cuba, differs considerably from the true B. of Britain and of the continent of Europe, being more fierce and having more resemblance to the bull-dog, and probably a connection with that or some similar race. Many of these dogs were imported into Jamaica in 1796, to be employed in suppressing the Maroon (q. v.) insurrection, but the terror occasioned by their arrival produced this effect without their actual employment. It is this kind of B. which has been chiefly introduced into the slave-states of North America.

BLOOD-ROOT. See *GEUM*, *HEMODORACEÆ*, and *SANGUINARIA*.

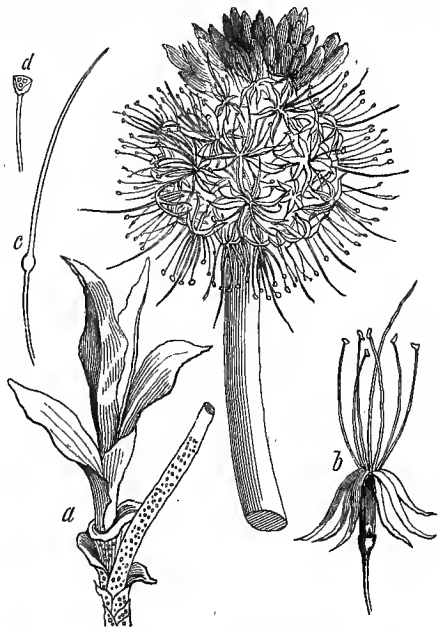

Many-flowered Blood-flower:

a, leaves and fruit of flower-stem, in miniature; *b*, flower; *c*, seed-bud, shaft, and summit; *d*, seed-bud cut transversely.

resorted to by gardeners, which is occasionally practised also with other bulbous-rooted plants, by cutting them across above the middle, upon which a number of young bulbs form around the outer edge.

The species of B. seem generally to possess poisonous properties. The inspissated juice of *H. toxicarius* is used by the natives of South Africa for poisoning their arrows.

BLOODSTONE. See **HELIOTROPE.**

BLOOM, an appearance on paintings resembling in some measure the bloom on certain kinds of fruit, such as peaches, plums, &c. (hence the name), produced, in all probability, by the presence of moisture in the varnish, or on the surface of the painting when the varnish is laid on. The B. destroys the transparency, and is consequently very injurious to the general effect of a picture. It is best prevented by carefully drying the picture and heating the varnish before applying it; and best removed by a sponge dipped in hot camphine, after which a soft brush should be employed to smooth the surface of the picture, which should be finally placed in the sunshine to dry.

BLOOMERISM, a new and fanciful fashion of ladies' dress, partly resembling male attire, which arose out of what is termed the 'Woman's Rights' Movement,' that began to be agitated in the United States about the year 1848. The first Woman's Rights' Convention was held at Worcester, New York, in 1850, under the presidency of Mrs Lucretia Mott. Its object was to advocate for women a more liberal education, training in trades and professions, and generally the social and political privileges possessed by the other sex. At the same date, and in close connection with this movement, arose an agitation for the reform of female attire. Its advocates said, justly enough, that if women were to take their place in the world as fellow-workers with men, they ought not to labour under the disadvantage of having a dress that deprived them of the use of their hands, and required nearly their whole muscular power for its support. In 1849, Mrs Ann Bloomer adopted the costume to which she has given her name, and lectured in New York and elsewhere on its advantages. The Bloomer dress consisted of a jacket with close sleeves, a skirt falling a little below the knee, and a pair of Turkish trousers. Though a few ladies followed the example of Mrs Bloomer, the dress was extremely unpopular, and exposed its adherents to a degree of social martyrdom which the more prudent, timid, or amiable declined to brave. A very elegant modification of the Bloomer dress was achieved by a New York lady—a Polish jacket, trimmed with fur, and a skirt reaching to within a few inches of the ground, avoiding a display of pantaloons, and showing off merely the trim furred boot, but still sufficiently short to avoid contact with the street; the filthy habit of spitting, which prevails in America, rendering such avoidance peculiarly necessary. The agitation for dress-reform has not died out on the other side the Atlantic. There is in New York a monthly publication, called the *Sibyl*, devoted to its advocacy, and whose editor, a married lady, as well as several of her contributors, personally illustrate their principles. A wood-cut at the head of the periodical represents the Reform Dress, as it is called. It looks by no means tempting in point of elegance—a fault fatal to its general adoption. The skirt is immoderately short, and the jacket cuts the figure awkwardly in two. The introduction of B. into England, soon after it had sprung up in America, was under such unfavourable auspices, that it failed to gain entrance into respectable society, and speedily disappeared. Still here, as in America, nothing is more frequently talked of, or desired with more apparent fervency, than a dress-reform. The present heavy hooped skirts, injurious to health and fatal to comfort from their weight and amplitude, and liable to be equally dirty and ridiculous, are universally complained of; but the prejudice with which any innovation is sure to be met, discourages every attempt to introduce a reform.

BLOOMFIELD, ROBERT, the author of *The Farmer's Boy*, and other pastoral pieces, born 1766, at Honington, near Bury St Edmund's, was the son of a poor tailor, who died, leaving Robert an infant. His mother with difficulty subsisted by teaching a school, where B. learned to read. At the age of 11 he was hired to a farmer, but ultimately became a shoemaker in London, where he wrote his *Farmer's Boy* in a poor garret. It was published in 1800, had extraordinary popularity, and was translated into a number of languages. He subsequently published *Rural Tales*, *Wild Flowers*, and other pieces. Though efforts were made for him by persons of rank, his health broke down, and he died nearly insane, at Shefford, in Bedfordshire, in 1823.

BLOUSE, a name borrowed from the French for that loose, sack-like over-garment which, as worn in England by wagoners and farm-labourers, is called a smock-frock. The English smock-frock is made of coarse and imperfectly bleached linen, and is ornamented, particularly on the breast and shoulders, with plaits and embroidery. In the south of Scotland it is sometimes worn by butchers, and is then blue, as in Germany and France. In Germany, it is frequently tightened to the body by a belt, and is sometimes made of coarse woollen; but France is pre-eminently the country of blouses. There, they are worn universally, not only by the country people, but also by the labouring-classes in towns, not excepting Paris; and so characteristic is this garment, that the French populace are often called the 'blouses.' The *white B.* is Sunday dress with the working-classes in France, and has also often served as a countersign among the leaders of sections in secret societies. A lighter and neater garment of the sort, usually made of fine but imperfectly bleached linen, and buttoning in front, which the English smock-frock and the original continental B. do not, is much worn by summer tourists.

BLOW-FLY (*Sarcophaga carnaria*), an insect of the order *Diptera* (two-winged), (q. v.), and of the large family *Muscidae*, of which the common House-fly (q. v.), Flesh-fly (q. v.), &c., are familiar examples. The B. is very similar to these in its general appearance; its body is hairy, the expanse of its wings about one inch, the face silky and yellow, the thorax gray, with three black stripes, the abdomen of a shining blackish brown, which, in certain points

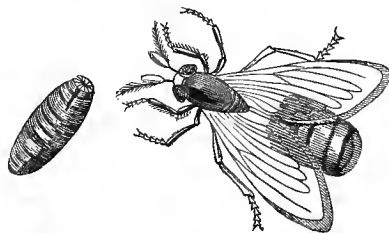

Blow-fly and Pupa.

of view, assumes a bluish tint, chequered with glittering yellowish spots. One of the distinguishing characters of the genus is, that the eyes are widely separate in both sexes. The species of this genus are not unfrequently ovoviviparous, the eggs being hatched within the body of the parent. The generic name (Gr. *sarx*, flesh; *phago*, to eat) is derived from the circumstance that the larvæ of most of the species feed upon the flesh either of dead or of living animals. The B. is common in Britain on heaths, in gardens, &c., and its larvæ are to be found feeding upon meat, the carcases of animals, sometimes upon living earthworms, and too frequently upon sheep, of which it is one of the

most grievous pests, requiring the constant attention of the shepherd during most of the summer and autumn. Some districts are more infested with it than others; it is particularly troublesome in the fenny districts of England. Unless the maggots are removed, they eat into the skin, the sheep suffer great torment, and soon die. At first they may be removed by shaking them out of the wool, into which dry sand is then abundantly sprinkled; but if they are very numerous, a mercurial ointment or wash of corrosive sublimate is applied; and when the skin is much broken, the wool is clipped away, an ointment of tar and grease is used, and a cloth sewed over the part. Like many other insects, the B. multiplies with excessive rapidity.

Another species of this genus, common in most parts of Britain, is *S. mortuorum*, so named from its frequenting burial-vaults and similar places. It is very similar to the B., but the abdomen is of a shining steel blue, and there is a reddish-brown line down the forehead.

BLOW-PIPE, a small instrument used in the arts for soldering metals, and in analytical chemistry and mineralogy, for determining the nature of substances by the action of an intense and continuous heat, its principle depending on the fact, that when a jet of air or oxygen is thrown into a flame, the rapidity of combustion is increased, while the effects are concentrated by diminishing the extent or space originally occupied by the flame.

The B. generally consists of a conical tube of metal, about eight inches long (fig. 1), closed at the wider or lower end, but open at the narrow or upper end, *a*, which latter constitutes the mouthpiece, and is turned over to admit of the lips closing perfectly round it. Near the lower end, a small tube, fitted with a finely perforated nozzle, *b*, is inserted at right angles to the large tube—the space below being intended as a chamber for condensing the moisture of the breath—through this nozzle, a fine current of air can be projected against the flame experimented with.

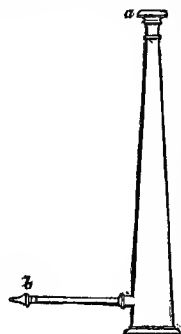

Fig. 1.

When a current of air from the B. is directed against a candle or gas-jet, the flame almost entirely loses its luminosity, owing to the perfect combustion of the gases evolved from the source of heat, and is projected in a lateral direction, as a long pointed cone, consisting of three distinct

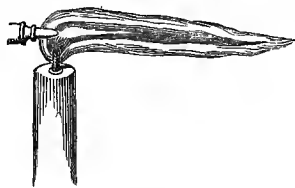

Fig. 2.

parts (fig. 2). The first or central cone is of a dark-blue colour, and there the combustion is complete from the excess of air thrown in from the small nozzle. The second cone, or that immediately surrounding the first, is somewhat luminous; and here the oxygen, being insufficient for the combustion of the carbon, any metallic oxide subjected to the action of this portion of the flame is deprived of its oxygen, and reduced to the condition of metal;

for this reason the luminous cone is generally termed the *reducing flame* of the blow-pipe. Beyond the second cone, or where the flame comes freely in contact with the atmosphere, and abundance of oxygen is present to effect complete combustion of the gases, is a third, or pale yellow envelope, containing excess of atmospheric air at a very high temperature, so that a portion of metal, such as lead or copper, placed at this point, becomes rapidly converted into its oxide: this outer part of the flame is on this account called the *oxidising flame* of the blow-pipe.

Substances under examination before the B. are generally supported either on wood-charcoal or platinum—the latter in the condition of wire or foil. In applying the B. test, the body to be examined is either heated alone, or along with some flux or fusible substance; in some cases, for the purpose of assisting in the reduction of metals from their ores and other compounds; in others, for the production of a transparent glassy bead, in which different colours can be readily observed. When heated alone, a loop of platinum wire, or a piece of charcoal, is generally employed as a support; the former when the colour of the flame is to be regarded as the characteristic reaction, the latter when such effects as the oxidation or reduction of metallic substances are to be observed.

The following are exemplifications of the difference of colour communicated to the flame by different substances: Salts of potash colour, the flame *violet*; soda, *yellow*; lithia, *purplish red*; baryta, *yellowish green*; strontia, *carmine*; lime, *brick red*; compounds of phosphoric acid, boracic acid, and copper, *green*. The commonly occurring metallic oxides reducible by heating on charcoal alone in the inner flame of the B. are the oxides of zinc, silver, lead, copper, bismuth, and antimony; the principal ores not so reducible are the alkalis and alkaline earths, as also the oxides of iron, manganese, and chromium. The fluxes generally used in B. experiments are either carbonate of soda, borax (biborate of soda), or the ammonia-phosphate of soda, otherwise called *microcosmic salt* (q. v.). The carbonate of soda, when heated on platinum-wire in the oxidising flame, forms with silica a *colourless glass*; with oxide of antimony, a *white bead*, &c. The following metals are reduced from their compounds when heated with carbonate of soda on charcoal in the inner flame of the B.; viz., nickel, cobalt, iron, molybdenum, tungsten, copper, tin, silver, gold, and platinum. When compounds of zinc, lead, bismuth, arsenic, antimony, tellurium, and cadmium are similarly treated, these metals are also formed, but being volatile, they pass off in vapour at the high temperature to which they are exposed.

Borax, as a flux, is generally mixed with the substance under examination, and placed on platinum-wire. When thus heated in either of the flames, baryta, strontia, lime, magnesia, alumina, and silica, yield *colourless beads*; cobalt gives a *fine blue colour*; copper, a *green*; &c. With microcosmic salt, the results obtained are generally similar to those with borax, and need not be specially mentioned, as the test is applied in the same way. The B. has been long used by goldsmiths and jewellers for soldering metals, and by glass-blowers in fusing and sealing glass-tubes, &c.; it has also been applied in qualitative analysis for many years, but more recently chemists (especially Plattner) have devoted their attention to its use, and have even employed it with great success in *quantitative* chemical analysis; the advantages being that only a very small quantity of material is required to operate upon, whilst the results may be obtained with great rapidity and considerable accuracy.

BLOW-PIPE AND ARROW, a kind of weapon much used by some of the Indian tribes of South America, both in war and for killing game. It consists of a long straight tube, in which a small poisoned arrow is placed, and forcibly expelled by the breath. The tube or blow-pipe, called *grava-tána*, *pocona*, &c., is 8—12 feet long, the bore not generally large enough to admit the little-finger. It is made of reed or of the stem of a small palm. Near Pará, it is in general very ingeniously and nicely made of two stems of a palm (*Iriarteia setigera*, see **IRIARTEA**) of different diameters, the one fitted into the other, in order the better to secure its perfect straightness. A *sight* is affixed to it near the end. The arrows used in that district are 15—18 inches long, made of the spines of another palm, sharply pointed, notched so as to break off in the wound, and their points covered with *curari* (q. v.) poison. A little soft down of the silk-cotton tree (q. v.) is twisted round each arrow, so as exactly to fit the tube. In Peru, arrows of only 1½—2 inches long are used, and a different kind of poison seems to be employed. An accidental wound from one of these poisoned arrows not unfrequently proves fatal. In the hand of a practised Indian, the B. and A. is a very deadly weapon, and particularly when directed against birds sitting in the tops of high trees. As his weapon makes no noise, the hunter often empties his quiver before he gathers up the game, and does more execution than an English sportsman could with his double-barrelled fowling-piece.

BLUBBER. See **CETACEA**, **WHALE**, and **WHALE-FISHERY**.

BLÜCHER, **GEBHARD LEBERECHT VON**, Prince of Wahlstadt, Field-Marshal of Prussia, born at Rostock, in Mecklenburg-Schwerin, West Germany, 16th December 1742. At the commencement of the Seven Years' War, he joined a regiment of Swedish hussars, and in his first action was taken prisoner by the Prussian hussars, whose colonel persuaded him to exchange out of the service of Sweden into that of Prussia, and gave him a lieutenancy. A lieutenant, Jägersfeld, having been promoted over B.'s head, he immediately wrote to Frederick the Great as follows: 'Von Jägersfeld, who has no merit except that of being son of the Markgraf of Schwedt, has been put over my head: I beg to request my discharge.' The result was, that B. was put under arrest, and after repeated applications for discharge, he received from Frederick the curt intimation: 'Captain Blücher is at liberty to go to the devil!' B. went instead to his estate of Grossraddow, in Pomerania, and devoted himself to farming; but he soon tired of a bucolic life. In 1793, having returned to the army, he fought, as colonel of hussars, against the French on the Rhine, evincing great genius as a leader of cavalry. The breaking out of the war of 1806 led him, as lieutenant-general, to the battle of Auerstadt. B., with the greater part of the cavalry, occupied the left flank of the Prince of Hohenlohe in the retreat to Pomerania. He is accused, on this occasion, of not giving the prince due support, and thus leading to the capitulation at Prenzlau. B. himself then marched into the territory of the free town of Lübeck, and hastily fortified the city; but the French took it by storm, and B. was forced to surrender at Ratkow, near Lübeck, whither he had escaped with a few troops. A fortnight after, he was exchanged for the French general Victor; and immediately on his arrival in Königsberg, was sent, at the head of a corps, by sea, to Swedish Pomerania, to assist in the defence of Stralsund. After the peace of Tilsit, he was

employed in the war-department in Königsberg and Berlin, and subsequently became commander in Pomerania. At a later period, he was pensioned, along with several other men of note, at the instance, it was said, of Napoleon. He was one of the few to combat the general belief in the invincibility of Napoleon, which had grown into a sort of fatalism in high places. In common with Stein and Hardenberg, he laboured to remove all weak and unpatriotic counsellors from the person of the king. When all the leaders of the army lost courage, his constancy revived confidence, and made him the centre of all hope for the future. When the Prussians at last rose in opposition to France, B. was appointed to the chief command of the Prussians and of General Winzingerode's Russian corps. At the battles of Lützen, Bantzen, and Haynau, he displayed heroic courage. At the Katzbach, he defeated Marshal Macdonald, and cleared Silesia of the enemy. In vain did Napoleon himself attempt to stop the 'old captain of hussars,' as he called him, in his victorious career. In the battle of Leipsic he won great advantage over Marshal Marmont at Möckern, 16th October 1813, and on the same day pressed on to the suburbs of Leipsic. On the 18th, in conjunction with the crown-prince of Sweden, he had a great share in the defeat of the French, and on the 19th his troops were the first to enter Leipsic. B., in opposition to the policy of Austria, continually pressed the taking of Paris as the real aim of the war. On the 1st of January 1814, he crossed the Rhine, garrisoned Nancy on the 17th of the same month, and after winning the battle of La Rothière, pressed forward to Paris; but his scattered corps were routed by Napoleon, and he fought his way back to Chalons with great loss. On the 9th March, however, he defeated Napoleon at Laon; and at the end of the month, after being joined by Schwarzenberg and his corps, he again advanced towards Paris. The day at Montmartre crowned the brilliant deeds of this campaign, and, on the 31st March, B. entered the French capital. Frederick William III. created him Prince of Wahlstadt, in remembrance of the victory at the Katzbach, and gave him an estate in Silesia. In England, whither he followed the allied sovereigns, he was received with an enthusiasm never before excited by a German. The university of Oxford conferred on him the degree of Doctor of Laws. After Napoleon's return in 1815, B. once more assumed the general command, and promptly led the army into the Netherlands. On the 16th June 1815, he lost the battle of Ligny, in which he was personally in great danger, from his horse falling on him. The victory of the allies at the battle of Waterloo was completed by B.'s timely appearance on the field. B. ordered his Prussians to pursue the flying enemy, which they did the whole night. Declining the offered truce, B. marched again against Paris, and on the second taking of that city manifested a strong desire to retaliate on Paris the spoliation that other capitals had suffered at the hands of the French; but he was held in check by the Duke of Wellington. In order to reward B.'s services to Prussia and the common cause, Frederick William III. created a new order, the badge of which consisted of an iron cross surrounded by golden rays. On the 26th August 1819, a colossal bronze statue was erected in his honour in his native town. B. died 12th September 1819, after a short illness, at his estate of Krieblowitz, in Silesia. In Berlin, a statue twelve feet high, modelled by Rauch, and cast in bronze by Lequene and Reisinger, was erected to his memory, 18th June 1826, and at Breslau another, also executed by Rauch, in 1827. In the beginning of the campaign of 1813, his characteristic activity

and the style of his attacks gained him the nickname of 'Marshal Forward' from the Russians; it soon became his title of honour throughout Germany. His tactics were always much the same: to attack the enemy impetuously, then to retreat when the resistance offered was too great for his troops to overcome; to form again at a little distance, and watch narrowly the movements of the enemy, and whenever an advantage offered itself, to charge with lightning speed, and throw him into disorder, make a few hundred prisoners, and retire ere the opposing force had recovered from its surprise. Such were his usual manœuvres. B., as a man and as a soldier, was rough and uncultivated, but energetic, open, and decided in character. His ardent enthusiasm for the liberation of Prussia and Germany from a foreign yoke, and his uncompromising pursuit of this noble aim, have justly rendered him a hero in the eyes of the German people. The old red uniform, and the old name of 'Blücher's Hussars,' were restored to the 5th Regiment of Hussars by Frederick William IV., on occasion of the centenary celebration of B.'s birthday.

BLUE, a colour of which there are several varieties used in the arts, noted below. See also **COLOUR**. Blue, or, as it is sometimes termed, *True Blue*, was the favourite colour of the Scottish Covenanters in the 17th century. When their army entered Aberdeen, says Spalding, there were few of them without a blue ribbon; this colour being probably adopted in contradistinction to the red of the royal forces. At the battle of Bothwell Bridge, the flag of the Covenanting army was edged with blue. From these usages, blue seems to have become the partisan colour of the Whigs, but commonly in association with orange or yellow, in memory of the House of Orange and the revolution settlement. This combination of blue and yellow is seen in the liveries of certain Whig families of distinction, and also in the cover of the *Edinburgh Review*. Blue is the colour of the uniform of the Royal Navy of England; it is of a dark tint, and is known as *Navy Blue*.

AZURE BLUE is a pigment prepared by mixing 2 parts of deep blue, 1 of oxide of zinc, and 4 of lead glass; the latter consisting of 4 parts of minium and 1 of sand. The above azure blue is for skies, but a pigment for more general use is prepared from 11 fused borax and 67 gray flux; the latter being itself made from 89 pebble flux, 75 minium, and 25 sand.—**BERLIN BLUE**. See **PRUSSIAN BLUE**.—**BRUNSWICK BLUE**, or *Celestial*, is made by precipitating the alumina from a solution of alum by carbonate of soda, washing the precipitate, and adding sulphate of baryta, sulphate of iron, yellow prussiate of potash, and some bichromate of potash. When dried, this mixture is known as Brunswick blue, but when the sulphate of baryta is left out, and the material not dried, it is called *Damp Blue*.—**CERULEAN BLUE** is a colour used in pottery, and consists of 79 parts of gray flux, 7 carbonate of cobalt, 14 hydrated carbonate.—**BLUE COLOUR OF FLOWERS**, or *Anthocyan*, may be obtained from those petals of flowers which are blue by digesting them in spirits of wine in the dark. The colour is soluble in alcohol, but is precipitated from its alcoholic solution by water. It is changed to red by acids, and to green by alkalis.—**BLUE COPPERAS**, or the Sulphate of Copper. See **COPPER**.—**BLUE DYES**. See **INDIGO**, **LITMUS**, **PRUSSIAN BLUE**, and **DYEING**.—**IRON EARTH BLUE** occurs native amongst bog iron ore and in mossy districts in Europe and New Zealand. It mainly consists of a phosphate of iron with a little alumina, silica, and water. It is called *Native Prussian Blue*.—**INDIGO BLUE**, in pottery-ware, consists of 13 parts of carbonate of cobalt, 26 hydrated carbonate of zinc, and 61 gray flux.—**COBALT BLUE**

is the only really good and serviceable blue in the colouring of glass and porcelain, and is essentially the oxide of cobalt (CoO), the colouring power of which is so great, that the addition of 1000 part to white glass is sufficient to render it blue. Several of the compounds named above owe their blue colour to this substance. See **COBALT**.—**DEEP BLUE** is employed in porcelain colouring, and is made from 1 part of oxide of cobalt, 4 glass of lead (2 minium, 1 white sand), 1 lead glass (2 minium, 1 sand, 1 calcined borax), and 1 oxide of zinc, all of which are placed together in a porcelain crucible, fused for 2 or 3 hours; the residue washed, dried, and ground to a fine powder.—**KING'S BLUE** is made from 29 parts carbonate of cobalt, 29 sand, and 42 carbonate of potash, by fusing these ingredients in a crucible. The residue is intense deep blue, bordering on a black blue, and is generally reduced to powder, and re-fused with about half its weight of pebble flux (3 minium or litharge, and 1 sand).—**MINERAL BLUE** and **PARIS BLUE**. See **PRUSSIAN BLUE**.

PRUSSIAN BLUE is the deep blue colour which is so frequently seen on cotton, muslin, and woollen handkerchiefs and dresses. It was discovered in the year 1710 by Diesbach, a colour-maker in Berlin, and hence called *Berlin Blue*. The mode of its manufacture was published in Britain, by Dr Woodward, in 1724. It may be prepared in several ways: 1. By the addition of a solution of yellow prussiate of potash (ferrocyanide of potassium) to a solution of sulphate of iron (green vitriol). The blue compound thus produced deepens in tint when exposed to the air; and where it is required of greater consistence or more *body*, some alum and carbonate of potash are added to the prussiate solution before mixing with the iron solution. 2. By mixing solutions of yellow prussiate of potash and perchloride of iron, which yields the variety known as *Paris Blue*. 3. By adding a solution of the red prussiate of potash (ferrocyanide of potassium) to a solution of sulphate of iron, and this mode of preparation gives *Turnbull's Blue*. The Prussian blue settles to the bottom of the mixing vessels, and may be collected and dried by exposure to the air, when it is obtained as a blue powder. If heat be applied during the drying, the material cakes, and when cut, exhibits a lustre and hue like copper. When alum has been used in its manufacture, the product has a dull earthy fracture. The composition of Prussian blue is that of a ferrocyanide of iron. See **CYANOGEN**. It is employed by washerwomen, under the name of *blue*, for neutralising the yellow tint of cotton and linen clothes; by paper-makers, to colour paper; and is very largely employed as a pigment in **CALICO-PRINTING** (q. v.) and **DYEING** (q. v.). *Mineral Blue* is formed when the Prussian blue is precipitated along with a solution of zinc or magnesia, or moist carbonates of zinc or magnesia are added during the precipitation of the colour. In the formation of *Royal Blue*, a solution of tin is added, and *Steam Blue* is produced on the addition of solutions of tartaric acid and yellow prussiate of potash. The impurities liable to be present in Prussian blue are starch, chalk, and stucco, either of which necessarily decreases the intensity of the blue colour, and the utility of the substance.

SAXONY BLUE is prepared by dissolving indigo (q. v.) in Nordhausen sulphuric acid, and was first manufactured in Saxony in the year 1810, by taking the very finely powdered indigo and incorporating it with the acid cautiously heated, when the indigo dissolves, and yields a blue colour of great depth of tint. It is largely used in dyeing (q. v.).—**OLD SEVRES BLUE** is a cobalt blue used in pottery, and is made up of 19 parts oxide of cobalt, 39 dry carbonate of soda, 3 dry borax, and 39 sand.—

THENARD'S BLUE is the blue formed by heating alum with a solution of cobalt, or it may be formed by igniting a mixture of phosphate or arseniate of cobalt with eight times its weight of alumina in the hydrated state procured by precipitation from alum by ammonia. Used in pottery.—**TURQUOISE BLUE** is composed of 3 of oxide of cobalt, 4 of alumina, and 1 oxide of zinc. It is manufactured by dissolving the oxides of zinc and cobalt in dilute sulphuric acid, adding the liquid to a solution of 40 parts of ammonia alum, drying up and igniting at a red heat for several hours. The addition of a little chromate of mercury gives it a green shade.—**VARIEGATED BLUE** is used for colouring porcelain, and is formed by fusing 10 oxide of cobalt, 9 oxide of zinc, 5 lead glass (2 minium, 1 sand, and 1 calcined bones), and 25 glass of lead (2 minium and 1 sand).

BLUE STONE, or BLUE VITRIOL, is sulphate of copper. See **COPPER**.

BLUE-BEARD, the name given to the hero of a well-known tale of fiction, which is of French origin. According to this romance, the Chevalier Raoul has a blue beard, from which he gets his designation. This personage tests his wife's curiosity by intrusting her, during his absence on a journey, with the key of a chamber, which she is forbidden to enter. She is unable to stand the test, and he puts her to death. Several wives share the same fate, but at length the seventh is rescued at the last moment by her brothers, and B. is slain. The tale appears in innumerable collections, under various forms. Tieck, in his *Phantasus*, has worked up this material into a clever drama, with numerous romantic and satirical additions, and Grétry has made use of it in his opera of *Raoul*.

The historic original of Chevalier Raoul would appear to be one Giles de Laval, Lord of Raiz, who was made marshal of France in 1429, and fought valiantly in defence of his country when invaded by the English; but his cruelty and wickedness seem to have eclipsed even his bravery, as he is remembered chiefly for his crimes, which credulous tradition has painted in the blackest and most fearful colours. He is said to have taken a pleasure, among other atrocities, in corrupting young persons of both sexes, and afterwards in murdering them for the sake of their blood, which he used in his diabolical incantations. Out of this fact, in itself probably half-mythical, the main feature of the tale of B. has probably grown. Laval was burnt alive in a field near Nantes, in 1440, on account of some state-crime against the Duke of Brittany.

BLUE-BELL. See **HYACINTH**.

BLUE BIRD, BLUE WARBLER, BLUE REDBREAST, or BLUE ROBIN (*Sylvia sialis*, or, according to the most recent ornithological systems, *Erythaca* or *Sialia Wilsoni*; see **SYLVIADEÆ**), an American bird, which, from the confidence and familiarity it displays in approaching the habitations of men, and from its general manners, is much the same sort of favourite with all classes of people in the United States that the redbreast is in Britain. Except in the southern states, it is chiefly known as a summer bird of passage, appearing early, however, as a harbinger of spring, and visiting again 'the box in the garden, or the hole in the old apple-tree, the cradle of some generations of ancestors.' Few American farmers fail to provide a box for the B. B.'s nest. In size, the B. B. rather exceeds the redbreast, which, however, it much resembles in general appearance. Its food is also similar. The upper parts of the B. B. are of a rich sky-blue colour, the throat and breast are reddish chestnut, and the belly white. The female is duller in colours than the male. The B. B. lays five or six pale-blue eggs,

and has two or three broods in the season. Its song is 'a soft agreeable warble.' The male is remarkably attentive to his mate, and both exhibit extraordinary courage in driving away intruders from the



Blue Bird (*Sylvia sialis*).

vicinity of their nest. A hen, with her brood, has been seen to flee from the attacks of an enraged and pugnacious blue bird.—The B. B. is known as an inhabitant of the Bermudas, Mexico, the West Indies, Guiana, and Brazil.—In the western and in the more northern parts of North America, its place is taken by nearly allied and very similar species.

BLUE-BOOKS, the name popularly applied to the reports and other papers printed by parliament, because they are usually covered with blue paper. The term was, for like reasons, long applied to the reports sent annually by the governors of colonies to the colonial secretary; and even in technical official phraseology, these are called 'blue-books.' The practice of printing, and to some extent publishing, the proceedings of the House of Commons, began in the year 1681, when disputes ran high on the question of excluding the Duke of York from the succession to the throne. The proceedings on the occasion are extremely interesting. It was stated, that especially after parliaments were dissolved, false accounts of their proceedings were circulated, and, as a remedy, Sir John Hotham moved that the votes and proceedings of the House be printed. Mr Secretary Jenkins opposed the motion, saying: 'Consider the gravity of this assembly: there is no great assembly in Christendom that does it; it is against the gravity of this assembly, and is a sort of appeal to the people.' He was answered by Mr Boscawen: 'If you had been a privy council, then it were fit what you do should be kept secret, but your journal-books are open, and copies of your votes in every coffee-house, and if you print them not, half votes will be distributed to your prejudice. This printing is like plain Englishmen, who are not ashamed of what they do, and the people you represent will have a full account of what you do.' Colonel Mildmay said: 'If our actions be nought, let the world judge of them; if they be good, let them have their virtue. It is fit that all Christendom should have notice of what you do, and posterity of what you have done—and I hope they will do as you do, therefore I am for printing the votes.' The motion was carried. See *Parl. Hist.* iv. 1307; *Kennet*, iii. 396. The documents printed by the House of Commons accumulated gradually in bulk and variety, until they reached their present extent. In 1836, the House adopted

the practice of selling their papers at a cheap rate. A curious legal and constitutional question immediately arose out of this practice, a publisher having taken proceedings for libel against the officers concerned in circulating the papers, because it was stated in a report concerning prisons that the prisoners read indecent books printed by him. The chief contents of these papers at present are—the votes and proceedings of the House; the bills read in their several stages; the estimates for the public services of each year; the accounts of the expenditures of the moneys voted in the previous year; any correspondence or other documents which the ministry may voluntarily, or at the demand of the House produce, as connected with a question under discussion; reports of committees of inquiry appointed by the House; reports of commissions of inquiry appointed by the crown; and annual reports by the permanent commissions and other departments of the government, stating their proceedings during the year. The B. of a session, when collected and bound up, now often fill fifty or sixty thick folio volumes. Nothing can seem more hopelessly chaotic than those of a few sessions huddled together unarranged. It deserves to be known, however, that they are all printed according to a peculiar sequence, which enables the whole papers of a session to be bound up in such an order that any paper can be found by consulting an ample index in the last volume. In any library where the B. are preserved and properly bound up, the most trifling paper of any session may thus be found with ease; and it need hardly be said that with much that is useless or unimportant, there is an enormous mass of valuable matter hidden in the blue-books.

There is no doubt, however, that although the means are thus provided for finding what the B. contain, their contents are heterogeneous, and to a great extent cumbersome and valueless. They are not prepared on any uniform system, or subjected to general revision, or what may be called editing. Each officer prepares his own report in his own way, sometimes lauding his own services, or arguing in favour of his own peculiar principles on some public question, so that it has been remarked that the B. contain a large number of articles like those in the periodical press, but too cumbersome and dull to get admission there. It has been matter of complaint that the public are burdened with the expense of widely distributing such documents. It is stated in a treasury minute, circulated among the government departments in May 1858, with the view of in some measure remedying the abuse, 'that the cost of printing the report of the commissioners appointed to inquire into the endowed schools of Ireland, and the three volumes of evidence and appendices (including the cost of the paper), was £5200, and that the weight of the paper used in printing them was about 34 tons.'

BLUE-BOTTLE FLY. See FLESH-FLY.

BLUE CARDINAL. See LOBELIA.

BLUE-COAT SCHOOL, the name ordinarily given to Christ's Hospital, London, in which the boys wear blue coats or gowns, according to an old costume. See CHRIST'S HOSPITAL.

BLUE-EYE (*Entomyza cyanotis*), a beautiful little bird, abundant and very generally dispersed in New South Wales, although not found in the more southern Australian colonies. It is a species of Honey-sucker (q. v.) or Honey-eater, and is sometimes called the Blue-checked Honey-eater. The B. seeks its food almost exclusively among the blossoms and small leafy branches of *Eucalypti*. Its food consists partly of insects and partly of honey; perhaps also of berries. It is a bold and spirited bird, of most

elegant and graceful movements. Numbers are often seen together clinging and hanging in every variety of position, frequently at the extreme ends of the small thickly-flowered branches, bending them down with their weight.

BLUEFIELDS, a river of the Mosquito Territory, in Central America, which, after a course of several hundred miles to the east, enters the Caribbean Sea in lat. 12° N., and long. 83° W. Its lower stream is navigable to a distance of 80 miles from the sea. At its mouth is a good harbour, above which stands a town of the same name, the residence of the king of the Mosquito Territory.

BLUE-GOWNS, the name commonly given to a class of privileged mendicants in Scotland. The proper designation of these paupers was the King's Bedesmen, or Beadsmen. In ancient times, a beadsman was a person employed to pray for another. See BEAD. From practices of this kind, there sprang up a custom in Scotland of appointing beadsmen with a small royal bounty, who ultimately degenerated into a class of authorised mendicants. Each of the beadsmen on his majesty's birthday received a gown or cloak of blue cloth, with a loaf of bread, a bottle of ale, and a leathern purse containing a penny for every year of the king's life. Every birthday, another beadsman was added to the number, as a penny was added to each man's purse. The most important part of the privilege was a large pewter badge, attached to the breast of the gown, which, besides the name of the bearer, had the inscription, *Pass and Repass*. This inferred the privilege of begging, and bespoke the kindly consideration of all to whom the beadsman appealed for an alms or a night's lodging. The fictitious character of Edie Ochiltree, in Sir Walter Scott's tale of the *Antiquary*, is a fair sample of this ancient and picturesque fraternity. The practice of appointing beadsmen was discontinued in 1833, at which time there were sixty on the roll. The whole have since died out but one, who still annually calls at the Exchequer Office, Edinburgh, and receives his accustomed alms. (1860.)

BLUE-MANTLE, the title of an English pursuivant-at-arms. See PURSUIVANT.

BLUE MOUNTAINS, the name of two mountain-chains, the one in New South Wales, the other in Jamaica.—1. The B. M. of New South Wales run very nearly parallel with the coast, and being impassable by nature, long threatened to cut off the maritime part of the colony from the interior. To cross this apparently insurmountable barrier was the grand aim of the colony during the first 24 years of its existence, Surgeon Bass, the discoverer of the strait that bears his name, standing pre-eminent among the adventurous and patient explorers. It was not till 1813 that a practicable passage was found, or rather made, for it terminated towards the west in a zigzag road down a nearly perpendicular height of 670 feet; but it was not before 25th April 1815—a day ever memorable in the local annals—that Governor Macquarie, with a numerous retinue, actually opened a route into the Bathurst Plains, then yielding the richest pasturage in the colony, and now forming its gold-field. The B. M. are the dividing-ridge between the rivers of the coast and those of the interior. They are of very considerable height, for some parts of the road which crosses them are about 3400 feet above the sea—an elevation nearly equal to that of any point in England or Wales.—2. The still loftier range of the same name in Jamaica traverses the whole length of the island from east to west. These B. M. in some places attain an altitude of 6000 feet.

BLUE PILL (*Pilula hydrargyri*) is the most

simple form in which mercury can be administered internally. It consists merely of two parts of mercury rubbed up with three parts of conserve of roses, till globules of mercury can no longer be detected; to this is added powdered liquorice-root, so that a pill of five grains contains one grain of mercury.

In cases of torpid condition of the liver or inflammation of that organ, B. P. is much used as a purgative, either alone or combined with some other drug, such as rhubarb. When it is given with the view of bringing the system under the influence of mercury (Salvation, q. v.), small doses of opium should be added to counteract its purgative tendency, and the state of the gums watched carefully from day to day, so that the first symptoms of salivation may be noticed, and the medicine omitted. As a purgative, the common dose of B. P. is one or two pills of five grains each, followed by a purgative draught. When the system is to be saturated with it, or salivated, one pill may be given morning and evening, or one every night combined with $\frac{1}{4}$ of a grain of opium, repeated till the gums become sore. But the sensibility to the action of mercury varies with the individual; some may take large quantities before it exhibits its physiological symptoms, and on the other hand, three blue pills, one taken on three successive nights, have brought on a fatal salivation. When taking blue pills, all sudden changes of temperature should be avoided; and, indeed, though they are found in every domestic medicine-chest, neither they nor any other form of mercury should be given without good cause and without the greatest caution.

BLUE RIDGE, the most easterly range of the Alleghamies, in the United States. It forms an almost continuous chain from West Point in New York down to the north of Alabama, through New Jersey, Pennsylvania, Virginia, the Carolinas, and Georgia. It divides Virginia into Eastern and Western. Mount Mitchell, in North Carolina, the loftiest point of the B. R., is 6470 feet above the sea; while the Otter Peaks in Virginia, next in elevation, have an altitude of 4200 feet.

BLUE STOCKING, a name given to learned and literary ladies, who display their acquirements in a vain and pedantic manner, to the neglect of womanly duties and virtues. The name is derived from a literary society formed in London about the year 1780, which included both men and women. A lady of the name of Stillingfleet, who was in the habit of wearing blue stockings, was a distinguished member of this society; hence the name, which has been adopted both in Germany and France.

BLUE THROAT, or **BLUE BREAST**, also called Bluethroated Warbler and Bluethroated Robin (*Phenicura Suecica*, or *Sylvia Suecica*, see SYLVIADÆ), a beautiful bird, a very little larger than a redbreast, and much resembling it, but having the throat and upper part of the neck of a brilliant sky-blue, with a spot in the centre, which in some specimens is pure white, and in very old males is red. Below the blue colour is a black bar, then a line of white, and again a broad band of bright chestnut. The B. is well known as a summer bird of passage in many parts of Europe, from the Mediterranean Sea to the Arctic Ocean, but is very rare in Britain, only a few instances of its occurrence having been recorded. It is supposed to spend the winter in Africa. Great numbers are caught for the table in Lorraine and Alsace. The bird is one of those known by the names of *Becfin* (q. v.) and *Beccafico* (q. v.), and esteemed a delicacy. It is a bird of very sweet song. It imitates, to an unusual degree, the notes of other birds, so that the Laplanders give it a name which signifies the bird of a hundred tongues.

BLUE WING, according to some naturalists, a genus of *Anatide*, which has been named *Cyanopterus* (by a sort of Greek translation of the English name), but more generally regarded as a mere section or subsection of the restricted but still large genus *Anas*. See DUCK. The tail-feathers are only 14 in number, instead of 16, as in the common duck, teal, &c.; but the character from which the name is derived is, after all, that which chiefly distinguishes the bluewings, and never fails to arrest attention. The best known species, the Common or Lunate B. (*Anas* or *Cyanopterus discors*), is generally called the Blue-winged Teal in the United States of America, where it is very abundant. Vast numbers spend the winter in the extensive marshes near the mouths of the Mississippi, to which they congregate both from the north and from the coast regions of the east; but the summer migrations of the species extend as far north as the 57th parallel, and it is plentiful on the Saskatchewan in the breeding-season. It breeds, however, also in the marshes of the south, even in Texas; and is common in Jamaica, where it is supposed to be not a mere bird of passage, but a permanent resident. None of the duck tribe is in higher esteem for the table, and it has therefore been suggested that the B. is particularly worthy of domestication, of which it seems to be very easily susceptible. In size it is rather larger than the common teal; in the summer plumage of the male, the upper part of the head is black, the other parts of the head are of a deep purplish blue, except a half-moon shaped patch of pure white before each eye; the prevalent colour of the rest of the plumage on the upper parts is brown mixed and glossed with green, except that the wings exhibit various shades of blue, the lesser wing-coverts being of a rich ultramarine blue, with an almost metallic lustre; the lower parts are reddish orange spotted with black; the tail is brown, its feathers short and pointed.—The B. is a bird of extremely rapid and well-sustained flight. The flocks of the B. are sometimes so numerous and so closely crowded together on the muddy marshes near New Orleans, that Audubon mentions having seen 84 killed by the simultaneous discharge of the two barrels of a double-barrelled gun.—There are other species of B., also American; but this alone seems to visit the more northern regions.

BLUM, ROBERT, was born in very humble circumstances at Cologne, 10th November 1807. After a brief military service in 1830, he became scene-shifter, afterwards secretary and treasurer, to Ringelhardt, director of a theatre at Cologne, and subsequently at Leipsic, in which situation he remained, devoting his leisure time to literature and politics until 1847, when he established himself as bookseller and publisher. In 1840, he founded at Leipsic the *Schillers-Verein*, i. e., Schiller's Society, which celebrated the poet's anniversary, as a festival in honour of political liberty. In 1845 he acquired, in connection with the German Catholic movement and the political outbreaks in Leipsic, great reputation as a popular orator; and in 1848, was elected vice-president of the provisional parliament at Frankfort, and as such he ruled that turbulent assembly by presence of mind and a stentorian voice. In the National Assembly he became leader of the Left; and was one of the bearers of a congratulatory address from the Left to the people of Vienna, when they rose in October. At Vienna he joined the insurgents, was arrested, and shot on the 9th November. B. was a man of strong character, of great natural intelligence, and a speaker of stirring eloquence. For heading a party, he possessed cleverness and ambition enough, but he had not that passion and fanaticism which scorns to consider

the consequences likely to flow from unbridled popular licence. The news of his execution caused an indignant outcry among the democrats in Germany, who, besides instituting commemorations for the dead, made an ample subscription for his widow and children.

BLUMENBACH, JOHANN FRIEDRICH, a very eminent naturalist, was born at Gotha, 11th May 1752. He studied at Jena and Göttingen, in the latter of which universities he became extraordinary professor in 1776, and ordinary professor in 1778. Here he lectured for fifty years on natural history, comparative anatomy, physiology, and the history of medicine. In 1785, consequently before Cuvier, he made natural history dependent on comparative anatomy. His *Manual of Comparative Anatomy and Physiology* has been translated into almost all the principal languages of Europe. The natural history of man was always his favourite study; and his *Collectio Craniorum Diversarum Gentium*, commenced in 1791, and completed in 1808, gave to the learned world the result of his observations on the skulls of different races, of which he had an extensive collection (see ETHNOLOGY). He published many other works on natural history, all of which were favourably received; for, both as a writer and a lecturer, he was eminently successful. His *Manual of Natural History*, indeed, has gone through 12 editions. Towards the end of the 18th c., he visited England, where he met with a distinguished reception from the most famous naturalists. On the 19th September 1825, his friends celebrated the jubilee of his doctorate, presented him on the occasion with a medal struck on purpose, and founded an exhibition in his name, the proceeds of which were to assist young physicians and naturalists in the prosecution of their researches by travel. In 1835, the increasing infirmities of age compelled him to resign his academical functions. He died on the 22d January 1840.

BLU'NDERBUSS is a kind of short musket with a very wide bore, sufficient to take in several shot or bullets at once. It has a limited range, but is very destructive at close quarters. As a military weapon, it is chiefly of service in defending passages, door-ways, staircases, &c. Some of the English and German troopers in the 17th c. were armed with the B.; but the carbine has since nearly superseded this weapon.

BLUSHING, a sudden reddening of the face, neck, and breast, owing to some mental shock, most commonly of the character of humiliation or shame. The nature and cause of this effect have been recently elucidated by physiological researches. It is produced by an increased flow of blood into the capillary vessels over the parts where the blush extends. Besides reddening the complexion, it creates a sensible augmentation of heat in those parts. The feeling that accompanies the state is of a distressing kind.

The phenomenon of B. is part of a general influence exerted on the capillary circulation by mental causes operating through the brain. The experiments whereby the existence of this influence has been established, may be described as follows: The *small blood-vessels*, by which the blood is brought into proximity with the various tissues of the body, are kept in a state of balanced distension between two forces: the one the propulsive power of the heart's action, which fills and distends them; the other, an influence derived from the nervous centres, and acting upon the muscular fibres so as to contract the vessels. The first of the two forces—the agency of the heart—is quite well

understood: it is simply like the case of distending the hose of a fire-engine by working the pump, and driving the water along. The counteracting force of the nerve-centres is proved by the following experiments: When the sympathetic nerve proceeding to the vessels of the head and face of an animal is cut, there follows congestion of the blood-vessels with augmented heat over the whole surface supplied by the nerve. The ear is seen to become redder; a thermometer inserted in the nostril shews an increase of temperature, the sign of a greater quantity of blood flowing into the capillaries. The inference from the experiment is, that, from the withdrawal of a counterpoise, the force that *distends* the small blood-vessels—that is to say, the heart's action—has an unusual predominance. It is further proved that this nervous influence, acting upon the minute muscular fibres of the small vessels, proceeds from the nerve-centres lodged in the head, for, by cutting the connection between the brain and the ganglion in the neck, from which the above-mentioned nerve is derived, the same restraining influence is arrested, and the congestion takes place. By stimulating the divided nerve galvanically, the suffusion disappears, the vessels shrinking by the galvanic contraction of their muscular coats.

The agency now described is of a piece with the action of the brain upon involuntary muscles generally, as the heart and the intestinal canal, and by it many organic functions—digestion, nutrition, absorption, &c.—are affected by those changes in the cerebral substance that accompany mental states. It is known that mental excitement has an immediate influence in all those functions; one set of passions, such as fear, tend to derange them, while joy and exhilaration operate favourably upon them.

To apply these observations to the case in hand. Supposing a person in the average mental condition, and something to arise which gives a painful shock to the feelings—a piece of ill news, a reproach from some one whose good opinion is much valued, an open shame, or the fear of it, a fit of remorse, an occasion of grief—the pain is accompanied with a sudden loss, or waste, or decrease of cerebral power; none of the functions that the brain aids in maintaining is so strongly stimulated as before; and in particular, that stream of nervous energy which balances the heart's action in regulating the distension of the small blood-vessels, is abated, the abatement being made apparent in the redness and heat over the face and neck. In a great stroke of mental depression, the influence is of a much more extensive kind, though still of the same nature essentially as regards the enfeeblement of the nervous energy, and may lower the action of the heart itself: in which case there will be a widespread pallor, perhaps without a blush. In all probability, it is when the loss of cerebral influence extends only to the relaxation of the muscular fibres of the small vessels, leaving the heart in its usual vigour, that the state of B. is most fully manifested. Hence it is more apt to arise out of the smaller modes of painful apprehension, than from the more serious calamities that prostrate the system throughout.

It is said that, in the Circassian slave-market, a young woman that blushes fetches a higher price. Some complexions do not shew the increased flow of blood in this way, and all persons are not equally sensitive to the cerebral shock that causes it.

BO TREE, the name given in Ceylon to the PEPUL (q. v.) of India (*Ficus religiosa*). It is held sacred by the Buddhists, and planted close by every temple, attracting almost as much veneration as the statue of Buddha itself.—The B. T. of the

sacred city Anarajapoor, is in all probability the oldest tree in the world, of which the age can

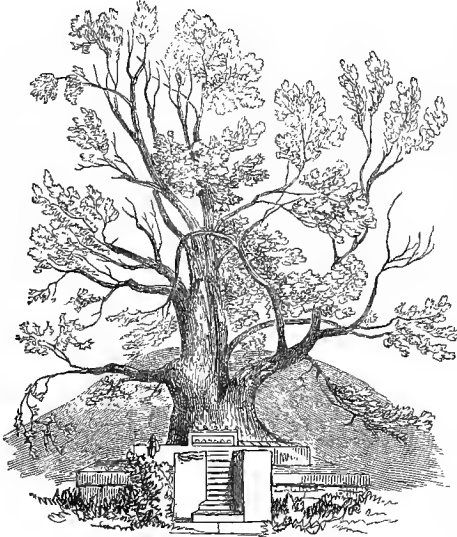

Bo Tree.

From a Drawing in Tennent's work on Ceylon.

be ascertained by historical evidence. It was planted in 238 B. C., and is therefore now (in 1860) 2143 years old. Sir James Emerson Tennent, in his work on Ceylon, gives reasons for believing that the tree is really of this wonderful age, and refers to historic documents in which it is mentioned at different dates, as 132 A. D., 223 A. D., and so on to the present day. This tree is invested, in the estimation of the Buddhists, with wonderful sanctity. 'To it,' says Sir James, 'kings have even dedicated their dominions in testimony of their belief that it is a branch of the identical fig-tree under which Gotama Buddha reclined at Uruvelaya when he underwent his apotheosis.' Its leaves are carried away as treasures by pilgrims; but it is too sacred to be touched with a knife, and therefore they are only gathered when they fall.

BOA, in popular language, the name of all those large serpents which kill their prey by entwining themselves around it, and constricting it in their coils; but by zoologists of the present day, limited as the name of a genus to a very small portion of their number, all of which are natives of the warm parts of America—the similar large serpents of Asia and Africa forming the genus *Python* (q. v.). The name *B.*, however, was certainly not originally applied to American serpents, for it is used by Pliny, who accounts for its origin by a fable of serpents sucking the milk of cows, thus referring it, very improbably, to the Latin *bos*, an ox. The Linnaean genus *B.* comprehended all serpents having simple subcaudal plates, but without spur or rattle at the end of the tail, and was thus very artificial, as founded chiefly upon a single unimportant character, and consisted of a very miscellaneous assemblage of species, venomous and non-venomous. The *B.* family, or *Boïdæ*, as now constituted (containing the *Pythons*, &c., of the old world, as well as the true *Boas* of the new), is almost exclusively confined to tropical climates, and all

the species are of large size and great strength, some of them far exceeding in these respects all other serpents. The story related by the ancients of a serpent 120 feet in length, which devoured several soldiers, and caused alarm to a Roman army in Africa, may perhaps be deemed unworthy of credit, although the skin is said to have been long preserved at Rome; but there is good reason to believe that serpents in more modern times have attained at least half this length, and have made even the larger mammalia, and sometimes man, their prey. The *Boïdæ* are not venomous; but their mouth, although destitute of poison-fangs, is so furnished with teeth as to make their bite very severe. Their teeth are numerous, long, and directed backwards, so as the more effectually to prevent the escape of the prey, which is first seized by the mouth, and then the serpent, with a rapidity of

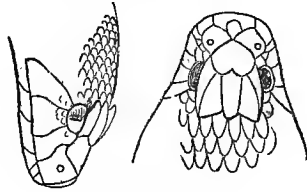

Head of Boa.

motion which the eye of the closest observer fails perfectly to follow, coils itself around it; the powerful muscles of the body are afterwards brought into action to compress it, so that usually in a few minutes its life is extinct, and its bones are broken. Deglutition then takes place—not, as has been alleged, after the prey has been licked and covered with saliva by the tongue, but accompanied with an extraordinary flow of saliva, which seems not only to serve for lubrication, but to have the property of hastening the decomposition of animal substances, and so to assist in making the prey more easy to be swallowed. It is always swallowed entire, and the process is sometimes rather a tedious one, and seems to require no small muscular effort; but the muscles of the serpent are capable of acting for this purpose, even at the neck, when that usually narrowest part of the body is distended to an enormous degree as the prey passes through it. The lower jaw is not simply articulated to the skull, but by the intervention of other bones, a structure without which the prodigious dilatation of the throat would be impossible. The lungs consist of two lobes, one much larger than the other, and at the extremity of the larger is an extremely capacious air-bag, which is supposed to serve for the necessary aeration of the blood whilst respiration is impeded in the process of deglutition.

The tail in all the *Boïdæ* has great prehensile power, and its grasp of a tree round which it may be coiled is aided by the opposing action of two claws, one on each side of the anus, which are really the representatives of the hinder limbs of the superior vertebrate animals, and which, on dissection, are found to be connected not only with strong muscles, but with bones entirely concealed within the serpent, one jointed to another, so as to make the character of a rudimentary limb very apparent. These serpents, being almost all inhabitants of watery places, often lie in wait for animals that come to drink; thus the largest of the American species, *Boa* (*Eunectes*) *murina*—sometimes called *Anaconda*,



Claw of Boa.

although Anaconda seems to be originally, like B., the name of a serpent of the old world—is to be found where rivers or narrow lagoons are overshadowed by gloomy forests. Perhaps the want of sufficient supplies of water, more than the greater cold of the climate, may account for the short time that specimens of the *Boideæ* brought to Europe have generally lived in confinement.

After a repast, these serpents spend a considerable time in a state of comparative torpidity—several weeks generally elapsing before they waken up to require a new supply—and in this lethargic state they are easily killed. When they do waken up, the demands of appetite seem to be very urgent. Many of our readers must still remember the interest excited some years ago concerning a B. in the London Zoological Gardens, which, to the astonishment of its keepers, swallowed its rug; but this, after a trial of a week or two, it found indigestible, and the animal then gratified public curiosity by a reversal of the process of deglutition.

The head in the *Boideæ* is thick, yet somewhat elongated; the eyes are small; the body is thickest in the middle; the tail usually has a blunt termination. The scales are numerous and rather small. The colours are various, and in many of the species rather bright and elegantly disposed. The true boas have the plates underneath the tail double, whilst in the pythons they are single. The species to which the name *Boa Constrictor* is appropriated, is far from being one of the largest, seldom attaining a length of more than twelve feet. It is common in Surinam and Brazil, where its skin is used for making boots and saddle-cloths. The name *Boa Constrictor* is, however, popularly extended to almost any of the species.—The number of species, whether in the genus or in the family, is far from being well ascertained.

Boas are much infested by intestinal worms, which appear often to cause their death. The excrement of the B.—the urine and faeces being combined as in other reptiles, and voided by a single vent—is a solid white substance, and consists mainly of urate of ammonia, accompanied by phosphate of lime (bone-earth). It is employed as an easy source of uric acid.

BOADICEA, a warrior-queen of the Iceni, a tribe inhabiting the eastern coast of Britain, in the time of the Romans. She flourished after the middle of the 1st century. Prasutagus, her husband, who died A. D. 60, or 61, had left his wealth jointly to the Roman Emperor Nero, and to his two daughters, hoping that by this artifice his kingdom would be protected from oppression; but the Roman soldiery, taking advantage of the defenceless condition of the country, began to plunder unscrupulously. B. herself was scourged, her daughters were violated, and the noblest among the Iceni were treated as slaves. These outrages soon drove the Britons to revenge. B. gathered round her a large army; attacked and captured the Roman colony of Camalodunum; defeated Petilius Cerealis, legate of the ninth legion, who was marching to its relief; took Londinium and Verulamium; and destroyed, it is said, somewhere about 70,000 Romans, many of them by torture. Suetonius, the Roman governor of Britain, now advanced at the head of 10,000 men against B., who, we are informed, had under her command no less than 263,000. A dreadful battle ensued (62 A. D.), in which, according to Tacitus, 80,000 Britons perished, and only 400 Romans. These figures, of course, cannot be trusted; but the victory must have been decisive, as it finally established the authority of the Romans in Britain. B., overwhelmed with despair, committed suicide.

BOARD, the general name applied to persons in

their collective capacity, who have the management of some public office or department, bank, railway, charity, or, indeed, of any other trust. Thus, the Commissioners of Customs, when met for the transaction of business, are called the B. of Customs; the Lords of the Treasury, the B. of Treasury; Commissioners of Excise, B. of Excise; directors of railways, B. of Directors; poor-law guardians, B. of Guardians, &c. See CUSTOMS, TREASURY, &c.

BOARD, BOARDING. In nautical language, *board* is used with many significations. Besides its ordinary application to a plank of wood, B. is a space or portion of sea over which a ship passes in tacking; hence the phrases, 'to make a good board,' 'to make short boards,' 'to make a stern-board,' 'to leave the land on back-board,' &c.—all of which refer to the direction of a ship's movement at a particular time and place. Again, *board* or *aboard* relates to the interior of the ship, in such phrases as 'to go aboard,' 'to heave overboard,' &c.

But the most important of these meanings is that which relates to the *boarding* of an enemy's ship, or making a forcible entry for the sake of capturing it. Whenever this bold operation is determined on, certain seamen are told off to act as boarders. It is very rarely that, between two men-of-war, this operation is ventured on; it would, in most cases, be too perilous to the assailants, who more frequently conquer by cannon and musketry. Boarding is, in most instances, attempted by privateers against merchantmen, where the defenders are few in number. The assailant well considers all the circumstances for and against him—the relative sizes of the two vessels, the relative strength of the crews, the state of the wind and sea, and the chances of escape if foiled. Besides the pistols, cutlasses, and boarding-pikes of the seamen, there are provided powder-flasks for producing smoke and confusion on the enemy's deck, and shells called stink-pots, for producing an intolerable stench. The moment and the spot being selected, the fuses of the flasks and stink-pots are lighted; these combustibles are thrown upon the enemy's deck; and while the fire, smoke, and stench are doing their work by confusing the enemy, the boarders climb on board, and gain a mastery by their personal prowess—that is, if the calculations of relative strength have been duly made. Sometimes terrible hand-to-hand encounters take place on deck before victory decides for or against the assailants.

General Sir Howard Douglas, in his recent work on 'Warfare with Steam,' expresses an opinion that steam war-ships are likely sometimes to come to close quarters; and that, on that account, they should be provided with a larger quota of marines and of boarding-implements than have hitherto been supplied to sailing ships. The defenders, he adds, should construct loopholed barricades across the terminations of the quarter-deck and the fore-castle, to prolong the defence within board. The French naval officers, it is known, look forward to a great increase in all such military resources on board war-steamers; and Sir Howard is endeavouring to impress similar convictions on the English authorities.

BOARD OF ADMIRALTY, a government department which has the management of all matters concerning the British navy. In the article ADMIRAL, the steps are noticed by which the duties of the Lord High Admiral, in former days, were transferred to a Board of Commissioners. The constitution and functions of this body will now be described.

The B. of A. comprises six lords commissioners, who decide collectively on all important questions. Besides this collective or corporate action, each has

special duties assigned to him. There are two civil or political lords, and four naval or sea lords. The first lord, who is always a cabinet minister, besides a general control, has the management of naval estimates, finance, political affairs, slave-trade prevention, appointments, and promotions. The first naval lord manages the composition and distribution of the fleet, naval discipline, appointment of inferior officers, commissioning ships, general instructions, sailing orders, and the naval reserve. The second naval lord attends to armaments, manning the navy, the coast-guard, the marines, marine artillery, dock-yard brigades, and naval apprentices. The third naval lord attends to naval architecture, the building and repairing of ships, steam-machinery, and new inventions. The fourth naval lord has control over the purchase and disposal of stores, victualling ships, navy medical affairs, transports, convicts, and pensioners. The junior civil lord attends to accounts, mail-packets, Greenwich Hospital, naval chaplains, and schools. Under these six lords are two secretaries-in-chief, who manage the daily office work. The lords all resign when the prime minister resigns, and are usually replaced by others. This change gives rise to many evils. There is likely to be a change of views and of system: the new Board is not bound to act on the plans of its predecessors; and many of the costly novelties in the navy within the last ten years are directly traceable to this cause. The system is defended on the plea that these changes infuse new blood into the Admiralty, and give fair-play to increased knowledge and new plans. Some statesmen advocate a modified plan: proposing to render a few naval officers of rank permanent lords of the Admiralty, and only changing the others on a change of ministry. A connecting-link between the old and new Boards is the surveyor of the navy, who is a permanent officer. Every morning, a junior lord assists a clerk in apportioning all letters and dispatches among the several departments. Each lord of a department then attends to his own. The secretaries and the lords determine which letters ought to be submitted to the Board collectively: and that portion of the correspondence is treated as in most boards and committees. All delicate or doubtful matters are specially reserved for the first lord; but in the Board meetings he has only one vote, like the rest. The Admiralty House at Whitehall being too small for the business required to be done, many rooms in Somerset House are also appropriated by the Board; an arrangement that leads to much waste of time. The offices of the surveyor of the navy, the accountant-general, the storekeeper-general, the comptroller of victualling and transports, the navy medical department, the comptroller of steam-machinery, and the director of works—are at Somerset House; and numerous messengers are employed all day long in conveying letters, documents, and messages from those departments to the Admiralty, where the lords, the chief secretaries, and the hydrographer have their offices.

BOARD OF ORDNANCE, a government department having the management of all affairs relating to the artillery and engineering corps of the British army. Under this precise designation, the Board no longer exists: a change having recently been made which requires brief explanation. The B. of O., until 1854, comprised the master-general of the Ordnance, the surveyor-general, the clerk of the Ordnance, and the principal storekeeper. There was no chairman at the meetings, and the Board often consisted of only one officer. The master-general had a veto, and was in that respect more powerful than the chief member of the Board of Admiralty; although, not having necessarily a seat

in the cabinet, he had less political power. The Board days were thrice a week; and each of the four members had control over certain departments—the patronage of which was generally vested in him. Scarcely any improvements were made from 1828 till 1854, and the general arrangements were very defective. Of the four members, the master-general had a sort of general authority and veto; the surveyor-general had control over the artillery, engineers, sappers and miners, ordnance medical corps, contracts, laboratory, gunpowder, barracks, and navy gunners; the chief clerk managed the estimates, money-arrangements, civil establishment, pensions, superannuations, and Ordnance property; while the storekeeper-general had charge of stores, store-rooms, naval equipments, and naval war-stores. In matters relating to coast-defences, it was often difficult to decide between the Admiralty and the Ordnance: each Board claiming authority. When the Crimean disasters took place in 1854, the defects of the B. of O. became fully apparent: it could not work harmoniously with the other government departments: The Board was dissolved, the office of master-general abolished, and the duties were distributed among different branches of the War-office, in a way that will be briefly noticed under WAR DEPARTMENT.

BOARD OF TRADE. See TRADE, BOARD OF.

BOAR-FISH (*Capros*), a genus of fishes of the Dory (q. v.) family, or *Zeida*, differing from the genus *Zeus*, or Dory, in the still more protractile mouth—the resemblance of which to the snout of a hog is supposed to have given origin to the name—in the want of spines at the base of the dorsal

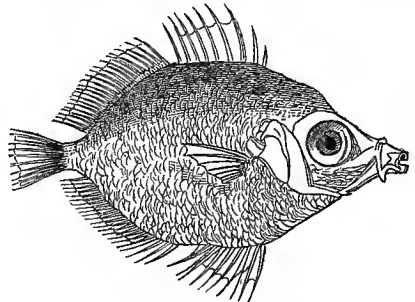

Boar-Fish (*C. Aper*).

and anal fins, and of long filaments to the dorsal spines. The body has the usual oval, much compressed form of the family. The common B. (*C. Aper*) is a well-known inhabitant of the Mediterranean, rarely caught on the coasts of England. The eyes are very large, and placed far forward; the body is of a carmine colour, lighter below, and with seven transverse orange bands on the back. The flesh is little esteemed.

BOAR'S HEAD. The B. H. is the subject of a variety of legends, poetic allusions, and carols connected with the festivities of Christmas in England. At this wintry season, the wild boar was hunted, and his head served up as the most important dish on the baronial table. According to Scott's graphic lines:

Then was brought in the lusty brawn
By blue-coated serving-man;
Then the grim boar's head frowned on high,
Crested with bays and rosemary.
Well can the green-garbed ranger tell,
How, when, and where the monster fell;
What dogs before his death he tore,
And all the baiting of the boar.

Referring to the article CHRISTMAS for a notice of some of the observances on this occasion, we need here only say, that in the 'boar's-head carols' are found some of the most interesting specimens of the old English convivial verses. The following, from a carol printed by Wynkin de Worde (1521), may be given :

*Capud Apri desero
Reddens laudes Domino.*

The boar's head in hand bring I,
With garland gay and rosemary;
I pray you all sing merrily
Qui estis in convivio.

The boar's head, I understand,
Is the chief service in this land;
Look wherever it be found,
Servite cum cantico.

The boar's head 'erased,' according to heraldic phraseology, is a well-known cognizance of a number of old families, particularly the Gordons; it also formed the sign of a tavern at Eastcheap, London, which has been immortalised by Shakespeare. On the site of this famed tavern now stands the statue of William IV.

BOAST (Fr. *Ebaucher*), a word in use with sculptors. To B., as its French original implies, is to block out a piece of stone or wood, so as to form a rude approach to the ultimate figure, leaving the smaller details to be worked out afterwards. Ornamental portions of buildings are often inserted in their places in this condition, and frequently remain so if they are in an obscure position.

BOAT is the general name for a small open vessel. Boats differ, however, greatly one from another. They may be slight or strong, sharp or flat-bottomed, decked or undecked, swift for despatch or roomy for cargo, ornamental for pleasure or plain for hard service, deep or light of draught for deep or shallow water. The chief varieties supplied to ships of war are the following—*Long-B.*: the largest B. of a ship, furnished with mast and sails; it is either armed and equipped, to render warlike service in certain situations, or it is employed to fetch water, wood, provisions, and heavy stores on board. *Launch*: longer and more flat-bottomed than the long-B.; being rowed with a greater number of oars, it makes more rapid progress up rivers. *Barge*: a long, narrow, light B., employed in carrying the principal officers to and from the ship; for other kinds of boats or vessels under this name, see **BARGE**. *Pinnace*: a B. for the accommodation of the inferior officers; it has usually eight oars, whereas the barge has ten or more. *Cutter*: broader, deeper, and shorter than the barge or pinnace; it is rowed with six oars, sometimes hoisting a sail, and is chiefly employed in carrying light stores, provisions, and crew. *Jolly-B.*: a smaller cutter, rowed with four oars instead of six. *Yawl*: small in size, and used for nearly the same purposes as cutters and jolly-boats. *Gig*: a long narrow B., rowed with six or eight oars, and employed by the chief officer on expeditions requiring speed. Some of the above-named boats are diagonal-built for strength; the others are clincher-built, to be as light as possible. The largest ships of war carry boats of all these various kinds, varying in weight from 110 cwt. down to 10 cwt.; the smaller ships carry fewer; while merchant-ships have seldom more than three—except passenger-ships, which are bound by law to carry boats enough to save all the passengers and crew in case of disaster. There are other kinds of boats which do not belong to ships. See **BOATING**.

In reference to the legal regulation of boats in the merchant-service, the following are the chief

provisions: When a B. belongs to any ship or other vessel, the name of the vessel and of the place to which she belongs must be painted on the outside of the stern of the B., and the master's name within side the transom—the letters to be white or yellow on a black ground. Boats not belonging to ships or other vessels must be inscribed with the name of the owners and the port to which they belong. All boats having double sides or bottoms, or any secret places adapted for the concealment of goods, are liable to forfeiture.

The boats intended for the rescue of shipwrecked persons, or crews and passengers exposed to that danger, are described under **LIFE-BOAT**.

BOAT-FLY (*Notonecta*), a genus of insects of the order *Hemiptera* (q. v.), suborder, *Heteroptera*, and of the family of the *Hydrocorisæ*, or Waterbugs (q. v.). All of them, like the rest of the family, are aquatic insects. Their English name is derived from their boat-like form, eminently adapted for progression in water, and probably also from their remarkable habit of always swimming on their back—peculiar to the genus *Notonecta*, as restricted by recent entomologists—and of resting in this posture suspended at the surface of the water. The known species of this genus are not numerous. One of them, *N. glauca* (sometimes called the *Water Boatman*), is common in Britain: it is about half an inch long, and varies considerably in colour; but exhibits a general greenish tinge, the other colours being black, brown, and gray. They fly well, but seldom use their wings. They move with difficulty on dry ground. When they descend into the water, they carry down a supply of air for respiration in a hollow between their folded wings. They feed on animal substances, and often kill and devour those of their own species.



Water Boatman
(*N. glauca*).

BOATING, the art of managing and propelling a boat. This is done either by means of oars or sails. As sailing is fully treated under the head of **YACHTING**, rowing only is dealt with here. The most ancient form of boat known to have been used in the British Islands is the coracle; it is still much used in Wales. The *coracle* is but a large wicker-work basket, covered with skins, or some thin water-proof substance stretched over the wicker-work, strengthened by a cross seat. Seated in one of these rude boats, with but a single paddle, it is astonishing with what dexterity the paddler will skim over broken water, and avoid dangers which would infallibly destroy a heavier or less manageable craft. From the coracle spring all the varied classes of boats now in use, either as pendants to ships, or as used for pleasure traffic or a means of conveyance upon our rivers and inland waters. The *wherry* next claims attention. There are many kinds of wherries, but we only notice the Thames wherry. This is stoutly built, and is constructed to carry about eight passengers. It is usually managed by one sculler or two oarsmen; it is almost entirely employed by watermen for the conveyance of passengers or pleasure-parties. The boats used for rowing as a sport or pastime are of a much lighter and sharper build. They are constructed of all sizes, to carry from eight oarsmen down to a single sculler. Of this class of boats, for racing purposes, we have the 8, 6, 4, 2, and single pair oared boats; while in contests between single scullers, we have what is denominated the *wager-boat*—a boat so frail and light in its proportions, that none but a most experienced sculler can sit in one without danger of upsetting. For pleasure, we have another class of

BOATING—BOAT-LOWERING APPARATUS.

boats denominated *gigs*, of stouter and more capacious build; they are constructed either for four oars, a pair of oars, or single sculls. Boat-racing is a practice of some antiquity, but it has only culminated in our day. Many prizes have been given from time to time for competition, some of which have been made annual. Perhaps the most famous of all these is Dogget's coat and badge, which is rowed for yearly on the Thames by water-

men's apprentices, on the 1st of August. It is a prize held in high estimation by young aspirants to rowing honours. But the events of most note in the rowing world are the Oxford and Cambridge 8-oared match, rowed annually upon the Thames, from Putney to Mortlake. This match has not been a regular yearly match, there having been occasional intervals at times of a year or two. In 1829, 1842, 1849, 1852, 1854, 1857, and 1859,

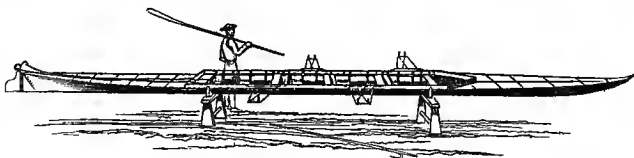

Four-oared Racing-boat.

the Oxford boat carried off the prize; Cambridge having wrested it from Oxford in the years 1836, 1839, 1840, 1841, 1845, 1846, 1849, 1856, 1858, 1860. 17 matches have come off in 32 years, the balance being still on the side of Cambridge. It will be noticed that two matches were rowed in 1849. The best picked men from each university are selected to contest this great event, and the hardest exercise and the severest training gone through by the crews, to improve their wind, strength, and endurance, for months before the day of rowing; their diet consisting mainly of the plainest cooked lean meat and potatoes, with malt liquors, spirituous drinks being prohibited, and the duties of temperance, soberness, and chastity strictly enforced. It was at one time thought that light men stood the best chance in these matches, and men weighing nine and ten stone were preferred; but experience has shewn this to be an error, and ten, eleven, and twelve stone men are now chiefly selected. The distance rowed upon this course, which is called 5 miles, is about $4\frac{1}{2}$. The time chosen is usually at slack-tide, and the time taken in rowing varies according as there is little or no tide or wind, or the reverse, from 19 to 26 minutes. Robert Coombes is said to have rowed it on one occasion in 18 minutes. The Cambridge boat, in a closely contested race in 1860, did the distance in 26 minutes 5 seconds, having previously, in one of their trials, rowed it in $21\frac{1}{2}$, the young ebb-tide, on the day of the match, being against them upon the latter half of the course. From 36 to 44 strokes of the oar taken per minute is held to be fair racing-pace; and a long steady even stroke—the blade of the oar not being dipped too deeply in the water, or thrown too high above the surface when withdrawn, the arms being well extended in taking the stroke, and the elbows brought well home to the sides at the conclusion—is the kind of stroke now preferred by connoisseurs. The other great events of the boat-racing world are the regattas of Henley and Putney. At the former, the Oxford and Cambridge crews usually fight their battle over again in conjunction with others for the challenge-cup; and at these also many scullers' matches are rowed, though single scullers' races for the championship of the Thames, &c., are usually events of themselves. The most renowned champion of the Thames was Robert Coombes, who wrested the championship from Charles Campbell on the 20th of August 1846, having previously defeated all the best men. He held it unbeaten for above six years. He at length succumbed to the prowess of Cole in 1852. Cole, in 1854, was beaten by Messenger; Messenger yielded the palm to Kelly in 1856; and Kelly was at length, in 1859, beaten by Robert Chambers, the champion of the Tyne, who now adds

to his titles champion of the Thames also. So much is B. favoured at our universities, that almost every college has its club.

BOAT-LOWERING APPARATUS is the name given to certain ropes and pulleys for lowering boats from ships quickly and safely, in case of emergency. Every passenger-ship is compelled by law to carry a certain number of boats, depending on the tonnage; and every ship of war necessarily carries boats (see **BOAT**) for minor services; but until recent years the apparatus was very inefficient for lowering these boats from the davits or cranes by which they are usually suspended. In shipwreck or other emergencies at sea, the boats were, until recent years, often so difficult to extricate that they could not be lowered in time to save the crew and passengers; or in lowering they capsized, and plunged the unhappy persons into the sea. Many inventors have recently directed their ingenuity to this subject, with a hope of devising a remedy. In Lacon's apparatus, the principal feature is the employment of a friction-brake, by which one man can regulate the rate of descent to varying degrees of speed. Captain Kynaston's *disengaging hooks* are intended not only to lower boats quickly and safely when suspended over the side of the ship, but also to hoist them out quickly when they happen to be stowed in-board. Wood and Rogers's apparatus resembles Kynaston's in this: that the actual lowering from the ship is effected by the crew on shipboard, leaving to the person or persons in the boat only the duty of disengaging it from the tackle. But the apparatus which now engages most attention is Clifford's, the leading principle of which is, that the lowering and the disengaging are both effected by one man seated in the boat. Two ropes or lowering pendants, *c* and *d* (see fig.), descend from two davits; pass through blocks or sheaves, *f*; then through other blocks, *h*, within and near the keel of the boat; and finally, round a roller, *a*, placed horizontally beneath the seat on which the manager of the boat takes his place. By means of a winding-rope, *b*, held in one hand, he can regulate the speed with which the other two ropes uncoil themselves from the roller, thus graduating the boat's descent to the water's level. When lowered, the two ropes can be thrown off and the boat set free. The slings or lifts, *g*, are intended to prevent the canting or upsetting of the boat. The lanyard, *m*, belongs to the lashings, *i*, which hold the boat to the side of the ship; but by the thimbles, *k*, slipping off the prongs, *o*, the boat is liberated. The efficiency of the apparatus is most remarkable. In 1856, by order of the Admiralty, experiments were made with the starboard-cutter of H.M.S. *Princess Royal*. Twelve men got into the boat while it was hanging

from the davits; it weighed, with the crew and the gear, nearly three tons; nevertheless, this cutter, thus laden, was successfully and quickly lowered by one of the twelve men, to a depth of 40 feet from

the davits to the water. Many other experiments of similar kind were made. Clifford's apparatus is now supplied to many ships of war and merchant-vessels; and many lives have been saved by its

CLIFFORD'S BOAT-LOWERING APPARATUS.

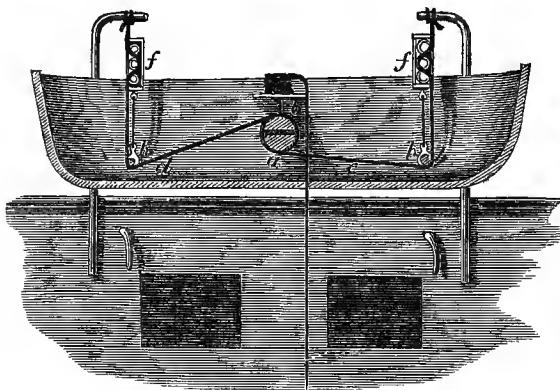

Longitudinal section of Boat.

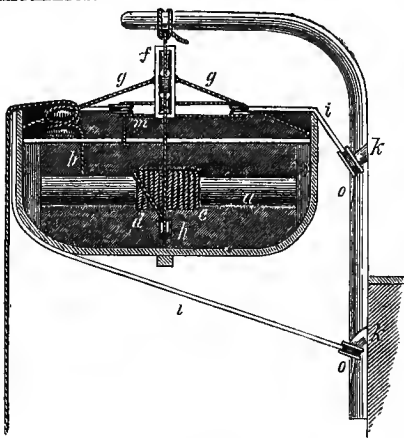

Transverse section of Boat.

means, under circumstances which would almost certainly have proved fatal under the old mode of lowering boats from the davits.

The apparatus above described is a mere appendage, not necessarily depending on the form and construction of the boat.

BOATSWAIN is a warrant-officer on board her Majesty's ships, who has charge of the boats, sails, rigging, cables, anchors, flags, and cordage. He is immediately under the master in some of these duties; he frequently examines the masts and yards, sails and ropes, to report on their condition and efficiency. He also keeps account of all the spare rigging, &c., and superintends the replacement of old by new. The B. has certain duties in connection with the crew: he assists in the necessary business of the ship, and in relieving the watch. In bad weather, he looks well to the boats and anchors, especially when night is coming on. A B. should be a good sailor, a good rigger, and a vigilant, sober, firm man.

The *boatswain's mate* assists in all the above-named duties; and to him is assigned the repulsive office of inflicting the flogging to which seamen are sometimes sentenced.

BOBBIN-NET is the name of a kind of net-fabric, usually made of cotton-thread. It is of the nature of lace, but is made in the lace-frame instead of by hand. The texture is peculiar: it consists in the interlacing of a set of long threads, representing the warp in common weaving, with a set of cross ones (the weft), in such a manner as to form a mesh-texture. B. is one of the most elegant of

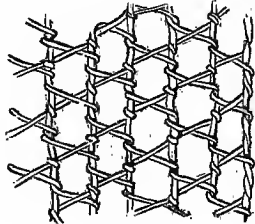

Bobbin-net texture.

textile fabrics, and forms an extensive branch of business, the chief seat of the manufacture in this country being Nottingham. See **LACE MANUFACTURE**.

BOBBINS are small wooden rollers, flanged at

the ends, to hold yarn, which is wound on them as a preparatory process to warping in the manufacture of cloth. B. are likewise extensively used in the spinning of yarn, chiefly in the preparatory processes, for holding rove. In throstle-spinning, however, they are an essential part of the machinery, as they receive the thread on their respective spindles as it comes from the rollers. B. are likewise very extensively used in the manufacture of thread.

Besides these, there are three other kinds of B., although not of the genuine type, which deserve to be named as belonging to the class—viz.: the B. used for holding silk, which are flangeless, the ends being merely raised and rounded a little, by slightly hollowing the barrel. Then the bobbin, called in Scotland *pin*, for delivering the weft from the shuttle, is simply a tapered pin, bored, it may be, throughout, with but the rudiments of a flange at the thick end; and next, the hobbin used for a similar purpose in lace-weaving, is merely a thin metal pulley, about the size of a halfpenny, deeply grooved in the rim, to hold the thread-weft. B., again, of a large size, and flanged and ribbed like the frame of a sand-glass, are called *reels*, and are chiefly used in cordage-spinning, and are frequently of iron.

The B. used in the thread-manufacture are small, being from less than one inch to more than two, according as they are made for three or six ply-cord, and holding 200 yards each. The thread B., and those for warping, are of hard wood, turned out of the solid block; but the larger B., for rove, called *slubbing B.*, are of pine, with the ends and barrels turned individually on the same arbor, and glued together.

The quantity of B. used in the various branches of business is enormous. In the thread manufacture alone, the wood required for them, in Britain only, is stated to be at least 40,000 tons annually; and assuming that a ton of wood produces 50 gross, taking the small and large together, we have 2,000,000 gross annually consumed in this manufacture, costing from 5*d.* to 1*s.* 4*d.* a gross, according to size, or, at an average, at least £80,000.

This enormous production is, of course, the result of the machinery employed in it. The thread B. are turned by a self-acting lathe, which turns out

about 100 gross in 10 hours, thereby effecting a saving of about sixteenfold, as compared with hand-turning; whilst the attendant has nothing to do but feed the machine, by dropping the blocks into a hopper, from which they pass singly into the lathe, where they are finished and dropped one by one out of the machine.

The quantity and value of the B. made use of, for warping and spinning, in the various manufacturing districts of the country, cannot be so well ascertained. It must be very great.

The price of the B. ranges from about 6s. a gross to about £18; or 2s. 6d. a piece for the large wooden B. used in cordage-spinning. The wood for B. is becoming scarce, so enormous is the supply wanted; and the trade is now under apprehension as to how it is to be kept up.

BO'BPIO, a town of Piedmont, capital of the province of the same name, is situated near the left bank of the Trebbia, about 37 miles north-east of Genoa. B. is an ancient place, having originated from a church and convent erected here in the end of the 6th, or beginning of the 7th c., in the crypt of which St Columbanus and some of his disciples lie buried. B. has a cathedral, an episcopal palace, and a palace belonging to the Malaspina family. It is guarded from the inundations of the Pellice by a long embankment, built by a money-grant from Oliver Cromwell, during whose protectorate the town was nearly destroyed by an inundation. Pop. 3976.

BO'BIA, or **PIRATE ISLE**, a singular island in the Bay of Amboise, off the coast of Guinea, Africa. Originally of considerable size, it has been greatly reduced by the action of the waves, and the same agency is still gradually lessening it. It is difficult of access, on account of the precipitous character of its shores, but is said to be densely peopled.

BO'B-O-LINK, or **BO'BLINK**, **REED BIRD**, or **RICE BIRD** (*Dolichonyx oryzivorus*), a bird nearly allied to buntings and sparrows, but of a genus characterised by stiff-pointed tail-feathers. It is rather larger than a yellow-hammer; and the male in his summer or nuptial plumage exhibits a fine contrast of colours, black, yellow, and white. The female differs greatly from the male in colours of plumage, yellowish-brown chiefly prevailing; and in the latter part of summer, the males assume the comparatively dull hues of the females. The B. is a bird of passage, spending the winter in the West Indies. In summer it is found as far north as the banks of the Saskatchewan, in lat. 54°, but is most plentiful in the Atlantic states and other eastern parts of America, where it is to be seen in every meadow and cornfield. It renders good service by the destruction of insects and their larvæ; but the immense flocks which congregate on their return southwards in autumn, commit great ravages in the rice-plantations of Carolina. At this season, these birds become extremely fat, and are killed in great numbers for the table. Their flesh is delicate, and resembles that of the ortolan.

The B. generally makes its nest in a grassy meadow, an artless structure of a few dry stalks and leaves, with a lining of finer grass. It displays the same instinct with many other birds, of seeking to lead intruders away from its nest, by pretending great anxiety about some other part of the field. During the breeding-season, the males are very musical, singing mostly in the air, in which they seem to rise and fall in successive jerks. Their song is very pleasing, and is 'emitted with a volubility bordering on the burlesque.' On account of their beauty and powers of song, many are caught, caged, and sold in the New York and other markets.

BOBRU'YSK, a fortified town of Russia, in the government of Minsk, and 83 miles south-east of the city of that name. It is situated on the right bank of the Beresina, and is a station for the steam-packets navigating the Dnieper and Beresina. It was besieged ineffectually by the French in 1812. Pop. stated at 10,000.

BO'B-STAY, in the rigging of a ship, is a rope used to confine the bowsprit down to the stem or cut-water; its purpose is to keep the bowsprit steady, by counteracting the force of the stays of the foremast, which draw it upwards.

BO'CA (Span. meaning *Mouth*), a term applied to the entrance of various straits and rivers, chiefly in America.—1. B. *Chica*, the channel of 28 miles in length, which leads to Cartagena in New Granada.—2. B. *de Navios*, the largest and most southerly outlet of the Orinoco.—3. B. *Grande*, a bay of the Caribbean Sea, at the mouth of the Zucar, in Costa Rica.—4. B. *del Toro*, on the Caribbean Sea, in Costa Rica, in lat. 9° 20' N., and long. 82° W.

BO'CCA TI'GRIS, or **BOGUE**, the name given to that portion of the estuary of the Canton River (q. v.) extending north from lat. 22° 45' N.; south of this point, the estuary is designated the 'Outer Waters.' In the centre of the B. T. are the rocky islands of North and South Wantung, while on the east the B. T. has the islands of Anunghoy and Chuenpee, and on the west the Ty-cock-tow island. On these islands are situated the Bogue forts, which have been more than once captured by the British. The last time they were taken was in November 1856, the occasion of quarrel being the refusal of the Chinese to make proper reparation for the capture of a vessel under British protection, but alleged, on the other hand, to be nothing but a smuggling craft, contriving to hide its real character by hoisting the British flag.

BOCCA'CCIO, **GIOVANNI**, the celebrated author of the *Decamerone*, was born in Paris, 1313. He styled himself *Da Certaldo*, and was sometimes named *Il Certaldese* by others, because his family sprang from Certaldo, a village in the Florentine territory. From an early period he displayed an invincible attachment to poetry, which his father attempted in various ways to thwart; but as soon as B. had attained his majority, he commenced to follow vigorously his own inclinations, poetising both in the Italian and Latin tongues, but not with any 'fine issues.' In prose he succeeded far better, developing quickly that airy grace of style which suits so admirably his light and lively tales, and which soon placed him in the highest rank of Italian prose-writers. He studied Dante closely, but did not confine himself to literature properly so called. In 1350, B. formed an intimate friendship with Petrarch, and, following his friend's example, collected many books and copied rare MSS., which he could not afford to buy. It is said that he was the first Italian who ever procured from Greece a copy of the *Iliad* and the *Odyssey*. He also wrote a *Genealogy of the Gods*, in 15 books, which was unquestionably the most comprehensive mythological work that Europe had as yet seen. But not only was B. one of the most learned men of his time, he was also one of the most enlightened in his scholarship. He helped to give a freer direction and a greater expansiveness to knowledge, stimulated his contemporaries to the study of Greek, and wished to substitute the wisdom of antiquity for the unprofitable scholasticism that prevailed.

While in Naples (1341), B. fell passionately in love with a young lady who was generally supposed to

be an illegitimate daughter of King Robert. His passion was returned, and to gratify his mistress, B. wrote *Il Filicopo*, a prose-romance, and afterwards *La Teseide*, the first attempt at romantic epic poetry, and written in *ottava rima*, of which B. may be considered the inventor. In 1342, he returned to Florence, but in 1344, went back to Naples, where he wrote his *Amorosa Fiammetta*, *Il Filostrato*, and *L'Amorosa Visione*. Here also he composed his famous *Decamerone*, to please Joanna, the daughter and successor of King Robert. It consists of 100 stories, ten of which are told each day by seven ladies and three gentlemen, who had fled from Florence during the frightful plague of 1348, to a country villa, and who try to banish fear by abandoning every moment to delicious gaiety. It is impossible to exaggerate the literary merits of the book. In abundance of incident especially, it is almost inexhaustible, though many of the stories are taken from older collections of *Contes et Fabliaux*. It is, however, unfortunately steeped in impurity. B. once more returned to Florence about 1350. He was now honoured with several diplomatic appointments by his fellow-citizens, and subsequently even thought of entering into holy orders as a penance for the immoral life he had previously led. From this artificial course of repentance he was wisely dissuaded by Petrarch, who advised him to be content with changing his conduct. In 1373, B. was appointed Dantean professor at Florence; that is to say, he was to deliver elucidatory lectures on the *Divina Commedia* of the great poet, and zealously devoted himself to the difficult task thus imposed on him; but his health failing, he resigned the office, and retired to his little property at Certaldo, where he died, December 21, 1375, 16 months after his friend Petrarch. Besides those works we have already mentioned, B. wrote *Origine, Vita e Costumi di Dante Alighieri*, and *Commento sopra la Commedia di Dante*. This commentary on the Divine Comedy extends only to the 17th canto of the *Inferno*. In Latin, B. wrote, beside the *Genealogia Deorum*, a work arranged in alphabetical order, *De Montibus, Silvis, Fontibus, Lacubus, Fluminibus, &c.*; *De Casibus Virorum et Fœminarum Illustrium*; *De Claris Mulieribus, &c.*

BOCCAGE, MARIE ANNE FIQUET DU, a French poetess, was born at Rouen, 22d October 1710, and received her education in the monastery of the Assumption at Paris, where her poetic tendencies early developed themselves, though only furtively. She first appeared as an authoress in a small volume of poems, published in 1746; next as an imitator of Milton in her *Paradis Terrestre* (1748); and in 1756, issued her most important work, *La Colombiade*. The letters which she addressed to her sister, Madame Duperron, while travelling through England, Holland, and Italy, are the most interesting things which have fallen from her pen. During her life, she was excessively admired and bepraised, especially by Voltaire, Fontenelle, and Clairaut. She used to be described as *Formâ Venus, arte Minerva!* The complimentary poems addressed to her would, if collected, fill many volumes. She was elected member of the academies of Rome, Bologna, Padua, Lyon and Rouen. She died 8th August 1802. Her poems fail now to explain the reputation she once enjoyed, and dispose us to believe that her personal attractions must have given a charm to her verses.

BOCHART, SAMUEL, a learned Protestant divine, was born of an ancient family at Rouen, in 1599. He very early exhibited remarkable talent, chiefly philological. After studying at Paris, Sedan, and Saumur, visiting England in 1621, and finishing his

education at Leyden, he was chosen pastor of the Protestant church at Caen, where he became very popular. In 1629, he gained great reputation by his victory, in a public discussion of several days' duration, over the famous Jesuit, Doctor Verin. The meetings gained additional éclat from the occasional presence of the Viceroy of Normandy, the Duke of Longueville. In 1646, appeared his Sacred Geography, bearing the title of *Phaleg and Canaan*. His *Hierozoicon*, or Scripture Zoology, to which he devoted many years of his life, appeared posthumously in 1675. In 1652, B. was invited to Stockholm by Queen Christina, and went thither accompanied by his friend Huet. The court-life, however, did not suit him, and his visit was short. He died suddenly, in 1667, while speaking at a meeting of the Caen Academy of Antiquaries. A complete edition of his works, with a life by Morin, was published at Leyden in 1712; and a new improved edition of the *Hierozoicon*, his most valuable work, at Leipsic, in 3 vols. 4to (1793—1796), by Rosenmüller.

BO'CHNIA, a town of Austrian Galicia, capital of a circle of the same name, and about 25 miles east-south-east of Cracow. The houses are built chiefly of wood. There are extensive mines of rock-salt in its vicinity, which employ upwards of 500 miners, and yield annually about 13,000 tons of salt. Pop. 5300.

BÖCKH, AUGUSTUS, the most erudite classical antiquary of Germany at the present day, was born 24th November 1785, at Carlsruhe, and entered the university of Halle in 1803. The prelections of Wolf determined him to the science of philology. His first publication was *Commentatio in Platonis qui vulgo fertur Minoem* (Halle, 1806). In 1808, appeared his *Græcæ Tragœdiæ Principum, Æschylis, Sophoclis, Euripididis, num ea quæ supersunt et genuina omnia sint*. In 1809, he became ordinary professor at the university of Heidelberg; and in 1811, he was translated to the chair of Rhetoric and Ancient Literature, at Berlin, where he has taught for upwards of forty years, forming many excellent scholars, and extending his reputation through all the learned circles of Europe. His conception of philology as an organically constructed whole, which aims at nothing short of an intellectual reproduction of antiquity, excited for a long time great opposition among his professional contemporaries, but has undoubtedly given an impetus to a deeper study of the old classical world. His lectures include not merely a grammatico-historical interpretation of the ancient authors, but also archæology proper, the history of ancient literature, philosophy, politics, religion, and social life. The four great works of B. which have, in fact, opened up new paths in the study of antiquity, are, 1st, his edition of Pindar (2 vols., Leip. 1811—1822), in which the metre and rhythm of the poet, as well as his artistic skill, are investigated and discussed with profound knowledge of the subject. 2d, *The Political Economy of Athens* (2 vols., Berlin, 1817), a work which remains unsurpassed for subtle research, surprising results, and clear exposition. It treats of the prices of goods, rate of workmen's wages, rent of houses and land, and other points of commercial economy, as well as of the larger questions of the state income and expenditure. It has been translated into English by Sir George Cornewall Lewis, under the title of *The Public Economy of Athens* (Lond. 2d edit. revised, 1842). 3d, *Investigations concerning the Weights, Coins, and Measures of Antiquity* (Berl. 1838). 4th, *Records of the Maritime Affairs of Attica* (Berl. 1840). The most important of his lesser works are the *Development of the Doctrines of Philolans*,
181

the *Pythagorean*, his edition of the *Antigone* of Sophocles, and a *Dissertation on the Silver Mines of Laurion in Attica*. B. has also the honour of having commenced, in 1824, the great work entitled *Corpus Inscriptionum Græcarum*, published at the expense of the Royal Academy of Berlin, and which, in 1850, had reached its third volume. It is intended to contain every known Greek inscription, whether printed or in manuscript. In 1852, appeared his *Researches on the Cosmical System of Plato*; and in 1855, *The Lunar Cycles of the Greeks*.

BO'CKLAND, BOCLAND, or BOOKLAND, one of the original modes of tenure of manor-land, also called charter-land or deed-land, which was held by a short and simple deed under certain rents and free services. It was land that had been severed by an act of government from the *Folcland* (q. v.), and converted into an estate of perpetual inheritance. It might belong to the church, to the king, or to a subject; it might be alienable and divisible at the will of the proprietor; it might be limited in its descent, without any power of alienation in the possessor. It was often granted for a single life or for more lives than one, with remainder in perpetuity to the church. It was forfeited for various delinquencies to the state.

The estate of the higher nobility consisted chiefly of bockland. Bishops and abbots might have B. of their own, in addition to what they held in right of the church. The Anglo-Saxon kings had private estates of B., and these estates did not merge in the crown, but were devisable by will, gift, or sale, and transmissible by inheritance, in the same manner as B. by a subject. (Kerr's *Blackstone*, vol. ii., p. 88; and see *An Inquiry into the Rise and Growth of the Royal Prerogative in England*, by John Allen, 1830, pp. 143—151; and *Wharton's Law Dictionary*, 2d ed., under *Bockland*.)

BO'DEN-SEE. See **CONSTANCE, LAKE OF.**

BODE'S LAW, an arithmetical relation subsisting between the distances of the planets from the sun. It may be thus stated: Write, in the first instance, a row of fours, and under these place a geometrical series beginning with 3, and increasing by the ratio 2, putting the 3 under the second 4; and by addition we have the series 4, 7, 10, &c., which gives nearly the relative distances of the planets from the sun.

4	4	4	4	4	4	4	4	4
	3	6	12	24	48	96	192	384
4	7	10	16	28	52	100	196	388

Thus, if 10 be taken as the distance of the earth from the sun, 4 will give that of Mercury, 7 that of Venus, and so forth. The actual relative distances are as follow, making 10 the distance of the earth—

Mercury.	Venus.	Earth.	Mars.	Asteroids.	Jupiter.	Saturn.	Uranus.	Neptune.
3.9	7.2	10	15.2	27.4	52	95.4	192	300

Close as is the correspondence between the law and the actual distances, no physical reason has been given to account for it, although there is little room for doubt that such exists. B. L., therefore, in the present state of science, is termed empirical. Kepler was the first to perceive the law, and Bode argued from it that a planet might be found between Mars and Jupiter, to fill up the gap that existed at the time in the series. The discovery of the Asteroids has proved the correctness of this prediction. The greatest deviation from the law is seen in the case of Neptune; but if we were acquainted with the principles from which the law proceeds, we might also be able to account for the discrepancy. Similar relations, though expressed in different

numbers, are found to subsist in the distances of the satellites of Jupiter and Saturn from their primaries.

BO'DKIN, an instrument used by women of antiquity to fasten up their hair behind. It was the method commonly adopted by the priests of Cybele, as well as by the female characters in Greek tragedy, the B. being highly ornamented. Silver bodkins are still worn in a similar way by the peasant girls of Naples. The term B. is also applied to a sharp-pointed instrument for piercing holes in cloth, and it was at one time a very common name for a dagger.

BO'DLE, an ancient copper coin in Scotland, in value the sixth of a penny sterling. According to Jamieson, the B. is said to have been so called from a mint-master of the name of *Bothwell*.

BODLEY, SIR THOMAS, the restorer of the library originally established at Oxford by Humphrey, Duke of Gloucester, was born at Exeter, March 2, 1544. His family being forced to flee from England during the persecutions of Mary, settled at Geneva, where B. studied languages and divinity under the most distinguished professors of that city. On the accession of Elizabeth, he returned to England, and completed his studies at Oxford, where he took the degree of M. A., and was afterwards elected a proctor. After travelling some time abroad, he was employed by the queen in diplomatic missions to Denmark, France, and Holland, and returned to his favourite city, Oxford, in 1597, where he devoted himself to literature, especially to the extension of the university library, now called the **BODLEYAN** (q. v.), in B.'s honour. In collecting rare and valuable books from many parts of Europe, B. expended a very large sum, and also left an estate for salaries to officers, repair of the library, and purchase of books. He was knighted by King James, and died at Oxford, January 28, 1612. B.'s autobiography, extending to the year 1609, together with a collection of his letters, has been published under the title *Reliquiæ Bodleianæ* (Lond. 1703).

BODLEYAN or BODLEIAN LIBRARY, the public library of Oxford university, restored by Sir Thomas Bodley (q. v.) in 1597, his first act being the presentation of a large collection of valuable books, purchased on the continent at an expense of £10,000. Through his influence and noble example, the library was speedily enriched by numerous other important contributions. Among the earliest subsequent benefactors of the B. L., which was opened in 1602, with a well-assorted collection of about 3000 volumes, were the Earl of Pembroke, who presented it with 250 volumes of valuable Greek MSS.; Sir Thomas Roe; Sir Kenelm Digby; and Archbishop Laud, who made it a magnificent donation of 1300 MSS. in more than twenty different languages. Upwards of 8000 volumes of the library of the famous John Selden (q. v.) went to the Bodleyan Library. General Fairfax presented the library with many MSS., among which was Roger Dodsworth's collection of 160 volumes on English history. During the present century, the most important bequests have been the collections of Richard Gough, on British Topography and Saxon and Northern Literature; of Edmund Malone, the editor of Shakspeare; and of Francis Douce; also a sum of £40,000, by the Rev. Robert Mason, the interest to be expended on books. By purchase, the library acquired some magnificent collections of Oriental, Greek, Latin, and Hebrew books and MSS. The B. L. is particularly rich in biblical codices, rabbinical literature, and materials for

British history. By the Copyright Act, it is entitled to a copy of every book printed in the United Kingdom. The number of volumes it possessed in 1859 is estimated at 260,000, in addition to 22,000 in manuscript. The first catalogue of the printed books was published by the first librarian, Dr James, in 1600; the last in 1843, in three volumes, by Dr Bandinel, the eleventh who has held the office since the institution of the library, and who still (1860) continues to hold it. In the interval, several catalogues of various departments of the library were published; and a supplemental volume was added by Dr Bandinel in 1850. By statutes drawn up for the government of the library by Sir Thomas Bodley, it was decreed that the vice-chancellor, the proctors, and the regius professors of divinity, law, medicine, Hebrew, and Greek, should be visitors and curators; a statute passed in 1856 added 'five more residents to be elected by congregation for ten years, if continuing to reside, and to be re-eligible.' Members of the university who have taken a degree are admitted to the use of the library—a small addition on the matriculation fees, and an annual payment, being charged for the privilege. Literary men, properly recommended, are allowed to make extracts from the works in the library, which is open between Lady-Day and Michaelmas from nine o'clock in the morning till four in the afternoon, and during the other half of the year from ten to three. It is shut during certain holidays, and for visitation purposes, in the aggregate about 34 days in the year, besides Sundays. Since 1856, a reading-room, open throughout the year from ten o'clock in the morning to ten in the evening, has been attached to the library.

BODMANN (ancient *Bodami Castrum*), a village of Baden, at the mouth of the Stockach, on Lake Constance, with ruins of a castle, formerly the residence of the lieutenants (*Botemann* or *Bodmanno*, messenger or *legatus*) of the Carlovingian kings; hence the German name of the lake, Bodman-see, or Boden-see. Pop. 900.

BODMER, JOH. JAK., a German poet and *littérateur*, was born at Greifensee, near Zurich, 19th July 1698. The study of the Greek and Latin writers, together with the English, French, and Italian masters, having convinced him of the poverty and tastelessness of existing German literature, he resolved to attempt a reformation. Accordingly, in 1721, along with a few other young scholars, he commenced a critical periodical, entitled *Discourse der Maler*, in which the living poets were sharply handled. After 1740, when B. published a treatise on *The Wonderful in Poetry*, a literary war broke out between him and Gottsched, which was long waged with great bitterness; yet it was not without fruits, inasmuch as it partly prepared the way for the Augustan epoch of German literature. B. died at Zurich (in the university of which he had held the chair of history for 50 years), 2d January 1783. As an author, he was marked by inexhaustible activity, but his poems, dramas, and translations have no vigour or originality. His best known production is the *Noachide* (Zurich, 1752). He did greater service to literature by republishing the old German poets, the Minnesingers, and a part of the *Nibelungen*, as also by his numerous critical writings.

BODMIN, a town in the middle of Cornwall, 26 miles north-north-west of Plymouth. It is situated partly in a valley and partly on the side of a hill, and consists principally of one street a mile long. Its chief trade is in wool. It arose in a priory founded in the 10th c., and was long an important place, having, besides the priory, a cathedral and 13 churches. Of the latter, only one now exists, built in the 15th century. The priory was

once the property of Thomas Sternhold, one of the translators of the Psalms of David into English metre. A carnival, or low kind of festival, was formerly held near Bodmin; and a leper-hospital once existed in the vicinity. 1500 persons in B. are said to have died of the pestilence in 1351. Pop. (1851) 4327. It returns two members to parliament.

BODO'NI, GIAMBATTISTA, a distinguished type-cutter and printer, born at Saluzzo, in Sardinia, 1740; went to Rome in 1758, where he secured an engagement as compositor in the printing-office of the Propaganda, and where he remained till the death of his patron, Abbate Ruggieri, in 1762, or, according to others, 1766. In 1768, he went to Parma, where he published several specimens of his workmanship; among others—on occasion of the marriage of the Prince of Piedmont with the Princess Clotilde of France—the *Epithalamia Exoticis Linguis Reddita*, which exhibited the alphabets of twenty-five languages. In 1789 the Duke of Parma made him superintendent of his private printing establishment, and in this press he sent forth his edition of the *Iliad* (3 vols. 1808), dedicated to Napoleon. It is a splendid specimen of typography; but the correctness of the text is by no means equal to the beauty of the printing. His editions of Virgil (2 vols. 1793), and several Greek, Latin, Italian, and French classics, as also his Lord's Prayer in 155 languages, are admired for their elegance. He died at Parma, 1813.

BODY, HUMAN, will be treated of under the names of the several organs and functions. For **BODY-SNATCHING**, see **RESURRECTIONIST** and **ANATOMY ACT**.

BODY COLOUR, a term which, in oil-painting, is applied to the opaque colouring produced by certain modes of combining and mixing the pigments. When, in water-colour painting, pigments are laid on thickly, and mixed with white, to render them opaque, instead of in tints and washes, the works are said to be executed in body colour.

BODY OF A CHURCH, more commonly called the *Nave* (q. v.), though this latter term is sometimes employed to include the Aisles (q. v.), is also known as the main or middle aisle.

BOECE, or, more properly, **BOYCE**, **HECTOR**, a distinguished Scottish historian, was born of an old family, about 1465, at Dundee. He completed his education at Montague College, in the university of Paris, and in 1497, was appointed a professor of philosophy. Among other learned men whose friendship he here acquired was Erasmus. About the beginning of the 16th c., he was invited by Bishop Elphinstone to preside over the university newly founded by him at Aberdeen. B. accepted the office after some natural hesitation, the yearly salary being 40 merks, or about £2, 4s. 6d. sterling. The value of money, however, it has to be remembered, was immensely greater then than now, and the learned principal was at the same time made a canon of the cathedral, and chaplain of St Ninian. There is every reason to suppose that he discharged his duties with high success. In 1522, he published his lives, in Latin, of the Bishops of Mortlach and Aberdeen. This work, a great part of which is occupied with the life of his excellent patron, Bishop Elphinstone, was reprinted by the Bannatyne Club in 1825. Five years later, B. published the *History of Scotland*, on which his fame chiefly rests, a work which, though proved to contain a large amount of fiction, is worthy of the commendation it has received even on the score of style. The author was rewarded by the king with a pension of £50 Scots, until he should be promoted to a benefice of 100 merks, which appears to have occurred in 1534. B. died two years later.

BEHMERIA, a genus of plants of the natural order *Urticeæ*, included, until recently, in the genus *Urtica* or Nettle (q. v.). The fibres of a number of species are used for making ropes, twine, nets, sewing-thread, and cloth; and some of them appear likely to acquire much economical and commercial importance. *B. nivea* (formerly, *Urtica nivea*) has been recently ascertained to yield great part of the fibre employed in China in the manufacture of the beautiful fabric known as *China-grass* (q. v.) cloth. It is a perennial herbaceous plant, with broad ovate leaves, which are white and downy beneath, and is destitute of the stinging powers of the nettles. It is carefully cultivated by the Chinese, by whom it is called *Tchou Ma*. It is propagated either by seeds or by parting the roots. It loves shade and moisture. Three crops are obtained in the season, new shoots springing up after it has been cut. Great attention is bestowed upon the preparation of the fibre; the stems are sometimes tied in little sheaves, and instead of being steeped, are placed on the roof of a house, to be moistened by the dew, and dried by the sun, but are carefully preserved from rain, which would blacken them; and in rainy weather, they are placed under cover in a current of air. Another plan is to steep the separated fibres for a night in a pan of water, and sometimes they are steeped in water containing the ashes of mulberry-wood. A patent was obtained in Britain, in 1849, for the preparation of this fibre, by boiling the stems in an alkaline solution, after previously steeping them for 24 hours in water of the temperature of 90° F., then thoroughly washing with pure water, and drying in a current of high-pressure steam.—It seems now to be ascertained that this is the same plant which Dr Roxburgh strongly recommended to attention about the beginning of the 19th c., under the name of *Urtica tenacissima*, and of which the Court of Directors of the East India Company, in 1816, declared the fibre to be 'stronger than Russian hemp of the best description,' and to have been 'brought to a thread, preferable to the best material in Europe for Brussels lace.' It may well be regarded as curious that, after this, it was lost sight of for a considerable time, although the commendation bestowed upon it is found not to have been exaggerated. The plant grows naturally, and is cultivated not only in China, but in Sumatra, Siam, Burmah, Assam, and other parts of the East. The fibre is called *Caloce* in Sumatra, *Ramee* by the Malays, and *Rheea* in Assam.—*B. candicans* and *B. utilis*, from which a fine silky fibre is obtained in Java, are either varieties of this or nearly allied species.—*B. frutescens* is another important species, common in Nepaul, Sikkin, and other parts of the Himalaya, to an elevation of 3000 feet above the sea. It is not cultivated, but often overruns abandoned fields. It grows to a height of 6 or 8 feet, and varies from the thickness of a quill to that of the thumb. The leaves are serrated, dark-green above, silvery-white below, not stinging. The plant is cut down for use when the seed is formed, the bark is then peeled off, dried in the sun for a few days, boiled with wood-ashes for four or five hours, and beaten with a mallet to separate the fibres, which are called *Pooah* or *Poeë*, and also *Kienki* or *Yenki*. When properly prepared, the fibre is quite equal to the best European flax.—The fibres of a number of coarser species are employed in different parts of the East Indies for making ropes. See Royle's *Fibrous Plants of India*.

BEOTIA, one of the ancient political divisions of Greece, was bounded on the N. and N.W. by Locris and Phocis, on the E. by the Euboean Channel, on the S. by Attica and Megaris, and on the W. by the Corinthian Gulf. B. had

a surface estimated at 1120 square miles. The plains enclosed on the south by Mounts Citharon and Parnes, on the west by Mount Helicon, on the north by the slopes of Mount Parnassus and the Opuntian Mountains, fall naturally into three divisions—the basin of the lake Copais, now called Topolias, that of the Asopos, and the coast-district on the Crissean Sea. The principal stream was anciently called the Cephissus. It entered the country from Phocis at Charonea; and in the spring, when it was swollen by innumerable torrents, almost converted the Copaic plain into a lake. There were several natural channels for the outlet of the waters that congregated in this plain, but they were not sufficient to carry off the whole surplus, and the surrounding country was in consequence frequently deluged. In order to guard against this inundation, two tunnels had been cut in the rock for the discharge of the water. One of these tunnels, which carried the water to Upper Larymna—where it emerged in a natural outlet after a subterraneous course of nearly four miles, whence it flowed above ground a mile and a half to the sea—was no less than four miles in length, with about twenty vertical shafts let down into it, some of which were from 100 to 150 feet deep. The other tunnel, which united the Copais Lake with that of Hylica, was much shorter, but still an extensive and striking work. The date of these gigantic engineering undertakings is not precisely known, but they are generally attributed to the Minyæ of Orchomenus. B. was in ancient times very productive of marble, potters' earth, and iron, besides abounding in corn and fruits; and it was also particularly celebrated for flute-reeds. The earliest inhabitants belonged to different races, the two most powerful of which were the Minyæ and Cadmeans or Cadmeones; but were at an early date (about 60 years after the Trojan war, according to Thucydides) in part dislodged by the Beotians, an Æolian people who were driven from Thessaly, and in part incorporated with them. The Beotians excelled as cultivators of the soil, and were gallant soldiers both on foot and horseback; but they were rude, unsocial, and took little part in the gradual refinement of manners and intellectual development of the rest of Greece, so that the name became proverbial for illiterate dulness. This was usually ascribed to their thick damp atmosphere. Yet there have not been wanting amongst them eminent generals, as Epaminondas; and poets and historians, as Hesiod, Pindar, Corinna, Plutarch, &c. The greater cities, of which the number was about fourteen, Thebes, Haliartus, Thespiæ, &c., with their territories, formed the Bœotian League. At the head of this was an archon, and next to him a council, which was composed of four persons, and had its head-quarters in Thebes. The executive authority was intrusted to Bœotarchs, who were elected in popular assemblies of the separate states, and could only hold office for one year. Of this League, a shadow still remained down to the times of the empire; but after the battle of Charonea, in which Philip established the Macedonian throne on the ruins of Grecian liberty, the political importance of the country declined so rapidly, that about 30 B. C. only two cities, Tanagra and Thespiæ, were of any consideration.—Along with Attica, B. now forms one of the 'nomarchies' of the kingdom of Greece.

BOERHAAVE, HERMANN, the most celebrated physician of the 18th c., was born at Voorhout, near Leyden, December 13, 1668. In 1682, he went to Leyden, with the intention of becoming a clergyman, and there studied Greek, Latin, Hebrew, Chaldee, history, ecclesiastical and secular, and mathematics.

In 1689, B. was made doctor of philosophy, and in 1690 began the study of medicine, reading carefully Hippocrates among the ancients, and Sydenham among the moderns. Though mainly self-educated in medicine—as in chemistry and botany—he gained his doctor's degree at Harderwyck, 1693, and returned to Leyden, where, in 1701, having abandoned theology, he was appointed lecturer on the theory of medicine, and in his inaugural lecture recommended to the students the ancient method of Hippocrates in medicine; but in 1703 his views had become greatly enlarged. He saw the necessity of *a-priori* speculations, as well as of the Hippocratic method of simple observation, and elaborated various mechanical and chemical hypotheses to explain the diseases of the body, especially in the case of the fluids. In 1709, he was elected professor of medicine and botany in the place of Hottot. About this time, he published the two works on which his great fame chiefly rests: *Institutiones Medicæ in Usus Annuæ Exercitationis Domesticæ* (Leyd. 1708), and *Aphorismi de Cognoscendis et Curandis Morbis, in Usum Doctrinæ Medicinæ* (Leyd. 1709), both of which went through numerous editions, and were translated into various European languages, and also into Arabic. In the first work—a model of comprehensive and methodical learning—he gives a complete outline of his system, including a history of the art of medicine, an account of the preliminary knowledge necessary to a physician, and a description of the parts and functions of the body, the signs of health and disease, &c.; in the second, he gives a classification of diseases, with their causes, modes of treatment, &c. B. also rendered important services to botany. One of his best lectures is that delivered on his resignation of the office of rector of the university, *De Comparando Certo in Physiis*. To combine practice with theory, he caused a hospital to be opened, where he gave clinical instructions to his pupils. Though so industrious in his own profession, he undertook, in 1718, after Lemort's death, the professorship of chemistry, and published in 1724 his *Elementa Chemicæ*, a work which did much to render this science clear and intelligible; and although now entirely superseded by more advanced researches, one that will always occupy a high place in the history of chemistry. His fame had meanwhile rapidly increased. Patients from all parts of Europe came to consult him. Peter the Great of Russia visited him; and it is even said that a Chinese mandarin sent him a letter, addressed 'HERR BOERHAAVE, celebrated physician, Europe.' He was a member of most of the learned academies of the day. He died September 23, 1738, having realised from his profession a fortune of two millions of florins.—Burton, *Account of the Life and Writings of B.* (2 vols., Lond. 1743); Johnson, *Life of B.* (Lond. 1834).

BOERHAAVIA. See NYCTAGINACEÆ.

BOERS (*Ger.* agriculturists, farmers), the name applied to the Dutch colonists of the Cape of Good Hope who are engaged in agriculture and the care of cattle. The B., generally, according to Dr Livingstone, 'are a sober, industrious, and most hospitable body of peasantry.' Very different, however, are certain of their numbers who have fled from English law, on various pretexts, and formed themselves into a kind of republic in the Cashan Mountains. Coming 'with the prestige of white men and deliverers' from the cruelty of Kaffir chiefs, they were received by the Betjuans gladly, who, however, soon found out that their new friends were much less desirable as neighbours than their old enemies. The B. force even those tribes of the Betjuans who are

most friendly towards them to perform all kinds of field-labour for nothing; and not only this, but they also compel them to find their own implements of labour and their own food. They steal domestic servants from the more hostile tribes in the most cowardly and cold-blooded way imaginable. The plan of operation is thus described by Dr Livingstone: 'One or two friendly tribes are forced to accompany a party of mounted Boers, and these expeditions can be got up only in the winter, when horses may be used without danger of being lost by disease. When they reach the tribe to be attacked, the friendly natives are ranged in front, to form, as they say, "a shield;" the Boers then coolly fire over their heads, till the devoted people flee, and leave cattle, wives, and children to the captors. This was done in nine cases during my residence in the interior, and on no occasion was a drop of Boer's blood shed.' And yet these B. proudly boast themselves 'Christian!' They have an immense contempt for the ignorance of the natives, and told Dr Livingstone that he might as well teach baboons as Africans. They, however, declined a test which the missionary proposed—viz., to be examined whether they or his native attendants could read best. In his opinion, they are quite as degraded as the blacks whom they despise.

BOËTHIUS, ANICIUS MANLIUS SEVERINUS (to which a few MSS. add *Torquatus*), a Roman statesman and philosopher, was born between 470 and 475 A. D. The family to which he belonged had been distinguished both for its wealth and dignity for two centuries. His own father held the office of consul, but dying while B. was still a boy, the latter was brought up under the care of Festus, Symmachus, and other honourable Romans. He studied with sincere enthusiasm philosophy, mathematics, and poetry, translated and elucidated with laborious care the writings of Aristotle, and of the old mathematicians Euclid, Archimedes, Ptolemæus, and others; but the story of his eighteen years' stay at Athens is entirely unhistorical. B. soon attracted notice; he became a patrician before the usual age, a consul in 510, and also *princeps senatus*. Having, moreover, gained the esteem and confidence of Theodoric, king of the Goths, who had fixed the seat of his government at Rome in the year 500, he was appointed by that monarch *magister officiorum* in his court. His influence was invariably exercised for the good of Italy, and his countrymen owed it to him that the Gothic rule was so little oppressive. His good-fortune culminated in the prosperity of his two sons, who were made consuls in 522. But his bold uprightness of conduct, springing from what seem to have been the essential characteristics of the man—viz., a strong faith in the truth of his philosophic ethics, and a courage to regulate his official conduct by them—at last brought down upon his head the unscrupulous vengeance of those whom he had checked in their oppressions, and provoked by his virtues. He was accused of treasonable designs against Theodoric; and the king, having become despondent and mistrustful in his old age, was induced to listen to the charges. B. was stripped of his dignities, his property was confiscated, and he himself, after having been imprisoned for some time at Pavia, was executed in 524 or 526; according to one account, with circumstances of horrible cruelty. During his imprisonment, B. wrote his famous *De Consolatione Philosophiæ*, divided into 5 books, and composed in the form of dialogue, in which B. himself holds a conversation with Philosophy, who shews him the mutability of all earthly fortune, and the insecurity of everything save virtue. The work is composed in a style which happily imitates the best

models of the Augustan age, and the frequent fragments of poetry which are interspersed throughout the dialogue are distinguished by their truthfulness of feeling and metrical accuracy. The *Consolatio* is piously *theistic* in its language, but affords no indication that B. was a Christian; and if the doctrinal treatises ascribed to him are, as the acutest criticism maintains, not genuine, we must class him in religion rather with Marcus Aurelius than with his alleged friend, St Benedict. He was the last Roman writer of any mark who understood the Greek language and literature. During the middle ages, he was regarded with profound reverence, as the *Augustine* of philosophy, but on the introduction of the Aristotelian metaphysics in the 13th c., his reputation gradually sank. The first edition of B.'s entire works appeared at Venice, 1491—1492; a more correct one at Basel, 1570. The oldest edition of the *Consolatio* is that published at Nürnberg, 1473, but many manuscript translations into various languages had appeared long before the invention of printing. Among these may be mentioned that by King Alfred into Anglo-Saxon.

BOG, land covered with peat, the spongy texture of which containing water, converts it into a kind of quagmire. The term PEAT-BOG is sometimes employed as more perfectly distinctive of the true bog from every other kind of swamp or morass; the term PEAT-MOSS is also sometimes employed, particularly in Scotland, and even simply Moss. The word Bog is of Irish origin, being from a Gael. root, signifying a bobbing, quaking motion.

Bogs of great extent exist in some of the northern parts of the world. A very considerable part of the surface of Ireland is occupied with them. The Bog of Allen (see ALLEN, BOG OF) is the most extensive in the British Islands, although its continuity is not altogether unbroken, strips of arable land intersecting it here and there. The Solway Moss (q. v.), on the western borders of England and Scotland, is about seven miles in circumference. Chatmoss (q. v.), in Lancashire, famous for the engineering difficulties which it presented to the formation of the first great English railway, is twelve square miles in extent. The swamps of the east of England are in general not peat-bogs, but consist chiefly of soft mud or silt.

The general surface of a bog is always nearly level, but it is usually varied with rushy tussocks rising above the rest, and having a rather firmer soil. By the continued growth of peat, the surface of a bog is gradually elevated; that of Chatmoss, for example, rises above the level of the surrounding country, having a gradual slope of thirty or forty feet from the centre to the solid land on all sides. In rainy weather, it sensibly swells, the spongy mass imbibing water, whilst the mosses and other growing plants on the surface prevent evaporation. Occasionally, the quantity of water becoming excessive, a bog *bursts*, and pours a terrible deluge down the course of a stream, causing great devastation, not only by the force of its torrent, but by the enormous quantities of peat which it deposits upon meadows and cultivated fields, as has recently happened in some memorable instances in Ireland. The depth of a bog is sometimes more than forty feet. The spongy mass of which it is formed shakes on the least pressure. Sometimes it is impossible to traverse it; in other cases, it is possible only for those who are well accustomed to it, a false step being a plunge into a quagmire, in which a man sinks as in a quicksand. Safety is sometimes insured by 'patteus'—boards fastened upon the soles of the feet—a method which Mr Roscoe of Liverpool, in his extensive operations for reclaiming land from Chatmoss, employed also to enable horses to work

upon its surface. It was not the least remarkable triumph of the genius of Stephenson, to extend the same principle to the support of the railway. Tradition reports that at the battle of Solway, in 1542, a fugitive troop of horse plunged into the moss, which instantly closed upon them; and in the end of the 18th c., this tradition was confirmed by the discovery, made in peat-digging, of a man and horse in complete armour.

One of the remarkable phenomena of peat-bogs is the frequent presence of roots and fallen trunks of trees, in a good state of preservation, many feet below the surface. From the black hog-oak of Ireland, various small fancy articles are manufactured. The circumstance of trees being found imbedded in bogs, leads to the conclusion that in many instances these morasses originated in the decay or partial destruction of ancient forests. This subject, however, along with all that relates to the origin and nature of bogs, will be treated in the article PEAT. It may be proper here to mention that there is a popular division of bogs into two classes—*Red Bogs* and *Black Bogs*; the decomposition of the vegetable matter in the former being less perfect, and the substance, consequently, more fibrous and light than in the latter. There is indeed no precise line of distinction, and all intermediate conditions occur. The most extensive bogs are red bogs, and they are said to cover 1,500,000 acres in Ireland. Black bogs, although comparatively of small extent, are more numerous, particularly in elevated districts, for which reason they are sometimes called *mountain bogs*. The depth of red bogs is usually much greater than that of black bogs.

The conversion of bogs into good pasture or arable land, is a subject of national importance. There can be no doubt that much of the land now occupied by bog is capable of being rendered very productive, whilst the effects of extensive bogs upon the climate are always injurious. The reclaiming of shallow mountain bogs is comparatively easy, and in some cases it is effected by a very simple and inexpensive drainage, and by throwing them at once under cultivation in a manner analogous to that known in Ireland as the *lazy-bed* method of planting potatoes—the soil upon which the bog rests being partially digged up and thrown over its surface. Great difficulties, however, attend the reclaiming of red bogs. It has unfortunately happened, particularly in Ireland, that the tenures of land, and the want of capital on the part of the owners of estates, have formed the most insuperable of all obstacles to improvements of this kind, which, however, have been carried on to no inconsiderable extent since the middle of the 18th c., and have in general proved highly remunerative. A chief difficulty, in some cases, is caused by the low situation of the bog, and the want of *fall* for drainage. Another great difficulty is presented by the spongy substance of red bogs being extremely retentive of water, so that a deep ditch only drains a very narrow strip on each side of it. A difficulty has been also found in disposing of the peat, where a good soil being known to exist below, it has been attempted to reclaim land by removing the peat instead of draining it and converting its own surface into soil. To some extent, in such cases, the peat is advantageously disposed of for fuel, or to be used as a species of manure for other soils; but the demand for these purposes is often insufficient for any other than a very slow process of improvement in an extensive bog. The peat is therefore, sometimes, by various means, floated off, as in the long-continued operations at Blair-Drummond, on the banks of the Forth, the results of which have for many years formed a

peculiar feature on the shores and in the bays of the upper part of the Firth of Forth. But when a similar method was more recently introduced in an extensive moss in the low lands of Renfrewshire, the Clyde trustees interposed to prevent it, in the interests of the navigation of the river. A portion of the peat, taken from the upper surface, is not unfrequently burned in heaps upon the spot, the ashes becoming a manure, and assisting in the formation of a soil.

Of course, the first essential in the reclaiming of bogs is drainage. The method of effecting this must be varied according to circumstances; but very frequently, after a general outlet with sufficient fall has been secured, wide open drains are cut, by which the bog is divided into strips, which again are traversed and subdivided by smaller drains. When these drains begin to serve their purpose, the surface of the bog sinks, and their depth is reduced; they are then often deepened, and at last a permanent system of covered drains emptying themselves into open ditches is thus formed, and fits the land for all the purposes of agriculture. It is, however, often ploughed before this state of things is attained, the plough-horses being shod with the *pattens* already mentioned, and socks and coulters of unusual sharpness being employed for the cutting of the bog. Various implements have also been devised for cutting the moss, to facilitate cultivation. Lime, calcareous sand, clay, and other manures are applied, according to circumstances, to promote the conversion of the peat into useful soil. Sometimes the first crop taken from the ploughed bog is a crop of oats; sometimes it is found preferable to begin with rape, turnip, or the like. In some places in the North of Ireland, fiorin grass (see BENT GRASS) has been sown on bogs in process of being reclaimed, and enormous crops have been obtained.—See WASTE LANDS.

BO'GAN, or **NEW-YEAR RIVER**, the *Allan Water* of Oxley, an interior stream of East Australia, joins the Darling, after a generally north-west course of more than 300 miles, about lat. 30° S., and long. 146° E. Its source is in the Harvey Range, about lat. 33° S., and long. 148° 30' E.

BOG BUTTER, a very peculiar mineral substance, which is found in some of the bogs of Ireland. It is evidently of vegetable origin, and has been formed by the decomposition of the peat amidst which it is found. In composition and qualities it exhibits a general agreement with bitumen, asphalt, amber, and the other mineral resins; all of which are not improbably supposed to resemble it also in their origin, although perhaps it is the most recent of them all. It contains about 74 per cent. of carbon; its remaining constituents being oxygen and hydrogen in nearly equal proportions. In colour and consistency, it much resembles butter, and at 124° F. it becomes liquid. It is not soluble in water, but is readily dissolved by alcohol.

BOGDANOVITCH, **HIPPOLYTUS THEODOROVITCH**, a distinguished Russian poet of the 18th c., was born at Perevolotchna, Little Russia, in December 1743. His fame rests entirely upon his poem *Dushenka*, published in 1775. The story of Psyche forms the groundwork of the poem, which is characterised by a refined and graceful style, and vivacious playfulness of language. Its publication made him at once famous, as well as obtained for him the high favour of the court; but there can be no doubt that the popularity of the work was as much owing to the adventitious circumstances in which it was produced—nothing of the kind having been previously attempted in Russia—as to its intrinsic

merits. B., though he wrote much afterwards, never equalled his first performance. He died in January 1803.

BO'GEN, a town of Bavaria, in the circle of Lower Bavaria, situated on the left bank of the Danube, about six miles east of Straubing. It has extensive breweries, but is chiefly celebrated for its chapel, still a place of pilgrimage, built on a neighbouring height. Here, according to tradition, a hollow stone image of the Virgin floated up by the river, remained stationary; and its miraculous arrival had the effect of converting a notorious robber-chief, the ruins of whose castle now enclose the church. Innumerable pilgrims flocked to the image, including, at various times, three German emperors, and the monks grew very wealthy on their offerings. Pop. 1200.

BOGERMANN, **JOHANN**, who occupies a place in history as president of the far-famed synod of Dort, was born in 1576, at the village of Oplewert, in Friesland. He took a violent part in the religious controversies which inflamed, with unwonted fire, the Dutch mind at the beginning of the 17th century. His hatred of Arminianism extended itself (as theological hatred generally does) to the persons who upheld it, and his zeal was on various occasions gratified by securing the punishment of those who had the misfortune to differ in opinion from him. He translated and recommended Beza's book on the *Capital Punishment of Heretics*; and about the year 1614, ventured to assail the great Grotius in a polemical treatise, which, along with most of the angry literature of the period, has properly perished. In 1618, B. was elected president of the synod of Dort; but his conduct there does not seem to have given satisfaction to the Frieslanders who had delegated him, for he was accused on his return of having exceeded his instructions. For one thing, however, B. deserves great credit, his translation of the Bible into the vernacular. Four other persons were associated with him in the task, but the translation of the Old Testament is chiefly B.'s work, and is characterised by taste, fidelity, and purity of language. It is still used in the Dutch churches. B. died in 1633, at Franeker, in the university of which he was primarius professor of divinity.

BOGHA'Z KIE'UI, **KE'WEB**, or **KOL**, a village of Asia Minor, pashalic of Sivas, 88 miles S. W. of Amasia. In its vicinity are the ruins of a magnificent temple, supposed to be that of Jupiter which Strabo mentions (lib. xii.). A perfect ground-plan of the building still remains; the length outside is 219 feet, the breadth, 140 feet, while the cella measures 87 feet by 65. There are several other ruins which seem to identify B. K. as the ancient *Tavium*.

BOG IRON ORE, a mineral of very variable composition, but regarded as consisting essentially of peroxide of iron and water; the peroxide of iron often amounts to about 60 per cent., the water to about 20. Phosphoric acid is usually present in quantities varying from 2 to 11 per cent. Silicic acid, alumina, oxide of manganese, and other substances, which seem accidentally present, make up the rest. B. I. O. occurs chiefly in alluvial soils, in bogs, meadows, lakes, &c. It is of a brown, yellowish-brown, or blackish-brown colour. Some of its varieties are earthy and friable, formed of dull dusty particles; some are in masses of an earthy fracture, often vesicular; and some more compact, with conchoidal fracture. It is abundant in some of the northern and western islands of Scotland, and in the northern countries of Europe generally; also in North America. When smelted, it yields good iron. See IRON, ORES OF. From what source the iron in B. I. O. is derived, has often been a subject of discussion; but Ehrenberg appears to have determined

that it proceeds from the shields of animalcules, and he regards the mineral itself as composed of incalculable multitudes of these shields. He found in the marshes about Berlin a substance of a deep-ochre yellow passing into red, which covered the bottom of the ditches, and which, when it had become dry after the evaporation of the water, appeared exactly like oxide of iron; but which under the microscope was found to consist of slender articulated threads, formed of the partly silicious and partly ferruginous shields of *Gaillonella ferruginea*.

BOG MOSS. See SPHAGNUM.

BO'GNOR BEDS. See LONDON CLAY.

BOGODOUKHO'V, or **BOHODUKHO'V**, a fortified town of Russia, in the government of Kharkov, 29 miles north-west of the city of that name. It is situated on the Merle—the chief industry of its population, which amounts to about 10,000, consisting in leather-dressing and boot-making. B. has also a considerable trade in cattle and hides.

BOGOMILI, a religious sect of the 12th c., whose chief seat was in Thrace. They resembled the Paulicians and Kathari. Their name, which is derived from the Bulgarian *Bog*, 'Lord,' and *milus*, 'have mercy,' refers to the frequency of their prayers. The basis of their creed was as follows: Out of the eternal Divine Essence or Being sprang two principles—Satanal and Logos; the former, at first good, afterwards rebelled, and created in opposition to the original spiritual universe a world of matter and human beings. These human beings, however, received from the Supreme Father a life-spirit; but this was kept in slavery by Satanal until the Logos or Christ came down from heaven, and assuming a phantom body, broke the power of the evil spirit, who was henceforth called only Satan. The B., like all similar sects, practised a severe asceticism, despised images, and rejected the sacraments. Instead of baptism, they placed their hands, and an apocryphal gospel of St John, on the head of the neophyte, singing at the same time the Lord's Prayer, which they repeated seven times during the day, and five times during the night. They looked on the Lord's Supper as a sacrifice offered to the demons. They accepted the whole of the New Testament, but of the Old Testament only the Psalms and Prophets, which they interpreted allegorically. In 1118, that vehement hater of heretics, Alexius Comnenus, burned their leader Basilus, and imprisoned the rest. Nevertheless, the B. continued to exist in the neighbourhood of Philippopolis down to the 13th century.

BOGOTA', more fully **SANTA FE DE BOGOTA**, in South America, the capital at present of New Granada, but lately of Colombia as a whole. It is situated within the limits of Cundinamarca, in lat. 4° 6' N., and long. 78° 30' W., on a table-land, which, at an elevation of 8694 feet above the sea, separates the basin of the Magdalena from that of the Orinoco. Independently of its political importance, B. occupies a commanding position in relation to commerce. It lies on the most convenient route between Quito and the Caribbean Sea; while, by navigable affluents of the Orinoco and the Magdalena, distant respectively 37 and 55 miles, it enjoys a two-fold access to tide-water. Its immediate vicinity, too, is favourable to the growth of a great city and the maintenance of a large population. The table-land measures about 60 miles from north to south, and about 30 from east to west, being bounded on all sides by mountains which, though lofty enough to give shelter, are yet below the line of perpetual snow. This extensive plain—a temperate zone on the verge of the equator with a singularly genial and salubrious climate—is exceedingly fertile, yielding abundant

crops of wheat and barley, as also generally of the leguminous plants cultivated in Europe; while, favoured as it is with two rainy seasons in a year, it is as rich in pasture as in grain, affording ample sustenance to numerous flocks of sheep and herds of cattle. B. was founded in 1538, consisting then of 12 houses in honour of the 12 apostles. In 1800, it contained 21,464 inhabitants; and in 1821, 30,000; and now it is supposed to have at least 40,000. Prospectively, also, the surrounding mountains promise, one day, to give to industry many valuable minerals, such as iron, coal, and salt. The last two, in fact, have already been obtained to some extent. Mines of emeralds, gold, silver, and copper are also said to exist within the same district. B. is regularly and handsomely built. It has 4 public squares and 5 elegant bridges over 2 small rivulets—the San Francisco and the San Augustin. Like every place in Spanish America, it teems with churches and convents—two of the latter overhanging the city on twin hill-tops at a height of 2500 feet above the general level. B. likewise possesses, in addition to official buildings, a mint, a theatre, a university, and spacious barracks. A short way from the city, the rivulets above mentioned join a stream of the same name as the town itself.—The river Bogota, otherwise called the Funcha, is in itself an object of physical interest. It is the single outlet of the waters of the table-land, which, both from geological features and from aboriginal traditions, appears to have once been a land-locked basin, somewhat like the still loftier and larger plateau of Titicaca. Be this as it may, the river B. has found, if it has not forced, a passage for itself towards the Magdalena. At the cataract of Tequendama the waters plunge over a precipice 900 feet high; and the clouds of spray clothe the adjacent grounds in the most luxuriant vegetation. About the centre of this cataract, known as the Fall of Tequendama, stands the natural bridge of Icononzo, formed as if by the fortuitous jamming of rocks from the opposite sides of the cleft. Between the crest and the foot of this fearful torrent, there exists a difference of climate, which is obviously disproportioned to the mere difference of elevation; and the excess may perhaps be ascribed, in conjunction with the ceaseless moisture, to the wall-like precipice behind, which, besides intercepting the winds, increases by reflection the heat of the sun.

BOGOUSLAV, or **BOGUSLAW**, a town of Russia, in the government of Kiev, about 70 miles south-south-east of the city of that name. It is situated on the Rossa, and has a population of 6000, chiefly Jews.

BOG SPAVIN. This singular name has been applied to a lesion of the hock-joint of the horse, consisting in distension of the capsule enclosing the joint. It usually arises suddenly from a sprain in action. It most commonly affects young horses with defective hocks, and is associated with other indications of weakness of the injured joint.

Symptoms.—As the immediate result of a violent sprain, the hock becomes swollen, hot, and tender, and there is considerable lameness. The acute symptoms subside readily, but a circumscribed swelling remains towards the front, inner, and lower part of the joint. The swelling is soft, partly disappears on pressure, if the joint is moved; but on the horse standing firmly on its limbs, the projection is distinctly visible. At every recurring strain, lameness supervenes, but commonly passes off within a short time. If the B. S. has accidentally occurred in a young horse with good hocks, it may never be attended with inconvenience, and the acute symptoms mentioned do not relapse.

Treatment.—The treatment of B. S. consists in the application of stimulating embrocations, or mild blisters, in the early stage; in severe cases, the golden ointment of iodine is the best application; but we can only obtain a reduction in the inflammatory symptoms, and disappearance of the lameness. The capsular ligament which is injured is never again completely restored, and the horse is more or less blemished for life. See SPAVIN.

BOG-TROTTER, an appellation sometimes contemptuously given to the lower class of the Irish peasantry, has its origin in the ability acquired by many of them of traversing the extensive hogs of their native country, passing from tussock to tussock, where a stranger would find no secure footing, and in the frequent use which they have made of this ability to escape from soldiers, officers of police, or other pursuers.

BOGUE, REV. DAVID, the founder of the London Missionary Society, was a native of Berwickshire, being born at Hallydown, February 1750. After studying at the Edinburgh University, and obtaining his licence as a preacher in connection with the Church of Scotland, he, in 1771, went to London, where he was for some time engaged in tuition. He afterwards accepted the charge of an Independent church at Gosport, where he established a seminary for the education of students who purposed to become Independent ministers, an institution which had a great influence on the connection, as well when it had this object in view as afterwards, when it became a school for the training of missionaries. B. now conceived the idea of a grand missionary scheme, which was ultimately realised, in the London Missionary Society. He also took an active part in the establishment of the British and Foreign Bible Society and the Religious Tract Society. From this time until his death, which took place in October 1825, he devoted himself zealously to the cause of missions. On his death, an extraordinary meeting of the London Missionary Society was convened, and resolutions passed expressive of its sense of bereavement, and of the benefits which the deceased had conferred on the Society. B. was the author of *An Essay on the Divine Authority of the New Testament*, which has had a circulation only second to that of Bunyan's *Pilgrim's Progress*, having been translated into French, Italian, German, and Spanish; also *Discourses on the Millennium*; and in connection with Dr James Bennet, a *History of Dissenters*, from the Revolution of 1688 to 1808.

BOHEMIA (Ger. *Böhmen*), formerly one of the kingdoms of Europe, now forming a part of the Austrian empire, is situated in lat. 48° 33'—51° 3' N., and long. 12°—16° 46' E. It is bounded N. by Saxony and Prussian Silesia, E. by Prussia and Moravia, S. by Lower Austria, and W. by Bavaria. It has an area of 19,822 square miles, and a population, in 1857, of 4,865,830. It is divided into thirteen circles—viz., Prague, Leitmeritz, Jung-Bunzlau, Jiëin, Königgrätz, Chrudim, Caslau, Tabor, Budweis, Pisek, Pilsen, Eger, and Saaz. It contains 318 towns, 237 small market-towns, and 12,105 villages. B. is surrounded on all sides by lofty mountain-ranges, the principal of which are the Riesengebirge (part of the Sudetic chain) on the north-east, dividing B. from Prussia and Silesia, and attaining, in the peak of the Schneekoppe, a height of 5275 feet; on the north-west, the Erzgebirge, with a height, in some places of more than 4000 feet; on the south-west, the Böhmerwald, reaching in its highest point an elevation of 4613 feet. Offsets from these traverse the interior of the country, which has an undulating surface, sloping generally to the centre. B. has

several fine valleys, the chief of which are those of the Moldau and the Elbe. The country belongs to the upper basin of the Elbe, which rises in the Riesengebirge range; and it is well watered by the affluents of that river, the principal of which are the Moldau—which has its source in the Böhmerwald, and which is navigable from Budweis to Melnik, where it joins the Elbe, a distance of 148 miles—the Eger, Iser, Aupa, Metau, Biela, and Erlitz. B. has no lakes.

The climate of B. is cold in the mountainous regions, the higher peaks being covered with snow during a great portion of the year, but mild in the valleys, and, on the whole, healthful.

The mineral wealth of B. is varied and extensive, consisting of silver, tin, copper, lead, iron, cobalt, alum, sulphur, graphite, calamine, cinnabar, porcelain clay, with several precious and ornamental stones, such as Bohemian garnet (*Pyrope*), rubies, sapphires, &c. Of coal, B. produces more than all the rest of the Austrian empire together; in 1855, it yielded 35,000 tons of asphaltum. Mineral springs are abundant, and those of Carlsbad, Marienbad, Eger-Franzensbad, Teplitz, Elisenbad, &c., are celebrated places of resort.

The soil of B. is generally fertile. More than one-half of the area consists of arable land; nearly one-eighth is laid out in meadows and gardens; pastures form about a twelfth; vineyards, a very small portion; and forests cover nearly a third. Of wheat, B., in 1851, raised 9,620,000 imperial bushels—about a seventh of the whole produce of the Austrian empire; of rye, 23,368,000 bushels; and the produce of barley and oats respectively was 13,273,000 bushels, and 22,000,000 bushels—being, in the case of rye, nearly one-fourth, and of barley and oats, more than one-sixth of all the produce in these kinds of grain of the Austrian dominions. Various kinds of game are found, and the breed of pheasants is celebrated. Horned cattle, sheep, goats, and swine are reared extensively in some districts; and in the south, geese form an important item in the resources of the country.

In manufactures, B. holds a very high place among continental countries. The linen manufacture, which is more extensive than that of all the other Austrian provinces together, consists of damask, cambric, lawn, and other fine varieties, in addition to the ordinary qualities of cloth. This branch employs about 400,000 flax-spinners, more than 50,000 weavers, and some thousands of bleachers. Between 9000 and 10,000 are employed in cotton manufacture, the quantity of raw cotton used in 1851 being about 150,000 cwt., and the quantity of yarn and thread produced, about 100,000 cwt. The chief seat of the woollen manufacture is Reichenberg and its neighbourhood. Another important branch of industry is the paper manufacture, carried on in 108 mills. The glass-works of B. are celebrated, and very numerous and extensive, affording employment to not less than 30,000 persons. Beet-root sugar is manufactured extensively, and there are hundreds of breweries and brandy distilleries throughout the country, but they are mostly on a small scale. The manufacture of iron is considerable. In 1855, the value of the exports was £3,385,783, and the value of the imports, £4,636,786. The position of B. secures it a large transit trade. Steam-packets ply on the Elbe and Moldau, and the latter river is connected with the Danube by a horse-railway from Budweis to Linz. B. has good roads, but the only railways in the kingdom of any consequence are those uniting the capital, Prague, with Vienna, Dresden, and the kingdom of Bavaria.

Population, Religion, and Education.—The Czechs, a Slavonic race, form the bulk of the people. They

number 2,930,300, and dwell chiefly in the centre and east of the country. The German population, amounting to 1,835,830, reside mainly on the outskirts, especially in the north-east. The few remaining are Jews. The vast majority of the population (4,599,400) belong to the Roman Catholic Church, but other religions are tolerated; the number of Protestants only amounts to 166,000, and the number of Jews is 99,700. The Roman Catholics are under the supervision of the Archbishop of Prague, and the three bishops of Leitmeritz, Königgrätz, and Budweis. The monasteries and convents number between 70 and 80. Education is much more widely diffused than in any of the other provinces of Austria. The total number of educational establishments in 1851, including 17 universities and superior institutions devoted to literature, science, and art, was 7224, attended by 768,029 pupils, and taught by a staff of 8107 teachers and professors, at an annual expense of £57,797.

History.—The *Boii* (q. v.), from whom B. derives its name, settled in the country in the 2d c. B. C., but were expelled by the Marcomanni about the beginning of the Christian era. The victors themselves soon gave place to others, and as early as the 5th c. A. D., we find B. peopled by the Czechs, a Slavic race. In the latter part of the 9th c., Swatopluk, the king of Moravia, subjugated Bohemia and introduced Christianity. After his death, the dukes of Prague, who in 1061 had the title of king conferred on them, by the Emperor Henry IV., ruled the country as a state in the German Empire until 1306, when the last of the dynasty was assassinated.

From 1310 to 1437, B. was ruled by kings of the House of Luxemburg. In the time of Wenzel IV. (Wenceslas), a reformation of religion took place under John Huss (q. v.) and Jerome of Prague (q. v.). After the death of Wenzel IV., the imprudent measures adopted by the Emperor Sigismund excited in B. a war of sixteen years' duration, which ended in making B. an elective kingdom. In 1458, the shrewd and able Protestant noble, George von Podiebrad, ascended the throne. His successor, Ladislaus (1471—1516), was elected (1490) to the throne of Hungary, and removed the royal residence to Ofen, where also his son and successor, Lewis (1516—1526), resided. After his death in battle against the Turks at Mohacz (1526), B. and Hungary passed into the hands of Ferdinand I. of Austria, who had married Lewis's sister. From that time, the history of B. merges in the history of Austria (q. v.).

Bohemian Literature.—The Czechs of B. possess a literature older than that of any other people of the Slavonic stem. Its origin may be dated with certainty as early as the 10th century. Of the oldest period—or before the time of John Huss the reformer—21 poetical, and more than 50 prose works are extant. Among the former, the remains of a collection of ballads, &c., made in the 13th c., are remarkable for their poetical merit. John Huss in B., like Luther in Germany, began a new era in literature (1409—1526); but the impulse of his example was far more important than his own writings. The literary remains of the Hussite sects in the 15th c.—dogmatic, polemic, and ascetic works—are still numerous in the old libraries and archives of B., though very many of them perished in the flames the Jesuits kindled during the Thirty Years' War. Even so late as 1750, the Jesuit, Antony Konias, boasted that he had burned 60,000 Bohemian books. Of historical works of this period, some remains have been edited by Palacky in his *Scriptores Rerum Bohemicarum*, 1829.

The period 1526—1620 is regarded by the Bohemians as their golden age of literature. In this

time, especially under Rudolf II. (1576—1611), the arts and sciences were generally cultivated. Prague had two universities and sixteen schools, and the Bohemian language had reached its highest point of cultivation. It cannot, however, be said, that the literary works of this period display any great originality of genius. Among the most noticeable is a Bohemian translation of the Bible, which was finished in 15 years by 8 scholars, assembled by John of Zerotin at his castle of Kralic, in Moravia, and was published 1579—1593. It is a model of pure and elegant Bohemian.

In December 1774, an imperial decree was issued, ordaining that the German language should be employed by all teachers, lecturers, &c., in the upper schools. This harsh measure excited considerable opposition; and several writers came forward to vindicate the claims of the persecuted dialect, and to develop its powers; but their efforts were attended with little success.

A new and better era began in 1818, with the discovery of valuable remains of old literature, and the publication of edicts favourable to the use of the Bohemian language in schools. Since that time, the progress of the language, as a vehicle of literature and science, has been rapid, and a love of the old dialect has been extended through all classes of society. In Bohemian poetry and belles-lettres, the names of Czelakowsky, Kollar, Holly, Langer, and Schneider, are distinguished. Among scientific writers, mention may be made of Jungmann, Schafarik, Wenzel Hanka, and Presl. In history and archaeology, the names of Palacky, Tomek, Schafarik, and Wocel are worthy of notice. During the year 1851, 22 Bohemian journals (of which seven were entirely political) were established—11 in B., 5 in Moravia, 4 in Hungary, and 2 in Vienna. Since 1831, a committee for the cultivation of Bohemian literature has been connected with the Bohemian Museum in Prague. Several important works, among them Schafarik's *Slavonic Antiquities*, and Jungmann's *Large Lexicon*, and his *Literary History*, have been published by aid of the committee.

The *Bohemian language* is one of the best dialects of the West-Slavonic; it is spoken not only in B., but also in Moravia, and among the Slovaks in Hungary. Among its sister-dialects, it is distinguished by copiousness of root-words, great flexibility in combinations, precision, and accurate grammatical structure; but, like all the Slavonic and most modern dialects, it has no specific form for the passive voice of the verb. The orthography introduced by John Huss in the 15th c. is precise and consistent with itself. Every letter of the Roman alphabet has its one distinct sound. Bohemian prosody is distinguished from that of most European languages by the use of quantity instead of accent, so that it can copy faithfully all the ancient Greek and Roman metres. No other modern language can translate the ancient classics so readily, and yet so completely and forcibly, as the Bohemian. Its grammatical forms are complicated and difficult.

BOHEMIAN BRETHREN is the name of a religious society which was first instituted in Prague about the middle of the 15th century. It was originally composed of remnants of the Hussites. Dissatisfied with the conduct of the Calixtines (q. v.), they betook themselves, in 1453, to the borders of Silesia and Moravia, where they settled. Here they dwelt in separate communities, and were distinguished by the name of Brothers of the Rule of Christ. Their adversaries often confounded them with the Waldensians and Picards, while, on account of their being compelled during persecution to hide in caves and solitary places, they were also called Cave-dwellers

(*Grubenheimer*). In spite of oppression, such was the constancy of their faith and purity of their morals, that they became profoundly respected, and their numbers greatly increased. The chief peculiarity of their creed was the denial of the ordinary Catholic doctrine of transubstantiation; but, in truth, they rejected tradition generally, and professed to found their tenets only on the Bible. Their ecclesiastical constitution and church-discipline—of which the Lutheran reformers spoke highly—was a close imitation of that of the primitive Christian communities. They even went the length of practically denying anything to be secular; and, under the impression that religion should consciously penetrate and characterize the entire life of men, they extended ecclesiastical authority over the very details of domestic life. Their chief functionaries were bishops, seniors and conseniors, presbyters or preachers, sediles, and acolytes. Their first bishop was consecrated by a Waldensian bishop, though they never united themselves with the Bohemian Waldenses. It was against their principles to engage in war; and having, on several occasions, refused to take up arms, they were at last deprived of their religious privileges. The result was, that, in 1548, about a thousand of the Brethren removed to Poland and Prussia. The contract which these exiles entered into with the Polish reformers at Sandomir, 14th April 1570, and, still more, the religious peace concluded by the Polish States in 1572, secured their toleration; but subsequently, in consequence of the persecutions of King Sigismund III., they united themselves more closely to the Protestants, though even at the present day they retain something of their old ecclesiastical constitution. The Brethren who remained in Bohemia and Moravia obtained a little freedom under the Emperor Maximilian II., and had their chief seat at Fulnek, in Moravia. In the 17th c., a number removed into Hungary, but during the reign of Maria Theresa, were coerced into Catholicism. The Thirty Years' War, so disastrous to the Bohemian Protestants, entirely broke up the societies of the B. B.; but afterwards they united again, though in secrecy. Their exodus about 1722 occasioned the formation, in Lusatia, of the *United Brethren*, or *Herrnhuters*. See MORAVIAN BRETHREN.

BOHEMOND I., eldest son of the Norman conqueror of Apulia and Calabria, Robert Guiscard, was born about 1056, and during his youth distinguished himself in his father's war against the Byzantine emperor, Alexis Comnenus (1081—1085). After his father's death, he was excluded from the throne of Apulia by his brother Roger, and only gained the principality of Tarentum after a long contest. He joined the crusade of 1092 with a large army—most of which he had won over from his brother's service—and took a prominent part at the fight of Dorylæum, in Cilicia, in 1096, and at the capture of Antioch, 1098. While the other Crusaders advanced to storm Jerusalem, B. remained in Antioch, where he established himself as prince. Being soon after besieged, the Christians, reduced to extremities, came out, and gave the sultan battle, and entirely routed his forces, B. greatly distinguishing himself in the fight. He was afterwards made prisoner by a Turkish emir, and remained two years in captivity. Tancred, meanwhile, looked after his interests in Antioch. B. returned to Europe to collect troops, and after defeating Alexis in several engagements, was acknowledged by that emperor as Prince of Antioch. He died in Apulia, 1111.—His son, B. II., a minor at the death of his father, assumed the government of Antioch (after Tancred had been regent for some years) in 1126, and was

killed in battle, 1130.—B. III., grandson of the former, was allowed to retain sovereignty only by the clemency of Saladin, and died 1201.—B. IV. (1233—1251) and B. V. (died 1275) were insignificant princes; and with B. VI. the Christian dynasty in Syria was brought to a close.

BÖHME, or **BÖHM**, JACOB, a German theosophist and mystic, was born of poor parents at Altscheidenberg, near Görlitz, in Upper Lusatia, 1575, and spent his boyhood in tending cattle. He received no instruction till he was ten years of age; but even then, the contemplation of earth and sky had so excited his naturally pious imagination, that he conceived himself inspired. He learned the trade of a shoemaker, but continued to devote much of his time to meditation on divine things. About 1612 was published his first book, called *Aurora*, or *the Morning Redness*. It contains revelations and meditations upon God, Man, and Nature; betokens a remarkable knowledge of Scripture, especially of the apocalyptic books; as also a familiarity with the writings of the mystico-philosophic alchemists. It was condemned by the ecclesiastical authorities of Görlitz; but the persecutions to which its author was subjected, had not the effect of convincing him of his errors. B.'s fundamental speculation is, that the forthcoming of the creation out of the divine unity—which is itself distinguishable into a trinity—can be contemplated by mystic illumination, and expressed in words. The object of his mystic contemplation, accordingly, is twofold: first, God himself apart from creation, or, to use some of B.'s own synonyms, the groundless, the eternal one, the silent nothing, the *temperamentum*; and, secondly, the forthcoming of the creature out of God. This forthcoming of the creation, which is also an in-going of the silent nothing, is, according to B., the principle of negation, and he calls it 'contrariety.' 'All things,' he says, 'consist in Yes and No. The Yes is pure power and life, the truth of God, or God himself. The No is the reply to the Yes, or to the truth, and is indispensable to the revelation of the truth. So, then, the silent nothing becomes something by entering into duality;' and so on into what most minds will think utter unintelligibility. Numerous attacks from theologians disturbed B.'s last years, but he bore them all with great meekness. They were probably occasioned by a tract on repentance which his friends had printed without his knowledge; and so great was the interest excited, that he was induced by the solicitations of certain courtiers and of his friends to visit Dresden for the purpose of having his doctrines investigated. The court applauded and protected him. On returning to Görlitz, he took ill, and died 27th November 1624. The first collection of his writings was published by Betke (Amsterdam, 1675); the most complete in 1730, at the same place; and the latest (1831—1846) by Schiebler, at Leipsic. Next to Germany, Holland and England are the countries in which B.'s works have been received with most favour. Sir Isaac Newton studied him, and used to make extracts from his works; William Law of Oxford published the best English translation of them in two quarto volumes, 1764; in 1697, Jane Lead, a fanatical disciple of B., founded a sect, called the Philadelphists, for the exposition of his writings; and John Perdage, a physician, is also famed among his English interpreters. Abraham von Frankenberg, who died in 1652, published the earliest biography of Böhme. In modern times, and in connection with speculative philosophy in Germany, his views, which had come to be regarded as empty mysticism, have acquired fresh interest and importance. This arises from the kindred character of

his fundamental principle with the spirit pervading the systems of Spinoza, Schelling, and Hegel. The intellectual contemplation of the absolute, out of which the contradictions in the world of phenomena proceed, and into which they return, is common to these systems and to B.; Hegel, indeed, expressly represents B.'s negativity, the active principle of development, as an obscure foreshadowing of his own intuitions, and on that account places him at the head of modern philosophy. The terminology of his philosophy, as will be seen from what we have quoted, is utterly fantastic; but his imagination often conceives splendid ideas, which are more profoundly appreciated in the 19th than they were in the 17th century. The latest German treatise on both the life and the doctrine of B. is Wuller's (Stuttgart, 1836).

BOHN, HENRY G., a well-known author, translator, and publisher, of German parentage, was born in London about the year 1800. It is impossible to estimate too highly the services he has rendered to the intelligent portion of the community by republishing, at a cheap rate, a vast number of the most valuable works in literature, science, philosophy, theology, &c. Such collections as the Standard Library (130 vols.), the Scientific Library, Library of French Memoirs, the Illustrated Library, the Classical Library (consisting of translations into English of the Greek and Latin authors), the Antiquarian Library, the Ecclesiastical Library, &c., contain the intellectual wealth both of the ancient and modern world. Mr B. has also obtained distinction as the editor of the *Bibliotheca Parriana*, of Addison's works, of Lowndes's *Bibliographer's Manual*, &c., and as translator of Schiller and other eminent authors. The latest production of Mr B. is a pamphlet (1860) against abolition of the paper-duty.

BOIARDO, MATTEO MARIA, Count of Scandiano, one of the most celebrated Italian poets, was born at Scandiano in 1430 or 1434. After completing his studies at the university of Ferrara, he was introduced at the court of Duke Borso d'Este, by whose successor, Ercole I., he was promoted to several honourable offices. In 1478, he was made governor of Reggio; in 1481, governor of Modena; and six years later, he again became governor of Reggio, where he died in 1494. His chief work is the romantic chivalrous poem, *Orlando Innamorato*, which he left unfinished in three books. Former writers had described Orlando only as a cold, pure, champion of Christendom; but B. introduced the element of love, to give an additional charm to romantic adventure. The method in which he does this not only proves him to have possessed a truly creative faculty, but also brings his conception nearer to the reality of history. B. furnished to all his poetical successors, even to Ariosto himself, the personages who figure in their adaptations of the old romance. His work was printed sixteen times before 1545, and was translated into French as early as the 16th century. As it was written in the dialect of the court of Ferrara, it failed to give satisfaction to the Florentines. Accordingly, after several attempts had been made to purify its diction, Lodovico Domenichi (died 1564) produced a *Riformazione* of the poem, 1545, without making any important change in the substance. Berni, in his *Rifacimento*, proceeded further, and gave to the whole poem a tone of burlesque; but his version enjoyed such popularity that it took the place of the original, which was almost entirely forgotten, until it was republished with introduction and critical observations by Panizzi (9 vols. Lond. 1830), and afterwards by Wagner in his *Parnasso Italiano Continuato* (Leip. 1833). The other works

of B. include *Sonetti e Canzoni* (Reggio, 1499); *Il Timone*, a five-act drama (1500); *Cinque Capitoli in Terza Rima* (1523); and *L'Asino d'Oro*, a version of the *Golden Ass* of Apuleius (1523); besides a translation of Herodotus (1533), and of Riccobaldi's *Chronicon Romanorum Imperatorum*.

BOII, the name of a Celtic people who at a very remote period seem to have inhabited either the southern part of Belgium, or a portion of France in its immediate vicinity, whence they emigrated to Italy. Having crossed the Po, they established themselves in the territory of the Umbrians, lying between that river and the Apennines, and for some hundreds of years waged a fierce war with the Romans. They were defeated at the Vadimonian Lake in 283 B. C.; at Telamon, in Etruria, in 225 B. C., during the great Gallic war, of which they were the original cause; rushed into rebellion on hearing of Hannibal's march, joined him at the battle of the Trebia in 218 B. C., destroyed the entire army of the consul Postumius in 216 B. C., took a prominent part in the revolt of the Gauls under Hamilcar, and in the destruction of Placentia, 200 B. C.; but at length, in 191 B. C., they were completely subdued by Scipio Nasica, who, besides killing a vast number, took from them nearly one-half of their land. At a later period, they were dispossessed of the whole, and driven across the Alps. Their subsequent history and geographical position are not very clear. Those who settled south of the Danube were, after a century, exterminated by the Dacians; those who returned to Gaul, were destroyed by Cæsar. The most important migration of the B., however, was that to the north of the Danube, where they founded the extensive kingdom Boiohemum, which was overthrown by the Marcomanni under Marbod. But though the dynasty of the B. was thus destroyed, the kingdom retained the name Boiohemum—i. e., home of the B., whence comes the modern Böhmen, or Bohemia.

BOIL (allied to Lat. *bulla*, a bubble) is a hard painful swelling of the skin. It begins as a small hard point of a dusky red colour, which is hot, painful, and throbbing. This point extends, and these symptoms increase in severity till about the sixth to the ninth day, when it ceases to enlarge, is of a conical form, with a broad firm base, and on the apex a whitish blister, which contains a little matter; this opens, and after a few days more there is discharged a core or slough of cellular tissue, and the small cavity left heals rapidly, leaving a white depressed scar.

Many kinds of boils have been described, but they may, like other diseases of an inflammatory nature, be divided into those which are *acute* and run a rapid course, as above described; and the *chronic*, which take three or four weeks to 'come to a head.' Boils are most common in the spring, and in young and plethoric persons, and their appearance is quite consistent with robust health. Men in training for boat-races, or others who have suddenly changed their diet and daily habits, are said to be very subject to them. There is a form of B. which generally occurs on the back of the neck, after some disorder of the stomach, in elderly people, hence it is called 'Old People's Boil.' In some, boils continue to succeed each other for a length of time; others are attacked during the night, after having experienced feelings of nausea and languor, by pustules, which are called night-boils (*epinyctis*).

The treatment of boils varies with the subject of them: in many, they are merely critical—in other words, a natural effort 'to relieve some function of the body by a peculiar inflammation of the skin.' The intestinal canal should be cleared out by

laxative medicines, and the digestive powers improved by tonics and antacids. The skin should be kept healthy by frequent washing, while the inflamed spot should be poulticed with poppy-heads or hemlock, mixed with other materials. Wet lint is a sufficient application after the core has been thrown off. If the patient chooses to submit, however, to a momentary pain, he will have the greatest, most permanent, and immediate relief from a cut carried quite through the boil. John Hunter, the great surgeon, got rid of habitual boils by taking repeated doses of soda in milk.

BOILDIEU, ADRIEN FRANÇOIS, an eminent French composer, was born at Rouen in 1775. His talent for music was early developed. At the age of eighteen, he brought out a one-act opera in his native town, and two years afterwards he repaired to Paris, where he produced many successful compositions. When the Conservatoire de Musique was established, B. was elected a professor. In 1803 he went to Russia, where he was appointed, by the Emperor Alexander, *mattre de chapelle* at the imperial court. He remained in Russia eight years, during which time he produced several operas. In 1811, he returned to Paris, where he brought out *La Dame Blanche*, his most popular piece, *Jean de Paris*, *Le Petit Chaperon Rouge*, and other works. He died in October 1835; and, as a tribute to his genius, the nation honoured him with a public funeral. His native city claimed his heart, and to defray the pomp of its reception in the cathedral, the municipality voted 12,000 francs. The government further marked its sense of his merit by granting a pension to his son.

BOILEAU DESPRÉAUX, NICOLAS, an illustrious French poet, was born near Paris, November 1, 1636. After hesitating for some time in the choice of a profession, he betook himself to *belles-lettres*. In 1660, his fine powers first obtained an adequate expression in the satire, entitled *Adieux d'un Poete à la Ville de Paris*. In 1666, he published his seven *Satires*. The favourable reception which they met with, induced him to continue, until he had increased the number to twelve, of which the eight and ninth are considered the best. In these satires, B. even ventures to castigate the *Coryphæi* of the world of letters—Chapelain, Cotin, Scudery, &c. To his honour, however, it must be said that malice does not once animate his pen; he is always pleasant and gay, never cruel. His contemporaries are his laughing-stocks, not his victims. Between the years 1669 and 1696 appeared his *Twelve Epistles*. They indicate a riper genius than the *Satires*. The versification has more ease and grace; the style, a quicker movement and a firmer consistency; the thoughts are more vigorous, and more strictly concatenated; everywhere there is greater truth, colour, and energy. The one addressed to Racine, who, along with B., filled the office of royal historiographer, is reckoned among his finest. In 1674, B. published *L'Art Poétique*, accompanied by a translation from the Greek of *Longinus on the Sublime*, and the greater part of *Lutrin*. These are by many French critics considered his *chefs-d'œuvre*. The first is indeed an exquisite performance, and has been copiously imitated in Pope's *Essay on Criticism*. It lays down rules for almost every species of poetry, in a clearer and more methodical manner than had ever been done before, while the whole poem is sprinkled with touches of delicate satire. The second, *Lutrin*, is a comic epic in six cantos, immensely admired by his countrymen. Besides these, B. wrote several minor pieces, both in prose and verse, such as—*Dialogue des Héros de Roman*, *Dissertation sur Jaconde*, *L'Arrêt Burlesque*, and *Discours sur la Satire*. A large number of his letters have

been collected. Among them are twenty to Racine. The letters of B. are in general extremely valuable, from the fact that they contain a large proportion of the literary history of the time. They also enable us to form a just idea of his character. He was high-minded, generous, and pure. In fact, his impulsive disposition and imprudent warmth of heart quite contradicted the common notion of what a satirist is. When Corneille's pension was ordered to be stopped, after the death of Colhert, B. flew to the king, remonstrated against so 'barbarous a spoliation,' and threatened to resign his own, if the decree were carried into effect. He courageously denounced the persecutors of the nuns of Port-Royal; expressed his admiration of Arnauld, when the latter was on the point of being arrested; extricated out of pecuniary embarrassments many friends; and through sheer kindness of heart, forced on a reconciliation with various of his literary adversaries. An admirer of Pascal, and a friend of the Jansenists, he could yet render homage to the talents of such Jesuits as Bourdaloue, Bonhours, and Rapin; but his most intimate and cherished companions were Molière, Racine, and La Fontaine. Until 1706, B. lived much in public, but after that his bodily infirmities induced him to retire to Auteuil. He died March 13, 1711. B.'s influence on French literature has been immense, and, on the whole, beneficial. Voltaire proclaimed him 'the legislator of Parnassus.'

BOILER (Fr. *chaudière*, Ger. *Kessel*), the name given to that part of a steam-engine where the steam is generated. It consists essentially of a close vessel made of metal-plate, having apertures for the admission of water and the egress of steam. When water is boiled in an open vessel, the temperature of the water and the steam rising from it remains at or very near 212° F., and the elastic force or tension of the steam is no more than sufficient to make its way into the atmosphere. Steam at 212°, therefore, is said to have a tension equal to one atmosphere. In a close vessel, on the other hand, we may raise the temperature and tension of the steam to a very high point; for this, however, it is requisite that the vessel shall have sufficient strength to resist the outward force of the steam. In boilers, therefore, where steam of several atmospheres has to be produced, considerable strength is needed to insure efficiency and safety. The strength of a B. depends partly on its shape, and partly on the nature of the material employed. The globular form is the best adapted for strength, because every part of a B. of this shape is exposed to equal strain. Boilers, on the other hand, whose surfaces meet each other at sharp angles, are not calculated to withstand high pressures. For the most part, boilers are made of plates of malleable iron, riveted together. Copper has been likewise highly recommended for the construction of boilers, as possessing many advantages. Its conducting power is $2\frac{1}{2}$ times greater than that of iron, so that boilers made of it produce steam much more readily than iron boilers, and may, in consequence, be made of less dimensions and of less thickness. Although copper is much more expensive than iron, the expense of a copper B. is in this way not much more than an iron one, and it occupies considerably less space. Wrought iron boilers, so far as the value of the material is concerned, scarcely pay the expense of removal, whereas the material of copper boilers in this condition is said to be worth $\frac{3}{4}$ ths of the original cost. Again, copper boilers do not hurst as iron boilers, which frequently scatter their fragments in all directions, but simply tear open—a property which lessens immensely the dangers attending an explosion. Although the globular form gives to a B. the greatest strength, it deprives it of a most essential

BOILER.

requisite—namely, a large surface for the furnace and the heated air and gases proceeding from it to play upon. A spherical B., for its capacity, offers the least heating surface, so that, although a strong, it is by no means an economical one. The conditions, therefore, of strength and heating surface are opposed to each other, so that the machinist must endeavour to give his boilers such a shape that both conditions may be conceded.

The following are some of the more frequent forms of boilers. Fig. 1 represents the wagon B., one of the most important improvements of Watt for cheapening the working of the steam-engine, boilers previous to his time being made round, for the sake of strength. The furnace is placed below the B. in front, and the flues are built round the B. in such a way that after the heated air and gases have passed along the bottom of the B., they return along the side AB to the front, where they pass over to the side C, at the back end of which they are admitted into

the chimney. The heating surface is by this means greatly increased, and a small proportion of the heat passes off unempoyed. To prevent the B. from becoming red hot in its upper part, the level of the water is maintained a few inches above the upper surface of the side-flues. The wagon B. is the usual form of low-pressure boilers, or those in which the pressure of the steam exceeds that of the atmosphere by only a few pounds. Fig. 2 represents the cylinder B., the form generally employed for steam of high tension. Its length offers a large heating surface, while its roundness is favourable to great strength. The ends are usually hemispherical, but they are sometimes also flat, in which case they are made of great thickness. The length of the cylinder is about 10 or 12 times the diameter. The flues are disposed round it in the same way as in the wagon boiler. The cylinder B. is frequently made with a wide tube passing through the middle of it, within which the furnace is placed, fig. 3. In

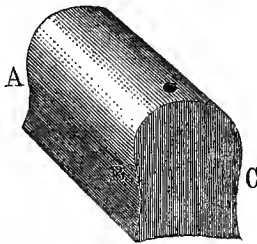

Fig. 1.

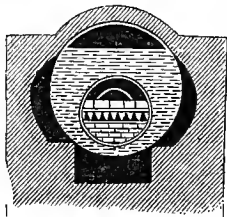

Fig. 3.



Fig. 2.

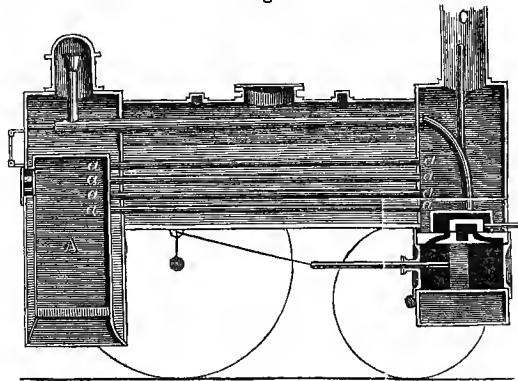

Fig. 4.

this arrangement, the heated air is made to pass not only round the sides, but also under the bottom of the boiler. Sometimes two such internal flues are introduced, so as still further to increase the heating surface. In locomotive boilers, where a large quantity of steam of a high tension (from 5 to 10 atmospheres) must be generated in a B. of comparatively moderate dimensions, a special construction is adopted for increasing the heating surface. In addition to the furnace or fire-box, A, fig. 4, being surrounded on all sides by water, the B. is perforated from end to end with about 100 brass or copper tubes about $1\frac{1}{2}$ inch in diameter, to which the products of the furnace yield their heat in their passage to the chimney, C. The position of these tubes, α, α , is shewn in the figure. See LOCOMOTIVE.

The construction of the furnace-flues and chimney forms an important element in the efficiency of a boiler. The furnace is placed below the B., so that the radiation from the fire may have its full heating effect. The bars of the grate are generally about $1\frac{1}{2}$ inch thick, and placed at half an inch from each other, when coal is the combustible employed. Below the grate is the ash-pit, for the reception of the waste products of combustion. A partition, called the fire-bridge, is

built at the junction of the furnace with the flues, which narrows the channel to a few inches all round, thereby bringing the products of combustion more nearly in contact with the B., and at the same time mixing them intimately with the air. It is of the utmost importance that as little as possible of the heating material should pass off unconsumed, or that the combustion should be accompanied by little smoke. Boilers with double internal flues are well adapted for this purpose. It is usual with these to charge one of the furnaces with coal while the other is in full combustion, so that when the heated products of both, after traversing the B., meet in the common flue, what has escaped combustion in the newly charged furnace is then consumed by the heated air proceeding from the other. The disposition of the flues round the B. has been already referred to. It is usual to give the chimney the same section as the flues. The height of the chimney has an important effect on the draught, and consequently on the briskness of the fire. The higher it is, the greater is the velocity with which the heated column it contains rises into the air. The usual height varies from 60 to 120 feet; and where this height cannot be attained, some artificial means must

BOILER—BOILING, BOILING-POINT.

be adopted for increasing the draught, such as air-bellows. In the locomotive engine, the draught is stimulated by the steam discharged from the cylinders, which rushes with great force through the chimney.

The apparatus attached to the B., and essential to its proper working, are the water-gauge, the feed-pipe, the manometer, and safety-valves. The water-gauge, which shows the height of the water, frequently consists of a glass tube, firmly cemented above and below, to metal tubes connected with the B., the water attaining the same level in the tube as in the interior. The level is sometimes also shown by having two tubes inserted in the B., both being closed with stop-cocks. One of these tubes descends a little below the proper level of the water, and the other terminates a little above it, so that if, when these gauge-cocks are opened, water rushes from the first, and steam from the second, the water is of the proper height. If steam issue from both, the level is too low; and if water, too high. The float-gauge is another arrangement for the same purpose. It is formed by suspending, by means of a wire passing steam-tight through the B., a stone-float to the one end of the beam of a balance, which is kept horizontal by a counterpoise at the other end when the water is of the due height. When the water is too low or too high, the end of the beam to which the float is attached is inclined downwards or upwards accordingly.

The feeding apparatus which supplies the B. with water is different for different kinds of boilers.

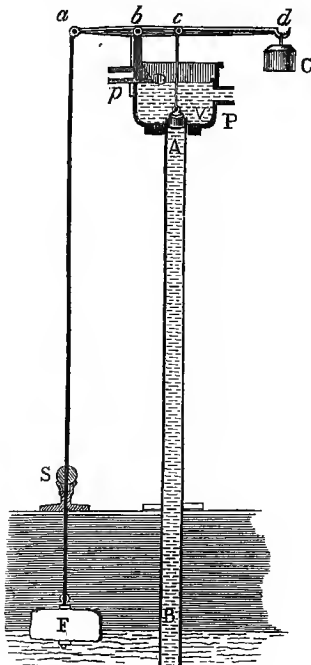

Fig. 5.

For high-pressure boilers, it is usually a forcing-pump, which is worked at the discretion of the attendant. The self-acting arrangement attached to low-pressure boilers is shown in fig. 5. AB is an iron pipe fixed to the top of the B., and rising a few feet above it; D is an iron bucket, resting on AB, and supplied with water through the pipe P, which

proceeds from a forcing-pump worked by the engine. The water can rise no higher in the bucket than the overflow-pipe, *p*. The lever, *ad*, moves on a pivot, *b*, attached to one side of the bucket, from the one extremity, *a*, of which is suspended the stone-float, *F*, by a wire passing through the stuffing-box, *S*; and from the other extremity, a weight, *C*, hangs, to counterbalance the difference of the specific gravities of the stone and the water. The valve *V*, opening upwards, and which is connected with the lever by the rod *cV*, closes the communication between the tube, *AB*, and the bucket. When the water in the B. gets low, the float, *F*, sinks, and by means of the lever, raises the valve *V*, and as much water is admitted as raises the level in the B. to the proper point, when the lever being horizontal, the valve is again closed.

Boilers are usually furnished with two safety-valves—one for allowing the steam to escape when the tension becomes too high; and another, for admitting the air, when the B. is cooled, and the steam within it condensed. The latter valve is generally placed in the plate which covers the man-hole, the opening by which a workman can be admitted to the interior for repairs. For further details, see SAFETY-VALVE, MANOMETER.

BOILING (of Liquids)—BOILING-POINT. When heat is applied to a vessel containing water, the temperature gradually rises, and vapour comes silently off the surface; but at a certain degree of heat, steam (q. v.) begins to be formed in small explosive bursts at the bottom, and rising through the liquid in considerable bubbles, throws it into commotion. If, after this, the steam is allowed freely to escape, the temperature of the water rises no higher, however great the heat of the fire. The water is then said to *boil*, and the temperature at which it remains permanent is its *boiling-point*. The boiling-point of water is ordinarily 212°; but every liquid has a point of its own. Thus, sulphuric ether boils at 96°; alcohol, at 176°; oil of turpentine, at 316°; sulphuric acid, at 620°; and mercury, at 662°. The boiling-point of liquids is constant, under the same conditions, but is liable to be altered by various circumstances. Water with common salt in it, e. g., requires greater heat to make it boil than pure water. The nature of the vessel, too, exerts an influence; in a glass vessel, the boiling-point of water is a degree or two higher than in one of metal, owing to the greater attraction that there is between water and glass than between water and a metal. But what most affects the boiling-point is variation of pressure. It is only when the barometer stands at 30 inches, shewing an atmospheric pressure of 15 lbs. on the square inch, that the boiling-point of water is 212°. When the barometer falls, or when part of the pressure is in any other way removed, it boils before coming to 212°, and when the pressure is increased, the boiling-point rises.—Thus, in elevated positions, where there is less air above the liquid to press on its surface, the boiling-point is lower than at the level of the sea. An elevation of 510 feet above the sea-level, makes a diminution of a degree; at higher levels, the difference of elevation corresponding to a degree of temperature in the boiling-point increases; but the rate of variation once ascertained, a method is thus furnished of measuring the heights of mountains. See HEIGHTS, MEASUREMENT OF. At the city of Mexico, 7000 feet above the sea, water boils at 200°; at Quito, 9000 feet, at 194°; and on Donkia Mountain, in the Himalaya, at the height of 18,000 feet, Dr Hooker found it to boil at 180°. Boiling water is thus not always equally hot, and in elevated places, many substances cannot be cooked by boiling. Under the receiver of an air-pump, the

BOILING.

same effect is still more strikingly seen; water may be made to boil at the temperature of summer, and ether when colder than ice. In complete vacuo, liquids, in general, boil at a temperature 140° lower than in the open air. The knowledge of this effect of diminished pressure is now largely turned to account in sugar-boiling, in distilling vegetable essences, and in other processes where the substances are apt to be injured by a high temperature.—By increasing the pressure, again, water may be heated to any degree without boiling. Papin's Digester (q. v.) is formed on this principle. Under a pressure of two atmospheres, the boiling-point rises to 234° ; of four atmospheres, it is 294° ; of ten atmospheres, 359° ; of fifty atmospheres, 510° .

In a deep vessel, the water at the bottom has to sustain the pressure not only of the atmosphere, but also of the water above it. At a depth of 34 feet, the pressure of the water above is equal to an atmosphere, or 15 lbs. on the square inch; and thus, at the bottom of a vessel of that depth, the water must be heated to 234° before it is at its boiling-point. This principle has been successfully applied to explain the phenomena of the Geysers (q. v.).

If a small quantity of water be poured into a silver basin, heated above the boiling-point, but below redness, it will begin to boil violently, or perhaps burst into steam at once. But if the basin is heated to redness, the water will gather itself into a globule, and roll about on the hot surface, without becoming heated to the boiling-point. For the explanation of this and other interesting phenomena connected with it, see SPHEROIDAL CONDITION OF LIQUIDS.

BOILING, in Cookery. One important preliminary rule in boiling rests on the fact, explained in the preceding article, that water cannot be heated in an open vessel, or in one with the ordinary fitting lid of a cooking utensil, to a higher point than 212° . When a vessel, then, has once begun to boil, a stronger fire than is just sufficient to keep it boiling will only evaporate, or waste, the water in steam, but will not cook the food any faster; on the contrary, the outside will be rendered so hard by the quick boiling, that the interior will not be reached by the heat.

By long soaking in cold or tepid water, fresh meat loses much of its albumen and nutritive juice. When a piece of meat is to be boiled, it is necessary, for the preservation of these juices, and its consequent tenderness and nutritious quality, that the outside should be sealed up, by immersing it in boiling water, and keeping up the temperature for a minute; this closes up the pores, and coagulates the albumen of the exterior. The boiling water should then be taken off, and as much cold put in as will reduce it to a tepid state; it should then be gradually warmed until it reaches a degree *slightly* under the boiling-point, called *simmering*; at this point it must be kept without suffering any interruption of the heat, till the time elapses that is allowed for cooking the food. 'The cooking goes on through the agency of the natural moisture of the flesh. Converted into vapour by the heat, a kind of steaming takes place within the piece of meat; it is, when skilfully done, cooked by its own steam.'

To prepare meat for B., it should be trimmed, washed, and dried before it is placed in the water. As it simmers, the water should be kept well skimmed with a skimming-spoon, as frequently as any scum is thrown up, but with due remembrance of the fact, that raising the lid of the vessel lowers the temperature of the water; and the preservation of an equal degree of heat throughout the operation is of the greatest importance.

For fresh meat, 20 minutes is the allowance for each pound. The weather must also be considered: in frosty weather, or with very thick joints, extra 20 minutes should be given. Mutton loses in boiling, in 1 lb. $3\frac{1}{2}$ oz.; beef, in 1 lb., 4 oz. Meat that has been salted and dried has its outer coat already sealed up; it requires, therefore, to be thoroughly washed, soaked for two hours in cold water, dried, and put to boil in cold water, gradually brought to the boiling-point, and kept simmering for a time, proportioned to the size of the piece. Hams and tongues to be eaten cold, should be allowed to cool in the water in which they have been boiled. The following is a time-table for the cooking of these meats, reckoning from the time the water boils: A ham of 16 lbs. takes 4 hours; a tongue of 16 lbs., 2 to 4 hours; a pig's face of 16 lbs., 2 hours; a piece of bacon of 4 lbs., 2 hours.

Poultry, and white meats, as veal or rabbit, should be put at once into tepid water, gradually brought to the boiling-point, drawn back immediately, and simmered, carefully skimming the water as scum rises. A chicken, or small fowl, or rabbit, will take 35 minutes; a fowl, or old rabbit, an hour, or an hour and a half, according to size. Some cooks add milk to the water, but this is apt to cause the scum to stick to the meat in streaks; some also use a cloth to enclose the meat, but this frequently imparts to it a disagreeable taste. Having trimmed, washed, and dried the meat, all that is necessary to keep it white, is to use a perfectly clean utensil, to be attentive to the skimming, and careful that no soot falls from the lid into the pot when doing this. Meat should only just be covered with water; if it wastes, a cupful of water at the same temperature should be added. The liquor in which fresh meat has been boiled, is an excellent foundation for soups and gravies.

Fish should be well cleaned and scraped; liver and roe should be carefully preserved, and boiled with the fish, in a fine net; they are used to garnish the fish. The sound of cod should be carefully cleaned, and left in the fish. Fish should be placed in cold water, in which a tablespoonful of salt and one of vinegar is mixed; should be gradually brought to the boiling-point, and simmered carefully, lest the outer part should crack before the thick part is done. If on drawing up the fish-plate, a thin knife will easily divide the flesh from the bone in the thick parts, and if the eyes contract, and become like balls, the fish is sufficiently cooked. Drain by laying the plate across the kettle covered with the lid, and dish perfectly dry on the strainer, which should be covered with a napkin.

Vegetables require generally to be well washed, and placed in boiling water, in which is mixed a large spoonful of salt. When they sink, they are done. Green vegetables should be well picked, soaked in salt and water, drained and boiled in plenty of water, in a vessel without a lid. Cabbage requires two waters; spinach, very little, as it is full of moisture. Pease and beans should not soak, but be merely rinsed in a colander. Winter potatoes should soak for an hour or more; whether they should be placed in cold or B. water, depends on the sort. A piece of soda the size of a small marble assists the B. of pease and cabbage, if the water is very hard.

For B. meat, the best vessel is one made of iron, tinned inside or not, but one kept perfectly dry, and free from grease or rust. Tinned vessels are proper for B. fish and vegetables; they require to be kept very dry, the moisture entering between the metals rusts the iron, and makes holes that cannot be mended. A tinned vessel in daily use should be polished once a week with fine whiting and oil; too frequent

polishing wears off the tin. The advantage of a tin over an iron utensil is, that it gains heat sooner.

BOIS BLANC, an island of the United States of America, situated in Lake Huron, between Michillimackinac and Michigan. It measures ten miles by three, and has a light-house at its east end.

BOIS-DE-BOULOGNE. See BOULOGNE.

BOIS-LE-DUC (Dutch, *S' Hertogenbosch*, 'Duke's Forest'), a fortified town of the Netherlands, capital of the province of North Brabant, is situated at the junction of the Dommel and the Aa, about 28 miles south-south-east of Utrecht. B., which is a clean and well-built town, is about five miles in circumference, and is intersected by canals, has a citadel, two forts, a cathedral—one of the finest ecclesiastical buildings in Holland—an academy of arts, a grammar-school, in which Erasmus was educated, an arsenal, several hospitals, manufactures of linen-thread, woollens, ribbons, cutlery, &c., and several distilleries. Pop., including garrison, about 22,000. B. is a place of considerable antiquity, having been founded in the midst of a forest—hence its name—in 1184, by Godfrey III., Duke of Brabant. The forest was cut down by his son and successor Henry, who surrounded the town with walls. In the 16th c., B. separated itself from the States, and was ineffectually besieged, in 1601 and 1603, by Prince Maurice of Nassau, but had to surrender to a Dutch force in 1629. In 1794, B. was taken by the French; and in 1814, retaken by the Prussians.

BOISSERÉE, SULPIZ, a celebrated archæologist, was born at Cologne in 1783. A visit which he and his brother Melchior (born 1786), along with their friend Joh. Bapt. Bertram, paid to Paris in 1803, inspired the trio with the idea of collecting and preserving the scattered specimens of early German art. The realisation of this idea became the single object of their lives. After many years of patient and unwearied research, they gathered together 200 pictures, which received the name of 'the Boisserean Collection.' The king of Würtemberg having presented the brothers with a spacious edifice in Stuttgart, the pictures were transferred thither, and skilfully arranged, according to their age and importance. This brought to light a very important historical fact, previously unknown—viz., that in the 14th c., Germany possessed a school of art based on Byzantine traditions. Great light was also thrown upon many of the Flemish masters, and especially on the influence exerted by Jan Van Eyck. The collection was divided into three sections corresponding to three historical periods—the first comprising the works of the Cologne school in the 14th c.; the second, those of Van Eyck and his disciples in the 15th; and the third, those of the German painters at the close of the 15th and beginning of the 16th centuries. In 1827, the collection was sold to the king of Bavaria; and in 1836 was transferred to the picture-gallery (*Pinakothek*) in Munich, whither the brothers followed it. Sulpiz died in 1841, and Melchior in 1851. The former has left several interesting and valuable works; such as, *Monuments of Architecture on the Lower Rhine, from the 11th to the 15th c.* (Munich, 1830—1833); *Concerning the Temple of the Holy Grail*, 1834; *Collection of Old Low and High German Paintings, with Notices of the Early Painters, by Sulpiz and Melchior B. and Joh. Bapt. Bertram, lithographed by J. V. Striämer* (Munich, 1822—1839); and a very magnificent work, entitled *Views, Plans, Sections, and Details of the Cathedral of Cologne, with Restorations after the Original Plan, accompanied by Researches on the Architecture of Ancient Cathedrals, &c.* (Paris and Stuttgart, 1823—1832).

BOISSY D'ANGLAS, FRANÇOIS ANTOINE, COUNT, an eminent French statesman, was born at St Jean Chambre, in the department of Ardèche, December 8, 1756. After filling for some time the office of major-domo to the Count of Provence (Louis XVIII.), he was about to devote himself to the peaceful pursuits of science, when he was elected a deputy to the States-general. While a member of the Constituent National Assembly, he was accused of having a design to change the French monarchy into a Protestant Republic. During the Reign of Terror, fear of 'the Mountain' kept him quiet; but, yielding to the solicitations of Tallien and Barrère, he joined the conspiracy against Robespierre. Two months after the execution of the tyrant, he was elected secretary of the Convention; and shortly after, a member of the Committee of Public Safety, in which capacity he displayed remarkable talent and discretion. As director of the supply of provisions for Paris, he was exposed to popular hatred and great peril during the riotous and sanguinary proceedings of the 12th Germinal and 1st Prairial in the year 3 of the Republic; but firmness and presence of mind preserved him. He was afterwards president of the Council of Five Hundred; was called into the senate by Napoleon; and made a peer by Louis XVIII. Through all the changes of the times, he maintained the principles with which he had commenced his career. He died in Paris October 20, 1826. His chief writings are, *Recherches sur la Vie, les Ecrits, et les Opinions de Malesherbes*, 1819, and *Études Littéraires et Poétiques d'un Vieillard*, 1825; but, in addition to these, he published numerous essays, pamphlets, and letters.

BOJADO'R, CAPE, a headland on the west coast of Africa, in lat. 26° 7' N., long. 14° 29' W., forming the western extremity of the Jebel Khal (or Black Mountains), a rocky ridge running eastward into the Sahara. In consequence of its extreme flatness, and the shoreward tendency of the currents, the coast, extending northwards to Cape Nun, is one of the most dangerous that mariners have to encounter, and is frequently the scene of shipping casualties. The Portuguese doubled this cape in 1433, and from them it received its name B. C., signifying 'a round cape.'

BOJA'NO, a town in the province of Molise, Naples, 13 miles south-west of Campobasso. It is situated on the Biferno, in a deep gorge at the foot of the mountain-range of Matese; has a cathedral and some ancient remains. It has suffered greatly from earthquakes, and especially from one which occurred in 1805. Pop. 3000. The site of B. has been identified as that of the famous Samnite city of *Bovianum*, which played so conspicuous a part in the Samnite, Punic, and Social wars. Unsuccessfully besieged by the Romans in 314 B.C., it was taken by them in 311, and yielded immense spoils. Passing out of their hands, it was retaken by them in 305 B.C.; and once more reverting to its original owners, was a third time captured by the Romans, in 293 B.C. During the second Punic War, it formed the head-quarters of the Roman army on more than one occasion; and in the great Social War, the confederates, on the fall of Corfinium, made it their capital and the seat of their general council. Surprised by Sulla, it was retaken by the Marsic general, Pompædus Silo. Cæsar established a military colony here; and afterwards, under the Roman empire, the town seems to have recovered considerably from the ruin which overtook it on the general devastation of Samnium.

BOJAR (pronounced *Bojar*), a word originally of the same meaning as Czech, Lech, and Bolgarin, i. e., free proprietor of the soil. The Bojars, in old

Russia, were the order next to the knjazes or knjzes (ruling princes). They formed the immediate 'following' of these princes, and bore somewhat of the same relation to them as the lesser English and Scottish knights of the feudal ages did to the great barons Percy, Douglas, &c. They had their own partisans, who served them as a kind of body-guard; they gave their services to a prince of their own choice, whom, however, they left again at their pleasure, and, in consequence of this, the knjzes could only secure their allegiance by the bestowment of privileges which were often abused. They held exclusively the highest military and civil offices, and were so universally looked up to by the mass of the people, that the most powerful rulers, even Ivan the Cruel, considered it prudent to use this form of expression in their ukases: 'The Emperor has ordered it; the Bojars have approved it.' Rank among the Bojars was always proportioned to length of state-service, and was observed with the utmost rigour, so that the B. who had obtained an office, as it were, yesterday, looked down with proud contempt on him who only entered on his to-day. This singular mode of securing gradation of rank was called *miestnicestvo*. It was a most peculiar phenomenon of Slavic life, equally unlike feudalism and modern aristocracy, and must be regarded as a strictly national development. In their housekeeping the Bojars were excessively fond of splendour, and their contempt for the serfs or 'lower orders' was immeasurable. In the lapse of time, many Chinese customs—as might be expected from their theory of rank—crept into their public life. Their power, and the respect which was paid them, acted as a wholesome check upon the otherwise unbridled authority of the princes; in consequence of which, the latter became their bitter enemies, and often sought to destroy their power. This was finally done by Peter the Great, who abolished the order of Bojars by giving them a place among the Russian nobility, but, at the same time, stripping them of their peculiar privileges. The last B., Knjaz Ivan Jurjewicz Trubeckoj, died 16th January 1750.

In Moldavia and Wallachia, bojars still exist. They have a seat and vote in the council of the Prince, and, as recent history shews, exercise at times a most extensive influence.

BOKHARA (i. e., Eastland), or **USBKISTAN**, a country of Independent Tatar, Central Asia, originally forming part of the ancient district of Sogdiana. Its extent is not exactly known, but it is generally described as lying between lat. 36°–42° N., and long. 67°–70° E. Its area has been estimated at 235,000 square miles, and its population variously from 1,000,000 to 2,500,000.

B. is essentially a level country, though in the east it is penetrated by offsets from the Bolor-tagh, which are said by one traveller (Burnes) to reach in some places a height of 18,000 feet. Only in the basins of the rivers, forming about a tenth part of the area of the entire country, is cultivation possible. The rest of the soil of B. is composed of a stiff arid clay, interspersed with low sand-hills, partaking of the desert character of that singular and extensive depression of country extending from the Volga to the Hindu Kush. B. belongs exclusively to the basin of the Sea of Aral. It has only three rivers of any importance—the Amu or Jihun (anciently the *Oxus*); the Kohik, Zar-afshan, or Samarcand; and the Kurshi. Entering B. at Kushtuppa, the Amu flows through the country in a west-north-west direction to the Sea of Aral. Its banks in some parts are very fertile, especially in the neighbourhood of Balkh. The Kohik, which rises in the eastern mountains alluded to, after a course of about 200 miles, issues out into the plain near Samarcand, and

thence fertilises the district (Meeankal) to the city of Bokhara. Before reaching the city, it sends out a northern branch, which, after a fertilising course of several miles, is absorbed in the sand. The southern branch passes B. to the north, and terminates in the lake of Kara-kool, a sheet of salt water about 25 miles in circumference, which is connected with the Amu by irrigating canals. The valley of the Kohik is the richest as well as the most populous in Bokhara. The Kurshi has a course of about 60 miles before it is lost in the desert.

The climate of B. is moderate and healthy. The rains usually commence and end with February. Violent sand-storms are frequent, and occasion ophthalmia among the inhabitants, who are also subject to the attacks of the guinea-worm, which penetrates into the flesh, causing great pain and annoyance.

Minerals are scarce. The sands of the Oxus yield gold. Salt deposits are numerous. Alum and sulphur are found in the vicinity of Samarcand, and salammoniac in the mountainous districts. The other products include rice and cotton, wheat, barley, beet-root, vegetables, hemp, which is only used in the preparation of an intoxicating liquor called *bhang*, silk, fruits in immense abundance, and tobacco. The camel's thorn, a plant that grows luxuriantly in Samarcand and Kurshi, exudes a saccharine gum or manna, extensively used as sugar.

Sheep and goats form a great source of wealth. Camels are numerous and valuable; the horses are celebrated for their strength and endurance; and the breed of asses is excellent.

The industry includes the manufacture of silk-stuffs, cotton-thread, shagreen, jewellery, cutlery, and firearms. Its geographical position secures B. the transit-trade between Russia and the south of Asia. The annual value of the merchandise sent to Russia is estimated at £700,000, and of that taken in return at £450,000. In the trade with Russia, between 5000 and 6000 camels are engaged; and more than half as many are employed in the traffic with Cabul, Herat, and Cashmere. The exports consist of the natural products and articles of industry already mentioned; the imports include India muslins and brocades, white cloths for turbans, sugar, shawls, European manufactures, tea, &c.

The population is made up of a great variety of nations. The Usbeks, who are the latest conquerors, are the most numerous. They are of Tatar origin. A few are employed in agriculture and the mechanical arts, and others hold offices under government, but the majority continue nomadic. The Tajiks, or Tadjiks, who regard themselves as the aborigines of the country, the descendants of the ancient Sogdii, stand next in point of numbers. They are the most industrious of the population. The Turkomans are third in importance. They are fierce nomads, recognising the authority of the Khan of B. only when it suits their interests to do so. They, as well as the Kirghiz and Kara-Kalpaks, who dwell north of the Kohik, and in the vicinity of Kurshi, are of Turkish origin. There are, besides, settled in B. in smaller number, Arabs and Persians, Mongols, Kalmucks, Afghans, Jews, and Gipsies.

Though the khan's government is professedly a despotism, being regulated by the Koran, it is really under the control of the Mohammedan priesthood. The number of troops the khan has at his disposal is variously estimated at from 25,000 to 40,000 of all arms; the revenue at about £400,000 annually. The Mohammedan religion is the only one professed.

B. was conquered by the Arabs in the beginning of the 8th c., who were dispossessed of it in 1232 by Genghis Khan. It fell into the hands of Timur in

1303, and was taken by the Usbeks—who still maintain their supremacy—in 1505.

Colonel Stoddart and Captain Conolly, who went on a mission to B., were murdered, by order of the khan, in 1843; and Dr Wolff, who visited the country in 1844, with a view to ascertain their fate, narrowly escaped with his life, after a detention of some months.

BOKHARA (honoured with the title of the 'Treasury of Sciences'), a famous city of Central Asia, capital of the above khanat, is situated on a plain in lat. 39° 48' N., long. 64° 26' E., in the midst of trees and gardens. It is between 8 and 9 miles in circumference, and surrounded by embattled mud-walls, about 24 feet high, and pierced by 11 gates. The houses, which are small, ill-lighted, and, with the exception of those belonging to the wealthy, uncomfortable inside, are built of sun-burnt bricks on a wooden framework; and the roofs of all are flat. The streets are ill-paved and very narrow, the widest barely sufficing for the passage of a loaded camel, while others are not more than 3 or 4 feet across. The palace of the khan occupies an eminence of between 200 and 300 feet in height in the centre of the city. It is surrounded by a brick-wall of 60 or 70 feet high. The area includes, besides the palace, the harem, which is quite embosomed in trees; various public offices, the residences of the vizier and other important state-functionaries, the barracks, royal stables, &c., and three mosques. The mosques, which are said to be 360 in number, necessarily form one of the greatest features of Bokhara. The most imposing one occupies a square of 300 feet, and has a cupola 100 feet high, ornamented with blue tiles. Attached to it is a tower of about twice the height, built by Timur, from which criminals are hurled. B. is celebrated as a centre of learning, and has, in addition to a vast number of schools, 103 colleges, at which, in 1840, it is stated there were 10,000 students. As a commercial town, B. is the most important in Central Asia. Its bazaars are numerous and extensive, and almost all kinds of goods are obtainable at them. The quantity of fruit displayed, and the demand for it, is perfectly marvellous; as is also the demand for tea, which is drunk at all hours, and is sold ready for consumption in the market; and the noise in the streets all day is described as quite deafening. B. has 38 caravansaries—where merchants from India, China, Cabul, Tatar, Russia, and Turkey assemble—and a large number of baths. A canal intersects the city, but during the summer months it is often dried up, and water becomes very scarce. Pop. variously estimated at 70,000—180,000.

BOKHARA CLOVER. See MELLOTO.

BO'LA BO'LA, or **BONA BONA**, or **BORA BORA**—the liquids *l*, *n*, *r* being interchangeable, or rather, perhaps, undistinguishable in the languages of Polynesia—one of the Society Islands, about 200 miles to the north-west of Tahiti. It is in lat. 16° 32' S., and long. 151° 52' W., presenting a valuable landmark in a double-peaked mountain of considerable height. It contains about 1800 inhabitants; and it is about 24 miles round, beset by coral-reefs, some of them rising into islets.

BOLA'N PASS, a hollow route ascending in a generally west direction from Sinde, on the Indus, through Beloochistan to Candahar and Ghuzni. Its entrance and its outlet are respectively 800 and 5793 feet above the level of the sea. The total ascent, therefore, is about 5000 feet, which, on a length of barely 55 miles, gives an average of fully 90 feet to the mile. Along the bottom of the pass descends a torrent, which the road generally

follows. The route, without being impracticable, is highly defensible in a military point of view. It is bounded throughout by eminences of at least 500 feet in height; and yet, in 1839, a division of the British army, which invaded Afghanistan, accomplished, with a heavy train of artillery, the whole distance in 6 days. From the outlet of the B. P. there is no fall towards the west, the spacious plateau of the Dasht-i-Bedowlut retaining the level of the upper extremity.

BOLBEC, a well-built town of France, in the department of Seine-Inférieure, about 18 miles north-east of Havre, on the railway between that place and Paris. B. is situated on a stream of the same name, which supplies the water-power for several mills, where woollen, linen, cotton, and chemicals are manufactured. Pop. 8664.

BOLE is the term applied to an earthy mineral resembling clay in structure, and consisting essentially of silica, alumina, and red oxide of iron. It occurs in nests and veins in basalt and other trap rocks, in Scotland, Ireland, France, Armenia, Italy, Saxony, and South America. It feels more or less greasy when placed between the fingers; is of different colours—yellow, red, brown, and black; has a dull resinous lustre, but a shining streak; is readily friable; and often adheres to the tongue when brought in contact therewith. *Armenian B.* has a red tint, is often used for colouring false anchovies, and is also employed in colouring tooth-powders. *Lemnian Earth* is the B. from the island of Lemnos, is red in colour, and was at one time prescribed by medical men as a tonic and astringent medicine; and acted beneficially, no doubt, from the large percentage of oxide of iron present. The boles which are employed in veterinary practice in Europe are generally made from Armenian bole. The savage tribes in South America eat B. to allay the pangs of hunger; and the inhabitants of Java use cakes made of it, under the name of *Tamaampo*, when they wish to become slender. When B. is calcined, it becomes hard; and when afterwards levigated, a coarse red kind is used as a pigment in Germany under the names of *English red* and *Berlin red*. *French B.* is pale-red; *Bohemian B.*, reddish-yellow; *Silesian B.*, pale-yellow; and *Bleis B.* is yellow.

BOLE'RO, a Spanish national dance, mostly in the time of a minuet, with a sharp, marked, and peculiar rhythm. It is accompanied with the castanets and the cithera, and frequently with the voice; and the dancer in the movements seeks to represent the different degrees of feeling from coyness to the highest ecstasies of love.

BOLETUS, a genus of *Fungi* (q. v.), of the division *Hymenomyces*, subdivision *Polypori*. The older botanists included in it the numerous species now forming the genus

Polyporus (see **AMADOU**, **DRY ROT**, and **POLYPORUS**) and other genera; but even as now restricted, it is a very extensive genus. Most of the species resemble the common mushroom and other species of *Agaricus* in form; but instead of gills, the under-side of the cap (*pileus*) is occupied by a layer quite distinct from it in substance, and pierced by pores so as to be composed of a multitude of small tubes united together, on the inside



Boletus edulis.

of which the *spore-cases* or seed-vessels are produced. Some of the species are edible. *B. edulis* is much used in France, also in Germany, Hungary, Russia, &c. It is the *Ceps ordinaire* of the French markets. It grows on the ground in thin woods of oak, chestnut, or beech, and sometimes in mountainous districts, in places covered with moss, heath, or grass. In moist warm summers, it sometimes appears in prodigious quantities. It has also been partially cultivated, by enclosing a portion of a wood, and watering the ground with water in which the plant has been steeped, thus, in fact, sowing its minute seeds or spores. In Britain, it is comparatively rare. The cap is smooth, 6 or 7 inches across, with a thick margin, varying in colour from light-brown to brownish-black; the tubes at first white, then yellow, and finally yellowish-green; the stem thick and solid, beautifully reticulated. The tubes are removed along with the skin and stem, and only the flesh of the cap is eaten, which is firm, white, delicate, of agreeable smell, and is prepared like the common mushroom, dried to flavour sauces, ragouts, &c., or eaten raw with salt and pepper. It is wholesome and nutritious, and this is certainly to be reckoned one of the very best of the edible fungi, and deserves much more attention than it has yet received in Britain.—*B. scaber* is another edible British species, but much inferior.—*B. ceneus* is the *Ceps noir* of the French markets, and *B. aurantiacus* is the *Gyrole rouge* or *Roussile*. They are used like *B. edulis*.

BOLEYN, ANNE, wife of Henry VIII., king of England, was born about the year 1507. Her father was Sir Thomas B., afterwards Viscount Rochford and Earl of Wiltshire; her mother, the daughter of the Duke of Norfolk. In her seventh or eighth year, Anne B. went to France with Mary, sister of Henry VIII., and remained in France after Mary—who had married Louis XII.—returned to England as a widow, under the protection of Queen Claude, wife of Francis I., who was much pleased with her beauty and liveliness. It is not known exactly when she returned to England, but it is certain that she was one of Queen Catherine's maids of honour in 1527, in which year the king appears to have conceived and expressed a passion for her, to which she apparently refused to listen on other condition than that she should become his wife. Henry's religious scruples regarding the lawfulness of his marriage with Catherine, whether he had entertained them before (as is alleged) or not, certainly became much more impatient than they had hitherto been—much too urgent, indeed, for the slow decision of the court of Rome. He, accordingly, without waiting for the award of his Holiness, entered privately into matrimonial relationship with Anne B., in January 1533, or, as some authorities have it, in the November previous. In September 1533, the Princess—afterwards Queen—Elizabeth was born. The new queen, naturally light and gay of heart, and educated at the French court, where these qualities were likely to be developed to the utmost, conducted herself towards the courtiers with an easy familiarity not customary in England for one in her position. Concerning the first two years of her married life, we have little information, only it is known that she was favourable to the Reformation, and promoted a translation of the Bible. In 1535, the affections of the king appear to have become alienated from her. According to some historians, the amorous monarch had already fixed upon a successor to Anne B.; others make out that his passion had nothing to do with her death, and assert that Henry contracted his unseemly hasty marriage with Jane Seymour solely at the request of the peers and privy council. If this

latter statement could be thoroughly relied on, it would no doubt tell strongly against Anne B., as there would then be no apparent motive for Henry seeking her condemnation if she were innocent. Between conflicting historians, one may well hesitate to decide on this point. In February 1536, the queen gave birth to a son, still-born. The king now became more and more estranged from her; and her freedom of manners had given but too good grounds for her enemies to speak evil of her. On the 1st of May, the annual tournament was held at Greenwich, in presence of the king and queen. The tilting had commenced, the challengers being Viscount Rochford, brother to the queen, and Sir Henry Norris, one of the gentlemen of the king's privy chamber. Suddenly the king rose—his outward bearing manifesting inward disturbance—left the tourney, and with a small party rode up to London, leaving the queen at Greenwich. The popular account is, that the king's sudden departure was occasioned by the discovery of a handkerchief belonging to the queen in the possession of Norris; but the necessity for any such romantic and sudden cause of jealousy is obviated by the fact, that, in the previous week, a commission, composed of members of the privy council, had been secretly engaged in examining into charges of adultery against Anne; and two of her alleged accomplices in the crime, Sir William Brereton, a gentleman of the king's household, and Mark Smeton, a musician at court, had been already arrested. The queen remained at Greenwich that night. On the following morning, she was examined before the privy council, under the presidency of the Duke of Norfolk, her uncle, but a bigoted Roman Catholic, and protested her innocence. In the afternoon, however, she was sent up the river to the Tower. Sir Henry Norris, and Sir Francis Weston, another courtier, along with Smeton, were also examined, and all at first declared their innocence of the charge imputed to them; but afterwards the musician confessed to the crime. Norris, too, it is said, made a like confession; but he indignantly repudiated it the next day, on the ground that he had been entrapped into it unwittingly. In the Tower, the queen's every action and word were watched and reported on; but anything she said while a prisoner seems quite as compatible with innocence as guilt, although her words unquestionably prove her to have exhibited a dangerous levity towards the courtiers; for which, however, her French education may be held to account. Her letter to Henry, written on the 6th May, speaks decidedly in her favour. On the 10th May, the grand jury of Middlesex found a 'true bill' on the indictment, which charged the queen with committing adultery with no less than five persons, including her own brother, Lord Rochford, and of conspiring with them, jointly and severally, against the life of the king, the adultery being alleged to extend over a period of nearly three years. On the 11th, the grand jury of Kent found a true bill likewise. On the 12th, the four commoners, Brereton, Weston, Norris, and Smeton, were found guilty, the last confessing to the charge of adultery only, the other three pleading not guilty to both charges. On the 15th, the queen and her brother were tried before twenty-seven peers, the president being the Duke of Norfolk. They affirmed their innocence; but they were found guilty, and condemned, the queen to be burned or beheaded on the Tower green. On the 17th, Smeton was hanged, and the other four beheaded; general protestations of unworthiness by them at the hour of death being regarded by some historians as evidence of particular guilt. On the 19th, the queen was beheaded—having

previously confessed to Cranmer some engagement that rendered her marriage with the king illegal—with her last words praying a blessing on Henry, who, she said, had ever been to her a good and gentle lord, but making no confession of guilt.

It is difficult, if not impossible, to form anything like a just and satisfactory estimate of the character of Anne B.; historians, for the most part, having made her but a lay-figure upon which to hang the drapery of religious partisanship, or to display the colours of individual sympathy. That, with the courtiers, she maintained not that dignity which becomes a queen, but was unguarded in manner, and thoughtlessly free of speech, there can be no question; there is much room to doubt that she was guilty of the heinous offences laid to her charge. A woman who resisted for years the criminal solicitations of the king, was not likely to seduce systematically grooms of the chamber; nor is it at all probable that one so diabolically bad as she must have been, if the charges alleged against her were true, could be so utterly devoid of that cunning necessary to the practice of successful wickedness. Again, it seems scarcely possible that such an extensive system of conspiracy and crime could have been carried on for nearly three years without being noticed by the lynx eyes, and blown upon by the calumnious tongues, of her numerous and powerful enemies, especially if there were truth in the statement in the indictment, that her accomplices were 'very jealous of each other.' On the other hand, it appears monstrous to suppose that seventy noblemen and commoners of England, before whom the case in its various stages came, against most of whom even slander had not a word to say, should have deliberately condemned a queen and five of her associates, and their own, without conclusive evidence. In the absence of the evidence which they had before them, however, it appears to us that the proper verdict for history to pronounce is the intermediate one of *not proven*.

BOLINGBROKE, HENRY ST JOHN, VISCOUNT, born at Battersea, October 1, 1678, was educated at Eton and Oxford, after which he travelled for about two years on the continent, and in 1700, shortly after his return, married the daughter of Sir Henry Winchcomb, from whom, however, he soon separated. Up to this period, he was chiefly notable for his extreme dissipation; but having entered parliament in 1701, he devoted himself to politics, and joining the Tory party, soon made himself prominent as an orator. In 1704, he was made Secretary at War. This office he retained till 1708, when the Whigs came into power, after which he retired from politics, and gave himself up to study, but still retained great influence as the queen's favourite counsellor. On the fall of the Whig party in 1710, he was made Secretary of State for Foreign Affairs. In 1712, he was called to the House of Lords by the title of Viscount Bolingbroke, and in 1713, against the wish of nearly the entire nation, concluded the peace of Utrecht. Having previously quarrelled with his old friend Harley—now Earl of Oxford, and his most powerful rival—he contrived his dismissal in July 1714, and immediately proceeded to form a strong Jacobite ministry, in accordance with the well-known predilections of his royal mistress, whose death, however, a few days after, disconcerted his dangerous and unprincipled schemes. The accession of George I. proved a death-blow to his prospects. On the 28th of August, he was deposed from office; in March 1715, he fled to France; and in August of the same year was attainted. For some time he held the office of Secretary of State to the Pretender; but his

restless and ambitious spirit yearned for the 'large excitement' of English politics. His efforts to obtain a pardon not proving in the meantime successful, he retired to a small estate which he had purchased near Orleans. In 1718, his first wife died, and in 1720 he married the rich widow of the Marquis de Vilette. A judicious use of this lady's wealth enabled him to return to England in September 1724. His property was restored to him, but he was never permitted to take his seat in parliament. He therefore betook himself to his villa at Dawley, near Uxbridge, where he occasionally enjoyed the society of Swift, Pope, and others of his old friends with whom he had corresponded in his exile, and where he diversified his moral and metaphysical studies by his attacks on the ministry in his periodical the *Craftsman*, in which the letters forming his *Dissertation on Parties* first appeared. In 1735, finding his political hopes clouded for ever, he went back to France, in deep chagrin, and continued there till 1742. During this second residence abroad, he wrote his *Letters on the Study of History*, in which he violently attacked the Christian religion. He died, after a long illness, 1751. His talents were brilliant and versatile; his style of writing was polished and eloquent; but the fatal lack of sincerity and honest purpose which characterised him, and the low and unscrupulous ambition which made him scramble for power with a selfish indifference to national security, hindered him from looking wisely and deeply into any question. His philosophical theories are not profound, nor his conclusions solid, while his criticism of passing history is worthless in the extreme. He was one of those clever, unscrupulous men, unhappily too common, who forget that God has something to do with the government of this world as well as themselves, and who, in spite of all their ability, can never see that swift destruction treads, like Nemesis, on the heels of those who dare to trifle with the interests and destinies of a great people. His collected writings were published by Mallet (5 vols., Lond. 1753—1754).

BOLIVAR, SIMON (named *El Libertador*, for having rescued South America from the Spanish yoke), was born at Caracas, July 25, 1783, descended from a noble and wealthy family. Having studied law at Madrid, he travelled extensively on the continent, married, and returned to his native country, where his wife soon after died. On her death, he again visited Europe, and in 1809 the United States, from which he returned with the determination to free his country from foreign despotism. Arriving at Venezuela, he at once associated himself with the patriots there; and after the insurrection of Caracas, April 19, 1810, he was sent to London with a view to interest the British cabinet in their aims. The British government, however, declaring its neutrality, B. speedily returned, and fought under General Miranda in several successful engagements. The Spaniards having again obtained possession of Venezuela, B. had to flee to Curaçoa. He did not, however, remain long inactive. Sympathised with by the republican president of New Granada, he raised a force of volunteers; defeated the Spaniards several times, his army increasing with each victory; and on August 4, 1813, entered Caracas as a conqueror, was hailed as the liberator of Venezuela, and made absolute dictator in all civil and military affairs. After defeating the Spaniards in several engagements, he was himself worsted at the battle of La Puerta, and again in August at San Mateo, where he had a narrow escape. He now went to Carthagena, and afterwards to Kingston, in Jamaica, where an assassin, hired by the Spaniards, tracked his steps,

but, by mistake, murdered his secretary. Having visited Hayti, and assembled there the insurgent refugees, he landed with them on the island of Margarita, December 1816, where he convoked a congress, instituted a government, proclaimed the abolition of slavery, and immediately manumitted his own slaves. The following two years were marked by successes over Morillo. In February 1819, a congress was opened at Angostura, and B., chosen president, was armed with the power of dictator. Having conducted his forces over the almost impassable Cordilleras to New Granada, he achieved the victories of Tunja and Bojaca, and soon afterwards declared New Granada united with Venezuela as a republic, under the name of Colombia. The office of president was conferred upon him. 1822 saw the new republic completely cleared of royalist troops, and B. was summoned the same year to help the Peruvians, and was named dictator of Peru. After two years' fighting, the Spaniards were driven from Peru also.

B. now made a tour through the southern provinces of Peru, where he was hailed with every demonstration of rejoicing. The name of the country was changed in his honour to Bolivia (q. v.), and a million of dollars was given him, which he devoted to the liberation of 1000 slaves. The Bolivian code was adopted by Bolivia in December 1826, and in the following year by the congress of Lima, where B. was made president for life. In the meantime, dissatisfaction prevailed in Colombia, to which he returned, and, notwithstanding some dissent, was confirmed in the presidency in 1826, and again in 1828. About this time a conspiracy threatened his life, but was suppressed by the execution of the leaders and the banishment of seventy accomplices. Meanwhile, his famous code was renounced in Peru, and B. was ejected from the presidency. In 1829, Venezuela separated itself from the republic of Colombia, which was generally disturbed by faction, and B.'s ambition was loudly denounced. B. accordingly laid down his authority in January 1830, notwithstanding earnest entreaties to retain it, and retired, in failing health, to Carthage. The congress of Bogota voted him a pension of 30,000 piastres, and awarded him the thanks of the Colombian people. He died at San Pedro, December 1830, having, shortly before his death, written a farewell address to the people of Colombia, in which he vindicated his character from the aspersions that had been cast on it, and complained bitterly of ingratitude. The war of liberation, and the peculiar elements with which he had to deal, compelled him to assume dictatorial power; but there is no proof that he was ever insincere in his devotion to liberty. His property was mainly devoted to the service of his country. He has been described as the Washington of South America. Like other great men, he was rightly estimated after his death. By a resolution of congress, New Granada, 1842, his ashes were removed with great pomp from Santa Marta to Caracas, where a triumphal arch was erected to his memory.

BOLIVIA, or **UPPER PERU**, a republican state on the west side of South America, deriving the former name from Bolivar (q. v.), and the latter from the fact that it had originally been subject to the Incas. It extends between lat. 12° 10'—25° 30' S., and long. 58°—70° 40' W., touching the Pacific on the S.W., Peru on the W. and N., Brazil on the N. and E., and lastly, the Plate Provinces and Chili on the S.; its area is 374,480 square miles; its population has been estimated, or rather guessed, at 1,650,000, a large majority being aborigines, and the remainder containing a smaller proportion of pure whites than

of mestizoes or half-breeds. B. is officially divided into the departments of La Paz, Potosi, Oruro, Chuquisaca or Sucre, Cochabamba, Beni, Santa Cruz de la Sierra, Tarija, Lamar or Cobiya. Hydrographically, the country may be regarded as unique. Its maritime territory, known, in fact, as the Desert of Atacama, is a sandy waste, which, with the inconsiderable exception of the Loa, does not send a single stream that is worthy of notice into the Pacific. Again, the plateau, chiefly Bolivian, of Titicaca, shut out alike from either ocean, loses its entire drainage in the Lake of Paria. Lastly, the region to the east of the Andes is a cradle at once of the Plata and the Amazon, gathering for the former the Pilcomayo and the Paraguay, and for the latter the Beni, the Mamore, and the Guapai. In each section of B., the hydrography may be said to be a clue to the rain-fall. On the almost riverless shore of the Pacific, the air is nearly as dry as the earth; to the east of the mountains, the trade-wind vapours from the Atlantic are copious enough not only to feed, but to flood the parent-streams of the mightiest rivers on the globe; and within the valley of Titicaca, which has a minimum height of 12,441 feet, the clouds barely supply the comparatively scanty evaporation of so lofty a surface. With regard to temperature, B., almost entirely a tropical region, may claim to embrace all the zones in the world. Difference of longitude is here more powerful in the matter than even difference of latitude, inasmuch as, on every parallel, elevation, to say nothing of changes of moisture, steadily varies up from the level of one sea to perpetual snows, and down again nearly to the level of another. Hence each locality, excepting, of course, the sandy wastes on the Pacific, has its own peculiar vegetation. Even the arid brows of the Andes yield a coarse grass, which forms the favourite food of the guanaca, llama, alpaca, and vicunha—animals almost as independent of water as the camel. Again, the tableland of Titicaca produces abundantly maize, rye, barley, and wheat. Lastly, the eastward slopes, beginning with those gardens of B., the valleys of Chuquisaca and Cochabamba, descend through dense forests of stately timber into the exuberant richness and variety of the plains below. Hitherto, however, B. has been remarkable mainly for its mineral productions. The silver mines of Potosi, after having, on a well-founded estimate, completed the full tale of 2000 millions of dollars, are believed to be inexhaustible; while gold, partly dug and partly washed, has also been obtained chiefly on the Eastern Cordillera, and the torrents rushing from it towards the Atlantic. Moreover, lead, tin, salt, sulphur, nitre, and copper, are known to exist. The foreign trade obviously labours under heavy disadvantages. In the days of Spanish connection, it was almost exclusively carried on—though quite as much by land as by water—along the line of the Plata; but since then, it finds its most convenient channel through the Peruvian marts of Arica and Tacua, for Cobiya, B.'s own single harbour, is separated from the interior by drought and barrenness—difficulties more formidable to commerce than the transit-duties of the neighbouring republic. Soon, perhaps, the external traffic of B. may, with the aid of steam, make for itself highways of the Plata and the Amazon. The imports, confined to articles of the highest value or of the first necessity, are principally iron, hardware, and silks; and the exports, besides the precious metals, are cacao, Jesuits' bark, skins, soap, tobacco, and native manufactures—mostly the work of the aborigines—such as hats of vicunha wool, and cloths of llama and alpaca hair. Since 1824, the epoch of independence, all classes of the population appear to enjoy equal rights—the

revolution having thus been peculiarly a blessing to the Indians, who, mild and abject as they were, had been goaded into a fruitless insurrection towards the close of the 18th c., by that worst form of bondage—serfdom without a master. The executive government is vested in a president; the legislative authority is exercised by a senate, tribunes, and censors. The annual revenue is about 1,700,000 dollars; and the standing army amounts to about 2000 men.

BOLKHOV, an ancient town of Russia, in the government of Orel, about 30 miles north of the city of the same name. B. is situated on the Nougra, is chiefly built of wood, has upwards of twenty churches, besides a monastery and nunnery. Its manufactures consist of gloves, hats, hosiery, leather, &c., and it has a trade in tallow, hemp, hides, and oil. Pop. 17,450.

BOLL, an old dry measure in Scotland, varying in quantity according to locality and the article measured. It is sufficient to say that a B. of oats is equal to six bushels, or six-eighths of an imperial quarter. Although superseded by imperial measures, the B. is still very commonly in use; but, as in the case of all old weights and measures, bargains by it cannot be legally enforced. See **WEIGHTS AND MEASURES**.

BOLLANDISTS, an association or succession of Jesuits by whom the *Acta Sanctorum* (q. v.), or Lives of the Saints of the Christian Church, were collected and published (1643—1794). They received their name from JOHN BOLLAND, born in the Netherlands 1596, died 1665, who, with the help of Gottfried Henschen, edited the first 5 vols., containing the month of January, in 2 vols., published in 1643, and the month of February, in 3 vols., published in 1658. The project had been undertaken by a Flemish Jesuit, Herbert of Rosweyd, and on his death in 1629, his collections were intrusted to Bolland, who established himself in Antwerp, opened a correspondence all over Europe, and associated young men of his order with himself in the work. Several distinguished names are ranked among the B., as Gottfried Henschen (died 1681), Daniel Papebroek (1714), Conrad Janning (1723), Peter Bosch (1736), Suykens (1771), Hubens (1782), Dom Anselmo Berthod (1788), and Jos. Ghesquière (1802). The abolition of the order of Jesuits in 1773 caused the removal of the Bollandist Society to the monastery of Candebeg, in Brussels, till the persecutions under Joseph II. brought about its dissolution. In 1789, the Abbey of Tongerlo, in Brabant, took up the colossal task of carrying on the *Acta Sanctorum*; but scarcely had the 53d vol. appeared in May 1794, when the French occupation put an end to the work. It was not till 1837 that a new Bollandist association of Jesuits was formed, under the patronage of the Belgian government, which set aside a yearly sum of 6000 francs for this object. In 1845 this new society published, in two parts, the 54th vol. of the work, containing, among others, the life of St Theresa, extending to 671 folio pages. Other volumes have since appeared, and more are in preparation, so that there is room to hope that at least the next generation may see the completion of this vast work, of which Gibbon has truly said, that 'through the medium of fable and superstition it communicates much historical and philosophical instruction.' M. Guizot, having ascertained that the 3 vols. for April contain 1472 lives, estimates that the 53 vols., published before the French revolution suspended the progress of the undertaking, contain more than 25,000 lives of saints.

BOLO'GNA, lately a delegation of the Papal States, but now (1860) forming a part of the new Italian kingdom. It was bounded N. and E. by the

delegations of Ferrara and Ravenna, and W. and S. by the duchies of Modena and Tuscany. Area, 1296 square miles; population in 1853, 375,631. Sloping gradually up from the plains of Lombardy in the north, its surface becomes mountainous in the south, which is traversed by offsets from the Apennines. B. is well watered, and the streams are extensively used in the irrigation of rice-fields. It is very productive, yielding corn, wine of middling quality, olive-oil, fruit, vegetables of all kinds, hemp, flax, and saffron. Silk-worms are reared in great numbers. Marble, chalk, and gypsum are the mineral products; hemp, rice, and silk the principal articles of trade.

BOLO'GNA, one of the most ancient cities of Italy, is beautifully situated on a fertile plain at the foot of the lower slopes of the Apennine Mountains, in lat. 44° 30' N., long. 11° 21' E. It is enclosed by a high brick-wall, some five or six miles in extent, but without fortifications; the canal of Reno intersects it, and, on either side, the rivers Reno and Savena sweep past its walls. B. was, next to Rome, the most important city of the Papal States. The streets in the newer parts of the city are spacious and well paved, with rich and varied colonnades, affording shelter alike from sun and rain; in the older portion, the streets are narrow, crooked, and dirty, and the arcades correspondingly low and gloomy. The city is adorned with many fine palaces of the nobility, which are rich in fresco-paintings by the great masters. Pre-eminently worthy of notice is the Piazza Maggiore, 'the Forum of B. in the middle ages,' which includes among other fine buildings, the Palazzo Maggiore del Pubblico, and the Palazzo del Podestà. Among the fine frescoed rooms and galleries of the former, that of the Sala Farnese is the most imposing; the latter is interesting as having been the prison and death-scene, in 1272, of Ennius, the son of the Emperor Frederick II., and also as containing the archives of the city. The great feature of B., however, is its religious edifices, which are remarkable both for the beauty of their architecture, and the abundance and splendour of the art-treasures they contain. It has more than 70 churches, the most remarkable of which are San Stefano, which is rich in relics, ancient tombs, and Madonnas, Lombard architecture, and Greek frescoes of the 11th and 12th centuries; San Petronio—which, though unfinished, is the largest church in B.—a noble specimen of Italian Gothic, with a meridian traced on the floor by the astronomer Cassini, and numerous splendid bas-reliefs by Jacopo della Quercia and Tribolo, as well as master-pieces by other artists both in sculpture and in painting; San Domenico, with works by Michael Angelo and Niccolò di Pisa, and many other eminent sculptors—and paintings and frescoes by Guido, Francia, Lodovico Caracci, Marchesi, Simone da Bologna, Colonna, and others; and the cathedral dedicated to St Peter, also rich in works of art, and interesting historical associations, which, indeed, cluster around all the structures mentioned. In the centre of the city are two remarkable leaning towers, constructed about the beginning of the 12th c.; the tallest, called the Asinella, has a height of 256 feet, with, in 1706, an inclination of 3 feet 2 inches. In 1813, a careful measurement shewed that this inclination had slightly increased. The other tower, the Garisenda—which is alluded to in the 31st canto of Dante's *Inferno*—has an elevation of 130 feet, with a lean of 8 feet. The university of B. is said to date its origin from the 5th c., when it was founded by Theodosius II., and to have been afterwards restored by Charlemagne. It was not, however, until the 12th c., when it was founded anew by Irnerius or Wernerus, that it attained

celebrity. Its reputation during that century was so great, chiefly on account of its school of jurisprudence, that students from all parts of Europe were attracted to it. In 1262, the number receiving instruction is stated to have been 10,000, and it was found necessary to appoint professors specially for the students from each country. The university is also celebrated as the first school for the practice of dissection of the human body, as well as for the fact, that for centuries learned female professors have prelected within its walls. The famous linguist, Cardinal Mezzofanti, was a professor here. Though the number of students is now comparatively small, the university of B. still holds a first place among Italian educational institutions. Medicine is now the principal study. The university library, according to Edwards's *Memoirs of Libraries*, contains 105,000 vols., and 6000 MSS. Many of the books are very rare and valuable. In the church of San Domenico there is a public library of 90,000 vols., accessible on holidays, when all others are closed. The Accademia delle Belle Arte is particularly rich in the works of those native artists who founded the far-famed Bolognese school of painting, and it has also some fine specimens of other schools. Besides being the birthplace of those painters that have made its name illustrious, B. gave to the pontifical chair Honorius II., Lucius II., Gregory XIII., Innocent IX., Gregory XV., and Benedict XIV.

B. has some important manufactures, including silk goods, velvet, crape, wax-candles, musical instruments, chemical products, paper, and sausages almost as celebrated as its paintings. Pop. 78,000.

B. owes its origin, which is said to be much more remote than that of Rome, to the Etruscans, by whom it was called *Felsina*. It afterwards fell into the hands of the Boii, from whom it passed to the Romans, who made it a colony, under the name of *Bononia* (189 B. C.). In 53 A. D., it was nearly destroyed by fire, but was restored by Claudius. After the fall of the Roman empire, it passed into the hands of the Longobards, from whom it was taken by the Franks. Charlemagne made it a free city, and its independence was confirmed by a charter from Henry V., in 1112, which also invested the citizens with the choice of their own judges, consuls, and magistrates. The feuds of the Guelph and Ghibeline factions led to the downfall of the republic, and the supremacy of the papal see, B. being made a delegation in 1513. In 1796, B. was taken by the French, and was constituted the chief town of the Cispadane Republic; and afterwards, when the kingdom of Italy was established, capital of the department Del Reno. It reverted to the pope in 1815. Since that time, B. has made several efforts to throw off the authority of the pope. One, in 1831, was successful, but the papal authority was restored in the following year. In 1848, the Austrians attempted to obtain possession of B., but were repulsed. In the following year, however, they succeeded in capturing the city after a siege of ten days. B. was then, like the rest of the Romagna, declared to be in a state of siege, and was made the head-quarters of the Austrian second Italian corps. From the commencement of the Italian campaign of 1859, the Bolognese gave an active sympathy to the national cause; and long before the peace-negotiations at Zurich had been brought to a close, they had intimated their intention of placing themselves under the rule of Victor Emmanuel, as a part of the new kingdom of Italy. Notwithstanding the menaces of the Vatican, they persisted in their resolve; and when the question of 'Annexation to Piedmont, or separate government,' was submitted to the universal vote of the people, in March 1860, the votes for annexation

exceeded those for separate government in the proportion of 1000 to 1.

BOLOGNA PHIAL, or **PHILOSOPHICAL PHIAL**, is a short, thick, narrow glass vessel, close at one end, and open at the other, which the glass-blower prepares from each pot of metal before employing it in the fashioning of tumblers, glasses, bottles, &c. See **GLASS**. It serves the purpose of enabling the glass-manufacturer to judge of the colour and other conditions of the fused glass or metal; and as the jar is not subjected to annealing, it is very friable, and a small angular fragment of any mineral allowed to drop into it, at once causes it to fly in pieces. It is curious to notice, however, that a B. P. will bear a very heavy blow on the outside without being fractured.

BOLOGNA STONE, an old popular name of a radiated variety of heavy spar or sulphate of barytes (see **BARYTES**), found near Bologna, which is phosphorescent in the dark. It has been also called Bologna Phosphorus; but this name more strictly belongs to it when calcined, pulverised, and made into little cakes with gum-water. These, after being exposed to a vivid sunlight, are very phosphorescent, either in the air or under water.

BO'LOR-TA'GH, a lofty mountain-chain of Central Asia, extending from lat. 35° to 45° N., and from long. 70° to 75° E.; and dividing the Chinese empire on the east from Kunduz and Kafiristan on the west. It forms part of the plateau of Pamir, and is connected with the Thian-sian range and others further north, as well as with the Hindu Kush on the south. Its highest points between 35° and 40° N. are said to have an elevation of more than 19,000 feet. The B. is crossed by three passes—one from Badakshan leads into Little Tibet, and two, west, start respectively from Kashgar and Yarkand.

BOLSENA, a town of the Papal States, in the delegation of Viterho, about 20 miles north-north-west of the town of the same name. It is situated on the north shore of the Lake of Bolsena (*Lacus Volsiniensis*), on the road from Florence by Siena to Rome. It has now less than 2000 inhabitants; but in early ages it was a place of great importance, forming one of the twelve Etruscan cities, under the name of Volsinii. When finally subjugated by the Romans (280 B. C.), as many as 2000 statues are said to have been taken from it; but, though this is doubtless an exaggeration, we may gather from it that the Volscians had achieved a high reputation for wealth and artistic skill. The Romans razed the Etruscan city to the ground, but built another in its place, which, however, is not much celebrated in history, except as the birthplace of Sejanus, the favourite and minister of Tiberius. Pliny records that it was the scene of supernatural occurrences, King Porsenna having here called down fire from heaven to destroy a monster, Volta, that was ravaging the surrounding country. In later ages, according to the traditions of the Roman Catholic Church, a doubting Bohemian priest was here convinced of the truth of the doctrine of transubstantiation, by witnessing the flow of blood from the Host he was consecrating; and in commemoration of this supernatural occurrence, Urban IV. instituted the festival of the Corpus Domini. Raphael has immortalised the incident. No remains of the Etruscan city exist, but many traces of the Roman one remain. The Lake Bolsena is a fine expanse of water, about 10 miles long and 8 broad, but its shores are very unhealthy. The Marta river carries its waters into the Mediterranean. It has two islands, Bisentina and Martana, which were favourite autumnal retreats of Pope

Leo X. Martana is famous as the scene of the exile and murder of the Gothic queen Amalasontha, by her cousin Theodatus.

BOLTON (-LE-MOO'ns), an important English manufacturing town, in South Lancashire, on the Croal, 11 miles north-west of Manchester. It was celebrated as far back as the time of Henry VIII. for its cotton and its woollen manufactures, introduced by Flemish clothiers in the 14th century. Emigrants from France and the Palatinate of the Rhine subsequently introduced new branches of manufacture; and the improvements in cotton-spinning of the middle of the 18th c., rapidly increased the trade of the town. Though B. gave birth to Arkwright and Crompton, the opposition of the working-classes long retarded the adoption, in their native town, of their inventions—the spinning-frame and the mule. B. is now one of the principal seats of the cotton manufacture, and of bleach and dye works in Lancashire. The chief articles manufactured are muslins, fine calicoes, quiltings, counterpanes, dimities, &c. B. has large steam-engine and machine works. The lexicographers Ainsworth and Lempriere were masters of B. grammar-school. During the civil war, the parliament garrisoned Bolton. In 1644, it was stormed by the Earl of Derby, but soon again surrendered; and after the battle of Worcester, that unfortunate nobleman was beheaded there. Pop. 61,171. Since 1832 it has returned two members to parliament. B. parish has upwards of 30 coal-mines. Between B. and Wigan much cannel-coal occurs, and is often made into snuff-boxes, candlesticks, &c.

BOLT-ROPE, in the rigging of a ship, is the rope to which the edges of sails are sewn, to strengthen and prevent them from tearing. It is of three kinds, according to its position—a *leech-rope* up the perpendicular edge of the sail, a *foot-rope* along the bottom edge, and a *head-rope* along the top edge. Some sails, owing to their shape, have no head-rope. All the cordage employed in furling and unfurling the sail is fastened to the bolt-rope.

BOLTS, in ship-building, are usually either of iron or copper; they are employed either for bolting together certain of the timbers, or for fastening any loose body. The B. are of various sizes and shapes, and the heads variously fashioned, according to the services to be rendered. The heads are named 'common,' 'saucer,' 'collar,' 'tee,' 'calking,' 'conical,' &c. The B. vary from half an inch to nearly three inches in diameter, and from a few inches to many feet in length. The lougest are driven through the dead-wood and through the knee of the head; others are used for securing the great guns, the stoppers of the cable, &c.; but the greater number penetrate the timbers of the ship. Some of the smaller are secured at the points by riveting, clinching, or forelocking.

BOLUS (Gr. *bolos*, a clod or lump), a soft mass of any kind of medicine, intended to be swallowed at once; a B. differs from a pill in being larger.

BO'MARSUND. See ALAND ISLANDS.

BOMB, a missile which also receives the names of *bomb-shell* and *shell*. It is a hollow ball, usually of cast iron, fired from a mortar or other large piece of ordnance, and filled with combustibles which work great havoc when the ball bursts by the firing. All such projectiles were formerly fired from mortars only, and there was thus a definite relation between the B. and the mortar; but since the invention of shell-guns, and other modern pieces of artillery, the name *shell* has been generally substituted for that of *bomb*. The 13-inch B., which is the largest size used in ordinary warfare (instances of exceptional

magnitude are noticed under **MORTAR**), weighs about 195 lbs., with a thickness of metal varying from 1½ to 2 inches at different parts; it bursts with about 8 lbs. of powder. The vent through which it is filled with powder is, after the filling, closed with a plug called a *fuse*, which sets fire to the powder, and at the proper moment bursts the B. into fragments. The 10-inch B., weighing about 90 lbs., is proportionably less in all dimensions than that just described; and so on for those of smaller diameters. It should be understood, however, that the above are conventional quantities prescribed and adopted more than half a century ago. Modern artillerymen try experiments on bombs of various degrees of thickness, and various charges and fuses. Some of the results of these experiments, and some of the modern achievements in B.-practice in actual warfare, are noticed under **MORTAR** and **SHELL**.

BO'MBA, a kind of nickname given to Francis II., king of Naples and Sicily, in consequence of his cruel bombardment of Messina, in September 1848, in which the slaughter and the destruction of buildings was immense.

BOMBA'CEÆ. See STERCULIACEÆ.

BO'MBARD, among the now disused engines of war, was a piece of ordnance very short, thick, and wide in the bore. It differed from the *Balista* (q. v.) in being worked with gunpowder instead of by mechanical force; and from the mortar, in shooting forth stones instead of iron shells. Some of the bombards used in the 15th c. propelled stones weighing from 200 to 500 lbs. each.

BOMBARDI'E'R is an artilleryman versed in that department of arms which relates especially to bombs and shells, mortars and howitzers, grenades and fuses. He has learned to load shells and greuaades, fix fuses, prepare composition for fuses and tubes, &c.; and on the field or at sieges, he fires the mortars. In some foreign armies, the Bombardiers form a separate corps; but in the English army, there are some attached to each company, troop, or battery.

BOMBARDI'E'R BEE'TLE, a name common to many species of Coleopterous (q. v.) insects of the genera *Brachinus* and *Aptinus*, of the tribe *Carabidæ* (q. v.). They have received this name in consequence of the remarkable power which they possess of discharging, for their own defence, an extremely acrid volatile fluid from the abdomen, which diffuses around them a pungent odour, and which explodes on coming in contact with the air. The species of the genus *Aptinus* have no membranous wings beneath their elytra; those of the genus *Brachinus* have. Both are found chiefly under stones. The larger and more brilliant species are tropical. Several small species of *Brachinus* are natives of England. The most common English species is only about four lines long. When roughly handled, it will make more than a dozen discharges in rapid succession. When the reservoir which contains the liquid is opened by dissection, it effervesces and evaporates instantaneously. It changes blue vegetable colours to red, and then to yellow; produces sharp pain when applied to the tongue; and leaves a yellow spot upon its surface, like that produced by a drop of nitric acid.

BOMBARDMENT is an attack upon a fortress or fortified town by means of shells, red-hot shot, carcasses, rockets, &c., to burn and destroy the buildings and kill the people. A bombardment is most likely to be successful when the place is destitute of bomb-proof cover; or when the governor is

too humane to expose the unoffending inhabitants to this dreadful ordeal; or when the population is strong enough to compel him to yield. A bombardment requires little engineering science; whereas to reduce a place by regular siege requires the aid of engineers to direct the attack against fortifications, guns, and soldiery, leaving the inhabitants and buildings untouched. Military engineers generally regard a B. as a cruel operation; it is especially directed against the civilians and their buildings, as a means of inducing or compelling the governor to surrender the place, and terminate their miseries. In a well-defended place, the soldiers, the ammunition, and the defence-works suffer comparatively little, seeing that the bombardiers aim at pitching their terrible missiles into the heart of the place. In modern times, a B. is mostly adopted as an adjunct to a siege, distracting the governor by an incessant fire of mortars day and night. At Sebastopol, for instance, the mortars fired shells into the centre of the city, to weaken the defence of the forts which were cannonaded by the siege-guns. B. is more frequently a naval than a military operation. The stores required for a vigorous B. are immense. Thus, in 1759, Rodney threw 20,000 shells and carcasses into Havre; in 1792, the Duke of Saxe-Teschén threw 36,000 shot and shell into Lille in 140 hours; in 1795, Fichegru threw 8000 shells into Mannheim in 16 hours; and in 1807, the English threw 11,000 shot and shell into Copenhagen in 3 days.

BO'MBAX. See SILK-COTTON TREE.

BOMBAY', an island of 8 miles by 3, on the west of Hindustan, having its southern extremity in lat. 18° 57' N., and long. 72° 52' E. It consists of two rocky ridges, which embrace a valley so low as to require embankments against the tide. Its productions, of course, are scanty and unimportant. The rain-fall, with an annual mean of 80 inches, gave, in 1831, 99·64, and in 1838, only 50·78. The temperature, ranging between 70° and 100°, averages, during the year, about 80°. The climate, at one time very unhealthy, has latterly been so much improved by drainage and other appliances, that, in favourable seasons, the proportion of deaths is said very little to exceed that of London. In 1509, about a year before the capture of Goa, the Portuguese visited the island; and by 1530, they had made it their own. In 1661, they ceded it to Charles II. of England, as part of the dowry of his bride, the Infanta Catherine. In 1668, his majesty granted it to the East India Company, which, in 1685, transferred what was then its principal presidency to B. from Surat. The name of the island, though manifestly a corruption of the native *Mambai*, may yet, with reference to the goodness of the harbour, have owed its specific form to the Portuguese *buon bahia*. The bay towards the mainland, even in its natural state, presents one of the finest havens in India, more particularly as being one of the few on the east side of the Arabian Sea which are accessible during the south-west monsoon. Anchoring-ground, of about 50 square miles, available for vessels of any burden, is sheltered on the north by Trombay and Salsette, and on the west by B. itself and its two insular appendages—Old Woman's Isle and Colaba; and lastly, the open passage at the south, which thus makes an entering wind of the monsoon already mentioned, is narrowed on the east by the island of Caranja. Art also has done much to aid nature. The islands on the north and west—all but Trombay, which, in fact, is itself enclosed—are welded into one by three causeways; while, at the south end of this continuous breakwater, the light-house of Colaba, 150 feet high, indicates to

mariners the entrance of the port along a radius of 20 miles.

BOMBAY' (City) occupies the entire breadth of the south end of the island, bordering at once on the harbour inside, and on Back Bay outside. Next to Old Woman's Isle, which, along with Colaba, may be regarded as a suburb, is the regularly fortified European town; about a mile to the north is the much larger Black Town; and between them is the esplanade with the barracks and the railway terminus. The population, sufficiently heterogeneous in its composition, amounted, in 1849, to 566,119.—305,951 Hindus of all classes; 124,155 Mussulmans; 114,698 Parsees; 1132 Jews; 7456 native Christians; 1333 Indo-Britons; 5417 Indo-Portuguese; 5088 Europeans; and 889 Africans. Amid these various classes, the Parsees or Persians, descendants of fire-worshippers driven from their homes by Mohammedan bigotry, rank next to the English, grade for grade, in respectability and influence. The late Sir Jamsetjee Jeejeebhoy, in fact, stands forth, to say nothing of fabulous wealth, as the faultless model of a merchant-prince in enterprise and integrity, in munificence and patriotism; and ever since the introduction of the ship-building business in 1735, the Lowji family, assisted chiefly by operatives of the same race, has been at the very head of this the most important interest of the city—not merely the Indian navy, to be noticed more at large under the next subdivision, but likewise several imperial men-of-war, both frigates and line-of-battle ships, having been almost exclusively the work of Parsees. Besides the dockyard, which covers about 200 acres, at the south-east of the European town, the objects most worthy of note are the fortifications, the town-hall, the Library of the Asiatic Society, the Mint, the Cathedral, and the Custom-house; the Cotton Screws, and the Bombay Inlaid Work; the Missionary Houses, the Elphinstone Institution, and the Grant Medical College; the Jamsetjee Hospital and the Jamsetjee Obstetric Hospital. Always favourably situated for external trade, as a glance at the map will shew, B. has profited more largely than any of its rivals by the re-opening of the ancient thoroughfare through Egypt, not merely as saving more distance in proportion than any other emporium in the East, but also as being placed, with the help of railways and telegraphs, on the direct line between Madras and Calcutta on the one side, and Aden on the other. In 1848, the exports and imports amounted respectively to £3,745,692 and £5,640,189, having more than doubled during the first twelve years after the abolition of monopoly. Nor, since then, has the growth been less rapid. To give a recent instance—scarcely 4 million pounds of cotton-twist were received from England in 1857, a little more than 8 million in 1858, and nearly 15 million in 1859. The principal articles of export are raw cotton, shawls, opium, coffee, pepper, ivory, and gums. The chief imports are piece-goods, thread, twist, yarn, metals, wine, beer, tea, and raw silk, with the best and most durable timber from Malabar and Gujerat.

BOMBAY' (Presidency) has become what it is mainly in the present century. During ninety years, it was confined, with now and then a temporary and insignificant exception, to the island and the two rocky islets on the south. Even the adjacent islands, such as Salsette and Caranja, were acquired only in 1775—the very year in which a younger presidency, after absorbing Bengal, Bahar, and Orissa, annexed Benares. With the exception of the detached territory of Sindé, this presidency, reared principally at the expense of Mahratta dominion, physically divides itself into three parts: the two Concaas, between the

Western Ghauts and the Arabian Sea; the eastward slope of the Western Ghauts; and, to the north of both these divisions, the alluvial tracts towards the mouths of the Taptee and the Nerbudda. Of these three regions, the first, though in a higher latitude than the second, is by far the hottest—its temperature occasionally reaching 115°. The first two differ widely as to rain-fall. In the Concans, the vapours of the south-west monsoon, intercepted by the mountains, recently yielded, at three different places in the same year, 106, 130, and 248 inches; while, almost as a necessary consequence, the eastward slope is generally liable to suffer from droughts even to the extent of producing famines. Without anticipating details, which will be given under the respective districts, it may be stated that B., as a presidency, contains 120,065 square miles, with 11,109,067 inhabitants—Sinde alone yielding 52,120 of the former, with only 1,087,762 of the latter. In 1855—1856, the revenue from all sources amounted to £5,123,425. The administration of the country is vested in a governor and three councillors, subject, however, to the 'superintendence, direction, and control' of the governor-general of India in council. The ecclesiastical establishment, without reckoning the missions of various denominations, consists of several chaplains of the Church of Scotland, and of a bishop of the Church of England, who has under him an archdeacon, with 20 or 30 clergymen. About 300 schools, with upwards of 13,000 scholars, exclusive of the seminaries under the missions, are managed by a board of education—about four-fifths of the institutions, with more than five-sixths of the pupils, using merely the vernacular tongues, and the remainder combining the native languages with English literature and science. In 1851, the local army, besides irregulars, numbered about 34,000. During the mutiny of 1857, this force remained, on the whole, steady and faithful; and it was, in fact, a portion of it which, under Sir Hugh Rose, acted, if not actually the first, at least the second part in the suppression of the insurrection. It is to this presidency that the naval force for all the presidencies belongs. To the island of Bombay, as to Great Britain itself, 'wooden walls' were from the beginning a necessary of life, more especially on waters proverbial for piracy from time immemorial. Accordingly, as early as 1670, a ship-of-war in the local squadron beat off 40 Mahratta vessels. On various subsequent occasions, too, the Company's navy was doing battle for the crown. It assisted in the capture of the Mauritius or Isle of France; it was eminently useful in the expedition against Java; and in the first Chinese war, it was at least as effective as that of her Majesty. While the Company existed, it numbered 229 officers, besides 9 sailing vessels, and 24 steamers of 1440 tons and under. B. seems to take precedence of the other presidencies in manufacturing industry. To say nothing of the marvellous increase, already noticed, in the recent importation of cotton-twist, this presidency, commanding, as it does, the richest cotton-fields of India, is still more recently improving to the utmost its natural advantages, by adding English machinery to its cheap labour and ready material. Two joint-stock companies for spinning as well as weaving have accordingly been established, chiefly by Parsees—the premium on the shares already ranging between 50 and 70 per cent.

BOMBAY ARMY. See EAST INDIA ARMY.

BOMBAY DUCK. See BUMMALOTE.

BOMBAZYNE is a plain fabric of cloth, for dresses, in which the distinguishing characteristic is that the warp is silk and the weft worsted. The cloth has thus a bare look. It is rather fine and

light in the make, and may be of any colour; and is about 24 inches in width. The fabric is now little used. It was extensively made, and chiefly at Norwich, from about 1816.

BOMB-PROOF BUILDINGS are military structures of such immense thickness and strength that bomb-shells and cannon-balls cannot penetrate them. Two of the chief kinds will be found noticed under CASEMATE and MAGAZINE.

BOMB-VESSEL. The various kinds of *B.*, *bomb-ketch*, *mortar-vessel*, and *mortar-boat*, may all be conveniently described under MORTAR-VESSEL.

BOMBYX. See SILK-WORM.

BOMMEL (Dutch, *Zalt-Bommel*), a town in the province of Guelderland, Holland, situated on the Waal, 25 miles east of Dort. The streets are spacious, and the houses having gardens attached to them, the town presents a very pleasant appearance. It has manufactures of nails and iron utensils, tanneries and soap-works, and carries on a considerable trade in agricultural produce. Pop. 3600. B. was formerly an important fortress, but its defences are now destroyed. Its port is also much obstructed by shoals.

BOMMELERWAARD, an island of Holland, in the province of Guelderland, formed by the union of the Waal and the Maas. Its length is about 16 miles, and its greatest breadth about 6 miles. The pop., 15,000, two-thirds of whom are Protestants, are chiefly engaged in agricultural pursuits, flax and hops being cultivated extensively. The town of Bommel, described in the preceding article, is situated in B., which contains about seventeen villages besides. Fort St André defends it on the east, and Fort Loeventin on the west.

BONA, a seaport town of Algeria, in the province of Constantine, situated on a bay of the Mediterranean, in lat. 36° 54' N., long. 7° 46' E., and known among the Arabs by the name of Beled-el-Areb. The town, divided into two parts, Upper and Lower B., is situated in a beautiful, but unhealthy district, at the foot of a hill near the embouchure of the Sebus; is surrounded by walls flanked with square towers, and further defended by Fort Cigogne, which is built on the top of the hill. Pop. about 12,000, one-third of whom are natives. Since the occupation of B. by the French in 1832, the town has been much improved, and has now good bazaars, shops, markets, reading-rooms, &c.; manufactures of tapestry, saddlery, and native clothing, and a trade in wool, hides, corn, coral, and wax. B. has regular steam-communication with France, Algiers, and Tunis. Among the public buildings, the Catholic church, and the convent of the Sisters of Mercy, are most remarkable. Near B. are some scanty remains of the once famous city Hippo Regius, the favourite residence of the Numidian kings, and the episcopal seat of St Augustine, who died here in 430. This city was probably connected with the ancient *Aphrodissium* (the present Bona) by a canal, of which the outline may still be seen in a morass. Hippo Regius, in early Christian times, was the central station of commerce and civilisation in North Africa, and was celebrated for its schools, theatre, aqueducts, palaces, and temples, afterwards changed into churches and monasteries. It was totally destroyed by the Mohammedans under the Calif Osman in 646.

BONA itself, a Latin vocable, literally signifying 'goods,' and often used in pleading, and otherwise technically to designate personal estate, has several applications in the law of England, of which the following are instances: *Bona Confiscata* are forfeitures of lands and goods for offences, and form a branch of the ordinary revenue of the crown.—*Bona Notabilia*

are chattels to the value of 100 shillings, or personal estate of £5 or upwards, excepting in London, where the sum is £10. Where such small estate was in different dioceses or jurisdictions, it was to be proved in the prerogative court of the archbishop of the province; and so late as the year 1847, an act of parliament was passed (10 and 11 Vict. c. 98), by the 4th section of which it is enacted that the law of bona notabilia should be continued unaltered. But now, by the 20 and 21 Vict. c. 77, amended by the 21 and 22 Vict. c. 95, the whole jurisdiction and authority in relation to granting administration is exercised by the new Court of Probate.—*Bona Vacantia*, or stray goods—such as wrecks, treasure-trove, waifs, and estrays, contrary to the general rule, which gives such things to the finder—vest in the crown.—*Bona Wariata* are also given to the crown. They consist of goods waived or thrown away by a thief in his flight, for fear of being apprehended.

BONA DE'A (the good goddess), a mysterious Roman divinity, who is variously described as the wife, sister, or daughter of Faunus. She was worshipped at Rome from the most ancient times, but only by women, even her name being concealed from men. Her sanctuary was a grotto on Mons Aventinus, which had been consecrated to her by the virgin Claudia; her festival, however (the 1st of May), was not celebrated there, but in the house of the consul, inasmuch as the sacrifices were then offered up for the whole Roman nation. The solemnities were performed generally by aristocratic vestals. At this celebration, no males were allowed to be present; even portraits of men were veiled. The wine consumed was called milk, in order that its name might not be discovered, and the vessel in which it was served *Mellarium*. The symbol of the goddess was a serpent, indicating her healing powers, and certain herbs were sold in her temple.

BONA FIDÉS, a Latin expression literally signifying good faith, enters largely into the consideration of legal questions, particularly matters of agreement, contract, damage, trusts, and other departments of the law; and in all of them it implies the absence of fraud, or unfair dealing or acting. This term, however, does not appear to occupy any formal or technical place in the law of England. It is the foundation of many just and enlightened maxims in the Roman jurisprudence, which in this respect, as in many others, has been followed by the legal system of Scotland. In the law of that country, a person who possesses and enjoys property upon a title which he honestly believes to be good, although it may be bad, is protected against the consequences of this illegal position by his *B. F.* and he is entitled to retain the fruits or profits which he has reaped or received during his *bona-fide* occupancy. But such *B. F.* ends when the possessor becomes aware of the insufficiency of his title, whether by private knowledge or otherwise. In the Scotch law, again, while *B. F.* gives no support to the parties, or either of them, in a second marriage, the first subsisting, it would, it is thought, have the effect of rendering the children of such second marriage—that is, children born while the *B. F.* continues—*legitimate*. The reason of this is, that legitimacy in Scotland is not the result merely of a lawful marriage, but may be otherwise acquired; and no offence against the laws being intended by one or both of the parties, it is inexpedient to impose bastardy on the issue. The contract itself is null, because, otherwise, a sanction would be given to bigamy. But the contract having been entered

into *in bona fide*, the law considers that it ought to attribute to it all the effects of a valid marriage; and such appears to have been the Scotch law from very ancient times. The law of England is not so indulgent, for there, children born under such circumstances would certainly be deemed bastards. See **BASTARDS, BASTARDY**; and see on the subject of this article generally, **CONTRACT, DAMAGE, MARRIAGE, GUARDIAN, EXECUTOR, TRUSTEE**.

The interpretation of the term *Bona Fide Traveller* has recently given no little trouble to the magistrates of Scotland in reference to the famous 'Forbes Mackenzie Act' (q. v.).

BONALD, LOUIS GABRIEL AMBROISE, VICOMTE DE, a celebrated publicist, was born in 1753 at Monna, near Milhau, in Aveyron. Compelled to emigrate during the French Revolution, he joined the emigrant corps, and, when it was dissolved, removed to Heidelberg, where he employed his pen in the composition of politico-philosophic works on behalf of monarchy. His first important work, *Théorie du Pouvoir Politique et Religieux* (3 vols., 1796), was seized by the Directory. It prophesied the restoration of the Bourbons. Having returned to France, B. was induced to accept the patronage of the Bonaparte family, and in 1808 was appointed Minister of Instruction. In 1815—as deputy for his department—he voted with the ultra-montane or theocratic party in the *Chambre Introuvable* (q. v.), and was one of the most influential members of the Chamber of Deputies in abolishing the revolutionary law of divorce, against which he had written in 1806; in opposing all projects of electoral reform, the alienation of forests, the efforts to get rid of the Swiss mercenaries, the freedom of the press, &c. In 1823, he was elevated to the peerage by Louis XVIII. The July revolution brought his public career to a close, as he refused to take the oath of allegiance to the new dynasty. He died at Monna, 1840. His most important writings are: *Législation Primitive* (3 vols., Par. 1802), and *Recherches Philosophiques sur les Premiers Objets des Connaissances Morales* (2 vols., Par. 1818), which have been immensely applauded by his own party. Their non-agreement with the fundamental facts of history has been proved by impartial criticism. His florid and incorrect style is often detrimental to his logic; and even his admirers must admit that his faith in papal infallibility, and his veneration of the Jesuits, were carried beyond all reasonable bounds. A complete edition of his works, in 12 vols., was published under his own supervision (Par. 1817—1819).—His son, **LOUIS JACQUES MAURICE B.**, Archbishop of Lyon, 1839, made a cardinal in 1842, has faithfully adhered to his father's political and religious principles.

BONAPARTE (pron. in Ital. in four syllables; in Eng., usually in three), **FAMILY OF**. In the 13th c., and afterwards, several families named B. appear in Italian records—at Florence, San Miniato, Sarzano, and Genoa; and towards the close of the 15th c., a branch of the Genoese B. family settled at Ajaccio, in Corsica, where they occupied a respectable position as patricians, *padre del commune* or *cittadini*, in the middle of the 16th century. In the 18th c., this family was represented by three male descendants, all residing at Ajaccio: the archdeacon, Lucien B.; his brother, Napoleon B.; and their nephew, Charles.—**CHARLES BONAPARTE**, father of the Emperor Napoleon, was born March 29, 1746; studied law at Pisa; and married in 1767—without the consent of his uncles—a beautiful young patrician, named Letizia Ramolino. In 1768, he removed with his family, accompanied by his uncle Napoleon, to Corte, in order to assist

General Paoli in defending the island against the French invasion. As the French prevailed, and further resistance was useless, Charles B. attached himself to the French interest, and in 1771 was included by Louis XV. in the election of 400 Corsican families to form a nobility. In 1773, through the influence of Marboeuf, governor of Corsica, Charles B. was appointed royal counsellor and assessor of the town and province of Ajaccio. In 1777, he was a member of the deputation of Corsican nobles to the court of France. In this capacity he resided for some time in Paris, where he gained for his son Napoleon, through the interest of Count Marboeuf, a free admission into the Military School at Brienne. In 1779, he returned to Corsica, and in 1785 went to Montpellier, for the benefit of his health, where he died of cancer in the stomach, February 24, 1785. He was a man of prepossessing exterior and amiable character. By his marriage with Letizia, he left eight children: Joseph B., king of Spain; Napoleon (q. v.), Emperor of the French; Lucien B., Prince of Canino; Maria Anna (afterwards named Elise), Princess of Lucca and Piombino, wife of Prince Bacciocchi; Louis B., king of Holland; Carlotta (afterwards named Marie Pauline), Princess Borghese; Annunziata (afterwards named Caroline), wife of Murat, king of Naples; Jerome B., king of Westphalia. These members of the B. family, with the children of Beauharnais (q. v.), adopted by the Emperor Napoleon when he married Josephine, are distinguished as the *Napoleonidae* of modern French history. By a decree of the senate, November 6, 1804, the right of succession to the throne was restricted to Napoleon and his brothers Joseph and Louis, with their offspring. Lucien and Jerome were excluded on account of their unequal marriages. Napoleon intended to give the right of succession also to Lucien, by the additional act of April 22, 1815; but this was never concluded. As Joseph, the eldest brother of the emperor, had no son, the descendants of Louis became nearest heirs to the throne.—MARIA LETIZIA RAMOLINO, mother of Napoleon I., lived to see her family placed on the thrones of Europe, and also witnessed their downfall. She was born at Ajaccio, August 24, 1750. After the death of her husband, she lived for some time in Corsica, and in 1793, when the island came under British rule, removed with her family to Marseille, where she lived in poverty, mainly supported by the pension given to Corsican refugees. After her son became First Consul, she removed to Paris, and when her son was crowned in 1804, received the title *Madame Mère*. A brilliant court-household was given to her, which, however, was never pleasing to her modest tastes. Remembering former adversities, and foreboding reverses of the splendid success of her sons, she was prepared for all that followed. After the downfall of Napoleon, Letizia lived with her step-brother, Cardinal Fesch, in winter at Rome, and in summer at Albano, and submitted to her change of fortune with remarkable dignity. She died February 2, 1836, leaving a considerable property, the result of saving habits during prosperity.

BONAPARTE, JOSEPH, eldest brother of Napoleon, was born at Corte, in Corsica, January 7, 1768, and was educated at Autun. On the death of his father, he returned to Corsica, exerted himself to support the younger members of the family, and removed with them to Marseille in 1793. In 1797 he was elected a member of the Council of Five Hundred, and in the same year was sent as ambassador from the republic to Rome. In 1800, after he had proved his ability in several offices of state, he was chosen by the First Consul as plenipotentiary to conclude a treaty of friendship with the United States of North

America. He signed the treaty of peace at Luneville, February 9, 1801, and that of Amiens, 1802; and with Cretet and Bernier conducted the negotiations relative to the *concordat*. After the coronation of Napoleon, new honours fell to the share of Joseph B., who was made commander-in-chief of the army of Naples; in 1805, ruler of the Two Sicilies; and in 1806, king of Naples. Though, during his reign, some beneficial changes of government were effected—such as the abolition of feudalism, the suppression of convents, the formation of roads, the repression of banditti, the organisation of laws, &c.—yet these reforms were not managed judiciously; and the collision that frequently occurred between his own humane endeavours and the reckless promptings of his imperial brother, who looked upon Naples simply as a province of the French empire, exposed only too well to the Neapolitans the weakness and dependence of their new sovereign. But, in truth, he was far too fond of the fine arts to be a vigorous ruler in stormy times; and he is accused of leaving affairs too much in the hands of his minister, the subtle Salicetti. In 1808, Joseph B. was summarily transferred by his brother to the throne of Spain, and Murat took his place as king of Naples. For Joseph, this was no favourable change: he found himself unprepared to cope with the Spanish insurgents, and after the defeat of the French at Vittoria, he returned to his estate at Morfontaine, in France. In 1813, when Napoleon recognised Ferdinand VII. as king of Spain, Joseph B. refused, at first, to abdicate, though he had many times before implored his brother to release him from his royal chains; but he soon submitted, as in all other matters, to the Emperor's will.

After the battle of Waterloo, he accompanied Napoleon to Rochefort, whence they intended to sail separately for North America. In his last interview with Napoleon, Joseph generously offered to give up the vessel hired for his own escape, but meanwhile Napoleon had determined to surrender himself into the hands of the English. After a residence of some years at Point-Breeze, in New Jersey, United States, where he employed himself in agriculture, and was highly esteemed by his neighbours, Joseph B. came to England in 1832, having previously, on hearing of the July revolution, written a letter to the House of Deputies, in which he advocated the claims of his nephew, the present Emperor of France, and in 1841 was allowed to return to his wife, who had remained in Italy since 1815. He died in Florence, July 28, 1844. Joseph was the only one of his brothers for whom Napoleon professed to care anything. He was a handsome, intelligent-looking man, distinguished by the elegance of his manners and conversation. His wife, JULIE MARIE CLARY, born December 26, 1777, was the daughter of a wealthy citizen of Marseille, and the sister-in-law of Bernadotte, king of Sweden. She was a quiet unambitious woman, with no taste for the splendours of royalty, which fell to her share during a few weeks only at Naples, for she never went to Spain. Ill health appears to have prevented her accompanying her husband to America. She died in Florence, April 7, 1845. By her marriage with Joseph B., she had two daughters—1. Zenaïde Charlotte Julie, born July 8, 1801, who became the wife of Lucien B.'s son, the Prince of Canino; 2. Charlotte Napoléone, born October 31, 1802, died March 3, 1839, who married Louis Napoleon, second son of Louis B., king of Holland. Her husband died March 17, 1831.

BONAPARTE, LUCIEN, Prince of Canino, and brother of Napoleon, was born at Ajaccio in 1775, and received his education in the college of Autun, the military school at Brienne, and the seminary at Aix.

BONAPARTE.

Rising gradually from one office to another, he was elected deputy for the department Liamone, and in the Council of Five Hundred, spoke against the squandering of state-property, and formed a party favourable to the views of his brother Napoleon. Shortly before the 18th Brumaire, he was elected president of the Council of Five Hundred, and was the hero of that day. During the ferment which followed Napoleon's entrance, Lucien left his seat, mounted his horse, and riding through the ranks of the assembled troops, called upon them to rescue their general from assassins. Afterwards appointed Minister of the Interior, he was active in the encouragement of education, art, and science, and organised the prefectures. As ambassador to Madrid, 1800, he contrived to gain the confidence of King Charles IV. and his favourite Godoy, thus putting aside the British influence which had until then been exercised at the court of Spain. It is said that for his services in the treaty of peace concluded between Spain and Portugal, September 29, 1801, he received 5,000,000 francs.

His constant opposition to Napoleon's progress towards monarchy involved Lucien in several misunderstandings with his brother; and their quarrel was brought to an issue by Lucien's second marriage against the views of Napoleon. On condition that he would divorce his wife, the crowns of Italy and Spain were offered to Lucien; but he refused them, and preferred living in retirement at his estate of Canino, in the province of Viterbo, near the frontiers of Tuscany, where he devoted his time to art and science. Here he enjoyed the friendship of the pope, who created him Prince of Canino and Musignano; but having denounced in his private capacity the arrogant and cruel policy of his brother towards the court of Rome, he was 'advised' to leave the city in which he was at that period residing. In 1810, he took ship for America, but fell into the hands of the English; was brought to England; and after a debate in parliament, was declared to be a prisoner, but treated with distinction. After his brother's downfall, he returned to Rome.

After the defeat at Waterloo, Lucien B. alone seems to have preserved his presence of mind. He immediately advised his brother to dissolve the chambers, and assume the place of absolute dictator. After the second ascent of the throne by Louis XVIII., Lucien lived for some time in and near Rome. In 1830, he went to England, visited Germany in 1838, and died at Viterbo, June 30, 1840. Lucien B. possessed considerable talents and firmness of character. He was in his early years a keen republican, but the weakness of the Directory convinced him that a military consulship was necessary to allay the social anarchy of France. He consequently threw himself eagerly into the designs of his brother, but protested against Napoleon giving way to his desire for a hereditary monarchy. As a writer, he was by no means successful. His long and tedious epic poem, *Charlemagne ou l'Eglise Délivrée*, in 24 cantos, was written and published in London, and was dedicated to the pope, 1814. Another heroic poem, *La Cyméide ou la Corse Sauvée*, followed in 1819. The *Mémoires Secrets sur la Vie Privée Politique et Littéraire de Lucien B.* (2 vols. Lond. 1819), of which Alphonse de Beauchamp is supposed to be the author, is an untrustworthy book. Lucien B. was the father of a numerous family. In 1795, he married Christine Boyer, the daughter of a private citizen of St Maximin. After her death, he concluded, in 1803, a second marriage with the widow of a stockbroker, Madame Joubertou, who was his survivor. By his first marriage, he had one daughter, Charlotte, born May 13, 1796, who married Prince Gabrielli of Rome. By his second marriage,

Lucien had nine children: the eldest daughter, **LETIZIA B.**, born December 1, 1804, married, in 1824, Thomas Wyse, Esq., an Irish gentleman, afterwards ambassador at the court of Athens; but a separation took place in the course of a few years.—The second daughter, **JEANNE B.**, distinguished by her beauty and taste for poetry, was born July 22, 1806, and died soon after her marriage with the Marchese Honorati.—The third daughter, **ALEXANDRINE MARIE B.**, born October 12, 1818, married in 1836 Count Vincenzo Valentini de Canino, and gave birth to two sons and one daughter.—**CONSTANZE**, the youngest daughter of Lucien B., born January 30, 1823, was living recently in a convent at Rome.—**CHARLES LUCIEN JULES LAURENT B.** (eldest son of Lucien B.), Prince of Canino and Musignano, was born at Paris, May 24, 1803. He never exhibited any inclination for political life, preferring the more quiet and wholesome pursuits of literature and science. He acquired a considerable reputation as a naturalist, and especially as a writer on ornithology. He died 29th July 1857. He was a member of the principal academies of Europe and America. His chief publications are a continuation of Wilson's *Ornithology of America*, and the *Iconografia della Fauna Italica*.—The second son, **PAUL MARIE B.**, born in 1806, took a part in the Greek war of liberation, and died by the accidental discharge of a pistol, 1827.—The third son, **LOUIS LUCIEN B.**, born January 4, 1813, has distinguished himself by his studies in chemistry, mineralogy, and languages. He was returned to the National Assembly in 1849. He has since been appointed a member of the imperial senate.—**PIERRE NAPOLEON B.**, the fourth son, born September 12, 1815, proved himself an energetic character, and passed through many changes of fortune in America, Italy, and Belgium, returning to France after the catastrophe of 1848.—The youngest son, **ANTOINE B.**, born October 31, 1816, fled to America after an affair with the pope's gendarmierie in 1836, and returned to France in 1848, where he was elected into the National Assembly, September 1849.

BONAPARTE, LOUIS, third brother of Napoleon, was born September 2, 1778, and was educated in the artillery school at Chalons, where he imbibed anti-republican principles. After rising from one honour to another, he was made king of Holland, 1806; but, in fact, he was never more than a French governor of Holland, subordinate to the will of his brother. Amid all the faults which marked his reign, it must be remembered to his advantage that on several occasions he firmly withstood the demands of France; that he replied to one requisition by saying that, since he had been placed on the throne of Holland, he had 'become a Dutchman;' that he nobly refused to accept the tendered crown of Spain; and lastly, that he did not enrich himself during his reign. After the restoration of the House of Orange, Louis considered himself free from all responsibility, and returned to Paris, January 1, 1814, where he was coldly received by the emperor. After living for some years in Rome—where he separated from his wife—he removed in 1826 to Florence, where he lived in retirement. On the escape of his son, Louis Napoleon, from the prison of Ham, the ex-king of Holland was removed as an invalid to Livorno, where he died, July 15, 1846. Louis B. was the writer of several works: *Marie, ou les Hollandaises*, 1814, a novel, giving some sketches of Dutch manners; *Documents Historiques, &c., sur le Gouvernement de la Hollande* (3 vols., Lond. 1821); *Histoire du Parlement Anglais*, 1820; and a critique on M. de Norvins's *History of Napoleon*. Louis B. was married in 1802 to Hortense Beauharnais, daughter of General Beauharnais (q. v.) by his wife

Josephine, afterwards Empress of the French. As this marriage was wholly a matter of submission to his brother's will, and put aside a former engagement, it naturally ended in unhappiness and separation.

The amiable and accomplished HORTENSE EUGENIE BEAUHARNAIS, the adopted daughter of Napoleon, queen of Holland, and Countess St Leu, was born in Paris, April 10, 1783. After the execution of her father, she lived for some time in humble circumstances, until Napoleon's marriage with Josephine. In obedience to the plans of her step-father, she rejected her intended husband, General Desaix, and married Louis B. in 1802. In 1814, she was the only one of all the *Napoleonides* who remained in Paris. After the Hundred Days, she visited Augsburg and Italy, and then fixed her residence at Arenenberg, a mansion in the canton Thurgau, where she lived in retirement, sometimes spending a winter in Italy. In 1831, when her two sons had implicated themselves in the Italian insurrection, the countess travelled in search of them through many dangers, and found the elder deceased, and the younger—now Emperor of the French—ill at a place near Ancona. Returning with her son to Paris, she was pleasantly received by Louis Philippe and by Casimir Périer, but was obliged, in the course of a few weeks, to remove with her son to England. After some stay here, she removed to her country-seat, Arenenberg, where she died, after severe suffering, October 3, 1837, and was buried near the remains of her mother, Josephine, at Ruel, near Paris. She was the authoress of *La Reine Hortense en Italie, en France, et en Angleterre, pendant l'année 1831*, and wrote several excellent songs. She likewise composed some deservedly popular airs; among others the well-known *Partant pour la Syrie*, which the present Emperor of the French, with a delicate union of political tact and filial pride, has made the national air of France. Of her three sons, the eldest, NAPOLEON LOUIS CHARLES, born 1803, died in childhood, March 5, 1807. The second, LOUIS NAPOLEON, born 1804, crown-prince of Holland, married his cousin Charlotte, daughter of Joseph B., and died at Forli, March 17, 1831. The third, CHARLES LOUIS NAPOLEON, is now Emperor of the French. See LOUIS NAPOLEON.

BONAPARTE, JEROME, youngest brother of Napoleon, was born at Ajaccio, November 15, 1784. After receiving his education in the college at Jully, he served as naval lieutenant in the expedition to Hayti. When war broke out between France and England in 1803, Jerome was cruising off the West Indies, but he was soon compelled to take refuge in the port of New York. While in America, he married Elisabeth Patterson, daughter of a merchant in Baltimore, December 27, 1803. Subsequently, he was employed by Napoleon in the liberation of Genoese prisoners who had been captured by the Dey of Algiers. In the war with Prussia, he commanded, in concert with General Vandamme, the tenth corps in Silesia, and on the 1st December 1807, was made king of Westphalia. He was recognised with great pomp at Cassel, where he lived in splendour, caring very little for government, not even taking the pains to acquire the vernacular language of the country. After the war with Austria, the finances of Westphalia, through mismanagement, plunder, and extravagance, as well as war-expenditure, were found in an exhausted condition. The battle of Leipsic brought the reign of Jerome to a close. After the peace of 1814, he left France, and resided in Switzerland, at Grätz, and in the beginning of 1815, at Trieste. He was made a peer when Napoleon returned from Elba, and fought by the side of the Emperor at Ligny and

at Waterloo. After his brother's abdication, he left Paris, June 27, and visited Switzerland and Austria, but ultimately settled in Florence. His request to be allowed to return to France was rejected in 1847, by the Chamber of Peers, but was afterwards granted, and at the outbreak of the February revolution, Jerome B. was in Paris, where he was appointed Governor of the Invalides, December 23, 1848; and in 1850, was made a French marshal.

His marriage with Elisabeth Patterson having been declared null by Napoleon, Jerome was forced, after he had gained the Westphalian crown, to marry Sophia Dorothea, daughter of King Frederick I. of Würtemberg. After the battle of Waterloo, her father wished to annul the marriage; but the wife of Jerome declared her resolution to share through life the fortunes of her husband. Jerome B. left in America one son by his first marriage, and had three children by his second wife—JEROME B., the elder son, born August 24, 1814, died May 12, 1847; MATHILDE JETTIA WILHELMINE B., Princess of Montfort, born at Trieste, May 27, 1820, married the Russian Count Anatol Demidov, and lived with her husband at the court of Louis Napoleon during his presidency. The younger son, NAPOLEON JOSEPH CHARLES PAUL B., born at Trieste, September 9, 1822, passed his youth in Italy; entered the military service of Würtemberg, 1837; afterwards travelled in several countries of Europe; and was banished from France, 1845, on account of his intercourse with the republican party. He returned to Paris with his father, 1847, and after February 1848, was elected into the Legislative National Assembly. Here he advocated democracy, so as to offend his cousin, the president, who sent him, in 1849, as envoy to Madrid; but immediately recalled him, as, on the journey, young Napoleon had the imprudence to declaim loudly at Bordeaux against the reactionary measures of the government. Napoleon B. is generally regarded as a believer in communism. In his personal appearance, he is said to bear a striking resemblance to his uncle, the Emperor Napoleon.

BONASIA, a genus of gallinaceous birds of the Grouse (q. v.) family or *Tetraonidae*, perhaps more properly only a sub-genus of Grouse (*Tetrao*), distinguished by having the toes and the lower part of the tarsus (or shank) destitute of feathers; also by the elongated feathers of the upper part of the head. To this genus belongs the Hazel Grouse of the continent of Europe (*Tetrao Bonasia* of Linnæus), a species which, although not found in Britain, is very widely distributed from Siberia to Africa, and throughout that continent. In size, it scarcely exceeds the common partridge, is prettily mottled with gray and reddish brown, and has a black band near the extremity of the lateral tail-feathers. It loves the deepest solitudes of forests. The eggs are 12—18 in number. The flesh of this bird is highly prized, and German etiquette has long assigned it a place above all other dishes at the tables of princes, as the only dish which may be served twice in succession.—Another species of B. is the Ruffed Grouse of America (*B. Umbellus*, or *Tetrao Umbellus*), known also in some parts of the United States by the names of Pheasant and Partridge. It is nearly equal in size to the black-cock of Europe. Besides having the feathers of the upper part of the head elongated, the male has a large shoulder-tuft on each side. This bird is found in almost all parts of North America, from the Gulf of Mexico to Hudson's Bay, and from the Atlantic to the Pacific Ocean. It is polygamous, and in spring the males make a noise called *drumming*, by rapid clapping of their wings, to attract the attention of the other sex, whilst they

also strut with erected ruff and tail, and with wings depressed, after the manner of the turkey-cock. At this time they have fierce battles with one another; and advantage is sometimes taken of their jealous pugnacity to attract them within shot, by an imitation of their drumming, accomplished by means of a bladder and a stick. The nest is formed on the ground in the woods, often under a bush, and 5—12 eggs are laid in it. The flesh of the Ruffed Grouse is much esteemed, and the markets of the American cities and towns are well supplied with it in the winter months.—It seems probable that both these species of *B.* might be easily introduced into Britain, and they would be very desirable additions to the game of woods and plantations.

BONASUS, or **BONA'SSUS**. See **BISON**.

BONAVENTURA, Sr, one of the most eminent Catholic theologians, whose real name was John of Fidanza, was born in 1221 at Bagnorea, in Tuscany. In 1248, he became a Franciscan monk; in 1253, a theological teacher at Paris, where he had studied; and in 1256, general of his order, which he governed strictly, but affectionately. The influence of his character now began to penetrate the church; and it was mainly through his eloquent persuasion that the differences which had sprung up among the cardinals on the death of Clement IV. in 1268 were reconciled, and all induced to unite in electing to the papal dignity Tedaldus Visconti (Gregory X.). The new pope created B. Bishop of Albano, and cardinal in 1273, when he accompanied Gregory to the Council of Lyon, where he died, July 15, 1274, from sheer ascetic exhaustion. He was honoured with a splendid funeral, which was attended by the pope, the king, and all the cardinals.

On account of his unspotted character from earliest youth, as well as the miracles ascribed to him, he enjoyed, even during his lifetime, especial veneration. Dante, who wrote shortly after, places him among the saints of his Paradise; in 1482, he was formally canonised by Sixtus IV.; and in 1587, was ranked by Sixtus V. as the sixth of the great doctors of the church. The religious fervour of his style procured for him the title of *Doctor Seraphicus*, and his own order are as proud of him as the Dominicans are of Thomas Aquinas. A great part of his writings is devoted to the praise of his order, and to the defence of Mariolatry, celibacy, transubstantiation, communion in one kind, and other doctrines and practices of the middle ages, which he attempts to deal with in a philosophical manner. His most important works, the *Breviloquium* and *Centiloquium*, are properly text-books on dogmatics. Unfortunately, his efforts to philosophise the church creed, and that deep mysticism in which his spirit revelled, make him often obscure and unintelligible even in his most popular treatises. With *B.*, theology is the goal of all art and science; and in his *Itinerarium Mentis in Deum*, as also in his *Reductio Artium in Theologiam*, he represents union with God, to which the soul attains through six stages, as the highest good. He did more than any other of the early theologians to give a scientific form to the mystical theology. His *Biblia Pauperum*, or 'Poor Man's Bible,' is a mystico-allegoric explanation of the plain contents of the sacred books for the benefit of the laity. In warmth of religious feeling, however, and in the practical tendency of his ethics, he far excels the hair-splitting scholastics. In his commentary on the *Sententie* of Peter the Lombard, he acutely argued against the eternity of the world, and also advanced some original proofs of the immortality of the soul. The most complete edition of his works appeared at Rome (8 vols. 1588—1596).

BONA VISTA, a bay and cape on the east coast of Newfoundland, in lat. 48° 42' N., and long. 53° 8' W.

BONCHAMP, CHARLES MELCHIOR ARTHUR MARQUIS DE, one of the bravest leaders of the Vendean party in the civil war consequent upon the French Revolution, was born at Jouverdeil, in the old province of Anjou, May 10, 1760; took part, like many young French officers, in the American war of liberation; and when he returned to France, was made captain. Of strong royalist principles, he looked with disfavour on the revolution. After living for some eighteen months in solitude, he allowed himself to be chosen leader of the Anjou insurgents. The army of La Vendée would have been more formidable if B.'s tactics had been adopted, but this was not done until it was too late. In the sanguinary encounter at Chollet, October 17, 1793, B. received a fatal shot in the breast, and when his followers vowed to revenge his death on 5000 republican prisoners, the dying hero exclaimed: 'Spare your prisoners. I command it.' This last command was obeyed.

BOND, in Masonry, is the connection established among the stones or bricks in a wall, by disposing them so as to overlap one another. See **BRICK-LAYING**.

BOND, in Law, is an instrument on stamped paper, by which the party granting it becomes bound to pay a sum of money, or perform any act or duty, according to the terms of agreement. In England, a B. is said to be an instrument under seal, whereby one person becomes bound to another for the payment of a sum of money, or for the performance of any other act or thing. The person who is thus bound is called the obligor, and he to whom the B. is given, the obligee; and this obligation may be either by or to one or several persons. The B. may be unconditional simply for the payment of money, or it may be accompanied with a condition, the performance of which is secured by a penalty; but in any event, the debt created by a B. is of the high nature of a *specialty debt* (q. v.).

The requisites of a good B. are as follow: 1. The B. must have an obligor and obligee. In regard to such parties, it is to be observed that in general no person who is under any legal disability to contract, can become an obligor, though it is otherwise of an obligee. Thus, B. by a married woman neither binds herself nor her husband, but is absolutely void. This is a rule, however, which is liable to some qualifications, as to which see the following articles—**HUSBAND AND WIFE**, **MARRIED WOMAN**, **INCAPACITY OF REVERSIONARY INTEREST**. Nor can an infant bind himself, unless the B. be for necessities. But although a married woman is incapable of executing a B., yet one given to her is valid, and the interest in it will vest in her husband, without whose concurrence in its acceptance indeed the B. will lose its force. In the same way, a B. may be given to an infant, a lunatic, or an alien. 2. The next requisite of a B. is, that it must state the precise sum in which the obligor is bound; any omission in this respect will invalidate the instrument. If, however, the sum be merely erroneously stated, the courts will make the necessary correction, and construe the B. so as to give effect to the intention of the parties. In practice, the sum stated is generally double the sum intended to be secured—the excess being meant to cover the interest and any costs. 3. A B. must be so expressed as to create a clear legal obligation. But for this purpose no particular form of words is necessary; any mode of expression by which the intention appears, will suffice. A B., again, may be in the first or third

person, only it must be expressed in the English language, and not in Latin or French. 4. The B. must be duly executed. Such execution, in general, is the same as that of deeds, the sealing being the essential solemnity; and although it is usual for the obligor to sign the B., his signature is not necessary to its validity. Then the B. must be delivered, but it need not be dated; a B. has even been held good, though it bear a false or impossible date, on the principle that deeds take effect from, and have relation to, the time of their delivery, and not in reference to their date. Such, in general, is the form and structure of an English B., and it is used in an infinite variety of contracts.

In Scotland, the B.—personal B., as it is called—differs in several points of form from the English instrument. Its general structure is different, and it is executed in a different manner, with much solemnity and particularity, but without sealing; it does not bear to be for double the sum due, or any sum other than the correct one, which it states with precision, with a liquidate penalty, which is usually one-fifth of the principal sum; and it must have a *true* date, and be very specific in all its details. As in English practice, there are in Scotland two kinds of these instruments: first, bonds for money simply; and secondly, bonds for the performance and accomplishment of some act, or, as they are called in the Scotch practice, bonds *ad facta præstanda*.

A mortgage over land or other real estate is also in Scotland in the form of a B., by which name, indeed, the mortgage is technically described. Thus, there is the *heritable B.*, and the *B. and disposition in security*, the latter being the more modern form. By these mortgage bonds, the borrower not only becomes personally bound in the repayment of the loan, but 'in further security and more sure payment' he also conveys to the lender the land, or other real property, itself, on which the sum is to be made a charge, with, in a certain event and under certain conditions, a power of sale, by means of which the creditor, on the debtor's default, may recover his money. There are, in England, bonds by which expectant heirs may operate on their reversions, and these are called *post obit bonds* (q. v.).

According to the law of both countries, certain bonds are void; such as a B. conditioned either to do something which the law considers wrong in itself, or which is legally prohibited, or to omit doing something which is a duty, or to encourage the performance of anything which is in the nature of a crime or offence against the law. In like manner, bonds to procure marriage, called marriage brocage bonds, or to restrain marriage, or for immoral considerations, or in restraint of trade, are void. A B., however, may be valid in part, or void in part, if such parts are separable. See MORTGAGE, MARRIAGE BROCAGE BONDS, POST OBIT BONDS, PERSONAL SECURITY, SPECIALTY DEBT.

BOND CREDITOR, in England, is the name sometimes given to a creditor whose debt is secured by a bond, and therefore privileged as a specialty. See preceding article.

BO'NDAGER, the term applied in Scotland to a rural labourer who rents a cottage from a farmer under an obligation to work for him at current wages at certain seasons. There are male and female bondagers, but the arrangement in each case is the same. The origin of the bondager system is the want of a sufficient rural population for the field-work of the neighbourhood. To induce the settlement of labourers, a landlord gives a certain

number of cottages along with each farm, and the tenant-farmer has the privilege of letting these, with a view to securing casual assistants, such as at turnip-hoeing and harvest. When wanted, they are obliged to turn out, though it may be at a sacrifice in point of wages or feeling. Such are bondagers, a class of cottagers over whom the landlord has no direct control; and as the farmer for the most part looks alone to their physical capacity, their moral and social condition is not generally creditable.

BONDED WAREHOUSE. See WAREHOUSING SYSTEM.

BONDI, CLEMENTE, a modern Italian poet, was born in 1742 at Mizzano, in Parma. He was educated by the Jesuits; and when still very young, appointed to deliver lectures in rhetoric, in the Royal Convent at Parma. Here he produced his first work, *Giornata Villereccia* (Parma, 1773), which is a not very lively picture of the rural pleasures of the brotherhood. Having celebrated in verse the abolition of the Jesuit order, he was subjected to a priestly persecution, and compelled to conceal himself in the mountains of the Tyrol; but ultimately he found a patron in the Austrian Archduke Ferdinand. He fixed his residence in Vienna, where he died in 1821. His poems are lyrical, descriptive, satirical, and elegiac. They please cultivated men, but more especially women of delicate sensibilities, by the light-flowing elegance of their versification, and the rare purity of their style. Among his larger works may be mentioned, *La Conversazione*, *La Felicità*, and *Il Governo Pacifico*. Italians consider B.'s translation of the *Æneid* to possess remarkable excellence. His entire works were published at Vienna in 1808.

BONDOU', or **BONDU**, a country of Senegambia, West Africa, lying between lat. 14°—15° N., and long. 11°—13° W. The population is estimated at 1,500,000, who are principally engaged in the cultivation of the soil, which is fertile, producing cotton, indigo, millet, maize, tobacco, &c. The weaving of cotton-cloth, which, besides being made up into articles of dress, is used as currency, also forms part of the industry of the people. The surface of B. is level, with elevations in the north and central parts; the climate generally healthy, and vegetation luxuriant alike in field and forest. Iron is said to be plentiful, though not much worked, and gold is obtained in small quantity. Wild animals are numerous; and the principal river on the eastern border of the country, the Falemé, abounds with crocodiles. The inhabitants of B. profess Mohammedanism, but they trust greatly in sorcerers. The sovereign is absolute. B. exports cattle, corn, and gums; and has a transit trade in slaves, gold-dust, iron, salt, and butter. The capital, Bulibani, is situated in a plain bounded by rocky hills and forests, on the left bank of the Falemé. Its streets are unpaved and dirty, and its buildings mean and miserable; mud-walls surround it, and in its centre is the extensive but rude palace of the sovereign. Pop. about 2200, composed in great part of slaves, from the sale of which the ruler derives a considerable revenue.

BONE, HENRY, R.A., a celebrated enamel-painter, was born at Truro, in Cornwall, in 1755. Apprenticed to a china-manufacturer in Bristol, he removed from thence to London in 1779, where he was employed in enamel-painting for lockets, brooches, &c. An enamel-portrait of his wife, exhibited at the Royal Academy in 1780, first attracted public attention; and he soon obtained a position which rendered it no longer necessary for him to continue his drudgery for the jewellers. In 1800, he was

BONE.

appointed enamel-painter to the Prince of Wales, a position which he retained when the prince became king; and he also stood in a similar relationship to George III. and William IV. The Royal Academy made him an Associate in 1801, and a full Academician ten years later. Between this time and 1831, when advancing years compelled him to desist from his labours, he produced a large series of works remarkable alike for their beauty and dimensions; in the latter quality they were unapproached by any former or contemporary artist, and the principal of which are 'Bacchus and Ariadne,' after Titian, which was sold for 2200 guineas, and is now in the National Gallery; the 'Death of Dido,' 'Hope Nursing Love,' after Sir J. Reynolds; 'Venus,' &c. He also executed a large number of historical portraits of great merit; and altogether his name is one of the highest, if not the highest in his profession. He died December 1834.

BONE is the hard material of the skeletons or frameworks of mammalian animals, reptiles, and birds. In its earliest stages, it is termed temporary cartilage (q. v.), and consists of cells massed together, except in the flat bones, as those of the skull and shoulder-blade, of which the primary foundations are to a great extent of fibrous tissue. Points or centres of ossification form, the cells alter their form and arrangement, and a deposit of earthy materials, phosphate and carbonate of lime, takes place, rendering the former flexible substance rigid. By soaking a B. in a dilute mineral acid, we can dissolve these earthy matters, and render it again flexible; on the other hand, if we expose it to intense heat, the animal matter (gelatine) is got rid of, and

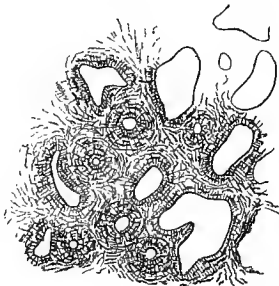

Transverse Section of Bone,
Shewing its microscopic structure.

though the bone retains at first its form, the slightest touch will cause its now unsupported earthy matter to crumble away. We see, in the ill-nourished children of large towns, too many examples of how necessary a proper relation of these two elements of B. to each other is; in the disease called rickets, the earthy matter is deficient, and the too flexible leg-bones bend under the weight of the trunk. In the aged person, again, the B. substance becomes more densely packed with earthy matter, and becomes brittle, rendering them peculiarly liable to fractures.

The bones of the skeleton are classified according to their shapes—viz., as long bones, e.g., the thigh-bone and arm-bone; flat bones, as the shoulder-blade and skull-bones; short and irregular bones, as those of the wrist or the vertebrae. The substance of bones is arranged differently in different parts—either hard and close, which is called the condensed substance, or loose and reticulated, called the cancellated structure. *Long Bones* have a shaft of hard substance terminating at each end

in soft or cancellated structure; in the latter situations, the B. is more expanded and rounded off to enter into the formation of a joint. *Irregular Bones* consist of a shell of condensed tissue, enclosing a mass of cancellated structure, and are smoothed off into surfaces adapted to those of the adjoining bones. *Flat Bones* consist of two layers of hard tissue, with an intermediate cancellated structure. Anatomists also talk of *mixed* bones, those which are both long and flat, as the ribs, the breast-bone, and the lower jaw.

The shaft of a long B. is hollow, and filled with an oily substance, the marrow (q. v.); the space in which the marrow lies is called the medullary canal. This fatty substance is also found in the cancellated structure of short and mixed, and in the diploté of flat bones, and even in the condensed tissue. Bones are covered externally by periosteum (q. v.), and on the surfaces of the cavities within by a fine membrane called internal periosteum or medullary membrane. B. is largely supplied with blood-vessels, which are continued into it from those of the periosteum; the largest are those which enter the cancellated ends of the long bones. The medullary membrane receives a special artery for the supply of the compact tissue next the canal. This vessel enters the bone generally rather above its middle, and divides into two branches, one of which runs up, the other downwards, both dividing into numerous branches, anastomosing with the vessels we have alluded to as entering the cancellated tissue. After the arteries enter the compact tissue of bones, they run in small capillary canals, invisible to the naked eye, which permeate the bone, and anastomose, leaving oblong loops or meshes. The veins of B. are also contained in these canals, but they are larger than the arteries, and possess at irregular intervals, where branches meet, dilatations or reservoirs for the blood.

These canals, named Haversian, after their discoverer, Clopton Havers, an old English anatomist, vary in diameter from $\frac{1}{2500}$ to $\frac{1}{200}$ of an inch. They take a longitudinal direction, and if a transverse section is examined under the microscope, it appears pierced with holes, which are the Haversian canals cut across. Each canal is surrounded by its own layers of condensed structure, forming in the aggregate a hollow rod or pin, called the Haversian system, running through the plates of which the B. is composed, and securing their cohesion. In addition to these, there are to be seen a number of minute spaces or *lacunae*, generally oval in man; from these pass numerous pores or *canaliculi*, which are directed to the nearest vessels: those in the periosteal, or outer lamella, pass into the B. from orifices on its surface, and the lacunæ face outwards. The pores of the internal layer open on the medullary canal, and its lacunæ face towards it, and the lacunæ in the layers around each Haversian canal face towards, and their pores open into it.

Nerves may be seen entering B., and the acute pain felt in some of its diseased conditions prove their existence, but they have not yet been actually demonstrated in the osseous tissue; neither have *absorbents*, though we suppose from analogy that bones are supplied with them.

The several bones composing the animal frame will be treated of under the head **SKELERON**. Any important peculiarities in the bones of different classes of animals, are noticed under the heads of these classes.

Chemical Composition of Bone.—The principal chemical ingredients present in B. are gelatine and phosphate of lime; and the following table represents the composition in 100 parts of B. of average quality:

BONE-ASH—BONE-BLACK.

	Human Bones.	Ox Bones.
Gelatine,	33.80	33.30
Phosphate of Lime,	53.04	57.35
Carbonate of Lime,	11.80	3.85
Phosphate of Magnesia,	1.16	2.05
Soda and Chloride of Sodium } (common salt), }	1.20	3.45
	100.00	100.00

When a B. is digested in dilute hydrochloric acid at a summer heat, the earthy matters are gradually dissolved out, leaving the gelatine of the size and shape of the original B., but now soft, somewhat transparent, flexible, and even elastic. If this soft gelatinous residue of B. be boiled with water, it dissolves in great part therein, and yields a solution which sets or gelatinises on cooling. A more common way of extracting the gelatine from B. is to heat the bones covered with water in a digester to a temperature of 270°—280° F., when much of the gelatine dissolves out, and leaves the earthy salts with the remainder of the gelatine. Besides the marrow (q. v.), a little fat is generally found permeating the entire structure of the B., which can be extracted by throwing the bones into hot water, when the grease or fat exudes and floats to the surface. In some of the larger bones of man and other mammalia, there is a central cavity containing a considerable amount of fatty matter, popularly known as *marrow*. These cavities are not found in the bones of the young animal, but gradually form as the animal approaches maturity. In the sloth, cetacea, seals, and a few other animals, the cavities are not found. Occasionally, as in man, the elephant, giraffe, &c., the bones in the head have cavities filled with air instead of marrow. The uses to which a B. may be put are various. In the cooking of soups, bones form a constant ingredient, and become useful in supplying gelatine, which gives a *body* to the soup it would not otherwise possess. Where the soup is required of great lightness, for an invalid with weak digestive powers, the shavings of stag's horns may be employed, and these yield a *hartshorn jelly* free from oil, and which therefore sits lightly upon the stomach. How far gelatine is of itself nutritious, is a disputed question. See GELATINE and NUTRITION. Animals, however, like the dog, which masticate, devour, and digest the entire B., do derive benefit therefrom, in part from the gelatine, and in other part from the earthy substances; and the same remark applies to the use sometimes made of small fish, where, after being thoroughly browned, they are entirely eaten. In times of scarcity in Norway and Sweden, the poorer people even eat the bones of mackerel and other fish.

B. is largely used in making the handles of small brushes, the more common table-knives and ferks, and penknives, and in the manufactures of the cheaper sorts of combs (q. v.). Our forefathers, before the metals were known, fashioned fish-hooks out of B., and used the spines in the tail and back-fin of certain fishes for pointing arrows. These uses of B., coupled with the employment of the serrated teeth of sharks as a war-weapon, are still practised by many uncivilised tribes. The fatty and other organic matters in B. allow of its being employed as a fuel where coal or wood cannot be obtained, as in the pampas of South America and the steppes of Tataria. In these regions, it is considered that the heat evolved during the combustion of the bones of an ox suffices to cook the flesh.

B. is likewise serviceable in the arts in yielding B.-ash (q. v.), B.-black (q. v.), B.-dust (q. v.), Dissolved Bones (see BONES, DISSOLVED), phosphorus (q. v.), superphosphates (q. v.), and certain oils and fats (see DIPPEL'S ANIMAL OIL),

which are employed in forming lampblack (q. v.), and in the manufacture of soap (q. v.). See also BONES, AS MANURE.

BONE-ASH, or BONE-EARTH, is obtained by the complete combustion of bones in an open furnace, when the oxygen of the air burns away the organic matter or gelatine, and leaves the earthy constituents as a white friable mass, the size of the original bone, but readily reducible to the condition of coarse powder which is bone-ash. A very large quantity of B. is exported from South America to other countries, especially Britain. The used up bone-black of the sugar-refiner is also employed as a source of B., by being heated in a furnace exposed to the air. B. of good quality contains about 80 per cent. of phosphate of lime, and 20 per cent. of carbonate of lime, phosphate of magnesia, soda, and chloride of sodium (common salt); but it is occasionally found mixed with sand, especially that procured from South America. B. is employed to some extent as a source of phosphorus (q. v.), and in the making of cupels (q. v.) for the process of assaying (q. v.); but the most extensive use is in the manufacture of artificial manures, such as dissolved bones (q. v.) and superphosphates (q. v.).

BONE-BLACK, ANIMAL CHARCOAL, or IVORY-BLACK, is prepared from bones by heating them in close retorts till they undergo the process of destructive distillation, when combustible gases and water, together with the vapours of various salts of ammonia, and oil, are given off, and B. is left in the retort. It is generally reduced to coarse grains from about the size of small peas, down to large pinheads, and is extensively used in the arts for decolorising liquids, such as the sirup of sugar, and solutions of argol (impure cream of tartar) and of the alkaloids, as also in filters (q. v.), for separating chemical impurities from water. The general mode of using the B. is to allow the coloured liquid to percolate through a layer of the charcoal, when all colour is arrested, and the sirup or water runs clear and colourless from under the stratum of charcoal. This power of absorbing colouring matters is also observable in vegetable (peat or wood) charcoal, but not to such an extent as in bone-black. The application of heat to the liquids before filtration greatly facilitates the decolorisation, and where the volume of liquid to be operated upon is not great, the most expeditious method is to boil the liquid and B. together, and then strain through filtering-paper or cloth. The composition of B. in 100 parts is 10 of pure charcoal, associated with 90 of earthy salts—that is, in the proportion of 1 of pure charcoal in 10 of the commercial bone-black. The power of absorbing colours appears to be due to the porosity of the substance, and is not resident simply in the pure charcoal; indeed, the earthy matters (principally phosphate of lime and carbonate of lime) can be dissolved out of the B. by dilute hydrochloric acid, and the pure charcoal thus obtained only possesses about one-third the decolorising power of the total amount of B. it was obtained from. Thus, if 100 parts of ordinary B. have the power of arresting the colour from ten volumes of a given coloured liquid, then the 10 parts of pure charcoal which can be obtained from the 100 parts of B. will be found to decolorise only three volumes of the same coloured liquid; so that it is apparent the earthy matters in the B. influence and increase the absorption of the colouring matter, and thus render a given weight of the charcoal of greater commercial value. When sirup of sugar and other liquids have been run through B. for some time, the pores of the latter appear to get clogged with the colour, and the clarifying influence ceases, and

then the B. requires to undergo the process of *revivication*, which consists in reheating it carefully in ovens, or iron pipes enclosed in a furnace, when the absorbed colour is charred, and the B. can be of service once again as an arrester of colour. After several re-burnings, the B. becomes of very inferior absorptive quality, and is then disposed of for the manufacture of bone-ash and dissolved bones (q. v.). B. has likewise a great power of absorbing odours, especially those of a disagreeable nature, and can thus be employed to deodorise apartments, clothing, outhouses, &c., or wherever animal matter may be passing into a state of active putrefaction.

BONE-DUST is obtained by reducing bones to a fine state of division, either under heavy revolving wheels, or by passing them through toothed iron rollers. In order to facilitate the pulverisation of the bone, it is occasionally first subjected to the action of hot water and steam in a digester at a temperature of 270°–280° F., which dissolves out two-thirds of the gelatine, and leaves a very friable mass, which can be reduced to powder even when pressed between the fingers. B. is used in agriculture as a fertilising agent, either in its ordinary insoluble condition, when the beneficial effects on the land are prolonged over a series of years, or as dissolved bones (q. v.), when the fertilising force is exerted principally the first year. See **BONES AS MANURE**.

BONE-GELATINE. See **GELATINE**.

BONER, ULRICH, one of the oldest German fabulists, was a preaching friar of Bern, and is frequently mentioned in documents of the years 1324–1349. He flourished just when the minnesingers and poets of chivalry had passed away. His collection of 100 fables, or 'examples,' as they used to be called, was entitled *Der Edelstein* (The Precious Stone), and was first printed at Bamberg, 1461. It is marked by purity of style, and by clear and vivid delineation. This book is one of the greatest of all bibliographical rarities, for, at present, only one copy—that in the Wolfenbüttel Library—is known. It is decorated with wood-cuts. Bodmer and Breitinger published a complete edition of the work at Zürich in 1757.

BONES, DISSOLVED, a manure prepared by acting upon bone-dust by sulphuric acid of specific gravity 1600. About 15 cwt. of sulphuric acid (of specific gravity 1600) is added to every ton of bone-dust in a mixing vessel, where the whole can be thoroughly incorporated together. The resulting mass is allowed to lie in a heap for several months, during which time it dries up, and when sent into market, is a dark-coloured, coarse, soft powder. The original bone-dust contains a large percentage of insoluble or tribasic phosphate of lime ($\text{CaO}, \text{CaO}, \text{CaO}, \text{PO}_5$); and two equivalents of sulphuric acid (HO, SO_3) acting thereon, abstract two of the atoms of lime, and form two equivalents of sulphate of lime (CaO, SO_3), and one atom of the acid phosphate of lime ($\text{HO}, \text{HO}, \text{CaO}, \text{PO}_5$), which are soluble in water. As the gelatine of the B. hinders the sulphuric acid from acting fully on the earthy matter, it is customary to use a good proportion of bone-ash along with the bone-dust, and the absence of gelatine in the former admits of the acid doing its proper work. Very often, bone-ash is alone used in the preparation of Dissolved B., and then the manufactured material, containing no gelatine or animal matter, receives the name of *superphosphate* (q. v.), or *superphosphate of lime*. In place of bone-ash, much bony matter or phosphate of lime, in the form of **APATITE** (q. v.) and **COPROLITES** (q. v.), is now employed in part in the manufacture of some varieties of dissolved bones. The present value (1860) of

Dissolved B. ranges from £6 to £8 per ton, according to quality; and they contain from 20 to 35 per cent. of soluble phosphate of lime, and 15 to 3 per cent. of undissolved or insoluble phosphates. This material is very largely employed as a manure in Britain, and is eminently suitable for the cultivation of the root-crops, such as turnips, mangel-wurzel, &c.; and, associated with 12 to 20 per cent. of sulphate of ammonia (q. v.), or nitrate of soda, it rivals Peruvian guano in its fertilising effects on land where cereals—wheat, barley, oats, &c.—are growing.

BONES AS MANURE. The employment of bones as a manure is one of the greatest modern improvements in agriculture. They are applied either simply reduced to small fragments or a coarse powder called *Bone Dust* (q. v.), or, after undergoing chemical preparations of various kinds, as the basis of highly valuable artificial manures.—See **BONE-ASH**, and **BONES, DISSOLVED**.—All the substances which enter into the composition of bones are desirable additions to the soil, but particularly the phosphates. Phosphoric acid, usually found in combination with magnesia, and more particularly lime, enters into the structure of every plant and animal; it is a substance, therefore, which cannot be dispensed with either in the vegetable or animal economy. Being very sparingly diffused through most soils, it is often essential to add it artificially. The productiveness in many districts of Britain had become much impaired by the diminution of phosphoric acid in the soil, owing to the quantity taken off in corn, cheese, and the B. of animals, which were annually raised and exported. The fine red sandstone loams of Cheshire were comparatively sterile in the end of the last century, which was entirely owing to the deficiency of phosphoric acid in the soil, no doubt partly to be attributed to the quantity yearly abstracted by the dairy produce sent to market. So much was this the case, that a liberal dressing of common or calcined B. had the effect of at once doubling the value of the worn-out pastures. In other parts of Britain, however, such as the clay-soils of Suffolk—which at one time were under dairy-farms—the soil is rich in phosphates, and the application of B. as a manure is there attended with little effect. It becomes, therefore, of practical importance to ascertain when this substance should be added, and when it is not necessary to do so. It is important to observe, that although phosphoric acid is as essential to one crop as to another, yet some crops, such as turnips, require a far more liberal *artificial* supply of it than others, or wheat, which actually require as much to build up their structure. We will shortly state the principles which should regulate the practice of bone-manuring.

All perennial plants, such as grasses, are enabled to extract phosphoric acid from the soil more readily than annual plants, owing to their numerous and well-developed roots, which are ready, even at the beginning of the growing season, to draw supplies from a large mass of soil. Grasses, therefore, are only benefited by phosphoric manures when the soil is more than usually deficient in phosphates. If grass-lands are sterile, it is easy to ascertain if a deficiency of phosphoric acid is the cause, by adding calcined or crushed B., and watching their effect. An experiment of this sort is a much better guide than any analysis of the soil. In Cheshire, the quantity of B. applied to the pastures is from half a ton to a ton per acre; and this dressing will last from 16 to 25 years.

Wheat, also, from the long time it occupies the ground before it is ready to be reaped, and its slow growth during its early stages, can thrive with a small supply of phosphates. These substances

are, therefore, comparatively seldom applied directly as a manure for this crop. So, also, with early-sown oats or barley. When these latter crops, however, are late sown, and the rapidly growing conditions of heat and moisture exist, phosphates are often applied with great benefit.

It is as an application to the turnip that phosphoric acid is so marked in its effects, even when the soil already contains it in considerable quantity. The reason of this is not difficult to trace. The seed of the turnip is small, and it is sown at the warm season, when the growth is rapid. The seeds themselves have only a limited quantity of phosphates stored up for the benefit of the roots and leaves of the young plants. Unless the roots, therefore, while yet short, meet with a concentrated supply, the other elements of the food of the plant—carbonic acid, water, and ammonia—however abundantly they may be present, cannot be assimilated, and its growth is arrested. Besides, a liberal supply of phosphates has the effect of pushing on the turnip through its early stages, when it is so liable to injury from various insects.

The effects of B. as a manure for the turnip are greatly increased by dissolving them in sulphuric acid, and manufacturing the soluble superphosphate of lime. Liebig suggested such a use of sulphuric acid in 1839, and since then, hundreds of manufactories of this manure have arisen over the land. The utility of the discovery, however, is not at present so great as is sometimes represented, owing to the large supply of phosphatic guanos now in the market. In these the phosphate of lime is in a finely divided state, and is readily enough taken up by plants without being dissolved by acids. No doubt, as the scarcity of guano begins to be experienced, and its price rises, it will again become a much greater object than at present to manufacture superphosphate from mineral phosphates or bones. Three to four cwt. of dissolved B. or of phosphatic guano is the quantity usually applied to an acre of turnips.

The value of B. as a manure has been long known in some parts of England, but their use was merely local, until more than two decades of the 19th c. had passed; and they were merely broken by a hammer, or rudely and imperfectly crushed by being laid in ruts where cart-wheels might pass over them. The first machines for bone-crushing were employed in Yorkshire and Lincolnshire in 1814 or 1815, and reduced them only to pieces about the size of a walnut, much larger than the coarsest or 'rough' bone-dust now in use. The employment of this manure did not become general in Scotland till about 1830, although it had been introduced in East Lothian some years before. Its use has now extended to different parts of the continent of Europe, and to North America.

BONET, JOHN PAUL, a Spaniard of the 17th c., one of the first instructors of deaf mutes. Only one person before him had been at all successful in the art, and about him, B. does not appear to have known anything, so that he is really entitled to the claim of originality in his method, which consisted in imparting instruction by the sight instead of by the ear—gestures, writing, a manual alphabet, and an artificial pronunciation, being the means employed. His plan is minutely detailed in a volume published by him at Madrid in 1620, entitled *Reduccion de las Letras, y Arte para enseñar a hablar los Mudos*. The manual alphabet now in use at almost all deaf and dumb institutions in Europe and America, differs little from that introduced by Bonet.

BONFIRE, a fire kindled for some purpose of

public rejoicing, usually in an open conspicuous place, as the top of a hill, or the centre of a village-green. The burning materials consist of tar-barrels, coal, and other combustibles. The practice of kindling fires of this kind is of so great antiquity in England, Ireland, and Scotland, as to be traced to pagan rites. See **BELFRIN**. It was customary to kindle one of these fires in token of rejoicing on Midsummer Eve—the evening before the 24th of June, which day was appropriated by the church for the feast of St John the Baptist. Reference is made to bonfires on this occasion by Googe in his translation of the poet Naogeorgus:

Then doth the joyfull feast of John the Baptist take
his turne,
When bonifiers great, with loftie flame, in evcrie
towne doe burne;
And young men round about with maides doe dance
in everie street,
With garlands wrought of motherwort, or else with
vervain sweete, &c.

For much antiquarian lore on this subject, see Brand's *Popular Antiquities*, edited by Sir Henry Ellis, vol. i. The origin of the word B. has been very puzzling to etymologists. In Scotland, the popular term is *banfire* or *banfire*, which Jamieson says is apparently a corruption of baillfire, which may be doubted. The most probable etymology is the Welsh *ban*, high, whence *ban-fagl*, a lofty blaze, a bonfire. The same hills that in English are called *Beacons*, are in Welsh called *Bans* or *Vans*. In Danish, also, *baun*, is a beacon, and may be traced in such names as *Banbury*.

B'ONGAR (*Bungarus* or *Pseudoboa*), a genus of venomous serpents, allied to the genera *Elaps* and *Naja*, and distinguished by a much keeled back, which has a row of hexagonal scales larger than the rest. The head is broad and depressed,

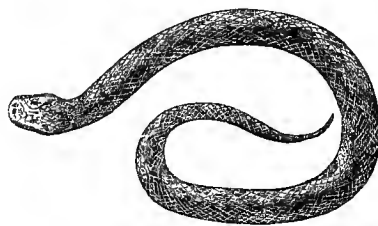

Bongar, or Rock Snake.

with very strong bones. The species, which appear to be few—only two being certainly known—are natives of the East Indies. They are called Rock Snakes in India. *B. annularis*, which has the body surrounded with rings of black and yellow, attains a length of six or eight feet.

BONGARDIA, a genus of herbaceous plants of the natural order *Berberideæ* (q. v.), natives of the East. One species (*B. Rauwolfii*) produces tubers, which are eaten, either boiled or roasted, in Persia; and the leaves of another (*B. chrysozonum*) have an acid taste, and are eaten as a salad.

BONGAY, an island of the East Indian Archipelago, to the east of Celebes. It gives name to a group of islets, which supplies the neighbourhood with slaves and wood.

BONHEUR, ROSALIE (more commonly called Rosa), a female French artist, born at Bordeaux on the 22d of March 1822. Her first master was her own father, Raymond Bonheur, an artist of merit, who died in 1853. In 1841, Mademoiselle B. contributed for the first time two small pictures to the

French Exhibition, and the subjects, 'Two Rabbits,' and 'Goats and Sheep,' already indicated the department in which she was afterwards to attain such extraordinary eminence. During the ten years which followed, she was a constant contributor, almost all her pictures being devoted to animal, or at least to rural life. In 1851 and 1852, she was so pressed by requests from private parties, that she was unable to exhibit; but in 1853, her famous 'Horse Market' was the principal attraction of the Parisian exhibition, and in London was recognised as placing her at least on a level with Landseer. Since 1849, Mademoiselle B. has directed the gratuitous School of Design for young girls. A beautiful portrait of her, by Paul Delaroche, has been executed.

BO'NI, or BO'NY, a powerful state of the south-west peninsula of the island of Celebes, in the South Pacific Ocean, between lat. 4° 20'—5° 20' S., and long. 119° 35'—120° 30' E. In the north part, the scenery is fine, and the soil fertile—rice, sago, and cassia being produced. In addition to agriculture, the industry of the inhabitants consists in the manufacture of cotton, and articles of gold and iron, in which they have a large trade. Their institutions, which are said to be very ancient, partake of the character of a constitutional monarchy. The British have twice attacked the Bonese for injuring their commerce, and selling the crews of British ships into slavery. In the second attack, in 1814, the Bonese king was killed. Pop. 200,000.—B., GULF OF, separates the south-east and south-west peninsulas of Celebes. It has a length of about 200 miles, with a breadth narrowing from 80 to 40 miles. Numerous shoals render its navigation difficult.

BONIFACE, Sr, 'the Apostle of Germany,' whose original name was Winfried, was born in Devonshire, England, about 680. He first entered a monastery in Exeter, at the age of 13, and afterwards removed to that of Nutcell, where he taught rhetoric, history, and theology, and became a priest at the age of 30. At that time, a movement, proceeding from England and Ireland, was going on for the conversion of the still heathen peoples of Europe; in 614, Gallus and Emmeran had been sent to Alemannia, Kilian (murdered 689) to Bavaria, Willibrord (died 696) to the country of the Franks, Swidvert to Friesland, and Siegfried to Sweden. Winfried also took the resolution (715) of preaching Christianity to the Frisians, among whom it had as yet found no entrance. But a war broke out between Charles Martel and the king of the Frisians, and Winfried returned from Utrecht to his convent, of which he became abbot. Still bent upon his design, he repaired to Rome in 718, and received the authorisation of Pope Gregory II. to preach the gospel to all the tribes of Germany. He went first to Thuringia and Bavaria, then laboured three years in Friesland, and travelled through Hesse and Saxony, everywhere baptising multitudes, and consecrating their idolatrous groves as churches. In 723, Gregory II. called him to Rome; made him bishop, with the name of Bonifacius; furnished him with new instructions or canons, and with letters to Charles Martel and all princes and bishops, requesting their aid in his pious work. Returning to Hesse (724), he destroyed the objects of heathen worship (among which are mentioned an oak near Geismar, sacred to Thor, and an idol named Stoffo, on a summit of the Harz, still called Stoffenberg), founded churches and convents, and called to his aid priests, monks, and nuns from England, whom he distributed through the various countries. In recognition of his eminent services, Gregory III. sent him (732) the pallium, and named him archbishop and primate

of all Germany, with power to establish bishoprics wherever he saw fit. B. now made a third journey to Rome (738), and was appointed papal legate for Germany. The bishoprics of Regensburg, Erfurt, Paderborn, Würzburg, Eichstädt, Salzburg, and several others, owe their establishment to St Boniface. The famous Abbey of Fulda is also one of his foundations. He was named Archbishop of Mainz by Pipin, whom he consecrated as king of the Franks at Soissons (752), and he presided in the council held at that place. In 754 he resumed anew his apostolical labours among the Frisians; and at Dokkum, about 18 miles north-east of Leeuwarden, in West Friesland, this venerable Christian hero was fallen upon by a mob of armed heathens, and killed, along with the congregation of converts that were with him (755). His remains were taken first to Utrecht, then to Mainz, and finally to Fulda. In the abbey, there are still shewn a copy of the gospels written by him, and a leaf stained with his blood. A collection of his letters, and the canons he promulgated for the discipline of the newly established churches, have been preserved, and are instructive as to the state of Germany at the time. The completest edition of the Letters (Epistolæ) is that of Würdtwein (Mainz, 1789). In 1811, a monument was erected to St B. on a hill near Altenberga, in the principality of Gotha, where, according to tradition, he had erected (724) the first Christian church in North Germany. A statue by Henschel of Cassel was also erected to him in Fulda in 1842. Rittberg, *Kirchengeschichte Deutschlands* (vols. i. and ii., Gott. 1845).

BONIFACE, the name of nine popes, most of whom are of no historic note.—B. I. (418—422) was appointed, contrary to canonical rule, by the Emperor Theodosius II., upon account of prevailing party divisions. He was the first who assumed as Bishop of Rome the title of First Bishop of Christendom.—Boniface III., who was pope only for ten months in the year 607, was the first to whom the title of Universal Bishop of Christendom was conceded by the Greek Emperor (Phocas).—B. VIII., previously Benedict Cajetan, a native of Anagni, was elected pope on December 24, 1294. His inauguration was distinguished by great pomp: the kings of Hungary and Sicily held the reins of his horse as he proceeded to the Lateran, and with their crowns upon their heads, served him at table. He failed, however, in his attempts to assert a feudal superiority over Sicily, and to exercise his papal authority in the disputes between France and England. Philip the Fair of France, supported by his states and clergy, maintained the independence of the kingdom, disregarding many bulls and briefs, and even the sentence of excommunication to which the pope proceeded. Philip at last, with the aid of Italian enemies of B., made him prisoner at Anagni, to which he had fled; and although he was liberated by the people of Anagni after two days' imprisonment, he died within about a month (1303 A.D.), in consequence of having refused food during these two days, through fear of poison. He instituted the Roman jubilee in the year 1300. If the charges, however, which Philip the Fair brought against B. in self-defence—viz., heresy, simony, licentiousness, &c.—were well founded, and regarding the second there can be no doubt, Dante was quite justified in giving him a place in hell. Apart from the question of his personal character, B. was undoubtedly one of those dangerous ecclesiastics in whose downfall civilisation exults.—B. IX. (Peter Tomacelli), a native of Naples, succeeded Urban VI. as pope at Rome in 1389, whilst Clement VII. was pope at Avignon. He exceeded all his predecessors in the shameless sale of ecclesiastical offices and benefices, and of

dispensations and indulgences. He acquired, after a struggle, a most despotic power in Rome, which he kept in awe by fortresses; but to secure himself against external enemies, particularly Louis of Anjou, whose claim to the crown of Naples he had opposed, he was obliged to give away part of his territory in fiefs, as Ferrara to the House of Este. He died in 1404.

BONIFACIO, STRAIT OF, the modern name of the strait between Corsica and Sardinia, the *Fretum Gallicum* of the Romans. At the narrowest part, it is only 7 miles wide. The navigation is difficult, owing to the great number of rocks, which, however, are favourable to the production of coral, and the coral and tunny fisheries are actively prosecuted. At the eastern entrance of the strait lie the Bucinaric or Magdalen Islands, the *Insulæ Caniculariæ* of the ancients, principally inhabited by Corsicans, but mostly belonging to Sardinia. The strait receives its name from the small town of Bonifacio in Corsica, strongly situated upon a rocky promontory, with an excellent harbour and 3300 inhabitants. It was a place of much consequence to the Genoese for the security of their trade in these seas, and a number of very fine churches still attest its former greatness.

BONIN, or ARCHBISHOP ISLANDS, in the Pacific, stretching in N. lat. between 26° 30'—27° 44', and in E. long. between 142°—143°. They were discovered in 1827 by Captain Beechey of the *Blossom*, who took formal possession of them for England. They would appear to have been then uninhabited. In 1830, however, Peel Island, near the centre of the group, was settled, in connection with the whaling-business, by a motley colony—an Englishman, an Italian, a Dane, 2 Americans, and 15 Sandwich Islanders (5 men and 10 women)—under the auspices of a 'union-jack.' According to the latest accounts, the population had increased from 20 to 42. Besides pigs, goats, and fowls, Peel Island produces sweet potatoes, maize, onions, yams, pumpkins, melons, lemons, tobacco, and sugar-cane. Timber also is plentiful, though not of sufficient size for masts.

BONITO, a name common to several fishes of the mackerel family, or *Scomberidæ* (q. v.). One of these, *Thynnus pelamys*, sometimes called the Stripe-bellied Tunny, and of the same genus with the

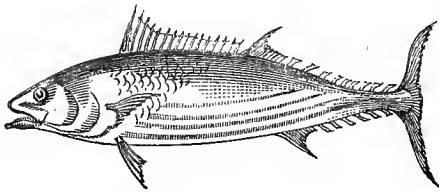

Bonito, or Stripe-bellied Tunny.

Tunny (q. v.), is well known to sailors as an inhabitant of tropical seas, and as one of the fishes most frequently seen pursuing the flying-fish. It is often taken by an imitation flying-fish made to skim along and touch the waves. Its flesh, although relished by those who have been previously confined to salt provisions, is dry. It is occasionally but rarely caught on the British coasts. It is a very beautiful fish, seldom exceeding thirty inches in length, of a beautiful steel-blue colour, darker on the back,

and whitish below. Four dark lines extend along each side of the belly. The general form resembles that of the mackerel, but is less compressed.—The B. of the Mediterranean (*Pelamys Sarda*) is a fish very similar to this, but of an allied genus, distinguished by its comparatively large and strong teeth. It has dark transverse bars reaching from the ridge of the back to the lateral line. It is plentiful in the Black Sea.—The Plain B. (*Auzis vulgaris* or *A. Rocheanus*) may be distinguished at once from both of these by its more uniform blue colour, without stripes or bands, and by the widely separated dorsal fins. It has only one row of minute teeth in each jaw. It is found in the Mediterranean, and in some places seems to bear, in common with the last-mentioned species, the name bonito. Its flesh is little esteemed when fresh; it is generally used either salted or pickled. Like mackerel, it putrefies rapidly, unless means are used for its preservation. This fish has been occasionally caught on the coast of England, and one was taken in summer 1859, in a herring-net, off the coast of Banffshire.—Another species of *Auzis*, a native of the West Indian seas, equals the tunny in size.

BONN, a town of Rhenish Prussia, beautifully situated on the left bank of the Rhine, 15 miles above Cologne. Population, exclusive of the military, about 17,000. B. is connected with the right bank of the Rhine only by a ferry, and with Cologne by the railway as well as the river. The Cathedral Church is a fine specimen of the last period of the Romanesque style, and exhibits the transition to the Gothic already begun. B. has considerable manufactures of cotton goods, earthenware, vitriol, and soap. The neighbourhood is very romantic. B. is the seat of a number of learned associations and institutions. The Leopoldine Academy of Physical Science, founded at Vienna in 1652, was transferred to B. in 1818. It obtained a university in 1786, which, however, was suppressed during the sway of France; and the present university was founded in 1818, receiving from government the former electoral palace and other buildings, with an annual revenue of nearly £15,000 sterling. There are two theological faculties, the one Protestant, and the other Roman Catholic. The university has altogether more than 80 professors and lecturers, and fully 1000 students, and among its professors have been numbered some men of high distinction, as Niebuhr and A. W. Schlegel. Albert, Prince Consort, was a student here. Its clinical establishments are of unusual extent, and admirably arranged. It has a library of about 150,000 volumes, archaeological and other collections, a botanic-garden, an observatory, an agricultural school, a riding-school, &c. B. derives its origin from *Bonna*, one of the castles erected by the Romans in Germany. It was long the residence of the electors of Cologne; it was taken from the French in 1689, after a severe bombardment by the Elector Frederic III. of Brandenburg; and in 1703 it surrendered, after a siege, to the English and Dutch army under Marlborough. It returned again into the possession of the Elector of Cologne in 1715, and in 1717 its fortifications were razed. It was acquired by France in 1802, and assigned to Prussia in 1814. Beethoven was a native of Bonn.

BONNER, EDMUND, Bishop of London, was born of obscure and doubtful parentage, about the end of the 15th century. The reputation he gained at Oxford by his knowledge of the canon law, recommended him to the notice of Wolsey, who promoted him to several offices in the church. After the fall of Wolsey, B. took an active share in the work of reformation, and received due promotion from Henry VIII.

In 1533, he was deputed to appear before the pope at Marseille, to appeal for the excommunicated monarch to a general council. The violence of his threats on this occasion suggested to his holiness the fitness of having him burned alive, or thrown into a caldron of melted lead, so that B. judged it prudent to leave Marseille without notice. In 1540, he was made Bishop of London. The death of Henry cooled his Protestant zeal; and having given proofs of his lukewarmness in the cause of reformation, he was at length, in 1549, committed to the Marshalsea, and deprived of his bishopric. The accession of Queen Mary restored him to office, and gave him the opportunity of revenge, which he now took without delay or stint. As vicegerent and president of the convocation, he was the principal agent in that bloody persecution which has made the reign of Mary infamous. On the accession of Elizabeth in 1558, B. accompanied his episcopal brethren to salute her at Highgate, but was excepted from the honour of kissing her hand. In May 1559, he was summoned before the privy council, and refused, with a consistency worthy of due respect, to take the oath of supremacy. He was accordingly deposed from his bishopric, and shut up in the Marshalsea, where he died in 1569. While it is right to remember with detestation the multitude of B.'s cruelties, one also ought not to forget that he was strict in castigating the lax morality of his clergy; that after his return to popery, he remained steadfast to his principles; and that he bore his final misfortunes with manly resignation.

BONNET, in Fortification, is a small defence-work constructed at the salient angles of the glacis or larger works. It consists of two faces only, with a parapet 3 feet high by 10 or 12 broad. There is no ditch. A larger kind, with three salient angles, is called a priest's B., or *bonnet à prêtre*. The use of the B. is to check the besiegers when they are attempting to make a lodgment.

BONNET, CHARLES, an eminent naturalist and philosopher, born at Geneva, 13th March 1720. He was educated for the profession of the law, but devoted himself at a very early age to the study of natural history. A dissertation on aphides obtained for him, in 1740, the honour of being made a corresponding member of the Academy of Sciences in Paris. He was soon afterwards occupied in researches concerning polypi, the respiration of insects, the structure of the tapeworm, &c. He published his *Traité d'Insectologie* (2 vols., Par.) in 1745. His *Recherches sur l'Usage des Feuilles des Plantes*, published in 1754, contained the result of much observation on important points of vegetable physiology. A severe inflammation of the eyes, putting a stop for two years to his researches in natural history, gave another direction to his studies, and he published several works on psychology, in which materialistic views decidedly prevail: the body is represented as the original source of all the inclinations of the soul, and all ideas are referred to movements of the nervous fibres; but his religious convictions remained always strong and unshaken, and in his *Idées sur l'État Futur des Êtres Vivants, ou Palingénésie Philosophique* (2 vols., Gen. 1769), he endeavoured to demonstrate the reasonableness of the Christian revelation. In this work he also maintained the future life of all living creatures, and the perfection of their faculties in a future state. Lavater translated the last part of it, and it helped to effect a change in the religious tendencies of Mendelssohn. His *Considérations sur les Corps Organisés* (2 vols., Gen. 1762) is very much devoted to an examination of the theories of generation. B. was for some years a member of the Great Council of

his native city. He died on 20th May 1793. In the latter part of his life, he superintended a collective edition of his own works (8 vols. and 18 vols., Neuch. 1779—1788).

BONNET, a covering for the head, of which there are many varieties. The French, from whom we have the word, apply it as we do to male as well as female head-dress. A kind of night-cap is called by them a B.; as, for example, the *bonnet rouge*, or infamous 'cap of liberty' of the revolutionary leaders. The English B. of former times was made of cloth, silk, or velvet, less or more ornamented, according to the means or taste of the wearer. This species of headgear was generally superseded by the hat, in the early part of the 16th c.; but in Scotland, bonnets were universally worn for a century to two centuries later, and they still remain to a certain extent a national characteristic. From the frequent notice of the blue B. in historical records and in song, it would seem that the Scotch were long identified with this kind of head-covering. The genuine old B. of the Lowland Scottish peasantry was of a broad, round, and flat shape, overshadowing the face and neck, and of a dark-blue colour, excepting a red tuft like a cherry on the top. The fabric was of thick milled woollen, without seam or lining, and so exceedingly durable that, with reasonable care, a single B. worth about 2s. would have served a man his whole life. No head-dress ever invented could stand so much rough usage. It might be folded up and put in the pocket, or laid flat and sat upon, with equal impunity; it might be exposed to a heavy drenching rain without the head being wetted, and when dried, it was as good as ever. Besides, it could be worn on the top of the head, or slouched in front, behind, or sidewise, as a protective against a cold blast; and from its softness and elasticity, it very fairly saved the head from the effects of a blow. In short, there was no end to the adaptability of the old 'braid bannet,' as the Scotch termed it; and one almost feels a degree of regret that, in the progress of fashion, it should have gone so much out of use. From having been worn, till comparatively late times, by small rural proprietors—such as owners of a cottage and an acre or two of land—it gave to these local notabilities the distinctive appellation of *Bonnet Lairds*. A lesser and not so broad a variety of the B. was worn by boys. The Highlanders have long worn bonnets of the same fabric, but these rise to a point in front, and are without any rim. Such is the cap now known as the *Glengarry Bonnet*. From time immemorial, these various kinds of Scots bonnets have been manufactured at Stewarton, a small town in Ayrshire. Formerly, the Stewarton B.-makers formed a corporation, which, like other old guilds, was governed by regulations conceived in a narrow and often amusingly absurd spirit; one of the rules of the fraternity, however, can be spoken of only with commendation, for it enforced a certain weight of material in each B., as well as durability in the colour. An account of this ancient corporation will be found in *Chambers's Journal*, first series, vol. v., p. 142. The bonnets used in the Highland regiments are made at Stewarton and Kilmarnock; they are usually distinguished by a chequered fillet, being the *fess-chequé* of the House of Stuart. Latterly, although hats and caps have, to a great extent, superseded bonnets of the old varieties, the bonnet manufactories of Stewarton have much increased, and are still increasing. Of the many and ever-shifting varieties of ladies' bonnets of straw, silk, and other materials, we need not attempt any account.

BONNET-PIECE, a gold coin of James V. of

Scotland, so called on account of the king's head being decorated with a bonnet instead of a crown, as was usual. We give a representation of the obverse side of this elegant coin, which shews the 'king's head regarding the right, with a cap or bonnet, having a circle of gems; round the neck



Bonnet-piece.

ished the size of the gold coins 'by increasing their thickness. The most remarkable are those commonly called the bonnet-pieces, which were struck of native gold; in beauty and elegance of workmanship, they approach the nearest to the Roman coins, and very much surpass all the coinage at that period, or ever since.' These bonnet-pieces are among the most valued curiosities of the antiquary.

BONNEVAL, CLAUDE ALEXANDRE, COUNT DE, also called Achmed Pasha, a French adventurer, whose history is very extraordinary. He was born of a noble family at Coussac, in Limousin, in 1675; proved unmanageable at the Jesuit College; and was placed in the Royal Marine Corps in his 13th year. He was transferred to the Guards; served with great distinction in Italy and the Netherlands; but having been refused promotion, upon account of some excesses of which he had been guilty, he behaved with great insolence to the minister at war, and was therefore condemned to death by a court-martial. Foreseeing this result, he fled to Germany, where, upon the recommendation of Prince Eugene, he obtained employment in the Austrian service. He now fought against his native country, distinguished himself by many daring exploits, was raised to the rank of lieutenant field-marshal, and bore a principal part under Prince Eugene in the war between Turkey and Austria. But when residing at Vienna, after the peace of Passarowitz, he made himself very disagreeable to the prince, and was therefore sent, in 1723, as master-general of ordnance, to the Netherlands, where he soon got into a scandalous quarrel with the governor, and was brought to trial, and condemned to death by a court-martial. The emperor commuted the sentence to one year's imprisonment; and upon condition of never again setting foot upon German soil, he was conveyed across the Tyrolese frontier. He went to Constantinople, was cordially welcomed, became a Mohammedan, took the name of Achmed, was made a pasha of three tails, was employed in organising the Turkish artillery after the European manner, achieved successes as general of a division of 20,000 men, in the war of the Porte with Russia, and arrested the victorious career of the Persian usurper, Thamasp Kuli Khan. For this service, the sultan appointed him governor of Chios; but his own imprudence, and the envy of others, caused his removal from this office. He now thought of leaving Turkey, but died at Constantinople on 27th March 1747. The memoirs published as his are spurious.

BONNYCASTLE, JOHN, long Professor of Mathematics at the Royal Military Academy, Woolwich, is well known as the author of many excellent elementary works, chiefly mathematical. He was

born at Whitechurch, Buckinghamshire, and died at Woolwich in 1821. His *Elements of Algebra* (2 vols. 8vo, 1813) is selected by a capable critic, from among his other works, as specially deserving of commendation.

BO'NNY RI'VEER, a river of Guinea, West Africa, forming the eastern debouchure of the Niger, and falling into the Bight of Biafra, in about lat. 4° 30' N., and long. 7° 10' E. It is accessible at all times of the tide to vessels drawing as much as 18 feet of water, and safe anchorage at all seasons of the year is found within its bar. Its banks are low, swampy, and uncultivated. On the east side, near its mouth, is the town of B., long notorious as the rendezvous of slave-trading ships. It exports considerable quantities of palm-oil.

BONPLAND, AIMÉ, an eminent botanist, was born at La Rochelle, France, August 22, 1773. Having studied medicine and botany at Paris, he accompanied Alexander von Humboldt in 1799 to America, where they travelled nearly five years, mostly in Mexico and the Andes, during which time B. collected 6000 new species of plants. After his return, he was appointed, in 1804, director of the gardens at Navarre and Malmaison, and published several splendid and valuable botanical works, *Plantes Équinoxiales Recueillies au Mexique*, &c. (2 vols., Par. 1808—1816, with 140 copper-plates); *Monographie des Mélastomées*, &c. (2 vols., Par. 1809—1816, with 120 copper-plates); and *Description des Plantes rares de Navarre et de la Malmaison* (11 numbers, Par. 1813—1817, with 64 copper-plates). He went to Buenos Ayres in 1816, with a collection of European plants and fruit-trees, was favourably received by the government, and named Professor of Natural History. After remaining at Buenos Ayres about five years, B. undertook an expedition of scientific discovery up the Paraña, with the view of prosecuting his investigations to the Andes, across the Gran Chaco Desert; but Dr Francia, then dictator of Paraguay, instead of giving him permission to cross the country, arrested him, after killing some of his men, and kept him prisoner for about nine years, notwithstanding the efforts of the British government, at the instigation of Humboldt, to obtain his release. While detained by Dr Francia, he acted as physician of a garrison. On the 2d of February 1831, he obtained his liberty, and travelling southward, settled on the southern boundary of Brazil, near the eastern bank of the river Uruguay, and in the vicinity of the small town of San Borja. Here he resided until 1853, taking great interest in cultivating and promoting the cultivation of Paraguay tea, and with no desire to return to Europe. In 1853, he removed to a larger estate at Santa Anna, where he busied himself in cultivating orange-trees of his own planting. In 1857 he wrote to Humboldt that he was about to carry his collections and manuscripts to Paris, to deposit them in the Museum there, and that after a short stay in France, he intended to return to Santa Anna. That voyage, his death in 1858 prevented him from accomplishing. His remarks on the herbarium collected in his travels with Humboldt, have been given to the world by Kunth in his *Nova Genera et Species Plantarum* (12 vols., Par. 1815—1825, with 700 plates).

BONUS, a special allowance, or extra dividend, to the shareholders of a company. If the previous dividend has been 4 per cent. on the capital, and if the profits of the current year admit of 5 per cent., a formal dividend of that amount would commit the company to a like dividend in future; and to prevent such a precedent, 4 per cent. is declared, and a B. of 1 per cent.

BONY PIKE (*Lepidosteus*), an interesting genus of fishes, being one of the few existing genera belonging to an order, *Ganoid Fishes* (q. v.), of which the fossil forms are extremely numerous, and the only existing genus, which, upon account of the number and arrangement of the bones of the head and other peculiarities of the skeleton exhibiting a resemblance to reptiles, is reckoned among *Sauroid Fishes* (q. v.). The body is covered with a case of dense bony square scales, so fitted together as to form a complete coat of mail. The vertebræ are articulated by ball and socket, and the head is capable of a degree of motion upon the trunk very remarkable among fishes, and compensating for the general stiffness of the mailed body, the skeleton of which is also bony, and not cartilaginous. The snout is elongated, and the edges of the jaws are furnished with long teeth, the breadth of the snout in some of the species giving it a resemblance to that of the pike. The tail is *heterocercal*, or unsymmetrical, the caudal rays being inserted not equally above and beneath the termination of the vertical column, but only at and beneath it, a character much more common in fishes of the old red sandstone than in those of the present period.—The species of this genus are pretty numerous, attain a large size, and are found in the rivers and lakes of the warm parts of America. They are much esteemed for the table.

BONZES, the Japanese priests of Fo or Buddha. The name is from the Japanese *Busso*. It was extended by the Portuguese to Buddhist priests in other countries, but particularly to the Chinese. See **JAPAN** and **BUDDHISM**.

BOO'BY (*Sula fusca*), a species of Gannet (q. v.), which has received this name from its apparent stupidity in allowing itself to be knocked down with a stick or taken by the hand. Accounts differ very much, however, as to this character of the B., some representing it as singular in not taking alarm or becoming more wary even when it has had reason to apprehend danger from man; others, as Audubon, asserting in such a manner as apparently to place it beyond dispute, that it does learn to be upon its guard, and even becomes difficult to approach within reach of shot. The B. is not quite so large as its congener, the common gannet or solan-goose, and, like it, is a bird of powerful wing, and feeds on fish, which it takes by diving in the sea, observing its prey as it sweeps along in graceful and varying flight, sometimes at a

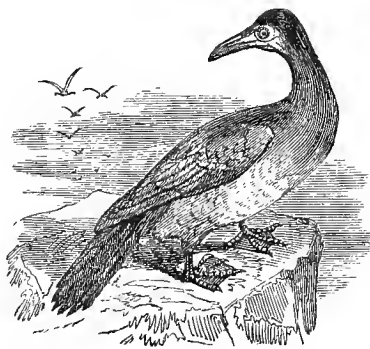

Booby.

height of only a foot or two from the surface of the water, sometimes twenty yards above it, and plunging suddenly to seize it. It is sometimes taken, like the gannet, by means of a

fish fastened to a board, through which it drives its bill, as it dashes at the bait. The B. is of a blackish-brown colour, whitish beneath; its colours are subject to some variation, and in young birds a general brown colour prevails; the sexes differ very little, except that the female is not quite so large as the male. It is found on almost all tropical and sub-tropical shores, and sometimes even 200 miles from land. On the east coast of North America, it reaches about as far north as Cape Hatteras, but is much more abundant further south, great numbers breeding on the low islands off the coast of Florida. The nest is often placed upon a low bush, and 'is large and flat, formed of a few dry sticks, covered and matted with sea-weeds in great quantity.' It contains only one egg or young one at a time. The expansibility of the gullet enables the B. to swallow fishes of considerable size. The bill, which is straight, conical, and longer than the head, opens beyond the eyes, as in the rest of this genus. The B. is much persecuted by the Frigate Bird (q. v.) and Man-of-war Bird (q. v.), more powerful birds and of swifter flight than itself, which often compel it to disgorge for their use the prey which it has just swallowed. The flesh of the B., although sometimes eaten by sailors, is dark coloured, and not very agreeable. Bligh and his companions, in his long boat-voyage, found one or two which they captured a providential supply of food.

BOOBY ISLAND, a level rock in Torres Strait, in lat. 10° 36' S., and long. 141° 53' E., 3 feet in height, and $\frac{1}{4}$ mile in diameter. Being, of course, highly dangerous to navigators, and destitute of resources of its own, it is said to be pretty regularly supplied with provisions and water by passing vessels, for the benefit of such as may be cast ashore on it.

BOODROOM, BOUDROOM, or BODRUN, a seaport town of Asiatic Turkey, in the pashalic of Anatolia, finely situated on the north shore of the Gulf of Kos, about 96 miles south of Smyrna, in lat. 37° 2' N., and long. 27° 25' E. It is an uninviting place, its streets being narrow and dirty, and its bazaars of the worst class; but as the site of the ancient *Halicarnassus*, the birthplace of Herodotus and Dionysius, it possesses great interest for the traveller. Many remains of the old city, which was 'the largest and strongest in all Caria,' bear witness to its former magnificence. A fortress, built by the Knights of Rhodes in 1402, occupies a projecting rock on the east side of the harbour, which is shallow but well sheltered, and resorted to by Turkish cruisers. Some ship-building is carried on. Pop. stated at about 11,000.

BOOK, a distinct literary production in one or more volumes; but the term book is also applied to a treatise, or group of chapters, forming a part of a volume, and traditionally it signifies a narrative, or record of some kind in the form of a roll: 'Lo, a roll of a book was therein; and he spread it before me; and it was written within and without.'—*Ezek.* ii. 9, 10. The term has a similar meaning in English law phraseology. 'In the Court of Exchequer, a roll was anciently denominated a book, and so continues in some instances till this day. An oath as old as the time of Edward I. runs in this form: "And you shall deliver into the Exchequer a book fairly written," &c., but the book delivered into the court in fulfilment of this oath has always been a roll of parchment.'—Godson and Burke *On the Law of Patents and Copyrights* (Lond. 1851, p. 323).

The word book is from the Angl.-Sax. *booc*, and, with some modifications of spelling, is common to

all the Teutonic and Scandinavian languages (Ger. *buch*; Dutch, *boek*). It is believed to be derived from the same root as *beech* (Angl.-Sax. *boe*; Ger. *buche*; Icel. *beyke*; Dutch, *beuke*), the earliest writing among those nations having been executed on the inner bark of the beech-tree, or perhaps carved on beech boards. The Greek word for a book, *biblos*, or more commonly, *biblion*, is derived from the Egyptian appellation for the plant papyrus (q. v.). The Latin word *liber*, a book, is derived from the name of the cellular tissue of the papyrus, instead of the plant itself. By the Greeks, a collection of books was called *bibliotheca*, and by the Romans, *libraria*; hence the French term *bibliothèque*, and the English word *library*; hence, also, the *librarian*, or book-writers, and *bibliopola*, booksellers, of the Romans. Properly prepared in long strips, the papyrus was wound round small cylinders, or rollers, which in Latin were styled *volumina*; hence the English word *volume*. As the papyrus has also given the term paper to the moderns, it has played an important part in the naming of what concerns books. Besides papyrus, however, the ancients used parchment and

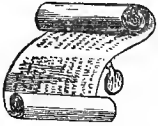

Book Scroll.

other materials for the fabrication of their books; and when, by the capture of Egypt by the Arabs in the 7th c., the papyrus plant could no longer be procured, parchment was the material generally employed.

By the Romans after the Augustan age, the art of fabricating books reached a degree of proficiency, along with the advancement in literature. The papyrus was carefully prepared; one side was reserved for the writing, and the other was coloured with saffron or cedar oil. The writing was effected by a pen made of a reed (*calamus*), of which the best kinds were supposed to be found in Egypt. The ink (*atramentum*) was very durable. In several rolls found at Herculaneum, the Roman ink, after being interred many centuries, is still in good preservation. When a Roman author wished to give his book to the world, a copy was put into the hands of transcribers (*librarii*), by whom a certain number of copies were produced. From these transcribers, who were equivalent to our modern printers, the copies passed to a class of artists (*librarioli*), who ornamented them with fanciful titles, margins, and terminations. The rolls were finished for use by the *bibliopecti*, or bookbinders; and last of all, they were offered for sale by the *bibliopola*, or booksellers. A copy of one of the esteemed productions of a Roman author—as, for example, a copy of Virgil or Horace—was an elegantly done-up roll, about thirteen inches in depth, wound round a cylinder, the two ends of which were decorated with ivory or metal knobs. Outside, it bore various decorations along with the title, and for safety was put in a neat case of parchment or wood, which also bore sundry ornamental devices, including perhaps a portrait of the author. A bookseller's shop in ancient Rome would probably show a collection of scrolls, less or more ornamented, not unlike in appearance to modern small maps mounted on rollers; and in this form books would be handed about and read. Prized for their rarity and costliness, these scroll-books were kept with great care in cases, or round-shaped boxes with lids, made of cedar; the odour of that wood being a preservative against moths and other destructive insects. Romans with a literary taste carried one of these boxes of scrolls with them as a portable library. A public library comprised a large variety of these boxes, and must have had the appearance of a

collection of round canisters. Yet the Romans did not invariably make their books in rolls; in some instances, they used leaves of lead, which had been beaten thin with a hammer, and also leaves of wood covered with wax; these loosely connected at the back with rings, may be viewed as the rude original of the modern book. At Herculaneum, books of this kind, called tablets, have been discovered in perfect preservation.

In producing books during the middle ages, the plan of rolls was dismissed, and that of leaves sewed together and enclosed in boards came generally into use. The material employed was still parchment, prepared from the skins of goats, sheep, deer, and other animals; for although the art of making paper was known in the 9th c., this new material came slowly into use. The fabricators of the books were for the most part different orders of monks, more particularly the Benedictines (q. v.), a learned and industrious body of men, whose peaceful establishments were long the great centres whence literature was dispersed in ages of intellectual darkness and social disorder. At the head of the book-manufacturing department in the monastery was the *armarian*, who besides taking charge of the library, gave out books to be copied, along with the pens, ink, and parchment required by the transcribers. Some of the monks were allowed to transcribe in the solitude of their cells, but the business of transcription was conducted chiefly in an apartment called the *scriptorium*, which was provided with ranges of desks and forms. There, the scribes or copyists, who were under strict regulations as to keeping silence, carried on their tedious but useful labours. The writing was effected in distinctly formed letters in an old character; regularity in the lines and pages being secured by previous ruling. There was an injunction that no one should on any account alter a single letter or word, without the sanction of the superior. With all the care that was bestowed, however, errors crept in, and were repeated from copy to copy, some of which mistakes have sorely puzzled the scholarly inquirers of later times. There was a division of labour in the monasteries. To some of the monks was assigned the duty of throwing in embellishments. With leaf-gold and brilliant water-colours, they adorned the devotional works, lives of saints, and copies of the Scriptures with pictorial illustrations and fancifully illuminated letters at the beginning of chapters. By another class of these monkish artists, the books were bound in styles suitable to the quality of the works. In many instances, the binding was superb. The boards of wood, covered with leather or velvet, were decorated with precious stones and devices in metal; and in front, the volume was held together with clasps of gold or silver-gilt. Skelton, the poet-laureate, in his *Garland of Laurel*, written about the year 1510, rapturously alludes to the splendid bindings of those old times:

With that of the boke losende were the claspis :
The margent was illumynid all with golden railles
And byse, enpicturid with gressoppes and waspis,
With butterflys and fresshes pecko taylis,
Enflorid with flowris and slymy snaylis ;
Envid [enuid] picturis well towchid and quikly ;
It would haue maid a man hole that had be right
sekely,
To beholde how it was garnisshyd and bounde,
Encouerde ouer with golde of tissew fyne ;
The claspis and bullyons were worth a thousande
pounde ;
With balassis* and charbuncles the borders did shyne ;
With *aurum musicum*† eucry other lynne
Was wrytin :

* Balassis—rubies.

† *Aurum musicum*—mosaic gold.

A book, usually known by the name of *Textus Sanctus Cuthberti*, preserved in the Cottonian Library, is a fine specimen of Saxon caligraphy and decoration of the 7th c. It was written by Eadfrid, Bishop of Durham; and Ethelwold, his successor, executed the illuminations, the capitals, and other illustrations, with infinite labour and elegance. Bilfrid, a monk of Durham, covered the book, and adorned it with gold and silver plates set with precious stones. We find also that Dageus, a monk who flourished in Ireland in the early part of the 6th c., was a skilful calligraphist, and manufactured and ornamented binding in gold, silver, and precious stones.—*Hannett's Inquiry into the Books of the Ancients* (Lond. 1843). Books of a common quality were plainly bound in parchment, and instead of clasps, they were tied in front with thongs. In order to enable monasteries to sustain the expense incurred by their book-fabricating establishments, they were occasionally endowed with lands by pious laymen, the bequests being expressly for 'the making and mending of books.' Among the works produced were copies of the Scriptures, in whole or in part; breviaries, or books of prayers used in the church-services; missals, psalters, books in philosophy, and copies of the Greek and Latin classics and fathers; also legends of the saints. Books of history, poetry, romance, &c., were less commonly transcribed; though, from the extent of some of the medieval libraries, these and various other subjects were not neglected. Indeed, but for the monks we should have possessed scarcely any chronicles of the middle ages; nor are we less indebted to them for the preservation of those classics which are now habitually used in our colleges and academies.

The method of dispersing the books was not less remarkable than that of their transcription. Some of the books were sold at exorbitant prices; some were executed to the order of kings, nobles, and church dignitaries; some were exchanged; and some found their way into the hands of the *stationarii*, or dealers in books, in the principal cities. It was customary to lend books for transcription, under an agreement to receive an additional copy on their return. In all cases of lending books, penalties were stipulated to be paid in the event of their not being restored. Latterly, there sprang up a practice among the *stationarii* of Paris, and some other cities, of lending out books, at certain rates, on the principle of a circulating library (q. v.), by which means the poorer class of students and others were accommodated. In these later times, also, as we approach the period when printing superseded transcription, the process of copying books began to be undertaken by lay scribes for a livelihood, of which there were examples in London. To the monks, however, and also to some orders of nuns, belongs the unspeakable merit of having not only supplied the religious orders with the books which were in daily use, but those which replenished the libraries of the learned and wealthy, until their ingenious craft was supplanted by that of the printer and bookseller. In the higher-class monasteries, there were libraries of from 500 to 1000 volumes; but many of the poorer conventual establishments could boast of no more than from 20 to 30 books. In the list of effects which belonged to a monastery in Scotland—St Serf, on an island in Loch Leven—there appear only 16 books; and yet, in this poorly provided insular establishment, the prior, Andrew Wintoun (1420), completed his *Orygynale Cronykil of Scotland*, a work in verse, which is not less valuable as a picture of ancient manners, than as a specimen of the attainments of the old monkish writers. But there are said to have been instances of a greater scarcity of books

than in St Serf's. Often, only two or three breviaries and missals, a psalter, and a copy of the Gospels, were all the books owned by a religious house. The possession of an entire copy of the Scriptures (the Latin version of St Jerome) gave immense importance to a monastery or church. Nor was this surprising, when the enormous labour of transcribing a Bible, letter by letter, is considered. Aleuin, a native of England, and one of the most industrious and ingenious monks of his time, occupied himself from about 778 to 800 A. D., a space of 22 years, in making a copy of the Bible for the Emperor Charlemagne. This ancient and extremely interesting monument of piety and labour is now in the British Museum, which became possessed of it for the sum of £750. The Museum is also enriched with a variety of missals and other works, executed by the monks. In the present day, it is scarcely possible to form a correct idea of the value put upon books, even of a common order, or of the prodigious care which was taken of them, during the middle ages. To preserve them from embezzlement, they

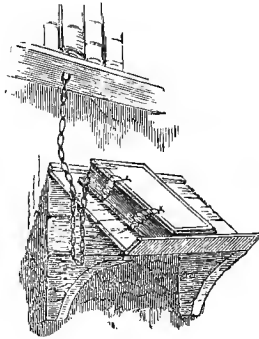

Chained Book.

were in some cases chained to shelves and reading-desks; and in the dwellings of nobles, a volume might be seen chained to a table in the hall, for the use of such members of the family as were able to read.

The establishment of universities in the 12th c. greatly stimulated the manufacture of books by transcription, more particularly those classics and philosophical treatises that were required by students in the colleges. The anxiety of the authorities in these schools of learning to insure accuracy in the text-books, as well as to prevent the use of books of an improper kind, led to the establishment of censorship and privileges which interfered with the preparation of, and traffic in, books, long after the invention of printing. Unfortunately, while this art was superseding the ancient process of transcription, the convulsions consequent on the Reformation caused an enormous destruction of books. In England, the libraries of monasteries, representing the labour of a thousand years, were mercilessly destroyed on the spot, or carried off and consumed in base purposes, without a thought as to their value. In Scotland, the monastic libraries which had escaped the ravages of Danish and other invaders, were similarly destroyed. The same fate overtook the ancient monastic libraries of France at the Revolution. See LIBRARIES.

In consequence of these deplorable events, as well as the perishableness of books, copies of works prior to the invention of printing exist only as rare and valuable curiosities. Even of the early printed books, there are comparatively few copies extant.

In England, books of improved typography and binding, adapted for ordinary libraries, date no further back than the reign of Queen Anne. In proportion as literature has been popularised, books have diminished in bulk and costliness. In the 16th and 17th centuries, the ordinary sizes of books were folio and quarto; and as works of these huge dimensions embraced light as well as much ponderous literature, a popular poet uses no metaphor, when he observes that ladies 'read the books they could not lift.' The dignified quarto survived in imaginative literature even till our own times; for it was in this costly form that the early editions of the poetry of Scott, Byron, and others made their appearance. Excepting for special purposes, all such large sizes are happily superseded by octavos and still lesser-sized books. Forms and prices are no longer for the few, but for 'the million.' And copies of the Bible, instead of being chained to shelves and desks, and being valued at hundreds of pounds, are now scattered in myriads at the easy charge of a shilling.

The dimensions of printed books are regulated by the size and form of the sheets of paper of which they are composed. A sheet, being folded in the middle, forms two leaves, or four pages; and a book of this size is called a folio. When the sheet is again folded, so as to make four leaves, or eight pages, it forms a quarto. The quarto, being folded across, so as to make eight leaves, or sixteen pages, forms an octavo. By folding the sheet into twelve leaves, or twenty-four pages, we make a duodecimo; and if into eighteen leaves, or thirty-six pages, we form an octodecimo. Below this there are small books of different denominations, and which are sometimes spoken of as pocket editions. Booksellers are accustomed, in speech, to Anglicise the terms for the sizes of books, with little regard to the proper terminations—as 4to, 8vo, 12mo, 18mo, 24mo, 32mo, 48mo, &c. For a long period, printing-paper was made chiefly of three sizes, respectively called royal, demy, and crown; and according as any one of these was employed, the size of the book was large or small. Demy, however, was the most commonly used, and the demy 8vo may be said to have become the established form of standard editions of books. As by means of the paper-making machine, paper is made in webs, and can be cut into every imaginable size of sheet, and as printing-machines can print very large surfaces, the sizes of books are now comparatively arbitrary; though, for convenience, the old names remain, with the difference, that instead of the 12mo, a not very dissimilar size, called the post-8vo, has come extensively into use. The size of the present work is large royal 8vo.

A thin kind of book, consisting of a few sheets sewed or stitched together, without boards, is called a pamphlet—a term supposed to be derived from the French words *par fil*, 'by a thread.' The French term *brochure* (from *brocher*, to stitch), signifying pamphlet, is coming into use; as also the French word *livraison*, signifying a portion of a book (group of volumes) published separately. For an account of the modern traffic in books, we refer to the article BOOK-TRADE. w. c.

BOOKBINDING, the art of connecting together in a durable and convenient manner the several parts of a book. The craft of the bookbinder is older than that of the printer. As noticed in the preceding article, the Romans had their *bibliopegi* for doing up their books in rolls; and during the middle ages, the binding of books in a square form was executed by certain orders of monks. As the first style of typography was an imitation of the penmanship employed in Bibles and Missals, so was the binding of the first printed books only a copy of what

had been usual in doing up volumes of manuscript. But as printing greatly multiplied books, binding got out of the hands of the monks and other ingenious men who had hitherto carried it on, and assumed the character of a widely dispersed mechanical art, which, like other useful arts, has gone on improving till the present day. It says little for the taste or tact of the Germans, that they, the inventors of printing, should have long since been left behind, not alone as regards typography, but binding, and everything else connected with the preparation of books. The French have exerted their fine artistic taste in binding, and take the lead in this branch of art among continental nations. In the French language, the term *relieur*, used for bookbinder, has oddly enough the same root as *religion* (religio, to bind again). To the English belongs the merit of carrying the art to a high degree of perfection; for no bookbinding in the world excels that of London in solidity, elasticity, and elegance—the three great requisites of a well-bound book—which have been arrived at, not less from skill in manipulation, than the excellence of tools, and the prices which are ungrudgingly paid by wealthy book-fanciers. Reaching this advanced stage, bookbinding forms a regular craft, distinct from printing and bookselling, though in country towns it is sometimes united with these professions. Properly conducted, it is divided into the three departments of preparing, forwarding, and finishing; but in these there are many subdivisions of labour, a few of which may be referred to.

On coming from the press, sheets are first dried by being hung on poles for a length of time, and then smoothed by pressure, singly, between glazed mill-boards in a powerful hydraulic press. They are next collated or arranged in distinct books in quires, in which form they are delivered to the publisher. If, however, for immediate sale in 'cloth boards,' the sheets are transferred in masses from the printer to the binder, and treated as follows: The first operation is to fold the sheets, by means of a small instrument called a folder. The object is to fold down the different pages so as to fall on one another; and on the perfect accuracy with which this is performed depends the proper binding of the book. Attempts have been made to introduce machines for folding, but none has worked satisfactorily, and this operation is still performed by hand; usually the work is done by girls. After being folded, the sheets of the book are gathered and collated according to the 'signatures,' A, B, &c., which are printed at the bottom of the first page of each sheet. The books so made up and completed, are now pressed to a proper solidity, by being placed in quantities in a hydraulic press. The next process is to saw indentations in the back of the book, preparatory to sewing. If only a few volumes are to be sawed, the operation is executed with a tenon saw; when, however, there are large numbers, the books are placed on a machine with revolving saws, which instantaneously effect all the indentations. The books are next sewed on a frame, each sheet being less or more attached by a thread to cords across the back. The sewing, like the folding, is executed by girls. On being removed from the sewing-frame, the book receives its 'waste papers,' which are pasted to the back on each side. The book is now 'trimmed,' by being cut on the edges with a knife-apparatus. In some instances, this is effected by the plough-machine on the screw lying bench; in others, the books are piled on a machine, beneath a broad knife, which descends like a guillotine, and a large number are cut with amazing expedition. The books are next glued on the back, to impart a certain degree of firmness. After this, they are 'backed' by means of a machine of

recent invention, which imparts a certain roundness to the back, and at the same time gives a seat for the boards. The book, with a slip of canvas pasted on the back, is now ready for receiving the boards, which are previously cut in large quantities by a machine.

The preparing and attaching of the cover forms the final stage of the process. For the whole of the class of boarded books we have been describing, there is a method of making 'cases.' A case consists of cloth or paper pasted on two boards, the distance of the boards from each other being equal to the thickness of the book. The case being finished, receives the book, to which it is attached chiefly by pasting it to the canvas of the back and the blank or waste paper on each side. When the cases are in paper, they are at once applied in this manner, and the books may be said to be finished and ready for sale. Such is the mode of doing up that prodigious host of flashily covered volumes which forms a leading product of the cheap press. If the cases are in cloth, there are additional manipulations, in all of which machinery is employed.

Formerly, the ornamental and other work on the

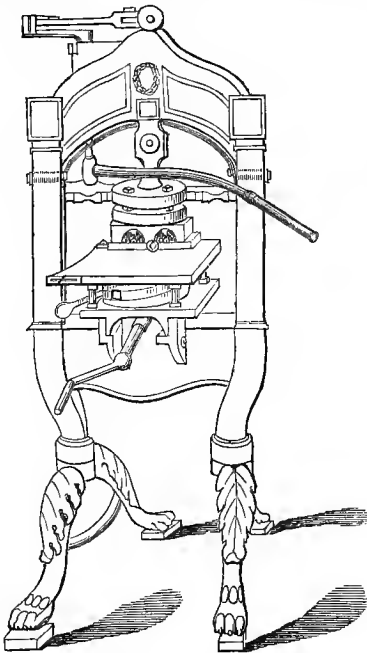

Arming-Press.

outsides of books was executed in a tedious and expensive way by hand. Now, the operation, at least as regards cloth boards, is done by two or three impressions in an arming press; perhaps not more than half a minute being employed to execute what in the olden time would have occupied a week. This improvement, the greatest in the art of book-binding, has been facilitated by an advance in the artistic skill of designers, by advancements in the art of die-sinking, and by corresponding adaptations of machinery—the whole unitedly working towards an end. When it is deemed necessary, for the sake of attractiveness, to stamp a peculiar device on the covers of a book, of which thousands are required, the design is referred to an artist, who, devoting himself to this branch of his profession, devises something appropriate and original. His design,

drawn on paper, is cut in brass or steel; and this, in the form of a metal block, gives the stamp at a blow by the arming-press. When the design is to be gilt, leaf-gold is previously applied. The block being heated, gives a firm and clear impression. Such is the expeditious method of titling and ornamenting with blank and gold tooling the cloth-covered books that are now generally in use.

Books bound in leather, of course, go through a more slow and careful process of forwarding and finishing. Formerly, the folded sheets were beaten with a broad-faced hammer on a stone, but now they are squeezed between steel rollers, to give them the required solidity. The sewing, gluing of the back, backing singly with a hammer, and the other manipulations which follow, are all effected with great deliberation and nicety; and in this department of binding the highest class of operatives are employed. At one time, the titling of bound books was executed letter by letter, and comparatively few men had sufficient skill and steadiness of hand to produce good work. Now, lettering is sometimes done by means of metal types put together in a small case; though, when numbers are to be executed, the title is cut in block. It is usual also to apply stamps in block to the sides of bound books, and to leave only the finer and smaller tooling to be done by hand. Yet, although greatly assisted by new mechanical contrivances, the finisher must needs be a kind of artist. Coming to his hands flat and solid, and with its joints well formed, through the previous care of the forwarder, he delivers the book a perfect work of art. It opens easily, and lies flat out without any strain; its hinges are finely formed without crease; and on back, edges, and sides, the tooling claims mathematical precision.

A method of fixing together the leaves of a book by means of caoutchouc, or India rubber, instead of by sewing, has been invented. The sheets are cut into leaves, and the back edges, being laid evenly, receive a solution of this tenacious material. As each leaf is held merely by the caoutchouc which adheres to it, the book can be made to lie very flat; but this new kind of binding is only employed for maps, or books of plates, and does not seem likely to come into general use. Another novelty in binding is the substitution of wood for pasteboard boards, in imitation of books of ancient date. Applied only to some costly books of a fanciful kind, this must be considered to be but a passing caprice; for as wood is liable to warp, it can never serve so well as pasteboards.

In the present day, the binding-trade is pursued in various distinct branches. There are binders who devote themselves entirely to doing up books in cloth or paper; others execute general binding in leather; a third class bind only account-books; a fourth confine their workmanship to Bibles and Prayer-books; and a fifth are known as binders of books in a high style of art. A common defect in provincial binding is a want of taste. Strength is given without elegance; even in the finest kind of books, there is often a vulgarity as regards the colours of the end papers, and the marbling of the edges, as if the binders were unconscious of proper delicacy of effect. The same thing may almost be said of the best American binding.

Among celebrated English binders of a past age, the foremost place is usually assigned to Roger Payne, a clever but wayward being who carried on business in the west end of London about the year 1770, and who, from his unfortunate habits, died in great poverty. His reputation as a binder rests principally on his fine tooling and choice of ornaments, in which department he introduced many improvements. The greatest of Payne's successors

was Charles Lewis, a London binder (1786—1836), whose talent, according to Dr Dibdin, 'consists in uniting the taste of Roger Payne with a freedom of forwarding and squareness of finishing peculiarly his own. His books appear to move on silken hinges; his joints are beautifully squared, and wrought upon with studded gold; and in his inside decorations he stands without a compeer.' At present, there are several eminent binders in London, whose forwarding and finishing, as well as artistic decoration, have given them a deservedly high reputation. W. C.

BOOK-CLUB, or BOOK-SOCIETY, an association of individuals for purchasing and reading new books as they issue from the press, which, after being circulated among the members, are sold for the benefit of the concern. In some cases, the used books are disposed of by auction among the members. Book-clubs exist in many of the large towns and rural districts of Great Britain. Although new in name, and mostly composed of persons in the higher ranks of life, they are established on plans similar to the more humble class of reading societies which were common in different parts of the country in the latter part of the 18th century. In some places, the more fashionable book-clubs have been superseded by the late re-invigoration of the system of circulating libraries (q. v.). W. C.

BOOK-KEEPING is the method of recording business transactions in a set of blank-paper books kept for the purpose, by all classes of traders, as well as in various kinds of establishments. Viewed as an art, B. was first brought to comparative perfection by the merchants of Genoa and other cities in the north of Italy; and followed up by the merchants of the Netherlands, it has been brought to England, in which country, as also in the British colonial possessions and the United States, it is now carried on in the best manner by professional accountants and skilled clerks in counting-houses. The books employed are usually of a folio size, strongly bound. For security against loss, it is customary to remove them every night from the desk and ordinary shelves in the counting-house to a fire-proof safe.

Although reduced to an accurate system, the details of B. necessarily differ according to the extent and the nature of the transactions to be recorded. In all kinds of B., however, there are or ought to be certain pervading principles, to which we shall in a brief way refer. The object is to keep an account of the goods a trader buys and sells, and the money he receives and pays away; also to shew, at short and periodic intervals, the exact state of his affairs—what are his *assets* (property and sums of money owing to him), and what are his *liabilities* (debts owing by him, and other pecuniary obligations). On the proper accomplishment of this object may be said to depend the stability and the reputation of the trader. Such is obviously the case, for, unless a person keep an accurate set of books to enable him to ascertain how his affairs stand, he must in a great measure be proceeding upon vague, and possibly erroneous conclusions; the result of which may be insolvency or bankruptcy, and loss of good name. In many instances, bankruptcy is traced to no other cause than the keeping of an insufficient set of books, and even keeping these badly. Viewed as credentials, a merchant's books are invested with a certain sacredness of character. Such a set of them is to be kept as will at all times admit of making up statements of affairs satisfactory not only to the trader himself, but to his creditors. On this account, they require to be kept with great neatness, accuracy, and perspicuity. As a rule, there must be no blotting, no scraping out of words or figures, and no tearing out of leaves—the records are to be beyond suspicion of falsification.

SINGLE ENTRY.—The simpler kind of accounting is called B. by Single Entry; the principal books used being the Day-book, Invoice-book, Cash-book, and Bill-book, which are employed for recording the transactions as they occur, and a Ledger, to which the entries are afterwards transferred, under the names of the parties concerned. The method is called Single Entry, for the reason that each item is entered only once in the accounts in the ledger.

Day-book.—The purpose of this book is to keep a daily account of all goods sold on credit—that is, goods not paid for at the time of being bought. The book is ruled with a date-line on the left-hand side of the page, and with double money-lines at the right-hand side. The entry of a transaction comprehends the name of the purchaser, and beneath it a note of the articles sold, with the prices extended to the first money-column. The gross amount added up is extended to the second money-column; so that the amount of all sales may easily be summed up. After the name of the purchaser, it is usual to put *Dr*, and to articles in the entry is prefixed *To*—the meaning of these insertions being that the party named is *debtor* to the concern for the articles mentioned.

Invoice-book.—This book, which is similarly ruled, is sometimes called the *Credit Day-book*. It is used for keeping an account of all goods bought on credit. When the goods are received, an invoice, or account of them, accompanies the package, or precedes it by post, and on being checked off, the items are copied into the book. After the name of the seller of the goods is inscribed the contraction *Cr*, and to the items entered is prefixed the word *By*—the meaning of which is, that the party named is *creditor* by having sold the articles named. For the sake of brevity, some dealers merely enter the name of the creditor, the date, and the amount; and preserve the invoices, by docketing and tying them up in parcels, or by fastening them loosely into a coarse paper-book prepared for the purpose. In any form, the invoices should always be preserved.

Cash-book.—In this is kept an account of all cash received and paid, and of discount received and allowed. It is ruled for date and double money-columns on each page. Two pages, one opposite the other, are required for the entries; that on the left hand for entering cash received, and the discount allowed *by* the trader; that on the right hand for the cash he pays, and the discount allowed to him. The first money-column on each page is for the discount, and the second for the cash. For example, if a person settles his account, amounting to £5, less a discount of 5s., the sum of 5s. is entered in the first column, and £4, 15s. in the second; by which means a record is kept of accounts settled and the money actually received. A similar explanation applies to the 'cash paid' side. At the close of business for the day, the amounts on both sides are summed up and balanced.

Bill-book.—This contains an account of all 'Bills Receivable'—that is, bills of which the trader is to receive payment; and 'Bills Payable'—that is, bills which he has to pay. Sometimes, however, in the case of large concerns, these two classes of bills have each a distinct book. The books are ruled in a particular manner, to admit of an explicit statement of dates, amounts, length of term, and other particulars.

Ledger.—This is the great book of the concern. It comprehends an abstract of the entries in the day-book, invoice-book, cash-book, and bill-book, the whole collected in a methodic form under the names of the various persons, whether standing in the relation of debtors or creditors to the trader;

and not only so, but an account of the trader's own private debit and credit. Two sets of columns are assigned to every person's account, one for *Dr*, and the other for *Cr*. The copying of items from the day-book, &c., into these ledger accounts, is termed posting. According to the ordinary practice, books are posted after short and regular intervals—not longer than a month. Having books at all times well posted up is an acknowledged mark of a good man of business. By means of a well-posted ledger, and an inventory of stock and other assets, drawn up with a prudent regard to realisable value, the trader is able at the end of a year to make a *Balance Sheet*, or condensed statement of his affairs. A proper balance-sheet ought to shew the amount of capital invested in the form of money, stock, debts, &c.; also the amount of liabilities, the expenses at which the business has been conducted, the money drawn on private account, and the profit that is over, after all deductions have been made.

Some other books of a subsidiary kind are kept by large trading houses—as an *Order-book*, in which copies of all orders are entered; a *Waste-book*, for memorandums; an *Account of Sales-book*, from which particulars are obtained for making out accounts of the sales of goods which may have been sent for disposal on commission; a *Stock-book*, in which an inventory is kept of the stock on hand; a *Bank Pass-book*, into which sums sent to and drawn from the bank are entered; and a *Letter-book*, into which all letters sent out by the firm are copied.

With such a set of books, and a few additional memoranda, a trader could doubtless strike a balance at the end of the year. He could see how much was owing to him, how much he was owing to others, how much he had spent, and how much would remain over, or how much would be deficient, after all accounts *pro* and *con* were settled. But by this elementary routine he could establish no satisfactory check on different departments of his business; and for large and complicated concerns, the system, if not absolutely valueless, would prove exceedingly imperfect. What the wholesale-trader wants is a process of checks—one book checking another—the whole thing reduced to such a rigorously methodised system of entries that every fraction is thoroughly accounted for. No doubt, to effect this elaborate and minute system of B., a considerable expense is incurred for clerks; but in large establishments this is of small account in comparison with the advantages that are secured.

DOUBLE ENTRY.—The method of B. which has been so called is only an extension of that already noticed. The distinct peculiarity in double entry chiefly concerns the ledger. Its object is a system of checks, to be effected by entering transactions in the ledger twice—first to the *debtor* of one set of accounts, and then to the *creditor* of another set. In making the two entries, one is a real account under the name of the debtor or creditor, and the other is a nominal or imaginary account, under the head of the goods that have been bought or sold. Take, for instance, the article sugar. Say, the trader purchases a hogshead of the article from A. B. & Co. He first enters it in the regular way to the *Cr* of A. B. & Co., and then turning to the folio headed 'Sugar,' he enters it on the *Dr* side of the account as bought from A. B. & Co. In the same way, when the hogshead is sold to E. F. & Co., it is entered first to the *Dr* of these parties, and then under the *Cr* side of sugar as sold to E. F. & Co. By this system of double entries, one the counterpart of the other, the nominal constantly check the real or personal accounts; and a trader can at all times tell how, when, and at what prices his

property has been disposed of, without analysing general accounts.

In double entry, a book called a *Journal* is frequently used. The entries in the day-book, &c., are abstracted into the journal, and thence posted in a brief form into the ledger; the use of the journal, therefore, is only to save the ledger from being burdened with details.

Acknowledged to be the triumph of accountants, B. by double entry, or by the Italian method, as it is sometimes called, is not an entire safeguard against frauds and fallacies in the conducting of commercial operations, which, independently of every technical aid, require to be sustained by constant integrity, vigilance, and discretion. Among the fallacies in the method of keeping books which are observed to sap the stability of the most gigantic concerns, are two so conspicuous as to demand our notice. The first consists in including bad or nearly worthless debts in the periodical lists of assets. The second is that of not estimating stock at its realisable value only. This last may be said to be a common error among traders, many of whom, without any evil intention, and simply from want of prudent consideration in making due allowance for depreciation of property, delusively and gradually slip into a condition of hopeless insolvency.

B. forms a department of school education in connection with penmanship and arithmetic. To assist scholars, there are various useful treatises on the subject, with proper forms for day-book, ledger, and other books. Two of the larger and more comprehensive of this class of works are, *A Complete System of Book-keeping*, by Benjamin Booth (Lond. 4to), and Jones's *Science of Book-keeping Exemplified* (Lond. 4to). Among the lesser and more accessible treatises we may specify *Book-keeping by Single and Double Entry*, by W. Inglis (Edin. 1858). It is proper, however, to add, that no method of school instruction can supersede the practical knowledge which is to be procured only in a busy and well-conducted counting-house. W. C.

BOOK-STALLS. See BOOK-TRADE.

BOOK-TRADE, the business of dealing in books, in which are comprehended two classes of persons—Publishers, who prepare and dispose of books wholesale; and Booksellers, to whom the retailing of books more properly belongs. Although ordinarily distinct, the two professions may conveniently be treated together. While publishing, properly speaking, is of modern date, the selling of books is as old as the origin of literature. Copies of the works of authors in manuscript were sold in the cities of ancient Greece and Rome. Horace celebrates 'the brothers Sosii' as eminent booksellers (*bibliopola*). With the foundation of several universities in the 12th c., the preparation and sale of books increased; but the trade of bookselling cannot be said to have attained to importance till after the invention of printing. The first printers acted also as booksellers, and being for the most part a learned class of men, they in some instances were the authors of the works which they produced. See PRINTING. Fust and Schœffer, the partners of Gutenberg (q. v.), carried the productions of the Mainz press to the fair of Frankfort-on-the-Main and to Paris. Some instances of division of the two branches, printing and bookselling, occurred in the 15th c. John Rynmann of Augsburg (1497—1522) styled himself, at the conclusion of his publications, 'Archibibliopola of Germany.' In consequence of the Reformation, the seats of learning were gradually removed from the southern to the northern states of Germany, and, of course, the booksellers followed their customers.

Migrating from place to place, and also resorting

to the great continental fairs for customers, the early booksellers became known as *stationarii*, or stationers, from the practice of stationing themselves at stalls or booths in the streets, as is still customary with dealers in old books. The term stationer was long held to be synonymous with bookseller, but in modern times it is more commonly applied to dealers in paper and other writing materials.

Whether settled or migratory, the early publishers and sellers of books were subject to a number of restrictions, as is still the case in various continental countries. In England, the book-trade was trammelled by royal patents and proclamations, decrees and ordinances of the Star Chamber, licences of universities, and charters granting monopolies in the sale of particular classes of works. In 1556, in the reign of Mary, the Stationers' Company of London was constituted by royal charter, the professed aim being the 'removal of great and detestable heresies.' The members of the Company were made Literary constables to search for books, &c., and it was ordered 'that no man should exercise the mystery of printing, unless he was of the Stationers' Company, or had a licence.' The charter, which was confirmed by Elizabeth in 1558, in effect empowered the company to make ordinances as to the printing and sale of books, and to exercise an arbitrary censorship of the press. The Crown, by an act 13 and 14 Car. II. c. 23, commonly called the 'Licensing Act,' assumed this species of control over the issue of books. The Licensing Act, and its renewals, ultimately expired in 1694. By the first Copyright Act, 8 Anne, c. 19, the legislature interposed to protect the rights of authors, and to relieve them, as well as publishers, from the thraldom of the Stationers' Company. But by the same act, the Archbishop of Canterbury, the Lord Chancellor, and certain judges in England, and the judges of the Court of Session in Scotland, were empowered, on the complaint of any person, to regulate the prices of books, and to fine those who sought higher prices than they enjoined. This provision was in force till 1738; when it was abolished by the act 12 Geo. II. c. 36. From this time the book-trade was free. How it spread and flourished may be best learned from the history of the literature with which it is identified. Subsequent to the reigns of Anne and George I., there was a succession of men of literary repute connected with the metropolitan book-trade; among whom may be mentioned Cave, the conductor and publisher of the *Gentleman's Magazine*, and early patron of Samuel Johnson; and Dodsley, a poet and dramatist, who reached the head of the bookselling profession. We might also almost include Richardson the novelist, for, though a printer, he in 1754 became master of the Stationers' Company. The names of Baldwin, Rivington, Longman, Tonson, Millar, Cadell, Dilly, and Lackington, besides many others, will also be as familiar as are the Knights, Bohns, and Murrays of later times.

Now, as formerly, the book-trade is centered in London, though carried on to a considerable extent in Edinburgh, and in a less degree in Oxford, Cambridge, Dublin, Glasgow, and a few other places. There are various reasons for London being the metropolis of English literature. As a centre of wealth, taste, and intellect, authors flock towards it as an agreeable and permanent home, and find in the Library of the British Museum the most ample materials for reference and study. By means of its system of railways, and its port, assorted parcels of books can be conveniently despatched to all parts of the United Kingdom, and of the world. It has numerous wholesale stationers, and abounds in printers, bookbinders, artists, and wood-engravers. Stationers' Hall, in which the rights to literary

property may be inscribed, is situated in London. Through its channels of literary intelligence and criticism, it possesses the most ample means of making new works known. Through favour of these circumstances, the metropolis becomes the centre of the British book-trade; almost every new work floats towards it, either for publication or to be issued wholesale on commission. In 1860, there were connected with the book-trade, within the bounds of the metropolitan post-office district, 211 booksellers who were also publishers, 566 booksellers alone, besides 23 foreign booksellers, and 12 law booksellers—total 812. Among the booksellers are included commission-houses; and among the publishing establishments are several branches from Edinburgh and other places. The London book-trade is partly carried on in distinct departments; miscellaneous literature, law books, medical books, educational treatises, periodicals, &c., respectively engage the attention of publishers; and as regards religious books, each sect may be said to have publishers and booksellers of its own. The greater number of the publishing and commission houses are situated in Paternoster Row and the courts adjoining; so that this part of the city has become the great and acknowledged market for literature. In whatever part of the metropolis books are primarily issued, they may be found in one of the establishments in or about 'the Row,' by which means the collecting of books to meet country or foreign orders is effected at once on the spot. Every commission-house has one or more 'collectors,' who, with bags, are seen hurrying about, picking up the works which are entered in their collecting-book. When not so found, books are said to be 'out of print.'

In Scotland, after struggling through an age of similar restrictions, the book-trade was developed about the middle of the 18th c. In Edinburgh, it was followed by Allan Ramsay, who published and sold his own songs, and his still more charming pastoral. Among his successors were Donaldson, Bell, Elliot, and Creech, each eminent in his way; more lately, the trade was ably sustained by Archibald Constable, the first publisher of the *Edinburgh Review* and *Waverley Novels*; and by William Blackwood, the originator of *Blackwood's Magazine*; still more recently the reputation of the Edinburgh book-trade has been maintained by Adam Black, publisher of the *Encyclopædia Britannica*, and who, besides rising to the highest civic honours, became member of parliament for his native city, on the retirement of Mr (afterwards Lord) Macaulay (1855).

Considering the many advantages possessed by London, it may appear surprising that the business of publishing should be attempted to any extent in Edinburgh—the only place out of the metropolis to which we need specially refer. Yet, the Scottish capital is not devoid of recommendations. Its general society is of a character to invite the residence of men of literary acquirements, and it is fortunate in possessing an extensive collection of books for reference in the Library of the Faculty of Advocates. Edinburgh publishers are able to conduct their enterprises with a degree of calmness and deliberation which can scarcely be realised in London; while, at the same time, they enjoy a certain advantage in comparatively cheap labour. Paper also may be obtained at a somewhat lower price from Scotch makers than from the wholesale stationers of London—this last circumstance being of first importance in producing large impressions of cheap books and periodicals. As Edinburgh books are mostly sent to London, the expense of carriage and loss by commission form a drawback on profits. Notwithstanding this and other disadvantages, the

book-trade of Edinburgh continues in a thriving condition. In 1860, it comprehended upwards of thirty firms carrying on the united business of publishers and booksellers, and ninety as booksellers alone. In this list are eight or nine leading publishing houses, all of which, with one exception, print the works which they issue—an economical and convenient union of professions which forms a peculiar feature of the Edinburgh book-trade. In the establishment whence the present work is issued, every department connected with the preparation and dispersion of books is included.

The publishers and booksellers of the United Kingdom possess no corporate privileges, nor do they associate for any professional object. No premiums are offered to stimulate improvements in typography, binding, or anything else—the trade being entirely free, and all being left to rise through individual exertion. All members of the profession, however, constitute what is, *par excellence*, 'the trade,' through which there is a pervading and strong feeling of fellowship.

In the infancy of the trade, authors frequently resorted to the plan of getting friends and patrons to subscribe for copies of their forthcoming works; the publisher in such cases acting only as commission-agent. Literature has risen above this degrading system. Now, the author (1) sells his work in manuscript to the publisher for a specified sum, giving him an assignment to the copyright, and leaving him to bring out the work according to his own fancy; or (2) the author retains the copyright, pays all expenses, undertakes all risks, and gets a publisher to bring out his work; or (3) the author, retaining the copyright, incurs no risk, and only allows the publisher to print and issue an edition of a certain number of copies for a sum agreed on; or (4) the author and publisher issue the work at their joint risk, and on such other terms as are mutually agreeable. In some instances, the publisher will not undertake to issue a work, unless the author gets it printed, and delivers copies ready for sale; in others, he will relieve the author of this trouble, and risking outlay, keep an account of charges and sales. Any plan by which an author retains a risk, is seldom satisfactory. Publishing is an exceedingly hazardous profession. Works of which the highest expectations are formed may not pay expenses; and books of a very frivolous and seemingly worthless kind may prove exceedingly remunerative. From a general misapprehension on this point, publishers have frequently been maligned as unjustly living on the brains of authors, who are ever represented as an unfortunate and ill-used race. A knowledge of the hazardous nature of publishing, and of the heavy expenditure ordinarily incurred for making new books known, not to speak of the unreasonable expectations which are sometimes formed by literary men, would do much to dispel the common notions on the subject. For one book that is highly successful, there are numbers that become a dead stock in the warehouse, and barely pay expenses, of which melancholy fact too many authors who undertake the expenses and the risks of publication must be well aware. We feel safe in averring, that with writers of really popular works, English publishers usually deal in a most liberal spirit; instances, indeed, could be cited in which they have voluntarily and largely added to the remuneration stipulated to be given for copyright. The latest case of this kind coming within our knowledge, is that of the celebrated sermon, *Religion in Common Life*, preached before the Queen, by the Rev. John Caird (1855), for which, though only a shilling pamphlet, the publishers, Messrs Blackwood of Edinburgh, gave £100; but

the sale having gone far beyond expectations, they afterwards, of their own accord, presented the author with an additional sum of £400. Facts like this, while reflecting honour on the book-trade, shew the baselessness of the imputations so inconsiderately cast on publishers as a body.

In publishing new books, the following are the items of outlay which need to be taken into account: Paper, composition per sheet, author's corrections, press-work or printing per sheet, embellishments, binding, advertising, 20 or more presentation copies to editors for review, 5 copies given to public institutions in terms of Copyright Act, and commission on sales. We have also known charges made for fire-insurance and warehouse-room for stock, also interest on outlay. An account is rendered annually, or in some cases every half-year. Supposing there is an overplus in favour of the author, the amount is usually payable by bill, or a deduction equal to the discount of the bill is made from the amount. It is proper, however, to say that only certain publishers make these extra claims on authors. The usual commission is 10 per cent. To understand on what sum this falls, it is necessary to know the extent of trade allowances. For every book, there is assigned a distinct selling price to the public, and it is very commonly stamped or printed on the cover or written within the boards. From this price the publisher makes an allowance of 25 per cent. (3d. per 1s.), the book being placed to a running account of six months, which is rendered to the bookseller at the end of June and December. If the account be settled in cash within one month thereafter, a discount of 2½ per cent. is made from the gross amount. If settled by bill at three months, no discount is given. Were publishers in all cases to deal directly with the retail bookseller, we should have in the above the whole amount of deductions. But in much the larger proportion of cases, there is interposed the commission-agent. Several London publishers have commission-agents in the principal towns, to whom they consign quantities of each work for sale to the retail dealers; and in the same way, provincial publishers having agents in London, it happens that the book-trade is largely and necessarily carried on through middlemen. These individuals, of course, receive a commission adequate to remunerate them, after giving the ordinary publisher's allowance to the retailer.

It is usual, on issuing new books, for publishers or their agents to send out the work to be 'subscribed' among the trade. A copy of the new work is shewn by way of sample, and the subscription paper bears the selling price, and the price at which copies are offered. Besides making the trade acquainted with the day, and even hour of publication of works which have been some time expected, this practice offers an opportunity for speculating. As an encouragement to do so, the work is offered at a somewhat lower rate than is afterwards allowed; and, as a still further inducement to subscribe, it is by no means uncommon to offer 13 copies as 12, or 25 as 24. By subscribing for books in this manner, and also by means of 'trade sales,' commission-houses in the Row ordinarily put themselves in possession of the works issued by publishers in other parts of London.

Trade sales, which are now less common than formerly, are conducted in the following manner. A publisher, wishing to get quit of a large part of his stock, issues a catalogue to the trade, stating the reduced price of each book, as well as the length of credit offered; and that the sale is to take place in a tavern specified, on a certain day, for which an invitation is given. At the

appointed time and place, a handsome dinner is on the table, and perhaps from a hundred to two hundred guests are assembled. Nothing is said about business during dinner, but with the wine and glasses afterwards, and amidst no little good-humour, the sale begins. Each book being called over, every person has an opportunity of saying how many copies he will take. Occasionally, a toast is proposed, in order to maintain the hilarity of the meeting. At these sales, it is not unusual to dispose of 'remainders of books,' that is, fag-ends of editions which are not moving off with sufficient alacrity in the ordinary course of trade. Remainders are either offered in small quantities at a very reduced price, or they are sold in the lump by auction. Purchased cheaply, these remainders are henceforth known as 'books with broken prices.' Many of the new-looking books ticketed on stalls are portions of these remainders. In some instances, they are sent to the colonies, in the hope of finding a market. At these trade sales, it is common to do business to the extent of from £5000 to £10,000; in the case of one publishing house, the amount is usually, at a half-yearly sale, from £12,000 to £15,000; and in another, being an annual sale, it is seldom less than £26,000. To avoid the seemingly useless outlay on a dinner, some publishers rely on the circulation of 'sale catalogues,' comprising offers at tempting prices, provided that orders are given within a certain day. Vast quantities of school-books of good reputation, and other works permanently in demand, are bought by London commission-houses in this manner, annually, about the month of November.

Throughout the more respectable part of the trade, there is a constant effort to maintain unbroken prices; for when a book can be obtained by booksellers below trade-price, it is essentially ruined for all regular business. On the other hand, there has sprung up a practice amongst some retail booksellers of selling new books to the public at prices little above cost. This system of underselling has caused much disquietude in the trade. For a long time, resolute attempts were made by the heads of the profession to refuse to deal with undersellers; but these, appealing to the public, ultimately conquered; and now books of all kinds are disposed of at such prices as the bookseller pleases. In one sense, this underselling is unjust to the publisher, who has his wares sold cheap, without the éclat and solid benefit which he might derive from fixing on them such low prices as would induce a large sale. Whether publishers will in time fall on the expedient of lowering nominal selling-prices, at the same time lessening allowances, or whether they will altogether drop the marking of prices, are questions on which we need not enter. Enough has been said to shew that, after making all ordinary deductions, to which losses, &c., may be added, publishers can reckon on receiving little more than half the price at which their books are nominally issued. To limit impressions as nearly as possible to the demand, is always a matter of serious consideration to the publisher; for, unlike most other kinds of goods left on hand, the overplus stocks of books are often nearly valueless. On this account, books are seldom sent out on sale or return except to commission-agents.

In one important respect the English publisher differs from the producer of almost every other class of goods. He has not only to manufacture the article, but to make it known to the public. While the retail draper takes upon himself the trouble and cost of advertising his novelties in order to attract customers, the retail bookseller is relieved from any such obligation, and has little

else to do than to hand across the counter the book for which a demand has been stimulated by the costly efforts of the publisher. The grand difficulty with the publisher is to excite general attention to his wares. Hence, the stupendous advertising system in newspapers and other channels of intelligence. Some publishers, we believe, spend as much as £5000 per annum on advertisements, and an expenditure of from £1000 to £2000 is quite common. The monthly and quarterly periodicals being now important advertising channels, it is of consequence for publishers to possess one of these, both for the sake of the revenue it may produce, and for keeping their own books before the public. A well-circulated periodical, therefore, is to be viewed as almost a necessity in the business of the publisher—the thing which gives spring and vitality to what might be otherwise an inert and difficult concern. So grave a matter is advertising to the publisher, that, even with a periodical, it is very generally the practice to employ one or more clerks to write, arrange, and distribute advertisements, and to conduct the multifarious correspondence connected with them. In consequence of these burdensome outlays, and other causes, including the liberal distribution of copies of books for review, the prices affixed to original works are necessarily higher than the actual amount of paper and print would seem to warrant. The price at which new books are commonly issued, is 7s. 6d. or 10s. 6d. for a volume 12mo, 12s. or 15s. for an 8vo, and 21s. for a 4to; a book in 3 vols. 12mo is 31s. 6d. At these and other prices, books, as has been said, are subscribed for among the booksellers of the principal cities; but booksellers in the country towns either send for supplies by letter, or give their orders to travellers employed by the chief houses. Between the country booksellers and the leading publishers in London, Edinburgh, or Dublin, there is kept up a continual correspondence. For convenience, orders are usually sent monthly; and the collecting for monthly parcels forms one of the remarkable phenomena of the Row. The day of making up, called 'magazine day,' is the last, or last but one, of the month, when periodicals for the succeeding month are collected and despatched. In receiving and forwarding of enclosures by these monthly parcels, there prevails a spirit of mutual accommodation, which is exceedingly commendable, and without which, indeed, a large portion of the book-trade would be at a stand. By means of enclosures, booksellers in the most distant parts of the country are able to procure small supplies from different publishers at a trifling charge for carriage—with what result of convenience to the public need not be dwelt upon. The execution of foreign orders is, of course, comprehended in the business of the publisher; but it cannot be said that, in preparing books, any account is usually taken of probable sales abroad. In this respect, the book-trade of England differs materially from that of Germany, France, Belgium, and the United States. Books are manufactured almost exclusively in reference to the home-trade. The colonies, left to be supplied as they best may, import large quantities of English copyright-works at a low price from foreign countries, more particularly the United States. As some varieties of books, however, have lately been cheapened in an extraordinary degree, to meet the growing taste for reading among the humbler classes, the English book-trade is, by a natural process, adapting itself to compete with pirated editions in the colonial market. On one point, there is reason for gratulation. The publishers of the United Kingdom (with some

obsure exceptions) have ceased to make reprisals on American copyrights, and left to the publishers of the United States the dishonour of preying on the literature of their neighbours.

The plan of issuing neat cheap editions of popular works, was struck out a hundred years ago (1760—1770) by Alexander Donaldson, an Edinburgh bookseller above referred to,* and was followed up by several publishers in London, one of whom, C. Cooke of Paternoster Row (1790—1800), issued an extensive series of cheap reprints, of a pocket-size, called *Cooke's Editions*, which for tastefulness of preparation have never been excelled. In the early years of the present century, Suttaby's, Sharpe's, Walker's, and Dove's pocket editions, though, from their small type, more fanciful than useful, were stock articles in the trade. About 1817—1818, some enterprising booksellers began to break through certain old usages of the trade, by issuing reprints of standard works, in a good style of typography, at considerably reduced prices. At the same time, numerous cheap periodicals made their appearance; but these, for the most part, were of so seditious, irreligious, and libellous a character, that the law

* According to the act, 8 Anne, c. 19, the copyright of a book was for 14 years, with a second term of 14 years contingent on the author being alive at the expiration of the first term. While such was the law, publishers who bought a copyright were usually allowed, by courtesy of the trade, to continue to publish their works unmolested during the second term, even if the author was dead when the first term expired. Notwithstanding this act, there was long so little precision as to questions of literary property, that works issued by London publishers were freely reprinted in Edinburgh, while those belonging to Edinburgh publishers were similarly dealt with in London—for example, Ramsay's *Poems*, which were issued by the author at Edinburgh in 1725, were reprinted in London, and also in Dublin, in 1731. Alexander Donaldson, of Edinburgh, is said to have taken the lead in this kind of trade, though from any evidence on the subject, it does not appear that he went beyond the bounds of the law. In order to extend his sale of cheap reprints, he opened a shop in the Strand; a step which brought him into collision with certain publishers in London. It will be recollected that Boswell, in his *Life of Johnson*, under date 1763, alludes to this case of Donaldson, who is spoken of by Johnson as 'a fellow who takes advantage of the state of the law to injure his brethren'—one who, supposing he did reduce the price of books, 'is no better than Robin Hood, who robbed the rich in order to give to the poor.' To judge from the litigation which ensued, Donaldson scarcely merited these strictures. In 1771, certain parties in London procured an injunction from the Court of Chancery to restrain Alexander Donaldson from printing and selling *Thomson's Seasons*, on the ground that it was their property. Donaldson, appealing to the House of Lords, shewed that the work in question was first printed in 1729, that its author died in 1743, and that the copyright expired in 1757. The Lords decided in favour of Donaldson; thereby settling the point, that copyright depended entirely on the statute, and was not an inherent and interminable right of property, as many seem to have believed it to have been. Some details of this curious and important case will be found in the article COPYRIGHT. Donaldson, whose enterprises are spoken of approvingly by Boswell, left a fortune, which was greatly augmented by his son, a newspaper publisher in Edinburgh; and the total sum, amounting to nearly a quarter of a million sterling, was bequeathed to found an educational hospital for poor children. This building adorns the environs of Edinburgh, and is one of the most magnificent in Scotland. See DONALDSON'S HOSPITAL. This is not the only hospital for which the world is indebted to the book-trade. Thomas Guy, a bookseller in Cornhill, London, founded during his life the hospital which bears his name; he died in 1724. See GUY'S HOSPITAL.

interposed to check the growing evil, by the act 60 Geo. III., and 1 Geo. IV. c. 9. See NEWSPAPERS. Those cheap unstamped periodicals which appeared during the next ten years, were only tolerated when strictly confined to mere matter of amusement. Of the few which braved the jealousy of government, the only one that attained to permanent success was the *Mirror*, an illustrated weekly sheet, 8vo size, projected by John Limbird in London, the first number of which appeared November 22, 1822. When, therefore, in 1827, the Society for Diffusing Useful Knowledge began to issue its low-priced scientific treatises—and when, in the same year, Archibald Constable commenced the cheap series of works in original literature, called *Constable's Miscellany*—the public were already in some measure familiar with a certain class of cheap books. Yet, viewing all previous enterprises of this kind as fitful and insufficient, as well as unsupported by any breadth of appreciation, we have to refer to this period (1827—1832) for the true origin of what is now designated the 'cheap press.' Constable's attempt to cheapen literature was happily coincident with a general awakening in the public mind, and proved eminently successful; imitations followed; a variety of serial works, in small volumes, for popular use made their appearance. A similar popularising of the price of periodicals was the next step in advance. Several cheap sheets of an entertaining nature were issued, similar to Limbird's *Mirror*, though more resembling a newspaper in shape, but for various reasons most of them soon disappeared. At this juncture, taking advantage of the growing demand for cheap literature, and desirous of guiding it in a right direction, William and Robert Chambers of Edinburgh began, on the 4th of February 1832, to issue *Chambers's Edinburgh Journal*, a weekly sheet at 1½d.; and on the 31st of March following, appeared in London the *Penny Magazine* of the Society for the Diffusion of Useful Knowledge. So many cheap publications of various kinds followed, that it would be impossible to particularise them in this brief sketch. The efforts to establish a cheap press were much facilitated by two great inventions—the paper-making machine, and the printing machine, both of recent introduction. The continued issue of cheap reprints of popular works out of copyright, has greatly changed the aspect of the trade; and although works at the old prices are as numerous as ever, cheap books of an improving tendency are now placed within general reach. By the enterprise of certain publishers, new and copyright works are also now issued in a cheap form, in boards, with coloured paper covers—the prices of these neat and handy volumes being from 1s. to 2s. 6d. each. The trade in this class of books, and in cheap periodicals and newspapers, has been largely developed by railways. On the platforms of all the chief termini and stations, there are stalls for the sale of books, periodicals, and newspapers. These stalls, consisting of a counter and some shelving, which can be closed in with shutters at night, are rented from the railway companies by different booksellers, from whose head establishments supplies ceaselessly radiate. One London firm, in February 1860, had 120 stalls. In 1859, a leading publisher of Railway Literature, sold 750,000 books, varying in price from 1s. to 2s. 6d.

The sudden and successful rise of a cheap press was not viewed with complacency by the fathers of the trade, and for a long time it was believed that, like many other novelties, it would have its day, and disappear. Viewed, therefore, as temporary and undignified, the cheap press was left to force its way in the hands of two or three ardent young publishers, who, extending their operations, at length assumed

a position which could not fail to command respect, and to excite a spirit of emulation. Latterly, the old-established firms have begun, though in a hesitating way, to issue a cheap class of publications, by reprinting and otherwise. At the same time, these firms, besides generally maintaining the old prices, unite to keep good editions of standard works in print. These 'trade editions,' as they are termed, are printed and supplied in shares; each party concerned taking an interest in their sale, and being so far precluded from attempting the issue of rival editions. The names of all the proprietors of these joint-stock books are printed on the title-page.

As circulating libraries, by creating a taste for reading, led to the establishment of the cheap press, so, as might be expected, has the cheap press extended the sphere of literature, and given rise to public libraries and book-clubs; and even circulating libraries, which for a time suffered from the deluge of minor publications, have begun not only to revive, but to assume dimensions beyond precedent. We now hear of these concerns in London despatching parcels of new books to subscribers all over the United Kingdom; for which, transit by railway offers facilities. By one of these circulating libraries, as many as 2000 copies of a single work at eighteen shillings or a guinea are sometimes added; so that in many cases what would formerly have been considered to be large editions, are absorbed by one purchaser. After being used for several months, the overplus copies belonging to these libraries are disposed of at from a half to two-thirds of the original price; and the readiness with which they find customers among the lesser libraries throughout the country, is alone an evidence of the increasing demand for books.

The selling of second-hand books from open stalls, and from booths (q. v.), is a practice so ancient as to be connected with the trade of the stationarii of the middle ages. Some men of considerable note in the book-trade began in the humble quality of stall-keepers. The most celebrated case of this kind is perhaps that of James Lackington (q. v.). He commenced his remarkable career by keeping a small stall of old books, which, while working as a shoemaker, he placed at his door in one of the obscure streets of the metropolis; and who, from his ultimate success, was able to inscribe the proud boast, *Sutor ultra crepidam feliciter ausus*, on his very entertaining memoirs. Though more common formerly than now, book-stalls are still seen in every large European city. They particularly abound in Paris—chiefly on the quays near the Pont-Neuf; and at all the great continental fairs, stalls of new and second-hand books are conspicuous. Booksellers at one time took their place among the stall-keepers on market-days in English provincial towns, nor have they altogether disappeared. Michael Johnson, bookseller in Lichfield, was in the habit of setting up a stall for the sale of his wares, every market-day, in Uttoxeter. On one occasion, confined to bed by indisposition, he requested his son Samuel to visit the market, and attend the stall in his place, which he refused to do. How this act of criminal pride and filial disobedience preyed in after-years on the mind of the great lexicographer; and how, in his old age, to expiate this juvenile delinquency, he went to Uttoxeter on a market-day, and stood on the site of his father's stall for the space of an hour bareheaded in the rain, exposed to the jeers of the bystanders, are among the most characteristic circumstances narrated in the life of this extraordinary man (see BOSWELL, Croker's post 8vo edition, vol. x. p. 103). The flood of cheap publications thirty years ago, which has been already referred to,

greatly damaged the stall-trade in old books. Nevertheless, there remain in London some good book-stalls and booths, and in Edinburgh, though fallen from their high estate, book-stalls are still visible. It must be admitted, however, that the business is losing its picturesque character; it is getting into a regular shop-trade, and attaining to dimensions far beyond the notions of the old class of stall-keepers. London, of course, is the chief seat of the second-hand book-trade; but it is also conducted on a respectable scale in Edinburgh, Manchester, Norwich, Bristol, and some other centres of wealth and intelligence. The dealers procure supplies chiefly at public auctions of the libraries of deceased clergymen; professors, and private gentlemen, of which sales there is a constant succession in London, Edinburgh, and elsewhere.* At these auctions, good editions of standard books may usually be obtained at moderate prices; but rare and curious works, prized by the 'bibliomaniac,' frequently bring very high sums. See BIBLIOMANIA. Dealers in second-hand books send catalogues to their customers throughout the country; and from this source not a few gentlemen's libraries are mainly made up. During the past ten years, there has been a growing scarcity of second-hand high-class works, in consequence of the purchase of large quantities for public libraries forming in the United States. From France, Italy, and Germany, there has been a similar export-trade in splendid old editions to North America.

At one period, it was usual to limit editions to from 500 to 1000, or 1250 copies, and impressions of 2000 were considered excessive. Now, large editions are more frequently the rule than the exception, particularly as regards books adapted for the circulating libraries. As the cost of composition (setting the types) is the same for a large as for a small edition, and as the charge for press-work is only a little more for a larger than a smaller impression, the profit on a book rises rapidly in proportion as the quantity put to press increases. In the case of cheap books, it is absolutely necessary that large impressions be sold, in order that they may realise any profit to the publisher. In preparing this class of books, therefore, to the extent of from 20,000 to 50,000 impressions, the element of composition dwindles into insignificance. The chief things taken into account are paper, machine-printing, and boarding. Paper, however, being the matter of most serious concern, the weight is rigorously computed beforehand by putting a sample volume into the scales. To avoid delay, and also to save outlay in preparing future impressions, it is customary to stereotype cheap books and periodicals. Although, like composition, stereotyping forms a minor charge, the accumulation of stereotype-plates at length becomes considerable, and, as in the case of overplus stock, forms a burden on the capital of the publisher.

The changes produced in the English book-trade by the cheap press, are not more remarkable than that improvement in taste which has subdued the traffic in books of a politically objectionable, and of a demoralising character. Contrary to fears entertained on the subject, the cheapening of books, periodicals, and newspapers has in no perceptible degree deteriorated literature. The sale of books of a grossly demoralising tendency has been driven

* By the principal auctioning establishments in London, five in number, in 1859, there were sold 800,000 volumes of second-hand books, besides 1,389,000 volumes of new works in quires and boards. In Edinburgh (chiefly at Nisbet's), there are sold every year by auction from 80,000 to 100,000 volumes of second-hand books.

into obscurity, and in other ways circumscribed by a recent act of parliament (21 and 22 Vict. cap. 83); and it is demonstrable, as regards periodicals, that those of an objectionable kind form but a small proportion of the whole. On this subject, we offer the following statement, the result of careful inquiry into the cheap periodical trade in 1859—1860: Religious but not sectarian periodicals, at $\frac{1}{2}d.$, $1d.$, and $1\frac{1}{2}d.$ each, 20 in number, aggregate issue per month, 1,436,500. Two periodicals of the Religious Tract Society of London, one sold at $1d.$, and the other at $\frac{1}{2}d.$, aggregate issue per month, 804,000. Temperance, at $\frac{1}{2}d.$ and $1d.$ each, 9 in number, aggregate issue per month, 203,000. Useful, educational, and entertaining literature at $1d.$, $1\frac{1}{2}d.$, and $2d.$ each, 7 in number, aggregate issue per month, 2,400,000. Novels, stories, ballads, &c., at $1d.$ each, 6 in number, aggregate issue per month, 3,200,000. Romances and tales to excite the sentiments of wonder and horror, mostly at $1d.$ each, 60 in number; the issue of these could not be ascertained, but it is believed to reach the monthly aggregate of 1,500,000. Stories and memoirs of an immoral nature at $1d.$ each, 4 in number, aggregate issue per month, 52,500. Freethinking and irreligious, 2 in number, with, it is believed, a comparatively limited circulation. According to this view, the cheap periodical literature may be classed and summed up in amount as follows: 1. Works of an improving tendency, circulation per month, 8,043,500. 2. Works of an exciting nature, but not positively immoral, circulation per month, 1,500,000. 3. Works immoral, and opposed to the religion of the country, circulation per month probably under 80,000.

Obviously, the sale of such an enormous mass of cheap sheets would be overwhelming to the ordinary trade; in point of fact, the writing and publishing, and also the retailing, of the more widely circulated penny papers are conducted as a separate business. The sales are effected chiefly by means of small shops in back-streets, the purchasers being, besides domestic servants, all varieties of persons, old and young, who reside in these humble localities. The rise of these cheap periodical and newspaper shops, in adaptation to new social wants, is not the least remarkable of the 'signs of the times.' Nor can it be spoken of with regret. With other commodities the huxter dispenses the weekly pennyworth of literary amusement, which, enjoyed in the poorest family circle, enlivens the most dreary fate, and if not directly elevating in its tendency, may be presumed to do at least some good as a substitute for more exceptionable means of excitement. On general grounds there is cause for congratulation. Considering the preponderatingly large proportion of cheap periodicals of an unobjectionable, and not uninteresting kind, and looking also at the perfect freedom now enjoyed by every department of the press, we have a striking illustration of the vastly improved state of public feeling, with which cheap literature has steadily kept pace, since the reign of George IV. Not even in the most objectionable of the irreligious prints is there anything at all resembling the scurrilities which were at one time prevalent. The classes of books and periodicals, which a number of years ago consisted of coarsely offensive attacks on the government, church, laws, &c., have entirely disappeared, and at no time in its whole history has the book-trade of Great Britain been on a more healthy footing than it is at present.

Limited by the generally imperfect state of education and inaptitude for reading, the ordinary book-trade is also obstructed on account of large sections of the people still speaking some form of

the Celtic language, and being unable to understand English. The Scottish Highlanders, Welsh, Manx, and aboriginal Irish, are less or more in this condition. In Ireland, there exists a press specially devoted to those who, in remote parts of the country, still hold to the ancient vernacular. In Wales, the publishing of books and sheets in the native tongue is conducted with remarkable activity. Some are translations from English works of a useful and popular kind, occasionally illustrated with wood-engravings; and the circumstance of there being a taste and demand for such productions, affords a favourable view of the intellectual advancement of the principality. The Highlands and Western Islands of Scotland, on the contrary, produce no literature, native or translated; and the Gaelic books in the hands of the people are extremely limited in variety and number.

Entirely separated from the general book-trade, there flourishes a system of publishing of a peculiar kind. We allude to the *Canvassing Trade*, which consists in the plan of disposing of books in weekly and monthly numbers or parts. The business is conducted by only a few houses in London, Edinburgh, Glasgow, and one or two other places. Canvassers are employed to go from door to door, to procure subscribers; and the numbers are delivered periodically, till the work is completed. On account of the expense of canvassing and delivery, books sold in this manner are necessarily much dearer than if disposed of through the ordinary channels of trade. The method, however, of buying books in small portions at a time, accommodates certain classes of customers, and has been the means of disseminating an improving literature—Bibles, with notes and illustrations, and works of piety in particular—in quarters not reached by the operations of the bookseller.

Apart, likewise, from the general trade, the publication of small books, tracts, and periodicals is carried on to a large extent by associations for religious purposes, the funds for which are raised by voluntary subscriptions. As far as concerns the distribution of purely religious tracts among the unfortunate and less instructed members of the community, no fault is found with the operations of these societies. But when such associations address themselves to the publication of volumes and illustrated periodicals, differing in no material respect from the ordinary products of private enterprise, and intended not for gratuitous distribution, but for sale, a certain injury is felt to be unbecomingly inflicted on the trade, which can no more be justified than the damage done to free competition by the giving of bounties on particular manufactures. Notice has been taken of two periodicals of the Religious Tract Society of London, the circulation of which must be allowed to be fostered in this manner, and other works could be pointed out as being so greatly cheapened by the same objectionable method as to be placed completely beyond the reach of fair commercial competition. See RELIGIOUS TRACT SOCIETIES.

Another distinct kind of trade is that of printing and publishing authorised versions of the Bible, New Testament, and Book of Common Prayer. The preparation of these works has always been a prerogative of the crown, which grants exclusive privileges or patent rights to certain parties for the purpose. From old usage, England, Ireland, and Scotland are treated separately. The last patent for England was granted by George IV. to Andrew Strahan, George Eyre, and Andrew Spottiswoode, for a term of thirty years; and having commenced on the 21st of January 1830, it consequently expired on the 21st January 1860. The universities of

Oxford and Cambridge have enjoyed the right of printing Bibles, &c., in common with the patentees; but in their case, it is a simple affair of permission, they have no power to prohibit or prosecute. See PATENT.

In Ireland, George III., in 1766, granted a Bible patent to Boulton Grierson for forty years. He was succeeded by his son, George Grierson, who, in 1811, obtained a renewal, and is still, with Mr Keene, the Irish patentee. Trinity College, Dublin, has also a concurrent right; but both Oxford and Cambridge are, by the Irish printers' own patent, permitted to import their Bibles into Ireland.

In Scotland, the last patent expired in 1839, and was not renewed in consequence of remonstrances from that country, to the effect that if its printing were left free, the Bible would be sold at a considerably lower price than it had hitherto been. Such has proved to be the case. The crown appoints a board with authority to grant licences to parties desirous to print editions of the Bible and other books falling within the royal prerogative, such as the Confession of Faith of the Church of Scotland. See *Abridgment of Specifications relating to Printing, &c., printed by order of the Commissioners of Patents*, London, 1859.

The cheapening of the Bible in Scotland having tended to lower prices in England, the possibility of any further reduction seems doubtful. One noticeable feature in the trade in Bibles is, that the publishers in England sell them only in sheets. They are bought in large numbers by bookbinders, who do them up in various styles; some very neatly with gilt edges, which they sell to retailers at about 11*d.* per copy. Other copies, costing, perhaps, not more than 1*s.* or 1*s.* 6*d.* in sheets, are bound in velvet, morocco, tortoiseshell, or other ornamental bindings, and retailed as high as three guineas each. It is computed that in London alone, nearly 500 persons are employed in binding Bibles and Prayer-books. From their cheapness, but more particularly from their accuracy, English printed Bibles and New Testaments are purchased in large quantities by the United States. Other large purchasers are the British and Foreign Bible Society. The Society for Promoting Christian Knowledge makes large purchases of Prayer-books, in addition.

Although the printing of the authorised version of the Bible, the New Testament, and the Book of Common Prayer, with as well as without notes, seems to be reserved by the crown, practically no objection is taken to the printing of these works with notes and comments. Many such editions are accordingly prepared and issued by publishers, often in a style of great elegance; nor have we ever heard the accuracy of their text impugned. Translations of the Bible, other than the authorised version, are also issued freely by Roman Catholic and other bodies.

The universities of Oxford and Cambridge; also of Trinity College, Dublin; the four Scotch universities; and the colleges of Eton, Winchester, and Westminster; were so much alarmed by the decision of the House of Lords in 1772, in favour of Donaldson's right to reprint works not protected by the copyright law of 8 Anne, c. 19, that they applied for and obtained an act of parliament, 15 Geo. III. c. 53, giving them a perpetual copyright of all works belonging to them, or which might afterwards be bequeathed to or acquired by them. The only work in existence older than the present century, claimed by any of the above institutions, to which any value can be attached, is Clarendon's *History of the Rebellion*, with his life and continuation. The right to this and other works possessed by the university of Oxford, was confirmed by the last Copyright Act, 5 and 6 Vict. c. 45. It will, therefore, be understood that the

printing and publishing of Lord Clarendon's *History of the Rebellion* remains an absolute and perpetual monopoly in the university of Oxford—a curious exemption from the ordinary and terminable claim of copyright, and singularly at variance with modern notions of free-trade. It should be added that the profits of the first edition were very great, and were applied by the university towards the erection of the 'Clarendon Press,' which was for a long time the university press; but, its business increasing, the 'Clarendon' has been superseded by the 'University Printing House;' the former building, a very handsome one, being used for other purposes. Besides Godson's *Law of Patents and Copyrights, and Supplements*, see Dr Ingram's *Memorials of Public Buildings of Oxford*, new edition, 1848, p. 11; and see the *Oxford University Calendar* for 1859, p. 88.

Publishers are under the legal obligation to deliver, free, a copy of every work they issue (new editions without alterations excepted) to the five following public institutions:—Library of the British Museum; Bodleian Library, Oxford; Public Library, Cambridge; Trinity College Library, Dublin; and Library of Faculty of Advocates, Edinburgh. This obligation, imposed by a clause in the Copyright Act (see COPYRIGHT), is usually spoken of as an unjustifiable burden, and no doubt it is so; but it is chiefly from causing trouble that it becomes matter for complaint. In comparison with the immense benefits conferred on literature by the public libraries mentioned, the value of the books (with some exceptions) claimed by them is insignificant. In practice, not a hundredth part of the cheap books and sheets issued are given or claimed; which is perhaps unavoidable, for if they were, no ordinary building could contain them.

The English book-trade has been lately much indebted to certain liberal Post-office arrangements. Manuscripts, proof-sheets, books, periodicals, and catalogues, if left open at the ends, may now be transmitted by post at an exceedingly small charge. See POST-OFFICE.

Unitedly, the whole trade of publishing and bookselling forms an important staple of national industry—inferior to some other manufactures and trades, yet great when viewed in relation to its past history, and to the still imperfect state of education among large masses of the people, and respectable from the number of men of high character who are connected with it. In reckoning the number of new works issued from the press annually, we may take the number of entries of distinct books, volumes, sheets, maps, &c., lodged by publishers at the British Museum, in terms of the Copyright Act. The following is an abstract of the return for 1859: Books: complete works, 5507; consisting of volumes, in process of publication, 5642; parts, 15,767; single sheets, 236—total 21,645. Music: complete works, volumes and pieces, 4066. Maps in sheets, 3071; atlases, whole or in parts, 25—total, 3096. Grand total of articles, 28,807. In 1854, the number was 19,578. The difference shews the rise since that period. In 1856, according to the tables of the Board of Trade, the imports of books into the United Kingdom amounted to 5771 cwts., of which 2226 cwts. were from France, and 709 cwts. from the United States. The exports in hundredweights were as follows: Russia, 20; Hanover, 158; Hanse Towns, 637; Holland, 553; France, 670; Turkey, 204; Egypt, 2004; United States, 11,977; Chili, 117; Malta, 267; South Africa, 826; Mauritius, 71; East Indies, 2443; Australia, 6535; British America, 1373; West Indies, 617; all other states, 1622—total, 30,094 cwts., the value of which, at £14 per hundredweight, is about £425,000. It is seen that the

exports are fivefold more than the imports; also that we export to Australia alone more than we import from all countries, and to the United States double as much. A system of more free and untaxed import of foreign-printed English works would, in various ways, introduce changes into the book-trade, and have a tendency to alter some of its traditional usages.

In Germany, where printing originated, the book-trade became also first established, and the principal mart was Frankfort, to the fairs of which the early booksellers and printers resorted. Leipsic, also, became a great mart for books as early as 1680; yet this ancient city is only one of many places of book preparation in Germany. Among them, Stuttgart has taken a front rank, since about 1830, as an agency place for the South German book-trade, whilst Frankfort has now greatly lost its ancient prestige. Throughout the different states of the Confederation, more particularly Prussia and Saxony, printing and publishing are largely carried on; and from the various places of publication a great proportion of entire editions of works is transferred to Leipsic agents, who disperse the books throughout Germany and all those countries for the book-trade of which the city of Leipsic forms the nucleus. Hence arises the important peculiarity of German literature, that literary, artistic, and scientific activity is not limited to, or monopolised by any single city, and that, consequently, authors do not need to resort to a metropolis for encouragement or any professional labour. Formerly, the booksellers from the various parts of Germany, and those countries which are dependent, in some measure, upon Germany, on account of affinity of language and identity of aspirations—such as Holland, Belgium, Denmark, Sweden, Norway, &c.—used to meet at Leipsic twice a year, at Easter and Michaelmas, with a view to exchange their respective publications, and arrange for settlement of mutual accounts. At present, business is done at Leipsic through a system of agencies by commissioners there established. Every bookseller in Germany and the adjacent countries has his commissioner at Leipsic, and to him he forwards packages containing copies of his new publication or publications, on sale or return, for all the booksellers with whom he has an account. The commissioner then distributes the packages among the Leipsic commissioners, every one of whom is thus enabled, out of the many packages flowing in every week, to make up a case for each of his correspondents. At the end of the year, unsold books are returned to the various senders by means of the Leipsic agency. At Easter, during the fair, the balances are now mostly paid by commissioner to commissioner, the German publishers not resorting as much as formerly to the fair; the extension of railway communication, and other circumstances facilitating business, having somewhat changed the nature of the trade. The method of sending parcels of new works, on sale or return, may not be satisfactory according to English notions, but the advantages of the plan are obvious in various points of view. There is no country in the world where literary and scientific novelties are so regularly made known and become noticed as in Germany. Let the book be what it may, within six weeks after its first publication it is known all over Germany, and through the personal vigilance of the retailers, is brought everywhere under the notice of those individuals to whom the subject treated of may be of interest. This method of publication has the merit of great simplicity, and secures an exemption from that frightful expenditure on advertisements to make books

known, which presses on the English publisher. On this account, as well as from the cheapness of paper and printing, and the simple way that books are for the most part done up, the selling-prices of every variety of production are very moderate. The only drawback on the German publisher is, the liability to heavy returns of unsold books; but this he doubtless endeavours to avert by professional tact in his speculations and a good knowledge of the market. It is, at all events, the belief of those who are well acquainted with the German book-trade, that the method pursued not only furnishes books cheaper, but is more productive to author and publisher than that in England; and that in point of good management and prosperity, it exceeds, or at least equals, the book-trade in any other country. From the teeming press of Mr Bernhard Tauchnitz of Leipsic, has been issued a series of 500 volumes of cheap reprints of English popular works, in a pocket size, which are sold largely in Germany and some other continental countries. It is proper, however, to say that, as there is an international copyright law between Saxony and the United Kingdom, these *Tauchnitz Editions*, as they are termed, are issued in virtue of an honourable arrangement with English publishers and authors, and are accordingly not to be ranked with the piratical issues of the New York trade. Latterly, the sale of German books in England, France, and North America has rapidly increased.

In France, publishing is carried on chiefly in Paris, where there are now some extensive printing establishments, including the *Imprimerie Imperiale*, provided with machinery equal, if not superior, to anything of the kind in London. As regards substantiality and elegance, French books occupy a place between those of Germany and England. They are, with few exceptions, done up simply in coloured paper covers, for temporary service; but the ink is generally better than that used in England; and works when of a superior class are executed with a high degree of taste—the excellence of pictorial embellishments being always conspicuous. Certain voluminous and most expensive works in French, and also in the classical languages, occasionally issue from the Parisian press, and command a large sale; orders of copies for university and public libraries all over the continent tending to promote these gigantic enterprises. Although confined mainly to Paris, the business of publishing, or at least of preparing books for the Parisian market and for exportation, is carried on to a considerable extent in several provincial towns. Tours, in particular, is the seat of a large book-factory—that of Messrs Mame—in which printing, designing, engraving, and binding are all executed on the premises.

According to returns of the Board of Trade for 1857, the following were the French imports and exports of books in 1855. Value of imports, 1,829,470 francs; of exports, 12,344,855 francs; the export trade having increased 30 per cent. since 1851. The exports are to Italy, Germany, Russia, Belgium, North America, and other countries, and a portion also comes to England. Between France and the United Kingdom there is now an international law of copyright, by which translations of works are protected in either country, when the title-page indicates that 'the right of translation is reserved.'

In the 17th c., various cities in the Dutch Netherlands bore a prominent place in the book-trade. At Amsterdam, some of the most beautiful editions of the classics were executed; while from Leyden, and other seats of learning, exports of works in law, theology, &c., formed at one time a prosperous commerce. In this as in other trades, it has

been the fate of Holland to lose its former reputation, for in the present-day its book-trade is on a comparatively poor scale. That part of the Netherlands, now known as Belgium, once under a civil and ecclesiastical despotism, which was adverse to a free press, possesses now a flourishing book-trade, mainly, we believe, on account of French being the language generally spoken. Brussels, as a kind of minor Paris, is the seat of some extensive printing and publishing concerns; at which Parisian works, as is well known, are unauthorisedly reproduced, and whence exports on a large scale are made to foreign countries. In point of appearance, Brussels editions, in all but the name, are indistinguishable from those of Paris. According to a return of the minister of finances of Belgium, the following was the import and export trade in books for 1856: Value of imports, 284,557 francs, of which 80 per cent. was from France; value of exports, 2,446,578 francs, of which 47 per cent. was to England, and 53 to all other countries.

Of the book-trade in Spain, and also in several Italian states, little can be said that is satisfactory. In the kingdom of Sardinia only is literature beginning to shew signs of animation. Among Italian booksellers, generally, there is little intelligence or spirit of enterprise, and authors are in many cases compelled to be their own publishers. During the last twenty years, Germans have established bookselling houses in the principal cities, as Rome, Naples, Turin, Milan, Bologna, Florence, Venice, and Verona, also Trieste; and under their auspices, as far as local laws and usages, and the want of proper means of intercommunication, will permit, the trade may be expected to assume an organised form. Already, these intelligent foreigners have done much to keep alive a knowledge of Italian literature.

The book-trade of the United States, which is daily assuming greater proportions, has sprung up from small beginnings within the present century. As in Germany, the business of publishing is monopolised by no particular city, but is carried on successfully in various towns, chiefly throughout the northern and middle states of the Union. The following particulars respecting the trade are given in *Trübner's Bibliographical Guide to American Literature* (Lond. 1859). 'In 1853, there were 355 book-publishing establishments in the United States. At present, the number is more than 400. About three-fourths of these are located in New York, Philadelphia, Baltimore, and Boston; the rest being principally in Cincinnati, Charleston, New Orleans, Buffalo, Auburn, Albany, Louisville, Chicago, St Louis, and Hartford. There are more than 3000 booksellers who dispense the publications of these 400 publishers, besides 6000 or 7000 general dealers who connect trade in books with the ordinary stock of a country store.' Several of the large American publishing houses, like those of Edinburgh, unite in one establishment the whole process of book preparation and issue. The most extensive of this class is that of the Harpers in New York, 'which covers half an acre; the building alone cost £40,000; their annual sales have been estimated at 2,000,000 volumes; and they employ not far from 600 persons.' At Boston and Philadelphia, there are also large publishing establishments. Of these, perhaps, the most notable is the house of Lippincott and Co., Philadelphia, from which there is said to be distributed 10 tons of literature every 24 hours. Including original works and reprints of native and foreign productions, the amount of the American book-trade was estimated in 1856 at 16,000,000 dollars. According to the authority already quoted, a change is

going on in the relative proportions of British and American books published in the United States; the British works having fallen from 70 per cent. of the entire consumption in 1820, to 20 per cent. in 1856. Admitting that such is the case, the fact is notorious that by the Harpers, and the Appletons, of New York, and others, the reprinting of British copyright works is carried on to an enormous extent, in defiance of all remonstrances to the contrary, and even in disregard to the claims of those more scrupulous American publishers who pay for and import early sheets from England. The unauthorised reprint of the present work by the Appletons affords an example of these piratical practices.

American books are now executed with neatness and taste; their wood-cut embellishments sometimes surpass those of London; and in point of size and price, they are, for the most part, well adapted for general circulation. On account of the prevalence of education, and also the aspiring habits of the people, book-buyers of a humble position in life are greatly more numerous than they are in the United Kingdom. Looking on the American book-trade as, after all, still in its infancy, it may be expected, in the progress of events, to go on in a vastly accelerated ratio. Latterly, several English and Scotch publishers have established branches of their business in New York; and there are now some extensive American commission-houses in London—from which intercommunication, happy results may be anticipated. Books are sold wholesale by written orders, trade-sales, auctions, and otherwise. Country dealers are in the habit of visiting the great book-dépôts of Boston, New York, and Philadelphia, and there personally making their selections. As previously stated, there is a large export of American books to Canada and other British possessions, in which, as yet, native literature is on a poor scale, but where there is a large and increasing number of readers.

In doing up books in cloth boards, the American binders invariably cut off the outer folds of the sheets, so as to smooth the edges of the leaves, as in English leather binding; by which process, the first readers of new books are spared the trouble of cutting open the leaves. Many persons have wished to see this improvement, for such it is, introduced into England. There are still, however, prejudices to be overcome on the subject. Strange as it may appear, numbers of purchasers like to cut up the leaves with a folder as they advance through a new book or periodical, from an idea that the repeated slight interruptions heighten the pleasure of perusal. In our experience, we have known gentlemen who would not sit down to read a cut-up new book. Besides, there is a notion among buyers in England, that books with smooth-cut leaves may be second-hand, and not worth the price of new. Undoubtedly, the Americans are ahead of Europeans generally in this particular.

Notice has been taken of the constant export from Europe to the United States of quantities of high-class books to stock the great public libraries that are everywhere springing into existence through the liberality of state legislatures, or the munificence of private individuals. There is, however, a traffic of a similar kind, more especially from England, in execution of orders for second-hand books from dealers who have establishments in the principal cities in the Union, and through whose agency persons of refined tastes are becoming acquainted with the aspect of our older literary treasures. One of these second-hand book-stores in Philadelphia, which we visited in 1853, was on an extensive scale as anything of the kind in London or Edinburgh, while the choice which it presented

would have come quite up to the delicate perceptions of the bibliomaniac.

For a variety of particulars bearing on the book-trade in general, we refer to the articles, BIBLIOGRAPHY, BOOK, BOOKBINDING, CENSORSHIP, CIRCULATING LIBRARY, COPYRIGHT, NEWSPAPERS, PAPER, PERIODICALS, PRESS, PRINTING, STATIONER, STEREOTYPING, WOOD-ENGRAVING. W. C.

BOOLAK, or **BOULA'C**, a town of Egypt, on the right bank of the Nile, two or three miles north of Cairo, of which it forms the port. Destroyed by the French in 1799, it was rebuilt by Mehemet Ali, who established cotton, silk, and weaving factories; a government printing-house, from which a newspaper in Arabic is issued weekly; and a school of engineering. Passengers for Suez and India debark here. Pop. 13,200.

BOOLUNDSHU'HUR, a British district in the sub-presidency of the North-west Provinces of India. With an area of 1855 square miles, it contained, in 1850, 699,393 inhabitants. It lies in N. lat., between 28° 3'—28° 43', and in E. long., between 77° 28'—78° 32', being bounded to the N. and W. respectively by the districts of Meerut and Delhi. Its chief town of the same name, otherwise called Unchuganj, is on the route between Bareilly and Delhi, being 40 miles to the south-east of the latter. Its population amounts to 12,049; and its distance from Calcutta is 730 miles, its elevation above the level of the sea being almost precisely the same number of feet.

BOOM, in a ship, is a general name for the long poles which jut out from certain supports or uprights, to stretch or extend the bottoms of sails. Some taper regularly from the middle towards both ends; while others have the thickest part at about one-third of the length from one end. According to their particular modes and places of application, they receive the names of *jib-B.*, *flying jib-B.*, *studding-sail B.*, *lower studding-sail B.*, *main B.*, *square-sail B.*, *driver-B.*, *spanker-B.*, *ring-tail B.*, *main-topmast B.*, *fore-topmast B.*, *fire-B.*, &c. In the old 110-gun ships of Nelson's days, these booms varied from 57 to 32 feet in length, and from 15 to 6 inches in thickness. The war-steamers of the present day require a somewhat different equipment of booms. The immense spread of canvas in some of the clipper merchant-ships now built requires the use of booms of very considerable length. A seaman speaks of 'booming' when he applies a B. to a sail; he employs *B.-irons*, shaped like the figure 8, to connect booms and other spars together end to end.

Besides the booms on board ship, the same name is also given to a strong iron chain employed in barring the passage of the mouth of a harbour or river, or to cut off the retreat of an enemy if he has actually entered. Such a B. should be protected by a battery or batteries. The chains are moored, and are floated by logs. There should be two such chains, one to afford resistance if the enemy has penetrated the other; they need not extend all across the passage, seeing that shallow spots are self-defended. A modern war-steamer would cut through a chain-B., unless made of very thick and strong iron. Sometimes hempen cable booms are used to resist small-craft. The Russians effectually boomed the harbour of Sebastopol in September 1854, thereby preventing the entrance of English and French ships; this was done partly by sinking some of their own ships, and partly by the laying of booms.

BOOM, a town of Belgium, in the province of Antwerp, about 10 miles south of the city of that name. Its situation at the junction of the Brussels Canal with the river Rupel makes it a place of

considerable trade. It has numerous and extensive brick and tile works, breweries, tanneries, ropewalks, sail-cloth manufacturss, salt-works, &c. Pop. 7464.

BOOMÉRANG, a missile instrument for war, sport, or the chase, in use by the aborigines of Australia. It is of hard wood, of a bent form; the shape is parabolic, as represented in the adjoining



Boomerang.

cut. It is about two and a half inches broad, a third of an inch thick, and two feet long, the extremities being rounded. One side is flat, the other rounded; and it is brought to a bluntness edge. The method of using this remarkable weapon consists in throwing it in a particular manner. It is taken by one end, with the bulged side downwards, and the convex edge forward, and thrown directly onward, as if to hit some one thirty yards in advance. Instead of going directly forward, as might be expected, and there falling to the ground, it slowly ascends in the air, whirling round and round, and describing a curved line of progress till it reaches a considerable height, when it begins to retrograde, and finally it sweeps over the head of the projector, and falls behind him. This surprising motion is produced by the bulged side of the missile. The air impinging thereon, lifts the instrument in the air, exactly as by hitting the oblique bars in a windmill, it forces it to go round. The ingenuity of the contrivance, which is worthy of the highest scientific calculation, is very extraordinary as coming from almost the lowest race of mankind. The B. is one of the ancient instruments of war of the natives of Australia. They are said to be very dexterous in hitting birds with it, the animals being of course behind them, and perhaps not aware that they are objects of attack. This curiosity, as it must be called, was first made known by being brought before the Royal Irish Academy by Professor McCullagh in May 1837.

BOONE, DANIEL, a famous backwoodsman and trapper, was born in Virginia, United States. At an early period of his life, he emigrated to North Carolina; but his love of the wilderness not being sufficiently gratified there, he planned an expedition into Kentucky, then almost unknown. On the 7th of June 1769, along with five companions, he reached the Red River, north of the Kentucky. B., however, was captured by the Indians, but escaped, and accidentally falling in with his brother, who had pursued his track, they lived together in a cabin during the whole winter. In May 1770, B.'s brother went home, and B. himself was left alone in the perilous forest. In July, his brother returned, and after exploring a considerable portion of country, they returned in 1771 to Carolina, determined to emigrate with their families to Kentucky; but the attempt proved unsuccessful. Shortly after, B. was engaged as the agent of a Carolina company, in purchasing the lands on the south side of the Kentucky river, where, in 1775, he built a fort on the site now occupied by the town of Boonesborough. In 1777, the place was twice attacked by a swarm of Indians, who, however, failed to capture it. On the 8th of August 1778, a third attempt was made by 450 savages, officered by Canadian Frenchmen. In spite of repeated assaults, the little garrison of fifty men set at defiance its

enemies, who were at length obliged to retire, and never afterwards ventured to besiege the place. After many skirmishes and encounters with the Indians, B. removed in 1798 to Upper Louisiana, where the Spanish authorities gave him a grant of 2000 acres of land. He settled with his children and followers at Charette, on the Missouri River, beyond the inhabited limits of the country, where he followed his favourite occupation of hunting and trapping bears till his death, which occurred in 1822. B. was one of the most adventurous of all those 'pioneers of civilisation' to whose courage, endurance, and skill America owes so much.

BOONESBOROUGH, one of at least thirty localities in the United States, which take their name from the first pioneer of the great valley of the Mississippi. It stands on the Kentucky, about 18 miles to the south-east of Lexington. Though now an insignificant village, yet it deserves a prominent place in the history of the mighty west. It was founded in 1775 by Daniel Boone (q. v.), as his first fort; and within three or four years thereafter, it was the seat of the first legislature beyond the Alleghanies.

BOORGHAS. See **BURGAS**.

BOO'RO, an island of the Malay Archipelago, about 60 miles to the west-north-west of Amboyna, extending between S. lat. 3° and 4°, and between E. long. 126° and 127°. With an estimated area of 2000 square miles, it is said to contain 18,000 inhabitants. Though it is mountainous, having Mount Dome and Tomahoc, respectively 10,400 feet high and 6528; yet it is, on the whole, very fertile, its productions being rice, sago, fruits, dye-woods, and cajeput oil. At the east end of the island, the Dutch have a station named Fort Defence; but the best anchorage is on the north side in Cajeli Bay.

BOOROJIRD, or **BOOROOGIRD**, a town in the province of Irak-Ajemi, Persia, situated in a fertile valley about 190 miles north-west of Ispahan. Lat. 33° 43' N., long. 48° 45' E. It has a castle and several mosques. Pop. about 12,000, who are chiefly engaged in agricultural pursuits.

BOO'SA. See **BOUSSA**.

BOOT, **BOOTS**, or **BOO'TKIN**, an instrument of judicial torture, formerly used in Scotland to force confessions from persons accused of crimes, or answers from unwilling or suspected witnesses. Bishop Burnet in the *History of his Own Time*, and Sir Walter Scott in his *Old Mortality*, speak of the B. as made of iron; but the Rev. Thomas Morer in his *Short Account of Scotland*, written from personal observation of the country at a time when the B. was still in use, describes it as 'made of four pieces of narrow boards nailed together, of a competent length for the leg, not unlike those short cases we use to guard young trees from the rabbits.' One or both legs of the person to be tortured having been placed in this case, wedges were inserted between the limb and the sides of the case, and these wedges were driven down by the executioner with a mallet or hammer, questions being at intervals put to the sufferer, until either he gave the desired information, or fainted away, or shewed such endurance as satisfied the judges that no answer could be extorted from him. The wedges were commonly placed against the calf of the leg, but Bishop Burnet says he had heard that they were sometimes placed against the shin-bone. In one case—that of a lad in Orkney, in 1596—it is recorded that they were struck home as many as fifty-seven times. In another—that of John Fian, schoolmaster at Prestonpans, burned for sorcery in 1591—it is said that the victim 'did abide so many blows, that his legs were crushed and

beaten together as small as might be, and the bones and flesh so bruised that the blood and marrow spouted forth in great abundance, whereby they were made unserviceable for ever.' 'Still,' it is added, 'he would not confess;' and, indeed, it is remarkable in how many cases we are told that the torture, agonising as it was, failed in its purpose, even where the sufferer 'shrieked for pain in terrible manner, so as to have moved a heart of stone.' A writer of 1591, after speaking of the 'pilniewinks,' 'pilliwinks,' thumb-screws, or thumbikins (q. v.) as 'a grievous torture,' and of compression of the skull by a twisted cord as 'a most cruel torment also,' describes the B. as 'the most severe and cruel pain in the world.' Yet there are instances in which it was not thought enough. When the boots were first used in Scotland is not known. In a case where a deed of conveyance of land was challenged as a forgery, in 1579, two witnesses, a clergyman and a notary, both of Forfarshire, were ordered to be 'put in the boots, gins, or any other torments, to urge them to declare the truth.' In a letter, still preserved in the State Paper Office at London, Sir Francis Walsingham writes to the English ambassador at Edinburgh, in 1583, that Queen Elizabeth desires that Father William Holt, an English Jesuit then in Scotland, may be 'put to the boots.' The B. was subject of allusion on the English stage in 1604; in Marston's *Malcontent*, printed in that year, one of the characters is made to say: 'All your empirics could never do the like cure upon the gout the rack did in England, or your Scotch boots.' A young gentlewoman of Aberdeenshire was tortured by the B. in 1630. Soon afterwards, it is said to have fallen into desuetude for about thirty years. It was revived after the insurrection of the westland Covenanters in 1666, and continued to be used throughout the reigns of King Charles II., and King James II., and during the first years of King William III. 'The genius of our nation,' writes Sir J. Lauder of Fountainhall in 1681, 'locks upon the torture of the boots as a barbarous remedy, and yet of late it hath been frequently used among us.' The Claim of Right brought forward by the Scottish Convention in 1689, denounced 'the use of torture, without evidence, and in ordinary crimes, as contrary to law.' Notwithstanding this declaration, the B. was used at least once again. In 1690, Neville Payne, an English gentleman who was supposed to have entered Scotland on a treasonable mission, was put to the torture under a warrant superscribed by King William, and still shewn in the Register House at Edinburgh. The B. was applied to one leg, the thumb-screws to both hands, but without any effect, although, in the words of one of the privy-councillors, the torture, which lasted for two hours, was inflicted 'with all the severity that was consistent with humanity, even unto that pitch that we could not preserve life and have gone further.' This is believed to be the last time that the B. was used. But it was not until Scotland had ceased to be an independent kingdom, that the British parliament enacted—by the statute 7 Anne c. 21—that in future 'no person accused of any crime in Scotland shall be subject or liable to any torture.' Torture is believed not to have been used in England after 1640. It was abolished in France in 1789, and in Russia in 1801.

BOO'TAN. See **BHOTAN**.

BOO'TÉS, in ancient mythology, the son of Ceres and of Iasion, who, being plundered of all his possessions by his brother Pluto, invented the plough, to which he yoked two oxen, and cultivated the soil to procure subsistence for himself. As a reward for

this discovery, he was translated to heaven by his mother with the plough and yoke of oxen, under the name of B, i. e., the Ox-driver, which is still borne by one of the constellations. According to others, B. was the son of Lycaon and Callisto, whom his father slew, and set before Jupiter for a repast, to try his omniscience. Jupiter restored him to life, and placed him amongst the stars.

BOOTH. Throughout all Europe, in early times, trade was carried on chiefly by fairs, as indeed is still the case in some parts of it, and in many parts of Asia. The tents, huts, or other temporary or movable structures in which the traders exposed their goods for sale, had in this country the name of *booths*—a word of uncertain origin, traced by some to the Gaelic *both* or *bothag*, a bothy or hut; by others, with more probability, to the Greek *apothēke*, the Latin *apotheca*, the Italian *boteca* and *potheca*, and the French *boutique*—all signifying an office, place of business, shop, store-house, or tavern. From this, its primary sense, in which it is still in use, B. gradually came to mean a fixed shop or warehouse. As towns sprang up, the yearly fair was more or less supplanted by the weekly market. The slight B. which was set up in the same spot every week, had an irresistible tendency to become substantial and permanent; and the records of the 12th and some following centuries are full of unavailing complaints against the encroachments which were in this way made upon the market-places and streets. Thus, Joceline of Brakelond chronicles the ineffectual efforts of his great and wealthy abbey, in 1192, to dislodge the burgesses of Bury St Edmunds from the shops, sheds, and stalls which they had erected on the market-place without leave of the monks. So in the Winton *Domesday Book*, compiled in 1148, notice is taken of 'houses' in Winchester which had been 'stalls.' So, also, Stow relates that the houses



Merchants' Booths :
From an illuminated MS. representing Venice in the
14th century.

in Old Fish Street, in London, 'were at the first but movable boards set out on market-days to shew their fish there to be sold; but procuring licence to set up sheds, they grew to shops, and by little and little, to tall houses.' So, again, the same chronicler tells us that 'in Cheapside, from the great conduit west, were many fair and large houses, which houses in former times were but sheds or shops, with solars (that is, lofts or upper chambers) over them.' So in Edinburgh the range called at first 'the Boothdraw,' and afterwards 'the Luckenbooths,' arose in the very centre of the High Street. So, likewise, in Edinburgh and elsewhere, the trader who for years had spread his stall under the shelter of the same

buttress of the church or town-hall, began to rest a fixed wooden B. against it, gradually transforming the timber beams into lath and plaster, or even into brick or stone, until at length the basement of the stately cathedral, or *hôtel de ville*, was incrustated all over with unseemly little booths (or *kramas*, as they were called in Scotland), like limpets on a rock. The B. which thus arose had often but one apartment, which opened on the street by a narrow door, and a broad unglazed window, closed at night by a wooden shutter, dividing in the middle, and hinged at top and bottom, so that the upper half formed a sort of awning, while the lower half served as a table for the display of the trader's wares. It was at this window that business was conducted, the trader standing within, the buyer without. Occasionally a flight of steps led down to a cellar under the B., which served as a store-room. In other cases, a chamber behind was the warehouse of the merchant's B., or the workshop of the craftsman's B., or the sleeping-place of either. As civilisation advanced, a 'solar' or chamber was raised above the B. for the dwelling-house of the trader, occasionally with a store-room in the roof, to which goods were hoisted by a crane. There is mention of a goldsmith's B. with a 'solar' above it, at Perth, about 1220. Traces of the middle-age B. still remain in this country. There are many perfect examples in France, some of them believed to be of the 12th century.

BOOTHS, UNLICENSED, are, by the law of England, public nuisances, and may, upon indictment, be suppressed, and the keepers of them fined. But by the 6 and 7 Vict. c. 68, s. 23, theatrical representations in booths or shows at fairs, feasts, or customary meetings of the like kind, when allowed by the justice of the peace of the district, or other local authorities, are lawful. See **THEATRICAL REPRESENTATIONS, PLAYHOUSES.**

BOOTH, BARTON, a celebrated actor of the 18th c., was born in 1681, his father being nearly related to Henry Booth, Earl of Warrington. Having received a good education at Westminster, he was sent at the age of 17 to Cambridge University, from which he ran away to join a company of strolling-players, who were shortly after dispersed by the law. B. next performed at Bartholomew Fair with such success that Betterton would have engaged him for Drury Lane had he not been afraid of offending his family by doing so. After a successful engagement in Dublin, he returned to London, and was now engaged at Drury Lane, where he appeared in 1701, and made a great 'sensation.' He became quite the rage among the nobility, who vied with each other in placing their carriages at his disposal; and he frequently stayed overnight at Windsor, where the court was then held. His greatest character was the ghost in *Hamlet*, in which he is said never to have had an equal; and his Othello, according to Cibber, was also a very masterly performance. He died May 10, 1733.

BOOTH'AUK, a fortified pass of Afghanistan, 12 miles to the east of Cabul. It runs for 5 miles between cliffs 500 feet high, and is in some places only 50 yards wide.

BOOTHIA FELIX, a peninsula forming the most northerly part of the American continent. Towards the south, it is terminated by an isthmus, while, to the north, it is bounded by Bellot Strait (q. v.). It was discovered by Sir John Ross during the most famous of his voyages, and named after his friend Sir Felix Booth, being supposed at the time to reach as far north as Barrow Strait.

BOOTHIA GULF separates Boothia Felix on the west from Cockburn Island on the east, and

is, in fact, a continuation of Prince Regent's Inlet towards the south.

BOOTON, an island of the Malay Archipelago, separated by a strait of the same name from the south-east end of Celebes. It is in lat. 5° S, and long. 123° E. In size, character, and productions, it generally resembles Booro (q. v.). It is frequented by the Dutch, who used at one time to send an officer to destroy the clove-trees, as interfering with their monopoly in cloves.

BOOTS, which are only a lengthened variety of shoes, are among the most ancient articles of attire. Shoes, extended a certain height up the leg, laced, ornamented, and of fanciful colours, were in use by the ancient Egyptians, Greeks, and Romans, as is seen by existing relics and drawings. Leaving an account of these and other varieties of shoes, as well as an account of the trade and manufacture of shoes and boots generally, to the article **SHOE-TRADE**, we here confine attention to a few historical particulars respecting what are properly called B., meaning by the term leather coverings for the legs and feet. Different kinds of half-boots were worn by the Anglo-Saxons and Anglo-Normans; and in the reign of Edward IV., if not earlier, the boot-proper, with tops and spurs, was established as an article of knightly dress. (See *Book of the Feet*, by J. Sparke's Hall, London.)



Jack-boot.

In the reign of Charles I., a species of boot, exceedingly wide at the top, made of Spanish leather, came into use; and with Charles II. the highly decorated French boot was introduced as an article of gay courtly attire. Meanwhile, the jack-boot, as it is called (see **JACK**), had become indispensable in the costume of cavalry soldiers and horsemen generally; and by William III. and his followers it was regularly naturalised in England. Strongly made, the jack-boot extended in length above the knee, was capacious at top, had a very high heel, and round the ankle it had a flat leather band bearing a powerful spur. In the adjoining cut is offered a representation of this highly characteristic boot, which we readily associate with the civil and foreign wars that distracted the 17th century. This huge species of boot remained in use in British cavalry regiments until comparatively recent times, and was dismissed as being too cumbersome in the case of men being dismounted. It is, nevertheless, in a somewhat polished and improved form, still worn by the Horse-guards, with whose stalwart appearance, doing duty in their tall B. at Whitehall, most people are familiar.

As an improved jack, the Horse-guards boot bears a remarkably close resemblance to the hoot of the French postilion, well known to the older class of continental tourists. French postilion B., however, it is proper to understand, are made of that capacity that will suit any ordinary foot and leg. Kept economically as part of the equipment of a posting-house, they are ready for all legs, with or without stockings, as the case may be; and looking at the strength of their materials, they may very fairly be supposed to accommodate all the post-boys of an establishment during half a century.

The jack-hoot is almost entitled to be called the parent of the top and some other varieties. B. with tops of a yellow colour were so commonly worn by gentlemen in the 18th c., as to become a peculiarity in the national costume of the English. When Philip, Duke of Orleans, and other revolutionists of note, affected to imitate the sentiments and manners of the English, they ostentatiously wore top-boots. In the early years of the present century, a number

of members of the House of Commons, among whom may be specified the late Sir Francis Burdett, habitually wore top-boots; nor have they yet entirely disappeared. By jockeys and riders generally, they are likely to remain in permanent use. What perhaps contributed to break up the general use of top-boots, was the introduction of the Hessian boot as an article of walking-dress. Worn over tight pantaloons, the Hessian boot was a handsome piece of attire, giving, undoubtedly, an elegant appearance to the nether costume. A representation of a Hessian hoot, with its tassel, is annexed. B. of this shape, as is seen by engravings, were worn by English general officers in the early part of the French war, and somewhat later. At length they were superseded by the well-known Wellington hoot, which, as its name imports, was introduced by the great Duke, as a simplification, under the loose military trouser.



Hessian Boot.

This species of boot has, in its turn, been almost entirely abandoned in England, in consequence of the universal use of short ankle B.; but it is still generally used by some classes of persons in the United States, though in an odd fashion, with the trousers stuffed loosely in at the top.

BOOTY is the victors' share in property captured from the vanquished. It is generally a military term, the word *prize* being more frequently used in the navy. The regulations concerning B. in the British army were collected and consolidated in 1831, and have only been slightly altered since. All military B. is apportioned as the sovereign from time to time may direct. Deserters, and those who do not claim their share within six years, receive none. The officers appoint two B. or prize agents, by letters of attorney; the field-officers naming one, and the subordinate officers another. The officer commanding the successful expedition sends to the military authorities a list of the persons entitled to booty. The agents collect the property, convert it into money at the best advantage, and hand over the proceeds to the authorities, receiving a small percentage for their trouble. A scale of distribution is then made out, and the money is paid after a certain interval. When an army and a fleet join in a capture, the Admiralty calculates the army share, and sends the amount to the military authorities. Prize and B. originally belonged to the sovereign, and are only distributed to the captors as an act of grace; for, if the sovereign pleases, the property can be given back again to the enemy. See further, under **PRIZE**.

BOPP, FRANZ, Ordinary Professor of Oriental Languages at Berlin, was born at Mainz, on the 14th September 1791. Devoting himself exclusively to the study of oriental literature, he spent some years in Paris, where he was encouraged in his labours by Chezy, Silvestre de Sacy, and August Wilhelm Schlegel, and afterwards visited London, to prosecute his favourite studies more thoroughly, being partly supported by a small pension from the king of Bavaria. His first publication was on the Sanscrit verb; he afterwards produced a Sanscrit grammar, a *Glossarium Sanscritum*, and editions of several fragments of the great Indian epic, the *Mahabharata*, in the original text, with a translation. He has done much to facilitate the study of Sanscrit in Europe. But his most important labours have been in the analysis of the grammatical forms of the different languages of the Indo-Germanic family, by which he may be said to have founded a new science of Comparative

Grammar. His great work in this department is a Comparative Grammar of the Sanscrit, Zend, Greek, Latin, Lithuanian, Old Slavonian, Gothic, and German (*Vergleichende Grammatik*, &c., Berl. 1833, &c.; a second edition, entirely recast, was published in 1857). An English translation by Lieutenant Eastwick, and conducted through the press by Mr Wilson, Boden professor of Sanscrit in Oxford University, was published in 3 vols. 1845—1850. In recognition of his splendid services to philology, he was, in 1842, made a knight of the newly erected French *Ordre du Mérite*, and in 1857, foreign associate of the French Institute.

BO'PPARD, or **BO'PPART** (ancient *Baudobriga*), a walled town of Rhenish Prussia, situated on the left bank of the Rhine, about 9 miles south of Coblenz. B. is a busy manufacturing place, with dirty, narrow streets, and its houses are chiefly of wood. Its appearance, however, is picturesque, and it has several buildings, architecturally remarkable. The church of the Carmelites contains some fine specimens of 16th c. sculpture. During the middle ages, B. was an imperial city, and many councils were held in it. Remains of the Roman fortress built by Drusus still exist in the centre of the town. Pop. 3680.

BORA, **KATHARINA VON**, or **CATHARINE DE BORA**, the wife of Luther, was born, it is supposed, at Löben, near Schweinitz, in Saxony, on 29th January 1499. At a very early age, she entered the Cistercian convent of Nimptschen, near Grimma. Becoming acquainted with Luther's doctrines, she found herself very unhappy in her monastic life; and finally, along with eight other nuns, whose relatives, like her own, refused to listen to them, she applied for assistance to Luther. Luther obtained the services of Leonhard Koppe, a citizen of Torgau, and by him and a few associates the nine nuns were liberated from the convent in April 1523. They were brought to Wittenberg, where Luther had suitably provided for their reception. Catharine became an inmate in the house of the burgomaster Reichenbach. Luther, through his friend, Nicholas von Amsdorf, minister in Wittenberg, offered her the hand of Doctor Kaspar Glaz, who became pastor in Orlamünde. She declined this proposal, but declared herself ready to marry Von Amsdorf, or Luther himself, who had already laid aside his monastic dress. Her marriage with Luther took place on 13th June 1525, and was made the occasion of much unjust reproach by his enemies, which has not ceased to be repeated to this day. In his will, he left her all that he had, so long as she should remain a widow, because, as he says, she had always been an affectionate and true wife to him. After Luther's death, the Elector of Saxony and Christian III. of Denmark contributed from time to time to her support. She died at Torgau on 20th December 1552.

BORA'CIC A'CID is found native (1) in the steam or vapour which rises from certain volcanic rocks in Tuscany, and (2) as a saline incrustation in the crater of a mountain in the island Volcano, which is situated 12 miles north of Sicily. This crater is about 700 feet deep, the sides lined with a crust of B. A. about half an inch thick, and is sufficient to yield an annual supply of 2000 tons. B. A. also occurs in combination in Borax (q. v.), Datholite (q. v.), Boracite, and other minerals, and to a very minute extent in trap rocks generally. The Tuscan supply of B. A. may be regarded as the most important, and its collection takes place over an area of about 30 miles. The plan pursued is to form a series of caldrons—100 to 1000 feet in diameter, and 7 to 20 feet deep—partly by excavation, and partly

by building, in the side of the volcanic mountain where the steam and B. A. vapours are issuing from fissures, and divert the course of a mountain stream, so that at pleasure the caldrons, or *lagoons*, may be supplied with water. As the volcanic vapours—called *suffioni*—gurgle through the water contained in the lagoons, the B. A. is arrested by the water, which becomes impregnated with it. The liquid is passed from one lagoon to another, then on to settling vats and flat-bottomed evaporating pans, till it becomes so concentrated that on cooling, impure crystals of B. A. separate. In this condition it is sent to England and other countries. The appearance of the surface of the ground, from which thousands of jets of steam are constantly issuing, is very striking; and the name given to one of the principal mountains, *Monte Cerboli* (*Mons Cerberi*), denotes the feeling of awe with which the peasantry regarded the district as the entrance to the lower regions. Native B. A. is employed as a source of borax (q. v.), and contains about three-fourths of its weight of true B. A., accompanied by one-fourth of water and impurities. In a pure condition, B. A. may be prepared by dissolving 40 parts of borax ($\text{NaO}_2\text{B}_2\text{O}_3$) in 100 of water, and acting thereon by 25 parts of hydrochloric acid (HCl), which removes the soda, forming chloride of sodium (NaCl) and water (HO), and on cooling the mixture, the B. A. (BO_3) crystallises out. On re-resolution in water and re-crystallisation, it is obtained in pure white feathery crystals. B. A. is used in the arts as a flux, as an ingredient in the glaze employed in pottery; and the wicks of stearine and composite candles are treated with it, so that when the candle is burning, the end of the wick when it gets long, may fuse and fall to the side, where it can be burned away. The exportation of B. A. from the Tuscan lagoons exceeds 3,000,000 lbs. annually.

BO'RAGE (*Borago*), a genus of plants of the

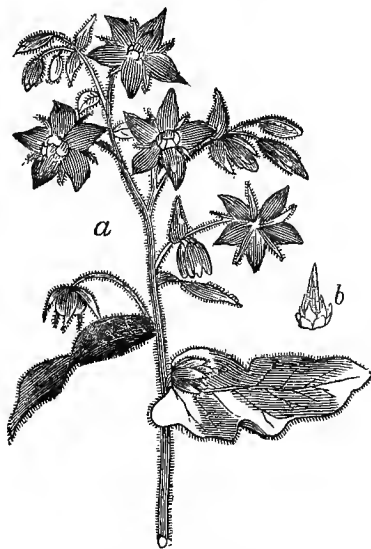

Borage (*B. officinalis*):
a, flowering branch; b, the cone of stamens, &c.

natural order *Boraginæ* (q. v.), having a wheel-shaped corolla, the mouth of which is closed with five teeth, and forked filaments, of which the inner arm bears the anther, the anthers connivent around

the style, in the form of a cone. The species are few, chiefly natives of the countries around the Mediterranean Sea. The COMMON BORAGE (*B. officinalis*) is found in waste places in many parts of Europe, and is pretty frequent—perhaps naturalised—in Britain. It is a plant of rather coarse appearance, with a stout erect herbaceous stem, 1–2 feet high, somewhat branched; the lower leaves elliptical, obtuse, tapering to the base; the stem, leaves, flower-stalks, and calyx rough with hairs. The flowers are more than half an inch broad, of a beautiful blue colour. B. was formerly much cultivated and highly esteemed, being reckoned amongst the *cordial* flowers, and supposed to possess exhilarating qualities, for which it no longer receives credit. The belief in its virtues was at one time extremely prevalent in England, and its use accordingly universal. The flowers were put into salads, Gerarde tells us (1597), ‘to make the mind glad;’ and he adds: ‘There be also many things made of them, used everywhere for the comfort of the heart, for the driving away of sorrow, and increasing the joy of the mind.’ Like some other plants of the same order, B. contains nitrates of potash (nitre), and is slightly febrifuge. It is mucilaginous and emollient, and has been used in pectoral affections: its leaves impart a coolness to beverages in which they are steeped; and with wine, water, lemon, and sugar, enter into the composition of an English drink called a *cool tankard*. The young leaves and tender tops are pickled, and occasionally boiled for the table.

BORAGINEÆ, or **BORAGINACEÆ**, a natural order of dicotyledonous plants, consisting chiefly of herbaceous plants, but also containing shrubs and even trees, the leaves generally rough with hairs which proceed from a thick hard base, and the whole plant mucilaginous and emollient. The leaves are alternate and without stipules. The flowers are in spikes, racemes, or panicles which are almost always coiled up, and gradually uncoil and elongate themselves, the flowers expanding in succession. The calyx is 4–5-partite, and remains till the fruit is ripe; the corolla is generally regular, 4–5-cleft, imbricated in bud; the stamens rise from the corolla, and are equal in number to its divisions—generally five—and alternate with them. The ovary is 4-partite, 4-celled; the style simple, arising from the base of the lobes of the ovary. The fruit consists of 4—or sometimes of 2—distinct achenia. See **ACHENIUM**.—The order *Ehretiaceæ* of some hotanists differs chiefly in the fruit, which in the more typical species is a succulent drupe; and in the *Heliotropes* consists of four dry achenia more or less consolidated.—There are about 600 known species of the proper *Boragineæ*, and about 300 of *Ehretiaceæ*. The former are natives principally of temperate climates, and are particularly abundant in the south of Europe and in the temperate parts of Asia; the latter are more tropical, but not exclusively so. **BORAGE** (q. v.), **ALKANET** (q. v.), **COMFREY** (q. v.), and **FORGET-ME-NOT** (q. v.), are familiar examples of the former; the exquisitely fragrant **HELIOTROPE** (q. v.) is the best known of the latter. The drupes of some species of *Ehretia* are eatable.

BORA'SSUS. See **PALMYRA PALM**.

BORAX, or **BIBORATE OF SODA**, is found native as a saline incrustation on the shores of certain lakes in Persia and Thibet. It also occurs in India, China, Ceylon, Saxony, and South America. When collected on the banks of the lakes, it is impure, and goes by the name of *tincol*. The latter is purified by acting upon it with a solution of caustic soda, which removes the fatty matter that the

crystals are coated with, to prevent evaporation of the water they contain, and thereafter dissolving in hot water and recrystallising. B. is likewise prepared from boracic acid (BO_3), (q. v.), by solution in boiling water, and the addition of a boiling solution of ordinary carbonate of soda (Na_2CO_3), when B. ($\text{Na}_2\text{O}, 2\text{BO}_3$) is formed, and carbonic acid (CO_2) is disengaged, and on cooling in wooden tanks lined with lead, the crystals of B. separate. The common crystalline variety of B. contains 10 equivalents of water ($\text{Na}_2\text{O}, 2\text{BO}_3 + 10\text{HO}$); but if a stronger than ordinary solution be allowed to cool, crystals begin to separate at a higher temperature than usual, which contain only 5 atoms of water ($\text{Na}_2\text{O}, 2\text{BO}_3 + 5\text{HO}$). B. is soluble in water to the extent of one part of the salt in two parts of hot water, and in twelve of cold, yielding a clear solution with a sweetish taste. It is readily reduced to powder, and is then known as *powdered borax*. It is of great use in the chemical arts. As an assistant agent in experimenting with the blow-pipe (q. v.), B. is of great service, from the readiness with which it forms coloured glasses with the various metallic oxides. It is also employed in the manufacture of enamel, and for glazing or coating vessels in English pottery, as also in the formation of the paste for artificial gems. To the metallurgist, it is an aid in the readiness with which it promotes the fusion of metallic mixtures, and the separation of the metals; and to the solderer of all metals it is of service in forming a thin glassy coating over the edges of the metals, which prevents their oxidation at the time they are being joined together. B. is also used in dyeing.

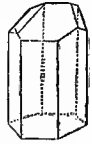

Crystal of Borax.

BORDA, **JEAN CHARLES**, an eminent practical mathematician and astronomer, was born on 4th May 1733 at Dax, in the department of the Landes, in France. In 1771, he was associated with Verdun and Pingré in proving the accuracy of chronometers. He also devoted much attention to the subject of ship-building, and suggested great improvements in the form of vessels. In 1787 he took an active part in bringing the observatories of Paris and Greenwich into closer relations with one another. Along with Delambre and Méchain, he was a leading member of the French commission intrusted with the measurement of a meridian arc. He rendered essential service in the commission on the new system of weights and measures. He invented a new instrument for measuring the inclination of the magnetic needle; and his corrections of the seconds' pendulum are still in use. But his reputation depends most of all on his improvement of the reflecting circle, on which instrument he published a work in two volumes (Par. 1787). He died at Paris on the 20th February 1799.

BORDEAUX, an important seaport town in the south-west of France, beautifully situated in a plain on the left bank of the Garonne, about 60 miles from its mouth in the Atlantic. Ships of more than 1000 tons' burden can easily ascend the river at high water to B., which is accessible at all times of the tide to vessels of 600 tons. Its harbour is very capacious; and, by the Garonne, its commerce very extensive. The river is crossed by a noble bridge of 17 arches and 532 yards in length, erected by the elder Deschamps in 1811–1821. The old town, consisting partly of high wooden houses of the 15th c., has narrow crooked streets; but the newer parts of the city and the suburbs have wide streets, fine squares, and pleasant promenades lined with trees. The cathedral, which was consecrated in 1096, is remarkable for its beautiful towers. The church

of St Croix is a building of the 10th c.; that of St Seurin is also very old, and has rare Gothic ornaments. The former archiepiscopal palace is now the town-hall. The Great Theatre is one of the largest and finest buildings of its kind in France. B. has many other fine public buildings, and learned associations, and educational and benevolent institutions, with a public library of upwards of 120,000 volumes. The university, founded by Pope Eugenius IV. in 1441, has been, since 1839, an *Académie Universitaire*, with four faculties and fifteen professorships. Pop. in 1856, 137,538.

Among the principal branches of industry are the production or preparation of sugar, brandy, liqueurs, vinegar, nitric acid, printed calicoes, woollen goods, carpets, hats, paper, earthenware, glass bottles, metallic wires, &c. The rope-works, cooperages, and dockyards are extensive and full of activity. The Canal du Midi, connecting B. with the Mediterranean, enables it to supply the whole south of France with the colonial produce which it imports; and also with English tin, lead, copper, coal, dye-stuffs, herrings, &c. Wine, brandy, vinegar, dried fruits, hams, turpentine, and glass bottles are among its principal exports.—In former times, B. was called *Burdigala*, and was the capital of the *Bituriges Vivisci*. It was a very prosperous town in the times of the Romans, was made by Hadrian the capital of Aquitania Secunda, and was both the principal emporium of the south-west of Gaul, and the seat of its best educational institutions. Remains of the Roman period still exist. After suffering greatly at the hands of Vandals, Goths, Franks, and Spanish Arabs, it was taken by Charles Martel in 735; but was again spoiled by Norman plunderers in the 9th century. It became the capital of the Duchy of Guienne; and in 1152 passed, by the marriage of Eleanor of Guienne with Henry of Normandy (afterwards Henry II. of England), under the dominion of England. From the English, B. received important liberties and privileges; they encouraged its commerce; and it was for a considerable time the seat of the splendid and chivalric court of Edward the Black Prince. It strongly supported the cause of England against France, but was taken by Charles VII. in 1451. It rose against the imposition of the salt-tax in 1548, and was visited with bloody vengeance by the Constable Montmorenci. The horrors of St Bartholomew's Day were repeated here, from 3d to 5th October 1572, by the governor, Montferrand, and 2500 persons perished. During the Revolution, B. was the principal seat of the Girondists, and suffered fearfully at the hands of the Terrorists. The pressure of Napoleon's continental system made its inhabitants disaffected to his government, and they were the first of the French to declare for the Bourbons in 1814.

The wines produced in the neighbourhood of B., and forming one of its principal exports, are called *Bordeaux Wines*. Except the wines of Champagne no French wines are so much exported to foreign countries. Some of them are red (known in England as *Claret*), others white. Of the red wines, the Medoc is one of the best known. The red wines produced by the vineyards of Lafitte, Latour, Château-Margaux, and Haut-Brion, are particularly celebrated for their quality. The white wines of Graves, and those of Sautesnes, Barsac, Puisseguin, and Langon are in highest repute.

BORDELAIS, a district of France, once forming part of the old province of Guienne, and having Bordeaux for its capital, but now included in the departments of Gironde and Landes.

BORDER, THE, is a term employed in historical as well as popular phraseology to signify the

common frontier of England and Scotland. At present, the dividing boundary of the two countries consists partly of natural and partly of imaginary outlines. It is customary to speak of Scotland as a country 'north of the Tweed;' but the Tweed is the boundary only in a small part of its course, on the east, and large portions of several Scottish counties lie to the south of that river. Even at its mouth, the Tweed is not the division; for north of the river at its estuary lies the ancient town of Berwick, with the district known as its 'bounds,' which belong to Northumberland. The Tweed forms the division only for about 16 to 18 miles. Leaving the river at Carham Burn, a few miles above Coldstream, the line proceeds towards the Cheviot mountains, the ridge of which is the boundary for about 25 miles; descending thence, the line strikes on Kershope Water, a tributary of the Esk. That river is the boundary for a number of miles to a point above Longtown. The line now quits the Esk abruptly in a northern direction, and taking into England part of what was known as the 'Debatable Land' (q. v.), strikes on the small river Sark, which is the boundary to the Solway Firth, the great natural division on the west. Such, in general terms, is the entire boundary, extending from sea to sea for about 100 miles, in which length the Tweed obviously plays an inferior part. The counties lying on the English side of the border are Northumberland and Cumberland; on the Scottish side, Berwickshire, Roxburghshire, and Dumfriesshire. Readers of history are aware that the division here indicated is comparatively modern; in former times, the frontier shifted according to the surging tide of war or diplomacy. For several ages prior to the 11th c., the kingdom of Northumbria, forming a part of what we now call England, included all that portion of Scotland south of the Firth of Forth as far west as Stirling. As a result of some warlike operations, this district was ceded by the Earl of Northumberland to Malcolm II., king of Scots, 1018, and ever since the Tweed, in its lower part, has been the boundary. What, however, was gained by Scotland on the east was lost on the west; for William the Conqueror wrenched Cumberland from the northern sovereign; and with little intermission the boundary in this quarter was settled according to its present limits.

It may be said that from the 11th till the end of the 17th c., there was almost constant disturbance on the border. Ruthless wars on a great scale between English and Scots sometimes caused the most frightful devastation, and became the source of lasting ill-will on both sides. History abounds in events of this kind, and the feuds and forays of clans and families are commemorated in a series of ballads, for ever embalmed in the *Minstrelsy of the Scottish Border*, by Sir Walter Scott. The most notable of these forays from the Scottish side is narrated in the ballad of the *Battle of Otterburne*, or, as it is sometimes called, *Chevy Chase*. The event referred to occurred in 1388. Among the latest of the regular invasions from England was that in 1543, in the reign of Henry VIII., conducted by the Earl of Hertford. The invasion was by the eastern marches, and in their devastating course, the English army set fire to and destroyed all the towns, villages, monasteries, and numerous castles within a wide range of country. At an early date, wardens and commissioners had been appointed to repress petty insurrections, and punish the moss-troopers who made cattle-lifting from their neighbours on the opposite side of the border a kind of profession. For these measures of police, the border was divided into three parts—the east, middle, and western marches. Such

was the lawlessness in the early part of the 16th c., that in 1511, Sir Robert Kerr, warden of the eastern marches, was slain at a border meeting by three Englishmen. The principal murderer escaped as far as York, and for a time tried to conceal himself; but he was sought out by two of Sir Robert's followers, who brought his head to their new master, by whom, in memorial of their vengeance, it was exposed at the cross of Edinburgh (Scott's *Essay on Border Antiquities*). Sometimes the Scottish borderers met ostensibly to amuse themselves with the ancient sport of football, but in reality to plan and execute daring military exploits. During the reigns of Elizabeth and James VI., strenuous efforts were made to preserve peace on the border, and this was attained only by extraordinary severities. Many of the more audacious reivers were hanged, and great numbers were banished. Some account of the measures adopted at this period to suppress border outrages will be found in the *Memoirs of Sir Robert Cary*, who long acted as English warden on the marches; also in the *Domestic Annals of Scotland*, by R. Chambers, vol. i. After the accession of James to the English throne, a sweeping clearance of the Scottish border was effected. The laird of Buccleuch collected under his banners the most desperate of the border marauders, whom he formed into a legion for the service of the states of Holland. At the same time, the Debatable Land was cleared of the Græmes, a daring sept of freebooters, who were transported to Ireland, and their return prohibited under pain of death. The legislative union of 1707, and the firm administration of justice, along with a general improvement in manners, finally terminated the long course of misrule.

In the present day, there is nothing to distinguish the border from other districts of the country, unless it be the prevalence of picturesque ruins of old castles, generally roofless, but, from the vast thickness and strength of the walls, still in a good state of preservation. The border strengths were of three kinds—regular fortresses, large baronial castles, and the lesser kind of towers. On the east, the English owned the fortified town of Berwick, and at no great distance Newcastle-on-Tyne; and on the west, Carlisle. The chief Scottish border fortresses were the royal castles of Roxburgh, Jedburgh, and Lochmaben; and we might almost include Edinburgh Castle, for it is only 60 miles distant. Among the baronial castles on the English side were numbered Norham, Alnwick, Bamborough, Naworth, Brougham, Penrith, and Cockermouth. Among the Scottish fortlets of the baronial class may be mentioned Newark, Hermitage, and Caerlaverock. The smaller kind of towers on both sides of the frontier appear to have been exceedingly numerous, and it is their remains that form the more conspicuous memorials of old border strife. These buildings consist of a single square tower, usually of three floors; the lower vaulted, for the reception of cattle; while the two upper, consisting of but one small apartment each, with narrow slit-hole windows, comprised the accommodation for the family. It is conjectured, however, that retainers lived in thatched huts outside, which are now obliterated, and were brought into the tower, along with the cattle, only in the case of an anticipated attack. These towers, known as bastel-houses or peels, once the residences of a warlike yeomanry, are thickly studded over the south of Scotland, more particularly along the vale of the Tweed; and by the lighting of beacons on their summits, the whole country between the border and the Forth could be speedily summoned to arms. On the English side, there are similar towers, such as those of Thirlwall, Fenwick,

and Widdrington. The English border castles of every kind appear to have been of greater splendour and strength than those on the Scottish side. 'Raby Castle, still inhabited, attests the magnificence of the great Nevilles, Earls of Westmoreland; and the lowering strength of Naworth shews the power of the Dacres' (Scott). On the English side, however, there is nothing which can be compared to the ruins of that remarkable group of Scottish border abbeys—Melrose, Dryburgh, Kelso, and Jedburgh, not to speak of the remains of various other religious houses. For an account of these and other architectural remains on the border, we must refer to the *Border Antiquities of England and Scotland*, by Sir Walter Scott, 2 vols. folio, illustrated with plates; also to Billings's *Baronial and Ecclesiastical Antiquities of Scotland*, 4 vols. 4to, illustrated with plates.

Assimilated in habits to the rest of the population, the old Scottish border families are still distinguishable by their surnames—as, for example, the Maxwells, Johnstons, and Jardines on the west, and the Elliots, Armstrongs, Scotts, and Kerrs on the middle and eastern marches. The principal Scottish border families of rank are the Scotts, Dukes of Buccleuch, descendants of a famed border chief, Sir Walter Scott of Buccleuch; and the Kerrs, Dukes of Roxburgh, who are sprung from an equally celebrated borderer, Sir Robert Kerr of Cessford. The possessions of both families are extensive, particularly those of Buccleuch (q. v.), which spread through several counties. The family of corresponding rank within the English border is that of the Percies, Dukes of Northumberland. Local intercourse across the border is considerably obstructed by the long range of hills and the moors which generally lie on the line of boundary; and the circumstance of the peculiar civil and ecclesiastical institutions of the two kingdoms shedding off here towards different centres, still further tends to lessen community of feeling. At no distant day, certain exciseable articles were charged with a less duty in Scotland than England, and the consequence was an active contraband trade on the border, chiefly by the mountain-passes and the Solway. Now, these duties are assimilated, and this demoralising kind of traffic has disappeared. The great channels of communication across the border are two lines of railway, one by way of Berwick, and the other by Carlisle. There are also good roads in various directions for those who wish to explore this interesting district of country. Besides the books relative to the border already referred to, there are some works of local note, among which the most comprehensive is Richardson's *Borderer's Table-book*, 8 vols. royal 8vo (Newcastle-on-Tyne); we may also refer to Jeffrey's *History and Antiquities of Roxburghshire*, 3 vols.; and Ridpath's *Border History*, 1 vol. 4to. w. c.

BORDER-WARRANT, in the law of Scotland, is a warrant issued by the judge ordinary—that is, by the sheriff or county court judge, or by magistrates of royal burghs within the royalty, or by justices of the peace—on the borders between Scotland and England, on the petition of a creditor who desires to arrest the person or effects of a debtor residing on the English side, and to detain him until he finds bail for his appearance in, and abiding the result of, any action which may be brought for the debt within six months. The creditor must swear to the truth of the debt, and before resorting to imprisonment of the debtor, it is proper to examine him as to his domicile, or usual residence, and occupation. These warrants are in use in the counties of Dumfries, Roxburgh, and Berwick. They are more used in the country districts than

in the burghs, though not frequently even in the country districts. In Dumfriesshire and Berwickshire, border-warrants are granted exclusively for arresting the persons of alleged debtors. In Roxburghshire—with the exception of the courts of the justices of the peace in Kelso and Melrose districts, which follow the practice of the two first-named counties—the warrants are granted for the purpose of arresting both the debtor's person and goods. In the stewardry of Kirkcudbright, and in Wigtonshire, they are unknown.

In English practice, the warrant to arrest an absconding debtor, which includes any foreigner who may be in England on business or pleasure, is very similar. See ARRESTMENT FOR FOUNDING JURISDICTION; DEBTOR, ABSCONDING; FOREIGN ATTACHMENT; JURISDICTION.

BORDURE, or BORDER, in Heraldry. Coats of arms are frequently surrounded with a B, the object of which is generally to shew that the bearer is a cadet of the house whose arms he carries. The character of the B. often has reference to the profession of the bearer: thus, a B. *embattled*, is granted to a soldier; and a B. *ermine*, to a lawyer.

BORE is a tidal phenomenon at the estuaries of certain rivers. When a river expands gradually towards a very wide mouth, and is subject to high tides, the spring flood-tide drives an immense volume of water from the sea into the river; the water accumulates in the estuary more rapidly than it can flow up into the river; and thus there is gradually formed a kind of watery ridge stretching across the estuary, and rushing up towards the river with great violence. In some cases, this ridge, or B., is many feet in height, and contends against the descending stream with frightful noise. This phenomenon is observable in several British rivers, as the Severn, Trent, Wye, and Solway. The most celebrated bores are those of the Ganges, Brahmaputra, and Indus: in the Hoogly branch of the Ganges, the B. travels 70 miles in 4 hours, and sometimes appears suddenly as a liquid wall 5 feet in height.

BORE is a name for the internal cavity of a cannon, mortar, howitzer, rifle, musket, fowling-piece, pistol, or other kind of firearm. It is in most cases cylindrical; but in the Lancaster gun the B. is oval; in the Whitworth gun, it is hexagonal; while in the Armstrong, and many other kinds of gun, it is furrowed by spiral grooves. Technically, the B. of a gun often means simply the diameter of the cavity, as when we speak of a gun 'of 8-inch bore;' and in that case its meaning is equivalent to 'calibre.'

The **BORING** of a cannon is a process which may best be described in connection with CANNON FOUNDING. It is desirable to mention in the present place, however, that there is an operation called 'boring-up' conducted at Woolwich Arsenal, for enlarging the bore of a gun. It has been found in recent years that many of the old cannon are thicker and heavier than needful for the size of shot propelled, and that they could be fitted for the discharge of larger shot without danger. A change was begun in the armament of the British fleet in 1839 by substituting heavier broadsides; and as one part of the process, many of the old 24-pounders were 'bored-up' to 32s; even some of the 18-pounders were found to be thick and strong enough to undergo this process. More than 2000 iron naval guns were thus treated at Woolwich preparatory to the change in 1839; and many others have since been similarly bored-up. At the present time, May 1860, important experiments are in progress at Woolwich, to determine

whether the old smooth-bore iron guns cannot only be bored-up, but *rifled* at the same time. There are 15,000 of such guns belonging to the British government, and it is suggested that they ought to be improved in efficiency, instead of being cast aside as useless in the event of the success of the Armstrong and Whitworth guns.

BO'REAS, the Greek name of the north-east wind, blowing towards Hellas from the Thracian mountains, and personified in mythology as the son of Astræus and of Eos or Aurora, and the brother of Notus, Zephyrus, and Hesperus. B. was said to dwell in a cave of the Thracian Hemus, to which he carried Oreithya, the daughter of the Athenian king Erechtheus, who bore him Zetes and Calais—employed as the symbols of swiftness—and Cleopatra, the wife of Phineus. According to Homeric fable, he begat, with the mares of Erichthomius, twelve horses of extraordinary fleetness. The rape of Oreithya was represented on the ark of Cypselos, where B. instead of feet has the tails of serpents. He had a temple in Athens, because he destroyed the ships of the Persians under Xerxes; and at Megalopolis, a yearly festival was celebrated in his honour, because upon one occasion he helped the Megalopolitans against the Spartans.

BO'RECOLE. See KALE.

BORELLI, GIOVANNI ALFONSO, a distinguished mathematician and astronomer, and the founder of the iatro-mathematical school, born at Naples in 1608, was educated at Florence, and became professor of mathematics at Pisa, and afterwards at Messina. Having taken part in a revolt, he was obliged to leave Messina, and spent the remainder of his life at Rome, where he enjoyed the patronage of Queen Christina of Sweden, and where he died in 1679. He carefully observed the motions of the satellites of Jupiter, then little known, and seems to have been the first to discover the parabolic paths of comets. He made many valuable observations on a malignant fever in Sicily, and wrote a treatise on the causes of such fevers. He wrote also an account of an eruption of Etna, and a number of works on subjects of applied mathematics, of which the most celebrated is that *De Motu Animalium* (Rome, 1680—1681). In this work, he applies the laws of mechanics to the motions of animals, regarding the bones as levers, in which the power acts between the weight and the fulcrum, and endeavouring to calculate the power of muscles from a consideration of their fibrous structure, and the manner in which they are united to the tendons. All more recent authors on the same subject have been much indebted to Borelli.

BORER, a name common to many insects of the Linnæan genus *Ptinus*, the tribe *Ptiniæ* of Latreille, coleopterous (q. v.) insects of small size, the larvæ of which—small, white, soft, worm-like creatures, with six minute feet—are furnished with strong cutting jaws (*maxillæ*), by means of which they eat their way in old wood, and similar substances, boring little holes as round as if made with a fine drill. Every one is familiar with the appearance of these holes, and with the injury done by these insects to furniture, &c. The holes are filled up, as the insect works its way onward, with a fine powder, formed from the wood which it has eaten; and finally it constructs for itself a little silky cocoon, and having passed through the pupa state in the bottom of its hole, comes forth a winged insect—a small beetle, in the widest popular sense of that term. One of the most common British species is *Anobium striatum*, a dark-brown insect, not much above one line in length. The thorax, as in the whole tribe, is proportionately very large,

and has a swollen hood-like appearance, the head being, as it were, received within it. This insect has long been noted for the pertinacity with which it



Borer (*Anobium striatum*),
Natural size, and magnified.

simulates death. This instinct appears to be common to the whole tribe, as it is also to many other insects.—Another species of the same genus, *Anobium tessellatum*, has become an object of interest as one of the insects which, being sometimes heard to make a peculiar ticking noise, are connected with superstitious fancies and fears, and receive the name of Death-watch (q. v.).

BORGHESE, a family of great distinction in the republic of Siena, and afterwards at Rome. **CAMILLO B.** ascended the papal throne in 1605 as Paul V., and by him other members of the family were advanced to high positions. A marriage with the heiress of the family of Aldobrandini brought the B. family into the possession of great wealth. **CAMILLO FILIPPO LUDOVICO B.**, Prince B., born at Rome in 1775, joined the French army when it invaded Italy; and in 1803 married Pauline, the sister of Napoleon Bonaparte, and widow of General Leclerc. His wife subsequently received the principality of Guastalla, and he was created Duke of Guastalla, and under the French Empire he was for some time governor-general of the provinces beyond the Alps. He held his court at Turin, and was very popular among the Piedmontese. He sold the B. collection of artistic treasures to Napoleon for 13,000,000 francs, receiving in part-payment the Piedmontese national domains; but when these were reclaimed by the king of Sardinia in 1815, he received back some of the works of ancient art. After the overthrow of Napoleon, he separated from his wife, and broke off all connection with the Bonaparte family. He lost Guastalla, but retained the principalities of Sulmona and Rossano, his hereditary possessions. He died in 1832.—The *Borghese Palace* is one of the most magnificent at Rome. The noble portico of the inner court is composed of 96 granite columns; the collection of paintings is remarkably fine.

BORGHESE, **BARTOLOMMEO**, COUNT, a distinguished antiquarian, born at Savignano, Central Italy, on the 11th July 1781. His father, Pietro Borghesi, who was one of the most accomplished scholars of his time, trained him to an early delight in learned pursuits. He studied at Bologna, and afterwards devoted himself to archaeological researches. He arranged the numismatic collection in Milan, and that of the Vatican, of which he drew up a catalogue. In reward for this work, he obtained from the pope exemption for himself and family from the observance of fasts. In 1821 he fixed his residence in the republic of San Marino. His principal work yet published is his *Nuovi Frammenti Dei Fasti Consolari Capitolini Illustrati* (2 vols., Milan, 1818—1820). His contributions to Forcellini's Latin Lexicon are very highly prized.

BORGIA, a family originally Spanish, but which acquired great eminence in Italy after the elevation of Alfonso Borgia to the popedom, as Calixtus III., in 1455. He had previously been a privy-councillor

of the king of Aragon. He died in 1458.—Rodrigo B. ascended the papal throne in August 1492, under the name of Alexander VI. (q. v.). Before his elevation to the popedom, he had a number of children by a Roman woman named Vanozza (Giulia Farnese), of whom two, Cesare and Lucrezia, share their father's extraordinary historic infamy.—**CESARE** or **CESAR B.**, was one of the greatest monsters of a time of depravity, when the court of Rome was the scene of all the worst forms of crime. He unscrupulously made use of the most sacred things as means to the most iniquitous ends. He had early received high ecclesiastical preferment, and his father, soon after becoming pope, invested him with the purple. But his father conferring upon his brother Giovanni the Duchy of Benevento, with the counties of Terracina and Pontecorvo, Caesar, as was believed, moved with envy, caused his brother to be assassinated. He obtained the duchy and counties for himself, and was permitted by his father to reign in the purple and to devote himself to the profession of arms. He was sent in 1498 to France, to convey to Louis XII. a bull of divorce and dispensation from his marriage with Anne of Brittany. Louis rewarded him for the pope's complaisance with the Duchy of Valentinois, a body-guard of 100 men, 20,000 livres of yearly revenue, and a promise of support in his schemes of ambition. In 1499, Caesar married a daughter of the king of Navarre; and accompanied Louis XII. to Italy, where he undertook the conquest of the Romagna for the Holy See. The rightful lords of that country, who fell into his hands, were murdered, notwithstanding that their lives had been guaranteed by his oath. In 1501 he was named by his father, Duke of Romagna. In the same year, he wrested the principality of Piombino from Jacopo D'Appiano, but failed in an attempt to acquire Bologna and Florence. He took Camerino, and caused Giulio Di Varano, the lord of that town, to be strangled along with his two sons. By treachery as much as by violence he made himself master of the Duchy of Urbino. A league of Italian princes was formed to resist him, but he kept them in awe by a body of Swiss troops, till he succeeded in winning some of them over by advantageous offers, employed them against the others, and then treacherously murdered them on the day of the victory, 31st December 1502, at Sinigaglia. He now seized their possessions, and saw no obstacle in the way of his being made king of Romagna, of the March, and of Umbria, when, on 17th August 1503, his father died, probably of poison which he had prepared for twelve cardinals. Caesar, also, who was a party to the design (and who, like his father, had long been familiar with that mode of despatching those who stood in the way of his ambition, or whose wealth he desired to obtain), had himself partaken of the poison, and the consequence was a severe illness, exactly at a time when the utmost activity and presence of mind were requisite for his affairs. Enemies rose against him on all hands, and one of the most inveterate of them ascended the papal throne as Julius II. Caesar was arrested and conveyed to the Castle of Medina Del Campo, in Spain, where he lay imprisoned for two years. At length he contrived to make his escape to the king of Navarre, whom he accompanied in the war against Castile, and was killed on the 12th March 1507 by a missile from the Castle of Bianco. With all his baseness and cruelty, B. was temperate and sober. He loved and patronised learning, and possessed in a remarkable degree a ready and persuasive eloquence. Machiavelli has delineated his character in his *Principe*.—**LUCREZIA B.** was a woman of great beauty. She was married first to Giovanni Sforza, Lord of Pesaro, but forsook him, and lived in incestuous intercourse

with her two brothers and with her own father. She then married, in 1498, Alfonso, Duke of Biscaglia, a natural son of Alfonso II. of Naples; but he was assassinated by her brother Caesar in 1501. In September of the same year, she married Alfonso of Este, who afterwards inherited the Duchy of Ferrara. She died in 1520. Like her brother Caesar, she shrank from no crime; but she also was a patroness of art and learning, and upon this account homage was paid to her by Pietro Bembo and other poets of that time.

BORGO, a name given to a number of towns and villages in Italy and the Southern Tyrol, and indicating the growth of the town or village around a castle or castellated rock, the original Borgo. See **BOROUGH**. Thus, *B. di val Sugana* is a place of 3500 inhabitants, with a castellated hill, in the Tyrol; *B. Lavazzano*, *B. San Dalmazzo*, and *B. Manero* are places of 2000—7000 inhabitants, in the Sardinian territory; *B. San Donnino*, a place of 6000 inhabitants, in the Duchy of Parma; *B. San Sepolcro*, a town of 4000, in Tuscany, &c.

BORING, as a process in carpentry and in the working of metals, is performed in a variety of ways. For boring holes in wood the carpenter makes use of *awls*, which simply displace a portion of the wood, and of *gimlets*, *augers*, and *bits* of various kinds, these last being applied by means of the crank-shaped instrument called a *brace*. All these are too familiar to need description. The boring of holes in metal plates for making attachments, is effected by means of *drills* driven by machinery. The annexed figure shews the essential parts of such a boring machine. The drill is inserted in the end of a vertical spindle, P, which revolves in a fixed frame, and is driven by the bevel-wheels, G. The metal to be bored is placed on a table or other support below the drill; and the up and down motion, or the end-pressure and off-action, of the drill is effected by the hand-gear, O, N, turning the screw M; which being coupled to the top of the spindle at L, presses it down or raises it, according to the way it is turned. The spindle slides vertically in the collar forming the axis of the bevel wheel, but is carried round with it by means of the pin I, which projects into a groove seen at J.

The Boring of Cannon and of Cylinders for steam-engines is most conveniently described under **CANNON-FOUNDING** and **CYLINDER**; see also **LATHE**.

BORING, applied to the earth and to rocks, has two chief uses. 1. *For Draining*.—In some districts, owing to the existence, near the surface, of a bed of clay impervious to water, the surface-water is retained in hollows, of greater or less extent. The expense of deep draining has been so great as to induce proprietors to neglect such land, but this expense has lately been avoided by leading drains to the lowest portion of the hollow, and then opening a bore through the clay to the pervious strata of sand or gravel beneath. This is done by a simple instrument, an auger of 2½ or 3½ inches in diameter, wrought by means of a cross-bar by one or two men.

2. *For Artesian wells, and for the discovery of the mineral contents of the earth*.—As the borings for these purposes are performed in the same manner, it is unnecessary to give them separate notices. The object in boring for Artesian wells is to open a passage for the escape of water from water-logged strata. See **ARTESIAN WELLS**. In the search for minerals, B. is had recourse to as a cheap method of discovering the mineral wealth of a district, and whether the quantity and quality of the contained minerals are such as to make the working remunerative. It should, however, never be undertaken without a previous geological survey of the locality; the neglect of this has caused an immense loss of time and money in futile searches for minerals, as in the innumerable cases of bores driven into Silurian and Old Red Sandstone strata, in search for coal. B. is also of use even after the presence of coal has been ascertained, to determine the most advantageous position for sinking the shaft by which the coal is to be drawn up. The general method of operating is as follows: The boring instrument consists of an iron shank, having a cross-bar at the top and a hollow screw at the bottom; to this all the successive B. instruments are fastened. A simple chisel is first attached to the screw, and one or two men press upon the cross-bar, and at the same time force it round like an auger; while another workman, by means of a lever erected overhead, with a chain descending from it to the cross-bar, gives an up and down motion to the instrument. When the chisel becomes clogged, from the accumulation of material which it has loosened, it is exchanged for a cylindrical auger, provided with a valve, which scoops out the separated material; and thus by alternate chopping and scooping the work is carried on. The nature of the strata is determined with considerable facility and certainty by examining the fragments brought up by the auger. As the work advances, successive lengths of rod are screwed on at the upper end. Three poles are erected over the well, for the purpose of elevating the rods, to permit the change of the tools.

The cost of B. varies with the material through which the operation is carried on. In strata of moderate hardness, the cost is about 10s. a fathom for the first 10 fathoms, and an additional 6s. for each 5 fathoms beyond.

A simple method of B. has been long in use among the Chinese, by which the great loss of time, arising from the screwing and unscrewing the rods, at each elevation of the chisel or auger, is saved. The chisel and scooping instrument are fastened to a rope, which is alternately elevated and allowed to descend by the simple force of gravity; the instrument thus forces its way through the ground. In the softer rocks of the newer formations this method has been successfully employed in boring for Artesian wells.

A still greater saving in time and money has been obtained by a process invented by M. Fauvelle, and described by him before the British Association in 1846. His apparatus consists of a hollow boring-rod, formed of wrought-iron tubes screwed end to end, armed at the lower end with a hollow perforating tool. The upper end of the hollow rod is connected with a force-pump by a flexible tube. By means of the force-pump a current of water is sent down the rod into the bore hole as it is sunk, and the water coming up again brings with it all the drilled particles, so that, except for the renewal of the perforating tool, the rods do not require to be elevated. M. Fauvelle found, by experience, that when he was passing through gravel, or required to bring up considerable masses of broken-off rock, it was better to inject the water by the bore-hole and

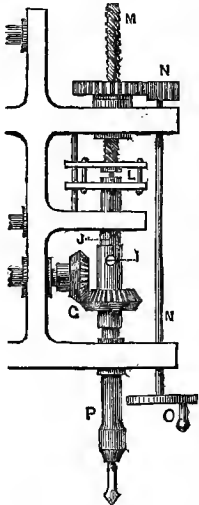

Boring Machine.

let it rise through the hollow tubs. In this way he has succeeded in raising stones $2\frac{1}{2}$ inches long by $1\frac{1}{4}$ inch thick.

BORLASE, REV. WILLIAM, an English antiquarian, was born at Pendeen, Cornwall, February 2, 1696. Ordained a priest in the English Church in 1720, he was, in 1732, presented to the vicarage of his native parish of St Just. Devoting himself to a study of the natural history and antiquities of Cornwall, he in 1753 published, at the Oxford press, a volume, entitled *Observations on the Antiquities, Historical and Monumental, of the County of Cornwall*. This was followed, in 1758, by the *Natural History of Cornwall*, printed at the same press. B. paraphrased the book of Job, and wrote several pieces of a religious nature, was active in the supervision of his parish, and took an especial interest in the improvement of its highways. But that which makes his name most interesting now, is the fact that he was one of Pope's correspondents, and furnished to the poet most of the curious fossils of which the Twickenham grotto was composed. He died August 31, 1772.

BORNEENE, FLUID BORNEO CAMPHOR, or **OIL OF CAMPHOR**, is a thin liquid, lighter than water, with a fragrant odour (somewhat resembling turpentine), obtained by distilling native oil of Borneo camphor, or oil of Valerian. The B. is employed in perfumery.

BORNEO (called by the natives *Pulo-kalamantin*), next to Australia the largest island in the world, is situated in the Indian Archipelago, and extends from lat. $7^{\circ} 4' N.$ to $4^{\circ} 10' S.$, and from long. $108^{\circ} 50'$ to $119^{\circ} 20' E.$ Divided by the equatorial line into two portions, nearly equal in surface, though of different shape, it is bounded on the E. by the Sea of Celebes and the Macassar Strait, on the S. by the Sea of Java, and on the W. and N. by the China Sea. Its length is about 800 miles, with a breadth of 700, and an area estimated at 300,000 square miles. The population is variously stated, but the probable number is about 2,500,000. The coasts of B., which are often low and marshy, and rendered dangerous to navigation by numerous islets and rocks, present no deep indentations, though they are pierced by numerous small bays and creeks. Of the interior, as yet comparatively little is known. Indeed, with the exception of certain not very extensive advances inland, made by Dutch and British enterprise, from the south and west and north-west, the country may be said to be wholly unexplored. Two chains of mountains run through the island in a nearly parallel direction, from south-west to north-east; the one rising in Sarawak (q. v.), gradually increases in elevation until it attains in its termination in Mount Kini Balu, on the north coast, a height of 13,698 feet—a cross chain, branching off in about lat. $2^{\circ} N.$, extends in a south-east direction through Banjermassin (q. v.); the other range, which is much lower, intersects the equator in long. $113^{\circ} E.$ Between are well-watered plains. B. has numerous fine rivers, especially on the north and west coast. About their upper course, however, little or nothing is known. The principal are the Batanglopar, with a breadth of 4 miles at its mouth in the China Sea, in lat. $1^{\circ} 30' N.$; the Borneo or Brunai, on which Borneo the capital of the island is situated, the Seriboe, the Morotaba or Sarawak, the Pontianak, and the Majak. On the south are the Pembuan, Sampet, Mendawa, Kahajan, Murong, and Banjer; and on the east, the Koetei and the Berou. Several of these rivers reach the sea by wide estuaries or deltas, and most of them are navigable. Kini Balu, south-east of the mountain of the same name, is the only known lake of any extent. The climate in the low grounds is moist, hot, and

unhealthy for Europeans, but in the higher grounds, towards the north-east, the temperature is generally as moderate as that of Europe. The rainy season lasts on the west coast from November to May, and the thermometer varies in the middle of the day from 81° to 91° Fahr. Vegetation is extremely luxuriant. Besides vast forests of ironwood, teak, the gutta-percha tree, ebony, &c., the products of the vegetable kingdom include dye-woods, nutmeg, sago, camphor, cinnamon, citrons, betel, pepper, ginger, rice, grain, sweet potatoes, yams, cotton, and bamboo. The animal kingdom rivals the vegetable. It produces elephants, rhinoceroses, leopards, bears, tigers, ounces, buffaloes, various kinds of deer, the babyroussa, apes, amongst which the orang-outangs are very numerous, and domestic animals; also eagles, vultures, parrots, owls, the swallows of whose edible nests the Chinese are so fond, birds of paradise, flamingoes, peacocks, &c.; many kinds of snakes, lizards, and tortoises; while in the surrounding seas are whales, seals, and cachalots, many kinds of fish, and pearl muscles. Among the mineral products are coal (said to be better than Newcastle in quality); gold, which in the district of Sambas alone yields half a million of pounds sterling annually; antimony, iron, tin, and zinc; also rock-crystals and diamonds, which sometimes are of 20 to 40 carats.

The population consists chiefly of Malays, Dyaks, Papus, Chinese, and Bugis. The Malays, who form the principal and most civilised part of the population on the coasts, are very bold, but dangerous from their rapacity and passion for revenge. They are partly Mohammedans and partly heathens, and live, like their countrymen at Malacca, under sultans and rajahs. The Dyaks, dwelling more inland than the Malays, are unquestionably the aboriginal inhabitants of the island. They are well formed, yellowish in colour, cruel, and wild. They subsist by hunting, fishing, and piracy. Their poisoned weapons make them formidable enemies; but when their favour has been won, they prove trustworthy friends. The principal tribe of them is that of the Kajan. The Papus or Negritos are probably also aboriginal inhabitants; they live in the deepest woods and solitudes, in caves, and upon trees, naked, uncivilised, and separate from the rest of mankind. The Chinese immigrants, about 250,000 in number, who form an independent commonwealth, and reject the despotic rule of the Dutch, occupy themselves with trade and the working of mines; and some of them return rich to their native country. Finally, the Bugis, who have mostly come from Celebes, live amongst the Dyaks; they are a people of some consequence, enriched by trade, and still more by daring piracy.

Cultivation may almost be said to be confined to the coasts, and is interrupted by many marshes and forests. The internal trade is carried on by the Bugis; the export trade by the Malays, the Dutch, and the British. The imports are opium, tea, and a few manufactured goods. B. is divided into several states. On the west coast lies that of Sambas, whose sultan has a number of rajahs under him. Within this district are gold diggings and diamond mines. Besides the Chinese colonies, the most important towns are Sambas, the residence of the sultan and a seat of the opium trade, and Pontianak, the centre of the Dutch power on this coast. On the south-west coast lies the territory of Succadana, or Sacadina, which is subdivided into a number of states; it has been ceded to the Dutch, but is not, properly speaking, governed by them. The capital is Succadana, which has a brisk trade with the Chinese, especially in opium. On the south coast is the state of Banjermassin, under a prince of some

consequence, who, however, is in some degree subject to the Dutch, whose fort of Tatis is in the vicinity of the capital. On the east coast lie the kingdoms of Passir, Kuti Lama, and Tirun; on the north-east coast, the kingdom of the sultan of Sulu; and on the north-west coast, the Malayan kingdom of B. or Bruni, whose sultan has many rajahs and penjerans under him. The capital is Brunai, or B., on the river of the same name, a town having a considerable trade, especially with Singapore. It is the residence of a sultan, and contains about 20,000 inhabitants. Part of the houses are built on rafts and part on stakes, and canals pass through the town in all directions. The Portuguese, who visited B. as early as 1518, effected a settlement in 1690 at Banjermassin; from whence they were, however, soon expelled. The Dutch alone succeeded in concluding a treaty of commerce with the princes of Banjermassin; and in 1643 they erected a fort and a factory at the village of Tatis, a second in 1778 at Pontianak, and a number of others since. The British made unsuccessful attempts in the years 1702 and 1774 to effect a settlement in B.; but they have, within the last twenty years, acquired a preponderating influence on the whole western coast. This has been in a great measure owing to the enterprise of Sir James Brooke (q. v.) and his vigorous government as rajah of Sarawak on the north-west coast, and in part also to the occupation of the small island of Labuan (q. v.) as a colony and naval station. The British government has, however, recently refused, upon Sir James Brooke's retirement from Sarawak, to accept it and annex it to the British empire. The piracy carried on by the inhabitants of B. has often demanded severe chastisement, and piratical flotillas have been destroyed by the British.—The Dutch have also recently extended their dominions in B., have constituted them into one government, have sent expeditions into the interior, and have renewed their treaties with the native princes.

BORNEOLE, or **BORNEO CAMPHOR**. See **CAMPHOR**.

BORNHOLM, an island in the Baltic Sea, belonging to Denmark, and situated about 90 miles east from Seeland, and half-way between the island of Rügen and the Swedish coast, lat. 54° 59'—55° 18' N., long. 14° 42'—15° 10' E. Area, including three small islands in its vicinity, about 230 square miles, with a population of 28,949. It is rocky, and traversed from north to south by a high mountain-ridge, the slope of which is in great part a waste heath, but elsewhere it is not unfruitful, and agriculture and cattle husbandry are successfully prosecuted. High cliffs, sand-banks, and breakers, make the coast dangerous. The most notable product of the island is porcelain clay, with which the porcelain manufacture of Copenhagen is carried on. The capital of the island is Rønne, or Rottum, on the western coast, a place of 4500 inhabitants.

BORNING-PIECE (Fr. *borner*, to bound), a common and very simple implement, used by gardeners in laying out grounds, to make the surface either level or of perfectly regular slope. It consists of two slips of board, one about 18 inches long, and the other about 4 feet, the shorter fastened by the middle to one end of the longer, and at right angles to it. One B. being placed at one end of a line drawn in the piece of ground which is being laid out, with the edge of the shorter slip of board along the line, and the longer slip erect, others of the same size are similarly placed at the other end and in other parts of the line; and the requisite uniformity of surface is obtained by filling up with earth, or removing it, until on looking along their

summits it appears that they are all in the same plane. The name is perhaps derived from the frequent application of the implement to borders or edgings.

BORNU, a powerful state of Central Africa, extending between lat. 10° and 15° N., and long. 12° and 18° E., and bounded on the E. by Lake Tsad, S. by Mandara, W. by Hausa, and N. by Kanem and the Sahara. The greater part of the country is perfectly level, and much of it is liable to be overflowed in the rainy season, which lasts from October to April, when fevers and other diseases consequently prevail. The heat from March to June is excessive, ranging from 104° to 107° F. The two principal rivers are the Shary and the Yeou or Yo, both of which fall into Lake Tsad. The soil is fertile, and although the cultivation is very imperfect, produces plentiful crops of maize, millet, barley, rice, various kinds of pulse, cotton, and indigo. The inhabitants possess elephants, horses, buffaloes, oxen, sheep, &c. Wild beasts, as lions, panthers, &c., are very numerous, having their chief haunts in the forests which occur only in the vicinity of the rivers, and which abound also in birds of many kinds, snakes, crocodiles, &c. Wild bees are extremely plentiful. The country produces no iron, that which is used being brought from Mandara. Much care is bestowed upon the manufacture of coats-of-mail, both for horses and their riders. The only other manufacture carried to any considerable extent is that of cotton cloth, which is dyed with beautiful blue stripes by means of indigo, and much exported to Fezzan. The population, which is estimated at from eight to nine millions, are mostly of Negro race, and called Kanowry. The ruling race, called Shouas, are of Arab descent, and bigoted Mohammedans; but many traces of Fetichism remain among the masses. Whatever they have of civilisation is derived from the Arabs. The slave-trade is eagerly prosecuted, and gives occasion to many warlike expeditions. B. appears to have existed as a state for many centuries, but in the beginning of the present century it was conquered by the Fellatahs, whose yoke, however, was soon shaken off, under the leadership of a fanatic faki, named Mohammed el Amin, whose services were called in by the sultan. The Bornuese afterwards transferred their allegiance to the sultan to Mohammed, whose descendant now rules in Bornu.

BORO BUDDOR (the Great Buddha), a splendid Buddhist temple in Java, the most elaborate monument of the Buddhist style of architecture anywhere existing. Buddhism (q. v.) was probably introduced into Java about the 10th or 12th c. of our era, and the date of the temple is assigned to the 14th century. The figure (copied from Ferguson's *Handbook of Architecture*) represents a section through one half, and an elevation of the other half, of the building. Mr Ferguson describes it as a nine-storied pyramid of a square form, measuring about 400 feet across. The five lower stories consist of narrow terraces running round the building, rising on an average about 8 feet the one above the other. On their outer edge is a range of buildings of the most various and fantastic outline, covered with small spires and cupolas of various shapes and forms, the principal ones covering 436 niches, occupied by as many statues of Buddha as large as life, seated in the usual attitude with his legs crossed. Between each of these are one or two bas-reliefs representing the god in the same attitude, besides architectural ornaments and carvings of all sorts. Below these, on the lower story, is an immense bas-relief running round the whole building, and consequently 1600 feet long, representing scenes from the

BORODINO—BOROUGH.

life of Buddha and religious subjects. These are all on the outside, but the inner faces of the five ranges of buildings are even more profusely and more minutely ornamented with bassi-relievi, and

seated figures, and architectural ornaments carried to an extent unrivalled, so far as I know, by any other building in any part of the world.

'Above and within the upper square terrace are

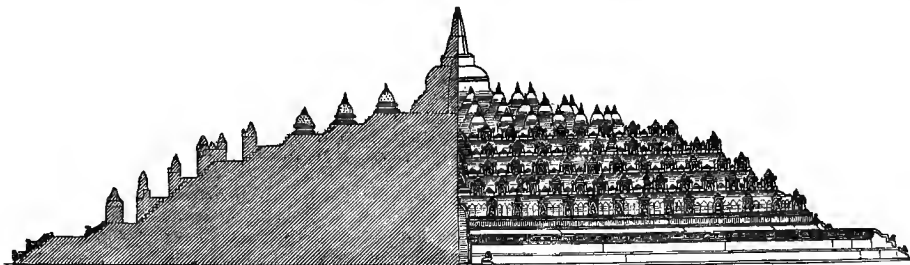

Elevation and Section of Temple of Boro Buddor.

three circular ones, the outer ornamented with 32, the next with 24, and the upper with 16 small domes, each containing a seated statue of Buddha, which can be seen through the open work of their roofs. The whole is surmounted by what must be considered as the pagoda (q. v.) itself, which is now empty, its centre being occupied only by a sunken chamber 10 feet deep, meant originally, no doubt, to contain the relic for which this splendid temple was erected.' Mr Fergusson considers that the five lower terraces are copied from and represent a Buddhist vihara or monastery; and that the niches containing the cross-legged figures were, in the originals, cells, each occupied by a shaven priest. The structure is thus a compound of a tope (q. v.) with a copy, in durable architecture, of the frail cells of a vihara.

BORODINO, a village of Russia, in the government of Moskwa, and about 70 miles west from the city of that name. It is situated on the Kalouga, an affluent of the Moskwa, and gave name to the great battle fought between the French army under Napoleon, and the Russian under Kutusow, Barclay de Tolly, and Bagration, 7th September 1812. The battle of B. was one of the most obstinately disputed in history, and the loss on both sides was almost equally great. Out of 240,000 men engaged, between 70,000 and 80,000 were killed and wounded. The Russians retreated on the following day, but it was in the most perfect order, and without the enemy venturing to attack them. The Russians, therefore, have always held this battle as a victory, and in 1839 raised a fine mausoleum on the battle-field. To the French, however, certainly belongs the honour, as they not only remained on the field of battle, but in seven days after, they had pushed on to Moscow. The French name it the battle of the Moskwa, from the river of that name, and it gave Marshal Ney his title of Prince of Moskwa.

BORON is a non-metallic element present in Boracic Acid (q. v.) and Borax (q. v.). It was discovered in 1808 by Gay Lussac and Thenard in France, and Davy in England. The process followed in procuring B. till lately, was to mix pure and dry boracic acid (BO_3) with thin slices of the metal potassium (K), and heat them in a tube, when three atoms of the potassium abstracted the oxygen, forming potash (KO), and set free the boron (B). On cooling and washing the mixture with cold water, the potash dissolved out, and left the B. as a dark greenish-brown powder, which, when heated, burned with a green flame, and was re-formed into boracic acid, by combining with

the oxygen of the air. Recently, however, Wöhler and Deville have obtained B. by heating in a crucible at a high temperature a mixture of pure dry boracic acid and the metal aluminium, when the latter takes the oxygen forming alumina (Al_2O_3), and leaves the B. as minute crystals interspersed through the earth alumina. These crystals possess great interest from their similarity in properties to pure crystallised carbon, or the diamond, and they are now known among scientific chemists as *B. diamonds*. They are remarkably transparent, are tinged yellow or red (though the colours may be accidental), and rival the ordinary diamond in their lustre and refractive power. B. diamonds not only scratch glass, but also the corundum and the sapphire; and a real diamond, with which a few B. diamonds were crushed, had its edges worn away. It is apparent, therefore, that the B. crystals possess in a high degree the characters of the ordinary diamond; and though they have as yet only been obtained in minute specks, yet it is not too much to expect that the size will be increased, and the artificial B. diamond come into market as an article of ornament, to rival the *natural* carbon diamond in its mysterious power of flashing back the rays of light. Indeed, so like are these two kinds of diamonds, that they can scarcely be distinguished by outward characters or signs; and it has been gravely suggested that some of the diamonds which now adorn the brow, the neck, or the arm, may be natural B. diamonds. They are very indestructible, requiring a high temperature to destroy them; and, like the true diamond, heat ultimately forms them into a *coke*.

BO'ROUGH (Ang. Sax. *byrig, burg, burh*; It. *borgo*; Fr. *bourg*; Scot. *burgh*). The original meaning of this word, by which we now designate a corporate township, seems to have been a hill, rising-ground, or heap of earth; and it was probably from the elevated positions on which places of defence were erected, that it afterwards came to signify a fortification or castle, and latterly the aggregate of houses, churches, and other structures, which, in unsettled times, usually gathered under the walls of a castle; together with their inhabitants, and the arrangements which were made for their government. The questions whether we owe our municipal corporations to Roman, or to Saxon and other Teutonic influences, or to both; and if to both, then to what extent they have severally contributed to their formation, have been keenly discussed by constitutional historians. In so far as etymology goes, its authority is pretty equally divided, the term *municipal*, from the Latin *municipalis*, and *city*,

BOROUGHBRIDGE—BOROUGH RATE.

from *civitas*, favouring the Roman view; whilst B. from the root above indicated, and *town*, from the Saxon *tan* or *dun*, a fortified hill, support the Teutonic. But the discussion forms a branch of a very wide subject, which has divided recent writers into two opposite schools, and of which we can here only indicate the existence. On the Roman side, Sir Francis Palgrave is the most uncompromising, and Mr Allen, as it seems to us, the more judicious champion. The Teutonic side is espoused by most of the Anglo-Saxon scholars of England, and in general by German writers. But from whatever source derived, that the boroughs of England existed, not as aggregates of houses merely, but as corporate bodies, in the Saxon time, is now generally admitted. The B. system of Scotland is also of great antiquity. 'A *Hanse*, or confederation of boroughs for mutual defence and the protection of trade, existed in Scotland, and was known by this name in the reign of David I., about a century before the formation of the Hanseatic League of the continental cities; and the famous burgh laws date from about the same period. This code of Scotch burghal regulation,' in Mr Innes's opinion, 'though collected in the reign of David, and sanctioned by him, was the result of the experience of the towns of England and Scotland;' and he goes on to shew the very close resemblance between these laws and the burghal usages of Newcastle, and even of Winchester, which seems to suggest their common Saxon origin. Mr Innes speaks favourably of the B. life of our ancestors; and he considers the burgh domestic architecture, of which monuments remain sufficient to shew that 'the burghers of the Reformation period lived in greater decency and comfort than the laird, though without the numerous following, which no doubt gave dignity if it diminished food. I am not sure that this class has gone on progressively, either in outward signs of comfort, or in education and accomplishment, equal to their neighbours. The reason, I suppose, is obvious. The Scotch burgher, when successful, does not set himself to better his condition and his family within the sphere of his success, but leaves it, and seeks what he deems a higher.' In confirmation of this view, Mr Innes elsewhere mentions that 'many of the old citizen-merchants of Edinburgh had studied at the university, and appear in the list of graduates.'

Borough, in England, is properly a city or other town that sends burgesses to parliament—a privilege, the nature and extent of which will be explained under PARLIAMENT, and PARLIAMENTARY REFORM ACTS (q. v.); and in this sense it is also called a *parliamentary borough*. But in the interpretation clause of the Municipal Reform Act, 5 and 6 Will. c. 76, s. 142, the word *borough* is declared, for the purposes of the act, to mean a city, borough, port, cinque port, or town corporate, and whether sending representatives to parliament or not. See MUNICIPAL B., MUNICIPAL CORPORATION, and MUNICIPAL CORPORATIONS ACT.

BOROUGHBRIDGE, a town in West Riding, Yorkshire, on the right bank of the Ure, here navigable for small-craft, 17 miles north-west of York. It arose simultaneously with the decline of Aldborough, 1½ mile to the east, soon after the Conquest, when the great north road was diverted from Aldborough to this place. Its chief trade is in agricultural produce and hardware. Pop. 1095. Edward II., in 1321, defeated the Earl of Lancaster here. Near B. are three immense Druid stones, called the 'Devil's Arrows,' 16 to 22 feet high.

BOROUGH ENGLISH is a custom that prevails in some ancient boroughs in England, according to

which the youngest son inherits the property within borough in preference to his elder brothers. The reason assigned for it is, that the youngest son, on account of his tender age, is not so capable as his elder brothers to maintain himself. A posthumous son is entitled to this privilege, and dispossesses his elder brother. The right of representation also exists with reference to it, for should the youngest son die in his father's lifetime leaving a daughter, she will inherit the property. This custom obtains in the manor of Lambeth, Surrey, in the manors of Hackney, St John of Jerusalem in Islington, Heston, and Edmonton in Middlesex, and in other counties. See CUSTOM, GAVELKIND, INHERITANCE.

BOROUGH FUND. This is a fund which is expressly defined by the Municipal Corporations Act, 5 and 6 Will. IV. c. 76, by which it is declared that the rents and profits of all hereditaments, and the interest, dividends, and annual proceeds of all moneys, dues, chattels, and valuable securities belonging or payable to any body corporate named in conjunction with a borough in the schedules, or to any member or officer thereof, in his corporate capacity, and every fine or penalty for every offence against this act (the application of which has not been already provided for), shall be paid to the treasurer of such borough; and all the moneys which he shall so receive shall be carried by him to the account of a fund to be called 'The Borough Fund;' and such fund, subject to certain payments and deductions, shall be applied towards the payment of the salary of the mayor, and of the recorder, and of the police magistrate, when there is a recorder or police magistrate, and of the respective salaries of the town-clerk and treasurer, and of every other officer whom the council shall appoint; and other borough expenses.

The Court of Chancery exercises jurisdiction over the property of corporations in boroughs, which, since the Municipal Corporations Act, are considered to hold their property in trust for charitable uses; and the trusts are applicable as well to the personal as to the real estate. See Grant on Corporations, 1850; and see FUND.

BOROUGH JUSTICES were first created in the time of Charles I. Under the Municipal Corporations Act, 5 and 6 Will. IV. c. 76, these justices consist of the mayor during his year of office, and for one year after it determines; the recorder *ex officio*; and such persons as the crown may appoint by commission. Their duties cannot be delegated; and before acting, they must make the same declaration, and take the same oaths as the recorder does on entering his office. See JUSTICES.

BOROUGH LAWS, in Scottish legal history, was the name given to a collection of ancient laws relative to boroughs or *burghs*, which have long ceased to have any force, but serve to throw light on the ancient manners and customs of the country. The authenticity of these B. L. is beyond question; they are universally allowed to have been enacted in the reign of King David in the 12th century. See REGIAM MAJESTATEM.

BOROUGH RATE is a rate raised and levied within borough by order of the council of the same; and it has been decided by the Court of Exchequer that such rate is valid, though not made *in public*. By the 92d section of the Municipal Corporations Act, 5 and 6 Will. IV. c. 76, where there is a deficiency of the *borough fund* (q. v.), the borough council is authorised and required from time to time to order a B. R. in the nature of a *county rate* (q. v.) to be made within their borough, for which purpose the council shall have all the

powers of county justices. As to boroughs not within the Municipal Corporations Act, the levying and application of borough rates, in them is regulated by the 17 and 18 Vict. c. 71, by the first section of which it is enacted that the justices of the peace may make a B. R. in the nature of a county rate, for all the purposes for which a B. R. may be levied, such borough justices also having the same powers as county justices. The council of a borough cannot make a *retrospective* rate; and the provision of the 7 Will. IV. and 1 Vict. c. 81, s. 2, which declared lawful all such retrospective rates as might be made within six calendar months after the passing of the act, was merely for a temporary purpose. The Municipal Corporations Act directs that all sums levied in pursuance of a B. R. shall be paid over to account of the borough fund; and there is a provision as to *Watch Rates* (q. v.).

Where parties consider themselves aggrieved by a B. R., they may appeal to the recorder at the next quarter-sessions for the borough in which such rate has been made; or if there be no recorder, to the next county quarter-sessions.

BOROVSK, or **BOROVSK**, a town of Russia, in the government of Kalouga, and 49 miles north-north-east of the town of that name. Conjointly with Kalouga it gives title to a bishop. It has extensive manufactures of sail-cloth, and a trade in leather, flax, and hemp. Its onions and garlic are celebrated. In its vicinity is a convent, founded in 1444, one of the richest in the empire. Pop. 6000.

BORROMEAN ISLANDS, a group of small islands in the Lago Maggiore, Northern Italy. They are situated in the western arm of the lake, called the Bay of Tosa, and are named after the family of Borromeo, which for centuries has been in possession of the richest estates in the neighbourhood. They are sometimes also called *Isole dei Conigli*, on account of the number of rabbits found on them. They were little more than naked rocks, till Vitaliano, Count Borromeo, master-general of ordnance to the king of Spain, about 1671, caused soil to be carried to them, built terraces, and converted them into gardens, the beauty of which and of their situation has won for them the name of the *Enchanted Islands*. The two most celebrated are *Isola Bella* and *Isola Madre*. On the west side of *Isola Bella* stands a palace of the Borromeo family, containing many admirable paintings and other works of art. The *Salle terrene*, a series of grottos, inlaid with stones of various colours and adorned with fountains, connect the palace with the gardens, the terraced style of which gives to the whole island the appearance of a truncated pyramid; a colossal winged unicorn, the armorial device of the Borromeo family, crowning the whole. *Isola Madre* is laid out in the same terraced style, and is crowned by a castle. The odours of flowers from the islands, upon which grow many plants of tropical climates, are wafted far over the lake. The *Isola de' Pescatori* now contains a village of about 400 inhabitants, who derive their subsistence from fishing and smuggling.

BORROME'O, CARLO, COUNT, a saint of the Church of Rome, was born on the 2d October 1538, at the Castle of Arona, on the Lago Maggiore, the family seat of his ancestors. He studied law at Pavia, and took the degree of doctor in 1559. His uncle, Pope Pius IV., on being raised to the pontificate in 1560, appointed him, notwithstanding his youth, to a number of high offices, and made him a cardinal and archbishop of Milan. B. displayed great faithfulness and ability in governing Ancona, Bologna, and other parts of the States of the Church

as legate, and in discharging the duties of offices connected with ecclesiastical administration at Rome. Surrounded as he was with magnificence and luxury, he was always grave, pious, and rigid in his life, studious, and a patron of letters. His uncle, the pope, made him his grand penitentiary, and did nothing considerable without his co-operation. It was in a great measure by his influence that the re-opening of the Council of Trent was accomplished, and that its deliberations were brought to a conclusion so favourable to the papal throne. He committed its decrees to memory, had the principal part in drawing up the *Catechismus Romanus* for exposition of them, and proceeded to give all possible effect to them in his archiepiscopal province. B.'s exertions, not only for the improvement of ecclesiastical discipline, but also for the reformation of morals in the archbishopric of Milan, drew upon him the hostility of the monastic orders, and also to some extent that of the Spanish authorities in Milan, who were jealous of the extension of his jurisdiction. An attempt was even made upon his life in 1569. He spent great part of his income in beautifying the cathedral and other churches. With a view to provide well-qualified priests, he founded, in 1570, the Helvetic College at Milan. He brought about an alliance of the seven Catholic cantons, known as the *Golden Borromean League*, for the united defence of their faith. In the famine of 1570, and during the plague in Milan in 1576, he displayed equal energy, benevolence, and devotedness, saving the lives of multitudes by the prompt arrangements which he made for necessary relief. Exhausted by his labours and his austerities, he died on 3d November 1584. Many supposed miracles at his tomb led to his being canonised in 1616. His theological works were published at Milan in 1747, in 5 vols. folio. On the western bank of the Lago Maggiore, in the neighbourhood of his birthplace, is a colossal brazen statue of him.—His brother's son, Count Frederico Borromeo, born 1563, was also a cardinal, and from 1595 to 1631 archbishop of Milan, and was the founder of the Ambrosian Library (q. v.).

BORROW, GEORGE, an English author, born at Norfolk in 1803. He displayed from his earliest years an extraordinary talent for languages, and a strong inclination for adventure. In his youth he lived for some time among gipsies, by this means acquiring an exact knowledge of their language, manners, and customs. His travels, as agent for the British and Foreign Bible Society, through almost all countries of Europe and a part of Africa, made him familiar with many modern languages, even to their dialectic peculiarities. Whatever was little known had peculiar charms for him, and he shrunk neither from toil nor danger. True to his youthful predilection, he made the gipsies scattered over every part of Europe one of the principal subjects of his study. His first work, *The Zincolis, or an Account of the Gipsies in Spain* (2 vols., Lond. 1841), made a favourable impression by its lively and dramatic style. It was followed by *The Bible in Spain* (2 vols., Lond. 1843), a book to which its author is chiefly indebted for his celebrity, and which consists of a narrative of personal adventures as various as it is interesting. The graphic power of the style amply compensates for the rather unmethodical arrangement of the book. After a long interval, B. published a work long before announced, *Lavengro, the Scholar, the Gipsy, and the Priest* (3 vols., Lond. 1851), which was generally regarded as an autobiography, with a spice of fancy mingling with fact. The principal character is depicted with extravagant exaggeration; and the somewhat bizarre originality which gave a peculiar zest

to the author's earlier works here appears as mannerism. The book left the hero in the midst of his adventures, which were not continued until 1857, when B. published *The Romany Rye*, a sequel to *Lavengro*, which was in all ways a more unsatisfactory work than any of its predecessors.

BORROWING has, in the case of *money*, several legal applications of a general nature, in which the law with regard to *bonds*, *mortgages*, and other similar *securities*, has to be considered. See the articles on these subjects. More strictly, B. may be described as a contract under the law of *bailments* (q. v.)* and may be briefly and simply defined as asking or taking a loan. The essentials of this contract are, that there must be a certain specific thing lent, such as a book, an article of furniture, a horse, or it may be a house, land, or even an incorporeal right. But in the law of England the contract is confined to goods and chattels or personal property, and does not extend to real estate. Lord Chief Justice Holt's definition described it as a B. of a thing *lent*, in contradistinction to a thing deposited, or sold, or intrusted to another for the sole benefit or purposes of the owner. Again, the B. must be gratuitous and for the borrower's use, which use must be the principal object, and not a mere accessory. Such use, too, may be for a limited time or for an indefinite period. The contract must also be of a legal nature, for if it is immoral, or against law, it is utterly void; this, however, is a necessary qualification of all contracts. Lastly, the property which is the subject of the contract must be borrowed or lent to be *specifically* returned to the lender at the determination of the agreement, in which respect it differs from a loan for consumption.

The persons who may borrow and lend are all those who can legally make a contract; a capacity, therefore, which excludes married women, unless they act with the consent of their husbands, when it binds the latter and not the wives.

It is not necessary that the lender should be absolute proprietor of the thing lent or borrowed; it is sufficient if he have either a qualified or a special property therein, or a lawful possession thereof. As to the borrower, he has the right to use the thing during the time and for the purpose intended, whether such intention is expressed or implied; but beyond this he cannot go. The following quotation from Mr Justice Story's celebrated work on *bailments* (to which reference is generally made), is useful for popular information: 'A gratuitous loan is to be considered as strictly personal, unless, from other circumstances, a different intention may fairly be presumed. Thus, if A lends B her jewels to wear, this will not authorise B to lend them to C to wear. So, if C lends D his horse to ride to Boston, this will not authorise D to allow E to ride the horse to Boston. But if a man lends his horses and carriage for a month to a friend for his use, there, a use by any of his family, or for family purposes, may be fairly presumed; although not a use for the benefit of mere strangers.' During the period of the loan, the borrower has no property in the thing, but a mere right of possession and use of it. But, notwithstanding, if the thing lent and borrowed be injured by a stranger, it would appear that the lender may maintain an action for the recovery of damages; the mere possession of property without title being sufficient against a wrong-doer. See **CONTRACT**, **LOAN**, **HIRE**, besides the subjects above referred to.

* The article on *Bailments* having been accidentally omitted at its proper place, the reader will find the subject explained under **CONTRACT**.

BORROWING DAYS. The last three days of March are so called in Scotland and some parts of England. The popular notion is, that these days are borrowed or taken from April, and may be expected to consist of cold or stormy weather. Although this notion dates from a period before the change of the style, a few days of broken and unpleasant weather about the end of March still afford a sanction for old notions concerning the borrowing days. The origin of the term B. D. is lost in the mists of antiquity, though we are inclined to hazard the conjecture that it has no higher source than the popular rhyme in which it is introduced as a poetic fiction. The most dramatic form of this rhyme in Scotland is as follows:

March said to April:
 'I see three hogs on yonder hill;
 And if you'll lend me days three,
 I'll find a way to gar [make] them die!'
 The first o' them was wind and weet,
 The second o' them was snaw and sleet,
 The third o' them was sic a freeze,
 It froze the birds' feet to the trees.
 But when the borrowed days were gane,
 The three silly hogs came hirplin [limping] hame.

The superstition, if we may so call it, respecting the B. D., though now little else than a jocular fancy, was so strong in Scotland in the 17th c., that when the Covenanting army, under Montrose, marched into Aberdeen on the 30th March 1639, and was favoured by good weather, a minister pointed it out in his sermon as a miraculous dispensation of Providence in behalf of the good cause. See Gordon of Rothiemay's *History of Scots Affairs from 1637 to 1641*. For further notice of the B. D. we refer to Brand's *Popular Antiquities*.

BORROWSTOUNNESS, or **BONESS**, a seaport in Linlithgowshire, on a low peninsula on the Firth of Forth, 17 miles west-north-west of Edinburgh. It has coal-mines extending under the bed of the Firth; and manufactures of salt, soap, malt, vitriol, and earthenware, and a trade in grain. Ironstone, limestone, and freestone also exist in the parish. Graham's Dike, a part of the Roman wall of Antoninus, traverses the parish. Dugald Stewart lived near Borrowstounness. Pop. 2645. In 1858, 60 vessels of 5624 tons belonged to the port; and 1658 vessels of 149,485 tons entered and cleared it.

BORY DE SAINT VINCENT, **JEAN BAPTISTE GEORGE MARIE**, a French traveller and naturalist, was born in 1780 at Agen, now in the department of Lot-et-Garonne. In 1798, he proceeded, along with Captain Baudin, in a scientific mission to New Holland, but separated from him before they reached their destination. Among the fruits of his travels were his *Essai sur les Iles Fortunées de l'antique Atlantide, ou Précis de l'Histoire Générale de l'Archipel des Canaries* (Par. 1803), and his *Voyage dans les quatre principales Iles des Mers d'Afrique* (3 vols., Par. 1804). Having returned to his native country, he became a captain in the army, served at Ulm and Austerlitz, went to Spain, and became military intendant in the staff of Marshal Soult. In 1815, he served as a colonel, and after the battle of Waterloo made an eloquent but fruitless appeal to his colleagues in the Chamber against submitting to the Bourbons, and was compelled to go into exile. At Brussels he edited, along with Van Mons, the *Annales des Sciences Physiques* (8 vols.). He also produced an admirable work on the subterranean quarries in the limestone hills near Maestricht (Par. 1821). He returned to France in 1820, wrote for liberal journals, and for Courtin's *Encyclopédie*, &c. In 1827, appeared his *L'Homme, Essai Zoologique*

sur le Genre humain. He wrote what relates to cryptogamic plants in Duperrey's *Voyage autour du Monde* (Par. 1828). He rendered an important service to science by editing the *Dictionnaire Classique de l'Histoire Naturelle*. When, in 1829, the French government sent a scientific expedition to the Morea and the Cyclades, the first place in it was assigned to B. de S. V.; and the results of his researches were given to the world in the *Expédition Scientifique de Morée* (Par. and Strasb. 1832, &c.), and in the *Nouvelle Flore du Péloponnèse et des Cyclades* (Par. 1838). In 1839, he undertook the principal charge of the scientific commission which the French government sent to Algeria. He died 22d December 1846.

BOS. See BOVIDÆ and OX.

BOS, LAMBERT, a Dutch philologist, was born at Workum, in Friesland, 23d November 1670, and studied at the university of Franeker, where, by the advice of Vitringa, he devoted himself especially to the Greek language. In 1704, he was appointed Greek professor in that university. He died 6th January 1717. All his works are characterised by thorough scholarship and remarkable acuteness, and notwithstanding the advances of classical criticism since his day, some of them are still consulted, such as his *Vetus Testamentum ex Versione Septuaginta Interpretum* (Franeker, 1709; new edit., Oxford, 1805), his *Ellipses Græcæ* (Franeker, 1702), and more particularly his *Antiquitatum Græcarum præcipue Atticarum Descriptio Brevis* (Franeker, 1714).

BOSA, a town of the island of Sardinia, in the division of Cape Sassari, near the mouth of the Termo. Lat. 40° 17' N., long. 8° 27' E. Notwithstanding its fine situation, partly on the side of a hill and partly on a plain, it is an unhealthy place. It is surrounded by decaying walls; has an old castle, a cathedral, several monasteries and churches; and a trade in wine, oil, grain, and cheese. Its port admits only vessels of small size. Pop. 6500.

BOSCAN-ALMOGA'VER, JUAN, a Spanish poet, born in the year 1500 at Barcelona, of an ancient noble family. He received from his parents a careful education, and came to Granada, to the court of Charles V. The education of the celebrated Duke of Alva was afterwards intrusted to him. He spent the latter part of his life at Barcelona, and was employed in editing his own works and those of his friend Garcilasso de la Vega, when he died some time prior to 1544. He was the first to make use of Italian measures in Spanish verse, and thus became the creator of the Spanish sonnet. By the introduction of various Italian forms, he made an epoch in Spanish poetry. His poems are still esteemed, but his other literary productions are forgotten. The best edition is that of Leon, 1549.

BOSCAW'EN, EDWARD, an eminent English admiral, second son of Viscount Falmouth, was born in 1711, and highly distinguished himself at the taking of Puerto-Bello, and at the siege of Carthagena in 1740. In April 1744, he captured the French ship *Medée*, with 800 prisoners. He had an important share in the victory off Cape Finisterre (May 3, 1747), and six months after received the command of the East Indian expedition; he displayed high military skill in conducting the retreat from Pondicherry. He returned in 1750, and in the following year became a lord of the Admiralty. In 1755, he was again afloat, and intercepted the French fleet off Newfoundland, capturing two 64-gun ships and 1500 men, including the French commander, Hoquart, whom he had twice before

taken prisoner. Next year, now admiral of the blue, he was appointed commander-in-chief of the powerful expedition against Cape Breton, as the fruit of which that island and St John's were taken after some hard fighting. B. crowned his career by his signal victory over the French Toulon fleet, in the Bay of Lagos, August 18, 1759. On his return home, he received the thanks of parliament, a pension of £3000 a year, a seat in the privy council, and the command of the marines. In the following summer, while his fleet lay idle in the Bay of Quiberon, ravaged by scurvy, B. and some of his men employed themselves in cultivating a garden on a small island, in order to supply the sick with vegetables. He died in the following year. Lord Chatham is said to have testified that when he proposed expeditions to other commanders he heard only of difficulties, but when he applied to B., he found him ready with suggestions and expedients.

BOSCH, HIERONYMUS DE, born at Amsterdam 23d March 1740, died there 1st June 1811, was unquestionably the most distinguished Latin poet of recent times, and a philologist of varied acquirements. His *Pœmata* first appeared at Leyden in 1803 (2d ed., Utr. 1808). He rendered an important service to classical literature by his edition of the *Anthologia Græca*, with a metrical translation by Hugo Grotius never before published (4 vols., Utr. 1795—1810, to which Van Lennep added a fifth volume, Utr. 1822). His Discourses and Treatises on subjects of literature, which are mostly composed in the Dutch language, display profound learning, excellent judgment, and refined taste.

BOSCOBEL, an extra-parochial liberty of England, in the county of Shropshire, about 6 miles east-north-east of Shifnal. The population of B. is only about 20, but the place is interesting in connection with the escape of Charles II. after his defeat at Worcester in 1651. After the battle, Boscobel House being proposed as a secure retreat, thitherwards Charles turned his steps. At White-Ladies, a seat of the Giffard family, which was reached in the early morning, the king had his long hair cut, his hands and face smeared with soot; and for his royal dress he substituted the green and greasy suit of a countryman, and a leathern doublet. Thus disguised, Charles passed through a secret door into a neighbouring wood, in the thickest part of which he sat shivering in the rain until dusk, when he stole out, and along with a guide endeavoured to reach Wales, where it was now thought he would be safer than at Boscobel. They reached a royalist's house at Madeley, on the banks of the Severn, at midnight, and it was then found that they could not escape to Wales, on account of the vigilance of the Puritans; and once more, after a day's rest in a stable loft, the king started for Boscobel wood, where he arrived about five o'clock in the morning. He immediately, along with Major Carlis, who had led the forlorn-hope at Worcester, ascended a thick pollard oak, from which they could watch at intervals during the day the Roundheads in search of them passing by unaware of their near presence. In the evening, they descended from their elevated hiding-place, and made their way to the manor-house, where the king remained hidden for two days. After other adventures, Charles contrived to escape from England on the 17th October.—The title of BOSCOBEL TRACTS has been given to certain contemporaneous writings, first published in 1662, giving a graphic description of this passage of the monarch's life. The authorship is generally attributed to Thomas Blount, a loyal gentleman of Worcestershire; but Nash, his grandson, in his history of Worcestershire, denies that they were his, on the authority of Blount

himself. But the author, whoever he was, was manifestly a staunch royalist, and his narrative bears evidence that he had good opportunity for ascertaining the truth of all the statements in it.

BOSCO TRE-CASÉ, a town of Naples, situated at the southern base of Mount Vesuvius. It has several churches and convents, and a royal manufactory of arms and gunpowder. Wine and silk are raised in the district. Pop. 8500.

BOSCOVICH, ROGER JOSEPH, a celebrated mathematician and astronomer, born at Ragusa 18th May 1711. He entered at an early age into the order of the Jesuits, and spent his life in scientific pursuits and important public labours. Before the completion of his course of studies in Rome, he was appointed teacher of mathematics and philosophy in the *Collegium Romanum* there. The pope gave him a commission to measure a degree of the meridian in the States of the Church, which he accomplished in the years 1750—1753. In 1764 he was appointed to a professorship in Pavia, but after some time retired from this office. He was subsequently appointed professor of astronomy and optics in the Palatine schools at Milan, and superintended the erection of the observatory in the Brera College, upon which he spent money of his own. After the dissolution of his order, he went to Paris in 1774, and received a pension from the king. B. afterwards went to Bassano, to superintend an edition of his works, on the completion of which he returned to Milan, but fell into a depression of spirits, which at last grew into complete insanity, and he died 12th February 1787. His works include dissertations on a great variety of important questions in mathematical and physical science, and were published collectively under the title *Opera Pertinentia ad Opticam et Astronomiam* (5 vols., Bassano, 1785). His name is connected with a theory of physics, first published in his *Philosophia Naturalis Theoria, Redacta ad Unicam Legem Virium in Natura Existentium* (Vienna, 1758). He was also a poet, and his Latin poem, *De Solis ac Luna Defectibus* (Lond. 1764), has been much admired.

BOSIO, FRANÇ. JOS. BARON, an eminent sculptor, was born 1769 at Monaco, in Sardinia; studied at Paris; and when only 19, returned to Italy, where he executed a multitude of commissions even at that early age. His reputation was greatly increased by the figures which, at the request of Napoleon, he executed for the column in the Place Vendôme. Louis XVIII. and Charles X. also patronised B., the former appointing him royal sculptor, the latter elevating him to the rank of baron. He also enjoyed several professional honours, being director of the Academy of Fine Arts in Paris, and member of the Berlin Academy of Arts. He died July 29, 1845. B.'s principal works are—the 'Hercules' in the garden of the Tuilleries; the incomparably beautiful 'Hyacinth' in the Luxembourg; the 'Nymph Salmacis,' a figure displaying wonderful grace and purity of outline; an allegorical figure of France, 7 feet high, surrounded by the Muse of History and a group of Genii; the statue in memory of the Duc d'Enghien; the equestrian statue in the Place des Victoires, and the monument of Count Demidov, 30 feet high, composed of six figures, with bas-reliefs, &c. Besides these, B. executed a great multitude of busts of distinguished persons, such as the Emperor Napoleon, the Empress, Queen Hortensia, the king and queen of Westphalia, Louis XVIII., Charles X., &c. B.'s works are all marked by grace of form, harmony of design, and elegance of finish. His style generally reminds one of Canova.

BO'SJESMAN'S COUNTRY, a region in Africa to the north of the Cape Colony. The inhabitants, a



Bosjesman.

variety of the Hottentot (q. v.) race, are remarkably diminutive in stature, and thoroughly savage in condition.

BOSNA-SERAI, SERAÏO, or SARAJEWO (Ital. Seraglio), capital of the province of Bosnia, European Turkey, is beautifully situated in the midst of gardens on both sides of the Migliazza, an affluent of the Bosna, about 122 miles southwest of Belgrade. Its population is estimated at from 40,000 to 60,000, two-thirds of whom are Turks, the rest Greeks and Jews. Four handsome stone bridges cross the river at different points of the city, which is adorned with 150 mosques and churches, whose gilded domes and whitened minarets and spires give it quite an oriental appearance. B. has a palace built by Mohammed II., and an old castle on a height, erected in 1263 by the Hungarian general Cötroman; its old walls are decayed, but it is defended by a citadel, well provided with cannon, and has manufactures of cutlery, jewellery, leather, and woollen goods. Its position makes it the entrepôt for the commerce of South Germany, Croatia, Dalmatia, and Turkey, and it is consequently a busy place. It has important iron mines and mineral baths in its vicinity.

BOSNIA, the most north-westerly province of European Turkey, forming an eyalet, governed by a pasha, and including, besides Bosnia proper, the Turkish parts of Croatia and Dalmatia, and the district of Herzegovina (q. v.). It extends between lat. 42° 30' and 45° 15' N., and long. 17° 40' and 21° E. It is bounded N. by the Save and Unna; E. by the Vrina, the mountain-chain of Jublaniak, and a branch of the Argentic Alps; S. by the Scardagh Mountains; and on the W. by the mountains of Cosman, Timor, and Steriza. At a few points in the south it reaches to the Adriatic Sea. It has an extent estimated at 18,800 square miles, with a population of about a million. With the exception of the northern tract, extending along the Save, it is everywhere a mountainous country, and is traversed by more or less elevated ranges of the Dinaric Alps, whose highest peaks rise to a height of from 5000 to 7700 feet above the sea, and are covered with snow from September to June. The mountain slopes are for the most part thickly covered with forests of oak, beech, lime, chestnut, &c., of magnificent growth, and only here and there

exhibit meadows, pastures, and cultivated spots. The principal river of the country is the Save, on the northern border, into which flow the Unna, the Verbas, the Bosna, and the Drin. The Narenta and the Boyana fall into the Adriatic Sea. The air is salubrious, the climate temperate and mild. It is only in the plain that agriculture is carried on to a considerable extent; grain, maize, hemp, vegetables, fruits, and grapes are produced in great abundance; and their cultivation would be much more extensively and actively prosecuted, but for the heavy impositions laid upon this branch of industry by the Turkish government. Game and fish abound, as well as wild animals, such as bears, wolves, lynxes, &c. The country is celebrated for the breeding of sheep, swine, goats, and poultry; and bees, both wild and tame, are very numerous. The gipsies and Morlacks dig for lead, quicksilver, coal, and iron; but beyond this, mining, owing to repressive government, is entirely neglected, although the country is rich in metallic ores. Commerce and manufactures—chiefly limited to the fabrication of firearms, sabre-blades, and knives—are entirely confined to the towns. The position of B. gives it the transit trade between Austria and Turkey. There are almost no good roads in the country. The population consists of Bosnians, Croats, Morlacks, Montenegrines, Turks, Germans, Illyrians, Dalmatians, &c., the much greater part being of the Slavonian race. The Bosnians, or Bosniaks, who form about a third of the inhabitants, are partly Mohammedans and partly of the Greek and Roman Catholic Churches. They are brave, hardy, rapacious, and cruel; rude and repulsive towards strangers, yet among themselves they are peaceful and honest; they are also industrious, simple in their habits, and temperate. The Moslem women in B. are less secluded than in the other Turkish provinces, and have long enjoyed the liberty of appearing in public more or less veiled. The Croats, who form about a sixth of the population, belong partly to the Greek and partly to the Roman Catholic Church; only a few are Mohammedans. They are principally engaged in agriculture, the feeding of cattle, and the barter trade. The Morlacks, who number about 150,000, dwell mostly in the district of Herzegovina, are courteous, clever in business, and extremely ready in adapting themselves to anything. They are inveterate enemies of the Turks. Three-fourths of them are Greek Christians, and the rest Roman Catholics. The Turks form more than a fourth of the inhabitants, the number of Greeks and Jews is between 20,000 and 30,000. B., being a frontier province, is important as a line of defence, and has consequently a great number of fortifications. B., in ancient times, was included in Pannonia; and previous to the 7th c., was governed by princes of its own, called Bans or Waiwodes, who became dependent on Hungary. Being conquered by the Turks, it was finally annexed to the Ottoman empire, in 1522, by Solyman the Magnificent. Since the introduction of reforms, denuding the former hereditary chiefs of their highest prerogatives, and a great part of their revenues, B. has been the seat of almost perpetual disturbance, and several campaigns have had to be undertaken against it by the Turkish government. A most dangerous rebellion broke out in 1851, which was not quelled by Omar Pasha until he had inflicted several defeats on the rebels, and stormed some of their fortresses. Since that time the country has been more quiet.

BOSPORUS, the ancient name of the channel now known also as the Strait of Constantinople, which separates Europe from Asia, and connects the Black Sea with the Sea of Marmora. The name,

which signifies Ox-ford or Cow-ford, was given to it because here, according to the legend, Io, transformed into a cow, swam across; or, as is very generally supposed, because it is so narrow that an ox might swim across. Afterwards, as the same name was bestowed upon other straits, this was designated the *Thracian Bosphorus*. Its south and north entrances have two light-houses each. Its shores are elevated, and throughout its length the strait has 7 bays or gulfs, with corresponding promontories on the opposite side. One of these gulfs forms the harbour of Constantinople, or, as it is often called, the Golden Horn. The length of the Thracian B. is about 17 miles, with a breadth of from little more than a third of a mile to two miles. At the middle of this strait, where it is about 2800 feet in breadth, Darius made his bridge of boats when he marched against the Scythians.—The name of *CIMMERIAN BOSPORUS* was given by the ancients to the Strait of Kaffa (q. v.), also called the Strait of Yenikalé or of Theodosia. The country on both sides of the Cimmerian B. formed, in ancient times, the kingdom of Bosphorus, which was founded by the Archæanactides, 502 B. C. They reigned till 480. A new dynasty began with King Spartocus, 480—438 B. C. Under Satyrus I., who died in 393, the kingdom was extended along the Asiatic coast; and under Leucon I., after whom his descendants were called Leuconides, Theodosia was united with it in 360. King Leucanor became tributary to the Scythians in 290; and this tribute afterwards became so oppressive, that Parisades, the last of the Leuconides, preferred to become subject to Mithridates, king of Pontus, who in the year 116 B. C. vanquished the Scythians, and set his son, Machares, on the throne of Bosphorus. He having taken his own life, and Mithridates having followed him to the grave, the Romans gave the country, in 63 B. C., to Pharnaces, the second son of Mithridates, and after his assassination, to several princes who gave themselves out for descendants of Mithridates. When at last the family became entirely extinct, in 259 A. D., the Sarmatians made themselves masters of the kingdom, from whom the inhabitants of the Chersonesus took it in 344. Along with Tauric Chersonesus, it afterwards formed a part of the Eastern Roman Empire, until the Chazars, and afterwards the Tatars, under Mongolian princes, made themselves masters of it. See TAURIA.

BOSQUET, PIERRE FRANÇOIS JOSEPH, a distinguished French marshal, born 8th November 1810 at Mont de Marsan, in the department of Landes, entered, in 1829, the Polytechnic School at Paris, and in 1833 joined the artillery as sub-lieutenant. In June 1834, he proceeded with his regiment to Algeria, where he became conspicuous for his military tact, energy, and valour. In 1847, he had attained the rank of colonel, and the following year he was named general of brigade by the republican government. In the end of 1853, he returned to France, and in 1854 was appointed by the emperor general of division. He had the command of the second division of the French army in the Crimea, and at the battle of the Alma, 25th September, his successful manoeuvres against the Russian left wing were mentioned in Marshal St Arnaud's dispatch to the emperor as deciding the fate of the day. At Inkermann, 25th November, he contributed greatly to the defeat of the Russians. His conduct on this occasion was noticed with praise by Lord Raglan in his dispatch, and the British parliament voted its thanks to him in a special resolution. He also took a leading part in the capture of the Malakoff, 8th September 1855; but a wound he received from the bursting of a shell obliged him to retire to France. In 1856 he was made field-marshal of France.

BOSS, in Architecture, a raised ornament, covering the intersections of the ribs of ceilings. They are more frequently seen in vaulted roofs, as in the

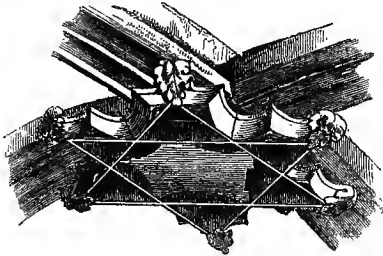

Boss.—From Notre-dame la Riche, Tours.

aisles of a church, but occur also where the ceiling is flat. In early Norman work there are generally no bosses, and they become richer and more frequent as we advance towards the decorated and perpendicular styles. In the decorated style the B. usually consists of foliage, sometimes combined with animals, heads, and the like. Coats-of-arms, charged with armorial bearings, came then also to be used for this purpose, though they were more frequent in the perpendicular.

—The B. of a bit is the ornament with which a bridle-bit terminates at each end. It was borne in the arms of the corporation of Lorimers. See LORIMER.

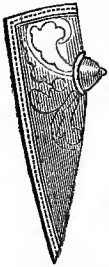

Boss, on Norman shield.

BOSSI, LUIGI, an Italian archæologist and historian, was born at Milan in February 1785; studied at Pavia, and became a canon of the cathedral of Milan; but when the French entered Italy, he took the side of the invaders, and was appointed by Bonaparte agent of the French government at Turin, and afterwards prefect of the archives of the kingdom of Italy. He died at Milan 10th April 1835. He was an extremely prolific author, and produced more than 80 works, great and small, including theological and religious works, dissertations on antiquarian subjects, historic works, works on subjects connected with the fine arts, tragedies, comedies, &c. That his works have afforded many opportunities for unfavourable criticism, is only what might be supposed, from their number and variety. His *Introduzione allo Studio delli Arti del Disegno*, is instructive and much esteemed. His most important historic works are a much enriched translation of *Roscoe's Life of Leo X.* (12 vols., Milan, 1816—1817); *Researches concerning Christopher Columbus* (Milan, 1818); and a *History of Italy* (19 vols., Milan, 1819—1823).

BOSSUET, JACQUES BÉNIGNE, a distinguished French pulpit orator, was born, 27th September 1627, at Dijon; received his earlier education in the Jesuit college there; and then came to Paris to the College of Navarre, where he studied the Sacred Scriptures, the works of classical antiquity, and the Cartesian philosophy. In 1652, he was made a doctor of the Sorbonne, and a canon in Metz. Here he was called by the bishop to reply to the Catechism of the Protestant minister, Paul Ferri, and this he did in a way that commanded the admiration even of Protestants. He soon attained great distinction as a pulpit orator, and in 1661 he was made preacher to the court. His discourse on the occasion of Marshal Turenne's conversion to the Catholic

church obtained for him the bishopric of Cordan. The king having, in 1670, intrusted to him the education of the Dauphin, he resigned his bishopric in 1671, because he believed that he would be unfaithful to his duty if he retained it during a continued absence from his diocese. He was now made a member of the Academy. The care with which he attended to the education of the Dauphin was rewarded, in 1680, by his nomination as first almoner of the Dauphin, and in 1681 by his appointment to the bishopric of Meaux. He was the author of the four articles, which secured the freedom of the Gallican Church, and the rights of the king in regard to it, against the aggressions of the pope; and his eloquence in the Assembly of the French clergy, in the year 1682, obtained their adoption of these articles. In 1697, he became a member of the Council of State, and in the following year first almoner to the Duchess of Burgundy. He spent the last year of his life in his diocese, where he died 12th April 1704. He was alike strict in morals and in religious doctrine: his strictness in the latter he shewed particularly in his controversy with Fénelon, whom he reproached as a heretic for his defence of Quietism (q. v.). His style is vigorous and artistic. His orations at the funerals of the Duchess of Orleans and the great Condé are particularly noted as master-pieces of this kind of eloquence. All his writings attracted much attention. For the defence of those dogmas of the Catholic Church which are rejected by Protestants, he wrote his *Exposition de la Doctrine de l'Eglise Catholique sur les Matières de Controverse* (Par. 1671). His greatest controversial work is his celebrated *Histoire des Variations des Eglises Protestantes* (2 vols., Par. 1688), in which he founds his argument chiefly upon the doctrinal diversities of the churches of the Reformation. To the defence of the four articles of the Gallican Church he devoted his *Defensio declarationis celebratæ, quam de Potestate Ecclesie sanxit clerus Gallicus a. 1682* (2 vols., Luxemb. 1730). With a view to the instruction of the Dauphin, he wrote his *Discours sur l'Histoire Universelle jusqu'à l'Empire de Charlemagne* (Par. 1681), a work particularly deserving of notice, as the first attempt at a philosophical treatment of history. The continuation of it to the year 1661 (Par. 1805) is entirely derived from materials which he left behind him, but to which the last touch of his own hand was wanting. Another fruit of his political and historical studies, was the *Politique tirée de l'Ecriture Sainte* (Par. 1709). The most complete edition of his works is that published under the care of the Benedictines (46 vols., Versailles, 1815—1819).—His nephew, **JACQUES BOSSUET**, died bishop of Troyes, 12th July 1743. His very extensive correspondence, chiefly devoted to the elucidation and investigation of the views of Fénelon, is included in the above-mentioned edition of the works of his uncle.

BOSSUT, CHARLES, a French mathematician and natural philosopher, born 11th August 1730, at Tartaras, near Lyon. So early as the year 1752, he became professor of mathematics in Paris, and in 1768 was received into the Academy of Sciences. The revolution deprived him of his situation and his income, and he lived in the greatest seclusion, and in almost misanthropical discontentment, till under the Empire he was appointed a professor in the Polytechnic School. He died 14th January 1814. His works are very numerous. The following may be mentioned as particularly valuable: *Recherches sur la Construction la plus avantageuse des Dignes* (Par. 1764); *Recherches sur les Altérations que la résistance de l'éther peut produire dans le Mouvement des Planètes* (Par. 1776); *Nouvelles*

Expériences sur la Résistance des Fluides, par d'Alembert, Condorcet, et Bossut (Par. 1777); *Traité élémentaire de Mécanique et de Dynamique* (Charleville 1763); *Cours Complètes des Mathématiques* (7 vols., Par. 1795—1801); *Cours de Mathématique à l'Usage des écoles Militaires* (2 vols., Par. 1782); *Essai sur l'Histoire Générale des Mathématiques* (2 vols., 2d ed., Par. 1810), one of the best works on the history of mathematics; and *Traité du Calcul Différentiel et Intégral*. All his works are distinguished by methodical arrangement and great clearness. He was a great admirer of Pascal, and edited his works (16 vols., Par. 1779), to which he prefixed an introductory *Discours sur la Vie et les Ouvrages de Pascal*, in 5 vols.

BOSTAN (Er), a town of Asiatic Turkey, in the pashalik of Marash, situated in a plain on the Sihun, on the north side of Mount Taurus. Lat. 38° N., long. 36° 23' E. B. can be surrounded with water on the approach of an enemy; it has several mosques, and a considerable trade in wheat. It occupies the site of the Cappadocian Comana, which had a celebrated temple dedicated to a deity which is 'supposed to have been called *Ma* in the language of the country, and to be the moon-goddess.' Pop. between 8000 and 9000.

BOSTANJI, a class of men in Turkey who, originally the sultan's gardeners (the name being derived from *bostan*, a garden), now perform, in addition to their garden labour, a variety of duties, such as mounting guard at the seraglio, rowing the sultan's barge, and attending on the officers of the imperial household. They are under a chief called Bostanji Bashi, who holds the rank of a pasha, and is governor of the sultan's residences, and steersman of his barge. He also holds the inspector-generalship of the woods and forests in the vicinity of the capital, has the jurisdiction of the shores of the Bosphorus and Sea of Marmora, and is, altogether, so important a functionary that only personal favourites of the sultan can hope to fill the office. The financial reforms of Sultan Mahmoud, however, have greatly lessened the emoluments of the post. The B. at one time amounted to 5000, and were divided into companies like the janissaries, with whom they were united in military duty. In war-time, their strength was 12,000. A scarlet bonnet, of excessive dimensions, formed the distinctive part of their costume. Their number now does not amount to more than 600.

BO'STON, an ancient English borough and seaport in Lincolnshire, on both sides of the Witham, 28 miles south-east of Lincoln. It is supposed to be identical with the Icanhoe, where St Botolph founded an abbey in 654, destroyed in 870 by the Danes. Under the Normans, B. became a place of importance, and in 1204 it paid the largest dues (£780) of any English port except London (£836). In the reign of Edward III., many foreign traders settled, and the merchants of the Hanseatic League established a guild in Boston. After their departure, the town declined, and the suppression of the monasteries by Henry VIII. further injured it; but his grant of a charter of incorporation, and Mary's subsequent grant of extensive lands, partly compensated for this. The modern town consists chiefly of two good streets, one on each side of the river. The parish church of St Botolph (1309), 245 by 98 feet, is one of the largest without cross aisles in England, and has a fine tower 300 feet high, surmounted by a lantern visible 40 miles out at sea. The clearing of the river of silt and the closing of the adjacent fens have greatly promoted the trade of Boston. Vessels of 300 tons can reach the heart of the town. The chief export is corn. Pop.

of municipal borough, 14,773; of parliamentary, which returns two members to parliament, 17,518. B. is a great market for cattle and sheep, and has manufactures of canvas, iron, brass, ropes, leather, bricks, whiting, and hats. In 1857, 141 vessels of 6573 tons belonged to the port; and in 1858, 972 vessels of 49,455 tons entered and cleared it. Fox, the martyrologist, was born in Boston.

BO'STON, capital of Massachusetts, United States, is situated in lat. 42° 21' N., and long. 71° 4' W. It stands at the west end of Massachusetts Bay, on an inlet, which, whether for defence or trade, forms one of the best havens in the world. This inlet, known as Boston harbour, the primary source of the city's growth and prosperity, has a seaward barrier of two headlands, the interval of 4 miles being so subdivided by an insular breastwork as to leave only three practicable entrances, the main one barely wide enough for two vessels to pass one another; while the enclosed space of about 75 square miles—at least half of it affording depth for the largest ships—greatly augments, with its islands and its peninsulas, both its military and commercial capabilities. On an oblong peninsula, of about 700 acres, running to the north-east, B. was founded in 1630, its original owner, John Blackstone, selling out his right and title, five years thereafter, for £30. With so well chosen a site, and, doubtless, also through the industry and enterprise of its Puritan occupiers, the new town increased so steadily in wealth and population, that in less than a century and a half it became the foremost champion of colonial independence. Since then it has overleaped its natural limits, swarming off, as it were, into an island towards the north-east and into the mainland on the south-east—the three sections of the one municipality, under the respective names of B. proper or Old B., East B., and South B., being connected together by bridges, while the united whole has been joined to the inner shore of the harbour by an immense dam called the Western Avenue. All the divisions of the city are of an uneven surface. Undulation, in fact, is a characteristic of the entire neighbourhood—continent, islands, and peninsulas alike. From this irregularity, so different from the straight and formal lines of street in American cities, and also from being built of a very neat kind of brick, B. has much the appearance of a substantial English provincial town; the resemblance being perhaps heightened by the dress, manners, and feelings of the inhabitants, who are essentially of the old British type, as befits the descendants of the 'Pilgrim Fathers.' On a peninsula, to the north of East B., rises Bunker's Hill, so famous in the War of Independence; while the Dorchester Heights, only less famous, occupy the centre of South B.; and, lastly, the peninsula of Old B. seems to have originally taken the name of Tremont, from its three mounds or hillocks. Between 1840 and 1850 the population had swelled from 93,383 to 136,881—a rate of expansion, which, if maintained during the past decennial period, will now, in 1860, give the amount of 200,000. Among the public buildings, the principal are the State House, City Hall, Faneuil Hall, Faneuil-hall market, Massachusetts hospital, custom-house, county jail, houses of industry and correction, 2 theatres, an atheneum, an odeon, a library, and about 100 churches of the various sects. Among other objects worthy of note are the Common, a beautiful park of 50 acres, on the peninsula; the wharfs and quays; and the bridges, seven in number, which unite together the three portions of Boston. The water-works demand more special mention. To say nothing of an earlier enterprise

of the kind on a smaller scale, Long Pond, distant 20 miles, and capable of yielding 10 millions of gallons a day, has, since 1845, been conveyed by a brick conduit into the grand reservoir of Brookline, at the further end of the Western Avenue, and thence been carried into the subordinate reservoirs respectively of the three sections of the city. B. as the centre—social, political, and commercial—of the best educated and most intelligent state in the Union, is pre-eminent throughout the republic in literature and science. Its trade, likewise, is marvellous: it is, in fact, more marvellous, in proportion to physical facilities, than even that of New York, for while the latter city, with the lakes on the one side and the ocean on the other, and with the Hudson as a link between them, drains regions of vast extent and singular fertility, B., to say nothing of rugged soil and ungenial climate, is cut off from the interior, such as it is, by the entire want of inland waters. But what New York has so largely inherited from nature, B. has in some measure created for itself. By seven great systems of railway it reaches, besides the coasts to the north and south, the St Lawrence and the Lakes, the Hudson and the Mississippi; while, as the transatlantic terminus of the Cunard line, it virtually connects those channels of communication with Great Britain and its net-work of iron roads. In several departments of maritime traffic, such as the coasting intercourse and the trade with Russia, India, and China, B. is understood to possess far more than its share; and as the port of the manufacturing districts of the Union, it may be said to monopolise the carrying alike of raw material and of finished goods. The chief exports are beef, pork, lard, fish, ice, woollens, cottons, paper, boots and shoes, cordage, hardware, and furniture; while the imports, wafted from all corners of the world, comprise nearly every article that has a name in commerce. In cottons alone the foreign exports amounted in 1850, 1851, and 1852 respectively to about 2, 2½, and 3 millions of dollars; while the foreign imports—apparently into Massachusetts as a state, rather than into B. as a city—yielded the corresponding results of about 30, 32, and 34 millions. The aggregate shipping of B. in June 1854 amounted to 495,880 tons. In 1851, the appraised value—not as income, but as capital—of property, *personal* as well as *real*, was about 187 millions of dollars; and on this was collected an assessment of 1,350,000 dollars, averaging 10 dollars a head, and being equivalent, if property be reckoned at 12 annual returns, to an *income-tax* of 8·4 per cent., or upwards of 20d. in the pound. In 1822, B., previously ruled like an ordinary township by select men, adopted a municipal organisation, with a mayor, 8 aldermen, and 48 councillors—the councillors forming one board, and the aldermen and mayor another.

BOSTON, THOMAS, a Scottish divine, once extensively popular, was born of poor parents at Dunse, Berwickshire, March 7, 1676. As early as his 12th year he was concerned about the state of his soul, and while only a boy at the grammar-school, he formed a society of three for religious conference and social prayer. After a hard struggle, he succeeded in entering Edinburgh University in 1691. He received licence as a preacher in 1697, and was greatly appreciated by the serious portion of the community; but his uncompromising character prevented him from receiving a clerical charge for two years. He was then ordained minister of Simprin, and in 1707 was translated to Ettrick, where he died on the 20th May 1732. Of his voluminous works the best known, but not the most agreeable, is the *Fourfold State*, published in 1720. It discourses of

man's paradisaical integrity, his ruin by the fall, his begun regeneration on earth, and consummate bliss or woe hereafter. An excellent little treatise of B.'s is entitled *The Crook in the Lot*. As a pastor, B. was eminently laborious, and deservedly popular. In the ecclesiastical courts he distinguished himself by his zeal in defence of the church's independence, and in the controversy regarding the *Marrow of Modern Divinity* (which was objected to as being too free in its offers of salvation), he was one of the ten ministers who declared their approval of that work. See MARROW CONTROVERSY. As a theologian, B. is perhaps the most 'Representative Man' in the whole list of Scottish divines. His language, sentiments, and peculiar modes of expressing the peculiarities of Calvinistic psychology, have coloured the style of Scottish preaching more than any other writer of the same school has done. Although often displaying what we should now call narrowness and ignorance, B. exhibits also flashes of insight and beauty, quaint felicities of diction—as, for instance, when in *The Crook in the Lot*, he warns the profligate against the possibility of a 'leap out of Delliab's lap into Abraham's bosom'—and an occasional shrewdness of thought, which are even yet worth studying. B.'s autobiography used to be a great favourite with the Scottish peasantry.

BO'SWELL, JAMES, Esq., of Auchinleck, in Ayrshire, celebrated as the friend and biographer of Dr Samuel Johnson, was born October 29, 1740, at Edinburgh, where his father was one of the judges of the Court of Session, and as such was styled Lord Auchinleck. He was intended by his father for the profession of an advocate, and studied first at Glasgow, and afterwards at the then famous university of Utrecht, to which he went in 1763. When in London in that year he made the acquaintance of Johnson, an event of decisive importance for his whole subsequent life. The acquaintance was earnestly sought by himself, and originated in his strong literary tastes and his ardent admiration of Johnson's writings. He spent one winter at Utrecht, and then proceeded on a tour through Germany, Switzerland, and Italy, and visited Corsica with a letter of introduction from Rousseau to Paoli, with whom he contracted a warm and lasting friendship. He enthusiastically adopted the cause of Corsican independence; and after his return to Scotland, published an *Account of Corsica, with Memoirs of General Pasquale Di Paoli* (Glasg., 1768; 3d ed., Lond. 1769), which was speedily translated into several languages. B. became a member of the Faculty of Advocates in 1766, but never devoted himself with earnestness to the business of law. In 1773, he was admitted into the Literary Club instituted by Johnson, and of which Burke, Goldsmith, Reynolds, and Garrick were members. From this time he made it his principal business to note down the sayings and doings of Johnson, with whom he associated on most intimate terms, and whom he accompanied on his tour in Scotland and the Hebrides in 1773. Boswell was married in 1769 to a lady named Montgomery, by whom he had several children. Led by his taste for London society, he removed thither at a mature period of life, and entered at the English bar, but without attaining to any success in the profession. After Johnson's death in 1784, he employed himself in arranging the materials which he had collected, and preparing his long-contemplated biography. His *Journal of a Tour to the Hebrides* appeared in 1785, his *Life of Samuel Johnson*, in 2 vols., in 1791. Both have gone through many editions. Boswell has been emphatically styled by Macaulay 'the first of biographers.' His work is indeed full of details, but

they are such as exhibit character, and are arranged in the most interesting manner. He neither conceals his own faults, nor those of Johnson, but presents a picture of which the truthfulness is too evident to be questioned; and Johnson is perhaps already better known by the pages of *B.* than by any of his own writings. *B.* died in London, June 19, 1795. Besides the works already mentioned, he was the author of one or two minor productions of temporary interest. In December 1856, there was published a posthumous volume of *Letters of James Boswell, addressed to the Rev. W. J. Temple, from the Original MSS.*, in which the gay, insouciant character of the man very strongly appears. His eldest son, SIR ALEXANDER BOSWELL, Baronet, of Auchinleck, born 1775, was the author of a number of Scottish songs, full of humour, which he collected into a volume, entitled, *Songs, chiefly in the Scottish Dialect* (Edin. 1803), and some of which attained considerable popularity. He also wrote *Edinburgh, or the Ancient Royalty*, a picture of Scottish manners in the dialogue form, and edited many of the older productions of Scottish literature. A duel with Mr Stuart of Dunearn, occasioned by personal allusions in a publication connected with a parliamentary election, resulted in his death on March 26, 1822.

BOSWELLIA, a genus of trees of the natural order *Amyridaceæ* (q. v.), having flowers with a small five-toothed calyx, five petals, and a crenulated glandular disk; a triangular capsule with three valves, three cells, and one seed in each cell; the seeds winged on one side; their cotyledons intricately folded, and cut into many segments. Two or three species only are known, of which the most interesting is *B. serrata* (or *B. thurifera*), the tree which

supposed to be also a native of other parts of India, and of Persia, Arabia, and perhaps Abyssinia. *B. glabra*, a very similar species, a native of India, also yields a resin, comparatively coarse, which is sometimes used for incense, and is boiled with oil as a substitute for pitch.

BOSWORTH, or **MARKET BOSWORTH**, a market-town in Leicestershire, on an eminence in a very fertile district, 12 miles west of Leicester. Pop. of town, 1058; of parish, 2449, many being employed in knitting worsted stockings. On a moor in the vicinity was fought, 1485, the battle in which Richard III. was slain, and which terminated the Wars of the Roses. On an elevation, called Crownhill, Lord Stanley placed the crown on the head of the Earl of Richmond, Henry VII. Here Simpson the mathematician was born; Dr Johnson was an usher in the Free Grammar School, in which Salt the Abyssinian traveller, and Richard Dawes the Greek critic, were educated.

BOSWORTH, JOSEPH, D.D., a distinguished philologist, is a native of Derbyshire, where he was born in 1788. He graduated first at Aberdeen, and afterwards at Leyden; he also took the degrees of B.D. and D.D. at Cambridge and Oxford. He obtained a curacy in the English Church in 1815, and two years afterwards the vicarage of Horwood Parva, Buckinghamshire. He now devoted such time as an active discharge of his parochial duties left at his disposal to literature, and especially to researches in Anglo-Saxon and its cognate dialects. The result of his labours appeared in 1823 in a work, entitled *Elements of Anglo-Saxon Grammar*. Fifteen years afterwards, he published the work by which his name is best known, *A Dictionary of the Anglo-Saxon Language* (Lond. 1838), which is considered alike remarkable for its ripe scholarship, enlarged views, copiousness, and accuracy; containing, as the *Edinburgh Review* remarked, 'within a moderate compass, a complete apparatus for the study of Anglo-Saxon. An abridged edition has since been issued by the author, who has also published some other works of a philological character. *B.* resided in Holland eleven years, from 1829 to 1840, first as British chaplain at Amsterdam, and subsequently at Rotterdam. He returned to England in 1840, and was presented to the vicarage of Waithe, in Lincolnshire. He has now (1860) long been engaged in preparing for publication the Anglo-Saxon and Mæso-Gothic Gospels in parallel columns.

BÖSZÖRMENY, the name of two towns in Hungary, one in the county of Bihar, about 12 miles west-north-west of Grosswarden, with a population of about 15,000; the other a free town of the county of Szabolcz, 12 miles north-north-west of Debreczin, with a population of 14,660.

BOT, **BOT-FLY**, and **GAD-FLY**, names common to many insects of the family *Estridæ* (q. v.) or *Estracidæ*, the genus *Estrus* of Linnæus. The name bot is sometimes restricted to the larvæ, which appears to have been its original use; the other names being given to the perfect insects; the name gad-fly often to insects of the genus *Tabanus* (q. v.), to which some try to restrict it. The insects of this family are now supposed not to be those which were called *Estrus* by the ancients, although, like them, extremely troublesome to cattle. They are Dipterous (two-winged) (q. v.) insects, nearly allied to the *Muscides* (House-fly, Flesh-fly, Blow-fly, &c.), with small 3-jointed antennæ, and mouth destitute of a proboscis.—The Horse-bot, or Gad-fly of the Horse (*Gasterophilus*, or *Gastrus*, or *Estrus Equi*), sometimes also called the *Breeze* and

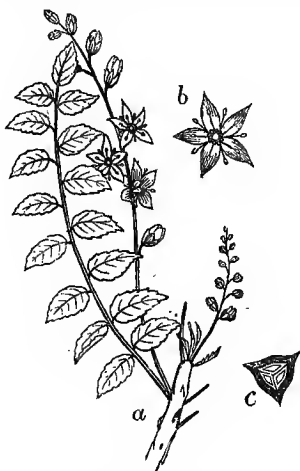

Boswellia serrata :

a, part of a branchlet, with leaf and raceme of flowers; *b*, a single flower; *c*, a capsule, cross section.

yields **OLIBANUM** (q. v.), now very generally believed to have been the **FRANKINCENSE** (q. v.) of the ancients. It is a large timber-tree, with pinnate leaves, which have about ten pair of hairy serrated oblong leaflets, and an odd one, each leaflet about 1—1½ inch in length. The flowers are small and numerous, in axillary racemes, and of a pale pink colour. When the bark is wounded, the olibanum flows out, of a delightful fragrance, and hardens by exposure to the atmosphere. The tree is found in the mountainous parts of Coromandel, and is

Horse-bee, is much less common in Britain than in some parts of the continent of Europe, and occurs chiefly in elevated healthy districts. It is not quite half an inch in length, woolly, with yellowish gray head, rusty thorax, abdomen, and the wings whitish, with brownish-gray spots. The abdomen of the female terminates in a blackish horny tube. In the latter part of summer, the female hovers about horses, and deposits her eggs on their hairs, where they remain attached by a glutinous substance until they, or the larvæ just emerging from them, are licked off by the tongue of the horse, their destined place being its stomach. It is believed that the fly deposits her eggs only on those parts which are accessible to the horse's tongue, seeming to prefer the back of the knee-joint, where they may sometimes be found in hundreds. The larva is yellowish, without feet, short, thick, soft, composed of rings which have a double row of short teeth surrounding them; it is somewhat acuminated at one end—the head; and the mouth is furnished with two hooks, one on each side, for taking hold of the inner coat of the horse's stomach, to which the B. attaches itself, and from

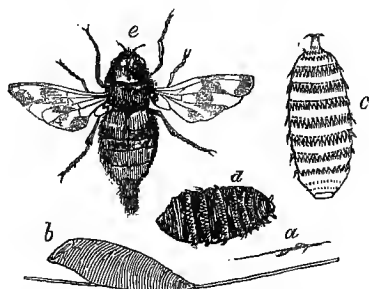

Horse Bot-fly :

a, a horse-hair with eggs of hot-fly; b, one egg magnified; c, larva; d, pupa; e, perfect insect, a little larger than life.

which it derives its subsistence, hanging in clusters sometimes of three or four, sometimes of more than one hundred. Here it spends the winter, and in the following summer, when it is about an inch long, it disengages itself, and being carried through the horse's intestines, burrows in the ground; and changes into an oval black pupa with spiny rings, from which, in a few weeks, the perfect insect comes forth. Multitudes, of course, become the prey of birds, before they can accomplish their burrowing.—It has been disputed whether or not bots are very injurious to horses; and some have even maintained that, when not excessively numerous, their presence is rather beneficial, an opinion which is certainly not recommended by its apparent probability, whilst it seems to be universally admitted, that in great numbers they are hurtful.—The Red-tailed Horse-bot (*G.* or *B. hæmorrhoidalis*), also a British species, deposits its eggs upon the lips of the horse, distressing it very much by the annoyance which it gives in so doing. The larvæ attach themselves chiefly to the surface of the intestine, about the anus of the horse, and sometimes cause an annoying irritation. Linseed-oil is used for their removal.—The Ox-bot, or Ox Gad-fly (*Estrus* or *Hypoderma Bovis*) is more troublesome than any species of horse-bot. It is a beautiful insect, not quite half an inch long, and thicker in proportion than the horse-bots; it has brown unspotted wings; the face whitish, the crown of the head brown, the thorax black, the abdomen whitish, with a broad black band around the middle, and yellow hairs at the extremity, where also the

female has an ovipositor—a remarkable organ, formed of a horny substance, and consisting of four tubes

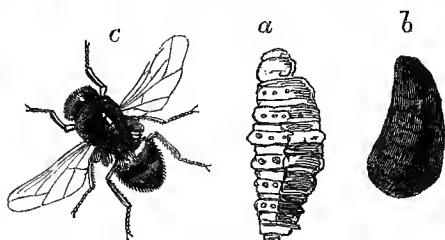

Ox Bot-fly :

a, larva, full grown, natural size; b, pupa; c, perfect insect, a little larger than life.

retractile within one another, like the pieces of a telescope; and the last of them terminating in five points, three of which are longer than the others, and hooked. By means of this organ, a small round hole is pierced in the hide of an ox's back, in which an egg is deposited. The fly is very quick in depositing her egg, not remaining upon the back of the animal more than a few seconds. Cattle exhibit great alarm and excitement at the presence of the gad-fly, and rush wildly about, with head stretched forward, and tail stuck out, to escape from their tormentor. The further injury done by this insect is not, however, usually great; the larva—a little pearl-white maggot (*warble* or *wormal*)—feeding upon the juices beneath the skin, causes a swelling, called a *warble*, forming a sort of sac, within which it lives and grows, amidst a kind of purulent matter suited to its appetite; and from which it finally emerges, leaving a small sore, and like the horse-bot, undergoes its further transformations in the ground. By pressure on the warbles, bots may be destroyed, and when they are numerous, assiduous oiling of the back of the ox is resorted to for the same purpose.—The SHEEP-BOT (*Cephalomyia* or *Estrus Ovis*) is a much more serious pest than any other British species, and is not unfrequently very destructive to flocks. The insect is smaller than either the ox-bot or horse-bot; it is of grayish colour, with a large head and yellow face, and is most abundant in damp situations and



Ovipositor of Bot-fly, highly magnified.

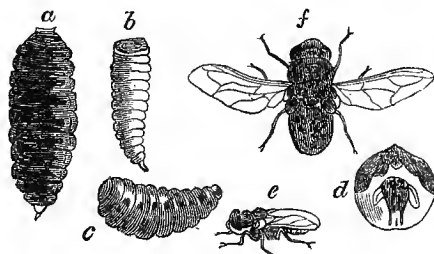

Sheep Bot-fly :

a, larva, full grown; b, larva, younger; c, pupa; d, the face of the perfect insect, magnified; e, perfect insect, natural size; f, perfect insect, magnified.

woody districts. It is to be seen chiefly in the months of June and July. Sheep exhibit great alarm when it approaches them, and seem to seek, by keeping their noses close to the ground, and by incessant motion of their feet, to keep it from

entering their nostrils. It is in the nostrils of the sheep that this fly deposits its eggs, and the larvæ, when hatched, make their way into the maxillary and frontal sinuses, feeding upon the juices there, until they are ready to change into the pupa state, in April or May of the following year, when they find their way again through the nostrils to the ground. They seem to cause great irritation in their progress up the nostrils of the sheep, and the poor animals run hither and thither, snorting and in great excitement. 'The common saying, that a whimsical person is *maggoty*, or has got *maggots in his head*, perhaps arose from the freaks the sheep have been observed to exhibit when infested by their bots.' The bots cause considerable irritation in the cavities, where they usually fix themselves, and sometimes get into the brain, and cause death.—These larvæ move with considerable quickness, holding on by the hooks with which their mouth is furnished, and contracting and elongating the body. It is said that flocks fed where broom is in flower are never infested with them; and when many cases arise in a flock, it is found particularly advantageous to remove it to a dry soil.—Goats, deer, and other quadrupeds are also liable to be assailed by different kinds of gad-fly. The eggs of one of the species which attacks the fallow-deer, are deposited in the nostrils, and the larvæ make their way in large numbers to a cavity near the pharynx. Rein-deer are excessively tormented by these insects, one kind depositing its eggs in their nostrils, and another in their skin; and it is no infrequent thing for a large part of a flock to be destroyed by them. When feeding where bot-flies are numerous, they keep such watch against them, that they neglect to eat, become emaciated, and often actually perish in consequence.—Even human beings have sometimes been afflicted by insects of this family. Humboldt saw Indians in South America having the abdomen covered with tumours produced by their larvæ.

BOTANIC GARDEN, a garden devoted to the promotion of botany, and in which plants are collected and cultivated in order to scientific study. The various economical applications of botany, however, in agriculture, manufactures, medicine, &c., are almost always kept particularly in view; and one great object of a B. G. is to bring to a country useful foreign plants, to determine the question of their suitableness to its climate, and to introduce those which may be cultivated with advantage. B. gardens are now deemed indispensable to universities; they are reckoned among the public institutions of great cities, and even of nations, and are established in new colonies, not only for the sake of science, but as one of the means of promoting their prosperity. They were utterly unknown to the ancients, although some of the secondary objects in which they are found most useful engaged the attention both of Greeks and Romans. The first approach to a B. G. appears to have been made about 1309 A. D., in the garden of Matthæus Sylvaticus, at Salerno; botanical science, however, being merely subservient to medicine. Of a similar character was the medical garden established at Venice, by the republic, in 1333. The example of Venice was followed by other Italian cities, and plants from different parts of the world began to be collected. At length, about contemporaneously with the revival of botanical science in modern times, the first true B. G. was formed in 1533 at Padua, by Musa Brassavola, for Gaspar de Gabrieli, a wealthy Tuscan noble; which was soon followed by those of Pisa, Florence, Bologna, and Rome. The first public B. G. was that of Pisa. A public B. G. was established at Padua in 1545, by a decree

of the republic of Venice, at the request of the professors and students of medicine. The republic of Venice greatly encouraged the study of botany by sending persons to the Levant, to Egypt, and even to India, to procure plants for this garden.—The B. G. of Leyden was begun in 1577; it enjoyed in its infancy the care of Clusius, and was brought to great perfection by Boerhaave, who was professor of botany there.—The first public B. G. in Germany was established by the Elector of Saxony at Leipsic in 1580, and was soon followed by others.—France had no B. G. till Louis XIII. established the *Jardin des Plantes* at Paris, which was begun in 1610, but not completed till 1634.—Nor was there any public B. G. in England till 1632, when that of Oxford was founded by the Earl of Danby. Private B. gardens, however, had existed in England for the greater part of a century before.—The B. G. of Edinburgh, the first in Scotland, was founded about the year 1680, as a private B. G., by Dr. afterwards Sir Andrew Balfour, a zealous naturalist, who had inherited a collection of plants formed by a pupil of his own, Patrick Murray of Livingston, at his country seat, and transferred them to Edinburgh; and the city of Edinburgh afterwards allotted to it a piece of ground, and allowed an annual sum for its support out of the revenues of the university.

The B. G. at Kew occupies a high place among British national institutions: it possesses one of the richest collections of plants in the world, and has been greatly improved under the care of Sir William Jackson Hooker, who has been director of it since 1841. The *Hortus Kewensis* of Mr Aiton, to whom the garden owed much of its prosperity in the 18th c., illustrates the greatness which it had even then attained. One of its chief glories is now its immense palm-house, finished in 1848, which is 362 feet in length, and the central part of it 100 feet wide, and 66 feet high.—A new palm-house has, in like manner, greatly added to the attractions and value of the B. G. of Edinburgh. It is 100 feet long by 60 feet wide, and 70½ feet high. These houses permit something of the stateliness and magnificence of the palms of the tropics to be seen in Britain.

Of B. gardens on the continent of Europe, the *Jardin des Plantes* may be regarded as holding the first place, both with reference to the strictly scientific study of botany, and to the care bestowed upon the introduction and diffusion of useful or beautiful plants from all parts of the world. There exists in France what may be called a system of B. gardens—one at least in every department—to which plants are sent from the *Jardin des Plantes*, and from which, as they continue to be multiplied by propagation, they soon find their way into the hands of nurserymen and private cultivators. The B. G. connected with the imperial palace at Schönbrunn, in Austria, and that of Berlin, are the greatest in Germany. The former, which was begun in 1753 by the Emperor Francis I., was supplied with West Indian plants at enormous expense, the celebrated Jacquin being sent to procure them. The B. G. of New York is perhaps the most worthy of notice among the numerous botanic gardens of America; and that of Calcutta deserves to be mentioned, as an important connecting-link between the B. gardens of Europe and the botany of India. It has enjoyed the care of a succession of eminent botanists, and has been very useful both in transmitting Indian plants to other parts of the world, and in introducing valuable productions of other countries into India.

In the laying out and arranging of B. gardens, different methods are adopted, mere convenience and beauty being in some cases primarily regarded, and these in other cases being sacrificed to the

supposed interests of science in an attempted scientific arrangement. A perfect adherence to a botanical system is, for obvious reasons, impossible; but a scientific arrangement of the plants in natural groups, in so far as it can be conveniently accomplished, greatly increases the usefulness of a B. G., and facilitates the study of botany. Sometimes houses are devoted to particular orders of plants, as palms, heaths, or orchids; sometimes to plants of particular habit, as aquatic plants; and sometimes portions of the garden are advantageously devoted to the exhibition, at one view, of plants valuable for particular uses, as cereals or corn-plants, plants yielding fibre, &c.

BOTANOMANCY, divination by means of plants. See **DIVINATION**.

BOTANY (Gr. *botane*, an herb), the science which has for its subject the Vegetable Kingdom (q. v.). Everything that relates to plants is included in this science; there are, therefore, several great branches of it, in many respects very different from each other. Of these branches of the science, some, relating to plants in general, rather than to particular kinds or species, are sometimes included under the designation of *General B.* (sometimes called *Phytotomy*; Gr. *phyton*, a plant, and *nomos*, a law); whilst those which relate to particular species, their distinctive characters, distribution, &c., are, in like manner, comprehended under the term *Special Botany*.—In the former of these departments, the first place must be assigned to *Structural B.*, also called *Organology*, or *Organography*, which has for its subject the structure of plants, the textures of which they are composed, and their various organs. Subordinate to this are the study of the elementary tissues of plants, sometimes called *Vegetable Histology* (see **HISTOLOGY**), and that of the anatomy of plants, sometimes called *Phytotomy* (Gr. *phyton*, a plant, and *tomē*, a cutting); both of which have recently been prosecuted with great assiduity. In both, the microscope is an indispensable instrument, and by means of it all the important discoveries of modern times have been made. Intimately connected with these is *Morphology* (Gr. *morphos*, a form, and *logos*, a discourse), that branch of botanical science which relates to what has been called the *Metamorphosis of Organs*, or, in other words, the gradual transmutation of leaves by the processes of vegetable life into the various organs with which a plant is provided, and their consequent assumption of new forms and adaptation to new uses. This branch of B., entirely of recent origin, has been described as being in the vegetable what comparative anatomy is in the animal kingdom, and has now become the exposition of an admitted great general law, almost equally important in reference to structural B. and to vegetable physiology. *Vegetable Physiology* or *Physiological B.* treats of the various kinds of organic activity which are displayed in the life of plants. It is based upon *Structural B.*, an intimate acquaintance with which is indispensable to the study of it. The arguments or illustrations of natural theology, derived from B., are chiefly taken from structural B. and vegetable physiology considered together, the wisdom of the Creator appearing in his works equally in their structure and in the adaptation of all their organs to their respective wonderful functions. In connection with vegetable physiology, another branch of science claims attention—**VEGETABLE CHEMISTRY**; of which there are two parts—an examination of the products of the living processes in plants, which, with all its well-known difficulty, is still comparatively easy; and an inquiry into these processes themselves, with respect to the chemical

changes effected in them—an investigation of the secrets of that chemistry of nature which so far excels all that has yet been accomplished in laboratories. This is, however, a branch of the science of chemistry rather than of B.; but it so far belongs to the latter, that although only subsidiary, it is useful and indispensable. Even mathematics and natural philosophy, however, have been called to the assistance of the philosophical botanist in his attempts to explain the phenomena of his own science.

Special B. has been rendered subservient to the study of general B., and errors in the former are also guarded against by dependence, to a certain extent, on the well-ascertained principles of the latter. A comprehensive view of the vegetable kingdom is indeed impossible without an inquiry into the number and peculiarities of the different species which it contains; but the attempt to classify and arrange these can only be successful when it is founded upon a knowledge of general laws relating to all vegetable organisms. That the discoveries of a botanist may be made known, the description of species is necessary; and works devoted to this are sometimes called works of *Descriptive B.* or of *Phytography* (*phyton*, a plant, and *graphē*, a writing). But in the description of plants, a multitude of terms must be employed, which almost exclusively belong to botanical science itself, whilst even those which are common to it with other departments of natural history, must be employed in senses modified by the peculiarities of the vegetable kingdom. Many of the terms used are such as belong to structural B. and vegetable physiology; but many also—for example, adjectives which designate the particular forms of leaves, &c.—become familiar only when an acquaintance with them is sought in order to descriptive B., and a knowledge of the different species of plants. Great precision is necessary in the use of these terms, and from the want of it, the descriptions of the ancients and of travellers unacquainted with B. often leave it impossible to determine the particular species intended. This gives rise to what is sometimes called in botanical works *Terminology*—an explanation of botanical terms, which, however, has no right to be regarded as a separate branch of science, or worthy of a distinct name; and the name which it has received is barbarous. When structural B. was little heeded, and little more was commonly supposed necessary for a botanist than a knowledge of species and the ability to distinguish them, 'terminology' was often separately taught, and the student was required to commit long tables of terms and their meanings to memory—a difficulty placed in his way at the outset which was both formidable and repulsive, like that which the student of the Chinese language must expect to encounter in its alphabet.

The necessity of classification and systematic arrangement in B. will be very obvious, if the multitude of different kinds of plants is considered, fully 120,000 species being already known and described, whilst great regions of the earth are still unexplored. The systematic arrangement of plants is sometimes called *Systematic B.*, sometimes *Taxological B.* (Gr. *taxis*, order, and *logos*, a discourse), sometimes, less properly, *Taxology* or *Taxonomy*. The history and progress of the science have been marked by the different systems which have been proposed, and have prevailed at different times. These have, however, been of two very distinct kinds, founded upon very different principles, and particularly adapted to very different objects, and are respectively designated *artificial* and *natural* or *physiological* systems. Artificial

systems are based upon some single class of characters, in the external parts of plants, without reference to the importance of these characters in what concerns the life of a plant, or the purpose for which it exists, and are chiefly adapted to the convenience of the student desirous of readily distinguishing species among the multitudes with which he has to deal. A work of descriptive B., arranged according to an artificial system, has been aptly likened to a dictionary in which the words are alphabetically arranged.

An artificial system cannot, however, serve the highest purposes of the science. But in framing a natural system, great difficulties are to be encountered, and imperfection of the system is necessarily to a certain extent involved in imperfection of the science. Based not upon one mere set of characters arbitrarily selected, but upon a consideration as far as possible of all characters which plants present, and not merely upon external forms viewed in themselves, but upon these and internal organisation considered in their physiological relations, a natural system aims at exhibiting the real affinities which subsist in the vegetable kingdom; and evidently must be at all times liable to modification, and capable of improvement, as botanical science advances, either through the discovery of new plants or through phytotomical and physiological research: it also evidently requires the greatest scientific attainments and the highest powers of a philosophic mind. Nor is it one of the least of the practical difficulties, that the affinities of plants are not such as to constitute a simple lineal series, but that they may be viewed as a multitude of groups arranged around centres, and connected with each other upon different sides and by a great variety of ties.

Yet the rudiments of a natural system have always been sought after, and in some measure attained, when B. has been studied as a science—whenever it has become anything more than a mere acquaintance with a few plants and their names. The *genera* into which species are grouped by all botanists are natural, and are the basis upon which all classification proceeds in its further generalisations. So sensible was Linnaeus of the importance of maintaining this character of the genera, that when a rigid adherence to his artificial system would have caused the division of a genus into parts, and the consequent separation of species very nearly allied, he kept the genus unbroken, and maintained the usefulness of his artificial system, to the student desirous of finding the names of plants, by referring from one of its classes or orders to another for species exceptional among those of their genus as to the number of their stamens or pistils, or their *dicocious*, *monocious*, or *hermaphrodite* flowers.—The classification of species, however, in genera and larger natural groups, being a subject as much connected with other branches of natural history as with B., will more properly be treated in the article NATURAL HISTORY; and to that article also, and to the article SPECIES, we refer for all that our limits allow concerning some of the most interesting and difficult questions of science, the limits of species, the distribution of species, &c.

An important branch of botanical science is that which is called *Geographical B.*, or the *Geography of Plants*, and sometimes *Phytogeography*. It must be regarded as yet in its infancy, although a multitude of observations have been recorded in works of descriptive B., and by botanical travellers. It is the object of *Geographical B.* to connect with the occurrence or prevalence of plants in particular countries a great variety of facts as to climate, altitude, geology, &c., and even facts of history. It aims at the establishment of great general laws, which, however,

it has not yet been able to establish. Some account of the progress which has been made in this branch of B., and of the imperfect generalisations which have been reached, will be found in the article GEOGRAPHY OF PLANTS.

Another branch of botanical science which has recently sprung up, and has acquired great magnitude and importance, is PALAEOBOTANICAL B., or FOSSIL BOTANY. The petrified fruits and wood, the beautiful impressions of ferns and palms, and other traces and remains of former vegetation, which appear in vast numbers and great variety in different strata of the earth's crust, present a most interesting field of scientific research. The study of the different kinds of fossil plants, and the comparison of them with existing species, belong strictly to the science of B.; the study of their relations to particular strata or formations, and so to particular periods in the physical history of the globe, belongs to geology. The study of fossil plants has proved exceedingly useful in guiding to just and philosophic views of the mutual relations even of species and groups still existing. See PALAEOBOTANY.

The subject of the DISEASES OF PLANTS must be regarded as falling within the province of Botany. It has scarcely yet been treated or studied as a distinct branch of science, although it has not been overlooked in its relation to Vegetable Physiology, with which its intimate connection is obvious, and it has received no little attention in its bearings on agriculture and other arts by which plants are made to supply the wants or minister to the comforts of man.

ECONOMIC B. includes all that relates to plants, considered with reference to these arts and to these uses. That part of it which relates to medicinal plants has been often separately and elaborately treated under the name of MEDICAL BOTANY. In the botanical articles of this work, will be found notices of the more important plants affording food to man, and therefore cultivated in fields or gardens, in warm or in cold climates, and of those valuable for their timber, their fibre, or the dye-stuffs or medicines which they yield.

Having thus endeavoured to sketch an outline of the science of B., we must refer to the articles PLANT, VEGETABLE KINGDOM, and VEGETABLE PHYSIOLOGY, instead of attempting here to fill up a part of that outline by exhibiting the first principles of the science. It remains for us, in the present article, to give a very brief account of the history of B., and outlines of the systems of classification most deserving of attention.

We are informed that Solomon 'spoke of trees, from the cedar in Lebanon even to the hyssop that springeth out of the wall.' There is reason also to believe that Zoroaster devoted some attention to plants, and that this study early engaged some of the philosophers of Greece. The oldest botanical work which has come down to us is that of Theophrastus (q. v.), a pupil of Aristotle, who flourished in the 4th c. B. C. His descriptions of plants are very unsatisfactory, but his knowledge of their organs and of vegetable physiology may well be deemed wonderful, when we consider the low state of this branch of science throughout many centuries after his time. It was not, indeed, till after the revival of letters in Western Europe, that it was ever again studied as it had been by him. About four hundred years after Theophrastus, in the first c. of the Christian era, Dioscorides of Anazarbus, in Asia Minor—a herbalist, however, rather than a botanist—described more than 600 plants in a work which continued in great repute throughout the middle ages, a sure proof how destitute that period must have been of any botanical science of its own. About the same time, the elder Pliny devoted a

share of his attention to B., and his writings contain some account of more than 1000 species, but compiled from various sources, without much discrimination, and mingled with many errors. Centuries elapsed without producing another name worthy to be mentioned in a history of botany. It was among the Arabians that the science next began to be cultivated, about the close of the 8th century. The greatest name of this period is Avicenna. Centuries again elapsed, a longer interval than before, during which it made no progress whatever. It was not till the beginning of the 16th c. that B. resumed its place as a science. The first to revive it was Otto Brunfels, a German, who published in 1530 his *Historia Plantarum Argentorati*, or History of the Plants of Strasburg, in 2 vols., folio, illustrated with cuts. He was speedily followed by Book or Tragus, Fuchs or Fuchsius, and other Germans; by Matthioli and Casalpini in Italy; Dodonæus or Dodonæus in the Low Countries; De L'Obel or Lobelius, a Dutch physician at the court of England; Gesner in Switzerland; Dalechampa and Moulins, or Molinæus, in France, and by many others, for B. now began to be prosecuted wherever learning flourished, and with great zeal and success. Chairs of B. were founded in universities, botanic gardens (q. v.) were established in many places, and travellers began to explore even remote parts of the world. One of the greatest names of the latter part of the 16th c. is that of L'Ecluse, or Clusius, who travelled through many countries, encountering great perils and hardships in pursuit of his favourite science, and was finally professor of B. at Leyden. The name of Dr Turner, 'the Father of English B.,' belongs more to the 17th c. than to the 16th. The number of species known and described had increased, in the beginning of the 17th c., to more than 5000, but the study of them was much impeded by confusion of synonyms and by want of classification, whilst classification was rendered extremely difficult by imperfect knowledge of the structure and organs of plants. The foundations of a natural system of classification may be said to have been laid, in the latter half of the 17th c., by Dr Robert Morison, a native of Aberdeen and professor of B. at Oxford, followed towards the close of the century by the celebrated Ray, one of the greatest naturalists that England has produced.

The application of the microscope in B. inaugurated a new epoch of the science, about the middle of the 17th century. Henshaw and Hook, both Englishmen, were among the first to employ this instrument to good purpose in the examination of the organs and structure of plants; but the greatest eminence belongs to the name of Grew, also an Englishman, a physician at Coventry, and to that of Malpighi, an Italian, perhaps still more celebrated for his anatomical than for his botanical discoveries. Vegetable physiology now began to be recognised as the highest department of botanical science.

In the latter half of the century, perhaps the most eminent name after Ray is that of Joseph Pitton de Tournefort, a French gentleman, who devoted his whole life to the pursuit of botanical science, and who must be particularly noticed in a sketch of the history of B., on account of a system which he proposed, and which was more generally received and employed than any other till the time of Linnæus. Another botanist of the same period, Rivinus, professor at Leipsic, gave to the world a botanical system which was received to some extent in Germany. Tournefort's system was partly natural and partly artificial; that of Rivinus was perhaps the most perfectly artificial that was ever proposed.

The science of B. made rapid progress during the 17th and 18th centuries, both by the extension of

botanical research in different parts of the world, and the careful study of particular groups or families of plants. Its progress was promoted by the publication of many valuable descriptive works. Important discoveries were also made in vegetable physiology.

About the middle of the 18th c., the wonderful genius of Linnæus effected a great change in B., as well as in zoology. His name marks an epoch in the history of the science; not chiefly, however, in consequence of the new system which he introduced, nor even because of the discoveries which he made, but rather because he was able very thoroughly to make himself master of all that had been ascertained by his predecessors, and to exhibit it in lucid order. He gave also a great impulse to botanical studies, by the enthusiasm with which he inspired his pupils. And among the benefits which he conferred on B., in common with zoology, not the least considerable was the introduction of trivial or specific names to be used along with the name of the genus as the designations of particular species.

From the time of Linnæus, the progress of B. during the remainder of the 18th c. became more rapid; and since the commencement of the 19th c., it has advanced with gigantic strides. A large space would be occupied by a mere enumeration of the names of those who have promoted it by their labours and discoveries. Some notion of what botanical literature has become, may be formed from the fact, that Pritzel, in his *Thesaurus Litteraturæ Botanice* (Leip. 1847—1851), enumerates about 15,000 publications.

Von Haller, an anatomist and philosopher, as well as a botanist, was, of all the contemporaries of Linnæus, the only one who could be regarded as his rival. Of all the botanists of the latter half of the 18th c., the most deserving to be mentioned in the history of the science along with the great Swede, are Bernard de Jussieu, and his nephew, Antoine Laurent de Jussieu, who applied themselves with great earnestness to the study of the natural affinities of plants and the formation of a natural system, a work which Linnæus himself attempted, and of the importance of which he was so sensible, that whilst acknowledging the imperfect success of his endeavours, he declared his resolution to persevere in them to the end of his life. The Jussieus traced the outlines of a system which the greatest botanists since their time have not so much sought to change as to complete. Among those who have laboured with greatest success in this work, must be mentioned De Candolle, Fries, Endlicher, Brongniart, Meisner, Von Martius, Lindley, and Brown. The botanist last named acquired by his work on the plants of New Holland, published in 1810, a high eminence, not on account of new plants which he described, but on account of the light which he threw upon the most difficult questions connected with the structure of plants and vegetable physiology. Many remarkable discoveries in vegetable physiology have recently been made by Link, Meyen, Schleiden, Von Mohl, Lindley, and others, some of them affecting what may be called the most fundamental principles of botanical science.

Since the days of Linnæus, great progress has been made in the examination of the B. of particular countries and districts, of which perhaps the least important result has been the discovery of very many plants unknown before. But our limits prevent us from noticing particular works in this department of botanical science, or those of botanical travellers, or of botanists who have devoted themselves to the study of particular groups of plants. And we can merely allude to the scientific associations, continually increasing in number and resources,

by which the interests of this science are promoted, and to the magazines and other periodical publications devoted to it.—However, we cannot but refer also to what may be deemed by some—but unjustly—matters of comparative insignificance, the introduction of B. into schools, and the publication of many works intended for the use of persons not very scientific. By the introduction of this or any similar branch of science into schools, not only may important educational purposes be served, but the young may be led to form a taste for the science which will impel them to its subsequent prosecution. There are few branches of science so easily made popular as B.; but they very much mistake its nature who suppose it to consist in a mere knowledge of the names of plants, or in a familiarity with the classes of an artificial system. What B. really is, and to what the true study of it tends, is better perceived if we consider that ‘there is not a flower that blows but has some beauty only unveiled to the minute inquirer, some peculiarity in its structure fitting it to its destined place and purpose, and yet not patent to a casual glance.’ There is perhaps no branch of science which demands more than B. the application of the highest mental powers; and like every other, to him who truly prosecutes it—whether little or much—it brings in due measure an immediate reward in his own improvement and delight.

We proceed to exhibit an outline of the Linnæan system, the only artificial system which it appears necessary further to notice, and of the natural system by which it has been to a great extent superseded. The Linnæan system, however, is not entirely artificial. Its foundation may be said to be laid in the perfectly natural distinction between Phanerogamous and Cryptogamous plants—the former of which Linnæus divided into 23 classes; whilst he constituted the latter, corresponding to the Acotyledonous plants of Jussieu, into his 24th and last class, *Cryptogamia*. In the other classes, he took the characters from the parts of fructification; this he defined as having no stamens or pistils distinctly visible, and gave it a name, *Cryptogamia* (Gr. *kryptos*, concealed, and *gamos*, marriage), in accordance with this definition, modestly refraining from a confident assertion of the absence of stamens and pistils. Of the 23 classes of phanerogamous or phanogamous plants (Gr. *phaneros*, manifest, and *phaino*, to shew), the characters of all are taken from the stamens; and those of Classes I.—XI., simply from the number of them; these classes, however, not including plants exhibiting the peculiarities with references to which the remaining classes are constituted. Thus Class I., *Monandria* (Gr. *monos*, one, *aner*, a male), consists of plants the flowers of which have only one stamen; Class II., *Diandria* (Gr. *dis*, twice), of those with two stamens; Class III., *Triandria* (Gr. *treis*, three), of those with three stamens, and so on; Class IV., *Tetrandria* (Gr. *tetras*, four times); Class V., *Pentandria* (Gr. *pente*, five); Class VI., *Hexandria* (Gr. *hex*, six); Class VII., *Heptandria* (Gr. *hepta*, seven); Class VIII., *Octandria* (Gr. *octo*, eight); Class IX., *Enneandria* (Gr. *ennea*, nine); Class X., *Decandria* (Gr. *deka*, ten)—until, in Class XI., *Dodecandria* (Gr. *dodeka*, twelve), the number of the stamens is less definitely fixed, and plants are included in it having more than ten, and fewer than twenty stamens. Then follow two classes—Class XII., *Icosandria* (Gr. *eikosi*, twenty), and Class XIII., *Polyandria* (Gr. *polys*, many)—which have numerous stamens, but differ in their being inserted on the calyx in the former class, and on the receptacle in the latter, characters essentially natural, as are those also of most of the remaining classes. Classes XIV., *Didynamia*, and XV., *Tetra-*

dynamia (Gr. *dynamis*, power), are distinguished by having the stamens of different lengths—the former having two long and two short stamens, the latter, four long and two short. Class XV. agrees with the great natural order *Cruciferae*. Class XVI., *Monadelphica* (Gr. *adelphos*, a brother), has the stamens united by the filaments in one bundle; Class XVII., *Diadelphia*, has the filaments united in two bundles, or one free and the rest united; Class XVIII., *Polyadelphia*, has them united in more than two bundles. In Class XIX., *Syngenesia* (Gr. *syn*, together, and *genesis*, generation), the stamens are also united, but by the anthers instead of the filaments. This class nearly agrees with the great natural order *Compositæ*, and consists chiefly of plants having compound flowers. Class XX., *Gynandria* (Gr. *gynê*, a female), consists of plants in which the stamens grow out of, or are united with the pistil. Class XXI., *Monœcia* (Gr. *oikos*, a house), consists of plants having the stamens and pistils in different flowers on the same plant; Class XXII., *Diœcia*, of those which have the male and female flowers on different plants; Class XXIII., *Polygamia* (Gr. *polys*, many, *gamos*, marriage), of those having the stamens and pistils in the same or in different flowers on the same or on different plants.—The classes are divided into orders, which are constituted on various grounds. The orders of the first 13 classes are strictly artificial, their characters being found simply in the number of the pistils, according to which they are named *Monogymia* (Gr. *monos*, one, *gynê*, a female), *Digymia*, *Trigymia*, &c.; *Dodecagymia*, including all with 12—19 pistils, and *Polygymia*, all with 20 and upwards. The orders of Class XIV. are constituted on entirely different grounds, and are two in number, *Gymnospermia* (Gr. *gymnos*, naked, *sperma*, a seed), and *Angiospermia* (Gr. *angeion*, a vessel)—the former ‘having naked seeds’ (or rather the fruit formed of 4 *achenia*), the latter having the seeds in a capsule. The orders of Class XV. are in like manner founded upon the fruit; those of Classes XVI., XVII., and XVIII., upon the number of the stamens; as are also these of Classes XX., XXI., and XXII.; those of Class XIX., chiefly upon characters taken from the florets of compound flowers; those of Class XXIII., upon the circumstance of the hermaphrodites, male and female flowers being found on one, two, or three plants; whilst the orders of Class XXIV. are strictly natural—*Filices* (or Ferns), *Musci* (or Mosses), *Algae*, and *Fungi*.

The student may acquire a pretty complete knowledge of the Linnæan artificial system, without knowing much in reality of B.; but, even in beginning to learn the natural system, he must learn some of the first principles of the science. Jussieu followed Ray in dividing plants into three great primary divisions—*Acotyledones* (q. v.), *Monocotyledones* (q. v.), and *Dicotyledones* (q. v.); having respectively no cotyledon or seed-lobe, one cotyledon, and two cotyledons. And, however the names may be changed, or characters assumed from other parts of the plant, these great divisions of the vegetable kingdom still subsist; the *Acotyledonous* plants being also, according to characters taken from the stem, *Acrogenous* (q. v.); the *Monocotyledonous* plants, *Endogenous* (q. v.); and the *Dicotyledonous* plants, *Ecogenous* (q. v.). Endlicher is the only botanist of great note who has attempted to make primary divisions of this vegetable kingdom essentially different from those indicated by Ray, and his attempt has not commended itself to general approval. De Candolle gave expression to an important truth in botanical science, when he united the two divisions of monocotyledonous and dicotyledonous plants under the common title of *Vascular*

plants, in opposition to Acotyledonous or *Cellular* plants; the vascular plants being the *phanerogamous*, and the cellular the *cryptogamous*. Lindley has endeavoured to modify the natural system by dividing the *asexual* or *flowerless* (cryptogamous) plants into the two classes of *Thallogens*—with the stem and leaves undistinguishable—and *Acrogens*, with the stem and leaves distinguishable, thus limiting the term acrogens to those which have a distinct stem; and in like manner dividing the *sexual* or *flowering* (phanerogamous) plants into five classes, viz., *Rhizogens*, with fructification springing from the thallus; *Endogens* and *Dictyogens*, with fructification springing from a stem, the wood of which is youngest in the centre, and the seed with a single cotyledon—the former having parallel-veined permanent leaves, and the wood of the stem always confused; the latter having net-veined deciduous leaves, and the wood of the stem when perennial arranged in a circle around a central pith; *Gymnogens* and *Exogens*, having the wood of the stem youngest at the circumference, and always concentric, the seed with two or more cotyledons; the former having the seeds quite naked, the latter having them enclosed in seed-vessels. But others generally prefer the simpler division of phanerogamous or vascular plants into monocotyledonous or endogenous, and dicotyledonous or exogenous, the former including Lindley's endogens and dictyogens, the latter his exogens, gymnogens, and rhizogens; although the latter have only a provisional place assigned them, in the absence of well ascertained views of their structure.

One of the great advantages of the natural system is, that the plants which it brings together are very generally found to agree in their properties, as well as in their structural characters. There are, indeed, species which, in respect of their properties, are anomalous or exceptional in the genera or orders to which they belong; but these exceptions do not invalidate the general rule, according to which we expect the most deadly poisons in the order *Loganiaceae*, bland mucilage and useful fibre in *Malvaceae*, wholesome succulent herbage along with a certain amount of acidity or pungency in *Cruciferae*, &c., &c. The knowledge of the properties of genera and orders is of great use in guiding inquiry, and it is thus that modern science attains in rapid succession to discoveries important in their practical relations.

In the determination of the intermediate subdivisions of the natural system, botanists have not yet been so successful as with regard to these primary divisions, and the ascertainment of the characters and limits of lowest subdivisions—orders, tribes, and genera. Great difficulty has been found in arranging the orders in natural groups, although the attempt, very necessary to a complete system and a just exhibition of nature, has been very assiduously and perseveringly made by Meisner, Endlicher, Lindley, and others of the greatest botanists of the present age.

BOTANY BAY, a haven of New South Wales, in lat. 34° S., and long. 151° 15' E., discovered by Cook, on his first voyage, in 1770, and named by him from the great number of new plants in its vicinity—a characteristic, however, rather of Australia in general than of this particular locality. In 1787, it received England's first penal colony in the east; and though it was supplanted the very next year by Port Jackson, a vastly superior harbour immediately to the north of it, yet it long continued to be the popular designation, not merely of this convict settlement, but of the Australian convict settlements generally. On the shore of B. B. there was erected, in 1825, a column to the memory

of that eminent French navigator, the unfortunate La Perouse.

BOTH, JOHN and **ANDREW**, two celebrated painters, who, being united in their works like Beaumont and Fletcher, are, like them, usually spoken of together, were born at Utrecht, where their father was a painter on glass—John in 1610; the date of Andrew's birth is not known. After studying under Abraham Bloemart, the brothers went to Italy, where they soon won for themselves a high reputation. John painted landscapes, adopting Claude for his model, while Andrew filled in the figures after the style of Bamboccio, and in so careful a manner that the pictures looked like the work of one hand. John's landscapes are characterised by delicious warmth of sky, softness of distance, and general truthfulness to nature; even the different hours of the day may be distinguished in some of his best pictures, so careful are his tints. The works of the brothers are still in great repute, and bring high prices whenever they are offered for sale. One of the brothers was accidentally drowned in a canal in Venice in 1650; the other brother then settled in Utrecht, where he died six years afterwards.

BOTHIE (from the Gaelic, *bothag*, a cot), a hut, or very humble kind of cottage, in the Highlands of Scotland, but which original signification has latterly been extended to a house in which unmarried farm-labourers are lodged. The use of such a species of barrack, as it should be called, is of modern date, and as yet it is confined to certain parts of the country. Ordinarily, the ploughmen employed on Scotch farms are married, and reside with their families, each in a separate cottage. See **HIND**. A straining after economy in the working of farms has, however, introduced into Scotland the practice of employing only unmarried young men, several of whom are usually lodged together in a B., which is fitted up with some plain articles of furniture. As the inmates prepare their own food, and live without any kind of domestic control, a grievous laxity of morals is, of course, the consequence. In some places, bothies for lodging groups of unmarried female labourers on farms have also been introduced, with still more deplorable results. This subject has received some attention from the Rev. J. Begg, D.D., Edinburgh, who, in a public address (1859), thus speaks of bothies: 'The bothie system prevails more or less in the eastern and north-eastern districts of Scotland—in East Lothian, Fife, Angus, Kincardine, Aberdeen, Banff, Moray, and Caithness shires, and partially even in other counties. In 1841, in thirty parishes within the bounds of the synod of Perth and Stirling, 825 men, almost all unmarried, were lodged in bothies. In Aberdeenshire, there are at present 99 bothies, inhabited by 569 males, and 159 females. In East Lothian, there are not fewer than 600 Highland girls lodged in bothies. The prevalence of bothies is sometimes very great, even in single parishes. In the parish of Wick, there are 21 bothies, containing 77 young men, and 65 young women.' From this and other expositions, public opinion has been brought to bear on the B. system, which is universally condemned as a serious social abuse.

BOTHNIA, the name formerly given to a country of Northern Europe, extending along the east and west shores of the Gulf of Bothnia (q. v.), the eastern portion now being comprised in Finland (q. v.), and the western forming the Swedish governments of Pitea and Umea.

BOTHNIA, GULF OF, the part of the Baltic Sea which lies to the north of the isle of Åland, having on its eastern shore Finland, on the western,

Sweden and Lapland, with Tornea for its northern limit. It extends from lat. 60° to 66° N., and long. 17° to 25° 35' E., its greatest length being about 400 miles, and its average breadth 100 miles. Its depth varies from 20 to 50 fathoms, but both along its shores, and in the middle, are many small islands, sand-banks, rocks, and cliffs, called *skærs*, which render the navigation difficult; though on the whole it is less dangerous than other parts of the Baltic, and has many good harbours. The rivers which fall into this gulf, both from Sweden and Finland, are numerous; and the waters of the gulf itself are but slightly salt. In winter, it is usually so hard frozen that it can be crossed by sledges.

BOTHRIOCEPHALUS (Gr. *bothrion*, a little pit, and *cephale*, a head), a genus of intestinal worms, belonging to the order of *Cestode Worms* (q. v.), and included, until recently, in the genus *Tænia* (tape-worm, q. v.). The head in this genus is not furnished with four sucking disks, as in the true tape-worms, but with two lateral longitudinal hollows, which seem to serve only for adhesion by means of a partial vacuum, and to have nothing to do with nutrition. Nourishment is indeed supposed to be obtained entirely by the imbibing of fluids through the entire length of the worm; and whilst this process of imbibing takes place, there is also an exudation—as *exosmose* accompanies *endosmose* (q. v.) in the roots of plants—of, peculiar oleaginous drops, which may probably be in part the cause of the injurious effects produced by these worms upon the health of the animals infested by them. The species of *B.* are very abundant in predaceous fishes, and occur more sparingly in fish-eating birds; the immature and sexless young being found in fishes and inferior aquatic animals, either in peculiar cysts, or in the intestinal canal. Sticklebacks are often seen distended to an unusual size by a species of *B.* which lies free in the cavity of the abdomen; but in the stickleback its joints and sexual organs always remain undeveloped; it is only when the stickleback has been digested in a bird's stomach, that the



A few Segments
of
Bothriocephalus
latus.

B. released, and finding itself at last in suitable circumstances, acquires its mature form, becoming an inhabitant of the bird's intestines. Only one species of *B.* occurs in man, *B. latus*, which is at once distinguished from the common tape-worm by the different form of its segments, but has been often confounded with another species of tape-worm, under the name of Broad Tape-worm. The segments are much broader than they are long, and each contains organs of reproduction. The worm is strictly androgynous. It is scarcely known in Britain, but is of frequent occurrence in some parts of Europe, and sometimes attains a length of fifteen feet or upwards; and a coil of these worms is not unfrequently expelled at once from a patient. The *B.* is, however, much more easily expelled than the true tape-worms. The same means are employed. The geographical distribution of this worm, which is most frequent in low marshy countries, has led to the conjecture, that its youngest brood may inhabit some of the smallest aquatic animals, and that it may find its way into human beings by their eating salads, fruit which grows near the ground, or the like.

BOTHWELL, a small village in Bothwell parish, in Lanarkshire, on the right bank of the Clyde, 8 miles east-south-east of Glasgow. The river is here crossed by the celebrated bridge, the place of the bloody encounter between the Covenanters and Monmouth in 1679, when the former were so

terribly defeated. Near the village are the magnificent Norman ruins of Bothwell Castle, at the foot of which the Clyde washes the fine scenery of 'Bothwell Bank,' celebrated in Scottish song.

BOTHWELL, JAMES HEPBURN, fourth EARL OF, was born about 1526. On his father's death in 1556, he succeeded to the great inheritance which made the Earl of Bothwell the most powerful noble in the south of Scotland. At first, he opposed the Reformation party, but on their accession to power he easily changed his politics; and, in 1561, formed one of the deputation of lords sent to convey the youthful Queen of Scotland to her kingdom. He was shortly after made a privy-councillor; but his violence and misconduct soon became intolerable, and he was ordered to quit Edinburgh. In March 1562, he and the Earl of Arran were committed to the castle for conspiring to seize the queen's person. *B.* made his escape, was recaptured at Holy Island, again got free, and sailed to France. He speedily returned, but finding Moray close on his trail, embarked for the continent. Not appearing at his trial, he was outlawed. In 1565, after the queen's marriage with Darnley, he reappeared, and having strongly espoused her cause against Moray and his party, was suddenly restored to favour, and even high influence. In October 1566, while performing a judicial tour in Liddesdale, he was attacked and wounded, and the queen manifested her interest in his danger by riding twenty miles and back to see him, a journey which brought on a dangerous fever. At Craigmillar, some time after, *B.* attempted, unsuccessfully, to overrule her objections to a divorce from Darnley. A more thoroughgoing method was open to him, and on the night of 9th February 1567, Darnley was blown up at the Kirk of Field. The public voice loudly charged *B.* with the murder, but he was not formally indicted till the 28th March. He came to the trial attended by 4000 followers, and received an easy acquittal. Two days after, he carried the sword of state before the queen at the opening of parliament, and at its close, all his lands and offices were confirmed to him, in consideration of his 'gret and manifold gude service done and perfermit not only to her hienes' honour, weil, and estimatioun, but alsua to the comene weil of the realme and leiges thairof.' At a supper on the following night, the leading nobles signed a bond approving of Bothwell's acquittal, and commending him as a fit husband to the queen, pledging themselves to stand by him. On the 26th April, *B.*, accompanied by a strong force, carried off the queen to Dunbar Castle; on the 6th May he was divorced from his wife; and on the 15th his marriage with Mary was solemnised at Holyrood. He had previously been created Duke of Orkney. His guilty triumph was very short; the wrath of the nation was roused; at the end of one month, Mary was a prisoner in Edinburgh, and *B.*, pursued in his voyage to the Orkneys, fled to Denmark. There he was seized, imprisoned, and died in 1576, leaving no heirs. His titles and estates were forfeited to the crown.

BOTONÉ, or **BOTONNY**. In Heraldry, a cross betené is a cross of which the ends are in the form of buds or buttons.

BOTRYCHIUM, a genus of Ferns, of the division *Ophioglossæ*, having the *spore-cases* (or seed-vessels) distinct, sub-globose, clustered at the margin, and on one side of a pinnated *rachis* (an altered frond), 2-valved, without any trace of an elastic ring, and opening transversely. The only British species is *B. Lunaria*, MOONWORT, a little plant, pretty frequent in dry mountain pastures, but not

applied to any particular use. A species more worthy of notice is *B. Virginicum*, of which the geographical distribution is very remarkable. It abounds in many parts of the southern states of America, the mountains of Mexico, &c.; in Australia, in some parts of Asia, as the Himalaya Mountains; and is found also in Norway, although in no other part of Europe. It is large and succulent, and is boiled and eaten in the Himalaya, in New Zealand, &c. It is called RATTLE-SNAKE FERN in some parts of America, from its growing in places where rattlesnakes are found.



Moonwort Fern
(*Botrychium Lunaria*)

ing the fructification at their extremity. Some of them attack the fibres of vegetable fabrics, such as linen and cotton, in damp places, the decayed stems of plants, decaying fruit, &c. Some are found on living animal tissues, whether always previously diseased or not, is a question still unsettled, although the probability appears to be that they make their appearance only where there is already disease, which, however, they modify or entirely change. A remarkable species of this section of the genus is the MUSCARDINE (q. v.), or SILKWORM ROT.—A section of the genus, in many respects of particular interest, and which some botanists have endeavoured to separate into a distinct genus, consists of species which grow among living vegetable tissues. The threads of the *mycelium* creep among the loose cells of the under side of the leaves, and send up their fertile shoots through the stomata (see LEAF and STOMATA).



Botrytis parasitica :

a, plant, with mycelium, magnified; b, extremity of branch, with fructification; c, fructification, more highly magnified.

Many of the species are extremely destructive to particular plants, as *B. parasitica* to turnips. But *B. infestans* is, of all the species, the subject of greatest interest, the potato disease being confidently ascribed to it by some observers, among whom is

sometimes named Mr Berkeley, and the opinion of no living botanist is entitled to greater respect upon a point connected with this branch of the science; but Mr Berkeley himself states his opinion very guardedly. 'The decay of the leaves and haulm in the potato murrain,' he says, 'is certainly dus

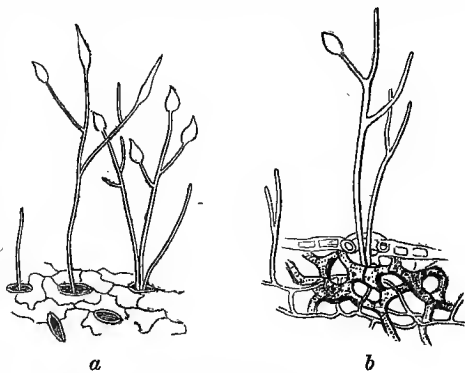

Botrytis infestans :

a, Young plants proceeding from stomata.
b, Section of potato-leaf, shewing the mode in which the mycelium creeps among the loose tissue of the leaf.

to *Botrytis infestans*; and its appearance in the diseased tissues of the tubers, when exposed to the air, makes it at least probable that it has a close connection with that destructive murrain, which, in many instances, does not appear alone, but accompanied by other diseases. The mould may be traced spreading round the edges of the brown spots on the leaves, and soon destroying the tissue on which it was developed.' (Art. *Botrytis* in Morton's *Cyclopaedia of Agriculture*.) This destruction results not only from the fungus feeding upon the juices of the plant, but from its obstructing the elaboration of the sap and all the processes which in a healthy state take place at the surface of the leaf.—The whole subject of the propagation of fungi of this kind is involved in great obscurity. They are indeed seen to produce spores in great abundance, but the doubtful question is, how these reach the place where they are to grow, whether from the surface of the leaf, to which it is objected that the stomata are too small to admit them, or, as Mr Berkeley thinks, from within the plant. See POTATO DISEASE.

BOTTA, CARLO GIUSEPPE GUGLIELMO, an Italian poet and historian, born in 1766 at S. Giorgio del Canavese, in Piedmont. He studied medicine in Turin. In 1794, he became a physician to the French army, and in 1799, he, Carlo Aurelio de Bossi, and Carlo Giulio, were appointed the provisional government of Piedmont. They were known as *Il triumvirato de tre Carli*. After the battle of Marengo, he became a member of the Piedmontese Consulta. In the *Corps Legislatif*, he gave offence to Napoleon, by designating his government as despotic. In 1830, he was allowed to return to his native town, and was pensioned by Charles Albert. He died in Paris 10th August 1837. Of his works of earlier date, the following may be mentioned, in which his admirable historic style is gradually developed: *Description de l'île de Corfu* (2 vols., Par. 1799); *Souvenirs d'un Voyage en Dalmatie* (Tur. 1802); *Précis Historique de la Maison de Savoie* (Par. 1803); *Histoire de l'Amérique* (Par. 1809). His epic poem in twelve books, *Il Camillo o Vejo Conquistata* (Par. 1816), was also favourably received. But his most important works are his *Storia d'Italia dal 1789 al 1814* (Par. 1824), which has gone

through many editions, and for which he received the quinquennial prize of 1000 Tuscan dollars, founded by the Grand Duke Ferdinand II. in 1814, in the *Accademia della Crusca* at Florence; his *Histoire des Peuples d'Italie* (3 vols., Par. 1825), in which he denies to the Christian religion and to philosophy the credit of having civilised Europe, and ascribes it to the restoration of learning; and the *Storia d'Italia dal 1490 al 1814* (20 vols., Par. 1832), which consists of Guicciardini's work (1490—1534), Botta's continuation of it (1535—1789), and the above-mentioned *Storia d'Italia*.

BOTTA, PAUL EMILE, a distinguished French archaeologist and traveller, the son of the preceding, was born about 1800. While yet young, he undertook a voyage round the world, and remained long about the western coasts of America, where he zealously collected treasures of natural history. In the year 1830 he went to Egypt, where he entered into the service of Mehemet Ali as a physician, and in this capacity accompanied the Egyptian expedition to Sennaar. Here he formed a very considerable zoological collection, with which he returned to Cairo in 1833. The French government now appointed him consul in Alexandria, from which he undertook a journey to Arabia, the results of which he gave to the world in a work, entitled *Relation d'un Voyage dans l'Yémen, entrepris 1837, pour le Muséum d'Histoire Naturelle de Paris* (Par. 1844). From Alexandria the government sent him as consular agent to Mosul, and at this place, at the instigation of the German orientalist Julius Mohl, he commenced a series of discoveries which form an epoch in archaeological science. Early in the spring of 1843, B. began his diggings in the heaps of ruins near the Tigris, for monuments of Assyrian antiquity, and the *Journal Asiatique* soon contained accounts of the success with which his enterprise and perseverance were rewarded, and also disquisitions on the extremely difficult subject of the cuneiform writing of the Assyrians, which afterwards appeared as a separate publication under the title, *Mémoires de l'Écriture Cunéiforme Assyrienne* (Par. 1848). The French government took up the matter warmly; a practised draughtsman was sent out for the purpose of making sketches upon the spot of the sculptures on alabaster, so apt to fall to pieces; and a commission of learned men was appointed, for the purpose of conducting the publication of a magnificent archaeological work, which shortly afterwards appeared under the special superintendence of B. himself, with the title, *Monument de Ninive, découvert et décrit par Botta, mesuré et dessiné par Flandin* (Par. 1849—1850). It consists of five great folio volumes. In 1848, he published the *Inscriptions découvertes à Khor-sabad*. Although in abundance of results B. was far exceeded by Layard (q. v.), yet he certainly deserves the praise of having laid the foundation of Assyrian archaeology, the extent and importance of which are even yet imperfectly perceived. See **ASSYRIA**.

BOTTARI, GIOVANNI, a learned Italian prelate, was born at Florence, January 15, 1689. He studied ancient literature and eloquence under Biscioni, and subsequently applied himself to mathematics, philosophy, and theology. He soon obtained a great reputation for the delicacy and purity of his style. The Della Crusca Academy intrusted him with the care of a new impression of its famous dictionary. This extensive work occupied B. and his collaborateurs several years, and proved of extreme service to the Italian language. In 1730, he went to Rome, where he was made professor of ecclesiastical history and of controversy in the College of

La Sapienza. He also took part in the labours of the geometer Manfredi, when the latter was engaged in determining the level of the Tiber. Clement XII. appointed him librarian of the Vatican, and Benedict XIV. canon of Santa Maria Transteverine. He died at Rome, 3d June 1775. The works of which B. was either the author or editor are very numerous; the principal are—his edition of *Virgil* from the Vatican MS.; his elaborate treatises on the catacombs of Rome and on the Vatican; his *Del Museo Capitolino*; and his dissertations on Dante, Boccaccio, and Livy.

BÖTTGER, or BÖTTCHER, or BÖTTIGER, JOH. FRIEDR., by whom the art of porcelain manufacture was very much improved in Germany in the beginning of last century, was born in 1681 or 1682 at Schleiz, in the territory of Reuss. His father was master of the mint at Magdeburg and at Schleiz. He was apprenticed to an apothecary in Berlin, but became an enthusiast in the search for the philosopher's stone, for which he neglected everything else, thereby involving himself in many difficulties, and incurring the displeasure of the authorities, so that he was obliged to flee from Berlin, to escape the risk of being punished as an adept. He found protectors and patrons at the court of Saxony, and received large sums to enable him to prosecute his experiments in alchemy. Disappointment ensuing, as he did not succeed in making gold, he was called upon to reveal his secret in writing, and handed in a manuscript full of mystical nonsense, but in which he expressed himself with the air of one completely master of his subject. The king, however, was dissatisfied with this production, of which he appreciated the worthlessness, and readily consented to a request of the Count of Tschirnhausen, who desired to avail himself of the skill which he believed B. really to possess, for experiments upon clays, with a view to the manufacture of porcelain. B. was compelled, accordingly, to enter upon these experiments, of which the celebrated Meissen (q. v.) Porcelain was the result. See **POTTERY AND PORCELAIN**. But as a security against the revelation of the art of making it, he and his assistants were treated as prisoners; and when Saxony was invaded by Charles XII. of Sweden in 1706, they were secretly removed from Dresden to Königstein. His success was, however, rewarded with large presents, which he soon squandered. He died on 13th March 1719.

BÖTTIGER, KARL AUGUST, one of the most erudite and thoughtful archaeologists of Germany, was born 8th June 1760, at Reichenbach, in Saxony. He studied at Leipsic. In 1791, chiefly through the influence of Herder, he was appointed director of the Gymnasium, and consistorial councillor at Weimar. Here he enjoyed the stimulating society of Schiller, Herder, Wieland, Goethe, and others. His literary activity at this period was prodigious. He edited several journals, and wrote multitudes of reviews, biographical notices, &c., for the *Allgemeine Zeitung*. In 1804, B. was called to Dresden, where he began to deliver lectures on special branches of classical antiquities and art. The result of these was: *Discourses on Archaeology* (Dresden, 1807); *On Museums and Collections of Antiques* (Leip. 1808); *The Aldobrandinian Marriage Festival* (a mythico-allegorical interpretation of a picture discovered by a member of the Florentine family of Aldobrandini, representing a Roman marriage. (Dresden, 1810); *Thoughts on the Archaeology of Painting* (Dresden, 1811); and the *Mythology of Art* (Dresden, 1811). In 1814, appeared his *Lectures on the Dresden Gallery of Antiques* (Dresden); in 1821—1825, his *Amalthea, or Museum of*

Mythological Art, &c. (Leip.); and in 1826, his *Thoughts on Mythological Art* (Dresden and Leipzig). In 1832, B. was elected a member of the French Institute. He died 17th November 1835. His works, both in Latin and German, have been collected and edited by Sillig.

BOTTLE (Fr. *bouteille*, which is the dim. of *botte* or *boute* [allied to Eng. *but*], a vessel), a vessel, generally of a round shape, with a narrow neck, for holding liquids. Bottles are now usually made of glass or earthenware; but the first bottles were made of the skins of animals, mostly goats—of this kind were the bottles spoken of in Scripture. Skin bottles are still used in Southern Europe for the transport of wine, and by tribes of Africa and Asia for carrying water. The ancient Egyptians made bottles of most elegant form and exquisite workmanship of alabaster, stone, gold, ivory, and other substances. The Italian peasants carry, slung round their necks, bottles made of the rind of the gourd, which, when dry, is as hard as wood. Bottles made of glass will be treated of under **GLASS BOTTLES**.

BOTTLE-CHART is the name given to a marine chart which purports to shew the track of sealed bottles thrown from ships into the sea. It is a well-known practice to throw sealed bottles containing some intelligence into the sea during long voyages, in the hope that these fragile messengers may be picked up, and their intelligence reach its proper destination. The frequency of these instances at length led to the inference, that by such means the determination of currents might be illustrated. Captain Beecher, an English naval officer, has the merit of having constructed charts of bottle-voyages in the Atlantic, his facts being drawn from the numerous cases that had occurred. The time which elapses between the launching of the bottle from the ship and the finding it on shore, has varied from a few days to sixteen years; while the straight-line distance between the two points has varied from a few miles to 5000 miles. Of the actual length of the curved line followed by the bottle, little or nothing is known, for the intermediate history of the voyage is a blank. The subject is now in course of being further investigated by this ingenious officer and others; and perhaps, in time, bottle-charts, as determining ocean currents, may be found practically useful to the hydrographer. Here, only glancing at this novel subject, we refer for current information respecting it to the *Nautical Magazine*.

BOTTLE-GLASS. See **GLASS BOTTLES**.

BOTTLE-GOURD (*Lagenaria*, from Lat. *lagena*, a bottle), a genus of plants of the natural order *Cucurbitaceæ* (q. v.), nearly allied to the Gourd (q. v.) genus (*Cucurbita*), in which it was until recently included. One of the most marked distinctions between them is the very tumid border of the seeds of the Bottle-gourds, which have also all the anthers separate, and have white flowers, whilst those of the Gourds proper are yellow. The Common B., or False Calabash (*Lagenaria vulgaris*), is a native of India, but is now common almost everywhere in warm climates. It is a climbing musky-scented annual, clothed with soft down, having its flowers in clusters, and a large fruit, from 1 to even 6 feet in length, which is usually shaped like a bottle, an urn, or a club. The fruit has a hard rind, and when the pulp is removed, and the rind dried, it is used in many countries for holding water, and is generally called a *calabash* (q. v.). The B., in its wild state, is very bitter and poisonous, and even in cultivation, some of its varieties exhibit not a little of the bitterness and purgative properties of colocynth (q. v.). Other varieties, however, have a cooling edible pulp. This is most perfectly the case, in general,

with those which attain the greatest luxuriance. The B. appears to have been introduced into Europe about the close of the 16th c., but it requires for its advantageous cultivation a warmer climate than that of any part of Britain, where, although it succeeds well enough on a hotbed, it is chiefly known as an object of curiosity. It is, however, much cultivated in warmer countries as an esculent, and is an important article of food to the poorer Arabs, who boil it with vinegar, or make a pudding of it in its own rind with rice and meat.

Another species, *L. idoloratrica*, is a sacred plant of the Hindus, much employed in their religious ceremonies.

BOTTLEHEAD (synon. *Bottlenose*, *Bottle-headed Whale*, *Bottle-nosed Whale*, or *Beaked Whale*), a cetaceous animal occasionally but rarely met with on the British coasts, and on those of the continent of Europe. It was until recently placed in the genus *Delphinus* by naturalists, and is still ranked among the *Delphinidæ* or Dolphin (q. v.) family;



Bottlehead.

but some of its characters appear to make it a connecting-link between them and the *Balenidæ*, or true whales. A new genus, *Hyperoodon* (the name of which is derived from the Greek, and refers to the peculiarities of the dentition), has been erected for it; but unfortunately several specific names have been adopted by different authors—as *H. Butzkopf*, *H. bidens*, and *H. Honfioriensis*—to the increase of difficulty and obscurity; whilst it appears that there is only one species to which they equally belong. The B. has the snout produced into a beak, as in the dolphins; the beak is short and strong; the forehead rises suddenly from the beak; and is remarkably elevated, a peculiarity which is owing to large bony crests rising over the bones of the upper jaw. The teeth are only two in number, and are situated in the fore-part of the lower jaw,



Skull of Bottlehead.

pointed, but much enveloped by the soft parts, and sometimes completely hidden among them: the palate and upper jaw are furnished with little hard points or tubercles, not $\frac{1}{10}$ th of an inch in height, which, however, have been doubtfully regarded as a kind of false teeth, and by Cuvier as rudimentary vestiges of whalebone. There is a dorsal fin, rather small in proportion to the size of the animal, and placed further back than in the common dolphin. The blowhole is crescent-shaped, the points of the crescent directed backwards. The skin is smooth and glossy, of a blackish lead colour on the back, gradually becoming lighter on the sides, and whitish on the belly. The animal attains a length of about 25 feet.

The B. has occasionally been caught in consequence of its having entered harbours or the mouths

of rivers. One was caught above London Bridge, and figured and described by Hunter in the *Philosophical Transactions* for 1787. It is impossible that too great attention can be paid to specimens of the rarer cetacea caught or driven ashore on any part of the coast, and it is to be hoped that the obscurity and confusion still so much prevailing in this branch of natural history may soon be removed. Photography seems to afford new facilities for an exact comparison of specimens, of which advantage ought to be taken; and everything capable of being preserved should be so carefully, for the study of naturalists. There is a splendid skeleton of the B. in the Museum of the Royal College of Surgeons, London.

The name BOTTLE-NOSED WHALE has been also given to a species of dolphin (q. v.), *Delphinus Tursio*, which is occasionally met with on the British coasts.

BOTTOM, in naval language, is either the whole ship itself, or that part of it which is under water when laden. Commodities are often said to be imported 'in foreign bottoms,' or in 'British bottoms;' in which cases, the phrase is applied to the whole ship. A 'full ship,' or a 'full B.,' denotes such a form given to the lower half of the hull as to allow the stowage of a large amount of merchandise. A 'sharp ship,' or a 'sharp B.,' implies a capacity for speed.

The word B. is also applied in an obvious way to the bed of the sea, which is characterised as rocky, stony, sandy, coral, muddy, oozy, &c., bottomed.

BOTTOMRY, BOND OR CONTRACT OF, is a security by which a ship itself is expressly mortgaged and pledged by the owner or master, or *hypothecated* for repairs to the ship, or for money advanced for its outfit, or otherwise with relation to it. It is called a security by B., because the bottom or keel of the ship is figuratively used to express the whole of it. The loan or debt is repayable only in the event of the ship's safe arrival at the port or destination; and in consideration of this risk, the lender or creditor exacts a premium, the amount of which depends on the nature of the adventure. If the ship be totally lost, the lender loses his money; but if she returns safely, he recovers his principal, together with interest at the rate agreed upon. These contracts, when made by the owner to raise money for the outfit of the vessel, are preferable according to the priority of their dates; but when entered into in foreign ports for repairs at different periods of the voyage, the last security in date is entitled to priority in payment.

Such, generally, is the law of Great Britain; but the French law appears to be different. By that system, a ship, as movable property, cannot be hypothecated, but remains subject to the debts of the seller until it has made a voyage at sea, under the name and at the risk of the new purchaser, unless it has been sold under a decree; and it is a rule that the sale of a ship at sea shall never prejudice the creditors of the seller. See *RESPONDENTIA*, *SHIPPING*, and *HYPOTHECATION*.

BO'TZEN, an important trading town of the Austrian Tyrol, about 32 miles north-north-east of Trent. B. is a well-built town, with good streets and arcades; and streams of pure water are conducted through the principal thoroughfares, in little canals. It is protected from the inundations of a mountain-torrent in the vicinity by a strong wall about two miles in length. Its situation, at the junction of the roads from Germany, Italy, and Switzerland, makes B. the entrepôt of the trade of these three countries. It has manufactures of silk, linen, hosiery, leather, &c.; and four extensive

annual fairs. Wine and fruits in abundance are produced in the environs. Pop. 10,000.

BOUCHAIN, a fortified town of France, in the department of Nord, 12 miles south-east of Douai, intersected by the Scheldt, and possessing the means of laying the adjacent country under water, in the event of an attack. It was taken by the Duke of Marlborough in 1711, and recaptured by the French in the following year, to whom it was finally ceded by the treaty of Utrecht. Pop. about 1000, who are chiefly engaged in extracting sugar from beet-root, and in refining salt.

BOUCHER, FRANCIS, a French painter of great note in his day, was born at Paris in 1704, and after studying there under Francis le Moine, he went to Rome to prosecute his art. After a short residence there, he returned to Paris, and on the death of Vanloo, was appointed principal painter to Louis XV. B. was an artist of much ability, and equally facile in the production of figure or landscape pictures—a facility, however, which was very fatal to the claims his genius might otherwise have had on posterity. In many of his paintings, picturesque effect is the only thing sought, no matter at what cost to truth. He has been called the Anacreon of painting, on account of the amorous character of many of his works: mythological and pastoral subjects were also great favourites with him. At his death in 1770, he was director of the French Academy.

BOUCHES-DU-RHONE, a department in the south-east of France, formerly a part of Provence, is situated at the mouths of the Rhone, in lat. 43° 10'—43° 56' N., and long. 4° 13'—5° 40' E. It has an area of about 2300 square miles, and a population, in 1856, of 473,365. It is divided into three arrondissements—Marseille, Aix, and Arles—which are subdivided into 27 cantons, and 106 communes. Through the northern and eastern districts, the Maritime Alps, which send out some calcareous ridges southward, slope gently down to the basin of the Rhone. Towards the sea-shore, there are several plains of considerable extent. About one-half of the department is under cultivation; heaths, wood, wastes, and water occupy the other half. The Rhone—which between Arles and the sea separates into several branches, forming a delta, called *Ile de la Camargue*—and its affluent, the Durance, are the principal rivers. The department is intersected by several canals of importance, and the aqueduct to convey the water from the Durance to Marseille, is one of the most extensive works of the kind in existence, being no less than 51 miles long, including 15 miles of tunnelling. The *Ile de la Camargue* produces corn and rice, and affords pasture for large numbers of sheep and cattle. The vine, olive, and mulberry also thrive here, and timber is plentiful. The soil in some parts, however, is strongly impregnated with salt. The great plain of Crau, which extends along the eastern branch of the Rhone, is stony and arid, except in a few spots, where the vine and olive are successfully cultivated. Besides the Etang de Berre (q. v.), there are numerous salt-lakes, communicating with the sea by natural or artificial channels. Marble, limestone, and gypsum are found in the Bouches-du-Rhone. Cloth leather, hats, perfumes, soap, olive-oil, vinegar, and chemical products are manufactured; there are extensive brandy-distilleries, sugar-refineries, and salt-works, and the produce of wine is large. B. has an active commerce with the Levant, Africa, Spain, and the West Indies.

BOUDOIR (Fr. *bouder*, to pout—hence a retired corner), a lady's small private apartment, in

which she receives only her most intimate friends. Boudoirs became particularly fashionable in France during the reign of Louis XIV., and so continued during the following reign. The example having been set by Madame Pompadour, Madame Dubarri, and other royal mistresses, it became indispensable for every lady of fashion to have her B, which was adorned with the most fantastic luxuriosness.

BOUFLERS, LOUIS FRANÇAIS, DUKE OF, peer and marshal of France, one of the most distinguished generals of his time, was born in 1644, and was descended from one of the most ancient and noble families of Picardy. He began his military career as a lieutenant, and rose very rapidly from one rank to another. Under the great Condé, Turenne, Cregui, Luxembourg, and Catinat, he fought with distinction in Germany and the Netherlands. His defences of Namur in 1695, and of Lille in 1708, are famous. The siege of the former place, conducted by King William III. of England, cost the allies more than 20,000 men; and although Louis XIV. sent to B. an order written by his own hand for the surrender of the place, yet he did not surrender it until all the means of defence were exhausted. After the defeat of Malplaquet, he led the French army so admirably, that the retreat seemed rather a triumph than the consequence of a lost battle. He was a man of highly honourable and upright character. He died at Fontainebleau in 1711.—His son, Joseph Marie, Duke of Boufflers, and also a marshal of France, born in 1706, died at Genoa in 1747.

BOUFLERS, STANISLAS, MARQUIS DE, commonly styled the Chevalier de Boufflers, was born at Luneville in 1737. He was the son of the Marquis Boufflers-Remiencourt, who was captain of the guard to Stanislas, king of Poland, and his mother was long one of the brightest ornaments of the Polish court. He himself was esteemed one of the most clever and agreeable men of his time. He entered the French military service, and was very soon made governor of Senegal, in which capacity he had the merit of introducing many regulations very useful to the colony. After his return, he devoted himself to the light literature for which the time of Louis XV. was distinguished. He was chosen a member of the National Assembly in 1789, in which he displayed great moderation, and made some most judicious proposals; but after the 10th of August 1792, he forsook France. He was hospitably received at the court of Prussia, and received the gift of a large estate in Poland, in order to establish upon it a colony of French exiles. Having returned to France, he again devoted himself, after the year 1800, entirely to literature. In 1804, he entered as an old academician into the Institute reorganised by Napoleon. He died 18th January 1815. The monument on his grave bears the following inscription, dictated by himself: *Mes amis, croyez que je dors* (My friends, believe that I sleep). A collection of his works was published after his death (8 vols. Par. 1815). His letters from Switzerland deserve to be particularly mentioned; and from this work an idea may be formed of the amiable character and intellectual liveliness of its author.

BOUGAINVILLE, a bay, island, and strait, so called from the French navigator of the name (q. v.), a contemporary of Cook.—1. *Bay*, in Patagonia, on the north side of the Strait of Magellan, being in lat. 53° 25' S., and long. 70° 13' W.—2. *Island*, one of the Solomons, in the west section of Polynesia, sometimes distinguished from the east section as Melanesia. It is between lat. 5° 30' and 7° 2' S., and in long. 155° E., being mountainous, well

wooded, and populous.—3. *Strait*, in the New Hebrides, having Mallicollo to the south-east, and, to the north-west, Espiritu Santo, an islet of 63 miles by 20, which now appropriates the appellation that so long drifted about the ocean in search of a southern continent.

BOUGAINVILLE, LOUIS ANTOINE DE, one of the most famous navigators of France, was the son of a notary, and was born at Paris, 11th November 1729, studied there, and attained great proficiency both in languages and science. In 1754, he went as secretary of the French embassy to London. In 1756, he acted as aide-de-camp to the Marquis of Montcalm, to whom the defence of Canada was intrusted. At the head of a select detachment, he burned an English flotilla; and through his advice and example, a corps of 5000 French, in June 1758, successfully withstood an English army of 24,000 men. In the campaign of 1761 in Germany, he served with distinction. After the peace, he entered the naval service, in which he soon signalised himself. After having been obliged to give up a project which he had formed of founding a settlement on the Falkland Islands, he undertook a voyage round the world (15th Dec. 1766, to 16th March 1769) with a frigate and a St Malo transport, the first voyage round the world which the French ever accomplished. He gave an account of it in his *Description d'un Voyage autour du Monde* (2 vols., Par. 1771—1772). Geography and other branches of science were enriched by it with many discoveries. In the North American war, B. commanded several ships of the line, and in 1779, was made *chef d'escadre*; in the following year, he was made a field-marshal in the army. After the outbreak of the Revolution, he retired from public service, devoted himself entirely to scientific pursuits, and died 31st August 1811.

BOUGET. See WATER-BOUGET.

BOUGHT AND SOLD NOTES are notes of sale signed by a broker employed to sell goods, and by which the bargain through him is completed. The following is the form of the bought and sold note:

'Sold for A. B., to C. D., 250 firkins butter, at 100s. Shipped in the month of July, and payable by bill at two months.'

These notes are, in fact, transcripts from books, in which it is the practice of brokers to enter or register their transactions. The bought notes and the sold notes are respectively delivered to the principal parties; and as they contain the essential parts of the bargain, they will suffice, in the absence of a corresponding entry in the broker's books; but if they describe the particulars differently or incorrectly, as one species of goods for another, or erroneously state the terms, no contract arises, and a variation of this nature cannot be corrected by a reference to the broker's book.

In Scotland, there is no necessity for any such signed note, but the contract may be proved by any kind of evidence, verbal (see PAROLE) as well as written, the only exceptions to this general rule being those contained in acts of parliament relative to ships, literary property, patents, and goods bonded in the Queen's warehouses. See BROKER, SALE.

BOUGIE'S are rods of metal or other substances, used for distending contracted mucous canals, as the gullet, bowels, or urethra. See STRICTURE. For the urethra, they are frequently of German silver, or pewter, and vary from .125 to .25 inch in diameter. Still larger sizes are used by many surgeons. The following directions for making common non-metallic B. are taken from South's translation of Chelins

Surgery: 'A piece of fine linen, which has been already used, nine inches long, and half an inch in width, according to the thickness of the bougie to be made, is to be dipped into melting plaster, and, when a little cooled, spread flat and even with a spatula; it is then to be rolled together between the fingers, and afterwards between two plates of marble, till it is quite firm and smooth. The bougie must be equally thick throughout its whole length to about one inch from its point. Bougies are also made by dipping cotton threads into melted wax till they have acquired sufficient size, after which they are rolled between marble plates. Bougies are also made of a material termed "gum elastic;" and for very narrow strictures, catgut is often used.'

BOUGUER, PIERRE, one of the most eminent French mathematicians and natural philosophers of his time, was born at Croisic, in Bretagne, 16th February 1698, and studied in the Jesuit College at Vannes. In 1713, he succeeded his father as Professor of Hydrography in Croisic, from which he was removed to a similar office at Havre in 1730. In 1729, he published his *Essai d'Optique sur la Gradation de la Lumière*. His researches on other subjects of natural philosophy and astronomy continued to add to his fame; and in 1731, he was made Associate Geometer of the Academy of Sciences, and promoted to the office of pensioned astronomer in 1735. In that year, also, he was chosen to proceed, along with Godin and De la Condamine, to South America, in order to the measurement of a degree of the meridian at the equator. B. and his companions had to contend with many difficulties, and were more than seven years away from home, during which time B. made valuable observations on the length of the seconds' pendulum at great elevations, the deviation of the plumb-line from a vertical position through the attraction of a neighbouring mountain, the limit of perpetual snow, the obliquity of the ecliptic, &c. He published an account of his labours and those of his colleagues in a magnificent work, entitled *La Figure de la Terre déterminée par MM. Bouguer et De la Condamine* (Par. 1749), which, however, involved him in an unpleasant controversy with De la Condamine concerning their respective shares of merit in the researches in which they had been jointly engaged. B.'s investigations concerning the intensity of light laid the foundation of photometry; and their results, which had been partly exhibited in the optical work already noticed, were more fully embodied in his *Traité d'Optique sur la Gradation de la Lumière*, which was edited after his death by Lacaille (Par. 1760). He invented the heliometer in 1748, which has of late been brought to greater perfection by Fraunhofer. He also published an excellent work on navigation (Par. 1753). He died in 1758.

BOUILLÉ, FRANÇOIS CLAUDE AMOUR, MARQUIS DE, a distinguished French general, was born in 1739 at the castle of Cluzel, in Auvergne, entered the army at the age of 14, and served with distinction in Germany during the Seven Years' War. In 1768 he was appointed governor of the island of Guadeloupe, and on the seeming approach of war with Britain, he was made governor-general of Martinique and St Lucia, and commander-in-chief of all the French forces in the West Indies. When the war really broke out in 1778, he took the island of Dominica from the British, the whole garrison falling into his hands. In conjunction with Admiral De Grasse, he took Tobago in 1781; and after De Grasse's departure, the British islands of St Eustatius, Saba, and St Martin. The humanity and generosity which he displayed were equal to his valour and skill. In

1782, B. captured the islands of St Christopher's and Nevis. For this he was rewarded with the rank of lieutenant-general. In 1784, he visited England, and was received with extraordinary respect. Louis XVI. nominated him a member of the Assembly of Notables in 1787—1788; in 1790, he was made commander-in-chief of the army of the Meuse, the Saar, and the Moselle. His decision of character prevented the dissolution of the army and the outbreak of civil war; he also quelled the insurrection of the garrison of Metz and of the three regiments at Nancy. For this he received the thanks of the National Assembly and of the king. For his share in the attempted escape of Louis XVI. he had to flee from France. He repaired to Coblenz to the king's brothers, and in 1791 attended the conference at Pilnitz. In the same year he entered into the service of Gustavus III. of Sweden, and after the assassination of that monarch, he served in the corps of the Prince of Condé. He rejected a proposal which the French princes made to him in 1793, that he should take the chief command in La Vendée; and went to England, where his advice in West Indian affairs was useful to the government, and where he wrote his *Mémoires sur la Révolution Française*—a truthful and useful work, throwing much light on the transactions of that time. He died in London in 1800.

BOUILLON, a duchy, originally German, in the Belgian part of the grand duchy of Luxemburg, consisting of a woody and hilly district in the Ardennes, about 157 square miles in extent, and with a population of 21,000. This duchy was the possession of the famous crusader, Godfrey (q. v.)^o. Bouillon, who, in order to raise money for his crusade, pledged it, in 1095, to the Bishop of Liege. It was conquered by France in the war of 1672, and bestowed by Louis XIV., in 1678, upon his grand chamberlain, Latour d'Auvergne. By the peace of 1814, the greater part of it was included in the grand duchy of Luxemburg; and the sovereignty of it passed to the king of the Netherlands, who, in 1821, purchased the proprietary rights from the heir. By the revolution of 1830, B., along with Luxemburg, was separated from the Netherlands, and in 1837 united to Belgium.—The principal town is Bouillon, situated between steep hills on the Semoy, with a strong castle on a rock, formerly the residence of the Dukes of Bouillon. Pop. 2800.

BOUILLON, GODFREY. See **GODFREY DE BOUILLON**.

BOUILLY, JEAN NICOLAS, one of the most prolific of French dramatic authors, was born at Boudray, near Tours, in 1763, and at first studied law, but afterwards devoted himself to belles-lettres. At the commencement of the Revolution, he attached himself to Mirabeau and Barnave, and in 1790 produced a drama called *Pierre le Grand* (Peter the Great), in which he displayed very revolutionary sentiments. He afterwards filled important public offices in Tours during times of the most dangerous excitement, and conducted himself with great prudence and moderation. He took an active part in the introduction of the system of elementary schools in France. The greater number of his dramatic works were produced in the first decade of the 19th century. Many of them have been translated into other languages. He wrote also tales and other works for young persons, some of which acquired great popularity. He died at Paris, 24th April 1842.

BOULAC, or **BOOLAK**, the name of the port of Cairo, is situated on the Nile, about one mile distant from that city, and is supposed to be the site of the ancient Litopolis. It is a crowded

town, extremely dirty, with very narrow and irregular unpaved streets. It contains the custom-house and warehouses of Cairo, and has some good baths, which are supplied by the Nile. Pop. about 14,000.

BOULAINVILLIERS, HENRY, COUNT, an eminent French author, descended from an ancient family in Picardy, was born 11th October 1658 at St Saire, in Normandy. After studying at the College of Juilly, he embraced the military profession, but afterwards resigned it, and devoted himself to the investigation of the genealogy of the ancient families of France. He regarded the feudal system as the most perfect creation of human genius and wisdom, and his writings are pervaded by the most extreme aristocratic sentiments. They were only circulated in manuscript during his life, and first published after his death, which took place on 23d January 1722. The most valuable of them are his *Histoire de l'Ancien Gouvernement de France* (3 vols. Hague, 1727), his *Histoire de la Pairie de France et du Parlement de Paris* (2 vols. Lond. 1753), and his *Abregé Chronologique de l'Histoire de France* (3 vols. Hague, 1733). His philosophical writings have long ceased to have any interest, and the prejudices which appear in his historic works may afford amusement to his readers; but he deserves to be remembered as one of the first laborious investigators of the facts of history.

BOULAY DE LA MEURTHE, ANTOINE JACQUES CLAUDE JOSEPH, COUNT, a statesman of the French Empire, was born in 1761 at Chaumousey, a village in the Vosges. He espoused the cause of the Revolution, but held moderate principles. In 1797, he was elected to the Council of Five Hundred, in which he became the declared opponent both of Jacobinism and of the despotism of the Directory. He supported the *coup d'état* of the 18th Brumaire. Under the Empire, he accepted the post of president of the legislative section of the Council of State, in which capacity he had an important part in the preparation of the *Code Civil*. He afterwards laboured with extraordinary zeal and energy in the administration of the national domains, which he regarded as affording the basis for a regeneration of France. He adhered to the cause of Napoleon with remarkable fidelity. After the second Restoration, he was conveyed by the Russians into Germany. He received permission to return to France in 1819, and lived in complete retirement till his death, which took place at Paris, 2d February 1840. Napoleon had elevated him to the rank of a count of the Empire. In 1799, he published an *Essay on the Causes which led to the Establishment of the Commonwealth in England* in 1649, a work which had an extraordinary circulation, and did much to prepare men's minds for the revolution of the 18th Brumaire. He prosecuted the same general subject in his Political Picture of the Reigns of Charles II. and James II. (*Tableau Politique, &c.*, 2 vols. Brussels, 1818). He wrote also Bourrienne and his Errors, Voluntary and Involuntary (*Bourrienne et ses Erreurs, &c.*, 2 vols. Par. 1830), a work not without value in reference to the history of Napoleon.

His son, **HENRY BOULAY DE LA MEURTHE**, was born at Paris in 1797. He took an active part in the revolution of 1830, but became an opponent also of the government of Louis Philippe. He devoted great attention to questions of social economy, contributing much to promote the establishment of houses of refuge (*salles d'asile*), the extension of elementary education, and many improvements in the condition of the labouring-classes. In the National Assembly of 1848, he associated himself

with the moderate republicans, and in January 1849 was elected vice-president of the republic. Nevertheless, he tacitly acquiesced in the *coup d'état* of December 1851, and has ever since continued a quiet but useful member of the imperial senate.

BOULDER-CLAY, DILUVIUM, DRIFT, or TILL, is a post-pliocene bed of a remarkable character, and as yet somewhat mysterious history. It usually occurs as the lowest or first of that group of beds which geologists recognise as the post-tertiary, post-pliocene, pleistocene, or superficial formation. The only exception is when a bed of sand intervenes—as is rarely the case—over the surface of the subjacent rocks. It consists of a compact clay, blue or red, according to the prevalent character of the subjacent rocks, having boulders diffused throughout its mass, and with here and there thin lenticular beds of gravel and sand interspersed. In some places in Scotland it is not less than 70 feet thick. In America, it extends to about the 38th parallel; in Britain, it terminates a little to the north of London. The boulders, which are the most striking feature of this bed, differ in size from a small pebble to masses many tons in weight. They are portions of rocks of all ages, more or less worn. The older rocks, when from a distance, are rounded, while those that have been broken from rocks in the district are more angular. These masses are scattered without order in the clay, the heaviest blocks occurring frequently in the upper portion of the bed. Nor is there any indication of their having sunk in the clay from gravity—the clay seems to have been so viscid when the materials assumed their present position, as to have successfully resisted the immense pressure of these enormous blocks. The boulders have not that rounded appearance produced by the action of water in a river-course or on the shore between high and low water marks. They have a greater or less number of *rubbed faces*, produced evidently by being forced, while held in one position, over the solid rocks beneath. The rubbed and scratched surfaces exhibited on these rocks, when the superincumbent clay is removed, plainly testify to their origin. Several interesting examples of such rubbed surfaces exist in the neighbourhood of Edinburgh. They have been carefully examined and described by Fleming, Chambers, Milne-Home, and other local geologists. A careful observer can determine from the scratchings the direction of the current which bore with it the rubbing boulders. In the district to which we have alluded, these indicate a current from the west. The general direction, however, in America, in Britain, and in Scandinavia, seems to have been from the poles towards the warmer regions of the earth.

The B. contains no fossils strictly its own. Organisms exist in the boulders obtained from the older fossiliferous rocks, but no indications have hitherto been observed of a fauna or flora belonging to the period of the deposition of this bed. In the brick clays and gravels overlying it in Scotland, there are shells of arctic character.

The origin and structure of this remarkable bed have been a puzzle to geologists. That it was produced by the Noachian deluge, as was universally believed not many years ago, finds now no supporters. The present approved explanation assigns it as the product of a glacial ocean, in which the materials were borne violently along, pressing hard upon the sea-bottom, so as to wear and scratch it. But, while there is little room to doubt that such was the general fact, it remains to be shown how a merely ice-charged ocean could carry along such vast masses of clay and blocks, allowing them all the time to press so hard upon the sea-bottom as

to mould its whole figure—for such appears to have been its work.

BOULDERS, ERRATIC, are large masses of rock found at a distance from the formations to which they belong. The term is generally applied when they are found lying detached on the surface; in which case they may either have been washed out of the boulder-clay (q. v.), or have been carried separately by icebergs, and dropped in their present situations. Large blocks of Scandinavian rocks are scattered over the plains of Denmark, Prussia, and Northern Germany. From their magnitude and number, they frequently form a striking feature in the landscape. They abound on the shores of the Firth of Forth—a large one, locally known as the 'Penny Bap,' is the most prominent object on the beach a little to the east of Leith. The pedestal of the statue of Peter the Great, in St Petersburg, was hewn out of a large erratic boulder, 1500 tons in weight, that lay on a marshy plain near that

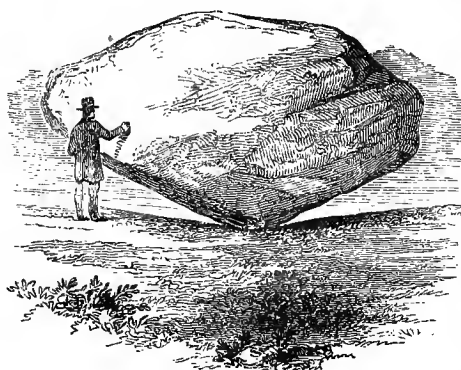

Erratic Boulder.

city. We give a drawing of a large one that forms a rocking-stone at Fall River, Massachusetts, United States.

BOULEVARD, or **BOULEVART** (Ital. *Boluardo*), identical with Eng. *bulwark* (q. v.), the name given in France to the old fortifications, ramparts, &c., with which towns, or portions of them, were or still are surrounded. In France and Germany, these ancient works have generally been levelled, the ditches filled up, and the space thus obtained employed for the formation of parks, promenades, and streets lined with trees. These, however, in France, still bear the name of Boulevard. The boulevards of Paris are celebrated, and are of great service as open spaces promoting the circulation of air amidst the dense mass of habitations. Some parts of them present a very dazzling spectacle; and as a whole, they afford a striking exhibition of the life and character of the French capital in all the different classes of society. The *Boulevard des Italiens* is particularly known as the rendezvous of the fashionable, and the *Boulevard du Temple* as the place where the small theatres are to be found which are frequented by the common people and the inhabitants of the suburbs, for which reason the expression *Théâtre de Boulevard* is often employed to denote a theatre for the common people, or one of an inferior kind.

BOULOGNE, a town of France, in the department of the Seine, on the right bank of the river of that name, about 5 miles west of Paris, from which it is separated by the Bois de Boulogne. A fine stone bridge of twelve arches crosses the Seine

from B. to St Cloud. Pop. in 1856, 11,161. The Bois de Boulogne is traversed by many walks, through the broadest of which the fashionable world of Paris travels in Easter-week to the Abbey of Longchamp. At the entrance of the wood lies Auteuil (q. v.). During the Revolution, the trees of the older walks were mostly cut down. But when Napoleon chose St Cloud, in the immediate neighbourhood, for his summer residence, new walks were planted and laid off, and the enclosing walls were restored. From ancient times to the present day, this wood has been not only a place of enjoyment and recreation to the Parisians, but also their chief place of resort for duels.

BOULOGNE-SUR-MER, a fortified seaport in the department of Pas-de-Calais, France, situated at the mouth of the Lianne, in the English Channel, about 19 miles south-west of Calais, and 139 north-west of Paris. Lat. 50° 45' N., long. 1° 36' E. The town consists of two parts—Upper and Lower Boulogne. The upper town was, in former times, strongly fortified; but its citadel was demolished in 1690, and its ramparts have been converted into beautiful promenades, with fine views, and from which, in clear weather, the spire of Dover can be seen. The upper town contains the Hôtel-de-Ville, and the Cathedral, a modern edifice with a conspicuous dome. The lower town, which is more properly the seaport, is newer, finer, more populous, and more lively, inhabited chiefly by merchants, mariners, and fishermen. It contains the barracks, the great hospital, the theatre, the museum, and gallery of art. Latterly, the streets of B. have been much improved by means of side pavement, and many new and elegant buildings have been erected. B. has numerous churches and educational institutions; is the seat of various associations; has extensive and excellent salt-water baths; and, on account of its fine sands, is much resorted to for sea-bathing. Pop. in 1856, 32,742, who are actively engaged in the boiling of sugar, in the manufacture of linen and sail-cloth, cordage, &c., and in fishing, the coast being productive in oysters, herring, eod, and mackerel. B. has an active coasting-trade, and ranks with Calais as one of the nearest and most frequented places of passage between France and England, steamers plying daily to London, which they reach in twelve hours, and twice a day to Folkestone, which they reach in two to three hours. B. is much resorted to by the English, who form a large section of the population, and for whose accommodation there are numerous hotels and boarding-houses. Paris is reached by railway from B. in six hours. The harbour of B. is too shallow for large ships of war, which can only reach the wide and safe roads of St Jean; it was, however, considerably enlarged and improved by Napoleon I., and also more recently—so that at high-water large merchant-vessels can, without danger, pass out or in. The long pier forms a fine promenade. B. was anciently called *Gesoriacum*, in the country of the Morini; after the time of Constantine the Great, it was called *Bononia*, and after that of the Carlovingians, *Botonia*. In 1435, B. came into the possession of the Duke of Burgundy, and was united with the crown of France by Louis XI. in 1477. B. was besieged by Henry VII. of England in 1492, taken by Henry VIII. in 1544, and restored to the French by Edward VI. in 1550. From this point Napoleon contemplated the invasion of England; and here he encamped 180,000 men and collected 2400 transports, ready at any favourable moment to swoop down on the shores of Britain; but after months' watching, the war with Austria created other employment for them. As a memorial of this great camp, a tall marble

column was commenced on the higher grounds; but being incomplete at the restoration of the Bourbons, it was finished and inaugurated in honour of Louis XVIII. It has since been restored to its original object, and surmounted by a colossal statue of Napoleon. The poets Campbell and Churchill died at B.; and the house, or rather, the house occupying the site of that in which Le Sage, the author of *Gil Blas*, is said to have died, is shewn to the visitor. Altogether, B. is to be described as a thriving and agreeable place of residence; and from its accessibility to English tourists, and rapid railway transit to Paris, it has greatly superseded Calais as a place of debarkation.

BOULTON, MATTHEW, a celebrated English mechanic, was born in 1728 at Birmingham, where his father, who had a steel manufactory, had acquired a considerable fortune. When still very young, he undertook, at his father's death, the business of the manufactory, which he carried on with great energy, and extended, in 1762, by the purchase of a piece of land, then a barren heath, at Soho, near his native town. One of his first inventions was a new mode of inlaying steel. He entered into partnership with James Watt (q. v.), who had obtained a patent for the great improvements in the steam-engine which have immortalised his name, and they established a manufactory of steam-engines in 1769. They jointly contributed also to the improvement of coining machinery, and so to the perfection of the coinage itself. B. died at Soho, 17th August 1809. His long life was devoted to the promotion of the useful arts and of the commercial interests of his native country. He was a man of extremely pleasing conversation, and of a most generous disposition.

BOUND, or BOUNDARY, the utmost limits of land by which the same is known and can be described; being in this sense synonymous with *abutals*, which means the buttings and boundings of lands, east, west, north, and south, with respect to the places by which they are limited and bounded. The *sides* of the land are properly said to be *adjoining*, and the ends *abutting*, to the thing contiguous. For other applications of this term, see the articles that follow.

BOUNDARIES OF BOROUGHES, CITIES, AND TOWNS in England, are settled by the 5 and 6 Will. IV. c. 76, ss. 7 and 8, which refers to and adopts, for the purpose of such boundary, the regulations of the 2 and 3 Will. IV. c. 64—amended, however, by the 5 and 6 Will. IV. c. 103. These boundaries are generally the same as the parliamentary limits. The corresponding Scotch law on this subject is contained in the 3 and 4 Will. IV. c. 76, which adopts the limits prescribed in the 2 and 3 Will. IV. c. 65.

By the 7 Geo. IV. c. 64, it is enacted that where, in England, any felony or misdemeanour shall be committed on the boundary or boundaries of two or more counties, or within the distance of 500 yards of any such boundary or boundaries, or shall be begun in one county, and completed in another—every such felony and misdemeanour shall be dealt with and tried in any of the counties.

BOUNDARIES OF PARISHES are determined by ancient and traditional circumstances, as to which, see **PARISH**, and see **BEATING THE BOUNDS**. It may also be observed that by numerous acts of parliament lately passed, for extending church accommodation, and making more effectual provision for the cure of souls, it is conditionally provided that any part or parts of any parish may be constituted a separate district for spiritual purposes, or parish *quoad sacra*, as it is called in Scotland; and that any parish may also be divided into two or more

distinct and separate parishes for all ecclesiastical purposes. And many such parochial arrangements have been made. See the acts above referred to in vol. i. of Stephen's *Com.*, p. 122, notes c, d, e, and f.

BOUNDARY SURVEY OF IRELAND. This important subject is provided for and regulated by these acts of parliament—the 6 Geo. IV. c. 99, 17 Vict. c. 17, 20 and 21 Vict. c. 45, and the 22 and 23 Vict. c. 8, which are all to be read as one act. The boundary surveyor may alter the names of lands erroneously named in the ordnance map of any county, on the application of the owners of such land, who are to state the ground on which such application is made. And the same surveyor may define the boundaries of parishes divided under certain acts of parliament. The publication in the *Dublin Gazette* of the surveyor's report, referred to in the order of the lord-lieutenant in council, is to be discontinued, on the ground of its being unnecessary and expensive; and in lieu thereof, any person desirous of seeing the report and ordnance plans, may see them at the council office, in Dublin, at all reasonable hours, without fee or reward. See **ORDNANCE SURVEY** and **SURVEY**; and see **IRELAND**.

BOUND-BAILIFF, in England, is an officer of the sheriff whose duty is to discover and arrest debtors. As the sheriff is responsible for the misconduct of these bailiffs, they are annually bound in an obligation, with sureties, for the due execution of their office, and are, in consequence, called *bound-bailiffs*, a name which Blackstone is at pains to inform us 'the common people have corrupted into a much more homely appellation'—*bum-bailiff*. See **BAILIFF**.

BOUNDING CHARTER, in the Scotch law, is an instrument of title which describes the lands thereby conveyed by their boundaries or limits. It gives right to everything within the bounds, and, on the other hand, it excludes what lies beyond these. If the boundary be the sea or the sea-shore, the right is extended or limited as the sea recedes or advances. If, again, it be a stream or river, the property may be subject to alteration, either extended by *alluvion* (q. v.), or by the gradual and imperceptible variation of the channel; or the stream may cease to be the boundary, in consequence of some violent change. But if the property described in the charter is bounded by walls, the walls, as a general rule, will not be held as included in the grant; and where it is intended that a wall is to be mutual, this must be expressed. When the grant is described both by boundaries and by measurement, the boundaries determine its extent, although containing a larger quantity of ground than the measurement. The lands, however, may be described simply by reference to a plan, and this is a conveyance which makes a valid bounding charter. See Bell's *Principles of the Scotch Law*, Menzies's *Scotch Conveyancing*, and Bell's *Scotch Law Dictionary* by Ross. And see the following articles—**CHARTER**; **CONVEYANCE**; **LAND, TITLE TO**; and **GRANT**.

BOUNTY is a sum of money given to encourage men to enter the army or navy. In time of peace, when there is little or no need to augment the forces, the B. sinks to a minimum; but in cases of exigency, it is raised according to the difficulty and urgency of the circumstances. In the British army, no B. was paid to recruits until about half a century ago; the temptations offered to them, if any, were of some other character. The highest B. ever paid during the great wars against Napoleon was in 1812, when it amounted to £18, 12s. 6d. for limited service, and £23, 17s. 6d. for life; but these sums were in great part nominal, being subject to

many unfair and absurd deductions. Even so late as 1849, when the B. to an infantry recruit was nominally £4, he received little more than one-eighth of this amount, all the rest being swallowed up in fees and drawbacks of various kinds. At present, whether the B. be high or low, it is really paid to the man in cash. The young men who enter the British army are for the most part improvident and ignorant; they are tempted rather by immediates B. than by prospective pay and pensions; and thus it arises that the rate of B. varies frequently, while those of pay and pension undergo very little change. In 1855, it was £7 per head (for line infantry); in 1856, only £2; in 1858, £3; and it has since undergone further changes. It is always higher to the cavalry and artillery than to the infantry; and in the latter it is higher to the Highland than to the other regiments, on account of matters connected with dress and personal ornaments. The relation which the B. bears to the other emoluments of the soldier will be explained under ENLISTMENT, PAY, RECRUIT. In reference to seamen, the subject will receive elucidation under MANNING THE NAVY.—The term B. is also used in the navy to signify the payment and distribution of money to which the officers and crews of her Majesty's ships and vessels of war may, on particular occasions of active service, be entitled. See PRIZE, SALVAGE, BOOTY.

BOUNTY, a term applied to any sum granted by the legislature towards creating or encouraging some kind of undertaking believed to be of national importance. At one time there was no end to the giving of bounties in this way from the public purse—there were bounties on exporting corn, with a view to encouraging agriculture; on the tonnage of vessels employed in the herring and whale fisheries; on the importation of materials of manufactures; on the importation of indigo from the colonies; on the exportation of Irish linen, &c. The fallacy of this costly and factitious process for fostering commerce, manufactures, and agriculture, was amply demonstrated by Adam Smith in his *Wealth of Nations*; one of his more striking facts being, that every barrel of herrings which sold for 20s., cost the government about 25s. The notion that bounties may properly be given as an encouragement in the infancy of undertakings, is now exploded, along with numberless errors in a past political economy. It is ascertained that, besides taxing the general community in order to reward or encourage individuals, bounties do no real good to the parties so favoured; for by such inducements they engage in businesses for which they have no special vocation, or which, in existing circumstances, it would be preferable to let alone. Misdirection of capital, talent, and industry are, in short, the inevitable result of bounties, as of all measures alleged to be for the special protection of trade. The only kind of bounties which can be spoken of as remaining in Great Britain, are the large parliamentary grants to sustain certain steam-boat companies which perform the mail-service; as, for example, the Cunard Company, as it is called. But on the subject of these grants there are differences of opinion. By some, they are defended as payment for a service which would not otherwise be so well performed; while by others it is asserted that they defeat competition, and are so much money thrown away.

BOUNTY OF QUEEN ANNE. See QUEEN ANNE'S BOUNTY.

BOUQUET OF WINE is the peculiar flavour yielded by the better class of wines, and which is due principally to the presence of œnanthic ether (q. v.). See WINE.

BOUQUETIN, or **IBEX** of the Alps (*Capra Ibez*), a species of goat, which inhabits the highest regions of the Alps, even higher and wilder than those inhabited by the chamois, up to the limits of perpetual snow. It is the *Ibez* of the ancients. See IBEX. In German Switzerland, its name is *Steinbock*. It was at one time found on all the higher Alps, but has disappeared from most of them, and exists chiefly on those between the Valais and Piedmont, where it is carefully protected by the Sardinian government. It is larger and more powerful than the common goat, and has a small head and great horns (those of the male 1½—2 feet long), which curve backwards, are directed a little outwards, and have prominent transverse knots or bands on the front. The horns of the females are only about six inches long. The hoofs are large, rough on the sole, and capable of being spread widely apart, to give greater security of footing. The general colour is brown. The body is covered with two kinds of hair, the longer hair being mixed, at least in winter, with thick soft wool. There is no beard, except a few hairs in winter, although the animal has been often incorrectly figured as having one.

The B. feeds on the herbage and small shrubs which are found on the last confines of vegetation, and descends by night to browse in the highest forests, the lichens and branches of which supply much of its winter food. It is capable of enduring



Bouquetin.

great cold, and will remain, with seeming indifference, for hours on the summit of a rock, motionless, during the most severe storm. It possesses an extraordinary power of bounding from crag to crag, and of ascending or descending almost perpendicular precipices. Even the projections of a wall of rough masonry have been seen to suffice for the feet of a tame one to take hold of. One has also been known frequently to spring from the ground, without a race, and plant itself on a man's head. Tschudi rejects as a fable the statement which has been repeated by one naturalist after another, from the days of Gesner, that the B. throws itself down precipices, so as to fall upon its horns, their elasticity preserving it from injury.

When taken young, the B. is easily tamed. It readily associates with common goats, and breeds

BOURBON.

with them, and the hybrids produce young, of which, however, it does not appear that in any case both parents have been ascertained to be hybrids.

Whether this animal might not be made useful to the inhabitants of such countries as Iceland and Greenland, no one seems to have thought of trying.

BOURBON, ILE DE, an island in the Indian Ocean, the southernmost of the Mascarene Isles, lying about 100 miles south-west from Mauritius, and 360 miles east from Madagascar. It is one of the most important of the insular colonies of France. It has an area of about 950 square miles, being about 38 miles in length, and 28 in its greatest breadth. Pop. 172,000, including some hundreds of Chinese, 6000 negroes, 34,500 Indians, and a garrison, and other officials, to the number of about 2000. It may be described as one great mountain mass, of which the highest peaks are the Piton de Neiges—in the centre of the island, rising more than 10,000 feet above the sea—the Grand Bernard, and the Cimandef, in the north, with respective heights of 9500 and 7300 feet; and in the south-east, the Piton de Fournaise, 7200 feet high, one of the greatest volcanoes in the world, and one of the most active, its eruptions taking place at least twice every year, and its lava-streams sometimes reaching to the sea. This volcano occupies perhaps one-sixth of the island, often changes its crater, and is surrounded by a district of more than 10,000 acres, which is a dreary desert, and is called the *Pays Brûlé* (Burned Land). Except in this part, however, the soil is in general extremely fruitful. About a fourth part of the island is cultivated, chiefly along the coast, although much of the interior is of great natural fertility. The scenery is very beautiful. Streams, although not large, are very numerous, and rush in cascades to the sea. The climate, which was once mild and salubrious, is now very unhealthy to Europeans, who cannot reside four or five years on the island without an attack of typhoid fever or dysentery. The south-east monsoon and hurricanes often make fearful devastation. The plants of Arabia, of the Asiatic Archipelago, and of the south of Europe, succeed equally well here; coffee and cloves are produced, along with the fruits of Italy and Spain. The trade is estimated at about two millions sterling. By far the most important article of export is sugar; and the cultivation of the sugar-cane has of late years greatly increased. Next to sugar is coffee. Rice, maize, and tobacco are also cultivated. Cloves, saltpetre, wood for cabinet-making, and dye-woods, are the other principal exports. The value of the exports has of late greatly increased. The cereals grown in the island are not sufficient for its own wants. Cattle are imported from Madagascar. The capital of the island, and seat of government, is St Denis, on the north-west coast, with 9000 inhabitants, a college, a botanic garden, &c. Lat. 20° 52' S., long. 55° 30' E. The mean temperature here is 77° F. There is an almost total want of harbours, the whole coast of the island possessing only two tolerable anchoring-places—one at St Denis, and another at St Paul, 18 miles further south. The coast is consequently very dangerous. In one year, 1843—1844, no less than 11 large vessels were wrecked. B. and Mauritius were discovered by the Portuguese navigator, Mascarenhas, and named after him, the Mascarene Isles. After the French had begun their attempt to found a colony in Madagascar, they took possession of B. in 1649, giving it that name, which was changed to Réunion at the Revolution, and to Isle Bonaparte in 1809. The name has been varied according to the political changes in France. The French having also taken possession of Mauritius in 1720, which

they then named Isle of France, the Mascarene Isles were placed under one governor. In 1810 they were taken by the British, but B. was restored to France in 1814.

BOURBON, a French family of the highest note in history, and which came to possess several European thrones, derives its name from the castle and seignory of Bourbon, in the former province of Bourbonnais, in the centre of France. The first lord or *sire* of this family, of whom history makes mention, was Adhémar, at the beginning of the 10th century. The fourth in succession from him, Archambaud I., added the name of the family castle to his own. Under his successors, who also bore the name of Archambaud, the family possessions were soon very much increased. At length the seignory of Bourbon having devolved upon an heiress, who, in 1272, married Robert, the sixth son of Louis IX. of France, thus passed to a branch of the royal family of the Capets, under whom it was converted into a duchy. The principal branch of this family was, in 1523, deprived of all its dignities and possessions, because the duke, Charles de B. (q. v.), the famous Constable, allied himself with Charles V. against Francis I. of France.

Of the collateral branches, that of Vendôme acquired great importance, first attaining by marriage, in the person of Antoine de B., Duke of Vendôme, to the throne of Navarre; afterwards by inheritance to the throne of France, in the person of Henry IV., on the extinction of the male line of the House of Valois; and by the fortune of war to the thrones of Spain and Naples. Among the numerous other collateral branches may be mentioned those of Montpensier, De la Marche, Condé, Conti, Soissons, and Orleans. Only a few members of the collateral lines, however, have borne the name of B.; for example, the Cardinal Charles de B., Duke of Vendôme, who, under the name of Charles X., was set up by the Catholic League as a rival king to Henry IV. The ducal dignity was revived by Louis XIV. in the House of Condé, so that the eldest son of that House should bear the title of Duke of Bourbon.

The dynasty of the Bourbons in France begins with Henry IV. (q. v.), who, after the assassination of Henry III., became, in virtue of the Salique law (q. v.), the next heir to the French throne. Through his father, Antoine de B., king of Navarre and Duke of Vendôme, he was descended from Robert, son of Louis IX., and husband of Beatrix, heiress of Bourbon. On his assassination in 1610, he left, by his second wife, Mary de' Medici, five legitimate children: 1. Louis XIII. (q. v.), his successor on the throne; 2. J. B. Gaston, Duke of Orleans (q. v.), who died in 1660, and left no male heirs; 3. Elizabeth, married to Philip IV. of Spain; 4. Christina, married to Victor Amadeus, afterwards Duke of Savoy; 5. Henrietta, married to Charles I. of England.—Louis XIII., on his death in 1643, left two sons by his queen, Anne of Austria: 1. Louis XIV. (q. v.), his successor; and 2. Philip, who received from his elder brother the title of Duke of Orleans, and was the founder of the family which has become the younger B. dynasty.—The Dauphin Louis, styled Monsieur, the son of Louis XIV. by his marriage with Maria Theresa of Austria, died on 14th April 1711, and left three sons by his marriage with Maria Anna of Bavaria: 1. Louis, Duke of Burgundy (q. v.); 2. Philip, Duke of Anjou, who afterwards became king of Spain, as Philip V.; 3. Charles, Duke of Berri, who died in 1714.—Louis, Duke of Burgundy, died in 1712. By his wife, Maria Adelaide of Savoy, he had three sons, of whom two died in early youth, the only one who survived being Louis XV.,

who succeeded his great-grandfather, Louis XIV. in 1715.—Louis XV. having married Maria Leszczyńska, daughter of the dethroned king Stanislaus of Poland, had by her a son, the Dauphin Louis, who married Maria Theresa of Spain, and died in 1765, leaving three sons: 1. Louis XVI. (q. v.), who succeeded his grandfather, Louis XV., in 1774; 2. Louis Stanislaus Xavier, Count of Provence, afterwards Louis XVIII.; 3. Charles Philippe, Count of Artois, afterwards Charles X.—Louis XVI. had three children by his queen, Marie Antoinette of Austria: 1. the Dauphin Louis, who died in 1789; 2. Louis, called Louis XVII. (q. v.), who died in 1795; 3. Marie Therese Charlotte, styled Madame Royale, afterwards Duchesse d'Angoulême (q. v.).—Louis XVIII. had no children; but Charles X. had two sons: 1. Louis Antoine de B., Duke of Angoulême (q. v.), who was dauphin prior to the Revolution of 1830, and died without issue in 1844; 2. Charles Ferdinand, Duke of Berri (q. v.), who was murdered in 1820. The Duke of Berri left two children: 1. Marie Louise Therese, styled Mademoiselle d'Artois, married to the Duke of Parma; 2. Henry Charles Ferdinand Marie Dieudonné, Duke of Bordeaux, now styled Count de Chambord, the representative of the elder branch of the Bourbons, now exiled from France, and whom the French Legitimists sometimes designate Henry V.

It has already been stated that the founder of the Orleans or younger branch of the B. royal family of France, was Philip, Duke of Orleans (q. v.), the younger brother of Louis XIV. He died in 1701, leaving, by his second marriage with Elizabeth Charlotte of the Palatinate, a son of his own name as his heir, who was Regent of France during the minority of Louis XV. His son, Louis Philippe, Duke of Orleans (born 1703), married a princess of Baden, and died in 1752, leaving an only son of his own name (b. 1725, d. 1785), whose son and heir was that Louis Joseph Philippe, Duke of Orleans (q. v.), so notable in the French Revolution, who in 1792 renounced his rank, taking the name of Citizen Egalité, and died by the guillotine in 1793. He left four children: 1. Louis Philippe (q. v.), who, before the Revolution, was styled Duke of Chartres—that being the ordinary title of the eldest son of the Orleans family—became afterwards Duke of Orleans, was King of the French from 1830 to 1848, and died in England on the 26th of August 1850; 2. the Duke de Montpensier, who died in England in 1807; 3. the Count de Beaujolais, who died at Malta in 1808; 4. Adelaide, styled Mademoiselle d'Orleans, b. 1777, d. 1847.—Louis Philippe left a numerous family by his queen Amelia of Naples; but his eldest son, Ferdinand, Duke of Orleans, lost his life by an accident on the 13th of July 1842, leaving by his wife, the Princess Helen of Mecklenburg-Schwerin, two sons, the eldest of whom, Louis Philippe Albert, now styled Count of Paris, is the representative of the younger or Orleans B. family.—Concerning the other members of Louis Philippe's family, see the article LOUIS PHILIPPE.

Louis XIV. having succeeded in placing his grandson, Philip, Duke of Anjou, on the throne of Spain in 1700 as Philip V., this prince became the founder of the Spanish B. dynasty, as well as of the B. dynasties of Naples, Parma, and Piacenza. These dynasties endured only a temporary overthrow from the policy and arms of Napoleon Bonaparte. Philip V. was succeeded on the Spanish throne by his son, Ferdinand VI., who died without issue in 1759, and the crown fell to his brother, Charles III., whose son and successor, Charles IV., was compelled to resign it in 1808, in favour of

a successor nominated by Napoleon, and died at Rome in 1811. The two eldest sons of Charles IV. by his marriage with Maria Louisa of Parma were—1. Don Fernando, Prince of Asturias, who, after the overthrow of Napoleon, ascended the Spanish throne as Ferdinand VII. (q. v.), and whose eldest daughter is now queen of Spain; 2. Don Carlos (q. v.), who, on the death of his elder brother in 1833, became pretender to the Spanish throne, until 1845, when he resigned his pretensions in favour of his son, Count de Montemolin. He died at Trieste, 1855. The Count de Montemolin, and his brother Ferdinand, in 1860, renounced all claim to the throne of Spain. See SPAIN.

Philip V. did not succeed in keeping possession of the crown of the Two Sicilies (q. v.) as of that of Spain; the House of Hapsburg effecting its own restoration there in the person of a son of Leopold I., who in 1720 ascended the throne as Charles III. But in consequence of the peace of Vienna, the son of Philip V. became king of the Two Sicilies, likewise by the name of Charles III. Upon his accession to the throne of Spain in 1759, he gave up that of Sicily to his third son, Don Fernando, called Ferdinand IV., with the express stipulation that it should never again be occupied by a king of Spain. Ferdinand IV. was compelled to yield to the French arms in 1806; but after the overthrow of Napoleon, he became king of the Two Sicilies, and was styled Ferdinand I. (q. v.). His son, Francis I., succeeded him in 1825, and died in 1830, leaving the throne to his son, Ferdinand II. (q. v.), whose son, Francis II., is the present king.

By the peace of Aix-la-Chapelle in 1748, Austria made over the duchies of Parma and Piacenza to Don Philip, the youngest son of Philip V. of Spain, but with stipulation of their reversion to Austria on the failure of his male descendants, or on his succeeding to the throne of Spain. He was succeeded in 1765 by his son, Ferdinand I., whose son, the hereditary Prince Charles Louis Ferdinand, was made king of Etruria in 1801, under the guardianship of his mother, Maria Louisa of Spain; but Etruria being soon incorporated with France, they were completely dispossessed. The Congress of Vienna assigned Parma and Piacenza for life to Maria Louisa of Austria, the spouse of Napoleon, but meanwhile indemnified Maria Louisa of Spain with the duchy of Lucca. In 1847, Parma and Piacenza reverted to the B. family, in the person of the former king of Etruria, Charles Louis de B., who had succeeded his mother in Lucca in 1824. He abdicated on March 14, 1849, and was succeeded as Duke of Parma and Piacenza by his son, Charles III., and he in 1854 by his son Robert—born 1848—whose mother, Maria Louisa Theresa de B., daughter of the Duke of Berri, then became regent of the duchies. The B. family lost these duchies in 1859. See ITALY and PARMA; and see Coiffier-Demoret, *Histoire du Bourbonnais et des Bourbons* (2 vols., Par. 1828); Achaintre, *Histoire Chronologique et Généalogique de la Maison Royale de Bourbon* (2 vols., Par. 1825).

BOURBON, CHARLES, DUKE DU BOURBONNAIS, styled CONSTABLE DE BOURBON, born 1489, was the son of the Count of Montpensier; and in consequence of the death of his elder brother, and his marriage with the only daughter of the Duke of Bourbon, he united in his own possession the vast estates of both these branches of the Bourbon family. Holding a very high position in virtue of his birth and wealth, he soon shewed himself to be no ordinary character, by the brilliancy of his exploits in arms, and by his rigid morals and severe taciturn disposition. At the age of 26, he received from Francis I. the Constable's sword, and was sent

to Italy at the head of an army, which he disciplined on the march; and crossing the Alps by passes previously deemed impracticable, he surprised the hostile generals, won the battle of Marignan (1515), and within a few days placed the keys of the citadel of Milan in the king's hand, acquiring for himself by these exploits the reputation of the greatest general of his time. But Maria Louisa, the king's mother, became enamoured of the brave Constable; and he, although a widower, declined her hand, openly declaring that he deemed her a woman devoid of modesty, and not to be thought of for a wife. Her revenge led to the seizure, on behalf of the crown, of the estates which he had acquired through his wife, and the withholding of his pay as Constable. Thus deeply injured, he renounced the interest of France, and concluded a private alliance with the Emperor Charles V., and with Henry VIII. of England. The former agreed to give him in marriage his sister, Eleonora, who had Portugal as her jointure, and to make an independent kingdom for him of Provence and Dauphiné, with his own possessions of the Bourbonnais and Auvergne. The rest of France was to be apportioned between the two confederates. The king, who was engaged in an expedition to Italy, received intelligence of this conspiracy. Forthwith he proceeded in person to the Constable, and offered him restoration to favour and also of his estates. The Constable, however, did not trust him, but fled in disguise, and reached Franche Comté in 1523. In order not to appear as a fugitive to the Spanish army, which awaited him in Lombardy, he drew around him 6000 German lancers, and soon contrived to gain their entire attachment. He attacked, in 1524, the French army on its march over the Alps, and thought to have advanced to the heart of France with the Spaniards, whose general he had been appointed by the emperor. But Charles V. did not entirely trust him, and appointed the Marquis of Pescara to assist and watch him. He was compelled to relinquish the siege of Marseille, on the approach of Francis I. with a great army. He repossessed the Alps, and took his revenge in the battle of Pavia, 24th February 1525, where the king was made a prisoner. He now went to Madrid, but soon found himself entirely disappointed in his hopes, and was sent back to Lombardy by Charles V. Without money or support, surrounded by daring and mutinous bands, he conceived a plan to found for himself an independent dominion of his own, and to unite himself with France against Spain. Hastily gathering together the wild bands around Milan, he led them against Rome; and on 6th May 1527, unprovided with things necessary for a siege, appeared before the walls of that city. Resolved to conquer or die, he led up his troops in the most impetuous manner, and eagerly seized with his own hands a scaling-ladder, in order to make his way over a weak place of the walls, when he was mortally wounded by a bullet, which Benvenuto Cellini afterwards asserted that he had shot. His death was kept secret for a time from the storming army under his command. When it departed from Rome two months after, his corpse, which the soldiers would not part with, was taken with them, and buried at Gaeta, under a magnificent monument, which, however, was afterwards destroyed.

BOURBONNAIS, a gently undulating, terraced district in the centre of France, northward of the high lands of Auvergne, abounding in grain, fruits, wine, iron, marble, and mineral springs. From 1327 to 1523, it formed the duchy of Bourbon, and afterwards, becoming a domain of the crown,

it formed a separate province of France. It now constitutes the department of Allier, and part of the department of Cher. The capital was Moulins.

BOURBONNE-LES-BAINS, a town of France, in the department of Haute-Marne, about 20 miles east-north-east of Langres. It is pleasantly situated at the confluence of the Borne and the Aspance, and has some fine promenades and manufactures of cotton hosiery and cutlery. Its chief feature, however, is its saline springs, which range in temperature from 121°—136° F., and are much resorted to by people suffering from chronic complaints or old wounds. Pop. 3458.

BOURDALOUE, LOUIS, one of the greatest pulpit orators of France, was born at Bourges, 20th August 1632, and having, at the age of 16, entered into the order of the Jesuits, obtained in succession the chairs of Humanity, Rhetoric, Philosophy, and Theological Ethics in the academy of his native place. He shewed a great capacity for science, but his remarkable powers of eloquence led his superiors finally to determine upon employing him as a preacher. Disdaining the inflated style prevalent among the tasteless pulpit orators of his time, he assailed with manly vigour and truly religious earnestness the passions, weaknesses, and errors of men. The dignity of his manner and the fire of his eloquence made him famous even when the public mind was occupied with the festivities of Versailles, the victories of Turenne, and the literary masterpieces of Corneille and Racine. At the court of Louis XIV. he was remarkably well received. After the revocation of the Edict of Nantes, he was sent to Montpellier in 1686, to labour among the Protestants on behalf of the Roman Catholic Church. B. particularly understood how to accommodate his eloquence to the minds of those whom he addressed. Simple among the simple, a dialectician among ecclesiastics, he was equally a favourite with the common people and with the learned and the great. He was also much esteemed and beloved as a man; and in all circumstances, maintained unimpeached a high reputation for candour and honesty. In the later years of his life, he relinquished the pulpit, and devoted his time to hospitals, prisons, and pious institutions. He died at Paris 13th May 1704. How thoroughly his religious sentiments were governed by the theological tenets of his church, may be perceived from these remarkable words which he uttered on his death-bed: 'It is highly reasonable that God be fully satisfied; and at least in purgatory I will suffer with patience and with love.' Several editions have appeared of the collected works of B. (as 16 vols., Versailles, 1812, and most recently in the *Pantheon Littéraire*, 3 vols., Par. 1838). The best edition of his sermons is that published under the care of Bretonneau (16 vols. and 18 vols., Par. 1707—1734). His life was written by Madame de Pringy.

BOURDON DE L'OISE, FRANÇOIS LOUIS, a notorious character of the French Revolution, was born in the middle of last century at Saint Remy, near Compiègne, and became a procurator in the parliament of Paris. He helped to storm the Tuileries on 10th August 1792. He shortly afterwards obtained a seat in the Convention by a trick, presenting himself as the regularly elected deputy for the department of Oise, in which he had actually been defeated by a namesake who was elected also for that of Loiret. The trick was subsequently discovered, but he was not ejected. B. contributed much to bring about the execution of Louis XVI., the insurrection of 31st May, and the destruction of the Girondists. He was sent to La Vendée, where, however, he loudly condemned the revolutionary

crudelties, and appeared in the character of a moderate. Obnoxious on this account to Robespierre and Hébert, and fearing for his head, he urged on with the greatest eagerness the overthrow of the Terrorists on the 9th Thermidor (27th July 1794). From this time forth, B. shewed himself an enemy of the clubs, and a protector of the nobles and the priests. In consequence of the insurrection of 13th Vendémiaire (5th October 1795), he was sent as commissioner to Chartres, where he behaved harshly and brutally. He passed from the Convention into the Council of Five Hundred, became a persecutor of the republicans, and joined a royalist club. The Directory placed him upon the proscription list after the 18th Fructidor (4th September 1797). He was transported to Cayenne, where, in a short time, he died in great misery, tortured with remorse.

BOURGELAT, CLAUDE, founder of the first veterinary school, and consequently the first to institute a distinct profession of veterinary surgeons. Born in Lyon in 1712, he died there in 1799. He was a learned lawyer, an able writer, and the bosom-friend of the great D'Alembert, enjoying also the esteem of Pembroke, Voltaire, Buffon, and Haller. He was instigated to further the cause of veterinary science from a natural liking for horses, and conceived the idea of educating men to alleviate their infirmities and those of other domestic animals. In the execution of this project he found a friend and collaborator in a minister of Lyon, Bertin; and in 1761, the first veterinary school was opened in the suburbs of the city. It was patronised by royalty, and students flocked to it from all parts of France, Italy, Switzerland, Germany, Sweden, and Denmark. Probably the only dark spot in B.'s veterinary career is his treatment of Vial de St Bel, who, persecuted by his colleagues in France, came to England, and founded the St Pancras College, Camden Town, London, in 1792. B. had, however, endowed the Lyon school with so much vital energy that it has maintained itself in the foremost ranks. From it all other colleges in Europe sprang, and with them it has kept pace, being superior to the majority, and rivalling the very best, even those of Paris and Berlin.

B. wrote much—his works on Farriery, *Materia Medica*, External Form, Contagious Diseases, and on the various apparatus and bandages used for quadrupeds, being still highly esteemed.

BOURG-EN-BRESSE, a town of France, capital of the department of Ain, pleasantly situated on the left bank of the Reyssousse, about 20 miles east-south-east of Macon. It is well built, has several public fountains, a statue to Bichat, the celebrated anatomist, who was a student at the hospital here, a museum, a fine corn-market, and a public library of 19,000 volumes. The distinguished astronomer, Lalande, was a native of B. It has manufactures of linen, cotton, hosiery, and leather, and a trade in agricultural produce. The town was captured by the allies in 1814. Pop. 8144.

BOURGEOISIE, a French term, but now not infrequently employed in English, German, and other languages. It denotes the citizens of towns as a rank or class of society, including persons from the condition of heads of manufacturing or mercantile establishments, down to master-tradesmen. The French B. have long been extremely hostile to the aristocracy, but have themselves latterly become the object of attack on the part of the operatives and of the extreme radical or red republican party. The term *bourgeois*, from which B. is formed, is quite distinct in meaning from *citoyen*, the latter term designating a citizen of the state.

BOURGES, the capital of the department of Cher, in France, situated in a fertile plain at the confluence of the Auron and the Eure, 123 miles south of Paris. B. is divided into an old and new town, the latter being built round the former. Its houses are of antique architecture, and its streets crooked and dirty. It was formerly surrounded by ramparts flanked with high towers, some of which still remain; but the ramparts have been converted into promenades, with avenues of chestnut, walnut, and mulberry trees. B. has one of the noblest Gothic cathedrals in Europe, lighted by 59 splendid painted windows. Its university, suppressed at the Revolution, enjoyed great reputation. It has manufactures of woollen, cutlery, beer, &c., and a trade in hemp, grain, and porcelain. Pop. 19,434. B. is a place of great antiquity, being the *Avaricum* of the Gauls, in the country of the *Bituriges Cubi*. Taken by Cæsar in 52 B. C., it was afterwards named *Biturica*, and became the capital of the Roman province of *Aquitania Prima*. In the middle ages, it was the capital of the province of Berri. Charles VII. had his residence at B., when almost all France had been taken from him by the English; and its Hôtel de Ville was originally the abode of his unfortunate minister, Jacques Cœur. Louis XI. was born at B. Of the seven ecclesiastical synods held at B., that of 1438—in which the Pragmatic Sanction of the Gallican Church was established with approbation of Charles VII., and the resolutions of the Council of Basel, relative to the limitation of the papal power and the security of the king's prerogatives, were confirmed,—was the most important.

BOURIGNON, ANTOINETTE, a celebrated religious visionary, born at Lille 13th January 1616. Her father was a merchant, and she inherited from him a considerable patrimony. She was so ugly an infant, that there was some thought of killing her as a monstrous birth. Her intellect, however, was very acute, and its powers were early developed, along with a tendency to religious mysticism, which was much encouraged by the reading of mystic books, till her imagination became inflamed, and she began to fancy that she saw visions, conversed with God, received special revelations, and was called to restore the pure spirit of the gospel. By the good offices of the Archbishop of Cambrai, she obtained admission into a convent, where she won over some of the nuns to her opinions, and soon found herself at the head of a considerable party. She afterwards had charge of a hospital at Lille, but from this position she was driven in consequence of her extravagant fancies. She now travelled through various countries, her enthusiasm gaining proselytes, whose conversion, she said, caused the pains of childbirth in her person. At last she was appointed head of a hospital in East Friesland. She died at Franeker 30th October 1680. According to Madame B., religion consists in internal emotion, and not in either knowledge or practice. Her own character exhibited a strange combination of pride and avarice, with a sort of mystic piety. She never gave anything to the poor, alleging as a reason that she had consecrated all to God. Some of her pretended revelations were of the most indecent nature; many of them were extremely ridiculous; yet many persons of intelligence and learning believed in them, and adopted the peculiar form of mysticism which soon began to receive the name of Bourignianism. Among the chief expounders of it was Peter Poiret, a Calvinistic minister. It spread to a remarkable extent both among Roman Catholics and Protestants; and about the end of the 17th c., and beginning of the 18th, prevailed so much in Scotland, that a solemn renunciation of it was demanded from every entrant on

the ministry at his ordination. A minister of Aberdeen was deposed for it in 1701. The formal renunciation of Bourgnianism is still continued in the Established Church of Scotland, but has been given up as needless by other Presbyterian churches. The works of Madame B. were edited by Poirêt (25 vols., Amst. 1676—1684; 2d edit. 1717). They exhibit not a little fiery eloquence.

BOURMONT, LOUIS AUGUSTE VICTOR DE GAISNE, COUNT DE, a French marshal, and the conqueror of Algiers, was born in 1773 at his paternal castle of Bourmont, in Anjou, went into exile at the Revolution, served as an officer in the army of the Prince of Condé, and from 1793 to 1796 was actively engaged in the anti-revolutionary struggle in La Vendée. Subsequently, he obtained the favour of the First Consul. Under the Empire, he was appointed to a colonelcy in the army of Naples, and was soon raised to the rank of brigadier-general. In the campaigns of 1813 and 1814, he distinguished himself upon a number of occasions, particularly in the battle of Dresden, and by the defence of Nogent, upon account of which Napoleon promoted him to the rank of a general of division. On 31st March 1814, he declared for the Bourbons, and received the command of a military division during the first Restoration; yet, on Napoleon's return, he went over to him, and was intrusted with the command of a division of the army of the Moselle. On the evening before the battle of Ligny, he deserted, and betook himself to Louis XVIII., at Ghent. There can be no doubt that B. was singularly ungenerous in choosing such a moment to resign, nor is there anything in his career to make us suppose he was actuated by any high principle in what he did. His evidence went a considerable way in bringing about the condemnation and execution of Marshal Ney. He received high military employment under Louis XVIII. Distinguishing himself in the Chamber of Peers as a zealous supporter of the king, he was appointed minister of war in 1829, and in this office displayed great activity. When the expedition against Algiers was undertaken in April 1830, he received the chief command of the troops, and the rapid success of the expedition was ascribed to his prudence and energy. For this he received the marshal's baton on 22d July, but on the revolution taking place in that month, he was superseded in his command, and went to England to share the exile of Charles X. Refusing to take the legal oath, he was struck off the lists of the French army and peerage in 1832. In 1833, Don Miguel of Portugal placed him at the head of his troops, but the campaign was brief and unsuccessful. B. finally settled on his estate in Anjou, and died there in October 1846.

BOURNE, HUGH, the founder of the sect of Primitive Methodists, was born 3d April 1772 at Fordhays, in Staffordshire. Originally a preacher among the Wesleyan Methodists, he distinguished himself by the fervour of his religious sentiments, and by the zeal which he displayed for the conversion of the ungodly. His enthusiasm for 'revivals' and open-air meetings, however, received no countenance from the leading clergymen of the denomination to which he belonged. In 1808, B. was cut off from the Wesleyan connection, strange to say, for following much the same course of earnest evangelisation as Wesley himself had done. He was not, however, alarmed. His preaching was wonderfully acceptable, and he quickly gathered round him many devoted adherents. In March 1810, a committee of ten members was formed. This may be regarded as the first official organisation of the body. In 1818,

B. published in the *Primitive Methodist Magazine*, a narrative of his labours and of those of his coadjutors. In the course of his life he visited Scotland, Ireland, Canada, and the United States, where his ministrations were attended with great success. He died at Bemersley, in Staffordshire, 11th October 1852.

BOURNE, VINCENT, one of the most elegant Latin versifiers that England ever produced, was born about the close of the 17th century. In 1714, he entered Trinity College, Cambridge; in 1721, he took his degree of A.M., and subsequently he was appointed usher in Westminster School. He died December 2, 1747. It would be difficult to praise too highly B.'s exquisite contributions to Latin poetry. They will stand comparison, not only in point of Latinity, but also in point of originality, with the choicest productions of the ancient Roman poets. A gracefulness which pervades thought, sentiment, and expression, is their essential characteristic. The subject is indeed often insignificant, but the treatment is always perfect. His translations of English ballads and other lyrics into Latin are wonderfully felicitous, every beauty being retained with the most delicate skill, and every defect being most carefully remedied. Cowper, Beattie, Charles Lamb, and others have expressed their admiration of B.'s singularly fine *genius*, for assuredly a gift so rare as that which enables a man to find a complete utterance for his ideas in a dead tongue, deserves the name. The first edition of B.'s poems appeared in 1734. Their number was enlarged in a subsequent edition.

BOURNOUSE is the Arabic name of a garment worn in Algeria, Marocco, and other parts of North Africa. It is a large woollen mantle, worn above the other attire of the natives, and having a hood, which is thrown over the head in rainy weather. The B. is generally white, though distinguished individuals wear it of various colours—blue, green, red, &c. It has been long in use among the Spaniards under the name of *albornoz*. Through the conquest of Algeria by the French, the B. was imported into France and England, although its original form has been considerably altered.

BOURRIENNE, LOUIS ANTOINE FAUVELET DE, the secretary and early friend of Napoleon I., was born at Sens, 9th July 1769, and received his education in the military school at Brienne, where he formed the closest intimacy with the future emperor. He became, in 1792, secretary to the embassy at Stuttgart. Deprived of this office by the breaking out of war, he lived for some time a rather retired life, until, in 1797, his former school-fellow appointed him his secretary. He accompanied him to Egypt and to Italy, and in 1801 was nominated a councillor of state. In 1802 he was dismissed from his office, for being implicated in the dishonourable bankruptcy of the house of Coulon, army-contractors; but in 1805 he was appointed ambassador to the States of the Circle of Lower Saxony, and in this capacity resided long at Hamburg. His tendency to speculation, however, necessitated his return to France, where he had to refund 1,000,000 francs into the public treasury. He now decidedly joined the party which sought the overthrow of the emperor and the restoration of the Bourbons. He was treated with little consideration by them during the first Restoration, yet he followed Louis XVIII. in his flight to the Netherlands upon Napoleon's return, and upon the second Restoration was honoured with the title of a minister of state. As deputy from the department of Yonne in 1815 and 1821, he shewed his weakness of character by opposing all

liberal measures, and even institutions for the promotion of science and popular education. The revolution of 1830, and the loss of his fortunes (occasioned by extravagance), caused his reason to give way, and he died in a lunatic asylum at Caen, 7th February 1834. His Memoirs concerning Napoleon, the Directory, the Consulate, the Empire, and the Restoration (*Mémoires sur Napoléon, &c.*, 10 vols., Par. 1829), gave many new explanations of the events of his time, but were declared by contemporaries to be in many respects untrustworthy. See the article BOULAY DE LA MEURTHE. The work, however, is one which must always constitute an important part of the materials of history. A work entitled *Histoire de Bonaparte par un Homme qui ne l'a pas quitté depuis 15 Ans*, has been erroneously ascribed to him.

BOUSSA, a town of Sudan, Central Africa, capital of a district of the same name, is situated on an island in the Niger, in lat. 10° 14' N., and long. 5° 20' E. It is hemmed in by rocks, and being also surrounded by walls, is a place of very considerable strength. Population estimated at from 10,000 to 18,000. A melancholy interest attaches to B. as being the death-scene of Mungo Park (q. v.).

BOUSSINGAULT, JEAN BAPTISTE JOSEPH DIEUDONNÉ, a French chemist, particularly distinguished for investigations relative to agriculture, was born at Paris, 2d February 1802, attended the mining school at St Etienne, and went in the employment of an English mining company to South America; where, besides his professional and scientific labours, he served as a colonel under Bolivar in the South American war of liberty. Returning to France, he was appointed professor of chemistry at Lyon, and in 1839 was admitted into the Institute, and appointed to the chair of agriculture in the Conservatory of Arts and Measures, Paris. In 1848, he was elected a member of the Constituent Assembly, and voted with the moderate Republicans. After the *coup d'état*, he retired from political life. In 1857, he was made commander of the Legion of Honour. His *Economie Rurale* (2 vols., Par. 1844; 2d ed., Par. 1849) embodies the result of experiments and investigations which have won for him a European reputation. It contributed much to the promotion of the infant science of agricultural chemistry, and has been translated into English (Lond. 1845) and German. B. is the author of numerous valuable papers in scientific periodicals, which were collected and published in 1854, and is one of the authors of a report on the means of discovering the presence of arsenic in cases of poisoning (Par. 1841).

BOUSSOLE STRAIT passes through the Kurile Islands, uniting the Sea of Okhotsk and the Pacific Ocean. Lat. 46° 30' N. It takes its name from one of the vessels of La Prouse, who, soon after Cook's death, nobly emulated, on the north-east coasts of Asia, that navigator's explorations on the north-west shores of America.

BOUSTROPHE'DON (Gr. *bous*, an ox, and *strephe*, I turn), a word used to describe a mode of writing practised by the Greeks in the earlier period of their history—viz., in which the lines did not proceed uninterruptedly from left to right, but alternately, the first line being written from right to left, the second from left to right, &c. Examples are frequently found in coins and inscriptions. The method received its name from its resemblance to the path made by oxen in ploughing a field.

BOUTERWEK, FRIEDRICH, a German philosophical and æsthetical author of merit, was born

on 15th April 1766 at Oker, near Goslar, in the Harz district. He at first devoted himself to the study of law; but in the second year of his academic course at Göttingen he relinquished it, imagining that his proper vocation was to be a poet. Besides poems, he wrote the romance of *Count Donamar* (*Graf Donamar*, 3 vols., Gött. 1791—1793; 2d ed., 1798—1800). Not finding, however, that success which he expected in this career, he renounced it, and devoted his whole energies thenceforth to the study of philosophy and of the history of literature. In philosophy, he was at first a zealous follower of Kant, but afterwards adopted the system of Jacobi. He began to give lectures in Göttingen in 1791, and became extraordinary professor of philosophy in 1797, and ordinary professor in 1802. He produced several works on philosophy; but his great work, on which his reputation really depends, is his *History of Modern Poetry and Eloquence* (*Geschichte der neuern Poesie und Beredsamkeit*, 12 vols., Gött. 1801—1819), one of the best works of its kind which Germany has produced. The part relating to Spanish literature is especially valuable, and has been translated into Spanish and much enlarged by Jos. Gomez de la Cortina and Nic. Hugelde de Molinedo (3 vols., Madrid, 1828). B. died at Göttingen in 1828.

BOUTS-RIMÉS (Fr. 'rhymed endings') are a kind of verses the making of which forms a social amusement. Some one of the party gives out the rhymes or endings of a stanza, and the others have to fill up the lines as they best may. Suppose the rhymes prescribed are *wave, lie; brave, die*; the following are two of the ways in which the lines might be completed:

Dark are the secrets of the gulging	wave,
Where, wrapped in death, so many heroes	lie;
Yet glorious death's the guerdon of the	brave,
And those who bravely live can bravely	die.

Whenever I sail on the	wave,
O'ercome with sea-sickness I	lie;
I can sing of 'the sea,' and look	brave;
When I feel it, I feel like to	die.

BOUVET, JOACH, a learned French Jesuit, who was sent by Louis XIV. to China, to acquire information concerning that country, which he reached, along with five other missionaries, in July 1686. Being invited to Peking, the missionaries received permission to disperse themselves over the whole Chinese empire, except B. and Gerbillon, who were required to remain in attendance upon the emperor, the famous Kanghi, whose respect and confidence they soon acquired in a high degree. He committed to them the erection of great buildings, and was so pleased with their performances, that he not only caused a church and a residence for them to be built within the bounds of his palace, but commissioned B. to return to his native country, and to engage as many missionaries as he could find. B. arrived in France in 1697, and brought with him, for the king, about fifty Chinese works. He returned again to China in 1699 with ten new missionaries, amongst whom was the learned Parenin. He died at Peking, June 28, 1732, after having laboured indefatigably in the cause of science, in that distant scene, for 50 years. He has left four different accounts of his various travels, and a work entitled *Etat Présent de la Chine, en Figures Gravées, par Griffart* (Par. 1697).

BOVEY COAL is a form of wood-coal or lignite, which derives its name from being found at Bovey, in Devonshire.

BOVIDÆ (Lat. *bos*, an ox), a family of ruminating

mammalia (see RUMINANTIA), to which different limits have been assigned by different naturalists, but which is generally regarded as equal in extent to the Linnaean genus *Bos*, or to what is popularly called the ox tribe. The B. are all large animals, with stout limbs and broad muzzle. The facial outline is nearly straight. Their dentition agrees with that of some of the other ruminants, as sheep, goats, and antelopes: they have eight cutting-teeth in the lower jaw, and none in the upper, but instead of them, a fibrous and elastic pad, which covers the convex extremity of the anterior maxillary-bone; they have no canine teeth, but a large interval between the cutting-teeth and the grinders, which are six on each side in each jaw. In eating, they collect and roll the grass together 'by means of the long and movable tongue; it is firmly held between the lower cutting-teeth and the pad, the cartilaginous upper lip assisting in this; and then, by a sudden nodding motion of the head, the little roll of herbage is either torn or cut off, or partly both torn and cut.' Both sexes are furnished with unbranched tapering horns, which are directed more or less laterally, and generally upwards and forwards, and are usually curved throughout their whole length. There are, however, breeds of the common ox, in which both sexes are destitute of horns. The tail is rather long, and terminated by a tuft of long hair. The females have four teats. All the B. are gregarious. Native species are found in Europe, Asia, Africa, and North America. Fossil remains of species which no longer exist have been found in Pliocene and Pleistocene deposits. The number of existing species is by no means certain; as, besides the difficulty of deciding in some cases what are to be deemed species and what merely varieties, there is still a great deficiency of accurate information concerning the B. of different parts of the world. The very magnitude of the animals has probably prevented so frequent a comparison of specimens as would otherwise have taken place. It has recently been ascertained that the number of species is more considerable than had been supposed. Attempts have been made to divide the genus *Bos* into several genera, but they are not very clearly nor strongly distinguished. All the B. are valuable to man, for their flesh, tallow, skin, &c.; but some of them, having long been reduced to domestication, are among the most valuable of all domestic animals, particularly the common ox, different kinds of buffalo, and the yak of Tatar.—See ARNEE, BANTENG, BISON, BUFFALO, GAUR, GAYAL, GALLA OX, MUSK OX, OX, PEGASSE, URUS, YAK, ZAMOUSE, ZEBU, &c.

BOVINO, a fortified town in the province of Capitanata, Naples, about 20 miles south-south-west of Foggia. It is the see of a bishop, has a cathedral, churches, and convents. The valley of B. was formerly notorious as the haunt of the brigands of Capitanata, and the town still enjoys the unenviable reputation of being the nursery of all the highway robbers of this portion of the Apennines. Pop. 5700. B. occupies the site of the ancient *Vebinum*. The Imperialists defeated the Spaniards here in 1734.

BOW, of a ship, is a general name for the fore-part, or that which breaks the waves. Very often the word is used in the plural, the ship being considered to have starboard and larboard, or right and left bows, meeting at the prow or figure-head. A narrow or *lean* bow, and a broad or *bluff* bow, are seamen's phrases for different shapes of bow, each of which has its own peculiar advantages at sea: a narrow bow will cut more smoothly through the

water, but a broad bow bears up more firmly in a high sea.

'On the bow,' in sea-language, is the position of a distant object when seen over the bow; it implies a sweep of one quarter of the horizon, embracing about 45° on each side of the prow or head.

BOW AND ARROW. In ARCHERS AND ARCHERY will be found a brief account of the military arrangements under which bowmen formed a component element in the armies of the middle ages; and under ARBALEST is a description of the cross-bow, which was once so favourite a weapon. We here describe the more effective, though simpler implement. The long-bow first gained ascendancy in England in the 14th century. It was found that a dozen arrows could be discharged from this weapon while the arbalester was winding-up his cumbersome cross-bow, and discharging one arrow or quarrel from it. Moreover, the long-bow being held vertically, the bowmen were able to stand in closer array than the arbalesters; they were enabled also to take a greater supply of the munitions of war into the field, seeing that the bow and arrows were much lighter in weight. In the time of Edward III., a bow was priced 1s. to 1s. 6d., and a sheaf of arrows, 1s. to 1s. 2d.; in the time of Henry VIII., the price (fixed by law) of the bow varied from 6d. to 3s. 4d. The last-named monarch adopted extraordinary means for encouraging the use of the long-bow. Many ordinances were issued for insuring a good supply of bow-staves. The bowyers, string-makers, fletchers, and arrow-head makers were all placed under stringent regulations. Merchants were compelled to import good bow-staves with cargo, in certain proportions. Very long bow-staves were admitted duty-free. Yew was considered the best wood; but in order that the supply should not be too speedily used up, bowyers were ordered to use elm, ash, and wych-hazel in certain proportions to yew. The heads of families were bidden to provide bows for their sons and servants; and town-councils or officers were required to provide shooting-butts just outside each town. Some of the bows had two arches, connected by a middle straight piece. The best length was regarded as about 5 feet 8 inches from neck to neck; but in earlier times, some of the bows were much longer. The first arrows were made of reeds; these materials were afterwards superseded by cornel-wood; but the wood finally adopted as the best was ash. The arrows had heads pointed with steel, sometimes barbed to render their action more terrible. They were feathered with portions of goose-wing. The best length for a bow of the above-named size was set down at 2 feet 3 inches. Sometimes the arrows were tipped with combustibles. The best makers of arrow-heads, as well as bows, were compelled by law to go from town to town, to exercise their craft wherever it was most needed. The Bowman usually carried 24 arrows, called a sheaf, or a quiver, at his right side or at his back; besides others in his girdle. He kept his bow in a case; hence Falstaff's comparison of Prince Hal to a bow-case, in allusion to his slenderness. Bowmen, in their hours of sport, used arrow-heads called *rigged*, *creased*, *shouldered*, and *spoon-headed*, according to the shape.

The circumstances attending the decline of the use of the long-bow are narrated in the articles above cited.

BOW ISLAND, an island of coral formation in the South Pacific, the largest in the Low Archipelago, being about 30 miles long and 5 miles broad. It can only be approached by a small opening in the reef at the north end. Within the lagoon, the

anchorage is safe. The east side is well wooded, but the west is low and barren. Pearl-oysters and other shell-fish abound in the lagoon. The inhabitants are few, ill-looking, and indolent, with a partiality for raw food. The island was first discovered in 1768 by Bougainville, who gave it the name of La Harpe, which Cook, who visited it in the following year, changed to the name it now bears.

BOWDICH, THOMAS EDWARD, an enterprising African traveller, born at Bristol in June 1790, was first engaged in trade in his native city, but afterwards appointed a writer in the service of the African Company. Selected, in 1816, to conduct a mission to the king of Ashantee, he published an account of it in 1819, 4to. On his return to Europe he resided for some years in Paris. To obtain funds for a new expedition into the interior of Africa, he published a translation of Mollien's *Travels to the Sources of the Senegal and Gambia*, and other works, and in August 1822 sailed from Havre. He died of fever on the river Gambia, January 10, 1824. A profound scholar and accomplished linguist, B. was a member of several literary societies both in England and on the continent.

BOWDITCH, NATHANIEL, an American astronomer of some note, born 26th November 1773, at Salem, in Massachusetts. He shewed at a very early age a great inclination for mathematics, in which he afterwards made great proficiency, without ever attending a university. He was at first bred to his father's trade of a cooper, and afterwards apprenticed to a ship-chandler. He acquired Latin that he might study Newton's *Principia*. He particularly devoted himself to the study of the practical applications of science. He went as supercargo of a merchant-ship in several long voyages, and added a thorough practical acquaintance with navigation to a theoretical knowledge of it. His work, *The American Practical Navigator*, was received with great favour. He published also an admirable translation of La Place's *Mécanique Céleste* (2 vols. Boston, 1829), to which he added valuable annotations. These works obtained for him marks of honour from scientific societies in Britain; and led to his being called to the professorship of mathematics and astronomy in Harvard College, in his native state, which situation, however, he declined, in order to enter the executive council of the state. He afterwards became manager of the Massachusetts Life Insurance Association, president of the Mechanics' Institute, and president of the Academy of Arts and Sciences in Boston. He died 16th March 1838.

BOWER (Ang. Sax. *bur*, a chamber). The 'ladies' bower,' a private apartment in ancient castles and mansions, used by ladies both as a parlour and sleeping-chamber.

Up, then, rose fair Annet's father,
Twa hours or it were day,
And he is gane into the bower
Wherein fair Annet lay.

Ballad of Lord Thomas.—Percy's *Reliques*.

BOWERBANKIA, a genus of Zoophytes (q. v.), of the class *Polyzoa* or *Bryozoa*, order *Infundibulata*, the structure of which has been very carefully studied in the common British species, *B. imbricata*, one of the most abundant zoophytes on the coasts both of England and Scotland. It grows on sea-weeds, corallines, stones, &c., between high and low water mark, or in no great depth of water, and forms branching tufts sometimes 1½ inch in height. The branches are smooth and transparent,

tubular, filled apparently with a granular fluid, and crowded with irregularly scattered clusters of delicate horny ovate or ovato-cylindrical cells, which are so transparent as to permit the most easy observation of their whole internal structure. The polypes which inhabit these cells are all connected with the tube of the branch, and so with the common life of the *polyzoidom*. Each, when fully expanded, is about one-twelfth of an inch in length, and has 10 finely ciliated tentacula. When alarmed, it contracts very rapidly, the tentacula being first drawn in, and then the body of the polype retracted into its cell.

The organisation is much higher than in many zoophytes. The mouth does not lead at once into the stomach, but into a funnel-shaped tube, which contracts into a gullet or *oesophagus*, *a* in fig., and ends in a globular gizzard, *b*, apparently provided with radiating muscular fibres, and intended for trituration of the food. The gizzard opens below into a bag, which is regarded as the true stomach, *c*, and is supplied with a fluid, regarded as bile, from minute follicles or sacs in its sides, which follicles are therefore regarded as representing the liver. From the upper part of the stomach, near the entrance from the gizzard, arises the intestine *d*, a straight tube which passes up by the side of the gullet, and terminates in an orifice outside the circle of tentacula; the structure thus exhibiting a strong resemblance to that of the Ascidian Mollusca. When the polype is retracted, the gullet is bent upon itself, and the tentacula are enclosed in a tube or sheath formed by the inverted integument. When the polype is vigorous and lively, the cilia of the tentacula are kept in active motion, apparently quite under control of the will of the animal, forming a kind of whirlpool to bring animalcules or organic particles into the mouth.

BOWER-BIRD, a name given to certain Australian birds of the Starling (q. v.) family, or *Sturnidae*, remarkable for their habit of making bower-like erections, called *runs* by the colonists of New South Wales, and for adorning them with gay feathers, rags, bones, shells, and such other white or brightly coloured objects as they can pick up. These bowers are not used as nests, but they appear to be places of much resort at the breeding-season in particular. The use made of them by the birds is very imperfectly understood; but their structure has been carefully examined, and fine specimens of them, transported with no little difficulty, have been deposited in the British Museum by Mr Gould, in whose work on the *Birds of Australia* an account of them was first given to the world. The bowers of the Satin B. (*Ptilonorhynchus holosericeus*) are built among the branches of some tree, and appear to be repaired and frequented from year to year. The base consists of an extensive and rather convex platform of sticks, firmly interwoven, on the centre of which the bower itself is built of more flexible twigs. It is chiefly at and near the entrance that the shells, feathers, &c., employed for decoration are placed. The bowers of the Spotted B. (*Chlamydera maculata*) are longer

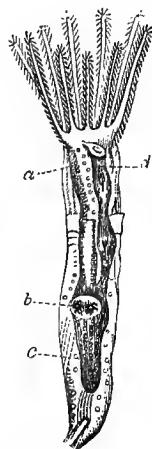

Bowerbankia imbricata,
Greatly magnified.

and more avenue-like than those of the Satin B.; they are placed upon the ground, and are outwardly built of twigs, and beautifully lined with

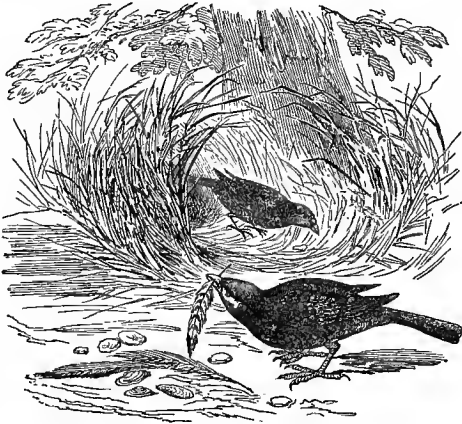

Spotted Bower-bird.

tall grasses so disposed that their heads nearly meet. The decorative propensity appears in the highest degree in this species. 'In some of the larger bowers, which had evidently been resorted to for many years,' Mr Gould says, 'I have seen nearly half a bushel of bones, shells, &c., at each of the entrances.' These are arranged in much the same way at both entrances. Small pebbles are often transported by the birds from considerable distances.

The Satin B. is particularly abundant in the mountainous districts of the west of New South Wales, and is found in all the 'brushes' from the mountains to the coast. The adult male has the whole plumage of a deep, shining black. The colours of the female are grayish green and brown, curiously mingled.—The Spotted B., which is rather smaller than the Satin B., or about the size of a starling, has a general colour of rich brown, beautifully marked with black and buff; a band of elongated feathers of light rose-pink crossing the back of the neck, and forming a broad, fan-like, occipital crest. It is exclusively an inhabitant of the interior of Australia.—Another species, the Great B. (*Chlamydera nuchalis*), considerably larger than either of the others, and very similar in form and plumage to the Spotted B., has been found on the north-west coast of Australia. Its bowers are always adorned with sea-shells, even when at a distance from the sea.

BOWIE KNIFE, an American knife, so called from its inventor, Colonel Jim Bowie, a famous fighter with the rifle and other weapons, and altogether one of the most daring characters in the southern states of the Union. The B. K. is a sharp-pointed weapon, and is usually carried concealed in a sheath in the breast, or some other part of the person, ready for any encounter.

BOWING TOWARDS THE ALTAR is an ancient practice in the church, derived from a belief in the superior sanctity of the east. There are scriptural allusions to the east, from which notions of this kind may have been drawn. 'And, behold, the glory of the God of Israel came from the east.'—*Ezek.* xlili. 2. 'For we have seen his star in the east.'—*Mat.* ii. 2. There was also an early legendary belief that Christ would come to judgment in the east. For these,

not to mention other reasons, it became customary to place the altar, with the crucifix and other symbols, at the eastern extremity of the church, to which all bowed. In the Romish Church, the practice is still kept up of bowing towards the altar, or more correctly towards the Host, on entering and departing from the church. Brand's *Popular Antiquities*, edited by Sir Henry Ellis, contains much curious antiquarian lore on this subject. It was further a custom in the early Christian Church to bow at the name of Jesus. This is still done in the Church of Rome, at whatever part of the service the name occurs. In the Church of England, it is customary to bow at the name of Jesus only in repeating the *creeds*. This ancient usage is traced to *Phil.* ii. 10, 'That at the name of Jesus every knee should bow.' Punctilious bowings and turning towards the east in repeating the *creeds*, constitute at present one of the unhappy sources of disturbance in the Church of England.

BOWLES, WILLIAM LISLE, D.D., an English poet, was born 24th September 1762 at King's Sutton, in Northamptonshire, where his father was then vicar. He received his education at Winchester School, and at Trinity College, Oxford, and became at last a prebendary of Salisbury Cathedral in 1803, and Rector of Bremhill, in Wiltshire, in 1805. Here he spent, in comparatively affluent circumstances, the remainder of his long life. His poetical career began with the publication, in 1789, of *Fourteen Sonnets, written chiefly on Picturesque Spots during a Journey*. This unpretending little volume was received with extraordinary favour; the sonnets were fresh and natural, and to many minds, all the more charming because of the contrast which they presented to the style of poetry which had long been prevalent. Coleridge, Wordsworth, and Southey were among their enthusiastic admirers; and through the influence which he exercised over them, B. may be regarded as the founder of a school of English poetry, in which their names soon became greater than his own. The subsequent poetical works of B. are very numerous, of which *The Spirit of Discovery* and *The Missionary* are generally regarded as the best of his longer blank verse poems. As a poet, B. shews a fine appreciation of the beauties of nature, and pleases by the expression of pure and generous sentiment, as well as by playfulness of fancy and perfect scholarly correctness, but he is greatly deficient in vigour and depth. He published an edition of Pope's works in 1807; and an opinion which he expressed on the poetical merits of Pope, led at a subsequent period to a rather memorable controversy, in which Campbell and Byron were his antagonists, and which turned chiefly upon the comparative value in poetry of images derived from nature and those derived from art. B. was generally admitted to have discomfited his opponents. B. frequently employed his pen in defence of the Church of England, and endeavoured to vindicate all the peculiarities of the older English educational institutions. Of his prose writings may be mentioned a volume of sermons (Lond. 1826), and a rather dry *Life of Thomas Ken, deprived Bishop of Bath and Wells* (2 vols., Lond. 1830—1831). B. died at Salisbury on 7th April 1850, in the 88th year of his age.

BOW-LINE, in a ship, is a rope fastened near the middle of the perpendicular edge of the square sails by three or four subordinate ropes called *bridles*. It is employed to tighten the edge of the sail in a particular direction during an unfavourable wind.

BOWLS, GAME OF. This is a favourite pastime throughout the British Isles. It is played upon a

smooth, flat piece of turf, from 40 to 60 feet square, surrounded by a trench or ditch about half a foot deep. The players arrange themselves in sides, usually of four each, and each man is usually provided with two bowls. The bowls are made of lignum-vitæ wood, of 6 or 8 inches in diameter, nearly round, and with a bias to one side. A smaller ball, perfectly spherical, and white, is placed at one end of the bowling-green; this is termed the *jack*, and the aim of the players, who stand at the other end of the green, is to send their B. that they may lie as near as possible to the jack. The side whose B. are nearest the jack reckon one point for each bowl so placed. 7, 14, 21, or 31, make game, according to mutual arrangement beforehand. B. are biased or weighted on one side, that the player may reach the jack by a curved instead of a straight course, an expedient which the nature of the game renders particularly desirable. Indeed, were it not for this, the game would lack half its charms. A bowl is played *fore-hand*, when it is so placed in the hand and delivered as to cause it to approach the jack with a curve from the right; and in order to attain this curve, the bowl must be held so that its bias is on the left or in-side. Backhand is the reverse. If a bowl goes into the ditch without touching the jack, it cannot count in the scoring of that end; but if it strikes the jack, and then rolls into the ditch, it reckons as if on the green. When the jack is carried by a bowl into the ditch, it is usually lifted, and placed on the green as near as possible to its position in the ditch. When the B. have so accumulated round the jack, that it is impossible to approach it from either *side*, without running the risk of touching an adversary's bowl, the last player frequently endeavours to *run* the jack, by playing straight at it with such force as to neutralise the bias, and, if fortunate, carry away the jack from the neighbourhood of his opponent's bowls. A *skip* is appointed on each side, whose duty it is to direct each of his men.—For BOWLING at cricket, see CRICKET.

The game of B. was anciently unlawful, and was the subject of prohibitive legislation in England in the reign of Henry VIII.; but the law then enacted was repealed in 1845 by the 8 and 9 Vict. c. 109, s. 1, so that B. or other similar games of mere skill may be legally indulged in by the people.

BOWRING, SIR JOHN, an English politician, linguist, and author, was born at Exeter, 17th October 1792. He early devoted himself to the study of languages, in the acquisition of which he displayed an unusual degree of talent. The national poetry of different peoples had particular attractions for him, and he rendered great service to literature by collecting and translating both the more ancient and the more modern popular poems of almost all the countries of Europe. His translations preserve remarkably well both the meaning and the spirit of the original, and exhibit no mean powers of versification. B. was very intimately associated with Jeremy Bentham, who appointed him one of his executors, and intrusted him with the editing of his collected works. A descendant of the old Puritans, he early came forward in writing and speaking against the political disadvantages experienced by dissenters. He took part from the first in the *Westminster Review*, which was established in 1824, and edited it for about five years from 1825. In 1828, he visited Holland; and his letters—which appeared in the *Morning Herald*, and were shortly afterwards translated into Dutch—procured for him the degree of Doctor of Laws from the university of Groningen. Subsequent travels were undertaken by him, on a commission from the British government,

to inquire into the commercial relations of certain states. He visited Switzerland, Italy, Egypt, Syria, and finally the countries of the German Zollverein, and everywhere found materials for valuable reports. He was a member of the House of Commons from 1835 to 1837, and again from 1841 to 1849; and notwithstanding his relations to the government, he displayed great political independence, actively promoting the adoption of free trade. In 1849, B. was appointed British consul at Hong-kong, and superintendent of trade in China. He returned in 1853, and in the following year, the honour of knighthood was conferred upon him, and he was made governor of Hong-kong. In 1856, an insult having been offered to a Chinese vessel, said to have been under the protection of the British flag, B., without consulting the home government, ordered an attack on certain Chinese forts, a proceeding which excited considerable dissatisfaction in the country, and produced a ministerial crisis. B. has since returned to England. In 1855, he concluded a commercial treaty with Siam, and has given an interesting account of his visit to that country in a work, entitled *The Kingdom and People of Siam* (2 vols., Lond. 1857). In 1859, he published *A Visit to the Philippine Islands in 1858—1859* (1 vol. 8vo, Lond.).

BOW'SPRIT is a large boom, spar, or mast, which projects over the stem or head of a ship. Its use is to carry sail forward, as a means of counteracting the effect of the after-sails, and keeping the ship well balanced. It is also the chief support of the fore-mast, which is fastened to it by large stays or ropes. In ordinary ships of war, the B. rises at an angle of about 45° from the horizon, and is generally about two-thirds as long as the mainmast; but in many kinds of vessels the position is more nearly horizontal.

BOWSTRING HEMP, an English name, proposed by Dr Roxburgh, and partially adopted, for the fibre produced by *Sansevieria Zeylanica*, a plant of the natural order *Liliaceæ* (q. v.), tribe *Hemerocallææ*, a native of the East Indies. The employment of the fibre for making bowstrings led to this name. Dr Royle prefers to use the Sanscrit name *Moorva*, on account of the confusion apt to be caused by applying the term hemp to a variety of fibres.—The genus *Sansevieria* is distinguished by a coloured funnel-shaped perianth, with a long tube, into the throat of which the stamens are inserted, and a 3-celled and 3-seeded, or abortively 1-celled and 1-seeded, berry. The plants have a general appearance much like that of many species of *Iris*, but their leaves are more fleshy; they have a thick creeping rhizome or root-stock; the radical leaves are long and narrow, and the flowering-stems have only scale-like leaves.—Very similar to *S. Zeylanica* are *S. Roxburghiana* and *S. lanuginosa*, also natives of India.—These plants grow under bushes in jungles near the sea, where the soil is salt, but may easily be propagated on almost any soil by the shoots which issue in great abundance from the root-stock. They are perennial. The leaves are about 2 feet, or in cultivation 3 or 4 feet long; the fibres extend their whole length; and to separate the fibres from the pulpy part of the leaves, 'the natives place them on a smooth board, then press one end of the leaf down with one of their great toes, and with a thin bit of hard stick held between the two hands, they scrape the leaf from them, and very quickly remove every part of the pulp.' Steeping in water is also practised, but it discolours the fibre, which is beautifully white. One pound of clean fibre is obtained from about 40 lbs. of fresh leaves. Dr Roxburgh calculated that 1 acre would yield 1613 lbs. of clean fibre at a gathering, of which two might be reckoned

upon annually in good soil and favourable seasons, after the plants have reached a proper age. Moorva, or B. H., may well be supposed likely to acquire commercial importances. The fibre is hair-like and silky, elastic, and in strength apparently about equal to hemp. It does not rot in water so soon as hemp.—A species of *Sansevieria* very similar to the Indian ones, *S. Guineensis*, is found in abundance along a great extent of the west coast of Africa, specimens of the fibre of which, also fine and strong, have been brought to England under the name of AFRICAN BOWSTRING HEMP.

BOWYER, WILLIAM, an eminent English printer and classical scholar, born in London in 1699, was educated at Cambridge, and in 1722, joined his father in trade. Appointed, in 1729, printer of the votes of the House of Commons, he subsequently became printer to the Society of Antiquaries, and to the Royal Society. In 1767, he was nominated printer of the Rolls of the House of Lords, and the Journals of the House of Commons. He died in 1777. B. published several philological tracts, but his chief production was an edition of the New Testament in Greek, with critical and emendatory notes. He left a considerable sum in trust to the Stationers' Company, for relief of decayed printers. A small volume of anecdotes of B. and his learned contemporaries, published soon after his death by Mr John Nichols, his apprentice and partner, was afterwards enlarged, under the title of *Literary Anecdotes of the Eighteenth Century* (9 vols., 8vo).

BOX (*Buxus*), a genus of plants of the natural order *Euphorbiaceæ*; evergreen shrubs or small trees, with opposite leaves, entire at the margins, and easily split into two plates. The greenish inconspicuous flowers grow in little axillary clusters, the male and female flowers distinct, but on the same plant. The male flowers consist of a perianth of four leaves, and of four stamens; the female flowers have a perianth of three or four leaves, and in addition, three small bracts at the base, an ovary surmounted by three styles, and two honey-secreting glands. The capsule has three beaks and three cells, and two or three black seeds in each cell.—The most important species is the COMMON BOX (*B. sempervirens*), which grows wild in the south of Europe, and in some parts of Asia. It is generally



Common Box :
b, a, female flower.

regarded as a true native of the south of England, where it grows on dry chalky hills; and is remarkable as the only arborescent species of *Euphorbiaceæ* found in such cold latitudes. In Britain, it seldom

attains a height of more than 12 or 14 feet, but in warmer countries, it is often twice that height. Its leaves are oval, generally from half an inch to three-quarters of an inch in length, smooth and shining, of a deep green colour. The box is remarkable for its compact habit of growth and densely crowded branches and leaves, presenting a very solid mass of foliage. There are several cultivated varieties, distinguished by differently variegated leaves—gold-edged, silver-edged, &c. The most interesting variety, however, is a very humble one, called DWARF BOX, which grows only to a height of two or three feet, and is very commonly used to form edgings for garden-plots, being kept down by clipping to the height of a few inches. These edgings—than which none are neater, or better serve the purpose of keeping gravel-walks free from earth—are generally formed by planting cuttings, which readily strike root. The box bears clipping remarkably well; and in a style of gardening once fashionable, but condemned by the taste of the present day, it occupied an important place, being cut into architectural and fantastic figures. The leaves of the box have a smell which is disagreeable to many people, and a very disagreeable bitter taste. When taken inwardly, they cause purging; an external application of them promotes the growth of the hair. In France, they are sometimes used instead of hops in making beer, but are extremely improper for the purpose. The wood of the box is heavier than that of any other European tree, and is the only European wood that sinks in water. It is of a beautiful pale-yellow colour, remarkably hard and strong, of a fine regular and compact texture, capable of a beautiful polish, and not liable to be worm-eaten. It is much valued for the purposes of the turner and the wood-carver; is preferred to every other kind of wood for the manufacture of flutes, flageolets, and other wind-instruments, as well as of mathematical-instruments; and is unrivalled for wood-engraving, admitting of a finish as sharp and fine as metal, whilst it takes the ink much better. See ENGRAVING. When scraped down and boiled, it can be used as a sudorific in many complaints, and as a substitute for guaiacum. An empyreumatic oil, obtained from box-wood chips, is used for relief of toothache, and for other medicinal purposes.—Spain and Portugal send into the market large quantities of box-wood; also Circassia and Georgia, from which countries it finds its way to Odessa, and is again exported thence. In 1815, as many box-trees were cut down at Box Hill, in Surrey, as brought upwards of £10,000; but the tree is of so very slow growth, that it is seldom planted in Britain except for ornament.—The MINORCA BOX, or BALEARIC BOX (*B. Balearica*), a native of Minorca, Sardinia, Corsica, Turkey, &c., is a larger tree than the common box, and has leaves three times as large. It is much less patient of frost, but is occasionally seen in shrubberies in the south of England. The wood is of a bright yellow, and inferior to the true box-wood, but is brought in large quantities from Constantinople under that name, for wood-engraving.

BOX-DAYS. These are two days appointed by the judges of the Court of Session in Scotland, in the spring and autumn vacations, and one day in the Christmas recess, on which pleadings or other law-papers appointed by the court, or by one of the judges, towards the close of the preceding session, may be lodged or filed; the object being to expedite the procedure, notwithstanding the vacation or recess. These days are called B., in consequence of an act of sederunt or order of the Court of Session, dated the 29th November 1690, in which the evil custom of private solicitation of the judges is

complained of: 'For preventing whereof,' says the order, 'and for easing the leidges, themselves, and the lawyers, they, according to the example of the most famous judicatories abroad, have appointed boxes for every one of the lords, to stand on a bank in the Session-house from three o'clock till seven o'clock at night, each box having a slitt, in which the informations or bills may be lett in, and cannot be drawn out, untill the box be opened; the key whereof is to be kept by every judge himself, and to be committed to no other; and each lord is to send for his box at seven o'clock at night, that he may have competent time to peruse all the informations therein, and to consider the same, and the citationes alleged in the same, whereby none of the leidges can be put to trouble to attend any of the lords for geiving their informations, bills, or answers.' Further facilities for legal business in vacation-time are afforded in Scotland by the regulations of the *Bill-Chamber* (q. v.); and in England the equity and common law judges attend at chambers during vacation; but to English lawyers the use of B., or of any similar expedient, is unknown. See COURT OF SESSION and other COURTS.

BOX-HAULING is a particular mode of turning a ship, when the swell of the sea renders tacking impossible, or when the ship is too near the shore to allow room for veering. The operation is effected by a peculiar management of the helm and the sails. *Boxing-off* is an operation very similar to box-hauling. See further under TACKING, VEERING.

BOXING, or PUGILISM (Lat. *pugilatus*), fighting with the fists. It was practised as a manly exercise by the ancients, among whom it was an art so highly esteemed, that Pollux, Hercules, and some of the other gods were represented as having excelled in it. The pugilists of the ancient games had leather thongs on their hands, sometimes loaded with lead or iron; this armature of the hand was called the *castrus*. Of course, their combats were not unfrequently attended with fatal consequences, which have resulted also in many instances of modern pugilistic encounters, although no armature of the fists is allowed. Among the Greeks, the practice of B. was at first permitted only to freemen, no slave, or person attainted with crime, being considered worthy to possess the high privilege of being beaten to the consistency of a jelly. Gradually, however, B. was taken up as a profession, and its character deteriorated. B. has been a favourite amusement of Englishmen for centuries; it is even said to have had such distinguished patrons as King Alfred and Richard III. But the golden age of pugilism as a profession in England commenced with the accession of the House of Hanover; then men calling themselves professors publicly announced their intention of giving lessons in 'the noble art of self-defence.' One professor challenged another to combat in the most bombastic language. In 1726, one Ned Sutton, who announces himself as 'pipemaker from Gravesend, and professor of the noble science of defence,' sneers at another professor, whom he calls 'the extolled Mr Figg,' for having by 'sleeveless pretence' shirked a combat with him, 'which I take,' says the pipemaker and professor, 'to be occasioned through fear of his having that glory eclipsed by me, wherewith the eyes of all spectators have been so much dazzled.' He further assures the said Figg, that if he can muster courage enough to fight with him, he (Figg) 'will have the advantage of being overcome by a hero indeed!' Figg had an 'amphitheatre' in Oxford Road, wherein fights were held; and a larger one was erected in the same locality in 1742 for one Broughton, the funds being subscribed by

some eighty noblemen and gentlemen. The pugilistic encounters that took place here were patronised by many of the nobility. Some faint protests against the brutality of the pastime now began to be made by the press, but these had little effect. Towards the end of the last century, fights were patronised by princes of the blood-royal; and the Prince of Wales, afterwards George IV., was present at one at Brighton, in which one of the combatants was killed. When the allied sovereigns and their generals came over to England in 1814, Lord Lowther treated them to a series of B.-matches in his drawing-room, which were so highly relished that they were repeated a few days afterwards. One of the pugilists, called Jackson, became quite a hero, and made enormous sums by giving lessons to young noblemen, among whom was Lord Byron. In 1817, the Czar Nicholas of Russia witnessed a prize-fight at Coombe Warren. At the close, the victor was presented to him, with whom he shook hands. This was the last time that royalty was present at one of these disgusting spectacles.

The character of the prize-ring, or, as it is called in the slang of its supporters, 'the P. R.,' had been for many years declining. People of influence and respectability seemed to have withdrawn their countenance from it. The lowest and least reputable class of the population furnished the fighters, and money was the only object of their backers. 'Fair-play' was no longer 'a jewel' in the P. R.; fights were sold, and the meanest and most disgraceful tricks resorted to, in order to win or to avoid the payment of bets. Prize-fights were under the ban of the law; in many counties of England, the police actively interfered to prevent them; and some railway companies refused to convey those taking part in them along their lines. The year 1860, however, witnessed a strange revival of the pugilistic spirit, on occasion of a fight between Tom Sayers, the 'champion prize-fighter of England,' and John Heenan, the 'Benicia Boy,' an American, for £200 a side, and the belt, a badge of honour worn by the champion. The battle, which was elevated to the dignity of 'a great international contest' by sporting papers, took place at Farnborough, April 17, 1860. It lasted for more than two hours, in which time the American was beaten almost blind, and the Englishman dreadfully bruised. The continuance of the battle was prevented by the breaking in of the ring, caused by the interference of the police. After the fight, the English champion was ranked by many newspapers—not sporting ones—with the heroes of the Crimea and of Lucknow; hundreds, if indeed not thousands, of pounds were subscribed for him, in admiration of his bravery, by persons of all conditions of life, and residing in all parts of the country; and he was fêted by merchants on the London and Liverpool 'Changes. His opponent received equally flattering and substantial testimonials from Americans. The fight formed the subject of discussion in the House of Commons, in which the home secretary announced that not only the principals, but all present at the spectacle, were amenable to the law. Though no steps were taken to bring the offenders to justice, it was intimated to those chiefly concerned, that if a renewal of the fight were attempted, the law should be put in force against those aiding or abetting it.

The training which prize-fighters undergo for some months before a battle is of the most healthful kind; it rids them of every superfluous grain of flesh, braces their nerves, and makes their muscles like iron; yet, owing to the rude way in which the result of all this training is demolished in an hour's fight, professional boxers are usually very short-lived. With the exception of one, Gulley,

who became M.P. for Pontefract, and the Jackson already alluded to, who made a fortune, few of them have ever risen to anything above the ownership of a low public-house, where they lay down the law on pugilism to their admirers, and take the chair at so-called 'harmonic meetings,' where B. is the entertainment. Several papers devote themselves to chronicle the doings of the P. R., which they do in a peculiar style. The following specimens of the slang will afford a sufficient idea of the character of this kind of literature. The mouth is called the 'potato-trap,' the 'kisser,' the 'whistler,' the 'grubber,' and the 'oration-trap;' the nose is variously described as the 'claret-jug,' the 'smeller,' the 'sneezer,' the 'snorer,' the 'sniffer,' the 'proboscis,' the 'nozzle,' the 'snout,' the 'scent-bottle,' and the 'snuff-box;' the ear as the 'conk;' and the eyes as the 'daylights,' the 'peepers,' the 'squinters,' the 'goggles,' &c. Instead of saying that the eyes did not swell up, the *litterateurs* of the P. R. would say that the boxer 'did not seem inclined to adopt the early-closing movement with either shutter!'

BOXING-DAY, the day after Christmas, and so called in England from being the day on which *Christmas boxes*, or presents, are given to servants and others. See CHRISTMAS BOX.

BOXING THE COMPASS is one among many sea-phrases not easily traceable to their origin. It means simply a rehearsal or enumeration of the several points, half-points, and quarter-points of the mariner's compass, in their proper order; and is among the lessons which a young sailor has to learn.

BOXTTEL, a busy town of Holland, in the province of North Brabant, situated on the Dommel, six miles south of Bois-le-Duc. The river intersects the streets, affording passage for boats, and also supplies water to turn the machinery of several manufactories. B. is famed for the beautiful diapers it produces. Pop. 4000. The Anglo-Dutch army, under the command of the Duke of York, was here defeated with great loss by the French in 1794.

BOX-THORN (*Lycium*), a genus of plants of the natural order *Solanaceae*, having funnel-shaped or tubular flowers, and 2-celled berries. The species are pretty numerous, and found in different quarters of the world. Several are natives of the south of Europe, thorny shrubs, with long slender shoots and simple lanceolate leaves. *L. Europæum* may be trained to a height of 30 or 40 feet, and is often planted—as are also other species—for ornament, to cover walls, &c. It has pale violet-coloured flowers, reticulated with red veins. Some of the species are almost trees. *L. fuchsioides*, although destitute of spines, is used as a hedge-plant in its native country, the Andes of Quito. Its flowers are orange scarlet, and grow in umbels.

BOYA'CA, a town of New Granada, near which, in 1819, Bolivar, by a victory over the Spaniards, secured the independence of Colombia. It gives name to the department, which stretches from the plateau of Bogota to the borders of Venezuela, being watered by the Magdalena, Sogamozo, Zulia, Casanare, and Meta. The capital, however, is not B. itself, but the neighbouring city of Tunja, which is about 70 miles to the north-north-east of Bogota.

BOYARD. See BOJARDO.

BOYAU, in military engineering, is a winding or serpentine trench, dug to form a path or communication between the different armed trenches of a siege-work, and to prevent them from being enfiladed, or fired upon in flank.

BOY-BISHOP. The custom of electing a B. on St Nicholas's Day dates from a very early period.

Warton thought he could find some allusion to it in one of the anathemas of the Constantinopolitan Synod, 867 A.D. It quickly spread over most Catholic countries, and in England seems to have prevailed in almost every parish. Although the election took place on St Nicholas's Day (6th December), the authority lasted to Holy Innocents' Day (28th December). The B. was chosen from the children of the church or cathedral choir, or from the pupils at the grammar-school. He was arrayed in episcopal vestments, and, attended by a crowd of subordinates in priestly dress, went about with songs and dances from house to house, blessing the people, who, as Bishop Hall says, 'stood grinning in the way to expect that ridiculous benediction.' The B. exacted implicit obedience from his fellows, who, along with their superior, took possession of the church, and performed all the ceremonies and offices except mass. The custom found countenance not among the populace only. In 1299, Edward I., on his way to Scotland, permitted a B. to say vespers before him at Heton, near Newcastle-on-Tyne, and gave him and his companions a present. At Salisbury—and perhaps in other places also—the B., it is said, had the power of disposing of such prebends as happened to fall vacant during the days of his episcopacy; and if he died during his office, the funeral honours of a bishop, with a monument, were granted him. What secular shows and entertainments accompanied this practice, history does not inform us. Probably dramatic exhibitions of a rude nature were the principal. In England, the custom of electing a B. was abolished by a proclamation of Henry VIII., dated July 22, 1542; restored by Queen Mary in 1554; and again abolished during the reign of Elizabeth, though it seems to have lingered here and there in villages till about the close of her reign.

BOYD, ZACHARY, an eminent Scottish divine, born before 1590, was educated at Kilmarnock, and studied at the universities of Glasgow, and Saumur in France, of which latter he was, in 1611, appointed a regent or professor, and is said to have declined the principalship. The persecutions of the Protestants in France caused him to return to Scotland in 1621. In 1623, he became minister of the Barony parish, Glasgow, and was thrice elected rector of the university of that place. His principal prose work, *The Last Battell of the Soule in Death*, published at Edinburgh in 1629 in two vols., was reprinted, with a life of the author, by Gabriel Neil, Glasgow, 1831. He was author of eighteen other works, chiefly of a religious cast. The third edition of his *Psalms of David in Meeter* appeared at Glasgow, 1646. He died in 1653 or 1654, leaving numerous MSS. and his library, with a considerable legacy, to the College of Glasgow, over the court gateway of which is his stone bust, whilst his portrait is in the Divinity Hall of the same university. Among his MSS. is a collection of quaint poems on Scriptural subjects, entitled *Zion's Flowers*, usually called Zachary Boyd's Bible. As a specimen of his homely style, the following extract from Jonah's soliloquy within the whale's belly may be quoted here:

What house is this, where's neither coal nor candle,
Where I nothing but guts of fishes handle?
I and my table are both here within,

Where day neere dawned, where sunne did never shine;

The like of this on earth man never saw,
A living man within a monster's maw,
Buried under mountains which are high and steep,
Plunged under waters hundreth fathoms deep.

Not so was Noah in his house of tree,
For through a window he the light did see;

He sailed above the highest waves—a wonder;
 I and my boat are all the waters under;
 Hee in his arke might goe and also come,
 But I sit still in such a straitened roome
 As is most uncouths, head and feet together,
 Among such grease as would a thousand smother.
 I find no way now for my shrinking hence,
 But heere to lie, and die for mine offence,
 Eight prisoners were in Noah's hulk together;
 Comfortable they wers, each one to other.
 In all the earth like unto me is none,
 Far from all living, I heere lye alone.

BOYDELL, JOHN, a liberal patron of art in England, born in 1719. At the age of 21, he apprenticed himself for seven years to an engraver in London, and on the expiration of his apprenticeship, published, by subscription, a series of views in England and Wales, with the profits of which he set up a print-selling business in the metropolis. English engraving was at a low ebb when B. threw his money and intelligent energy into the work of its improvement. Under B.'s liberal patronage of native artists, the importation of foreign prints, for the most part, not only ceased, but English prints were exported to the continent. B. now determined to do for English painting what he had done for engraving. He accordingly selected Shakspeare's works for illustration; and in the carrying out of his object, secured the most eminent painters in the kingdom, including Opie, Reynolds, Northcote, and West. The result was the magnificent 'Shakspeare Gallery,' from which was engraved a superb volume of plates (Lond. Boydell, 1803). B. also published, at Bulmer's press, a splendid edition of Shakspeare's works in 9 vols. fol. (1792—1801). The immense sums of money he spent on the Shakspeare illustrations, and the commercial depression consequent on the French Revolution, brought him into difficulties, from which he was not wholly extricated before his death, in December 1804. An alphabetical catalogue of plates containing engravings by the best artists, from the finest works of the Italian, Flemish, German, French, and English schools; sketches from Claude Lorraine, &c., were among the collections published by Boydell.

BOYER, ALEXIS BARON DE, a French surgeon of the greatest eminence, was born at Uzerche, in Limousin, on 30th March 1757, or, according to others, in 1760. He was for some years in the service of a notary, before he began his medical studies. In 1787, he was appointed second surgeon to the Hôpital de la Charité at Paris, and afterwards professor, first of operative surgery, and then of clinical surgery, at the École de Santé. In 1804, he was appointed first surgeon to the emperor, who also raised him to the rank of baron. He accompanied the emperor on his campaigns and journeys. After the Restoration, B. became professor of practical surgery in the university of Paris, and first surgeon at the Hôpital de la Charité. In 1823, he was appointed consulting-surgeon to the king; and in 1825, was admitted a member of the Institute. He died on 25th November 1833. His greatest works are his *Traité Complet d'Anatomie*, 4 vols. (Par. 1797—1799, and other editions), and his *Traité des Maladies Chirurgicales et des Opérations qui leur conviennent*, 8 vols. (Par. 1814—1822). From 1798 to 1817, he was engaged with Roux and Corvisart in conducting the *Journal de Médecine, Chirurgie et Pharmacie*.

BOYER, JEAN PIERRE, a mulatto, president of the republic of Hayti, was born 2d February 1776, at Port-au-Prince, capital of that part of the island then belonging to France. At a very early age he was sent to France, where he received a European education; and in 1792, entered the

military service. He very soon became a *chef de bataillon*, and fought against the British on their invasion of his native isle. After further fighting against the British under General Rigaud, leader of the mulattoes, and afterwards under General Leclerc, he entered into a combination which had for its object the union of the negroes and mulattoes, and a complete emancipation of the colony. After the negro Dessalines had seated himself upon the throne, B., along with Péthion, took the lead of the coloured people. They assisted Christophe to overthrow the bloody tyrant in 1806; but deserted Christophe when they saw that he wished to make himself sovereign. Péthion now established an independent republic in the western part of the island; and B. made himself indispensable to him by his military and administrative knowledge, so that he was invested by the new president with the command of the capital, Port-au-Prince, and the rank of a major-general. In this capacity he endeavoured to discipline his troops after the European manner; drove back, more than once, the black hordes of Christophe, thereby preserving Port-au-Prince from destruction; was recommended to the people by Péthion, when dying, as most worthy to be his successor; and was unanimously elected president of the republic. He arranged the financial affairs, collected funds into the treasury, improved the administration, and encouraged arts and sciences. After the death of Christophe, he united the monarchical part of the island with the republic in 1820; and in 1821, the eastern district also, which had hitherto remained under the dominion of Spain; and he urgently sought the recognition of the independence of the youthful state by France, which was obtained, in 1825, upon payment of an indemnity of 150 millions of francs. B. carried on the government of the republic of Hayti for fifteen years, from this time, with the most perfect peace; but his policy, which was rather arbitrary, and directed to the object of depressing the negroes in favour of his own race, the coloured people, resulted in a victorious insurrection in 1843. B. fled to Jamaica, whence he announced his resignation to the Haytian revolutionary committee, and condemned himself to a voluntary ostracism. From the proclamation of the provisional government, it appeared that he was the victim of his aristocratic policy; but the provisional government, after it had obtained the upper hand, conducted itself very moderately towards the defeated party. See HAYTI. After a protracted stay in Jamaica, B. went to Paris, where he died in the beginning of July 1850. He was a man of great perseverance, and of captivating manners, but artful, and often harsh and cruel to those under him.

BOYLE, a town in Roscommon county, in a picturesque valley on both sides of the Boyle, one mile above its expansion into Lough Key, and 8 miles north-west of Carrick-on-Shannon. Pop. 3483. It has a large trade in corn and butter. There are Latin and English annals of B. from 420 to 1245, which have been published. An abbey was built here in the 12th c., and was reduced to its present ruined state in 1595 by the Earl of Tyrone.

BOYLE, RICHARD, the founder of the House of Cork and Orrery, and fitly styled the Great Earl of Cork, was born in 1566, at Canterbury, of a good but not wealthy family. At the age of 22, after having studied at Cambridge and the Middle Temple, he went over to Ireland with a few pounds in his pocket, to hew his way to fortune. His energy, prudence, and signal capacity for government, received their reward. He bought estates and improved them, promoting the immigration of

English Protestants, and triumphed over the envy of his enemies, making good his cause before Queen Elizabeth, and winning her favour. Due honours flowed in upon him, and at length he was knighted. In 1620, he became Viscount Dungarvan and Earl of Cork. In 1631, he was made lord high treasurer, an office which remained hereditary in his family. In his old age, the Munster rebels compelled him to gird on armour, and turn his castle into a fortress. He soon raised a little army of his servants and tenants, and with an auxiliary force commanded by his four sons (and paid, when his money was spent, out of his plate-chest), the noble old earl took castles, smote the rebels, and quenched rebellion in his borders. He died in 1644, at the age of 78.

BOYLE, THE HON. ROBERT, seventh son, and fourteenth child of the first Earl of Cork, was born at Lismore, Waterford, January 25, 1626. As a child, he was distinguished by precocity of intellect and a rare love of truth. After studying at Eton, and at home, he went to the continent, where he stayed for six years. On his return in 1644, he found himself in possession, by his father's death, of the manor of Stalbridge, Dorsetshire, where he took up his abode, and resided till 1650. He took no part in political strife, but devoted himself to the cultivation of science, and particularly of chemistry and natural philosophy. He was one of the first members of that association of scientific men which about that time (1645) held private meetings at Oxford and London, and some years after, became better known as the Royal Society. In 1654 he settled at Oxford. Here he experimented extensively in pneumatics, and improved the air-pump. At the same time, he devoted considerable study to theology. After the Restoration, he was urgently advised by Lord Clarendon to enter the church, but he thought that he could do better service to religion as a layman. Among the proofs which he gave of this, besides his own theological writings and eminent example, were his exertions as a director of the East India Company for the propagation of Christianity in the East, as well as in procuring and circulating at his own expense translations of the Scriptures, and his bequest for the foundation of the 'Boyle Lectures' (q. v.), in defence of Christianity. In 1668, he took up his residence permanently in London, and was thenceforth able to devote much of his time to the business of the Royal Society. In 1680 he was chosen president, but declined the honour. A peccage had repeatedly been offered to him, and declined. In 1688, finding his health decline, he shut himself up against all interruption, in order to husband his remaining time for the labour of repairing the loss caused by the accidental destruction of his MSS. In 1691, his health finally gave way, and on the 30th of December 1692 he died, seven days after his beloved sister, Lady Ranelagh. B. was tall and emaciated in person, and extremely temperate in his habits, often subject to low spirits, but naturally lively and of rare conversational powers. His piety, benevolence, and charity would have made him remarkable, apart from his scientific attainments and reputation. His complete works (including his very interesting correspondence), with a life by Dr Birch, and an index, were published in 5 vols. fol. (Lond. 1744).

BOYLE, CHARLES, third Earl of Orrery, was born at Chelsea, August 1676, and entered Christ Church, Oxford, in his 15th year, where he had for his tutors Drs Atterbury and Friend. His attainments as an undergraduate were respectable for a nobleman; and probably this circumstance

induced the master of the college, Dr Aldrich, to select the youth for the annual task of editing a classic. In B.'s case, it unfortunately happened that the *Epistles of Phalaris* were chosen, Sir William Temple having about that time passed the most extravagant encomiums upon them. In 1695 the work appeared. Two years later, Bentley published his famous *Dissertation*, in which he proved that the Epistles, instead of being composed in the 6th c. B. C., were the production of the 2d c. after Christ. B., in reality, had little to do with the unlucky performance to which his name had been attached. It was the work chiefly of Atterbury and Friend. Nevertheless, in the following year, and while B. himself was absent from the country, the wits and scholars of Christ Church again exposed him and themselves to the merciless criticism of Bentley, by publishing *An Examination of the Dissertation, &c., by the Hon. Charles Boyle*. In 1699 Bentley once more replied, and sealed the lips of his adversaries for ever. But for this *Battle of the Books*, in which he only seemed to be engaged, B.'s name would have been forgotten. In honour of him, the name of 'Orrery' was given to the scientific apparatus of that name by its constructor, to whom B. had been kind. He fought, as a major-general, at Malplaquet, was promoted to diplomatic and court appointments, wrote some literary pieces, and died in 1731. Of his poems, even Sir Richard Blackmore said:

After his foolish rhymes, both friends and foes
Conclude they know *who did not write his prose*.

BOYLE LECTURES, so called from the founder, the Honourable Robert Boyle (q. v.), who settled an annual salary, charged upon his dwelling-house in St Michael's, Crooked Lane, London, for 'some preaching minister,' who shall preach eight sermons in the year for proving the Christian religion against Atheists, Deists, Pagans, Jews, and Mohammedans, not descending to any controversies among Christians themselves. The lecturer is to be 'assisting to all companies, and encouraging them in any undertaking for propagating the Christian religion, and is further to be ready to satisfy such real scruples as any have concerning such matters.' This provision shews that Boyle desired to make England's then increasing colonies a means of extending Christianity.

The first series of lectures, *A Confutation of Atheism*, was preached in 1692 by Richard Bentley (q. v.). In 1705, Dr Samuel Clarke preached in answer to the arguments of Hobbes, Spinoza, and their followers. In 1709, Dr Butler lectured on 'Religion no Matter of Shame.' All the lectures preached up to 1732 were collected into a fine folio edition in 3 vols. (Lond. 1739); since that period, up to 1802, when Van Mildert, Bishop of Llandaff, delivered several courses, few of the series had been published. Archbishop Tension procured a yearly salary of £50, to be charged upon a farm at Brill, Bucks, instead of the original charge for the endowment. In 1846, the course of lectures was preached by the Rev. F. D. Maurice, and published under the title, *The Religions of the World*.

BOYLE'S FUMING LIQUOR is the term applied to a concentrated solution of ammonia, saturated by a stream of hydrosulphuric acid, which combining with it, forms the sulphide of ammonium (NH₄S). Exposed to the air, it fumes, and evolves a very disagreeable odour, resembling, but in an intensified degree, ordinary bilge or sewerage water.

BOYNE, a river in the east of Ireland, rises in the Bog of Allan, and flows through Kildare, King's County, Meath, and Louth. It passes Trim, Navan, Slane, and Drogheda, and enters the Irish Sea

4 miles below the last town, after a course of 65 miles in a carboniferous limestone basin, its total descent being 336 feet. Its chief tributaries are the Deel, Mattoch, and Blackwater. It is navigable for vessels of 250 tons to Drogheda, and for barges of 70 tons to Navan, 19 miles up. Its banks are studded with many ruins of monasteries and castles. In 838, Turgeisus the Dane sailed up the B., and plundered Meath. But this river is chiefly famous for the battle of the Boyne, which took place on its banks, near Oldridge, on the 1st of July 1690, and in which William III. defeated James II. An obelisk, 150 feet high, marks the scene of the battle.

BOYS, SHIPS'. In nautical language, all the young or green hands on board are called *boys*, without much reference to their age; but in recent times, arrangements have been made to give a more precise meaning to the term, by engaging boys or lads as part of the crew.

In the royal navy, boys were first voted for in the estimates in 1834. There were 1000 in that year; and this number increased to 6500 in 1860. The Admiralty has, in recent years, made many regulations for attracting boys into the navy. Most of the seamen at present in the service entered it as boys. They enter mostly at about 14 years of age, but some as late as 18, and they are bound for 7 years. There are schools established for them at Portsmouth, Plymouth, Cork, and one or two other places. The boys are ranked in three classes, according to age, size, and experience. When out of their time, they have a tendency to enter the merchant service for two or three years; but they usually return to the navy, and enter as ordinary seamen. See further under **MANNING THE NAVY.**

In the merchant service, boys are apprenticed to the shipowners; they learn their duties by degrees; and constitute the source out of which mates, masters, and captains are ultimately supplied. By the Merchant Seamen's Act of 1844, every merchant-ship was bound to take a certain number of boys as apprentices, according to tonnage; the better hands were apprenticed by their friends; the worst were picked up by the Marine Society from the poor and wretched of the streets, and apprenticed as a means of setting them up in life. The indenture was from 12 to 18 months. The regulations have been modified in form, but not in substance, by the Mercantile Marine Act of later date.

BOZZARIS, MARCOS, a Greek patriot who distinguished himself in the early part of the modern War of Independence, was born at Suli, in the mountains of Epirus, towards the close of the 18th century. His youth was spent amid the din of arms. In 1803, he was forced to retreat to the Ionian Isles, by Ali Pasha (q. v.), who, in a series of bloody combats, had nearly exterminated the Suliotes. In 1820 two events occurred which called forth his patriotic energies: Hypsilanti summoned the Greeks to insurrection, and war broke out between Ali Pasha and the sultan. On learning the news, B. put himself at the head of some 800 expatriated Suliotes, and passed over into Epirus. Ali, who dexterously endeavoured to identify his cause with that of the Greeks, soon found means to secure B.'s services against their common enemy, the sultan. B. obtained several victories, and on the death of Ali at the taking of Janina in 1822, he continued the war successfully against Khurshid Pasha, the Turkish general. Shortly after, Prince Mavrocordato landed at Mesolonghi, with a body of disciplined troops, and being joined by B., he engaged the Turks at Petta, on the 16th July 1822. Through treachery the Greeks were overpowered,

their best soldiers perished, and B., along with Mavrocordato, was compelled to retire to Mesolonghi. This place he skilfully defended against the Turks, until a Hydriote fleet forced them to retire. In the summer of 1823, a Turco-Albanian army of 20,000 men, under the command of the Pasha of Scodra, descended from the north of Epirus. B., who knew that the fortifications of Mesolonghi were too weak to withstand an assault, determined to surprise his enemies by a sudden blow. He advanced swiftly at the head of 1200 men, and on the 20th of August reached Kerpenisi, where the van of the Turco-Albanian army, 4000 strong, was encamped. At night, the Suliotes burst in upon their startled foes, who were routed with great slaughter. The victors captured their camp, standards, and a vast quantity of baggage. This triumph was saddened by the loss of the heroic B., who fell while leading on his men to the final attack. His body was solemnly interred at Mesolonghi, and he was honoured with the title of the 'Leonidas of Modern Greece.'

BOZZOLO, a town of Lombardy, North Italy, situated on the right bank of the Oglio, about 16 miles west-south-west of Mantua. B., which was at one time a small independent republic, has remains of old fortifications, some silk-weaving, and an annual fair. Pop. about 5000.

BRA, a town in the province of Alba, Piedmont, 25 miles south-east of Coni. It has metal foundries and silk manufactures, and a good trade in cattle, grain, and wine. Pop. 11,466.

BRABANÇONNE, the patriotic song of the Belgians, originally sung by the insurgents during the revolution of September 1830. A young French player, by name Jenneval, at that time connected with the theatre at Brussels, was the author of the song; it was set to music by a singer named Campenhout. Jenneval fell in a combat with the Dutch at Berchem. The Belgians allowed his mother a pension of 2400 francs. Campenhout received from King Leopold a golden snuff-box, and was appointed director of the royal chapel. Each verse of the B. ends with the refrain—

La mitraille a brisé l'orange
Sur l'arbre de la liberté.

BRABANT was the name formerly given to an important province of the Low Countries, extending from the left bank of the Waal to the sources of the Dyle, and from the Maas and the plain of Limburg to the Lower Scheldt. In the time of Cæsar, B. was inhabited by a mixed race of Germans and Celts; it afterwards came into possession of the Franks; and in the middle ages it formed a duchy by itself, dependent upon Lower Lorraine, with which, in 1107, the county of Antwerp was incorporated, and in 1347, for a time, the lordship of Mechlin or Malines, formerly connected with Liege. After many changes, B. (divided into the provinces of North and South B.) was made a part of the kingdom of Holland, at the Congress of Vienna; but at the revolution of 1830, South B. separated from Holland, and became part of Belgium (q. v.). Old B. is now divided into three provinces: 1. North or Dutch B., containing about 2000 square miles, and 411,950 inhabitants; 2. The Belgian province of Antwerp, which contains 1094 square miles, and 439,534 inhabitants; and 3. South B., also Belgian, containing 1260 square miles, and an extremely dense population of 761,404. The country consists of a plain gently sloping to the north-west, and rising in the south into gentle hills, which are offsets of those of Ardennes. In the level northern part are many heathy and fenny tracts;

one of them, called the Peel, 20 miles in length, and from 2 to 6 broad. In the hilly district of the south, is the Forest of Soignies. The Maas and the Scheldt are the principal rivers; but some of their tributaries, as the Rupel, the Dyle, the Demer, the Aa, &c., are also very useful for internal commerce, which is further promoted by canals and railways. The climate in the northern parts is humid, but generally mild, and careful drainage has made it more healthy than in any other part of the Netherlands; the soil is fertile, and agriculture and cattle-husbandry are the principal occupations of the inhabitants, and are prosecuted with great success. Many kinds of goods made of flax, cotton, wool, and leather, are among the products of industry. B. lace has long been celebrated. The inhabitants in the north are Dutch; in the middle district, Flemish; and in the south, of Walloon race. The boundary between the languages is a few leagues to the south of Brussels, the Walloon French being spoken to the south, and Flemish and Dutch to the north of this line.

BRACCIO, FORTEBRACCI, COUNT OF MONTONE, a celebrated condottiere (see **CONDOTTIERI**), born at Perugia in 1368, of an old patrician family, was, in early youth, the leader of a troop of mercenaries in the service of the Count of Montefeltro, against the Malatesti, lords of Rimini. He became the champion of the Perugian nobles who were driven into exile in 1393; and after serving in Lombardy under Alberico da Barbiano, he carried on a partisan warfare in the Marches of Ancona against the Marquis Ludovico Migliorati, nephew of Pope Innocent VII. In 1408, he entered the service of Ladislaus, king of Naples, who had designs on Central Italy, and, with his condotta, crossed the Apennines, scoured the valley of the Tiber, and took several towns. In June of the same year, the people of Perugia offered the dominion of their city to the Neapolitan king on condition that he would prevent the nobles from returning. He accepted it, and ungenerously sent a large force against B., who retired to the Marches. In 1416, however, B. obtained the sovereignty of his native city, when the banished nobles, after an exile of twenty-four years, were restored. In 1417, B. got possession of Rome by capitulation, but was soon obliged to evacuate it. He afterwards made terms with the pope (Martin V.), with whom he had a conference at Florence in February 1420, and subsequently accepted from Joanna, queen of Naples, the command of her land-forces, with the rank of high constable of that kingdom. Entering the Abruzzo, he surprised Capua, and having relieved Naples, then besieged by the queen's enemies, was created by her Count of Foggia and Prince of Capua. In 1423, B. was, by her order, crowned at Perugia, as Prince of Aquila and Capua. Aspiring to the throne of Naples, he overran Campania and Apulia with a considerable army, took Bari, and advanced into Calabria. In a battle which ensued for the relief of the strong town of Aquila, besieged by him, B. was wounded and taken prisoner. After lingering for three days, refusing food, he died June 5, 1424, in his 56th year. His deeds, in chronological order, and those of his contemporary, Piccinino, are commemorated by Lorenzo Spirito, in a poem of 101 chapters, in terza rima, entitled *L'Altro Marte* (Vicenza, 1489).

BRACE, in Carpentry, an oblique piece of wood used to bind together the principal timbers of a roof or other wooden structure. See **ROOF**.

BRACELET (Fr. *brachiale*, from Lat. *brachium*, the under part of the arm), an ornament worn on the arm, generally at the wrist. Bracelets and armlets (Lat. *armille*) have been used by every nation,

both savage and civilised, from the earliest periods to our own. They are frequently mentioned in Genesis, as worn both by men (xxxviii. 18) and by women (xxiv. 30); both by the Hebrews and the surrounding nations (Numb. xxxi. 50). Similar ornaments were worn round the ankles, but they are stigmatised by Isaiah as marks of luxury (iii. 16). The Medes and Persians were remarkable, even amongst Asiatics, for their love for ornaments of this class. They wore not only bracelets and armlets, but earrings, collars, and necklaces, which often consisted of strings of valuable pearls, or were enriched with other jewels. These ornaments were used to indicate the rank of the wearer, and this use has continued to be made of them in the East down to the present day. In Europe, bracelets and armlets were worn both by the classical nations and barbarians from the earliest times. The Gauls wore them; and the Sabines, as early as the foundation of Rome, had ponderous golden armlets on the left arm. The same was the case with the Samians about the same period. It does not appear that armlets were worn by men during the historical period of Greece, but ladies wore both armlets and bracelets of the most various materials and forms. Both generally passed round the arm several times, and the form of B. now most in fashion has been accurately copied from those twisted spirals described by Homer in the eighteenth book of the *Iliad*, line 401. Many examples of this kind of B., as represented on painted vases, will be found in Sir William Hamilton's work. We are indebted to the Greeks even for the idea of giving to these spiral bracelets the form of a snake, the best models of our present goldsmiths being exact copies of antique bracelets. The goddesses of the Greeks, like the blessed Virgin in Roman Catholic countries, were represented as attired in the style of ladies of the highest rank; and the celebrated marble statue of Aphrodite, preserved at Florence, exhibits traces of a metallic armlet. Amongst the Romans, armlets were frequently conferred upon soldiers for deeds of valour, of which an instance is mentioned by Livy (x. 44). Roman ladies wore bracelets, not only for ornament, but also for the purpose of containing amulets, which were supposed to effect miraculous cures. On this principle it is said that the Emperor Nero wore on his right arm the skin of a serpent, enclosed in a golden armlet. But at Rome also, it was chiefly as an indication of rank or wealth that these ornaments were worn. Many Roman bracelets have been preserved, and the accompanying wood-cuts, taken from Smith's *Dictionary of Greek and Roman Antiquities*, to

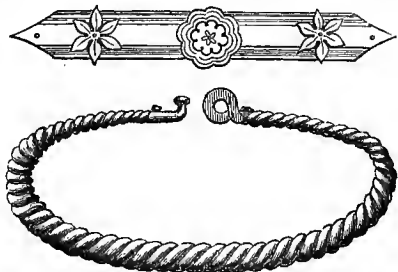

which we have been indebted for much of the information contained in this article, exhibit two antique bracelets of different forms.

BRACES, on shipboard, are ropes attached to the yard-arms, and employed to shift the sails in a horizontal direction round the masts, so as to receive advantageously the wind that may be

blowing at any particular moment. The phrases, 'to brace to,' 'to brace about,' 'to brace the yards sharp up,' &c., apply to this operation.

BRACHE (Fr. *braque*, diminutive *brachet*), a term frequently employed by the older English authors to designate some kind of dog. To what kind this name belonged, is, however, not very certain. The probability appears to be, that it was applied to hounds or hunting-dogs in general. The term is believed to be of Celtic derivation (from *brac*, a spot), and to have originally signified a spotted hound.

BRA'CHIAL A'RTERY is that portion of the great arterial trunk supplying the upper extremity

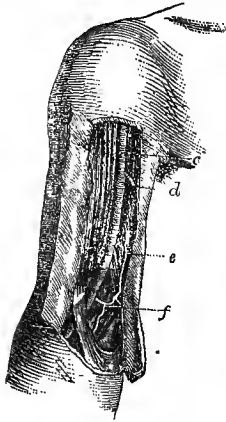

Brachial Artery:

c, brachial artery; *d*, superior profunda branch; *e*, inferior profunda; *f*, anastomotica magna.

between the armpit and the elbow; in other words, it is the continuation downwards of the axillary artery. The B. A. runs along the inner side of the arm, just behind the inner margin of the biceps muscle, and behind the great median nerve. Here it may be pressed against the bone, in cases of bleeding from any point below. In its course, the B. A. gives off, 1st, the superior profunda branch, which winds round the back of the arm-bone, and reappears on the outer side, where it joins some twigs coming up from the radial artery; 2d,

an artery which enters the bone to supply its medullary membrane; 3d, the inferior profunda, which, running down behind the internal condyle (the funny bone) of the humerus, joins branches coming from the ulnar artery; 4th, a short branch, the anastomotica magna, which breaks up into numerous branches insinuating round the elbow.

BRACHIO'PODA (Gr. arm-footed), or **PALLIO-BRANCHIATA** (Gr. mantle-gilled), a class of molluscous animals, having bivalve shells, but differing in important points from the vast majority of recent mollusks with bivalve shells, the *Lamellibranchiata* (q. v.). The chief differences existing in the shelly covering itself have been already pointed out in the article **BIVALVE SHELLS** (q. v.), but those of internal structure are still more important. The mantle or *pallium* (see **MOLLUSCA**) in the B. consists of two broad expansions or lobes, covered by the two valves of the shell, and enclosing all the other soft parts of the animal; whilst respiration or the aëration of the blood is carried on by the surface of these lobes themselves, traversed by minutely ramifying blood-vessels, extended into processes, and furnished, especially along the edge, with vibratile cilia which create a continual current in the surrounding water, and thus keep up a fresh supply, from which the necessary air may be obtained. The organs by which food is procured are also remarkable—two long arms arising from the sides of the mouth, and disposed wholly or partly in spiral curves, when not extended to seek or seize prey. These arms are usually furnished with numerous vibratory filaments, which are supposed not only to aid in the capture of

prey, but in the maintenance of the current necessary for respiration. The B. are attached to solid bodies either by a footstalk or by one of the valves of the shell. Of existing species, the *Terebratulæ* or Lamp-shells (q. v.) are by far the most numerous; but even these appear to have existed in far greater numbers in former geologic periods, and of some of the other families of B. only a single species is known to exist, or the existing species are very few, whilst the fossil species are very numerous. The existing species are very widely diffused over the globe. All of them are marine, and one (*Crania personata*) has been brought up from the depth of 255 fathoms. The B. are regarded as exhibiting structural affinities not only to the *Ascidia* (q. v.) and the *Lamellibranchiata*, between which they are commonly placed, but also to the class *Bryozoa* or *Polyzoa* among *Zoophytes* (q. v.).

BRACHYPTERÆ, or **BRACHYPTERES** (Gr. short-winged), in Ornithology, that section of the order of *Palmipedes* (q. v.), or web-footed birds, in which the wings are short, and the feet are placed far back, so as to compel the birds to assume a nearly erect posture when on land. They are all very aquatic in their habits, and excel in diving, so that the name **DIVERS** is sometimes used as equivalent to B.; but that name is also not unfrequently applied to other aquatic birds, and is sometimes restricted to the genus *Colymbus*. Auks, puffins, penguins, grebes, guillemots, and divers (*Colymbus*) are among the Brachypteræ.

BRACKET, an ornamental projection from a wall, used for the purpose of supporting a statue, bust, or the like. See **CORBEL**. Brackets may be either of stone or wood, and they are sometimes

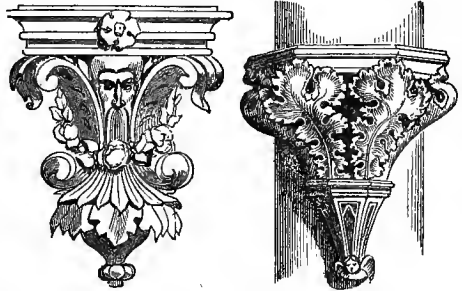

Ornamental Brackets.

elaborately designed and carved. The term B. is also employed in joinery, &c., to designate supports, in the form of a bent knee, of shelves, galleries, &c. B. is also generally applied to such gaslights as project from the wall.

BRACKLESHAM BEDS, a group of highly fossiliferous strata in the middle Eocene formation, included in the Bagshot series (q. v.).

BRACT, or **BRA'CTEA**, in Botany, a leaf from the axil of which a flower or a floral axis is produced, instead of an ordinary leaf-bud or branch. Bracts are sometimes called floral leaves. The term B. is not, however, generally employed when, as is often the case, there is no marked difference from the ordinary leaves of the plant; but the flowers are said to be axillary, or in the axils of the leaves. On the other hand, the term B. is very frequently applied to all altered leaves interposed between the ordinary leaves and the flower or flowers. In this case, they are sometimes very small and scale-like. The ordinary leaves often pass, by imperceptible gradations, into bracts, diminishing in size, becoming

more simple, and often also scariose. Bracts are generally entire, even when the ordinary leaves are divided. They are sometimes coloured so as apparently to form part of the flower, and sometimes crowded, so as to resemble an involucre or an outer calyx. They appear to serve purposes analogous to those of leaves, or, when coloured, of petals. When the primary floral axis is branched, bracts (sometimes distinguished as *bracteoles* or *bractlets*) are often to be seen at its ramifications. Bracts sometimes fall off at an early stage, sometimes they are more permanent, and sometimes they even remain to cover and protect the fruit.

BRADDOCK, EDWARD, a British major-general, commander against the French in America in 1755, arrived in February of that year at Richmond, Virginia, and with a force of 2000, British and provincial troops, reached the Monongahela, a branch of the Ohio, on July 8. Leaving the baggage behind, on the 9th his force moved forward to invest Fort du Quesne, now Pittsburg, Pennsylvania, when, from his slighting the warning of his American officers, of the probability of a surprise, the troops, in passing through a deep forest ravine, fell into an ambuscade of Indians, while they were attacked in front by the French, and half of them slain. The rest made a hasty retreat under Colonel, afterwards General Washington, B.'s aide-de-camp, the only one of his officers who escaped with life. B. himself, mortally wounded, was carried off on a tumbril 40 miles to the place in which the baggage had been left, where he died.

BRADFORD, an important manufacturing town in West Riding, Yorkshire, on a small branch of the Aire, at the meeting of three vales, 8 miles west of Leeds. Pop. in 1851, 103,778; now (1860) about 130,000, of whom more than one half are immigrants from other districts. It returns two members to parliament. B. is the chief seat in England of the spinning and weaving of worsted yarn, and the great mart for the long wools used in worsted fabrics. Cottons are also manufactured. There are 160 mills, employing 34,000 persons. Notwithstanding the large population, and the nature of their employment, the annual rate of mortality is now only 22½ per thousand. Ten years ago, the rate was 29½. The Salthwaite Alpaca and Mohair Mills, on the Aire, 3 miles from B., cover 6 acres. This establishment, erected by Mr Titus Salt, is the most splendid manufacturing concern in England. Coal and iron mines occur near Bradford. The Romans seem to have worked iron-mines here, Roman coins having been found in foundry refuse near the town. The early history of B. is connected with the castle of the Laceyse here. In the civil wars, the people of B. took the parliament side, and twice defeated the royalists, but were afterwards themselves defeated by the Earl of Newcastle. In a riot at B., against the introduction of worsted power-looms, in 1826, two of the rioters were shot dead by the defenders of the mill which contained the obnoxious machinery, and many more were wounded. In 1825, a strike for increased wages, in which 20,000 persons were concerned, lasted six months. According to statistics collected by the Bradford Chamber of Commerce, the rates of wages for operatives, for ten hours' labour, are as follow: *Worsted Spinners and Manufacturers: Men*—engineers, overlookers, &c., 2s. 8d. to 6s. per day; mechanics, warehousemen, wool-sorters, &c., 2s. 4d. to 4s. 6d. *Women*—reelers, drawers, weavers, &c., 1s. to 2s. 4d. per day. *Boys and Girls* (under 13), 3d. to 6d. *Machine Woolcombers*, 2s. 6d. to 5s. *Stuff Warehousemen*, 4s. *Dyers*, 2s. 6d. to 4s. 8d. The hours of labour in the three last-mentioned employ-

ments are uncertain. The Baptists, Independents, and Wesleyans have colleges near Bradford. This town is the seat of the first English Temperance Society. At Fulneck, 5 miles east of B., is a Moravian settlement, founded in 1748, where Montgomery the poet was educated. B. has been latterly much improved in its buildings, and possesses a spacious and elegant public hall, in which the National Association for Promoting Social Science met in 1859. The merchants of Bradford are distinguished by their liberality and enterprise. Their warehouses form the great wholesale market in the worsted and alpaca trade.

BRADFORD, GREAT (Sax. *Bradanford*, broad ford), a town in the county of Wilts, on both sides of the Avon, and on the Kennet and Avon Canal, 6 miles east-south-east of Bath. Pop. 4240. It has been noted for many centuries for its manufacture of fine broadcloths. Kerseymeres were first made here. An India-rubber manufactory has been also lately established. The remains of a monastery, founded in the 7th c. by St Aldhelm, are still visible.

BRADFORD CLAY, a member of the Lower Oolite, is a blue unctuous clay, occurring at Bradford near Bath, and extending for 50 miles around: it is never more than 40 or 50 feet in thickness. It is remarkable for the occurrence in it of large numbers of a crinoid (q. v.), (*Apiocrinites Parkinsoni*). The upper surface of the calcareous rock on which the clay rests is completely incrustated over with a continuous pavement formed of the stony bases of this crinoid. It had once formed the bottom of a sea, in which these animals lived, their stems bending with every motion of the water, and their star-like crown of arms outstretched in search of food. At length, however, the clear water was invaded by a current largely charged with mud, which threw them down, and broke most of their stems off near the base. The stem, body, and arms have been dismembered, and are confusedly scattered through the clay.

BRADLEY, DR JAMES, one of the most distinguished astronomers and discoverers of any time or country, was born at Sherborne, in Gloucestershire, in 1692. He received his early education at a boarding-school at North Leach, whence, being destined for the church, he proceeded to Oxford. Soon after graduating, he obtained successively the livings of Bridslow and of Welfrie, in Pembrokeshire; but there is reason to fear that his mathematical pursuits considerably distracted his attention from his clerical duties. Devoting himself to mathematics and astronomy, he soon exhibited such a genius for these pursuits as to win the friendship of all the leading mathematicians of his time, among others, of the great Isaac Newton, and to get elected a member of the Royal Society. About the time of his election, 1721, he became, in his 29th year, Savilian professor of astronomy at Oxford, resigned his livings, and devoted himself wholly to science. In 1727, he published his theory of the aberration of the fixed stars, containing the important discovery of the aberration of light, to which, it is related, he was led somewhat by accident, as Sir Isaac Newton was to the theory of gravitation. What suggested this discovery to B., it is said, was the observation that the vane of a yacht in which he was sailing never lay in the line of the wind, but was always inclined to it at an angle depending on the line and amount of the yacht's motion. This led him to a train of thought resulting in the proposition, that the direction in which we see a star is not that in which it actually lies, but inclined to it by an angle depending on the direction of the earth's

motion round the sun at the time of the observation, and the ratio of its velocity to that of light. See **ABERRATION**. Three years after this publication, B. became lecturer on astronomy and physics at the Oxford Museum. His next discovery was that the inclination of the earth's axis to the ecliptic is not constant, a fact including the explanation of the precession of the equinoxes and the nutation of the earth's axis. This discovery constitutes a great epoch in astronomy. Latterly, B. became Regius Professor of Astronomy at Greenwich, where, by his observations, he still further enriched the science. He declined the living of the parish of Greenwich, which was offered to him, and was favoured by the crown with a pension of £250 a year for his services to commerce and navigation. Towards the end of his life, B. was elected member successively of almost all the leading scientific societies in Europe. He died on the 2d of July 1762, in his 70th year. B. is described as having been gentle, modest, compassionate, and liberal; little given to speaking or writing, from diffidence and the fear of hurting his reputation. No man ever better merited the title of a great astronomer.

BRADSHAW, JOHN, an eminent Puritan, was born in 1586 of a good family in Cheshire, and studied law at Gray's Inn. Called to the bar, he gained a good practice by his ability and learning, especially as a chamber council. In October 1646 he was appointed a commissioner of the Great Seal, and in February 1647 chief-justice of Chester. In October 1648 he received the degree of serjeant, and in the following January, was elected president of the high court of justice for the trial of King Charles I. As the reward of his services on that solemn occasion, he was made President of the Council of State, and Chancellor of the Duchy of Lancaster, besides the grant of estates worth £4000 per annum, the deanery house of Westminster for a residence, and £5000 to furnish it. B., however, refused submission to the Protector. He was an able lawyer, but not an able politician. His mind was rigid rather than broad, and, in consequence, he was unable (like so many others of the stern fanatical republicans of his time) to see or comprehend the necessity for a great iron rule like Cromwell's. He even engaged in some Fifth Monarchy and other plots against Cromwell, but his respectable character and past services saved him from molestation. He was deprived, however, of his office as chief-justice of Chester. After Oliver's death, he was Lord President of the Council of State, and a commissioner of the Great Seal under Richard. His last public act was to protest against the violent seizure of Speaker Lenthall by the army. He died November 22, 1659. His body was buried with pomp in Westminster Abbey, but it was afterwards exhumed and hung on a gibbet, with those of Cromwell and Ireton.

BRADSHAW'S RAILWAY GUIDE, the pioneer, and still the type, of that now extensive class of publications whose object is to convey all necessary information in regard to travelling. It derives its name from George Bradshaw, originally an engraver and printer in Manchester, who in 1839 issued an occasional work, called the *Railway Companion*, which was corrected by means of another work, in the form of a broad sheet, styled the *Monthly Time Tables*. This sheet was frequently delayed to the 5th or 6th of the month, and was subject to changes made by the Companies, perhaps in the middle, or even the latter end of the month. By great efforts, the Railway Companies were induced to consent to adjust their tables, once for all, for the beginning of each month; and

Mr Bradshaw having established an agency in London, the first number of the monthly *Railway Guide* was brought out in December 1841. The second number now before us, published '1st month (January), 1842,' runs to 32 pages, and contains 42 or 43 lines of railway, in England only, without any advertisements. Through the suggestions and exertions of Mr W. J. Adams, the London agent and publisher, the plan was gradually enlarged and perfected, and resulted in the *Railway and Steam-navigation Guide* for Great Britain and Ireland, so well known to the public. The number for June 1860 comprises nearly 300 railway lines and branches in the three kingdoms, and extends to 290 pages, including 60 pages of steam-boat information, and about 115 pages of advertisements—price 6d. The particulars of the lines, &c., are official; that is, they are obtained direct from the Companies, at the last moment, in time to appear on the 1st of the month. The *Guide* has attained an immense circulation, and given birth to many publications of a similar character. Its plan has been imitated in France and Germany, in America, and even at the antipodes, where a *Bradshaw* is published at Sydney; and in spite of many rivals, the original work has always maintained its place in general estimation.

In 1847, the first number of *Bradshaw's Continental Railway Guide* was issued, which has prospered no less than the British *Guide*. In addition to the tables, as furnished by the companies abroad, it contains a large quantity of topographical information. A series of *handbooks* was also projected by Mr Bradshaw, which includes Great Britain, France, Switzerland, &c., but is still incomplete. The *handbooks of the Overland Journey*, and to the *Presidencies of India*, have been published since Mr Bradshaw's death, which occurred in 1853.

BRA'DYPUS. See **SLOTH**.

BRAEMAR (including the united parishes of Braemar and Crathie), an extensive Highland district, occupying the south-west corner of Aberdeenshire, in the heart of the Grampian Mountains, and intersected by the upper part of the Dee and its tributaries. The chief mountains are Ben Macdhui (q. v.); Cairntoul, 4220 feet; Braeriach, 4225; Ben-a-Buir, 3851; and Ben Avon, 3326, on the north; and Lochnagar (q. v.), on the south. Patches of snow lie on these mountains all the year round. The rocks of B. are granite, gneiss, and quartz, with beds of primary limestone, and masses of serpentine, trap, and porphyry. Most of the district is uncultivated, and consists of heathy tracts, while about a twentieth of the surface is in wood. The natural woods are birch, alder, poplar, and rowan, and the planted chiefly larch and Scotch fir. The fir-timber of the ancient Caledonian forest of Mar, now nearly all cut down, is, for size and quality, the best in the kingdom. Red-deer, roes, grouse, ptarmigan, and alpine hares abound. Many rare alpine plants are found on the mountains and in the glens. Black-faced sheep and small black-horned cattle are reared. Here the Earl of Mar first raised his standard for the Pretender in September 1715. The district is intersected by the great military road from Blairgowrie to Fort George, made by General Wade. In the east part of the district is Balmoral (q. v.); and near its centre is the small village of Castleton, a favourite resort for travellers, sportsmen, and lovers of grand scenery. Pop. 1712, a few of whom still speak Gaelic.

BRAGA, a city of Portugal, capital of the province of Minho, is situated on an eminence between the rivers Cavado and D'Este, about 35 miles north-east of Oporto. The neighbourhood is charming, especially along the banks of the river

Cavado. B. is surrounded by old walls, flanked with towers, and defended by a castle. It is the residence of the primate of Portugal, who has a palace here. It has also a fine Gothic cathedral, several spacious squares; and manufactures of linen, hats, cutlery, firearms, jewellery, &c. Pop. 17,000. It is a very ancient place, being supposed to owe its origin to the Carthaginians. In the time of the Romans, the city was named *Bracara Augusta*, and the ruins of a temple, an amphitheatre, and an aqueduct, belonging to that era, still remain. Not far from B. stands the celebrated *Sanctuario do bom Jesus do Monte*, which is still a place of pilgrimage. After the Suevi had taken Lusitania from the Romans, B. was made the metropolis; and here, at a council held in 563 A. D., the Suevi, with their king, renounced the errors of Arianism, and submitted to the teaching of the Roman Catholic Church. After the fall of the Suevian and West-Gothic kingdom, B. fell into the hands of the Arabs, from whom it was taken by the forces of Old Castile in 1040. After the establishment of the Portuguese dynasty, it was annexed to the crown of Portugal.

BRAGANÇA, the name of two considerable towns in Brazil.—1. B., a seaport of about 6000 inhabitants, at the mouth of the Caite, which enters the Atlantic about 100 miles to the east-south-east of the Amazon.—2. B., an inland city of about 10,000 inhabitants, 50 miles to the north-east of San Paulo, and about 200 to the west of Rio de Janeiro.—The first is about a degree to the south of the equator, and the second about a degree to the north of the Tropic of Capricorn.

BRAGANZA, or BRAGANÇA, a city of Portugal, capital of the province *Tras-os-Montes*, is situated in a pleasant and fertile district, on the river *Ferveça*, an affluent of the *Sabor*. The city is surrounded with walls; has two castles, partly in ruins, of which one was the ancestral seat of the Dukes of Braganza; and has manufactures of silk and velvet. Pop. 5000. This city gives its name to the House of Braganza, the present ruling dynasty in Portugal, John, eighth Duke of Braganza, having ascended the throne as John IV., when the Portuguese liberated themselves from the Spanish yoke in 1640. See PORTUGAL.

BRAGI, son of Odin and Frigga, in the Norse or Scandinavian mythology, was the god of poetry and eloquence. Upon his tongue were engraved the runes of speech, so that it was impossible for him to utter a sentence that did not contain wisdom. According to the older or poetic Edda, he was the most perfect of all scalds or poets, and the inventor of poetry, which is designated by a kindred word, *bragr*. Unlike Apollo, who, in the Greek mythology, is represented as enjoying eternal youth, B. was supposed to be an old man with a long flowing beard; but his brow was always mild and unwrinkled. B.'s wife was *Idunna*. Together with *Hermothr* or *Hermode*, he received and welcomed all those heroes who had fallen in battle, on their arrival in *Valhalla*. On festive occasions, as well as on the burial of a king, a goblet, called *Bragafull* (B.'s goblet), was presented, before which each man rose up, made a solemn vow, and emptied it. Several German periodicals and works, intended to cherish a national spirit, have taken the name of Bragi.

BRAHAM, JOHN, a celebrated tenor-singer, of Jewish origin, was born in London in 1777, and died February 15, 1856. He had an unusually long professional career, having sung on the stage at the age of ten, and continued to make occasional appearances at concerts until within a few years of his death. About the close of the 18th c. he visited

France and Italy for improvement; returning to London, his triumph was transcendent, and from that time, for half a century, he held the reputation of one of the greatest tenor-singers in Europe. It was as a concert-singer that he excelled most, and his great declamatory power and florid execution made his singing of the national songs wonderfully effective.

BRAHÉ, TYCHO, one of the most distinguished names of which astronomical science can boast, was born at Knudsthorp (a place near the Baltic), in Denmark, in 1546. He was descended from a noble family, originally Swedish, and sent, at the age of 13, to the university of Copenhagen, where he had not been more than a year, when an eclipse of the sun turned his attention to astronomy. His uncle, who destined him for the law, furnished him with a tutor, and sent him to Leipsic in 1562; but B., who cared nothing for that study, devoted just so much time to it as would save appearance, and while his tutor slept, busied himself nightly with the stars. By these surreptitious observations of the heavens, and with no other mechanical contrivances than a globe about the size of an orange, and a pair of rude compasses, he succeeded, as early as 1563, in detecting grave errors in the Alphonsine and Prutemic tables, and set about their correction. The death of an uncle, who left him an estate, recalled him to his native place in 1565; but he very soon became disgusted with the ignorance and arrogance of those moving in the same sphere with himself, and went back to Germany. At Wittenberg, where he resided for a short time, he lost part of his nose in a duel with a Danish gentleman; but for the lost organ he ingeniously contrived one of gold, that fitted so admirably, and was so naturally coloured, that few could have detected that it was artificial. After a couple of years spent in Angsburg, he returned home, where, in 1572, he discovered a new and brilliant star in the constellation Cassiopeia. In 1573, he married a peasant girl, which his fellow-noblemen thought even more undignified than being addicted to astronomy; and that they considered very degrading in a gentleman, whose only becoming qualification was, in their estimation, expertness in the use of arms. After some time spent in travel, B. received from his sovereign, Frederic II., the offer of the island of Hven or Hoëne, in the Sound, as the site for an observatory, the king also offering to defray the cost of erection, and of the necessary astronomical instruments, as well as to provide him with a suitable salary. B. accepted the generous proposal, and in 1576 the foundation-stone of the castle of Uraniberg ('city of the heavens') was laid. Here, for a period of 20 years, B. prosecuted his observations with the most unwearied industry—with a zeal, in fact, sufficient to create a new epoch—one of the three great epochs indeed—in astronomy as a science of observation. See ASTRONOMY. The scientific greatness of B. was no protection against the petty prejudices of the nobles, who could not bear to see honour heaped on one who, according to their notions, had disgraced their order, nor against the meaner jealousies of physicians, who were annoyed at his dispensing medicine gratis to the poor. So long as his munificent patron, Frederic II., lived, B.'s position was all that he could have desired, but on his death in 1588, it was greatly changed. For some years under Christian IV., B. was just tolerated; but in 1597, his persecution had grown so unbearable, that he left the country altogether, having been the year before deprived of his observatory and emoluments. After residing a short time at Rostock and at Wandsbeck near Hamburg, he accepted an invitation of the Emperor

Rudolf II.—who conferred on him a pension of 3000 ducats—to Benatek, a few miles from Prague, where a new Uraniberg was to have been erected for him; but he died at Prague on the 13th October 1601. At Benatek he had Kepler as his assistant, and to the advice of B. that celebrated astronomer owed much. The scientific publications of B. are numerous.

BRAHILOV, BRÄILOFF, or IBRÄTL, a fortified seaport town of Wallachia, European Turkey, on the left bank of the Danube, about 99 miles from its mouth, and 15 miles south from Galatz. From B., which is the chief shipping port in Wallachia, large quantities of corn are exported, and also other products of the principality. The sturgeon-fisheries on the Danube, in which many of the inhabitants of B. are engaged, are a source of considerable profit. Pop. about 20,000. In the wars between Turkey and Russia in the 18th c., B. was frequently besieged and taken by the Russians, by whom it was destroyed by fire in 1770. The peace of Kainardji, 1774, restored it to the Turks, who fortified it strongly on the European system; but it was again captured by the Russians in 1828, after a brave defence. It was restored to Turkey by the treaty of Adrianople in 1829. During the war of 1854—1856, it was occupied by Russian troops.

BRAHMÄ, or BRAHM (more commonly pronounced in one syllable), the name given by the Brahmans of India to the 'Self-existent,' or the invisible, eternal Spirit who is the primary source of all being. He is not an object of worship, in the common acceptation of the term, but the devout Brahmans meditate upon his unspeakable attributes with profound reverence and awe. See next article.

BRAHMÄ, sometimes written BRUHMA, a Hindu deity, regarded as the creator of the universe, and forming with Vishnu, the preserver, and Siva, the destroyer, the divine triad, consisting of the three principal gods (*Dei Majores*) of the Brahmanical system of faith. See HINDUISM. We are informed in the opening chapter of the *Institutes of Manu*, that the universe existed originally only in darkness, undiscoverable, 'as if it were wholly immersed in sleep.' Then the Self-existent power, himself undiscerned, but making this world discernible, appeared in glory, dispelling the gloom. 'He whom the mind alone can perceive, whose essence eludes the external organs, who has no visible parts, who exists from eternity—even he, the soul of all beings, whom no being can comprehend, shone forth in person; he having willed to produce various beings from his own divine substance, first with a thought created the waters.' Manu goes on to state that the first being produced from the Self-existent was 'Brahma, the great forefather of all spirits.' B. created the heavens and the earth; then he drew forth mind, already 'existing substantially, though unperceived by sense.' He next produced the elements, and created a multitude of inferior deities, and a number of sages, to whom he delegated a portion of his creative power, and who created the various animals and demons, as well as the clouds, lightnings, comets, &c.

B. is usually represented with four heads, which may perhaps have allusion to the four corners of the earth, as he is sometimes considered to personify the earth, this being no inappropriate type of the creative power in nature; hence, in pictures, B. is often painted red, or of a reddish hue, as this is the usual colour of the earth. B. has long since ceased to occupy that high place which he appears to have once held among the gods of India; his worship, in fact, may be said to have fallen into all

but universal neglect. There are no temples dedicated to him alone, though a qualified worship is paid to him in conjunction with other deities. Fear and hope being the great motives of human action, the adoration of the Hindus is now chiefly divided between Siva, the destroyer, and Vishnu, the preserver.

BRAHMAN, or BRAHMIN, the name of the highest Caste (q. v.) in the system of Hinduism.

BRAHMAPUTRA, a river which has its origin in Tibet, and, after partially mingling its waters with those of the Ganges, flows into the Bay of Bengal by three mouths. It is formed by the junction in Assam of two main branches—the Brahmaputra, with a course of fully 200 miles from the north-east; and the Sanpo, with a course of about 1000 from the north-west; and, as the united current has still upwards of 700 miles to run, the entire length rather exceeds 900 miles from the one principal source, and 1700 from the other. The B. Proper rises towards the east end of the Himalayas, about lat. 28° 30' N., and long. 97° 20' E.; while the Sanpo, about lat. 30° 25' N., and long. 82° 5' E., springs, on the north side of the mountains just mentioned, from the same swamp as the Sutlej and the Indus. Of these two branches, while still separate, the latter approaches Lassa, the capital of Tibet; while the former divides, for some distance, Tibet itself from British India. About 75 miles below the point of confluence, the river diverges into two channels for a distance of 65 miles. Being again united for a stretch of 220 miles, it at last leaves Assam, near Goulpara, after having watered Durrung and Gowhaty. After 60 miles more in a south-west direction, it takes a sweep of about 50 miles round the west extremity of the Garrow Mountains. Being now in lat. 25° 10' N., and long. 89° 43' E., it throws off the Konaie, which it partly recovers after a separation of 180 miles, having meanwhile, however, exchanged the name of B. for that of Meghna. About 25 miles further down, it receives tribute from the Ganges through the channel of Kirtynassa; and, being still 90 miles from the sea, it co-operates with its new partner in cutting up their common delta into a complex net-work of inland navigation.

BRAHMIN OX. See ZEBU.

BRAILS, on shipboard, are among the many varieties of ropes used in furling the sails. To 'brail-up' is to haul up a sail by means of brails.

BRAIN is the nervous centre in which reside consciousness and power over the voluntary movements of the body. It consists of one or more masses of *gray* and *white* nervous matter, or what are technically called vesicular and tubular neurine. When these substances are blended together, the mass is termed a *ganglion*, and from it proceed prolongations of the tubular matter, which are called nerves, and are conductors of impressions to or from the vesicular neurine. The number and size of these ganglia vary with the powers of the animal. In the lowest forms of mollusk, we find a single ganglion, from which proceed all the nerves of the animal; in the higher, there are two ganglia, joined by a nervous cord round the gullet, and distinct from, though connected with, the ganglion which supplies nerves to the foot, and the one for the respiratory apparatus. In the common slug, we have these cephalic ganglia united so as to form one bilobed mass or B. above the œsophagus.

In the **ARTICULATED ANIMALS** (q. v.), the B. consists of two cephalic ganglia over the œsophagus; there are also two nervous cords, one on each side of the body, connected with each other. In the *Cephalopoda*, as the pearly nautilus, the B., or

BRAIN.

mass of nervous matter situated over the gullet, is a transverse cord-like ganglion; in the cuttlefish (*Sepia officinalis*) we find a distinct rounded mass, supported by a rudimentary skeleton. In FISHES, we find, instead of one supra-oesophageal mass or ganglion, several separate masses, the nerves ending in their own special ganglia; i. e., where each nerve ends or begins in the B., there is a collection of vesicular neurine. In addition to these ganglia in fishes, there are parts corresponding to the cerebral lobes or hemispheres of the human brain. There is also a cerebellum.

Suppose we examine a cod's brain (fig. 1). Removing the roof of the skull, we see three pair of neurine masses; two small and round in front, *a*, the hemispherical ganglia; two larger in the middle, the optic ganglia, *b*; and a little triangular appendage behind, the cerebellum, *c*. From just in front of the anterior of those three pairs of masses diverge nervous prolongations, which end in two bodies, *d*, *d*, called the olfactory ganglia. On lifting the appendage we have named cerebellum, we see on each side of the spinal cord a deposition of neurine, which represents the auditory ganglia of more fully developed brains. The olfactory ganglia vary in their distance from the general mass. In REPTILIA, they are placed very near the cerebral hemispheres, which

Fig. 1.—Brain of Cod: Drawn *in situ*—shewn by removing roof of skull.

a, cerebral lobes, or hemispherical ganglia; *b*, optic ganglia; *c*, cerebellum; *d*, olfactory ganglia, or bulbs, connected to brain by long prolongations or roots.

in REPTILIA, they are placed one in front of the other, as in fishes and reptiles, but packed one above the other. We now begin to find some indications of convolutions. On the surface of the B. in the parrot, Leuret describes the furrowing as distinct, though many



Fig. 2.—Brain of Domestic Fowl:

a, cerebral ganglia; *b*, olfactory ganglia; *c*, cerebellum; *d*, optic ganglion of the right side, seen under cerebral ganglion. The optic nerves and eyeballs have been left in the preparation.

birds have perfectly smooth hemispheres; these also are not hollow, as in fishes and reptiles; and it will be seen that the convoluting or folding of the B. substance backwards and forwards, must allow of more being packed into the space than could be

admitted by any other arrangement. The middle part of the cerebellum is very large, *c*, and divided into laminae or leaflets; its lateral portions are much smaller than in Mammalia; the olfactory ganglia are small, *b*, and close to the cerebral hemispheres. The optic ganglia and other nerves rising from them are very large, and the wedge-shaped portion, called *medulla oblongata*, connecting the B. with the spinal cord, is also large. We now approach the MAMMALIA, and in the *Monotremata*, which in some important respects resemble birds—the *Ornithorhynchus paradoxus*, for instance—we find small smooth hemispheres in a B. which to the whole body bears only the proportion of 1 to 130. Even this is greater than in the Marsupials; the kangaroo's B. is as 1 to 800.

If we examine a rabbit's B., we find it to consist, apparently, of three parts—the *olfactory bulb*, the *cerebral hemispheres*, and the *cerebellum*. The cerebral hemispheres are connected by a transverse band of union, or what is technically termed a *commissure*. Continuing the dissection, we turn aside the hemispheres, and find they have concealed *four ganglia*, which represent the single pair of optic ganglia we found in birds. There are two other bodies in front of those just alluded to—viz., the *optic thalamus*, and in front of it another (inferior) *longitudinal commissure*. This forms a communication between the anterior and posterior portions of the hemisphere, on the same side. Two little white lines, running from the back of the thalami, join a little body called the *pineal gland*, interesting in connection with some fantastic physiological theories. It will be observed that the hemispheres lie over these structures like a cap; the space between the two, on each side, is termed the *lateral ventricle*.

We have now the most complicated B. before us, the human encephalic mass of ganglia (figs. 3, 4, 5), and include with it the *medulla oblongata*, the link which unites the B. to the spinal cord. First viewing the B. from its upper surface (fig. 3), we

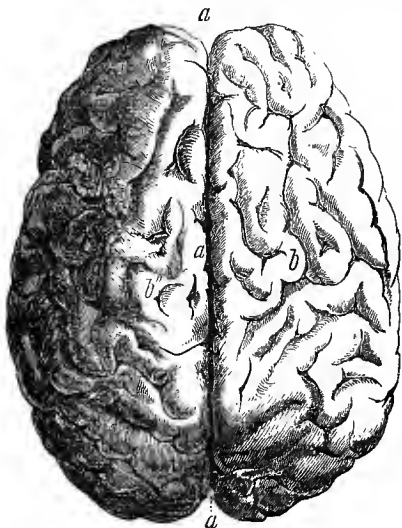

Fig. 3.—Human adult Brain:

Seen from above—membranes removed.

a, *a*, the longitudinal fissure, separating the two hemispheres, *b*, *b*.

see that it is divided by the longitudinal fissure into two equal halves or hemispheres, which are broader behind than in front. They are irregularly marked

by convolutions, *b*, and a smooth appearance is given to the whole surface by the glistening arachnoid membrane (*q. v.*). On slicing them transversely with a knife, the section appears white in the centre, and gray at the margins, of the *convolutions*, which are now seen penetrating to various depths below the surface. The white substance is dotted with the blood-vessels which supply the brain. On drawing the hemispheres asunder from each other with the fingers, the great commissure, or uniting band, is seen, the *corpus callosum*, which is streaked both longitudinally and transversely. The hemispheres should now be completely sliced off on a level with this commissure, and its transverse fibres will be seen to extend into their substance, constituting a large white surface, called by anatomists the *white oval centre*.

If we take the handle of the knife, and scratch with it through this white substance, the instrument soon opens a cavity, which is the *lateral ventricle* (fig. 4). Let this be done on both sides, and the ventricles exposed to view. They are shaped somewhat like the italic *S*. Their extremities are

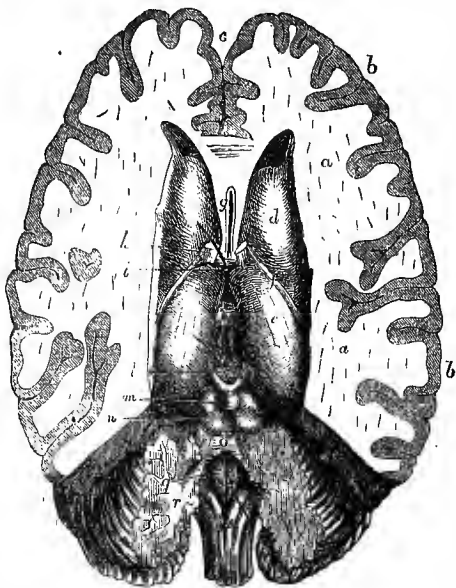

Fig. 4.—Human adult Brain:

In this dissection the cerebral lobes have been sliced off, and the lateral ventricles opened; to allow a view of the cerebellum, the posterior part of the cerebrum has been cut off opposite *n*.

a, a, remains of white oval centre; *b, b*, gray outer portion of hemispheres; *c*, longitudinal fissure; *d*, corpus striatum, or streaked body, lying in lateral ventricle; *e*, optic thalamus; *f*, tænia semicircularis, or worm-like body; *g*, the two layers of septum lucidum, open to shew fifth ventricle; *h*, anterior crura, or portions of the fornix, one of the great antero-posterior commissures; *i*, points to the foramen of Monro, a bristle is sticking down into the third ventricle; *k*, is the middle, or soft transverse commissure, joining the two optic thalami—sometimes absent, and easily destroyed; *l*, a bristle passed from the third to the fourth ventricle (*q*), the transverse lines beneath it indicate the posterior transverse commissure; *m*, the pineal gland, lying on *n*, the corpora quadrigemina; *o*, valve of Vieussens, a layer of gray matter from cerebellum; *p*, processes which connect the cerebellum to corpora quadrigemina; *q*, section of cerebellum line, points to gray matter in fourth ventricle; *r*, white matter projecting into the gray, giving a toothed or arborescent appearance, hence the name, *arbor vitæ*; *s*, posterior pyramids, or back of medulla oblongata.

turned the opposite way. We have now removed the hemispherical ganglion, and uncovered the others. The pia mater, which supports the vessels bringing blood to the B. substance, is seen in a purple wreath lying in each ventricle, and passing down into a depression termed the *middle horn* of the ventricle. This is the *choroid plexus*, and, if lifted, it will be found continuous with that on the opposite side, through an aperture called the Foramen of Monro, *e*, after the great Scotch anatomist of that name. If the remains of the corpus callosum are now scraped away, the choroid plexus will be found continuous with a web of pia mater called the *velum interpositum*, which lies over the central cavity of the B., or third ventricle. In front and behind will be seen portions of the inferior longitudinal commissure or *fornix*, *h*, the body of which has been removed to shew the velum; but, placed vertically between its anterior part and the under surface of the corpus callosum, are two layers of gray matter, between which is a narrow space termed the *fifth ventricle*, *g*. Behind, there will be seen a small hole, through which a probe will pass into the *fourth ventricle*, *l*.

The accompanying cut (fig. 4) shews the parts now exposed. The mass most in front is the *corpus striatum*, *d*, behind it is the *optic thalamus*, *e*. Through the former, motor fibres pass from the anterior columns of the spinal cord into the hemisphere; through the latter, the sensory fibres from the posterior columns of the cord. These are by some considered to be the ganglia of motion and common sensation.

Behind these are the *corpora quadrigemina*, *n*, which are analogues of the optic ganglia of the lower animals. Upon them lies the *pineal gland*, *m*, and behind them, projecting into the fourth ventricle, *g*, some gray matter, said to be the auditory ganglia. We now come to the upper surface of the *cerebellum*, consisting of two hemispheres split transversely into leaflets, and connected by a central portion to each other, and by two bundles of white fibres to the corpora quadrigemina, *p*. Between these is the *fourth ventricle*; and stretched across between them is a thin layer of gray matter, called the *valve of Vieussens*, *o*.

We now turn what remains of the B. upside down, and examine the base or under surface. It is very irregular in outline. The cerebral hemispheres are now found to be divided on each side by a *fissure* (*Sylvian*), *f*. The part in front is called the *anterior lobe*; that behind the *middle*, as far as the cerebellum, when it is called the *posterior lobe*.

The diagram (fig. 5) gives a better idea of the appearance than words could possibly do. The olfactory lobes, *h, h*, are now seen lying in a fissure in the anterior lobes. The optic tracts are seen meeting at their commissure, *i*, interchanging fibres, and passing on as the optic nerves to the orbit. The larger bundles behind, and directed outwards, are the *crura cerebri*, *p*, passing towards the hemispheres, emerging from the transverse mass called the *pons varolii*, *s*, which lies like a clamp between the two halves of the cerebellum, *d*. From the inner side of each crus arises the third nerve, *v*, destined to supply four of the muscles which move the eyeball. The fourth nerve, *g*, comes from the valve of Vieussens, and is seen on its way to supply the superior oblique muscle which turns the eye upwards and outwards, hence called *patheticus*. From each side of the pons the fifth pair, *r*, arises; the sixth, *t*, between the pons and the anterior pyramids of the medulla oblongata; *w* is the eighth, consisting of: 1. The Glosso-pharyngeal, or nerve of deglutition; 2. The Pneumo-gastric distributed to the respiratory apparatus and stomach; and with it, 3. The Spinal Accessory.

BRAINE-LE-COMTE—BRAINSTONE CORAL.

The chemical composition of B. matter averages in 100 parts—

Water,	75½ parts.
Albuminous matter,	7 "
Fat,	11½ "
Salts (containing 1½ of phosphoric acid),	6 "

The proportion of these constituents varies not only in different species of animals, but also in different members of the same animal group, and appears to be much influenced by the age, temper, and intellectual capabilities of each individual. Thus, the normal quantity of salts in the B. of a healthy man is 6 per cent., and in the B. of an insane patient, only 2½ per cent. were found.

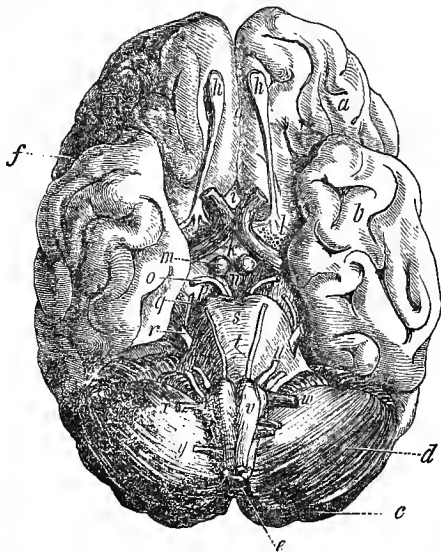

Fig. 5.—Human adult Brain:

a, anterior lobe of cerebrum; b, middle lobe; c, posterior lobe of cerebrum, appearing behind; d, cerebellar hemisphere; e, medulla-oblongata; f, fissure of Sylvius; g, longitudinal fissure; h, h, olfactory bulbs; i, optic commissure—the optic nerves are seen interchanging fibres; j, three roots of olfactory process; m, white round bodies (*corpora albicantia*), the terminations of the anterior portions of fornix; n, where the vessels perforate the brain substance, hence called posterior perforated space; o, third pair of nerves coming to supply muscles of the eyeball, from p, the crus-cerebri; q, fourth nerve, turning round from the valve of Vieussens; r, fifth pair; s, pons verolii; t, sixth pair of nerves; u, seventh pair, portio dura for muscles of face, and portio mollis for hearing; v, posterior pyramids of cerebellum, seen to interchange fibres; w, and two below, are eighth pair—viz., glosso-pharyngeal, vagus pneumo-gastric, and spinal accessory nerve; between w and v is the small prominence called olivary body; x, y, two roots of ninth pair of nerves, motor nerve of tongue.

Softening of the Brain (ramollissement) is a frequent result of chronic inflammation of the brain. The patient has been for some time in low health, troubled with headaches, loss of appetite, depression of spirits, and a gradual loss of memory, and acute perception of things in general. Then a spasm may occur, followed by paralysis, or the legs and arms may be bent up, and remain in that position. This condition of B. may be caused by want of proper nourishment to the cerebral substance, owing to plugging up, or from disease of its arteries. When the softening is caused by inflammation, we frequently find pus forming an abscess of the brain. Induration may also occur as the result of inflammation.—The other diseases, as hydrocephalus, will be treated under their own names.

Diseases of the Brain.—*Inflammation* (acute) of the B. (*phrenitis*, or popularly, *B.-fever*) rarely occurs separately, and can scarcely be distinguished from inflammation of its membranes (meningitis). According to Dr Watson of London, when the disease begins in the latter, the first remarkable symptom is a convulsion fit; when in the B. substance itself, nausea and vomiting generally usher in the attack.

In the first stage, there is rapid pulse, severe headache, the eyes suffused, and their pupils contracted to a small point, very intolerant of light. The patient is constantly watchful, and much annoyed by even ordinary sounds. Then furious delirium sets in, and lasts for a period, varying with the case, generally from twelve to forty-eight hours; when it is succeeded by collapse, in which the patient lies—his face devoid of colour, and covered with cold sweat—in a state of stupor. If roused, he now speaks with slow, indistinct utterance; his pupils are now dilated, and indifferent to the brightest light; and the loudest speaking ceases to annoy him. The stupor increases with the general prostration, and continues till death. After death, we find serous fluid upon and in the B., deposits of lymph, thickening of the membranes, and softening of the B. substance itself.

General and local bleeding, with antimony and digitalis, to subdue the pulse; mercury, to prevent the deposit of lymph; blisters, as counter-irritants, to the back of the head and neck, are the usual remedies for this rare, but terrible disease. The younger school of practitioners, however, as Dr Tauner expresses it, prefer waiting to see if nature unaided, or only *gently guided*, will not carry the patient through a disease where the efforts of art are notoriously futile, and are rather content to *watch the symptoms*, to calm excitement by sedatives, to lessen increased heat of body by diluents and tepid sponging, to prevent accumulations in the intestines by purgatives, and to diminish maniacal delirium by the application of cold to the head.

BRAINE-LE-COMTE, a busy town of the province of Hainault, Belgium, about 13 miles north-north-east of Mons. It is an ancient place, and formerly belonged to the monks of St Waudru at Mons, from whom it was bought by Count Baldwin in 1158. It has an old church of the 13th c.; and cotton and corn mills, dye-works, breweries, &c. Some of the finest flax that can be produced is grown in the district. Pop. 4500.

BRAINSTONE CORAL, the popular name of certain kinds of Coral (q. v.) or Madrepora (q. v.), included in the Linnæan genus *Madrepora*, but now forming the much more restricted genus *Meandrina*. They derive their name from the general resemblance to the brain of man or of a quadruped exhibited in their large rounded mass, and numerous winding depressions. Perhaps the true B. C. is *Meandrina cerebriformis*, a species always nearly hemispherical. When the hemispherical mass is broken, the ridges which bound its furrows may be traced inwards through its substance, even to the central nucleus from which they commenced. The mouths of the polypes, in all the species of this genus, are in the furrows or elongated hollows, in which they are ranged side by side, in sinuous series. The brainstone corals are very common in collections, and are much admired for their beauty. They are found chiefly in the seas of warm climates, particularly in the Indian and South Atlantic Oceans. They sometimes attain a large size. Ehrenberg noticed single masses (polyipidoms) in the Red Sea, from six to nine feet in diameter. Their rate of growth, however, appears to be slow. The fossil

species are few, and chiefly belong to the oolitic formation.

BRAINTREE, a market-town of Essex, about 40 miles north-east from London. It is an old place, having been constituted a market-town by King John. Its streets are narrow, and many of its houses are of wood. It has manufactures of silk and crape, and also of straw-plait. It is the polling place for North Essex, and has obtained some notoriety in connection with political and ecclesiastical proceedings. Pop. of town about 3000.

BRAKE, a genus of Ferns of the division *Poly-podeæ*, distinguished by spore-cases in marginal lines covered by the reflexed margin of the frond. The COMMON B. or BRACKEN (*P. aquilina*) is very abundant in Britain and in most parts of the continent of Europe, growing in heaths, parks, &c., often covering considerable tracts. It is a widely distributed plant, and is found in many parts of Asia, and in some parts of Africa. It has a long, creeping, black rhizome, or root-stock, from which grow up naked stalks of 8—18 inches in height; each stalk divides at top into three branches;

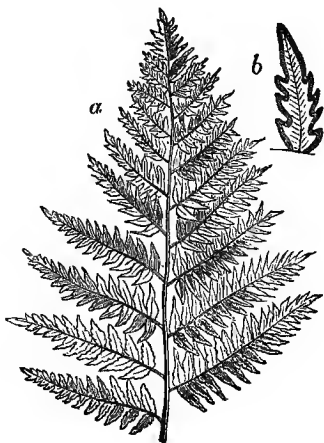

Common Brake :

a, end of a branch, much reduced; b, end of a pinnule, the lower side, shewing fructification.

the branches are bipinnate, the inferior pinnules pinnatifid. The root-stock, when cut across, exhibits an appearance which has been supposed to resemble a spread eagle, whence the specific name *aquilina* (Lat. *aquila*, an eagle). The root-stock is bitter, and has been used as a substitute for hops; it has also been ground, mixed with barley, and made into a wretched bread in times of distress. The plant is astringent and anthelmintic; and as such, it had at one time a high reputation, although it is now little used, at least by medical practitioners. It is employed in dressing kid and chamois leather. The ashes, containing a large quantity of alkali, were formerly used in the manufacture of soap and of glass, so that the collecting of them for sale was a considerable resource of the poor in some parts of the Hebrides. B. is also employed for thatching, for littering cattle, &c., and occasionally chopped up with straw or hay, for feeding cattle. It is a favourite covert of deer and of other game. The abundance of this plant is sometimes regarded as a sign of poor land, although, probably, its absence from the richer soils is very much a result of cultivation. To extirpate it, nothing more is necessary than a few successive mowings of the

young shoots as they appear. The annual growth of B. is killed by the first frosts of autumn, but remains rigid and brown, still affording shelter to game, and almost as characteristic a feature in the landscape of winter as in that of summer, perhaps adding to its general desolateness.—*Pteris caudata*, a large species of B. very similar to that of Europe, is one of the worst pests which the farmer has to contend with in the south of Brazil.—*Pteris esculenta*, a native of New Zealand, Van Diemen's Land, &c., has a more nutritious rhizome than the common brake. See TARA FERN.—Rock B. (*Cryptogramma crispa* or *Allosorus crispus*, formerly *Pteris crispa*) is a pretty little fern, common on stony hills in the northern parts of Britain.

BRAMA, a genus of fishes of the family *Chaetodontidae* (q. v.). *B. Rasi* is common in the Mediterranean, and occasionally found on the British shores. It is one of the fishes to which the name Bream (q. v.) or Sea-bream has been given; and it has also been described as a Gilt-head (q. v.); but these names belong to fishes of other families, with some similarity of general appearance. The genus B. has the body very deep and compressed, the head rather obtusely terminated, a single elongated dorsal fin, and the anal fin with a very lengthened base. The tail is forked, its points extremely divergent. This fish is sometimes more than two feet in length. Its flesh is of exquisite flavour.

BRAMAH, JOSEPH, an eminent practical machinist, the son of a farmer, was born at Stainborough, Yorkshire, April 13, 1749, and early exhibited an unusual talent for mechanics. Incapacitated in his 16th year from agricultural labours by an accidental lameness, he was apprenticed to a carpenter and joiner, and afterwards obtained employment with a cabinet-maker in London. Subsequently, he established himself in business in the metropolis, and became distinguished for the number, value, and ingenuity of his mechanical inventions, such as safety-locks, improvements in pumps and fire-engines, in the construction of boilers for steam-engines, in the processes of making paper, in the construction of main-pipes, wheel-carriages, the beer-machine used at the bar of public-houses, and many others. About 1800, he constructed the hydrostatic press known by his name. See HYDROSTATIC PRESS. In all, he took out about twenty patents. He died 9th December 1814.

BRAMANTÉ, DONATO LAZZARI, one of the most celebrated Italian architects, and also distinguished as a painter, was born at Monte-Asdroaldo, in the duchy of Urbino, 1444. From 1476 to 1499, he resided in Milan, where he studied geometry and perspective, neither of which sciences was well understood by artists in his day. He was noted as one of the best painters in Lombardy; but his success in architecture eclipsed his fame as a painter. In Milan, he built the choir of Santa-Maria delle Grazie, and the church of Santa-Maria presso San-Satiro. After the fall of Ludovico Sforza, B. went to Rome, where he was first employed by the pope Alexander VI., and afterwards by Julius II. The first great work which he undertook for the latter was to connect the Vatican palace with the two pavilions of the Belvedere by a series of immense galleries; the second was the rebuilding of St Peter's Church, of which he laid the new foundation in 1506. When only a small portion of his plans had been realised, B. died at Rome, 1514, and succeeding architects departed widely from the original design of a grand cupola over a Greek cross. Among other works of B. in Rome may be mentioned the palaces

Cancellaria and Giraud (now Torlonia), in which he adhered more strictly than in other works to antique forms, but not without a characteristic grace in his application of these.

BRAMBANAN, a district of the province of Soorakarta, Java, rich in remains of Brahmanical temples, which are superior in magnificence to any in India. The edifices are composed entirely of hewn stone, and no mortar has been used in their construction. In all, there are 296 temples, disposed in five parallelograms one within the other. The outer one consists of 84 temples; the second, of 76; the third, of 64; the fourth, of 44; and the inner one, of 28. In the centre stands the largest and most imposing structure of all. It is 90 feet high, and profusely decorated with mythological figures, which are executed in a very fair style of art. On the south face of the outside parallelogram, there are two monstrous figures, with uplifted clubs, kneeling in a threatening attitude. The great temple is pretty entire, as are also about a third of the others, but the rest lie strewn upon the ground.

BRAMBLE (*Rubus fruticosus*), a plant common in Britain and most parts of Europe, having prickly stems, which somewhat resemble those of the Raspberry (q. v.). The flowers do not appear till the summer is considerably advanced, and the fruit ripens towards the end of it, continuing to be produced till the frosts of winter set in. The fruit (brambleberry or blackberry) is too well known to need description. Besides affording much enjoyment to children, who collect it from hedges and thickets, it is sometimes offered for sale in towns, and jelly and jam are prepared from it of very delicate flavour, besides a wine, which, both in strength and flavour, is held by many to excel all products of similar native fruits of Britain. The B. is rarely cultivated, perhaps because it is in most districts so abundant in a wild state; but it seems to deserve attention at least as much as the raspberry, and might probably be as much improved by cultivation. A slight rail on each side of a row of brambles, to restrain the straggling stems, affords the necessary security for neatness and order, and the care bestowed is repaid by abundance of fruit,



Bramble.

very acceptable where wild-brambles are not plentiful, and at a season when there is no other small fruit in the garden.—There are many different species of B., according to some—varieties according to other botanists—to which the name is indiscrimi-

nately given, and which may almost all be regarded as belonging to the Linnæan *Rubus fruticosus*. From this was separated *R. corylifolius* of Smith, a common British plant, and from these some German and British botanists have separated many other alleged species. *R. suberectus* has more the habit of the raspberry than most of the other kinds, but even its claims to be received as a species are not admitted without doubt by some of the most eminent botanists. A variety of B. with white fruit is occasionally met with.—Species of *Rubus* very similar to the common B., or varieties of it, abound in the northern parts of Asia, the Himalaya Mountains, and North America. See RUBUS.

BRAMBLING, BRAMBLE FINCH, or MOUNTAIN FINCH (*Fringilla Montifringilla*; see FINCH and FRINGILLIDÆ), a bird nearly allied to the Chaffinch (q. v.). It is a little larger than the chaffinch, which it much resembles in its general appearance, its bill, and even the disposal of its colours. The tail is more forked. In the males, the crown of the head, the cheeks, the back and sides of the neck, and the upper part of the back, are mottled in winter with brown and black; but in spring, the whole of these parts become of a rich velvety colour; the throat and breast are of a rich fawn colour, which is also the prevailing colour of the wings, but they are crossed, when closed, by an oblique band of jet-black, and by another oblique band of white. The quill-feathers are also black, edged with yellow on their outer webs; the tail-feathers black, edged with reddish white; the rump and the belly are white; a small tuft of feathers under each wing and some of the lower wing-coverts are bright yellow. The B. is a mere winter visitant in Britain,



Brambling, or Mountain Finch.

and the period of its arrival appears to vary according to the severity or mildness of the weather in the more northerly regions. The B. has never been known to breed in any part of the British islands, and even in the south of Sweden it is a mere winter visitant. It breeds in the more northerly parts of Scandinavia. It has no song, its call-note is a single monotonous chirp. It is a very widely distributed species, being found as far east as Japan, and, in its winter migrations, visiting Italy, Sicily, Malta, Smyrna, &c.

BRAMPTON, a very ancient town in the county of Cumberland, near the Arthing, 8 miles east-northeast of Carlisle. It is surrounded by hills; and the Castle-hill commands a very extensive view. Pop. 3074. The chief manufacture is the weaving of checks and gingham; and there are coal-mines in the vicinity. On a rock, two miles to the south, is a Roman inscription, supposed to have been cut by one of Agricola's legions in 207 A.D. Two miles to the east stands Lanercost Abbey, founded in 1116.

BRAN is the material obtained from the outer covering or husk of grain during the process of grinding, and which is separated from the finer flour before the latter is made into bread (q. v.). It is generally met with in commerce in thin scaly yellowish-brown particles, with sharp edges, and its composition in 100 parts is as follows :

Water,	13.1
Allumen (coagulated),	19.3
Oil,	4.7
Husk, with a little Starch,	55.6
Ash or Saline matter,	7.3
	100.0

Bread made of flour, containing B., is known as *Brown Bread*. See BREAD. The main uses to which B. is put are in the feeding of horses and cattle, and poultry, and in clearing and brightening goods during the processes of Dyeing (q. v.) and Calico-printing (q. v.). In the practice of medicine, B. is employed as a warm poultice in abdominal inflammation, spasms, &c., and an infusion is used as an emollient footbath. It is also used internally in catarrhal affections.

BRANCH, in Botany, is a part of a tree or other plant not taking its rise immediately from the root, but rather forming a sort of division of the stem, and which is often divided into secondary branches, again, perhaps, to be further much ramified into *branchlets* and twigs, the ultimate ramifications producing leaves, flowers, and fruit. Branches originate in leaf-buds, which are produced at the *nodes* of the stem, or of the already existing branches. See BUD, PLANT, and STEM. The buds being formed in the axils of leaves, the arrangement of the branches, as alternate, opposite, whorled, &c., varies like that of the leaves, but buds often remain dormant, according to a regular law of alternation. The angles of ramification are very different in different plants, producing great variety of appearance, and giving marked characteristics to different kinds of trees. The great difference between the ramification of the *Coniferae* in general (Pines and Firs) and that of other trees must have attracted the attention of every one. In many herbaceous plants whose axis is scarcely developed into a stem, instead of branches there proceed from the lateral buds *runners*, which lie close to the ground, send down roots, and produce new plants, as in the strawberry.

BRANCHIÆ. See GILLS.

BRANCHIOPODA (Gr. gill-footed), an order of *Crustacea* (q. v.) of the division *Entomostraca* (q. v.) deriving this name from the distinctive peculiarity of having the *branchiæ*, or gills, which are numerous, attached to the feet. They are all small creatures, many of them almost microscopic, and chiefly abound in stagnant fresh waters. Some are popularly known by the name of Water-fleas (q. v.); the Brine-shrimp (q. v.) is another example; and the genera *Cyclops* and *Cypris* may be mentioned, the former on account of its great frequency in stagnant fresh waters, the latter because its hard shells resist decomposition, and are therefore abundant in a fossil state.

BRANCO, RIO, a river of that portion of Brazil which, originally comprised within the understood limits of Guiana, lies to the north of the Amazon. It rises in the Parime Mountains, on the very borders of Venezuela; and after a southerly course of about 400 miles, it joins, near lat. 1° 20' S., and long. 62° W., the Rio Negro, of which it is the principal tributary, on its way to the Amazon.

BRANCURSINE. See ACANTHUS.

BRAND, a name given in some parts of Britain to some of those diseases of plants, especially of

corn-plants, which are also called BLIGHT, BUNT, MILDEW, RUST, and SMUT.—See these heads.—It is the German name for the disease generally known in Britain as BUNT, and sometimes as *Pepper-brand*. Both as a German and an English word, it appears to be derived from the verb *brennen* to burn, and to refer to the burnt appearance which characterises the diseases to which it is applied.—Its most common application in Britain, however, is not to any of the diseases already mentioned, but to a peculiar spotted and burnt appearance often seen on the leaves, and sometimes also on the bark of plants, which does not seem to be in any way connected with the presence of parasitic fungi, but which sometimes becomes so extensive as to cause the death of the plant. The nature of this disease is still somewhat obscure. Occurring most frequently when warm sunshine succeeds to moist weather or to hear-frost, and frequently affecting plants in hotbeds upon which drops of condensed moisture fall from the frame, it has been ascribed to the concentration of the sun's rays by the drops of water on the leaf or bark—a theory utterly untenable, as no concentration can take place in such circumstances. The probability appears to be, that the action of the moisture unequally distributed, and particularly when sudden changes of temperature take place, deranges the vegetable functions, and destroys the fine tissues.—BRAND, a mark made on a cask for trade or Excise purposes. See FISHERIES, and TRADE MARKS.

BRANDENBURG, a province of Prussia, in the centre of the kingdom, in lat. 51° 30'—53° 45' N., and long. 11° 13'—16° 8' E. B. has an area of 15,416 square miles, and a population of 2,329,996. It formed the nucleus of the Prussian monarchy, but the modern province does not quite correspond with the old *Mark* of B., which included also a part of the province of Saxony and of Pomerania, while it lacked certain small portions of territory now contained in the province of Brandenburg. Almost the whole province is a plain, so low that at Potsdam the surface of the river Havel is only 14.6 Prussian or about 15 English feet above the level of the sea. The ground becomes slightly hilly towards Silesia. In general, the soil is sandy and naturally unfruitful. Without its numerous rivers and canals, B. would be one of the most barren tracts on the continent. The inhabitants are mostly Germans, mixed with French and Dutch colonists, who, however, are almost completely Germanised; and in the south of the province, with people of Wend extraction. With the exception of 37,962 Roman Catholics, and 24,196 Jews, they belong to the Protestant Church. Agriculture and the rearing of cattle afford occupation for a considerable number of the inhabitants. The manufactures are silk, cotton, wool, linen, sugar, leather, paper, metals, &c. There are also numerous distilleries throughout the province. B. is divided into the governments of Potsdam and Frankfurt, which are subdivided into 34 circles. Berlin is the chief town. In the beginning of the Christian era, B. was inhabited by the Suevi, and afterwards by Slavonic tribes. It was subjugated by Charlemagne in 789, but it again acquired independence under his weak successors, and remained free until 928, when Henry I. possessed himself of it. After passing through numerous changes in connection with the general history of the German empire—of which we need here mention only the facts that Albert the Bear (q. v.) became the first Markgraf of B. in 1142, and Frederick of Nürnberg the first elector in 1417—it became associated with the rise of the Prussian state into a monarchy under Frederick I., Elector of Brandenburg, in 1701. See PRUSSIA.

BRANDENBURG (the ancient *Brennaborch* or *Brennabor*), the town from which the province Brandenburg is named, is situated on the line of the Berlin and Magdeburg Railway, about 37 miles west-south-west of Berlin. The river Havel divides it into two parts, Old and New B., which are both surrounded with walls. On an island in the river there is a third quarter, containing the castle, cathedral, equestrian college, &c. The cathedral has a fine old crypt, and several interesting antiquities. The inhabitants, amounting to about 19,000, inclusive of the garrison, are engaged in the manufacture of woollen, linen, hosiery, paper, leather, beer, &c. Boat-building is also carried on to a considerable extent.

BRANDENBURG, NEW, a walled town in the grand duchy of Mecklenburg-Strelitz, North Germany, is situated near the north end of Lake Tollen, about 50 miles west-north-west of Stettin. It is a beautiful town, with regular, broad, and well-built streets. The grand duke has a palace in the market-place. It has manufactures of woollen, cotton, damasks, leather, paper, tobacco, &c., besides corn-mills, oil-works, and a trade in hides and horses, and is altogether a very thriving place. Pop. about 6000.

BRANDING was a mode of punishment practised in England for various offences. It was effected by the application of a hot iron, the end of which had the form which it was desired should be left imprinted on the skin. But B. by such means has long ceased, and now it is practically confined to the case of desertion from the army—the B. or marking being not done by a hot iron, but with ink, or other similar preparation. By the Mutiny Act of 1858, 21 Vict. c. 9, it is enacted by section 35 as follows: ‘On the first, and on every subsequent conviction for desertion, the court-martial, in addition to any other punishment, may order the offender to be marked on the left side, two inches below the armpit, with the letter D, such letter not to be less than an inch long, and to be marked upon the skin with some ink or gunpowder, or other preparation, so as to be visible and conspicuous, and not liable to be obliterated.’ Formerly, B. was employed in the case of all *clergerie* offences by burning on the hand (see **BENEFIT OF CLERGY**); and with a view still further to repress theft and petty larceny, the 10 and 11 Will. III. c. 23, s. 6, provided that such offenders as had the benefit of clergy allowed them should be ‘burnt in the most visible part of the left cheek, nearest the nose.’ This additional severity, however, not having the desired deterrent effect, but the reverse, was repealed by the 5 Anne c. 6, which nevertheless provided for offenders being burnt on the hand as formerly. The latter punishment, however, was entirely abolished by an act passed in 1822, the 3 Geo. IV. c. 38. Brawling in church (q. v.) was, by the 5 and 6 Edw. IV. c. 4, made an offence punishable by having one of the ears cut off, or, the offender having no ears, by B. with the letter F on the cheek. This punishment was repealed by the 9 Geo. IV. c. 31. B., therefore, in the case of felonies, has been entirely abolished.

BRANDIS, CHRISTIAN AUG., professor of philosophy in Bonn, was born at Hildesheim, 13th February 1790, his father being J. D. Brandis, one of the most distinguished physicians of his time. Having studied philology and philosophy at Kiel and Göttingen, he began lecturing in the university of Copenhagen, from which he removed to Berlin (1816). Here he was soon called upon to take part in the preparations for the great critical edition of the works of Aristotle, contemplated by the Berlin Academy of Science, 4 vols.

(Berlin, 1831—1836); and with this object, spent several years, along with Immanuel Bekker (q. v.), in exploring the chief libraries of Europe. In 1821, he resumed his academic career in the university of Bonn, where he edited Aristotle's *Metaphysics* (vol. i., Berl. 1823), *Scholias in Aristotelem* (Berl. 1836), and *Scholias Græca in A. Metaphysicum* (Berl. 1837). He accepted, in 1837, a call from the young king of Greece, and spent several years in that country as cabinet counsellor. As a result, we have his *Mittheilungen über Griechenland*, Communications on Greece (3 vols., Leip. 1842). In his *Handbuch der Geschichte der Griech.-Rom. Philosophie* (History of Greek and Roman Philosophy, vols. i. and ii., 1835—1844), he has, by establishing what are the facts of the case, laid the historical basis for a knowledge of Greek thought.

BRANDLING. See **PAR**, and **SALMON**.

BRANDON, a town on both sides of the Little Ouse or Brandon river, where it separates Norfolk from Suffolk, 78 miles north-north-east from London by road. Pop. 2022. It has a considerable com-trade. Great rabbit-warrens occur near Brandon. There was formerly an extensive manufactory of gun-flints here, the army being exclusively supplied with these articles from B. before the introduction of percussion-caps.

BRANDT, SEBASTIAN, the author of a very popular German book, the *Narrenschiff*, or Ship of Fools, was born at Strasburg, 1458; studied law and the classics with zeal at Basel, where he received permission to teach; and soon became one of the most influential lecturers in that city. The Emperor Maximilian shewed his regard for B. by appointing him an imperial councillor. He died at Strasburg in 1521. His Ship of Fools, a satire on the follies and vices of his times, which was published at Basel, 1494, is not very poetical, but is full of sound sense and good moral teaching, and was so much esteemed that the German popular preacher Geiler occasionally took his texts from it. It was translated into Latin by Locher (1497); and into English by Henry Watson, *The Grete Shyppe of Foles of the Worlde* (1517); partly translated and partly imitated by Alexander Barclay, *The Shyp of Fols of the Worlde* (1508); and imitated by W. H. Ireland in the *Modern Ship of Fools* (1807). It has also appeared in French, and indeed in almost all European languages.

BRANDY (Ger. *Branntwein*, Fr. *eau de vie*) is a term sometimes applied generically to all kinds of ardent spirits, but usually restricted to the liquid obtained by distilling the fermented juice of the grape. See **DISTILLATION**. The fermented liquors or wines which are employed for that purpose are various, and contain a proportion of alcohol (q. v.), which runs from 10 to 25 per cent. of their weight. The red wines generally are preferred, as containing most alcohol; but though they yield a larger amount of B. than the white wines, yet the latter afford a spirit which possesses a finer flavour and more agreeable taste. 1000 gallons of wine give by distillation from 100 to 150 gallons of B., which varies in strength, but is commercially judged of according to the quantity of *eau de vie* or B. à *preuve de Holland* which it contains, and is generally diluted with water till it contains from 50 to 54 per cent. by weight of absolute alcohol. When originally distilled, B. is clear and colourless, and if wished to remain so, is received and kept in glass vessels; but when placed in wooden casks, the spirit dissolves out the colouring-matter of the wood, and acquires a light sherry tint, which is deepened by burnt sugar and other colouring-matter, intentionally added by the dealers. The pleasant aroma of

B. is due to the presence of more or less of fusel oil (q. v.) accompanied by œnanthic ether (q. v.). The most famous B. is that distilled in Cognac, a district in the west of France, from the choicest wines, but comparatively little of that sold under the name of *Cognac* comes from this district. A second-class B. is obtained from the red wines of Portugal, Spain, &c., as also from the refuse (*marc*) of the grapes left in the winepress, the scrapings of wine-casks and vats, the deposits in wine-bottles, &c.; and very much of the B. sold in Great Britain and Ireland is prepared at home from ordinary grain alcohol, by adding thereto argol (q. v.), bruised French plums, some French wine-vinegar, a little good Cognac, and redistilling, when the spirit which passes over may be coloured with burnt sugar, or by being kept in an empty sherry cask. Occasionally, grains of paradise and other acrid matters are added, to give the B. a fictitious strength; and catechu or oak-bark, to give it an astringent taste. B. is the form in which alcohol is administered medicinally either internally or externally. It is distinguished from other ardent spirits by its light, cordial, and stomachic properties, and especially when set fire to for a minute or two, forming what is known as *Burnt B.*, it is valuable as a household remedy for diarrhœa. B. is administered internally (1), in *mild cases of diarrhœa*, unaccompanied by inflammation, but attended with griping pain, and the addition of nutmeg is productive of good; (2), as a *powerful excitant* for restoring patients who are suffering from suspended animation, and to relieve those who are labouring under fainting symptoms during an operation in surgery; (3), as a *stimulant and restorative*, where patients are much depressed in the ultimate stages of fever; and (4), as a *general stomachic stimulant* in indigestion after taking food, in the relief of flatulency and spasms of the stomach, and to check vomiting, especially in sea-sickness. Externally, B. is employed (1), in healing sores, and in stopping hemorrhage or the oozing out of blood from bruised or injured parts, and is generally applied by soaking linen or cotton with it, and laying the cloth on the part; and (2), in hardening the skin or cuticle over tender parts, the soles of feet which have been blistered, and the nipples of females for several days before delivery. The action of B. externally appears to be strictly chemical, as it coagulates the albumen of blood, and otherwise tends to render more solid all flesh tissue.

The duty on B. imported into Great Britain, which from 1814 had been as high as 22s. 10d. a gallon, was reduced in 1846 to 15s., and in 1860 to 8s. 2d. The consumption in the United Kingdom has since 1822 been on an average about 1,400,000 gallons. A considerable increase may now be expected. For further statistics, see SPIRITS.

BRANDYWINE CREEK, a stream of 36 miles in length, rising in Pennsylvania, and flowing through Delaware. In the latter state, it enters Christiana Creek, about 2 miles above its confluence with the Delaware River, and immediately below Wilmington, a port of entry. It possesses a historical interest in connection with the War of Independence—a battle, in which the British had the advantage, having been fought on its banks in September 1777.

BRANK, or **BRANKS**, an instrument formerly used for the punishment of scolds in England and Scotland, and often in the former country called 'the scold's bridle.' It seems to have come in place of the ducking-stool or cucking-stool (q. v.). 'I look upon it,' says Dr Plot in his *Natural History*

of *Staffordshire*, published in 1686, 'as much to be preferred to the cucking-stool, which not only endangers the health of the party, but also gives the tongue liberty betwixt every dip: to neither of which is this at all liable; it being such a bridle for the tongue as not only quite deprives them of speech, but brings shame to the transgression, and humility thereupon, before it is taken off.' The B., in its simplest form, is a hoop of iron, opening by hinges at the sides, so as to enclose the head, and fastened by a staple with a padlock at the back; a plate within the front of the hoop projecting inwards, so as to fit into the mouth of the culprit, and by pressing upon the tongue, be an effectual gag. There must have been difficulty in keeping such a hoop in its place; and so it received the addition of a curved band of iron, having a triangular opening for the nose, passing over the forehead, and so clasping the crown of the head that escape from it was scarcely possible. This may be regarded as the second form of the brank. In the third form, the curved band was hinged in the middle, and, passing over the whole head, was locked into the staple at the back of the hoop. The next addition seems to have been a second band crossing the first at right angles, so as to clasp the sides of the head, and keep the B. still more firmly in its place. In its last most complicated shape, the B., by the multiplication of its hoops and bands, took the form of a conical cage or lantern, with a door behind opening by a hinge and fastened by a staple, the front being fashioned into a rude mask, with holes for mouth, nose, and eyes. In one instance, the mask quite covers the face, the iron plate being

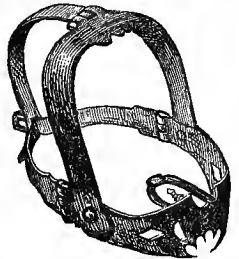

Branks.

called *England's Grievance Discovered in Relation to the Coal Trade*, published in 1655, and dedicated to Cromwell: 'John Willis of Ipswich, upon his oath, said that he was in Newcastle six months ago, and there he saw one Arne Bidlestone drove through the streets by an officer of the same corporation holding a rope in his hand, the other end fastened to an engine called the branks, which is like a crown, it being of iron, which was muzzled over the head and face, with a great gap or tongue of iron forced into her mouth, which forced the blood out; and that is the punishment which the magistrates do inflict upon chiding and scolding women, and that he hath often seen the like done to others.' When the B. first came into use is unknown. It is found at Edinburgh in 1567, at Glasgow in 1574, at Stirling in 1600, and at Macclesfield, in Cheshire, in 1623. One B. in the church of Walton-on-Thames, in Surrey, has the date of 1633. In another, called 'the witches' bridle of Forfar,' dated in 1661, the gag for the mouth is not a flat plate, but a long piece of iron with three sharp spikes. Of two examples in private custody in England, one has the date of 1688, the other the crowned cipher of King William III. The B. was used at Langholm, in Dumfriesshire, in 1772: it was used still more recently at Manchester and at

Macclesfield; and in the *Archæological Journal* for 1856, it is stated that 'at Bolton-le-Moors, in Lancashire, the iron bridle was still in use, not many years since, for the correction of immorality: it was fixed in the female's mouth, and tied at the back of the head with ribands, and thus attired, the offender was paraded from the cross to the church steps, and back again.' Examples of the B. may be seen in the Ashmolean Museum at Oxford, in the National Museum of the Antiquaries of Scotland at Edinburgh, in the county hall at Forfar, in the Guildhall at Lichfield, in the town hall at Macclesfield, in the parish church of Walton in Surrey, and in St Mary's Church at St Andrews in Fife.—Brank was at one time a common name in Scotland for any sort of bridle. The word is supposed to be derived from the Teutonic *pranghe*, a bridle. In the Dutch Netherlands, the pillory was called *pranghe*, from the yoke or collar in which the neck of the culprit is held. An instrument resembling the B., in its simplest form, is said to have been in use among the Spaniards in the West Indies for the punishment of refractory slaves.

BRANTOME, PIERRE DE BOURDEILLES, SEIGNEUR DE, was born at Perigord, in Gascony, about 1527. He travelled in several countries in the capacity of chamberlain to Charles IX. and Henry III.; fought against the Huguenots (1562), in Barbary (1564), and went in 1566 to Malta, to fight against the Turks. After his return to the court of France, he retired into private life, and wrote his *Mémoires*, full of self-praise but very interesting, as they afford a lively portraiture of the manners and morality of his times, the women, in particular, being very severely handled. The style is charmingly piquant, full of ingenious turns of expression, sudden sallies of wit, occasional flashes of eloquence, and withal so naively simple, that if the author cannot on account of the abundance of his gossip be reckoned a grave historian, he must needs be considered a most fascinating chronicler. B. died July 15, 1614. His complete works were published at the Hague (10 vols. 1740), and have been recently republished by Buchon in the *Pantheon Littéraire* (2 vols., Paris 1837).

BRASDOR'S OPERATION. It is stated in the article ANEURISM, that a cure is effected in that disease by successive layers of the fibrine of the blood being deposited in the aneurismal sac, and

that surgeons bring about this desired end by tying the artery at some point between the heart and the aneurism. In some situations it is impossible to do this, and therefore it was suggested by Brasdor that the course of the blood should be impeded *beyond* the aneurismal sac. This has not been tested to any great extent, but most surgeons think favourably of it; and the same principle can be carried out by pressure,

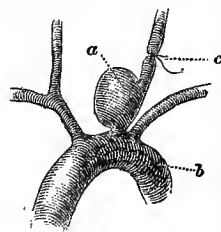

Brasdor's Operation.
a, aneurismal sac; b, arch of aorta; c, artery, tied.

without any cutting operation, as has been shewn by Mr Edwards of Edinburgh, who has succeeded in obliterating aneurisms at the root of the neck by pressure applied to the arteries beyond the tumour.

BRASENOSE, one of the colleges of Oxford University, sometimes called King's Hall and College of Brasenose, was founded in the year 1511, by the joint benefaction of William Smith, Bishop

of Lincoln, at one time Chancellor of the University, and Sir Richard Sutton, Knight of Prestbury, in Cheshire. The original foundation was for a principal and twelve fellows. Eight fellowships were afterwards added by various benefactors, from 1522 to 1586. This college is also very rich in scholarships and exhibitions; more particularly the Hulme exhibitions, 15 in number, of value £120 per annum each, besides £35 to be spent in books, to be selected by the principal. The statutes of this college, which were issued in 1520, three years after the publication of Luther's theses, seem to have been framed by a person warmly attached to the Roman Catholic faith. They enjoin devotional exercises of a peculiarly popish character, such as repeating five times each day the Lord's Prayer in honour of the five wounds of the crucifixion, of the angelic salutation in honour of the five joys of the blessed virgin, &c. These devotions are in some cases enforced by fines and whipping. The origin of the name of the college is obscure. Legends say that it was originally 'Brewing-house,' which became corrupted into the present appellation; but Anthony Wood tells us that the college was 'near finished out of the ruins of several hostels, the chief of which was Brasenose Hall, so called, without doubt, from such a sign, which was in ancient time over its door, as other halls also had, viz., Hawk or Hieron Hall, Elephant, Swan, or Bull Hall.' The former theory is supported by the fact, that B. has always been celebrated for the excellence of its beer; the latter is borne witness to by a nose in brass, curiously fashioned, which is now conspicuous over the great gateway. Till lately, all the fellowships were confined to natives of certain counties. The senior fellowships, owing to the appropriations of fines to the seniors, were very valuable, about £500 per annum; while the junior fellowships were about £80. By the commissioners appointed under 17 and 18 Vict. c. 81, many important alterations have been introduced. Five out of the twenty fellowships have been suppressed, one being elevated to the endowment of a professorship, the remaining four to the establishment of additional scholarships. All the remaining fellowships have been thrown open. The senior fellowships have been limited to £300 per annum; the junior raised to £150. Various oaths, previously taken by the fellows, committing them to statements which were untrue, and hindering them to duties impossible to be performed, have been by the same authority abolished. B. presents to 33 benefices, besides 29 pieces of preferment vested in the trustees of the Hulme exhibitions, for behoof of the exhibitioners. Though considered what is commonly called a 'good college,' B. has never attained much distinction in the 'schools.' In all probability this has been owing to the restrictions subject to which its endowments were so long administered. The number of names on the books, in 1860, is about 400, the number of resident undergraduates probably about 70.

BRASH. See WATER-BRASH.

BRASH, SHIVERS, BLAZE, and RUBBLE, are names given in different districts to layers of broken and angular fragments of rock. They occasionally form the basement bed of alluvial deposits. At Canonmills, and other places near Edinburgh, the boulder-clay rests on a bed of shivers composed of fragments of the subjacent bituminous shale.

BRASIDAS, the bravest and most energetic Spartan general in the earlier years of the Peloponnesian war. Having distinguished himself (B. C. 431)

by the courage with which he relieved the town of Methone from a hostile attack, he was made one of the chief-magistrates of Sparta. In 424 he relieved Megara; and in his expedition to Macedonia, in the same year, to aid the states which had thrown off their allegiance to Athens, he was completely successful. In 422, B., who could obtain no reinforcements from Sparta, had to encounter with his helots and mercenaries the flower of the Athenian army under Cleon. A battle took place at Amphipolis, in which both Cleon and B. were killed, but the army of the former was completely beaten. He was buried at Amphipolis, within the walls, and for long after his death his memory was honoured as that of a hero, by the celebration of yearly sacrifices and games. The Greek writers speak highly of Brasidas. Thucydides notices his eloquence, unusual in a Spartan, his justice, liberality, and wisdom, while Plato compares him to Achilles; but circumstances are not wanting to shew that he was as much endowed with Spartan duplicity as with Spartan courage.

BRASS is an alloy of copper and zinc, largely used for household furnishings, certain parts of machinery, and other ornamental and useful articles. Technically, the term B. is extended so as to include compounds of copper and tin, as in *brass-ordnance*, the *brasses* or bearings of machinery, &c.; but such alloys of copper and tin, though styled *hard B.*, are more strictly varieties of BRONZE (q. v.), and the present notice will be confined to the alloys of copper and zinc, or *yellow brass*. In ancient history, biblical and profane, frequent allusions are made to the employment of B. in the construction of musical instruments, vessels, implements, ornaments, and even gates; but as no mention is made of its mode of manufacture, or even of its composition, it is doubtful if the B. of the ancients was composed of copper and zinc. In the manufacture of B. on the large scale, two parts by weight of copper to one part of zinc are used, the zinc being one-half the weight of the copper; but alloys are made for particular purposes with less or greater proportions of zinc. Thus, where a material of more than ordinary tenacity is required, the zinc is reduced to one-fourth the weight of the copper; and where an alloy of a hard and brittle nature, possessing little resisting power, is wished for, the zinc is increased to an amount equal with the copper, or greater. In the manufacture of B., either of two processes may be followed. The direct method is to fuse the zinc in a crucible, and gradually add the copper in pieces. But this process is attended with disadvantage, owing to the volatile and oxidisable nature of zinc. The indirect method of forming B. is that which is generally followed in England and elsewhere, and consists in heating in crucibles or pots a mixture of calamine (carbonate of zinc, $ZnCO_3$), charcoal, and thin pieces of scrap or grain copper. The calamine (q. v.) is generally first calcined or roasted, so as to expel any traces of sulphur, then mixed with one-fourth of its weight of charcoal, and this mixture introduced into the crucible, after which the metallic copper is diffused through the mixture by being beaten in with hammers or mallets. The proportions employed are 3 parts of the mixture of calamine and charcoal to 2 parts of copper; and when introduced into a furnace, and subjected for 5 to 24 hours to the action of a white heat, the charcoal reduces the calamine and separates the zinc, which, combining with the copper, forms 3 parts of B., containing about 2 of copper to 1 of zinc.

For ordinary purposes, B. is first cast into plates of about 100 lbs. weight, and $\frac{1}{4}$ to $\frac{1}{2}$ inch thick, which can be readily broken up, remelted, and cast

in a mould of any desirable shape or size. The crude casting so obtained is generally screwed to a turning-lathe, and turned and bored into the required form with iron tools. B. is very largely employed in the construction of door-handles, window-shutter knobs, &c.; and since the introduction of gas, though the brazen candlesticks have almost ceased to exist in towns, yet the immense number of stop-cocks, and brass-pendants and brackets required, has given a considerable impetus to the brass manufacture. The proportion of copper and zinc in the alloys resembling B., and which are known as *gilding metal*, *Mannheim gold*, *pinchbeck*, *bath metal*, *Bristol brass*, *Muntz sheathing metal*, *spelter solder*, and *Mosaic gold*, have already been noticed under ALLOY (q. v.).

BRASSARTS, the name of the pieces which, in plate-armour, protected the upper part of the arms, and united the shoulder and elbow pieces. Brachiale was the ancient name for brassarts. When the front of the arm only was shielded, the pieces were called demi-brassarts.

BRASSES (*sepuichval*), large plates of brass, or of the mixed metal called *latten* or *laton*, inlaid on slabs of stone, and usually forming part of the pavement of a church. The figure of the person intended to be commemorated was generally represented either by the form of the brass itself, or by lines engraved on it. Such, however, was not always the case, an ornamented or foliated cross, with other sacred emblems, being frequently substituted for the figure. Nor was the practice of imbedding them in the pavement uniform, as we sometimes find them elevated on what were called altar-tombs. It has been ascertained that the incised lines on these B. were originally filled up with some black resinous substance, and that in the case of armorial decorations, and the like, the field or background was often cut out by the chisel, and filled up with some species of coarse enamel, by which means the appropriate tinctures were produced. In England, the brass was usually of the form of the figure, the polished slab forming the ground, and the ornaments, arms, inscription, &c., were also inserted each as a separate piece. On the continent, where the metal was more abundant, the B. were one long unbroken surface, formed of plates soldered together, on which were engraved all the objects represented, the portions of the plate not so occupied being ornamented by elaborate flower-work. B. are known to have been used for monumental purposes from a very early period, though there are no existing traces of them in England previous to the middle of the 13th century. There is reason to think, that if not imported from France, they were at first executed by French artists. Latterly, the art took root in England, and English B., like English architecture, acquired a distinctive national character. The oldest complete specimen in England is that on the monument of Sir John d'Aubernoun, at Stoke Dabernon. The knight died in 1277, and it is probable that the brass was executed shortly after that date. Next in antiquity are those of Sir Roger de Trumpington, who died in 1289, and of Sir Richard de Buslingthorpe, 1290; the former at Trumpington in Cambridgeshire, the latter at Buslingthorpe in Lincolnshire. In addition to the interest which they possess from their age, these B. are remarkable as being still unsurpassed in the beauty of the workmanship and the spirit of the design. As regards the earliest English B., it is further worthy of note that they are so similar, both in design and execution, as to lead to the conjecture that they are the work of one artist; whilst from their differing in many respects from the B. which were executed

on the continent at the same period, it would seem that this artist, if not an Englishman, at all events worked exclusively in this country. In the following century (1325), on the brass of Sir John de Creke, at Westley Waterless, in Cambridgeshire, the artist's



Inlaid brass Monument of Eleanor Bohun, Duchess of Gloucester. About 1400.

mark is affixed by a stamp—a fact which has been regarded as a proof that his craft had attained to some importance, and that his services were pretty frequently called into requisition. But in this case, as in every other, with one exception, the name of the artist has perished. The exceptional case is that of the brass which once covered the tomb of Bishop Philip, in the church of the Jacobins at Evreux, in Normandy, where the inscription ended with the words, 'Guillaume de Plalli me fecit.' Many of the B. executed in England in the 14th c. are probably Flemish; and in the churches at Bruges some exist which appear to be by the same hand with others which are found in England. There can be little question, indeed, that for this, as for most of the other departments of the arts, which were afterwards successfully cultivated in England, we were indebted to continental artists. Nor will it surprise those who know the results of recent archaeological investigations in similar subjects, to learn that the artists of France and Flanders in their turn were debtors to those of the worn-out empire of the East. As in painting, sculpture, and architecture itself, so in the art of working in brass, the sparks of antique genius which smouldered in Byzantium were the means of kindling those

which afterwards burned so brightly in modern Europe. The taste for lingering

Among the knightly brasses of the graves,
And by the cold *hic jacet* of the dead,

has grown to something like a passion of late, and there are few subjects which have been more carefully illustrated than that of sepulchral brasses. References to most of the leading works, too numerous to be mentioned here, will be found in Parker's *Glossary of Architecture*, in an article in which their results have been carefully condensed. Of modern B., the most remarkable is that in the Cathedral at Cologne, engraved in 1837, as a monument to the late archbishop.

BRASSICA, a genus of plants of the natural order *Cruciferae* (q. v.), distinguished by a round and tapering 2-valved pod (*siliqua*), of which the valves have each only one straight dorsal rib and no lateral veins, the seeds globose, in one row in each valve, and the cotyledons (q. v.) conduplicate (folded laterally). The species are chiefly natives of the temperate and colder regions of the old world; several are British plants. A number of species are very extensively cultivated, both in fields and gardens, and are of great importance in an economical point of view, particularly the **CABBAGE** (q. v.), of which Kale, Borecole, Colewort, and different kinds of Greens, Savoy, Cauliflower, Broccoli, Brussels Sprouts, and Kohl Rabi are varieties; **TURNIP** (q. v.); **RAPE** (q. v.) (Colza, Cole-seed) and **NAVEW** (q. v.). Among the British species is one, called Isle of Man Cabbage, or Wallflower Cabbage (*B. monensis*), which differs from all these, and in some measure departs from the strict generic character, in having the valves of the pod 3-nerved, and one or two seeds in its beak. It has deeply pinnatifid leaves. It is found on the sandy shores of the west of Scotland, the Isle of Man, the north of Ireland, &c. Sheep and oxen are very fond of it, and it has been suggested that it might be profitably cultivated for feeding cattle. Its peculiar adaptation to sandy soils ought to recommend it to attention.

BRAUN, AUG. EML., an eminent archaeologist, was born 19th of April 1809, at Gotha, in Germany. He studied at Göttingen and Munich, where he made the friendship of his teachers, Schelling and Gerhard; with the latter of these he went to Rome in 1833, and in a short time was made librarian, and subsequently secretary, to the Archaeological Institute. He died at Rome, 12th September 1856. B. has written many valuable works on art in German, Italian, and even English. Among these may be mentioned, *Il Giudizio di Paride* (Paris, 1838), *Kunstvorstellungen des geflügelten Dionysus* (Munich, 1839), *Griechische Mythologie* (Hamburg and Gotha, 1850), *Griechische Götterlehre* (Gotha, 1851—1855), *Vorschule der Kunstmythologie* (Gotha, 1854, with 100 copperplate engravings), translated into English by Mr Grant; and an admirable guide-book, *Die Ruinen und Museen Roms* (Brunswick, 1854), translated into English, 1855. B. also executed numerous electrotype copies of ancient works of art.

BRAUNSBURG, a walled town of East Prussia, in the government of Königsberg, about 35 miles south-west of the city of that name. It is situated on the Passarge, which divides the town into two parts; and has manufactures of woollen and linen, and a considerable trade in yarn, grain, ship-timber, &c. Pop. 8360.

BRAUWER, or **BROUWER**, **ADRIAN**, a painter of the Flemish school, was born at Oudenarde (or as others say, at Haarlem) in 1608. He was apprenticed to the well-known artist Franz Hals, who made profitable use of his pupil's great talents;

keeping him in a garret like a prisoner, and making him work almost night and day, in painting small pictures, which Hals sold at very good prices. By the advice of a fellow-pupil, Adrian Van Ostade, young B. ran away from his hard taskmaster, and going to Amsterdam found, to his own astonishment, himself famous as a painter. He now worked for himself, and might soon have made a fortune; but his intemperance was so extreme, that, it is said, he would never apply himself to painting, while he could have credit or be supplied with liquor at a tavern. During the war in the Netherlands he went to Antwerp, where he was seized as a spy, and taken to the citadel. Here, to prove himself a painter, he executed a sketch of the guards who had him in their custody. This picture was shewn to Rubens, who immediately exclaimed: 'That is the work of Brauwer! no other artist could treat the subject in that style.' B. was liberated through the interposition of Rubens, who gave him a lodging, supplied him with clothing and food, and in every way acted as a generous friend. But the sole return for all this kindness was, that B. secretly fled from the house of his patron, in order to renew his career of low dissipation. After visiting Paris, and failing to find work, he returned to Antwerp, where he died in the hospital (1640), and was interred, at the cost of Rubens, in the Carmelites' Church. All B.'s paintings are marked by power and harmony of colouring, and clearness of chiaroscuro. They are pervaded by a jovial humour, and betray the favourite haunts and associations of the painter.

BRAVI, were those individuals in Italy, but especially in Venice, who undertook to perform any dangerous deeds for money. It is now employed chiefly to designate hired assassins. The Italians also gave the name of B. to those fanatics in the Turkish army, who, after maddening themselves by opium, rushed upon the ranks of the enemy, and so met death.

BRAVO, 'Excellent!' 'Well-done!' an Italian exclamation of praise, the superlative form of which is *Bravissimo!* It is commonly used in England without distinction of number or gender; but the Italians say *bravo!* to a male singer or actor, *brava!* to a lady, and *bravi!* to a company of actors or singers.

BRAVO DEL NORTE, or **RIO GRANDÉ**, the largest river in the Gulf of Mexico next to the Mississippi. It is politically important, as being throughout its whole course the boundary between Texas and Mexico; while physically its mouth may perhaps be regarded as that point on the coast where Central America, in its geographical aspect, begins to taper itself off towards the south. It rises in the Rocky Mountains, near lat. 38° N., and long. 106° 30' W.; and after a course of 1800 miles in a generally south-east direction, it enters the sea near lat. 25° N., and long. 97° W. The commercial value of the river is not great, for, besides being for the most part very shallow, it is here and there beset by rapids and sand-bars. Small steamers, however, have got up as far as Kingsbury's Rapids, about one-fourth of the entire length of the stream.

BRAVOURA, an Italian word, in music applied to a composition as well as style of performance. As a composition, the B. is an air or song, with many difficult passages and divisions of notes, requiring great spirit and volubility of execution. The intention of merely astonishing by execution has brought this species of composition into undeserved discredit. The B. style first came from the Neapolitan school. Rossini, Bellini, &c., united the B. with the cantabile style; and instead of leaving

the embellishments to the taste of the singer, wrote the whole of the notes in the music. The compositions of Mozart, Beethoven, &c., give abundant proofs of how they united true artistic merit with the B. style.

BRAWLING IN CHURCHES, in the law of England, is an offence against the public peace. This offence may generally be described as quarrelling or creating a disturbance in a church; therefore, mere quarrelsome words, which are neither an affray nor an offence in any other place, are penal here. It was enacted by 5 and 6 Edw. VI. c. 4, s. 3, that if any person shall, by words only, quarrel, chide, or brawl in a church or churchyard, the ordinary shall suspend him, if a layman, *ab ingressu ecclesie* (from entering the church); and if a clerk in orders, from the ministration of his office during pleasure. And if any person in such church or churchyard proceed to smite or lay violent hands upon another, he shall be excommunicated *ipso facto*; or if he strike him with a weapon, or draw any weapon with intent to strike, he shall, besides excommunication, have one of his ears cut off, or having no ears, be branded with the letter 'F' in his cheek. But this portion of the act was repealed by the 9 Geo. IV. c. 31, s. 1. Other regulations respecting the disturbance of a congregation, or molestation of a clergyman during the celebration of divine service, will be found in the 1 Mary, c. 3, passed in the year 1553, which, although of Roman Catholic origin and application, is still held to be the law for the protection of the Protestant Established Church. It enacts (section 2) that if any person or persons shall willingly and of purpose, by overt word or deed, molest or disquiet any preacher . . . in any sermon, preaching, or collation, that he shall make in any church, chapel, *churchyard*, or in *any other place or places*, used or appointed to be preached in; or (section 3) if any person or persons shall molest a priest preparing or celebrating mass, 'or *other such* divine service, sacraments, or sacramentals as was most commonly frequented and used in the last year of the reign of the late sovereign lord, King Henry VIII., or that *at any time hereafter* shall be allowed, set forth, or authorised by the queen's majesty;' or shall abuse the blessed sacrament—such person or persons shall be liable to be committed to gaol, there to remain without bail or mainprize for the space of three months then next ensuing; and further, to the next quarter-sessions, at which the persons so offending shall only be delivered and discharged out of prison upon sufficient sureties for their good behaviour during one whole year. The act contains other regulations for the protection of the ministrations of the church, and it saves the jurisdiction of the ecclesiastical law.

By another act, 1 Will. and Mary, c. 18, s. 18, passed in 1688, it is provided that if any person or persons shall disquiet or disturb any cathedral or parish church, chapel, or other congregation, or misuse any preacher or teacher, such person or persons may be committed to prison, and on conviction, be fined £20.

It remains to be added, that reviling church ordinances subjects to fine and imprisonment—and profaning the Christian religion, and depraving the Book of Common Prayer, are also subjects of penal legislation. See on this subject 1 Eliz. c. 2, and the 9 and 10 Will. III. c. 32. See also articles on **BLASPHEMY** and **OFFENCES AGAINST RELIGION**, in which latter the Scotch law on the subject of this article will be found stated.

BRAWN, a preparation of meat made from the head and belly-piece of a young pig, with the addition

of ox-feet, to render it gelatinous. The whole is rolled up tight in sheet-tin, and boiled for four or five hours. The moisture is then well pressed out of it, and having been allowed to stand for some ten or twelve hours, the meat is put into cold salt and water, and is then fit for use. B. seems to have been a well-known dish as early at least as the latter part of the 15th c., for in Tyndale's version of the Book of Common Prayer, revised by Cranmer, and still in use, in the 70th verse of the 119th psalm, we find the words: 'Their heart is as fat as *braxm*.' The B. of Wiltshire is celebrated, and it is also a famous dish in Canterbury.

BRAXY, BRAXES, BRAXIT, BRACKS. These words are given as synonymous in Jamieson's *Dictionary*, indicating a disease in sheep. In the dialect of Angus, it is called braik and bracks. The derivation of the word is uncertain. The vague way in which the term braxy is used, renders it difficult to define the disease, for in different parts of the country, totally different disorders are included under this head. Of the two most generally recognised as braxy, the one is an intestinal affection attended with obstinate diarrhoea, the other is a blood disease, and the result of plethora or fulness of blood. The first will be considered under the head **DIARRHŒA**; but the second, which is spoken of by the better informed shepherds as the true braxy, may be described here.

Causes.—A very lean flock of sheep placed on rich food is very apt to be decimated by braxy. By rich food is meant more particularly these substances containing an abundance of nitrogenous principles, such as luxuriant heather, strong and succulent grass, the best turnips, &c. Hilly land is favourable to the production of braxy, from the firm nature and nutrient qualities of food growing on it. We find the disease in such situations in the winter season. About the month of November, many of the well-fed hogs placed on turnips die suddenly from braxy; and, again, when farmers resort to the forcing-system towards spring, the mortality is great, particularly when, in addition to much artificial food, sheep are allowed rich pasture. The mortality is greatest at the period of full moon, from the sheep grazing during the light nights as well as by day. The shepherd very frequently at these times finds one or two dead in the morning. Some assert that, in the winter, exposure induces braxy; and it is very possible that it may be produced by any sudden check to the exhalations, which tend so much to maintain the balance of the functions and purify the blood.

Symptoms.—The animal, in full health, suddenly ceases to eat, has a staring look, is peculiarly excitable, and separates itself from the flock. The head is lifted high, the breathing becomes laboured, the countenance appears anxious, and the animal loses the power of its limbs. It totters, falls over, is seized with convulsions, and dies within five or six hours, and often within an hour from the first symptoms of the disease.

Cadaveric appearances.—If the sheep's throat is cut before it breathes its last, the absence of any peculiar appearances within the body is very remarkable: the flesh appears of a dark-red colour, and the veins are charged with dark blood, but, on the whole, the body of the sheep looks so well that the mountain-shepherd cuts it up to make 'braxy mutton.' If the sheep is allowed to die of itself, the body soon swells, putrefies, and is rendered useless.

Treatment.—The prevention of the disease alone affords hope, and it consists in regulating the animal's diet, to prevent sudden transitions from low to rich keep; to mix food so as to modify the

action of the more highly nitrogenised kinds; and to check the development of plethora or fulness of blood by saline purgatives and diuretics, such as Epsom and Glauber salts or nitre. The principles to be followed out in preventing this disease are precisely similar to those referred to under the head **BLACK QUARTER** in cattle. Shelter during severe winter weather is insisted on by shepherds as essential to prevent the malady.

Braxy mutton, above alluded to, is, as a general rule, not unwholesome; though in warm climates the same disease in sheep assumes a very malignant type, and indeed constitutes one of the carbuncular diseases. Though the flesh can be eaten with impunity in the mountains of Scotland, it is most dangerous and condemned in Southern Europe.

BRAYERA. See *Cusso*.

BRAZIL, the most extensive state of South America. Towards the interior, it borders on all the other states of that continent except Chili and Buenos Ayres—on Uruguay, the Argentine Confederation, Paraguay, Bolivia, Peru, Ecuador, New Granada, Venezuela, and Guiana, English, Dutch, and French; while its sea-board, beginning about 200 miles to the north of the Amazon, and reaching to within the same distance of the Plata, projects into the Atlantic fully 1000 miles to the east of the direct line—pretty nearly a meridian—between its two extremes. This immense country extends between lat. 4° 30' N. and 33° S., and between long. 35° and 70° W., being, in round numbers, 2600 miles long and 2500 broad. The area, according to official accounts, is 3,100,000 square miles. But B. was not always, in point of extent, what it now is. The Portuguese, who, in 1500, accidentally discovered the south-east coast of the country (but that only after one of the Pinzons had, on behalf of Spain, followed the shores of the continent from its eastern angle to the mouth of the Orinoco), claimed all between the Plata and the Amazon. Soon, however, the Spaniards of Buenos Ayres, feeling that the complete command of their mighty river was to them a necessary of life, colonised the left bank by founding Monte Video. But nearly twenty years earlier, B. had acquired more territory on the Amazon than it was to abandon on the Plata, having, in 1509, wrested from France, then at war with Portugal, what may now be designated Brazilian Guiana. It was only in 1531 that the Portuguese, busy as they were in India, here planted their first settlement. In 1578, B. fell, along with Portugal itself, under the power of Spain—a connection which, besides being essentially detrimental, speedily threw it as a prey into the hands of the Dutch Republic; and though Portugal regained its own independence in 1640, it was not until 1654 that B. was entirely recovered from the Hollanders. Thenceforward, the colony entered on a new era. Supplanted, in a great measure, throughout the east by the Dutch, the mother-country was now directing most of its attention to its possessions on either side of the Atlantic. About a century and a half later, a still more beneficial change—and that, too, arising from the mother-country's own disasters—was inaugurated in the colony. In 1808, under the pressure of French invasion, the monarchy, in the persons of the royal family, was virtually transferred from Portugal to B., an event which, doubtless through British counsels and influence, was immediately followed by the opening of the ports to foreigners. As a remoter benefit, too, of an incident which had no parallel either in English or in Spanish America, B., on shaking off, like its neighbours, the European yoke altogether, found a merely nominal revolution.

sufficient for its purpose, establishing, or rather accepting, an hereditary empire instead of restless and precarious republicanism; and ever since the transition-period of 1821—1825, this consolidated government, with subordinate institutions for local objects, has secured to B.'s twenty vast provinces comparative unity and peace.

The executive authority is vested in the emperor, who, besides being aided by a council of state, must act through responsible ministers. The legislature consists of two chambers, which sit four months every year. Both the deputies and the senators, who must have annual incomes respectively of 400 milrees and 800, are indirectly elected by voters who must possess 200 milrees per annum—the former for four years, and the latter for life. The senate, however, appears to represent the crown as well as the people, inasmuch as each constituency merely nominates three individuals for his majesty's choice of one. Justices of peace, also, are appointed by the respective communities; and in the courts generally, whether civil or criminal, there prevails trial by jury. The revenue in 1859—1860 amounted to £4,380,900, the expenditure to £4,455,229, while the public debt in 1857 amounted to £11,909,000. The army numbered in 1859, 22,586 regulars and 60,000 militia, besides a considerable police, well organised, and thoroughly equipped. In 1858, the navy mustered 55 vessels, 28 of which were steamers having 2752 horse-power. The population must now, in 1860, exceed 8,000,000, having, in 1856, amounted to 7,677,800.

Of the three grand elements of the population, Aboriginal, African, and European, the first bears a much smaller proportion to either of the others than in most parts of Spanish America. The Europeans, besides having been from the beginning rather actual colonists than mere adventurers, were necessarily shielded, under the circumstances of the revolution, from that undistinguishing fury which elsewhere expelled the 'Old Spaniards' as the natural enemies of the new republics. The Africans, again, continued to be imported till 1854; while the partial amalgamation of the two races gradually produced perhaps the finest variety of the mulatto in the world. Slavery, too, abolished as to the aborigines, is not unlikely soon to die a natural death altogether, as it has done in most parts of Europe. In addition to Saturdays, the negro has 35 holidays in the year, while he is entitled to buy his liberty at a just price—privileges which, independently of their specific worth, involve the pregnant and progressive principle, that both the slave, no longer a chattel, and the master, no longer a despot, have rights and duties in relation to each other. Roman Catholicism is the prevailing religion. Education is defective, there being not more than 2550 schools of all kinds in the empire, attended by 88,800 scholars.

But physically, as well as politically and socially, B. differs in many respects from most of the other divisions of the new continent. It knows nothing of the volcanoes and earthquakes of the Pacific coast; with winds blowing constantly from the Atlantic Ocean, it is exempted from those droughts which are always blighting one or other of the slopes of the Andes, the remoter slope in Peru and Chili, and the nearer in Buenos Ayres and Patagonia; its mines, again, are as famous for gold and diamonds as those of the Western Cordilleras for silver. In its hydrography, B. contrasts unfavourably with the other divisions. While the Amazon and the Plata, the Mississippi and the St Lawrence—not to mention countless rivers of inferior magnitude on both shores—are for the most part practicable almost to their sources, the streams of B.,

with the exception of the Amazon, are mostly impeded throughout by cataracts and shallows, thus counterbalancing, as it were, its matchless seaward facilities by the deficiencies of its inland communications. Further, the most navigable of these streams, instead of entering the open sea, mingle their waters with those of the Plata or of the Amazon—the Parana and the Uruguay joining the former, and the Madera, the Tapajos, the Zingú, and the Tocantins, the latter; and even among those that do send their tribute at once to the ocean, a similar direction is sometimes impressed by the dividing ridges—the San Francisco, for instance, by far the largest of them, running to the northward parallel with the south-east coast through 11° of lat., and leaving only 4° of long. for its remaining course to the Atlantic. These hydrographic peculiarities must be the more strongly felt, inasmuch as a humid surface and a luxuriant vegetation conspire to render ordinary roads all but impossible; and accordingly three railways, the Bahia, the Pernambuco, and the San Paulo, are in progress of construction, under a public guarantee of 7 per cent. a year on the capital subscribed.

Among the mineral treasures, besides gold and diamonds already mentioned, iron of superior quality is abundant; and salt, also, is extensively produced in saline marshes by the alternate processes, according to the season, of inundation and evaporation. The productions of the soil, which are, of course, equally various and rich, will be more satisfactorily considered under the heads of the respective localities. Suffice it to say, that the cotton is naturally excellent, and that the tea-plant of China has been introduced, though hitherto with indifferent success. The exports are necessarily different from the different sections of the country. From the north, they are coffee, cotton, cocoa, sugar, and tobacco; from the south, hides, tallow, horns, &c.; and from the middle, drugs, diamonds, gold-dust, dyes, rice, manioc, tapioca, spirits, and rosewood. Their total value in the year 1856—1857 was £12,722,600, the corresponding imports amounting to £13,761,773. The chief centres of foreign trade, and, along with San Paulo in the interior, the principal cities of the empire, are Para, Maranhão, Bahia, Pernambuco, and Rio de Janeiro. This last-named port, which is likewise the seat of government, is the favourite halting-place of the outward-bound vessels for India, China, and Australia.

BRAZIL NUTS are the seeds of the *Bertholletia excelsa*, a majestic and beautiful tree of the natural order *Lecythidaceæ* (q. v.). The tree grows to the height of 100 or 120 feet, and abounds on the banks of the Orinoco and in the northern parts of Brazil. It produces a round woody pericarp or seed-vessel, almost as large as a man's head, within which are many of the seeds or nuts. The pericarp is very heavy and solid, requiring a blow of a sledge-hammer to break it; and at the time when this great fruit is ready to fall, it is dangerous to walk under the tree. The seeds, which are popularly called nuts, and much resemble fruits of that description, are wrinkled and triangular, having a hard shell and a pure white kernel, which, when fresh, is very agreeable. They are chiefly exported from Para and French Guiana, and are well known in our shops. They yield a large quantity of oil, which is good for burning. The nuts or seeds of the *Lecythis ollaris*, or **POT TREE**, are produced in a pericarp which resembles a rusty iron pot with a lid, the lid dropping off and letting the seeds out, which are oblong, grooved, and esteemed of a very superior quality to the common

BRAZIL WOOD—BRAZING.

B. N. ; but they have not yet become an article of commerce, as the tree grows chiefly in the interior

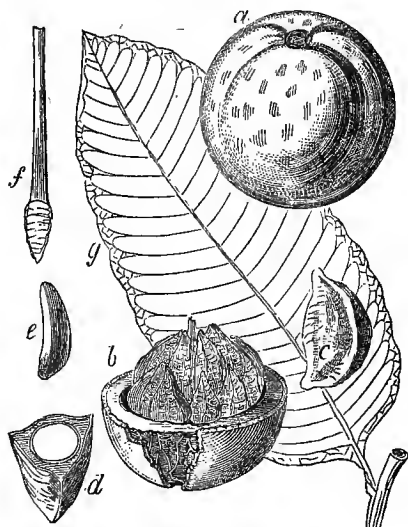

Brazil Nut :

a, the fruit ; b, the same, with half of the pericarp removed to show the nuts and seeds ; c, a single seed or nut ; d, a nut cut across ; e, a kernel of a nut ; f, the central placenta, to the lower end of which the nuts are attached in the pericarp ; g, a leaf.

parts of the country, from which the nuts are only occasionally sent to the coast.

BRAZIL WOOD, a dark-red or yellowish-brown dye-wood, which forms a considerable article

different species of *Caesalpinia* (q. v.). The best kinds are those called Pernambuco Wood, All Saints' Wood, and St Martha Wood. Much of the B. W. of commerce is obtained from *Caesalpinia Brasiliensis*, a tree which is a native of the West Indies, commonly growing in dry places and among rocks, and seldom exceeding 30 feet in height. It has bipinnate leaves, with many smooth, obtuse, oblong leaflets, and no terminal leaflets, the flowers in panicles, with downy stalks. The heart-wood alone is of any value.—**PERNAMBUCO WOOD** is the produce of *Caesalpinia echinata*, a prickly tree, with prickly pods, and of which the red and yellow flowers have a delicious smell, resembling that of the lily of the valley. The sap-wood is extremely thick, and the valuable heart-wood bears a small proportion to the whole diameter of the stem.—**The Sappan Wood** (q. v.) of the East Indies nearly approaches B. W. in quality. It is the produce of *Caesalpinia Sappan*, a small thorny tree.—**The BRAZILETTO WOOD**, sometimes also called B. W., which is brought from the Antilles, is much inferior. *Caesalpinia crista* probably yields some of the inferior West Indian Brazil-wood.—It is a curious circumstance, that B. W. is said not to take its name from Brazil, but to be mentioned under the name *Braxilis* in documents much older than the discovery of America, the Sappan Wood of the East Indies being probably intended, and the name of Brazil has even been supposed to be derived from that of this product of its soil.

When freshly cut, the colour of B. W. is yellow ; but when exposed to air, moisture, and light, it becomes red, and is generally sent into market ground down to the size of ordinary saw-dust. When treated with water, alcohol, or ether, the weathered B. W. readily yields up its red colouring matter, called *Brazilein*. The latter is supposed to be produced from the oxidation of a colourless substance called *Brazilin*, which exists in the original yellow wood of the tree. Strong decoctions of B. W. are used by the dyer and calico-printer in the fabrication of reds, browns, &c. ; it is also used in the manufacture of red ink. See **INK**.

BRAZILIAN GRASS, an incorrect popular name applied to a substance used in the manufacture of a very cheap kind of hats, known as B. G. hats, and also as *chip* hats. It consists of stripes of the leaves of a palm, *Chamærops argentea*, which are imported into Britain for this manufacture, and chiefly from Cuba. See **CHAMÆROPS**.

BRAZILIAN PLUM. See **HOG PLUM**.

BRAZING, or **BRASS SOLDERING**, is the process of uniting together two pieces of brass, two pieces of copper, or one of each, by means of a hard solder, partaking more or less of the composition and properties of ordinary *brass*. The edges or parts of metal to be joined are first filed bright, so as to be thoroughly clean, then there is strewed over the gap or crevice a mixture of the solder and borax. The solder employed varies in composition according to the kind of work, and may be rendered more fusible by the addition of a larger amount of zinc, but the general proportions are (1) 16 copper, 16 zinc, and 1 tin ; (2) 12 brass, 4 zinc, and 3 tin ; or (3) 18 brass, 3 zinc, and 2 tin. When the whole has been fused together, it is allowed to cool, and is then filed down to a coarse powder, in which state it is used. The borax is employed to form a glaze over the brightened surfaces, and thus prevent the oxidation of the metal, which would seriously interfere with B., and even stop the operation. An outward coating or layer of charcoal is likewise serviceable in the exclusion of the air during the B. of large pieces of metal. Where a very high heat is

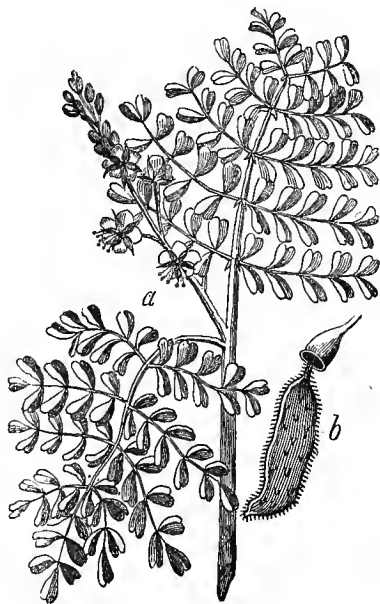

Brazil Wood :

a, a branch with leaves and flowers ; b, a pod.

of export from Brazil, where some of the trees which yield it are very abundant. It is the produce of

required in the process, a little powdered glass is mixed with the borax. The mixture of solder and borax may be applied dry, but it is better to moisten it with water, and to lay it on the filed surfaces with a spoon. The whole is then gently heated, when the water evaporates and leaves a crust of borax and solder. The work may now be strongly heated before the blow-pipe, or over a clear fire, and at a bright red heat the solder fuses and the zinc begins to burn with a pale-blue flame. At this stage, the solder *flushes* or becomes liquid enough to permeate the joint or crevice; but should it be tardy in acting thus, several slight taps will insure the proper result. The whole is now cooled, and, towards the close, the articles may be introduced into cold water for more rapid reduction in temperature. Pieces of metal which have undergone the process of B. are so firmly united that they may be rolled and re-rolled without the parts yielding. See **SOLDERING**.

BRAZOS DE DIOS, a river of Texas, North America, the second, if not the first, in magnitude that flows within the state. It runs towards the south-east, rising in the table-land of Bexar County, and falling into the Gulf of Mexico about 40 miles to the south-west of Galveston. With a course of about 900 miles, it is navigable at all times to a distance of 40 miles from its mouth, and at certain seasons to a distance of 300 miles. The valley of the river, the lower half being merely an alluvial plain, presents extensive forests, interspersed with plantations of maize, sugar, and cotton.

BRAZZA, an island in the Adriatic, belonging to Dalmatia, Austria, in lat. 43°—44° N., and long. 16°—17° E. It has an area of about 170 square miles, and a population of 15,495; and is separated from the mainland by a channel of some 8 or 10 miles in breadth. Its surface is mountainous, and extensively wooded; vines, yielding excellent wine, are grown in the valleys, and figs, saffron, almonds, and oil are produced in considerable quantities, but not much grain is raised. Bees and silk-worms are reared in large numbers. B. is also celebrated for its cheese, and the delicacy of the flesh of its lambs and kids. Excellent building-stone, which is largely exported, is found in the east part of the island. St Pietro di Brazza is the chief town.

BREACH, in siege-works, is a gap in any of the defensive walls or gates of a city; and *breaching* is the operation by which the gap is produced by the guns of the besiegers. *Breaching batteries* are employed, consisting of several pieces of ordnance, so chosen as to kind and size, and so placed as to distance, as to burst a hole through the defences in the shortest practicable time. The greatest effect is produced by lodging the balls in two vertical lines, from the parapet of the wall downwards, and in a horizontal line, connecting the lower ends of those vertical lines; and then overturning the mass of material thus loosened by an irresistible salvo or volley. When a hole has once been made, by thus knocking away the masonry or earthwork, the breaching is continued until the crumbling mass has so accumulated as to form a practicable slope, up which the storming-party of the besiegers may run. See **ASSAULT**. During the Peninsular war there were some formidable examples of breaching. At Badajoz, 14,000 shot brought down 180 feet of wall in 104 hours, from a distance of 450 yards. At Ciudad Rodrigo, 6700 balls brought down 105 feet of wall in 32 hours, from a distance of 560 yards. At St Sebastian, 13,000 shot brought down 100 feet of wall in 62 days, from a distance of 620 yards. It was calculated, from these and other instances, that

10,000 24-lb. shot, or 240,000 lb. of iron, will breach 100 feet of wall from a distance of 500 yards—the wall being of fair average masonry, and the height and thickness a fair average of those used in fortified towns. It must be remembered, however, that this estimate was made before the days of rifled cannon and Armstrong guns; and, on the other hand, that the walls adverted to were not constructed of granite.

BREACH, in law, signifies a breaking or violation of a right or of an obligation or engagement legally binding; and in this sense it has numerous applications, of which the following are those more particularly treated in law-books:

BREACH OF ARRESTMENT, in the practice of the Scotch law, is the disregard or violation of the process of arrestment, or attachment, by the arrestee, or party in possession of the arrested or attached property, but who, notwithstanding, pays the sums or delivers the goods arrested; and such B. is viewed by the courts as a contempt. But at present the only consequence of the B. is, that the person guilty of it, where it is a question as to *money*, is liable in damages to the extent of the funds paid away, and the costs. Where goods are arrested, and the arrestment is removed on bail (or 'loosed on caution,' as the Scotch lawyers say), if the goods themselves cannot be recovered, or their value cannot be clearly ascertained, the surety or 'cautioner' is held to be liable for the original debt. See **ARRESTMENT**. In England, the disputing or disobeying a rule or order by a judge for attachment of a debt very nearly means the same thing. See **ATTACHMENT, GARNISHÉE**.

BREACH OF CLOSE is a trespass by which an unwarrantable entry is made on another man's land, for satisfaction of which injury an action will lie to recover damages. It is called a trespass for breaking a man's *close*, because every man's land is, in the eye of the law, enclosed and set apart from his neighbour's; and that either by a visible and material fence, as one field is divided from another by a hedge; or by an invisible boundary, existing only in the contemplation of the law, as when one man's land adjoins to another's in the same field. The liability to this injury attaches not only to the party himself trespassing, but also to trespass by his cattle. And the law gives the party injured a double remedy in this case, by permitting him to distrain the cattle till the owner shall make satisfaction, or else by leaving him to the ordinary remedy by action for the damage done.

But in some cases this trespass is justifiable; as where it is done in exercise of a right of way, a right of common, or the like; or where a man comes to demand or pay money payable on the particular land; or to execute, in a legal manner, the process of the law; or by the licence of the plaintiff himself. Also, a man may justify entering into an inn or public-house without the leave of the owner first specially asked; because when a man professes the keeping of such an inn or public-house, he thereby gives a general licence to any person to enter his doors. So a landlord may justify entering to distrain for rent; and a reversioner to see if any waste be committed on the estate, for the apparent necessity of the thing; and it has been held that the common law warrants the hunting of ravenous beasts of prey, as badgers and foxes, in another man's land, if no greater damage be done than is necessary, because the destroying such creatures is said to be profitable to the public. But in cases where a man misdemeans himself, or makes an ill use of the authority with which the law intrusts him, he is accounted a trespasser *ab initio*; as if one comes into a tavern, and will

not go out in a reasonable time, but remains there all night, contrary to the inclinations of the owner; such wrongful act is held to affect and have relation back even to his first entry, and make the whole a trespass. But a bare nonfeasance, as not paying for the wine he calls for, will not make him a trespasser, for this is only a B. of contract. See Blackstone and Stephen's *Com.* respecting 'civil injuries.'

In the Scotch law, the term *close* is not used, and not known—but there any violation of a right of property in land may be redressed by legal process, and in many cases form the ground of an action for the recovery of damages. See CLOSE. The term *Inclosure*, in Scotch law, has a different meaning, although the penalties for breaking such inclosure are somewhat analogous to those for breach of Close. See below, BREAKING INCLOSURE, and see TRESPASS.

BREACH OF COVENANT is one of those civil injuries by which is meant a violation of a covenant or agreement contained in a deed of conveyance, either to do or omit to do something, and which B. gives a right of action against the party who made the covenant and his representatives. See COVENANT.

BREACH OF CONTRACT is a general description of injury, by which is understood the violation of any contract or legal engagement, and for which, at law, damages may be recovered, according to the nature of the breach and character of the contract; and by the Common Law Procedure Act, 1854, jurisdiction is conferred upon the courts of common law, by which a plaintiff can compel a defendant to fulfil any precise or actual duty. But it is only in the courts of equity that complete relief is given by enforcing the specific performance of agreements or contracts. See CONTRACT; DAMAGES; SPECIFIC PERFORMANCE; EQUITY, JURISDICTION OF; CHANCERY, COURTS OF.

In Scotland, although there is no distinction between law and equity, the remedy for this injury is very much the same. The party wronged may either conclude for damages, or *ad factum prestandum*, or for both of these remedies.

BREACH OF DUTY may be legally defined as either the non-execution of an office, or the performance of it in such a way that the conditions on which it was undertaken are violated. Such misconduct may either violate the conditions of an express contract, or it may be equally opposed and do equal violence to any implied engagement or *assumpsit*, as it is technically called in the law of England, not from the express determination of any court or the positive directions of any statute, but from natural reason and the just construction of law, which assumes and intends that every man has engaged what his duty or justice requires at his hands. And he must do this with integrity, diligence, and skill; for if by his neglect, injury accrues to individuals, they have their remedy against him in damages. See CONTRACT, DUTY, OBLIGATION, DAMAGES, EQUITY, PERFORMANCE.

BREACH OF THE PEACE is an offence against the public tranquillity and safety, and is either felonious or not felonious. But the law on this subject will be best considered under *Offences* (q.v.). See SPECIALLY OFFENCES AGAINST THE PUBLIC PEACE.

BREACH OF POUND is an indictable offence, and means the breaking any *Pound* (q.v.), or place where cattle or goods distrained are deposited, in order to rescue them. When once impounded, such goods or cattle are understood to be in the custody of the law, and an action for treble damages will lie for illegally taking them out of pound upon a distress for rent. Further, it is enacted by the

6 and 7 Vict. c. 30, that if any person shall release, or attempt to release, cattle lawfully seized by way of such distress, from the pound or place where they shall be impounded, or on the way to or from such pound or place, or shall destroy such pound—he shall be liable to a penalty not exceeding £5, and in default, may be committed to the house of correction. See Stephen's *Com.*, vol. iii., and see DISTRAIN, DISTRESS, POUND, POUND BREAD.

BREACH OF PROMISE TO MARRY. See PROMISE OF MARRIAGE.

BREACH OF TRUST. See TRUST, BREACH OF.

BREAD. The earliest and most primitive way of making B. was to soak the grain in water, subject it to pressure, and then dry it by natural or artificial heat. An improvement upon this, was to pound or *bray* the grain in a mortar, or between two flat stones, before moistening and heating, and from this *braying* operation some etymologists propose to derive the word *bread* (as if *brayed*). A rather more elaborate bruising or grinding of the grain leads to such simple forms of bread as the *oat-cakes* of Scotland, which are prepared by moistening oat-meal (coarsely bruised oats) with water containing some common salt, kneading with the hands upon a baking-board, rolling the mass into a thin sheet, and ultimately heating before a good fire, or on an iron plate, called a *girdle*, which is suspended above the fire. In a similar manner, the barley-meal and pease-meal *bannocks* of Scotland are prepared; and in the East Indies (especially the Punjab and Afghanistan), as well as in Scotland, flour is kneaded with water, and rolled into thin sheets, as *scones*. The *passover cakes* of the Israelites were also prepared in this way. A similar preparation of wheat-flour, but where the sheet of dough is made much thicker, forms the *dampers* of Australia. The Indian corn-meal, kneaded with water and fired, affords the *corn-bread* of America. The kinds of B. referred to above are designated *unleavened*, as no leaven has been added to the dough to excite fermentation. Even in the time of Moses, however, *leaven* was employed in making bread. It is held probable that the Egyptians were the first to use leaven; that the secret afterwards became known to the Greeks; and that the Greeks communicated the process to the Romans, who spread the invention far and wide in the northern countries during their campaigns.

The grain of wheat is generally employed in the manufacture of B. among the better classes, and more advanced nations, though rye, barley, Indian corn, and rice are also extensively used. The average composition of the grain of wheat when dried, so as to evaporate about 14 per cent. of moisture, is

Gluten and albumen,	15½
Starch,	54½
Gum, sugar, oil, and fibre,	8½
Saline matter,	2

The proportion of these ingredients varies, however; and though the native country of wheat is unknown, yet it is found that, within the wheat zone (see WHEAT), the quality improves as we travel south. Thus, Scotch wheat is inferior to English, the latter to French, that to the Italian; and the finest wheat in the world is grown in Barbary and Egypt. The principal constituents of wheat may be separated from each other without much difficulty. Thus, if wheat-flour be placed in a cloth-bag with the mouth well closed, and the whole introduced into a basin of water, and pressed by the fingers for some time, the starch is squeezed through the cloth as a fine white powder, and the gluten is left in the cloth as a viscid or sticky substance.

BREAD.

Again, if wheat-flour be burned on a porcelain plate on a fire, or oven, or gas-lamp, till it can burn no longer, it leaves behind a small amount of ash or saline matter.

Previous to being employed in the fabrication of B., the grain of wheat undergoes the process of *grinding*, with the double object of reducing it to a fine state of division, and separating the more hard and indigestible parts. See **MILL**. During the grinding operations, the wheat as it passes from grain to flour nearly doubles its bulk. The products come from the dressing-machine divided into different qualities, a quarter of wheat yielding—

	Bushels.	Pecks.
Fine flour,	5	3
Second flour,	0	2
Fine middlings,	0	1
Coarse middlings,	0	0½
Bran,	3	0
Twentypenny,	3	0
Pollard,	2	0
	14	2½

In the making of bread in Great Britain, the finest flour is employed in making *firsts* or the *fine 4-lb. loaf*; a coarser flour is made into *seconds* or household B.; and a still coarser into *thirds* or coarse bread. There is no bran in *firsts*, but a greater or less proportion of the finer bran in *seconds* and *thirds*. In the making of good B. three things are absolutely requisite: flour or meal, yeast or leaven, and water containing salt. The yeast (q. v.), or leaven (q. v.), is added to give a start to the fermentation (q. v.) process, thereby supplying carbonic acid, which communicates a spongy or light texture to the bread. Leaven is the more primitive ferment, and is simply a portion of moistened flour or dough in which the putrefactive agencies have begun to work. It may be procured by allowing moistened flour to lie in a warm apartment (summer heat) for six or eight days, and when sufficiently formed, has an acid taste and reaction, and a somewhat fusty odour. When brought in contact with a new portion of flour and water, and incorporated therewith by kneading, it very quickly acts as a ferment, and develops partial fermentation in the whole. Hence it is that where leaven is used, it is customary to retain a portion of the leavened dough for the next baking. On the continent, leaven is still very extensively employed, especially in districts far from breweries. In Britain, yeast is generally used as the ferment.

The materials being at hand, and the proper benches, utensils, and oven being within reach, the baker takes a quantity of water and adds to it the yeast and salt; after which the flour is added, and the whole thoroughly and laboriously kneaded together till it assumes a ropy consistence. It is then called the *sponge*, and is placed in a kneading-trough in a warm place, which is styled *setting the sponge*. In a short time, the yeast begins to act on the gluten, starch, and sugar of the flour, compelling the latter to pass into alcohol and carbonic acid gas in every part of the dough, which thereby becomes inflated with innumerable air cavities. When the fermentation has sufficiently advanced, the baker takes the sponge, adds more flour, water, and salt, and a second time subjects the whole to a thorough process of kneading, to prevent portions being so far fermented as to become *sad*, and again allows the mass to lie in a warm place for a few hours. The dough swells considerably from distension by gas, and is weighed out into lumps of the proper size, which are shaped into loaves, constituting the *batches*, or placed in tin pans, and are allowed to lie for a short time till they get further distended. The oven has

previously been heated by flues, by heated air, or by wood being burned within it, to a temperature of at least 320° F., which is the lowest temperature at which B. can be baked, and ranging up to 572° F.; and when it has been thoroughly cleaned out, the loaves are introduced and placed on the floor, and the oven shut up. The heat acts in dissipating much of the water from the dough, in distending the air cavities more fully, and in partially *boiling* the starch and gluten of the dough, and developing some gum from the starch. Indeed, though the temperature of the oven is much higher, yet the loaves beyond the mere crust are bathed in an atmosphere of steam, and are never heated above 212°, as has been proved by direct experiments with the thermometer. One effect of the heat is to arrest any further fermentation (q. v.; see also **YEAST**). After several hours' baking in the oven, the length of time being determined by the temperature, the loaves are withdrawn, and allowed to cool. The brown appearance of the crust of loaves, and the pleasant taste of the crusts, are due to the action of the heat on the starch and the formation of dextrins (q. v.), a sort of gum. The number of quartern (4 lb.) loaves which a sack of flour weighing 280 lbs. yields, is 90. It will be apparent, therefore, that as 280 lbs. of flour yield 360 lbs. of B., that a good deal more water must be present in the latter than in the former; and, indeed, ordinary good wheaten B. contains about 45 per cent. of water. This water is retained even after the loaf is apparently dry, and even mealy, as the gum and gluten have a great affinity for water.

Improvements in the process of making B. are occasionally effected. Thus a form of yeast, called German barn or yeast (q. v.), has been introduced, which is more cleanly than ordinary yeast or leaven, but appears to be too rapid in its power of causing fermentation to be manipulated easily in the making of ordinary loaves, though it does well for pan-loaves and fancy B. in general. Ovens heated by flues are being constructed, instead of the primitive method of heating them by wood, which smokes the whole oven. Instead of raising the dough by the action of yeast, which decomposes a part of the flour and causes the loss of about 2 per cent., bicarbonate of soda and hydrochloric acid are sometimes employed. The proportion by this process are 4 lbs. of flour intimately mixed with 320 grains of bicarbonate of soda; to this is added a mixture of 300 grains of common salt in 35 ounces of water and 6½ fluid drachms of hydrochloric acid, sp. gr. 1.16, and the whole is kneaded and placed in the oven. When the mixture is made, the acid acts on the bicarbonate of soda, forming common salt, which is left in the dough, and carbonic acid is liberated at every point, and communicates a spongy texture to the dough. The disadvantage attendant on this mode of raising the dough is, that it is apt to leave too much common salt in the B. This is obviated by using water charged with carbonic acid, as described under **AERATED BREAD**. Sesquicarbonate of ammonia is employed to some extent in the preparation of rusks, ginger B., and other light fancy B.; when heated, it entirely passes into gas, and thus yields a very spongy mass. *Short-bread* is prepared from flour which has been incorporated with butter.

The appearance which good wheaten B. ought to present, is that of a vesicular or spongy mass, from which layers can be readily detached; and this, known to bakers as *piled B.*, is the best index of good wholesome and easily-digested bread. When the layers cannot be detached, and the loaf cannot be crumbled down by the fingers into a coarse powder, or the fragments be thoroughly soaked

BREAD.

and be readily diffused through water, but become a permanent tough mass of dough, the B. is imperfectly made.

Rye B. is very extensively used in northern European countries, where the soil being sandy is admirably adapted for the growth of that grain. It yields a flour darker than wheat-flour. It is almost equal in nutritive value to wheaten-bread. Barley and oats, which when used as B. are generally made into cakes or bannocks, possess also a composition not unlike wheat. Indian corn, which thrives luxuriantly on the American soil, and is largely used there for B., as also to a considerable extent in the Old World, is little different from wheat in the proportion of its ingredients. Rice is occasionally employed in making B., but it is not nearly so nutritious as wheat.

But although, with the exception of rice, the various kinds of grain do not sensibly differ in the amount of nutritious matter contained in the meal, yet there is a great difference as to the quality of yielding a light, spongy bread. In this respect, the flour of wheat excels all others. This quality seems to depend upon the mechanical structure of the gluten of wheat, which gives a glutinous, sticky consistency to the dough, rendering it impervious to the carbonic acid gas formed in it during the fermentation, so that the gas thus imprisoned swells it up. The meal of other grains forms a more granular and less tenacious dough, which allows the gas to escape with more or less ease as it is formed. It is thus impossible to make a light, spongy loaf of oat-meal, however finely it might be ground. In the case of whole-meal B. or brown B., the rough, hard particles of the bran interfere with the ordinary tenacious quality of wheaten-flour, and make the dough slightly porous, so that much of the gas escapes, and thus this kind of B. is never so much raised as B. of fine flour.

BROWN, COMPOSITION, or WHOLE FLOUR B. is made from the ground but undressed wheat, and therefore contains the bran as well as the flour. Some years ago it was suggested, that as the bran contained more nitrogenised matter than the flour, the whole meal must be more nutritious than the finer flour alone. But that opinion is now considerably modified; for while it is true that the whole meal (bran and fine flour) contains chemically more nutritive matter than the fine flour alone, yet the gritty particles that are present in the former, cause an unnatural irritation in the alimentary canal, and lead to a quicker evacuation of the but partially digested and absorbed food. This explains why brown B. possesses laxative properties, and why labourers fed on it consider that it makes them hungry soon again; they feel that it does not last in the stomach, and consequently think it has little nourishment in it.

The adulterations of B. are various. Very commonly boiled potatoes are added to the flour and water in the making of the dough, and some consider that this yields a lighter and more palatable bread. It must be remembered, however, that the addition of any substance of a nature foreign to the composition of any material is an adulteration (see next article); and that though potatoes may be supposed to improve the B., yet good B. can be made without them, and the addition of the potatoes lessens the nutritive value of the wheat-flour. Alum is occasionally added to the dough, to increase the whiteness and improve the general texture of the B.; and this it appears to do by arresting the passage of the starch into gum and sugar, which tends to take place during the process of baking. In Belgium, sulphate of copper

is often used for a similar purpose, but it is not employed in this country. All such admixtures are destructive of the nutritive value of a certain part of the B., and are injurious to the animal system. For the nutritive qualities of B. see **NUTRITION** and **FOOD**, and for biscuit-bread, see **BISCUIT**.

The law on the subject of bread, so far as relates to England and Scotland, is regulated by a local act for London, the 3 Geo. IV. c. 106, the provisions of which are extended to a general act for the country, the 6 and 7 Will. IV. c. 37. These provisions are as follow: B. may be made of flour or meal of wheat, barley, rye, oats, huckwheat, Indian corn, pease, beans, rice, or potatoes, or any of them, or with any common salt, pure water, eggs, milk, harm, leaven, potato or other yeast, and mixed in such proportions as bakers may think fit, and with no other ingredient or matter whatsoever; and with the exception of French or fancy B. and rolls, the B. so made must be sold by weight, and in no other manner, under a penalty not exceeding 40s.; and bakers must use the avoirdupois weight, under a further penalty of not less than £2, or more than £5. For this purpose, they must provide in their shops, on or near the counter, a beam and scales, with proper weights, or other sufficient balance, in order that the same may be weighed in the presence of purchasers—a regulation that also applies to delivery of B. by cart or other conveyance, it being directed that the scales and weights shall be constantly carried in the cart or other conveyance, under a penalty, in either case, not exceeding £5. From this regulation, however, fancy B., or French B., or rolls, are also excepted. The act further provides that B. made of mixed meal or flour—that is, B. made wholly or partially of pease, or beans, or potatoes, or of any sort of corn or grain other than wheat—shall be marked with the large Roman letter 'M,' under a penalty, in case this rule be neglected, of a sum not exceeding 10s. for every pound-weight of such mixed B. sold, and so on in proportion for any less quantity. From this regulation, however, is excepted B. made of the meal or flour of wheat, in the making of which potato-yeast shall be used.

The following are the enactments against the adulteration of B.: 1. No baker shall, in the making of B. for sale, use any mixture or ingredient whatsoever other than those above mentioned, under a penalty for every offence not exceeding £10, nor less than £5, with the alternative of imprisonment, with or without hard labour, for any time not exceeding six calendar months; and the offender's name, place of abode, and offence may be published in the local newspapers. 2. Any person adulterating corn-meal or flour, by the introduction of any ingredient not being the real produce of the corn or grain; or any person selling meal or flour of one sort of corn or grain as the meal or flour of another sort, whether separate or mixed, shall forfeit and pay, according to the discretion of the magistrate or justice, a sum not exceeding £20, nor less than £5. 3. Magistrates or justices of the peace, and also peace-officers authorised by warrant, may, at seasonable times in the daytime, enter a baker's premises, and search for adulterated flour or B.; and if any be found, the same may be seized, and carried with all convenient speed to the nearest resident magistrate or justice of the peace, to be disposed of as he may think proper, the penalties varying from £2 to £10, with alternative imprisonment for six months; the offenders' names may also be published. Parties obstructing such search of bakers' premises, or upon the occasion of the search, carrying away the adulterated flour or B., are liable to a penalty not exceeding £10. Should it, however, appear that

any offence against the act shall have been occasioned by the wilful act or the neglect of the baker's journeyman or other servant, the magistrate may issue his warrant for bringing such servant before him, and, on conviction, may adjudge him to pay a reasonable sum to his master, by way of recompense; and this payment must be immediate, otherwise the servant may be committed to prison for a month or ten days, with or without hard labour.

The act further provides that bakers shall not bake bread, rolls, or cakes, on the Lord's Day; or, on any part of that day, after half-past one o'clock in the afternoon, sell such bread, rolls, or cakes; or bake meat, pies, or other victuals; or in any other manner exercise the trade of a baker, save and except so far as may be necessary by way of preparation for the following day's baking. For a first offence against this regulation, a penalty of 10s. shall be paid; for a second offence, 20s.; and for a third and every subsequent offence, respectively, the penalty of 40s., together with the costs of prosecution, a portion of the penalty to be paid to the prosecutor, and the residue to be applied towards the poor-rate of the place. This regulation as to Sundays does not extend to Scotland.

The law of Ireland on the subject of this article is contained in several acts of the Irish parliament, the leading provisions of which are similar to the above.

BREAD, ARMY. The B. now supplied to the British troops, in camp and barrack, is contracted for by the commissariat department of the War-office. The contractors engage to make the B. of good and dry wheat, one-third white and two-thirds red, made into flour which shall be dressed through wire-cloth of the degree of fineness known as No. 60. The B. is to be as good as 'best seconds;' it is delivered at quarters every day, or every alternate day, in 4-lb. loaves. The regimental board of officers may examine the B., and may reject any if sour or otherwise bad. Such are the rules, but they are often departed from in practice. A contractor will sometimes send in a tender so low, in order to obtain the contract, that he cannot possibly make good B. at a profit; and then he relies on small fees paid to him secretly by the soldiers as a means of obtaining better. This discreditable state of things was ascertained by a committee of inquiry a few years ago; it was found that the average of army B. was not equal in quality to that of workhouse bread. The evil is now undergoing remedy; and experiments are also being made to determine whether troops can bake their own bread in the field, and even while on the march—a subject that will be further noticed under **COOKERY, ARMY.**

BREAD-FRUIT TREE (*Artocarpus incisa*), a tree of the natural order *Artocarpaceæ* (q. v.), a native of the islands of the Pacific Ocean and of the Indian Archipelago—one of the most important gifts of nature to the inhabitants of these regions, its fruit supplying the principal part of their food, and its inner bark a considerable part of their clothing, whilst its timber and its milky juice are also employed for economical purposes. The genus to which it belongs (*Artocarpus*, Gr., Bread-fruit) is distinguished by having the male flowers in catkins, with a 2-leaved perianth and one stamen; the female flowers naked; the fruit roundish, fleshy, and tuberculated. The B. T. is a rather slender tree, of 40–50 feet high, often rising almost half its height without a branch. It has large, pinnatifid leaves, frequently 12–18 inches long, dark green, and glossy. The fruit is generally oval, or nearly spherical, and about the size of a child's head. It is a *sorosis*, a compound or aggregate

fruit formed from numerous flowers on a common axis, and is covered with a roughish rind, which is marked with small square or lozenge-shaped divisions, having each a small elevation in the centre; is at first green; when imperfectly ripened, brown; and when fully ripe, assumes a rich yellow hue. It is attached to the small branches of the tree by a short thick stalk, and hangs either singly or in clusters of two or three together. It contains a somewhat fibrous pulp, which, when ripe, becomes juicy and yellow, but has then a rotten taste. At an earlier stage, when the fruit is gathered for use, the pulp is white and mealy, and of a consistence resembling that of new bread. In a still less mature state, the fruit contains a tenacious white milk. The common practice in the South Sea Islands is to cut each fruit into three or four pieces, and take out the core; then to place heated stones in the bottom of a hole dug in the earth; to cover them with green leaves, and upon this to place a layer of the fruit, then stones, leaves, and fruit alternately, till the hole is nearly filled, when leaves and earth to the depth of several inches are spread over all. In rather more than half an hour, the bread-fruit is ready; 'the outsides are, in general, nicely browned, and the inner part presents a white or yellowish cellular pulpy substance, in appearance slightly resembling the crumb of a wheat loaf.' It has little taste, but is frequently sweetish, and more resembles the plantain than bread made of wheat-flour. It is slightly astringent, and highly nutritious. Sometimes the inhabitants of a district join to make a prodigious oven—a pit 20 or 30 feet in circumference, the stones in which are heated by wood burned in it, and many hundred bread-fruits are thrown in, and cooked at once. Baked in this manner, bread-fruit will keep good for several weeks. Another mode of preserving it is by subjecting it in heaps to a slight degree of fermentation, and beating it into a kind of paste, which, although rather sour, is much used when fresh bread-fruit cannot be obtained. There are numerous varieties of the B. T. in the South Sea Islands, and they ripen at different seasons. The tree produces two, and sometimes three, crops a year. In the West Indies and South America, into which it has also been introduced, the bread-fruit has not come much into use as an ordinary article of food; but various preparations of it are reckoned delicacies.—The fibrous inner bark of young bread-fruit trees, beaten and prepared, is used for making a kind of cloth, which is much worn by the common people in the South Sea Islands, though inferior in softness and whiteness to that made from the paper mulberry (see **MULBERRY, PAPER**).—There exudes from the bark of the B. T., when punctured, a thick mucilaginous fluid, which hardens by exposure to the air, and is used, when boiled with cocoa-nut oil, for making the seams of canoes, pails, &c., water-tight, and as bird-lime.—The timber is soft and light, of a rich yellow colour, and assumes, when exposed to air, the appearance of mahogany. It is used for canoes, house-building, furniture, and many other purposes. It is durable when not exposed to the weather.—The **JACK** (q. v.) or *Jaca* (*A. integrifolia*), and the **DEPHAL** (*A. Lakoocha*), both large East Indian trees, belong to the same genus with the bread-fruit trees.

BREAD-NUT, the fruit of *Brosimum alicastrum*, a tree of the natural order *Artocarpaceæ*, and therefore allied to the bread-fruit, a native of Jamaica. The genus *Brosimum* is distinguished by male and female flowers on separate trees, in globose catkins, with peltate (shield-like) scales for perianth, and the fruit a one-seeded drupe. The B. tree has ovate-lanceolate evergreen leaves; it abounds

in a tenacious gummy milk. Its leaves and young shoots are much eaten by cattle, but deleterious qualities are developed in them as they become old. The nuts, boiled or roasted, form an agreeable article of food, and are eaten instead of bread. Their taste resembles that of hazel-nuts.—To this genus the *Palo de Vacca*, or COW TREE (q. v.), of Demerara is supposed also to belong.

BREAD-ROOM. In the navy, the biscuits are called *bread*, and the place where they are stored is the bread-room; it is carefully constructed, warmed before being filled, and kept as much as possible free from damp.

BREAD-ROOT. See PSORALEA.

BREAD-TREE. See CAFFIR BREAD.

BREADTH, in art, is a term which, though often used in a very indefinite manner, is not without a definite meaning. It signifies that peculiar disposal of the background of a picture which, without sacrificing or even concealing details, gives to the whole unity and harmony of effect. With the older landscape-painters, it was a common fault to produce the effect of distance either by a certain trick of light and shadow, or by one uniform hazy colour in which the individual objects were entirely lost to view, and *breadth* became *vacancy*. In this respect, their pictures contrast unfavourably with those of such modern painters as Turner, of whom Mr Ruskin has very truly said that 'the conception of every individual inch of distance is absolutely clear and complete in the master's mind—a separate picture fully worked out: but yet, clearly and fully as the idea is formed, just so much of it is given, and no more, as nature would have allowed us to feel or see; just so much as would enable a spectator of experience and knowledge to understand almost every minute fragment of separate detail, but appears to the unpractised and careless eye just what a distance of nature's own would appear—an unintelligible mass. Not one line out of the millions there is without meaning, yet there is not one which is not affected and disguised by the dazzle and indecision of distance. No form is made out, and yet no form is unknown.' On the subject of breadth Mr Ruskin has, moreover, the following very judicious remarks: 'It were to be wished that our writers on art would not dwell so frequently on the necessity of breadth, without explaining what it means, and that we had more constant reference made to the principle, which I can only remember having seen once clearly explained and insisted on—that breadth is not vacancy. Generalisation is unity, not destruction of parts; and composition is not annihilation, but arrangement of materials. The breadth which unites the truths of nature with her harmonies is meritorious and beautiful, but the breadth which annihilates those truths by the million is not painting nature, but painting over her; and so the masses which result from right concords and relations of details are sublime and impressive, but the masses which result from the eclipse of details are contemptible and painful.'

BREAKERS, in maritime language, are the waves that break violently over rocks lying a short distance under the surface of the sea. They cover that particular part of the sea with a foam, and produce a hoarse and often terrible roaring. 'Breakers a-head' is one of the most alarming announcements made by the look-out men of a ship, seeing that the B. denote the existence of sunken rocks which may, perchance, pierce the hull of the vessel.

BREAKING BULK, in the Scotch law, signifies making use of an article supplied in bulk, or in quantity; by which act one is said to break bulk, and is, in consequence, prevented from afterwards

objecting to it, and returning it to the seller. See SALE, CONTRACT OF.

BREAKING INCLOSURES is an expression to be found in Scotch law-books, and means the destruction or invasion of planting and inclosures by persons or their cattle. The punishment for this offence is provided for by several old Scotch statutes, the principal of which are two passed in 1661 and 1685 respectively. The penalties are pecuniary, with right to detain the cattle found trespassing, until such penalties, along with the damage and costs, are paid. See INCLOSURE, PLANTING AND INCLOSING.

BREAKWATER is a barrier intended for the protection of shipping in harbours or anchorages. It sometimes happens that, in front of a semicircular bay, a small island is so situated as to form a natural breakwater. This is to some extent the case with the Isle of Wight, which occupies such a position as to protect Portsmouth and Southampton on the south. In many other places, however, bays and harbours are without such screens. A pier may be so placed and constructed as to serve also the purpose of a B., but the term B. is generally confined to a structure used solely for protection, and not for berthing or traffic, and breakwaters are frequently insulated, so as to be cut off from any communication with the shore unless by water.

Plymouth B. is the best known of these engineering works. The sound or harbour, being open to the south, was so much exposed to storms that, early in the present century, it was determined to construct a B. across its mouth, with openings between it and the shore, on either side, for the ingress and egress of shipping. The works were commenced in 1812. The operations consisted in transporting along a tram-road large blocks of limestone got from a neighbouring quarry, shipping them in vessels fitted with trap-doors, and by means of these depositing them in the shape of a huge mound in the required situation. As soon as the stones began to appear above water, a perceptible benefit resulted in the relative calmness of the sound during the prevalence of storms; but the structure was frequently very roughly handled by the waves, which altered and flattened its shape. A severe storm in November 1824 threw a great portion of the stones over into the sound. It was not until 1841 that the works were finally completed, by the deposition of more than 3,000,000 tons of stone, and the expenditure of nearly £1,500,000. The B. is nearly a mile long, the central portion is 1000 yards; and two wings, of 350 yards each, extend from the ends of this at a slight angle. The open channels at each end, between the B. and the shore, are each about half a mile wide, and their depth is respectively 40 and 22 feet, at low-water. The B. is 133 yards wide at the base, and 15 at the top—the two sides being made very sloping for the security of the stones. The slopes and top are faced with masonry. The water-space protected by this B. comprises 1120 acres, and it is generally admitted that the money has been well spent on the work.

Holyhead B., now in course of construction, is formed of stone quarried in Holyhead mountain, drawn along a tram-way on a timber structure, and cast into the sea. It more resembles a pier than the B. at Plymouth, for it is attached at one end to the shore, and is intended to convert Holyhead bay or roadstead into a harbour of refuge. The works are still in progress. They consist of a mound of loose stones up to low-water, and ashlar upright walls with a parapet above that line.

Portland B. is expected to be of very great value, in converting into a harbour of refuge the

BREAKWATER—BREAM.

expanse of water between the Dorsetshire coast and the isle, or rather peninsula of Portland. An act of parliament was obtained in 1847, authorising the works. The B., starting from the north-east point of the isle, will stretch nearly due north for more than two miles, with one or two intervening openings for the ingress and egress of shipping. The works are steadily progressing, and are conducted more easily than those of any other great B.; for the isle contains an abundance of stone easily quarried, and the steep shores afford facility for lowering the stones rapidly. The work—which is an upright ashlar superstructure, with a parapet founded on a mound of rubble stones—is done chiefly by convict labour; the depth is about 50 feet at low-water. From the nature of the operation, any part of the B. becomes useful as soon as constructed, increasing the safety of Portland Bay as a harbour of refuge.

BREAKWATERS.—SECTIONS.

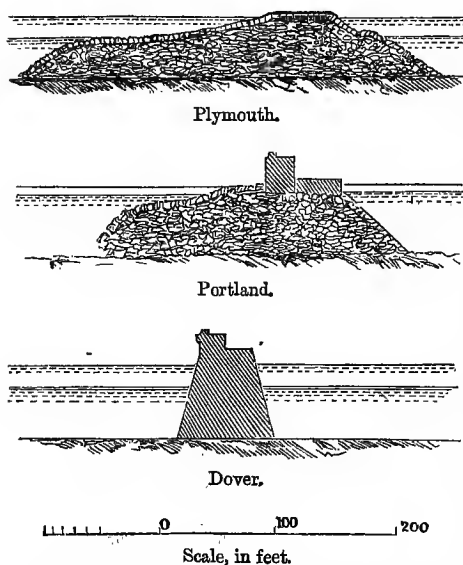

Dover B. progresses slowly, and involves an enormous outlay. There is no stone near to form a mound, as in the other breakwaters spoken of, and, in consequence, the work requires to be brought up in solid ashlar from the bottom by the diving-bell, with the interior formed of blocks of concrete. It has never been clearly stated whether the government regards this B. as a protection to a great naval station and fortified harbour, or as a chief feature as a harbour of refuge for commercial fleets. In 1844, a commission of inquiry recommended that £2,500,000 should be laid out in forming a harbour of refuge at this place. In 16 years only a small portion of the work has been done, consisting of a kind of pier jutting out from the western extremity of the harbour. The water is very deep—viz., 42 feet at low-water; the accumulations of shingle very troublesome; and many years must elapse before it can be made evident whether the Dover B. is worth the national money expended upon it.

Alderney B. is a great work, consisting of ashlar walls and parapet, built on a stone mound up to low-water from a depth of 72 feet. Small breakwaters have been constructed at Cette near Marseille, at the mouth of the Delaware in the United

States, and at Buffalo in Lake Erie; but they do not call for description.

Cherbourg B. is the greatest and the most costly ever constructed. About 80 years ago, M. de Cessart proposed to the French government the formation of a B. at Cherbourg, to be commenced by the construction of a number of hollow cones formed of timber-framing, sunk in a line as close as they could be placed to each other, and then filled with stones. These cones, of which there were to be 64, each about 70 feet high, 150 feet in diameter at the base, and 60 feet at the top, were intended to form a nucleus to the stone breakwater, to prevent the stones, during its formation, being knocked about and too much spread out by the action of the waves. In 1784 to 1788, 16 cones were constructed, and 13 of them sunk; but so great was the destruction which they underwent during stormy weather, that the government at length abandoned the plan, and carried on the stone breakwater without the aid of the cones. It has recently been completed at a cost exceeding £2,500,000. The B. itself was finished in 1853, but since that year large fortifications have been built upon the upper works. The length is nearly 2½ miles; the B. is 300 feet wide at the bottom, and 31 at the top. The chief mass consists of rubble or unshaped stones, thrown down from ships; but there is a larger ratio of wrought and finished masonry than in the Plymouth B., consisting of granite blocks imbedded in cement. The depth of water is about 60 feet at low-water spring-tides; and the B. rises to 12 feet above high-water level. The water-space included within and protected by the B., is about 2000 acres, but two-thirds of this has scarcely depth enough for the largest sized ships. The relation which this B. bears to the vast military and naval arrangements of the place will be noticed under CHERBURG.

Many substitutes have been proposed for solid breakwaters, such as floating breakwaters constructed of timber framework, open iron screens, &c., but none of them have been shewn to be suitable for actual practice. Close timber-work, filled in with stones, is found to be quite efficacious; but on most of our coasts the timber is liable to be eaten by the marine worm, which is an almost insuperable objection to its being used under water.

BREAM, a name which is apt to occasion some confusion to beginners in ichthyology, being applied equally to certain fresh-water fishes of the family *Cyprinidae* (q. v.), and to certain sea fishes of the families *Sparidae* (q. v.) and *Chatodontidae* (q. v.) or *Squamipennes*, among which the resemblance is a mere general one of outward form, the first of these families belonging to the order of *Malacopteros*, or soft-finned, the other two to that of *Acanthopteros*, or spiny-finned fishes.

The breams of the family *Cyprinidae* were included in the genus *Cyprinus* (see CARP) by the older naturalists, but are readily distinguished from that genus as now defined, and from other allied genera, by their deep and compressed form, by the great convexity of both the dorsal and the abdominal outline, by the want of spiny rays in the dorsal and anal fins, by the great length of the base of the anal fin, and by the want of cirri or barbules at the mouth. They form the genus *Abramis* of Cuvier.—The COMMON B., or CARP B. (*A. Brama*), is an inhabitant of many rivers and lakes of Europe, even as far north as Norway and Sweden, and of some of those of Britain and Ireland. It thrives best in still waters, and in some of the Irish lakes attains a large size; it has been known to reach 12 or even 14 pounds. The tail is very broad and much forked, the head small and acuminate, the

BREAM—BREAST.

eyes very large, the scales small, the general colour yellowish-brown, the cheeks and gill-covers silvery white.—The WHITE B., or BREAMFLAT (*A. Blicca*), differs from the Common B. in its silvery colour, the smaller number of rays in the pectoral and anal fins, and other particulars. It has never been taken of so large a size. It is found in many parts of the continent of Europe, and in some of the British lakes and rivers.—The POMERANIAN B. (*A. Buggenhagii*) differs much more widely from the Common B.; the body is much thicker in proportion to its depth, the scales larger, the base of the anal fin shorter, the tail less forked. This fish is known to occur in a few places of England and Ireland, and is said to abound in Pomerania.

The acanthopteroous Breams, or SEA BREAMS, are mostly of the family *Sparidae*, and nearly allied to the Gilthead (q. v.), in connection with which they

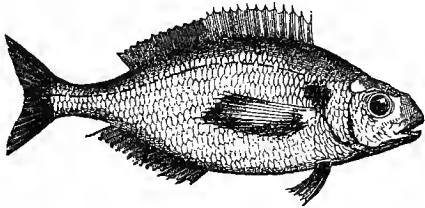

Common Sea Bream (*Sparus centrodontus*).

may most properly be noticed. The Common Sea B., indeed, often receives the name of gilthead. Only one of the British sea fishes called B., the *Brama Raiti* already noticed (see BRAMA), belongs to the family *Chatodontidae*.

Angling for Bream.—Of the two kinds of B. known to anglers, the carp B. is much the best for sport. The flesh of the B. is not held in much estimation, though the carp B. is infinitely to be preferred of the two. B. are found in both ponds and rivers. They prefer deep, still holes, or quiet, well-sheltered eddies in the bends of rivers. Here the angler will find them in large numbers. They are rather capricious in feeding; at times they will not bite for weeks together. Being a sly, shy-biting fish, the tackle required for them must be fine. They may be taken by means of the ledger (q. v.) in rivers, where they should be fished for in the same way as directed for barbel, save that it will be found advisable to use another hook, which should be fastened on to the line about eight inches or a foot above the ledger lead, as B. often take their bait some inches off the bottom. The hooks should be No. 7. In float-fishing for B. in holes or eddies, a stout swan-quill float and half-a-dozen No. 1 shot below it, will be found sufficient for the purpose; and having ground-baited as directed for barbel, put on two small red worms for the angling bait, or about an inch of the tail of a bright, well-scoured lob-worm. The former is preferable. Two hooks, one to rest on the bottom, and one 6 or 8 inches off it, will be found useful, for sometimes one will be taken, and sometimes the other. The fish being tender-mouthed, should be played gently. After the first rush, a B. soon tires, for his form is not fitted or shaped for a prolonged resistance. The B. has an unpleasant practice of boring downwards and rubbing the line with his tail, and the line often comes up covered with a thick slime from his body, for a foot or more above the hook. It is needless to remark that this must be cleared off before the tackle is again used. The rod should be a light cane-rod, moderately stiff, and some twelve or thirteen feet long for float-fishing for B. from a boat or punt.

Of all baits, worm is decidedly the best. Some recommend bullock's blood and grains to ground bait with, but worms are found to answer all purposes. B. spawn about the end of May, choosing the most weedy spots for that purpose; and after scouring and cleansing in some gentle gravelly stream for a week or two, they return to the deep still holes again. A clay or sandy bottom is preferred to any other. The presence of B. may always be detected by their fondness for coming at times to the top of the water, or, as anglers term it, 'primeing.' Early in the morning, or late in the evening, the whereabouts of B. may always be discovered by their rising then. In Lough Erne the shoals are prodigious, and cause a ripple on the water like a stiff breeze of wind.

BREAMING, in nautical affairs, is a cleansing process which a ship undergoes after a voyage, or after lying for a long time in harbour. The ship's bottom, under such circumstances, often becomes covered with grass, ooze, shells, or sea-weed; and B. consists in the removal of these impurities. The ship is laid aground after the tide has ebbed, or is docked, or is careened (see CAREENING); furze and fagots are placed under it; fire is applied; the heat melts the pitch, &c., of the hull; and the pitch and filth can then be scraped and brushed off.

BREAST, THE FEMALE, or mammary gland, consists of a series of tubes, radiating from a common centre, the nipple, which is situated in an areola or dark-coloured patch. On the surface of the latter are several (from 4 to 10) sebaceous glands, which secrete an unctuous fluid to protect the skin of the nipple, which is very thin, from the saliva of the sucking infant. The milk-tubes (15 to 18

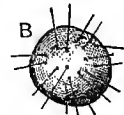
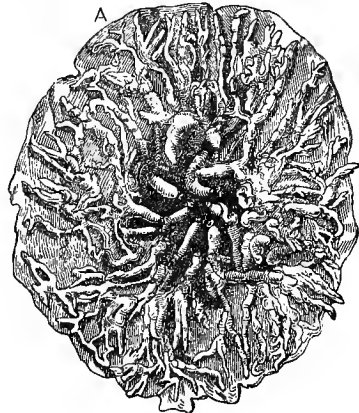

Breast :

A, lactiferous ducts dissected out and injected; B, nipple, with bristles inserted into the orifices of the lactiferous ducts.

in number) enlarge into *sinuses*, and pass each to a separate lobe or subdivision of the breast, where they divide into twigs and branches (the *lactiferous ducts*), which end in minute vesicles. The lobes are held together by fibrous tissue, and are well packed in fat, which increases sometimes to an enormous extent the apparent size of the organ.

The accompanying cut shews the structure of the

gland; and with a little consideration, it will be readily understood how over-distension of these delicate tubes, from whatever cause, must be productive of great suffering. When an abscess forms in the B., it is very dangerous to allow the matter to remain; but when an opening is made into an abscess of the B., the cut must be made in some line radiating from the nipple, so as to avoid division of the milk-tubes.

BREA'STPLATE, in ancient armour, was a plate of iron, steel, or other metal, so fastened as to protect the chest or front of the wearer. The backplate, in like manner, was worn to protect him from

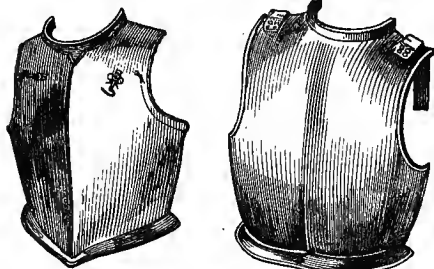

Breastplate.

Backplate.

attack from behind. In modern European armies, almost the only representative of the B. is the front half of the *cuirass*, worn by the *cuirassiers* in certain foreign states, and by the household cavalry (Life-guards and Horse-guards) in England.

BREA'ST-SUMMER, BRE'SSUMER (Fr. *sommier*, a lintel), a beam supporting the whole front of a building, in the same way in which a lintel supports the portion over an opening. They are seen in England and on the continent in old houses that are built partly of wood and partly of stone, brick, or mud.

BREA'ST-WORK, in Fortification, is a hastily constructed earthwork; not so high as to need a *banquette* (q. v.) for the defenders to stand upon, but sufficient to afford shelter when they are standing on the level of the ground, and firing over the crest. The dry ditch or trench from which the earth has been taken to form the B., affords an additional defence. A B. is midway between a *parapet* and an *épaulement*, in size and importance.

BREATH AND BREATHING. See **RESPIRATION**.

BREATH, OFFENSIVE, may depend upon some cause limited to the mouth or nose, or it may arise from diseased conditions of the respiratory or digestive apparatus. If, from want of proper attention, the teeth have collected a quantity of putrescent particles around them, they must be well scrubbed with a brush and tepid water, with some powdered carbonate of magnesia mixed with it. A wash composed of a teaspoonful of tincture of myrrh in a pint of water is also very useful. Occasionally, the secretion from the tonsils (q. v.) is very offensive; and then a solution of nitrate of silver, 4 grains to 1 ounce of water, should be applied to them every morning, with a camel-hair brush, and small alterative doses of medicine administered. Solutions of soda in water are also very useful. Should the fetid smell arise from a portion of dead bone, the latter must be removed whenever it becomes loose. Inhalations of steam from hot-water into which some creosote has been dropped, is much recommended for cases in which the cause

resides in the nose and respiratory passages. When, however, it is caused by digestive derangements, the treatment should consist in purging, to empty the intestinal canal, followed by soda, to correct acidity, and tonics, of which the bitter infusions and tinctures, and the dilute mineral acids, are among the best.

All medical treatment is unavailing to correct the foul odour which rises from the stomach of the habitual drunkard, or from the victim of gangrene or abscess in the lungs.

BRE'CCIA, a term adopted from the Italian to designate a mass composed of angular fragments of rocks of the same or different kinds, cemented together by an enveloping paste, or by infiltrated iron or carbonate of lime.

BRECHE-DE-ROLAND, a defile of the Pyrenees, between France and Spain, about 11 miles south of St Jean de Luz, with an elevation of about 9500 feet above the sea. It is a difficult passage of from 200 to 300 feet in width, between precipitous rocks rising to a height of from 300 to 600 feet.

BRE'CHIN, a town of Forfarshire, on the left bank of the South Esk, 8 miles west of its junction with the sea at Montrose. Pop. 6637. It unites with Montrose, Arbroath, Forfar, and Bervie in returning one member to parliament. Spinning, bleaching, distilling, and brewing are carried on here, as also the manufacture of linens and sailcloth. B. was once a walled town, and contained an abbey of Culdees, instituted, it would seem, about the end of the 10th century. David I. founded a cathedral and bishopric here in the 12th century. Part of the cathedral, built chiefly in the 13th, 14th, and 15th centuries, is now the parish church. Close to the church is a round tower, similar to the Irish ones and to the one at Abernethy, the only other example in Scotland. The tower is 85 feet high, 25 feet in diameter at the base, and 12½ feet at the top, and it is surmounted by a 15th c. spire of 25 feet. B. Castle, the ancient seat of the Maules, and now of their representative Lord Panmure, was taken by Edward I. in 1303, after a siege of 20 days. B. was burned by Montrose in 1645; and near it, Huntly, on the part of James II., defeated the Crawfords in 1452. Gillies, the historian of Greece, was a native of Brechin.

BRE'CKNOCKSHIRE, or BRE'CON, an inland county of South Wales, to the south of Radnor, from which it is separated by the Wye. Length, about 35 miles; average breadth, 20. It stands fourth in size of the Welsh counties. Area, 754 square miles, of which two-thirds are cultivated. B. is one of the most mountainous counties in South Wales, and has deep, beautiful, and fertile valleys. Two principal mountain-chains, the highest in South Wales, rising with Brecknock Peaks to a height of 2862 feet, intersect the county in the north and south, and occupy, with their offshoots, a great part of the surface. Old red sandstone occupies the south and middle of the county, and Silurian rocks the north. The chief rivers are the Wye, Usk, Yrfon, Elan, Claerwen, and Tawe. The climate is severe and rainy but healthy among the mountains, and in the valleys comparatively mild. The agriculture, though still defective, especially in the higher districts, was greatly improved by the Brecknockshire Agricultural Society, instituted in 1755. The chief crops are oats and barley, but much wheat is also grown in Talgarth and Crickhowell, the most fertile districts of the county. In the valleys in the east some hops are raised, and some orchards are seen. The native small black-cattle are reared in the hills, while in the lowlands the Hereford breed

predominates. The mineral produce is small, consisting of iron, especially along the south border; coal and limestone are also found in the south and west. The Brecon canal connects the county with the Bristol Channel. There are several small factories of woollens and worsted hosiery; also several important ironworks, but the ore is chiefly obtained from adjoining counties. B. returns one member to parliament. Pop. in 1851, 61,474. Schools, 104, with 4392 scholars. The chief towns are Brecon, the county and only corporate one, Builth, Crickhowell, Hay, and Llanelly. There are many remains of British and Roman camps, Roman roads, cairns, cromlechs, mounds, and castles throughout the county. B. formed part of the territory of the Silures, who bravely withstood the Romans. The Normans, under Barnard Newmarch, wrested the county from the Welsh princes in 1092. Llewelyn, the last British prince of Wales, was killed in this county in 1282, and by his fall the native mountain-chiefs were entirely subdued. Half the people in B. still speak Welsh.

BRECON, BRECKNOCK, or ABERHONDDU, the capital of Brecknockshire, South Wales, is situated in an open valley in the middle of the county, at the confluence of the Usk, Honddu, and Tarell, 171 miles west-north-west of London. It lies in the midst of fine mountain scenery, and has beautiful public walks. South of B. lie the three mountain-peaks, the Brecon Beacons. Pop. 5673. It returns one member to parliament. Flannels, coarse woollens, and hats are manufactured. Barnard Newmarch, a relative of William the Conqueror, founded the town, and built a castle here in 1094. He also founded two priories here in the reign of Henry I. Henry VIII. turned one of the priories into a college, still existing; the other is now the parish church. B. was formerly surrounded by a wall having ten towers and five gates. Hugh Price, founder of Jesus College, Oxford, and Mrs Siddons, the celebrated actress, were natives of Brecon.

BREDA, a strongly fortified town of North Brabant, Holland, situated at the confluence of the navigable rivers Merck and Aa, and containing about 15,000 inhabitants. It possesses the means of laying the surrounding country under water in the event of an attack; but the former importance of the town, as a military position, has been greatly lessened in recent years. It has a Gothic cathedral, with a lofty tower and several interesting monuments; also an old castle built in 1350, which was for some time the residence of Charles II. of England, and now serves as a military academy. It has manufactures of carpets, linen, hats, soap, leather, &c., and numerous dye-works, breweries, and ropewalks. It is celebrated as the place where, in 1566, the protest of the Dutch nobles, known as the 'Compromise of Breda,' against the measures of Philip II. of Spain in the Netherlands, was presented and scornfully rejected. During the subsequent centuries, it was the scene of much conflict and diplomatizing until 1813, when the French were finally driven out.

BRÉE, MATTHÆUS IGNAZIUS VAN, an excellent Flemish painter, born at Antwerp 22d February 1773, and educated partly there, and partly under Vincent in Paris. As early as 1798, he attracted attention by his 'Death of Cato,' and several other excellent pictures soon followed. A peculiar talent for rapid and vivid sketching enabled B. to execute for Napoleon, in a few hours, 'The Manœuvring of the Fleet before Antwerp on the Scheldt,' and, with equal celerity, Napoleon's 'Entrance into Amsterdam, at the Moment when the Magistrate presents him with the Keys of the City.'

In 1816, he painted the famous Leyden burgomaster, Van der Werff, in the act of addressing the famished and murmuring populace during the siege of 1576: 'Take my body, and share it among you.' This great work—now in the town-house of Leyden—is marked by a felicitous arrangement of the figures, and by a bold and lively colouring, after the style of Rubens. Other celebrated pictures of B.'s are: 'Count Egmont receiving Spiritual Consolation before his Execution,' 'Rubens dictating his Dying Testament,' 'The Tomb of Nero at Rome, with a Group of Lazzaroni and Musicians.' B. died 15th December 1839. In the latter part of his life, he was Director of the Academy of Fine Arts at Antwerp.

BRÉE, PHILIPP JACOB VAN, brother of the preceding, born 1786, has also acquired some reputation as a historical painter.

BREECH, of a gun, is the end furthest removed from the muzzle. It always contains a great mass of metal, to enable it to withstand the shock occasioned by the explosion of the gunpowder. For details, see **CANNON, HOWITZER, &c.**

BREECHES BIBLE. See **BIBLE**.

BREECHING, of a naval gun or carronade, is a strong rope by which the recoil of the gun is checked at such a point that the muzzle is brought wholly within the port-hole, where the seamen can sponge and reload it.

BREECH-LOADING, in Artillery, relates to a mode of constructing large pieces of ordnance, and small-arms or hand-firearms, the peculiar manner of charging which the term describes. This subject is now occupying much attention, and the patented inventions relating to it are very numerous. The Armstrong gun (see **ARMSTRONG**), among others, is a breech-loader; and so is the Whitworth gun. A considerable amount of additional mechanism is necessary for this purpose; seeing that the breech must be so far opened as to admit of the introduction of a ball or shell, and a cartridge, and then so firmly closed as to resist the immense pressure occasioned by the explosion. The objects sought to be attained by this change from the old system are many—quickness in loading, ease in cleaning after firing, accurate adjustment of the diameter of the ball to the calibre of the gun, facility in making the ball accommodate itself to the spiral rifle-grooves of the piece, &c.; but it is still a contested question, especially between the rival inventors of breech-loaders and muzzle-loaders, to what extent these objects are attained. In relation to muskets and fowling-pieces, Mr Greener, of Birmingham, who has written much on the subject, disputes the usefulness of B.; he denies that it is more safe, more accurate, or more forcible than muzzle-loading; while certain advantages which it may possess are, he thinks, counterbalanced by the greater cost of the weapon.

The annexed cut—for which, together with the

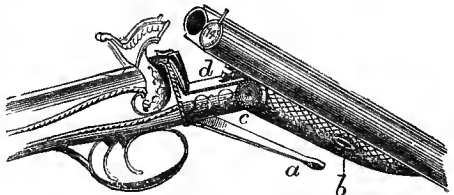

Breech-loading Rifle.

description, we are indebted to Stonehenge's excellent work, *The Shot Gun and Sporting Rifle*—represents part of the mechanism in one of the many

kinds of breech-loaders—viz., the Le Fauchaux or French crutch gun, invented about 20 years ago, and now largely made in England as well as in France; *a* is a lever which opens the mechanism, but which lies flat against the gun at other times; *d* is a notch which, when a hook is liberated from it, allows the barrels to be so adjusted as to be easily loaded at their breech end; *c* is a central pivot around which the movement is made; *b* is a slide that assists in the opening and closing. At 14 is a pin which, when struck by the hammer, transfers the blow to a cap inserted in the cartridge. The relative merits of breech and muzzle loading fowling-pieces were tested in 1859—60 by various trials, under the management of the editor of *The Field*, and resulted in favour of the breech-loaders. The demand for the latter has, in consequence, enormously increased.

This subject receives further notice in various parts of the *Encyclopædia*, in relation to certain kinds of ordnance and small-arms expressly constructed on the B. principle.

BREED, in domestic animals, a variety, or often merely a race distinguished by the possession of particular qualities, but not differing from the ordinary type of the species so as to constitute what naturalists usually designate a variety. The peculiarities of breeds in animals find an exact counterpart in cultivated plants, the value of particular kinds often depending, in a great measure, upon characters scarcely capable of being defined in the language of scientific description, but to the production and perpetuation of which the attention of the cultivator cannot be too earnestly directed. These, also, in plants, as in animals, have of themselves little permanence, and the preservation or perpetuation of them depends upon the same assiduous attention and high cultivation from which, more frequently than from any mere accidental circumstances, they have originated. Thus it happens that the most improved varieties of garden-plants usually degenerate even under ordinary horticultural treatment, and the choice pansies of the florist lose their characteristic excellences if a place is simply assigned to them in a common flower-border. The improvements which cultivation has effected in the productions of the fruit, flower, and kitchen garden do not, however, possess an economic importance to be compared with that of the similar improvements in the cereals and other plants cultivated on the most extensive scale, or in the breeds of some of the most valuable domestic animals. To the breeding of these, great attention has of late been paid—probably more since the beginning of the 19th c. than in all the previous history of the world—and with results the magnitude of which may in some measure be estimated from the statement made on very competent authority, that within the last thirty years the weight of mutton produced has been about doubled in proportion to the number of sheep kept. To the improvement of the B. of horses, attention has been paid for a much longer time than to that of oxen and sheep; and to this must, in a great measure, be ascribed the different excellences of some of the well-known breeds employed for very different purposes. The use of the horse in war, and for purposes of pomp and luxury, appears to have been the reason of the higher degree of attention thus paid to it, even from ancient times. The Arabs have long been particularly careful of the B. of their horses, and diligently preserve a record of their pedigree. What is called *blood* in horses, however, only fits them in a higher degree for certain purposes; and with regard to this as to other animals, the judgment of the breeder must be

exercised, as the perpetuation, increase, or combination of particular qualities may be the object which he has in view. Fleetsness and strength are important qualities in horses, the extremes of which never co-exist in the same animal, but of which a certain combination is for some purposes very desirable; and either of these may be displayed in a great degree without much *bottom*, or power of enduring continued severe exertion—a quality of very high value. The properties most desired in sheep and oxen are very different from those most highly esteemed in the horse—the fleece and the flesh being chiefly regarded in sheep, the flesh and the milk in oxen. Sometimes a perpetuation of good qualities is the great object of the breeder, and a combination of them in the highest possible degree is aimed at; sometimes, the production of the largest possible quantity of beef or mutton in the shortest time being almost exclusively designed, the breeder neglects considerations which would be of importance if his stock could not be improved by animals obtained from other quarters. Extraordinary differences are certainly found to exist among animals of the same species in the readiness with which they convert food into flesh and fat, and in the age at which they are fit for the hands of the butcher. One effect of the attention bestowed of late upon the breeding of stock, has been to supply the market, to a great extent, with the flesh of younger animals than could previously be sent to it—a change evidently tending not only to the benefit of the farmer, but to the increase of the national wealth; because that land, even without increased produce of grass, sends a greater amount of beef and mutton to market within the same term of years. Those sheep and oxen which exhibit in the highest degree the qualities just referred to, are also characterised by shortness of legs, smallness of bones, smallness of head, and fineness of skin; qualities the very opposite of those which would fit the animal for a wild state and an independent existence.

Some of the most important breeds of domestic animals will be mentioned under their proper heads. It remains for us only to allude here to the rules and physiological principles of breeding; but the latter, in so far as application of them has yet been found practicable, are only the best known principles of physiology (q. v.). In a great measure, however, the rules which guide the breeding of stock have been learned by experience, and are rather to be regarded as contributions to science than as deductions from it. The probable relative influence of the male and female parent upon their progeny, is a point unquestionably of the greatest importance, but concerning which widely different opinions have been maintained; and another much controverted and important point is, the propriety of *breeding in and in*. Practically, the rule is always observed by those who seek the improvement of a *breed*, of selecting the very finest animals possible, both male and female; although a great improvement of the existing stock on a farm is often effected in the most advantageous manner by the mere introduction of males of better quality. The dangers of *breeding in and in* are very generally acknowledged, even whilst it is contended that they may very much be obviated by careful rejection of every faulty animal, and that in this way the utmost advantage may be taken of the very highest improvements; but it is likewise very generally admitted that, if equally improved individuals can be obtained not so nearly related, it is better to seek the perpetuation of the B. by their means. It is a rule also of much practical importance, that an improvement of B. is to be attained not by a *cross* between animals of very different breeds, as between

a dray-horse and a race-horse, but only between those which are comparatively similar. The result of the intermixture of very dissimilar breeds is never in any respect satisfactory.

BREFDÉ, a river in Cape Colony, flowing chiefly through the district of Zwelendani, which contains Cape Agulhas, the most southerly point of Africa. It rises in the Warm-Bokkeveld, a mountain-basin about lat. 33° 10' S., and long. 19° 30' E., running first to the west, and afterwards to the south-east; and it enters St Sebastian's Bay or Port Beaufort, from which, upwards, it is navigable to a distance of 40 miles. Its exports are wool, aloes, skins, feathers, grain, butter, cattle, mules, &c.

BREEZE. See **WIND**.

BREGENZ, a frontier town of Austria, capital of the district of Vorarlberg, is situated at the mouth of the small river Bregenz, which here flows into the Lake of Constance, between the Swiss and Bavarian territories, about 80 miles west-north-west of Innsprück. From the ruins of the castle of Hohenbregenz, on a hill near the town, a very beautiful prospect is obtained of the lake and its surrounding vineyards, &c. B. is one of the oldest towns, and was formerly one of the chief fortified places in the southern part of Germany. The inhabitants, about 4000 in number, are engaged in agriculture, horticulture, and cattle-keeping. Cotton-spinning and weaving are also carried on; and articles of wood and straw are manufactured. Its position secures B. a large transit-trade in the produce of the district. In the neighbourhood lies the mountain-pass, the *Bregenz-Klause*, formerly a strong military position between Swabia and the Tyrol. During the Thirty Years' War, the Swedes, in 1646, stormed and captured the fortress of B., and destroyed the works in the pass.

BREHON LAWS (in Irish, *Dlíghádh Breitheamhuin*—that is, 'judges' laws'), the name usually given to the system of jurisprudence which prevailed among the native Irish from an early period till towards the middle of the 17th century. The *breitheamhuin* (pronounced *brei-hoo-in*, or *brehon*), from whom the laws had their name, were hereditary judges, who administered justice among the members of their tribe, seated in the open air, upon a few sods, on a hill or rising ground. The poet Spenser, in his *View of the State of Ireland*, written in 1596, describes the B. L. as 'a rule of right unwritten, but delivered by tradition from one to another, in which oftentimes there appeareth great share of equity, in determining the right between party and party, but in many things repugning quite both to God's law and man's: as, for example, in the case of murder, the brehon—that is, their judge—will compound between the murderer and the friends of the party murdered, which prosecute the action, that the malefactor shall give unto them, or to the child or wife of him that is slain, a recompense, which they call an *eric*; by which vile law of theirs many murders amongst them are made up and smothered: and this judge being, as he is called the lord's brehon, adjudgeth for the most part a better share unto his lord, that is, the lord of the soil, or head of the sept, and also, unto himself for his judgment, a greater portion than unto the plaintiffs or parties grieved.' Spenser was ignorant that pecuniary compensation for manslaughter had obtained in the ancient laws, as well of England as of most European nations. He was mistaken, too, in believing that the B. L. was an unwritten code. Many manuscript collections of the B. L. still exist in public and private libraries in Ireland, England, and Belgium. These manuscripts are regarded as

varying in date from the early part of the 14th to the close of the 16th century. For the laws themselves, a much higher antiquity is claimed. On this point, we must be content to quote what has been said on the part of the very few persons who have had an opportunity of making themselves acquainted with the existing collections of the brehon laws. 'So far as we have external evidence to guide us,' say Dr J. H. Todd and Dr C. Graves, two eminent Irish antiquaries, 'there is no reason to suspect that the brehon laws have undergone any material change since the time of Cormac Mac Cuilleain, king and bishop of Cashel, who died 908 A. D. He was a man of great learning and energy, who certainly promoted the execution of considerable literary works, and under whose influence it is not improbable that a systematic compilation of the laws may have been effected. Of this, however, we have no distinct record. On the other hand, we find scattered through all parts of the laws allusions to a general revision of them made in the 5th c., at the instance of St Patrick, who, in conjunction with certain kings and learned men, is said to have expunged from them all those institutions which savoured of paganism, and to have framed the code called the *Seanchus Mor*. These same documents assert the existence of still more ancient written laws, the greater part of which are ascribed to Cormac Mac Art, monarch of Ireland, in the middle of the 3d century. However slow we may be to acquiesce in statements of this kind, which contradict what we have learned concerning the progress of legislation in the remaining parts of Western Europe, we may readily admit that the subject-matter of many of the laws demonstrates their great antiquity, as it indicates the primitive nature of the society in which they prevailed. In spite of the attempts to efface it, traces of heathenism are still discernible in many parts of them. They enumerate various ordeals of a pagan character, which are expressly termed *magical*, and specify the occasions on which a resort to them was prescribed. There are also provisions in the laws of marriage which prove that Christianity could have exercised but a feeble influence at the time when they were enacted. The language in which the brehon laws are written is a convincing proof of their antiquity. They are not composed in a peculiar dialect, as many writers have maintained; but if their style differs from that of the vernacular Irish of the present day, as Anglo-Saxon does from modern English, this dissimilarity is to be ascribed mainly to the effects of time, by which the orthography and grammatical forms of the language have been modified, and legal terms and phrases of constant recurrence have become obsolete.' The world of letters will be able, in no long time, to judge for itself on the opinions thus expressed. It is now eight or nine years since the publication of the B. L., at the charge of the Irish government, was strongly urged, as well on historical as on philological grounds, by such men as Guizot, Grimm, and Ranke abroad, and Hallam, Macaulay, and Earl Stanhope at home. A commission was accordingly appointed by the Earl of Eglinton in 1852, 'to direct, superintend, and carry into effect the transcription and translation of the ancient laws of Ireland, and the preparation of the same for publication.' The commissioners intrusted the transcription and translation of the B. L. to the two most eminent of Irish scholars—Dr John O'Donovan, professor of Celtic in the Queen's College at Belfast; and Mr Eugene Curry, professor of Irish archaeology in the Roman Catholic university of Ireland. It is understood that these gentlemen have now finished their task, and that the editorship of the work has been committed to Mr W. J. Hancock, late professor

of political economy in Trinity College, Dublin. The publication, it is reckoned, will extend to eight volumes, of about 550 pages each; and will be similar in plan and form to that of the Anglo-Saxon and ancient Welsh laws printed by the Record Commissioners in 1840 and 1841. Along with the Irish text, an English translation will be given, accompanied with preliminary dissertations, glossaries, and indexes. What has transpired of the B. L. warrants the expectation that they will give a vivid and characteristic picture of the polity and social life of a Celtic people.

BREISACH, ALT, a very old town of the grand duchy of Baden, situated on an isolated basalt hill on the right side of the Rhine, about 12 miles west of Freiburg. As early as the time of Julius Cæsar, *Mons Brisacius* was known as a strong military position, and was taken by Ariovistus when he invaded Gaul. Being regarded as the key to the west of Germany, it was a prominent scene of action during the Thirty Years' War, at the conclusion of which it was ceded to the French. During the next century, it frequently changed masters, now belonging to France, and now to Austria. The French destroyed its fortifications in 1744, and during the war of the Revolution in 1793, part of the town was burned by them. In 1806, the French handed it over to the House of Baden. The minster of St Stephen is a venerable structure in good preservation, and contains several old monuments. Pop. 3200.

BREITENFELD, a village and manor of Saxony, about 5 miles north of Leipsic. It is historically remarkable for three battles, fought on a plain in its neighbourhood. The first of these, between the Swedes and the Imperialists, which was fought on the 7th September 1631, was of the highest importance to Europe, as it secured the permanency of Protestantism and the freedom of Germany. Tilly's pride had reached its highest point after the fall of Magdeburg, which took place on the 10th of May 1631; and in the early part of September of the same year, he advanced against the Saxons, with an army of about 40,000 men, for the purpose of forcing the elector, John George I. (who would not submit to the edict of restitution, and was treating with the Swedish king, Gustavus Adolphus), into an alliance with the emperor. No other way remained than for the elector to join the Swedish king, who had just entered Pomerania. Gustavus Adolphus, joined by the Saxons, advanced towards Leipsic, where Tilly lay, who advanced into the plain of Breitenfeld. The imperial forces were completely defeated, and their three most distinguished generals, Tilly, Pappenheim, and Fürstenberg, wounded. The second battle which B. witnessed again resulted in the triumph of Swedish valour: it took place on the 23d of October 1642, between the Swedes, headed by Torstenson, one of the pupils of Gustavus, who had invested Leipsic, and the Archduke Leopold, with General Piccolomini, who were advancing from Dresden to its relief. The Swedes gained a complete victory over the Imperialists, who fled into Bohemia, leaving behind them 46 cannon, 121 flags, 69 standards, and the whole of their baggage. The third battle of which B. was the scene, was fought on the 16th of October 1813, and was part of the great contest known as the battle of Leipsic.

BREMEN, one of the four free cities of Germany, is situated on the Weser, about 50 miles from its mouth. Pop. 60,000, nearly all Protestants. B. is divided into the Old and the New Town—the former on the right, the latter on the left side of the river, which is spanned by

two bridges. The ramparts and bastions round the old town have been levelled, and formed into public promenades, which are laid out with excellent taste. Among the principal buildings, the Cathedral (built about 1160), the Gothic Town-hall (begun about 1405), with its famous wine-cellar, said to contain hock of the vintage of 1624, the Exchange, the Museum, and the Observatory of Dr Olbers, from which he discovered the planets Pallas and Vesta, are remarkable. The position of B. makes it the emporium of Brunswick, Hesse, and other countries through which the Weser flows. Besides its excellent water-communication, it is connected by railways with the whole of Western and Central Germany. B. is an exceedingly thriving place, its trade having more than doubled within the last ten years. Large vessels stop at Bremerhafen, where there is a spacious harbour constructed, about 38 miles below B., with which it is connected by electric telegraph. Vessels not drawing more than 7 feet of water can come up to the town itself. B. carries on an extensive commerce with the United States of America, the West Indies, Africa, the East Indies, China, and Australia. Its great foreign trade, however, is with the United States, from which alone, in 1858, it imported produce of the estimated value of 8,617,400 dollars, exporting in return goods to the value of 10,452,100 dollars. With the exception of Liverpool, no port in Europe ships so many emigrants to the United States as B., through its main port at Bremerhafen. The total number of vessels arriving at B. in 1858 was 2929, and the number departing, 3043. The number of ships belonging to the port was 279, with an aggregate burden of 124,775 tons. In the same year, the value of the imports amounted to £3,232,000, exports to about £8,000,000, a very great decrease as compared with the previous year, especially in imports, which then amounted to nearly £11,000,000, and the exports to £9,000,000. The chief imports are tobacco, coffee, sugar, cotton, rice, skins, dye-woods, wines, timber, hemp, &c. The exports consist of woollen goods, linens, glass, rags, wool, hemp, hides, oil-cake, wooden toys, &c. Large quantities of tobacco are re-exported. In 1851, it was computed that no fewer than 5000 hands were engaged in the manufacture of cigars, but an increase of duty has greatly checked the trade, not a quarter of that number now being employed. B. has also manufactures of woollens and cottons, paper and starch, and extensive ship-building yards, breweries, distilleries, and sugar-refineries. It has regular steam-communication with New York, and also with Hull.

B. first became of historical note in the 8th c., when it was erected into a bishopric by Charlemagne. It soon attained considerable commercial importance, and became one of the principal cities of the Hanseatic League (q. v.). Having frequently suffered at the hands of the French, it was, in 1810, incorporated with that empire; but it recovered its independence in 1813, and by the Congress of Vienna was admitted, in 1815, as one of the Hanse towns, into the Germanic confederation. The area of the republic, of which it is the capital, is about 100 square miles; the total population, including the town of B., about 89,000. The government is intrusted to a senate composed of four burgomasters, two syndics, and twenty-four councillors, and to a convention of resident burghesses paying a certain amount of taxes.

BREMER, FRÉDERIKA, the well-known Swedish novelist, was born at Abo, in Finland, in 1802; but when she was only three years old, her father removed to Sweden, where he became a landed proprietor. According to the accounts of it given by herself in

a letter to her friend and translator, Mrs Howitt, her early life appears to have been outwardly uneventful, though 'with humility she confesses that she always regarded herself as a heroine.' As a child of eight, she had already begun to write verses; and the works of German poets, Schiller more especially, exercised a most powerful influence over her youthful imagination. Her original novels first made their appearance under the general title *Tekningar ur Hvardagslivet*, at Stockholm, in 1835. It was not, however, till 1842 that the English public hailed with delight the appearance, in an English dress, of *The Neighbours*, perhaps the most universally popular of all Frederika B.'s charming pictures of domestic life in Sweden. Encouraged by its enthusiastic reception, Mrs Howitt subsequently published translations of *The Diary*, *The H. Family*, *The President's Daughters*, *Brothers and Sisters*, *Life in Dalecarlia*, and *The Midnight Sun*. In 1849, Miss B. visited the United States, and there spent two years, passing some time in England on her return. In her *Homes of the New World*, published simultaneously in England, America, and Sweden, in 1853, she not only presents us with exquisite descriptions of scenery, and vivid pictures of social life, but with sound and comprehensive views on political and moral subjects. Returning to her home in Sweden, to find a beloved sister removed from it by death, Miss B. has since devoted her talents and energies no longer to literature, but to the carrying out of certain philanthropic objects, in which she has throughout life felt deep interest, more especially the education of the poorest classes. As a writer of fiction, she is eminently distinguished for feminine delicacy, shrewd sense, a pleasant vein of humour, deep knowledge of human nature, and a graphic and forcible style. Her works have been translated into almost all the languages of Europe, and have everywhere been deservedly popular.

BRENNUS, the name, or rather the title of several Gallic princes, is probably a Latinised form of the Kymric word *Brenhin*, which signifies a king. The most famous B. was that leader of the Gauls who, in 390 B. C., crossed the Apennines, and hurrying through the country of the Sabines, at the head of 70,000 men, encountered and overthrew on the banks of the Allia (q. v.) the Roman army. Had the barbarians immediately followed up their advantage, Rome might have been obliterated from the earth; but instead of doing so, they abandoned themselves to drunken delights on the battle-field, and gave the Romans time to fortify the Capitol, whither were removed all the treasures and holy things of the city. When B. entered the gates, he found that all the inhabitants had fled, with the exception of the women, children, and old men, the last of whom, with pathetic heroism, had resolved not to survive the destruction of their homes, and so, the chief among them, clothed in their robes of sacerdotal or consular dignity, and sitting in the curule chairs, waited the approach of their enemies, and received their death in majestic silence. B., having plundered the city, now besieged the Capitol for six months. During the beleaguement occurred the famous night-attack, which would have been successful had not the cackling of the geese, kept in Juno's temple, awakened the garrison. At length, however, the Romans were compelled to enter into negotiations with the besiegers. They offered 1000 lbs. of gold for their ransom, which was agreed to. According to Polybius, B. and his Gauls returned home in safety with their booty; but the rather mythical Roman traditions affirm that, just as the Gauls were leaving the city, Camillus, who had been recalled from banishment, and appointed dictator, appeared at the head of an army, attacked them,

and, in two bloody battles, slew the whole of the barbarians to a man.

Another B., who occupies a conspicuous place in history, was that Gallic chief who invaded Greece, 279 B. C., at the head of 150,000 foot and 61,000 horse. After desolating Macedonia, B. forced his way through Thessaly to Thermopylae. The Grecian army fled at his approach. B. now rushed on with a division of his great host to Delphi, which he had resolved to plunder; but the Delphians, having taken up a very advantageous position on some rocks, resisted his further progress. Assisted by the terrors of an earthquake and a terrible storm, besides, according to reverential tradition, by the supernatural help of Apollo, they utterly routed the Gauls, who fled in dismay. B. was taken prisoner, and drank himself to death in despair.

BRENT GOOSE, or BRENT BARNACLE. This bird has been already noticed under BARNACLE (q. v.). We add here a few sentences from Colonel Hawker's *Instructions to Young Sportsmen*, which we borrow from Yarrell's *British Birds*. They refer to wild-fowl shooting on the coasts of Dorsetshire and Hampshire. 'Towards November or December, we have the Brent Geese, which are always wild, unless in very hard weather. In calm weather, these geese have the cunning, in general, to leave the mud as soon as the tide flows high enough to bear an enemy; and then they go off to sea, and feed on the drifting weeds. To kill Brent Geese by day, get out of sight in a small punt, at low water, and keep as near as possible to the edge of the sea. You will then hear them coming like a pack of hounds in full cry, and they will repeatedly pass within fair shot, provided you are well concealed, and the

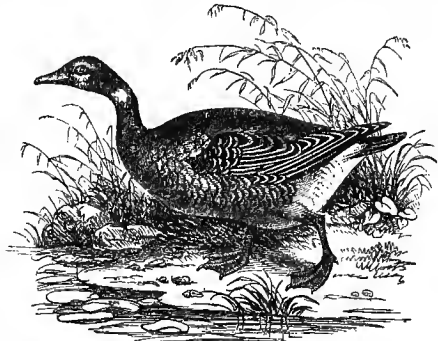

Brent Goose.

weather is windy to make them fly low. Before you fire at them, spring suddenly up, and these awkward birds will be in such a fright as to hover together and present a mark like a barn-door.'—The extensive muddy and sandy flats between Holy Island and the coast of Northumberland are a great winter resort of this species. It is also particularly abundant on muddy and sandy flats in Cromarty Bay. The markets, both of London and Edinburgh, are well supplied with it during winter. The B. G. is known in some parts of England as the Black Goose; it is considered the most delicate for table of all its tribe, and is perhaps as much sought after as any. The B. G. differs in its habits from the common gray lag and several other species, inasmuch as it never feeds on fresh-water herbage, its tastes being exclusively salinus. B. G. may be distinguished, when on the wing, by their black bodies and white tails. Folkhard, in his excellent work *The Wild Fowler*, gives much interesting information regarding this bird.

BRENTA (*Medoacus Major*), a river of North Italy, rises from two small lakes in the Tyrol; flows first in a southern, then in an eastern course through the Venetian territory; passes the towns Cisona and Bassano; receives an arm of the Bacchiglione below Padua, where it becomes navigable; and falls into the Gulf of Venice, at the haven of Brondolo. The ancient bed of the B. was, some centuries ago, altered by the Venetians, who feared that their lagoons might be choked with sand by its floods. Afterwards, the old bed of the river was made use of as a canal—the *Naviglio di Brenta Magra*, which forms the chief communication by water between Venice and Padua; while the B. is but little used for navigation.

BRENTANO, CLEMENS, known as a novelist and dramatic poet, and as the brother of Goethe's 'Bettina,' was born at Frankfort-on-the-Maine, 1777. He studied at Jena, and afterwards resided successively at Frankfort, Heidelberg, Vienna, and Berlin. In 1818, through a morbid discontent with himself and his fellow-men, he retired to the cloister at Dülmen, in Münster. Latterly, he resided at Regensburg, Munich, and Frankfort-on-the-Maine, where he led the life of a recluse, and gained a considerable reputation on account of his sarcastic wit. He died at Aschaffenburg, on the 28th of June 1842. In his earliest poems the peculiarities of the 'romantic school' of his time are carried to excess. His dramatic productions, such as *The Merry Musicians*, a *Musical Drama* (Frankfort, 1803), in which there are some gems of lyric poetry, *Ponce de Leon* (Göttingen, 1804), &c., are characterised by great dramatic power, amusing though rather far-fetched wit, and a wonderful flow of humour. Perhaps his most successful piece as a drama is *The Founding of Prague* (Pesth, 1816). B. was most successful in his smaller novels, particularly in the *History of Caspar the Brave and the Fair Annerl* (2d edit. Berlin, 1831), which German critics call a 'chef-d'œuvre in miniature.' His last work, the legend of *Gobel, Hinkel, and Gakelia* (Frankfort, 1838), was intended as a satire upon the times in which he lived. He has received the grateful acknowledgment of his countrymen for his renovation of the good old history of George Wickram of Kolmar, which he published under the title of *The Thread of Gold* (*Der Goldfaden*, Heidelberg, 1809).

BRENTFORD, the county town of Middlesex, on both sides of the Brent, at its confluence with the Thames, 7 miles west-south-west of London, and where the Thames is crossed by a bridge leading to Kew. It consists chiefly of one long irregular street. Pop. 6057. It has large gin-distilleries, a soap-work, and the works of the West London Water Company. There are many market-gardens in the vicinity. Here Ironside defeated the Danes in 1016, after expelling them from London; in 1558, six martyrs were burned at the stake; and in 1642, the Royalists under Rupert defeated the Parliamentarians under Colonel Hollis.

BRESCIA, a city of Lombardy, North Italy, about 60 miles east-north-east of Milan. It is romantically situated on the rivers Mella and Garza, in a wide fertile plain, at the base of several hills. The railway from Milan to Venice passes through Brescia. The city is for the most part regularly built, and, besides two cathedrals, the old and the new, it has numerous ancient churches, adorned with pictures and frescoes, including many by masters of the Venetian School. Several interesting antiquities have been discovered. It has a valuable public library, with many rare manuscripts. The population, in 1847, was estimated at 36,000; but since then, chiefly owing to the restrictive

and oppressive character of the late Austrian government, it has considerably decreased. B. has manufactures of woollen, silk, leather, paper, &c., and its wine is of good quality. The old name of B. was *Briavia*, and its inhabitants were allied with the Romans when Hannibal crossed the Alps. It was captured by the Huns during their migrations, and afterwards passed through the hands of the Longobards, Charlemagne, the Franks, and the Germans. It was taken by the French under Gaston de Foix in 1512, when it is stated that more than 40,000 of the inhabitants were massacred. The city never fully recovered from the effects of that inhuman sack and pillage. In March 1849, B., as the only important town opposed to Austrian rule in Lombardy, was besieged by Haynau, and forced to capitulate on very disadvantageous terms.

BRESLAU, the capital of the province of Silesia, Prussia, is situated at the confluence of the Ohlau and Oder. Next to Berlin, it is the most populous city in the Prussian monarchy, its inhabitants numbering 129,747, three-fourths of whom are Protestants. The Oder divides it into two parts, which are connected by numerous handsome bridges. The fortifications have been converted into beautiful promenades, and the ditch has been transformed into an ornamental sheet of water. The streets of the new portion of B. are spacious and regular, and the houses stately and handsome, affording a pleasant contrast to the sombre, massive structures of the old town. Educational institutions are numerous, including a university founded by the Emperor Leopold I. in 1702, and now accommodating from 600 to 700 students. The library contains 300,000 volumes. B. has many churches, the most remarkable being the Protestant church dedicated to St Elizabeth, with a steeple 364 feet in height (the highest in Prussia), and a splendid organ. The position of B., in the centre of the manufacturing districts of the province, secures it a large trade, which its railway connection with all the important cities on every side, in addition to the facilities of communication which the Oder affords, enables it to turn to the best account. It has manufactures of linen, woollens, cotton, silks, lace, jewellery, earthenware, soap, alum, starch, &c., and upwards of 100 distilleries; and a trade in corn, metals, timber, hemp, and flax. B. is a city of Slavonic origin, and was for many centuries occupied alternately by the Poles and the Bohemians. It afterwards passed to Austria, from which it was taken by Frederick II. of Prussia, in 1741. Six years afterwards, it was captured by the Austrians, after a bloody battle, but retaken by Frederick in about a month. From that time until 1814, when its fortifications were completely demolished, it was frequently besieged.

BRESSAY, one of the Shetland Isles, east of the Mainland, and separated from Lerwick by Bressay Sound. It is 6 miles long and 2 broad, and is composed of Devonian rocks. It supplied Lerwick with peat, until the proprietor, fearing that the peat might be exhausted, stopped exportation; and it continues to supply the Shetland Isles with slates. Pop. 885, chiefly fishermen. Bressay Sound is one of the finest natural harbours in the world, and is a rendezvous for herring-boats, and for all whalers and other vessels proceeding north. East of B., and separated from it by a narrow and dangerous sound, is a rocky isle, called Noss, 6 miles in circuit, girt on all sides by perpendicular cliffs, and rising abruptly from the sea to the height of nearly 600 feet, with a flattish top. A detached rock, or holm, on the south-east side of the Noss, is communicated with by means of a cradle or wooden chair run on strong

ropes, stretched across a yawning gulf, and admitting a man with a sheep to be drawn over at a time.

BREST, a strongly fortified city, in the department of Finistère, France, and one of the chief naval stations of the empire, is situated in lat. 48° 24' N., and long. 4° 29' W., on the north side of the Bay or Road of Brest, which forms one of the finest harbours in the world, having ample room for 500 ships of the line. The only entrance to the bay is by a narrow channel called *Le Goulet*, which is scarcely a mile wide, and is strongly defended by batteries; the difficulty and danger of access to hostile ships being increased by certain rocks which, rising in the centre of the channel, oblige vessels to pass close in front of the guns of the forts. The small river Penfel flows through the town, which is, on the whole, irregularly built on an uneven site, and has steep, narrow, dark, and very dirty streets. In some parts, communication between the lower and upper parts of the town can be effected only by stairs. The new quarter, the parade, and the quays, are more cleanly. B. has extensive ship-building yards, rope-walks, store-houses, &c.; its industry, indeed, is confined entirely to the equipment of the navy in its various branches. The *Bagne* (q. v.) affords accommodation for about 4000 galley-slaves. Pop., exclusive of garrison and convicts, 41,512. B. is a very ancient place, but it was not of much importance until the 17th century. Its splendid position made it an object of contention to French, English, and Spaniards. In 1631, Cardinal Richelieu resolved to make it a naval station, and commenced the fortifications, which were completed by Vauban, but have since been greatly extended. In 1694, the English under Lord Berkeley were repulsed here with great loss. In 1794, during the war of the Revolution, the French fleet, under Admiral Villaret-Joyeuse, was defeated off B. by the English fleet under Admiral Howe, who captured six ships of the line, and sank another.

BRETAGNE, or **BRITTANY** (*Britannia Minor*), a peninsula in the north-west of France, formerly a province, and now divided into the departments of Finistère, Côtes-du-Nord, Morbihan, Loire-Inférieure, and Ile-et-Vilaine, is surrounded by the sea on the N., W., and S. W. Though the height of the mountains is nowhere considerable, their structure gives to the peninsula a wild and savage aspect. Clay-slate forms the centre of the country, and masses of granite rise in the north and the south. The climate is often foggy, and subject to violent storms of wind. Large tracts of land lie uncultivated; but in the well-watered valleys, vegetation is luxuriant. In ancient times, B., under the name of *Armorica*, was the central seat of the confederated Armorican tribes, who were of Celtic and Kymric origin. Traces of them still remain in the old Kymric dialect of the three most westerly departments, and in the numerous so-called Druidical monuments. The name *Armorica* was changed for that of B., in consequence of the numerous immigrations from Great Britain in the 5th and 6th centuries. The peculiar, shut-in situation, and the characteristics of soil and climate in B., seem to have had a powerful effect on the character of its people. The Breton has generally a tinge of melancholy in his disposition; but often conceals, under a dull and indifferent exterior, a lively imagination and strong feelings. 'The tenacity with which the Breton clings to the habits and belief of his forefathers, is apparent by his retention of the Celtic language almost universally in Basse B., and by his quaint costume, which in many districts is that of the 16th century.' The greater number of the people are found to be ignorant and coarse in their

manners, and their agriculture is of a very rude character, by no means calculated to develop the natural resources of the country. Until within recent years, B. had escaped the observation of tourists; but it has now been found out, and seems likely to be considerably run upon, as well as to have a pretty extensive literature of its own. It will be some time yet before it is exhausted, and apart from the beauty of its scenery, it possesses great interest, as the only place where men can be seen living and acting much as our forefathers did three centuries ago. Under the Romans, the country, after 58 B. C., was made the *Provincia Lugdunensis Tertia*; but its subjugation was hardly more than nominal, and it was entirely liberated in the 4th c., when it was divided into several allied republican states, which, afterwards, were changed into petty monarchies. B. became subject to the Franks in the reign of Charlemagne, and was handed over by Charles the Simple to the Northmen in 912. After some fierce struggles, the Bretons appear to have at length acknowledged the suzerainty of the Norman dukes. Geoffroi, Count of Rennes, was the first to assume the title of Duke of Bretagne in 992. The duchy of B. was incorporated with France in 1532, by Francis I., to whom it had come by marriage, and subsequently shared in the general fortunes of the empire, but retained a local parliament until the outbreak of the Revolution. During the Revolution, B., which was intensely loyal, was the arena of sanguinary conflicts, and especially of the movements of the Chouans (q. v.), who reappeared as recently as 1832. Daru, *Histoire de B.* (Par. 1826); Roujoux, *Histoire des Rois et des Ducs de B.* (Par. 1829); Courson, *Histoire des Peuples Bretons dans la Gaule et dans les Iles Britanniques.* (Par. 1847).

BRETIGNY, a village of France, in the department of the Eure-et-Loir, about 6 miles south-east of Chartres, on the railway between Paris and Orleans. B. is celebrated as the place where, in 1360, Edward III. concluded a peace with France, by which John II. of France was released from his captivity in England, on agreeing to pay 3 million crowns for his ransom, England renouncing her pretensions to Normandy, Anjou, Maine, and Touraine, and being confirmed in her possession of Gascony, Guienne, and several other parts in France recently acquired by conquest.

BRETON DE LOS HERREROS, **DON MANUEL**, the most popular of modern Spanish poets, was born 19th December 1800, at Quel, in the province of Logroño; received his earliest education in Madrid; and served as a volunteer in the army from 1814 to 1822. Subsequently, he held several situations under government, but always lost them on account of his expression of liberal opinion. As early as his 17th year, he wrote a comedy, entitled *A la Vejez Viruelas*, which, in 1824, was brought upon the stage with great success. Since then, he has furnished theatrical managers with more than 150 pieces, partly original, partly adaptations from the older Spanish classics, and partly translations from the Italian and French, most of which have been highly popular. In addition to these, B. has published *Poesias Seltas* (Madrid, 1831, and Paris, 1840); several volumes of satirical verse; and recently (Madrid, 1858), a long humorous poem, called *La Desvergüenza, Poema Jocosario*. All B.'s poems are remarkable for their singularly sweet, yet powerful diction, and for the harmony of the versification. His peculiar sphere is the comic and the satirical, in which the Spanish or national qualities of his genius find their freest expression, and in which also he displays most ease and

self-reliance. A complete edition of B.'s works, excepting *La Desvergüenza*, was commenced at Madrid in 1850.

BRETSCHNEIDER, HEINRICH GOTTFRIED, a man remarkable for his unsettled life, eccentric habits, and satirical writings, was born at Gera, March 6, 1739. He was first sent for education to the Institute of Herrnhuters at Elbersdorf, and afterwards to the Gymnasium at Gera. He became captain of horse in a Prussian volunteer corps, in which service he was made prisoner, and retained in a French fortification till 1763. In 1775, B. visited England, France, and Holland; and in 1778 was nominated librarian to the university of Ofen, where he was persecuted by the Jesuits, whose hatred he had excited. This circumstance brought him under the notice of Joseph II., who, in 1782, appointed him one of the inspectors of studies. He died 1st November 1810. B. was the author of tales, poems, and satires. The latter are attacks upon every kind of injustice and falsehood. In his 'Almanac of the Saints (*Almanach der Heiligen*) for the year 1788, with Copper-plates and Music, printed at Rome, with the permission of the Principals, the priesthood is severely attacked, and the legends of the monks ridiculed. Like Nicolai, B. was very bitter against the 'Werther' mania which was so prevalent in his time.

BRETSCHNEIDER, KARL GOTTLIEB, a distinguished German theologian, born 11th February 1776, at Gersdorf, in Saxony, studied theology at Leipsic, was appointed pastor at Schneeberg in 1807, general superintendent at Gotha in 1816, and in 1840 obtained the dignity of councillor of the Upper Consistory. He died 22d January 1848. B. has acquired a reputation for sober, reflective, rationalistic thought. The character of his intellect rendered him unable to enter into the profane speculations of men like Schleiermacher and Schelling; but nevertheless by his diligence, clear, incisive understanding, and strength of character, he has secured a permanent place in the history of German theology. His most important work in dogmatics is the *Manual of the Evangelical Lutheran Church* (2 vols., Leip. 1814—1818). In 1824, B. published *Lexicon Manuale Græco-Latinum in Libros Novi Testamenti* (2 vols., Leip. 1824). In 1832, appeared *Der Simonismus und das Christenthum*; in 1835, *Die Theologie und die Revolution*. B. has also published many sermons, which have been well received, and in other departments of theology and literature he is considered to have done important service.

BRETTEN, a town of Baden, about 13 miles east of Carlsruhe, chiefly noteworthy as the birth-place of Melancthon. The house in which he was born is pointed out to travellers. Pop. about 3000.

BRETTS AND SCOTS, THE LAWS OF THE (Lat. *Leges inter Bretos et Scotos*, Old Fr. *Lusage de Scotis et de Bretis*), the name given, in the 13th c., to a code of laws in use among the Celtic tribes in Scotland. The 'Scots' were the Celtic people dwelling in the western and more mountainous districts north of the Forth and the Clyde, who, when it became necessary to distinguish them from the Teutonic inhabitants of the low country, received the names of 'the Wild Scots,' 'the Irishry of Scotland,' and, more recently, 'the Scotch Highlanders.' The 'Bretts' were the remains of the British or Welsh people, who were at one time the sole or chief inhabitants of the region now divided into the shires of Dumbarton, Renfrew, Ayr, Lanark, Peebles, Selkirk, Roxburgh, Dumfries, and Cumberland. This province was for some centuries an independent kingdom, known by the names of 'Cambria,' 'Cumbria,'

'Strathclyde,' and 'Strathclyde and Reged.' It became, about the middle of the 10th c., a tributary principality held of the king of the English, by the heir of the king of the Scots. It so continued till after the beginning of the 12th c., when Cumberland having been incorporated with England, the gradual absorption of the rest of the territory into the dominions of the king of the Scots seems to have been imperceptibly completed. The last 'Prince of Cumbria' named in record was the brother and heir of King Alexander I. of Scotland, 'the Earl David,' as he was called, who, on his brother's death in 1124, himself became king of the Scots. No more is heard of Cumbria as a principality; but 'the Welsh' continue to be named among its inhabitants, in the charters of King David's grandsons—King Malcolm the Maiden (1153—1165), and King William the Lion (1165—1214). And they seem to have retained more or less of their ancient Celtic laws until after the beginning of the 14th century. It was not until the year 1305 that an ordinance of King Edward I. of England, who appeared then to have reduced all Scotland to his subjection, decreed 'that the usages of the Scots and the Bretts be abolished, and no more used.' It is unknown how far this prohibition took effect. Of the code which it proscribed, only a fragment has been preserved. It was first printed by Sir John Skene, in his *Regiam Majestatem* (Edin. 1609). But by far the best edition is that of Mr Thomas Thomson and Mr Cosmo Innes, in the *Acts of the Parliaments of Scotland*, vol. i., pp. 299—301 (Edin. 1844), where the laws are given in three languages—Latin, French, and English. The French version, which is the oldest, is printed from a manuscript of about 1270, formerly in the public library at Bern, in Switzerland, now in the Register House at Edinburgh. The fragment of the 'laws of the Bretts and the Scots' thus published, is of much the same nature as the ancient laws of the Anglo-Saxons, the Welsh, the Irish, and other nations of Western Europe. It fixes the *cro*, or price at which every man was valued, according to his degree, from the king down to the churl, and which, if he were slain, was to be paid to his kindred by the homicide or his kindred. The *cro* of the king was 1000 cows; of the king's son, or of an earl, 150 cows; of an earl's son or of a thane, 100 cows; of a thane's son, 66½ cows; of the nephew of a thane, or of an ogethiern, 44 cows and 21½ pence; and of a villain or churl, 16 cows—all persons of lower birth than a thane's nephew, or an ogethiern, being accounted villains or churls. The *cro* of the married woman was less by a third than the *cro* of her husband. The *cro* of the unmarried woman was as much as the *cro* of her brother. Other chapters fix every man's *kelchyn* or *gelchack*, *galnes*, and *enauch*—Celtic terms not yet satisfactorily interpreted, but apparently equivalent to the *fyhthwite*, *mund*, and *manbot* of the Anglo-Saxons, as the *cro* of the Bretts and Scots appears to answer to the *wergild* of the English. A chapter 'of blood-drawing'—corresponding with the *blodwyte* of the Anglo-Saxons—fixes the fine to be paid for a blow to the effusion of blood, according to the degree of the person wounded and the place of the wound.

BREUGHEL, the name of a famous family of Dutch painters.—PETER B., the head of the family, was born in the village of Breughel, near Breda, in 1510 (or, as others say, 1530), and died at Brussels in 1570 or 1590. He was a scholar of Peter Koeck van Aelst, travelled through Italy and France, and on his return, fixed his residence at Antwerp. He painted chiefly the pleasures of rustic life, for which he himself had a great relish, and which he transferred to his canvas with clear insight and vivid

colouring, though unnecessarily exceeding at times the coarseness of his subject. He also executed several historical pieces, such as his 'Building of the Tower of Babel,' now preserved in the gallery at Vienna.—His son, PETER B., distinguished by the strange title 'Hellish Breughel'—because he loved to paint scenes in which the leading characters were devils, hags, robbers, &c.—was born about 1569, and died 1625. His paintings of 'Orphans' and the 'Temptation of St Antony' are the most remarkable of his pieces.—JAN B., brother of the preceding, and on account of the splendid apparel which he wore when he became rich, usually called Velvet B., was born 1563 or 1575, and died 1625 or 1640. He was an industrious painter, distinguished for his landscapes and for his minute finish of small figures. In concert with Rubens, who supplied the two chief figures, he painted 'Adam and Eve in Paradise,' and 'Vertumnus and Bellona.' These, with the 'Four Elements,' are his chief works.—Other members of the same family were known as painters: AMBROSE B., director of the Academy of Painting, Antwerp, between the years 1635 and 1670; ABRAHAM B., a painter of fruits, flowers, and birds, lived long in Rome and Naples, where he died in 1690; JAN BAPTIST B., born in Rome, died 1700; and finally, CASPAR B., both of whom were flower-painters.

BREVE. See ANT-CATCHER.

BREVE, a note in music, which, in the old notation of Guido d'Arezzo, had the value of two whole bars. It is written thus, \square , or $|\square|$, or $||\square||$. The note for a whole bar in modern notation is called semibreve, and has the value of four crotchets. In triple time, the B. contained three semibreves. The B. is now only used in *a la capella* movements, psalm-tunes, and fugues, or at the close of a composition.

BREVE, or **BRIEVE**, in the practice of the Scotch law, is a writ issuing from Chancery in the name of the crown, to a judge, ordering him to try by jury the points or questions stated in the breve. In ancient times, these writs appear to have been the foundation of almost all civil actions in Scotland; but they are now only used in the following cases: 1. B. of Inquest, now, however, superseded by a petition of service, according to the 10 and 11 Vict. c. 47. The object of the proceeding is judicially to ascertain the heir of a deceased person. 2. B. of Tutory, the purpose of which is the appointment, as guardian to a pupil, of the nearest agnate or person most nearly related through the father. 3. Breves of Idiocy and Furoosity, by which the mental condition of a party may be determined for the appointment, in case of ascertained insanity, of a guardian or curator. In the B. of idiocy, the direction is to inquire whether the person is of unsound mind, furious, and naturally an idiot. In the breve of furoosity, it is, whether he be of unsound mind, prodigal, and furious. 4. B. of Terce. The object of this writ is to 'cognosce the widow to her terce'—that is, to enable her to recover her terce or dower. It is issued to the sheriff of the county, and the jury under his presidency are directed to inquire whether the claimant was the lawful wife of the deceased, and whether the husband died infeft in the lands from which the terce is claimed. The verdict of the jury gives the widow her terce, and the judge then 'kens' her to it. See TERCE, and KENNING TO THE TERCE. 5. B. of Division amongst heirs-portioners. By means of this B., an heir-portioner—that is, one of two or more sisters succeeding in equal portions to a landed estate—may have her share of the lands separated or set apart by a judge, who appoints an inquest, or jury of fifteen persons,

to measure the land, and make a division; the jury report to the judge; and lots being cast for the different shares, the judge decides accordingly. This form is, however, now seldom used, an arbitration being more generally resorted to. See INHERITANCE, SUCCESSION, HEIRS-PORTIONERS.

BREVET (Fr. a writ or warrant), in the British army, is a promotion of officers. It takes place under various circumstances. If no special cause interfere, a general promotion by B. used in former times to be made once in about six years; but in recent years it has been due to such special occasions as a coronation, the birth of an heir to the throne, the termination of some great war, &c. The officers obtain an increase of rank and pay, even if they have never served in the field. A B. is determined on by the cabinet, and carried out by the commander-in-chief. The officers expect it, as one of the implied conditions on entering the service, and it has formed part of the British military system ever since the time of James II.; but it is unsatisfactory; because the nation is thereby additionally taxed, without having the power of rewarding the true and valiant soldier above the mere wearer of a red coat. Occasionally, a B. is useful in strengthening the list of generals by new-comers of middle age; seeing that the system of promotion by seniority seldom allows a regimental officer to become a general officer until he is advanced in life. There were brevets, arising out of the various circumstances above indicated, in 1837, 1838, 1841, 1846, 1851, and 1854. On these occasions, lieutenant generals, major-generals, colonels, lieutenant-colonels, majors, and captains, receive a promotion of one grade in rank. On one of these occasions, 200 colonels were at once made major-generals—that is, transferred from the command of a regiment to the power of commanding a complete force in the field. The higher the rank, the higher the pay, as a general rule; and therefore the cost to the nation is always permanently increased after each brevet. Thus the B. of 1837 occasioned an annual increase of £11,000; that of 1838, £7000; of 1841, £15,000; of 1846, £21,000, &c. In 1854, the new major-generals alone involved an additional charge of £18,000 a year. Taking all the recent brevets, and all the officers affected by them, an army B. is worth about £30 a year additional to each officer, on an average. B. does not apply below the rank of captain; lieutenants, ensigns, and cornets being excluded from its operation.

B. applies to the marines and the navy as well as to the army. In the navy, vice-admirals become admirals, rear-admirals become vice-admirals, captains become rear-admirals, commanders become captains, and so forth. As all naval officers are on half-pay except when their ships are in commission, a naval B. increases the total charge for half-pay, but not necessarily that for whole pay. Most of the recent naval brevets have cost the country an additional £20,000 a year, on an average, in the form of increased half-pay.

The above details relate to *general promotion by brevet*. Besides this, there is *brevet rank*, conferred upon individual officers for special services, and allowing them to hold a rank (but not the pay) next above that which their commission specifies. This kind of B. is not used in the navy, nor does it apply in the army to other officers than lieutenant-colonels, majors, and captains. Sometimes B. command or B. rank of this kind is only during a particular war or in a particular country.

Other matters bearing on this subject will be found treated under COMMISSIONS, ARMY.

BREVIAIRY. By this title we are to understand

an *abbreviation*, as well as an amended arrangement of the more ancient offices used at the Seven Canonical Hours, which are Matins, Prime, Tierce, Sext, None, Vespers, and Compline. See CANONICAL HOURS. The books in which these offices were contained were formerly distinct—viz., 1. The *Psalter*, which included the Psalms of David according to St Jerome's Galban version, the Te Deum, the Athanasian Creed, &c.; 2. The Bible; 3. The *Antiphonarium*, containing the anthems and responsories; 4. The *Hymnarium*; 5. The *Collectarium*, or the collects to be said at the end of the services; 6. The *Homiliarium*, *Passionarium*, and *Martyrologium*, containing the comments of the Fathers upon the gospel of the day, and accounts of the martyrdoms of the saints for each distinct festival. Out of all these separate books, the B. was compiled, about the 11th c., by Pope Gregory VII., as is supposed; the lessons, anthems, hymns, and responsories for the different days of the year being all arranged, in their proper places, in the same volume with the psalter, prayers, &c. In later times, the B. was divided into two parts, one for each half of the year, as was the case with those of Salisbury, York, and Hereford, used in England; and afterwards into four parts, so as to be more portable, whence it was also called *Portiforium*. It may perhaps be necessary to inform our Protestant readers, that the B. is an entirely distinct book from the *Miseal* (q. v.), the latter containing the proper offices for the service of the sacrifice of the mass.

The last settlement of the B. was under the pontificate of Pius V., and his bull of 1568 is that by which the present daily office of the Roman Church is authorised. This edition was compiled by the College of Sacred Rites at Rome, in conformity with the decrees of the Council of Trent, because of the variety of *Uses*, as they were called, which at that time existed in different dioceses. The bull of Pius V. abolished the use of all breviaries, except such as could prove a prescription of 200 years. This exception would have extended to the breviaries of Salisbury and York, if the Church of England had not already thrown off Rome's supremacy, and compiled a new Book of Common Prayer for herself. After this, in 1602, Clement VIII. had a standard edition printed at the Vatican, to which all future editions were to conform; and again, in 1631, Urban VIII. caused the metres of the hymns and the Latinity of the whole to be carefully revised. It is perhaps hardly necessary to state that the B. is in Latin, portions of it being sometimes translated for the use of the unlearned. It is necessarily a very bulky volume, when complete; and although some of the legends of the saints and martyrs may be of doubtful authenticity, yet it is a mine of interesting and devotional reading. Its general contents may be judged of from what has been already stated as to the sources from which they were drawn, every saint in the calendar having his proper services for the different canonical hours. The festivals of the Roman Church have their services, according to their importance, duplex, semi-duplex, or simplex—i. e., double, semi-double, or simple: these, again, are further distinguished, so that there are no less than 9 classes of services—the Ferial or ordinary week-day, the simple, the day with an octave, the semi-double, the Dominical or Sunday, the double, greater double, double of the second class, double of the first class. Indeed, so elaborate and perplexing are the rubrical directions, that it is impossible to form any idea of them without consulting the B. itself, and there are probably but few of the priests who are thoroughly conversant with their own ritual.

The B. contains, besides an office for the dead

and other smaller offices, three kinds of office in honour of the blessed Virgin Mary—viz., 1. The full office, said on such festivals as the Purification, Annunciation, Immaculate Conception, Assumption, &c.; 2. The office of the Virgin Mary on Saturdays; 3. What is called the 'little office,' or the Hours of the Virgin. This last was in use as early as the 7th c., and was enjoined by the Council of Claremont, 1096, to be said by the clergy daily, and by the laity on Saturdays, but the bull of Pius V. removed this obligation except as to clergy in choirs. The Roman Church enjoins, under pain of excommunication, all 'religious' persons—i. e., all persons, male or female, who have taken vows in any religious order—to repeat, either in public or private, the services of the canonical hours as contained in the breviary. For the influence of the old breviaries on the English Common Prayer-book (q. v.), consult Palmer's *Antiquities of the English Ritual*, and Maskell's *Momenta Ritualia*. The matins or morning-prayer of the English Prayer-book is an abridgment, with many omissions and additions, of the matins, lauds, and prime of the B., whilst the office of even-song, or evening-prayer, is in like manner an abridgment of the ancient vespers and compline.

BREVIPENNES (Lat. short-winged), in Ornithology, according to the system of Cuvier, that tribe of the order *Grallatores* (q. v.) in which the ostrich, cassowary, rhea or nandou, emu, and apteryx are comprised, and also the extinct dodo.—See these articles. The B. are characterised by a shortness of wing which incapacitates them for flight, but use their wings to aid them in running, which they do with great rapidity. Their *sternum* (breast-bone) has no ridge or keel. They constitute the family *Struthionide* of many ornithologists, and are by some placed among Gallinaceous (q. v.) Birds, to which they are allied by the form of their bill and their choice of food. They are, however, very different from all other birds, and whether ranked among Grallatores or Gallinaceous Birds, do not seem to form a natural part of the order. The gigantic *Dinornis* (q. v.) and other fossil birds of great interest exhibit the characters of the *Brevipennes*.

Gigantic birds, of which the footsteps appear imprinted on sandstones in the valley of the Connecticut and elsewhere, seem also to have belonged to this tribe. No remains or traces of such birds are, however, found nearly so ancient as many remains of quadrupeds. But to whatever geological period the commencement of their existence is to be referred, a peculiar interest is attached to them, because its close may be regarded as probably near. There is no tribe of birds that more generally shuns man, or disappears before the increase of population and the progress of colonisation. The cassowary and the emu are rapidly becoming rare. The ostrich, the rhea, the apteryx, the notornis, &c., are only found in deserts or other deep solitudes.

BREWING. For the process of B. see BEER. The legal requirements for the B. of beer for sale will be found in these acts of parliament, the 5 Geo. IV. c. 54, the 6 Geo. IV. c. 81, the 9 Geo. IV. c. 68, and the 13 and 14 Vict. c. 67. Instead of licences to brew, as formerly, duties are levied on the quantity of beer brewed, according to a scale which ranges from a quantity not exceeding 20 barrels to one that shall exceed 40,000 barrels, the duty itself beginning at 10s., and rising up to £75, according to the quantity. In the case of that kind of beer, called *Table Beer*, it is provided that the duty on such shall in no case exceed £2, no matter how large the quantity brewed may be. Brewers are not to retail or sell beer at any other

place than their licensed B. premises, and if they wish to sell beer at other places, they must get a licence for these places also; but it is provided that the taking orders for the sale of beer in any quantity amounting to or exceeding four and a half gallons, or two dozen reputed quart bottles at one time, sent to the purchaser direct from the B. premises, shall not be deemed a selling of beer at any other place. The last of the above acts, the 13 and 14 Vict., contains provisions respecting the duties to be levied on sugar used in B., providing that such duties shall be at the rate of 1s. 4d. for every hundredweight of sugar; and brewers are to make true entry, in the book kept for that purpose by the Excise, of the quantity of sugar in pounds-weight avoirdupois, used in B., under a penalty of £200, over and above any other penalties to which they may be liable. The acts contain numerous other regulations, too minute for further detail here. See BEER, BEER ACTS, LICENCES.

Anciently, in Scotland, the privilege of B. was given by a licence from the superior or lord, in whose deed of gift or charter to his vassals there was generally a clause *cum brucriis*. But these forms have long been dispensed with. It appears, however, that a person with a right of barony may prevent a feuar, that is, a tenant of property within the barony, or a stranger, from importing and vending ale within the baronial limits without his licence.

BREWSTER, SIR DAVID, an eminent natural philosopher and eloquent writer, was born at Edinburgh, December 11, 1781. He was educated for the Church of Scotland at the university of Edinburgh, where he highly distinguished himself. In 1808, he undertook the editorship of the *Edinburgh Encyclopædia*, to which he contributed many important scientific articles. Previous to this, he had entered deeply on the study of optics, with which his name is now enduringly associated. The beautiful philosophical toy, called the kaleidoscope, was invented by him in 1816. In 1819, in conjunction with Professor Jameson, he established the *Edinburgh Philosophical Journal*; and in 1831 he was one of the chief originators of the British Association for the advancement of Science. The honours conferred on this distinguished man make up a long catalogue. In 1815, he obtained the Copley medal of the Royal Society for one of his optical discoveries, and soon after was elected a Fellow; in 1816, he received half the physical prize bestowed by the French Institute for two of the most important scientific discoveries made in Europe during the two preceding years; in 1819, the Royal Society awarded him the Rumford gold and silver medals, for his discoveries on the polarisation of light; in 1825, he became corresponding member of the Institute of France; in 1832, he was knighted, and had a pension conferred upon him; in 1838, he was chosen Principal of the united colleges of St Leonard and St Salvador, St Andrews; in 1849, on the death of Berzelius, in the preceding year, he was elected one of the eight Foreign Associates of the French Institute, the highest scientific distinction in Europe. Sir David is also a member of the Imperial and Royal Academies of St Petersburg, Berlin, Copenhagen, and Stockholm; has presided over the British Association, and in 1851, over the Peace Congress held in London. In 1859, on the death of Dr John Lee, he was chosen Principal of the Edinburgh University. His principal work is his *Life of Newton*, first published in 1828, in the Family Library, and issued in a totally new and greatly enlarged form in 1855. Among his other works are his interesting *Letters on Natural Magic*, addressed to Sir Walter Scott,

also published in the Family Library; *More Worlds than One* (1854); his treatises on the Kaleidoscope and on Optics (Cabinet Cyclopædia); his *Martyrs of Science*; and his treatises in the *Encyclopædia Britannica* on Electricity, Magnetism, Optics, the Stereoscope, &c. Among other periodicals to which he has been an important contributor are the *Edinburgh* and *North British Reviews*.

BRIAN BOROIMHE (pron. *boru'*), a famous king of Ireland, ascended the throne of both Munsters—answering to the present counties of Tipperary and Clare—in 978. Some time afterwards, he deposed O'Maelachaghlín, and became supreme ruler of Ireland. The surname, Boroimhe, signifying tax, was given him in consequence of the tribute in kind he levied from the various provinces. King Brian supported a rude but princely state at his chief castle at Kincora, a place in the neighbourhood of the modern town of Killaloe, and he had also seats at Tara and Cashel. The vigour of his reign brought prosperity to his country. He defeated the Danes in upwards of 20 pitched battles, restricting their influence to the four cities of Dublin, Wexford, Waterford, and Limerick alone. In the battle of Clontarf (1014), in which he was killed, he gained a signal victory over a united army of revolted natives and Danes, the power of the latter receiving a shock from which it never recovered.

BRIANÇON (ancient *Brigantium*), a town of the department of the Hautes-Alpes, France, on the right bank of the Durance, about 35 miles north-east of Gap. It is the highest town in the French empire, being situated at an elevation of nearly 4300 feet above the sea-level. As the principal arsenal and dépôt of the French Alps, B. is very strongly fortified, while several forts guard the approaches, and every height in the vicinity is a point of defence. It is considered impregnable. Troops can readily be marched from it on to the passes of the Simplon, St Bernard, Mont Cenis, and the Col de Tende. Mont Genève affords a practicable passage into Italy from the town itself. B. has some manufactures of cotton-goods, hosiery, cutlery, crayons, &c. Pop., exclusiv of garrison, 1596.

BRIAN'SK, a town of Russia, in the government of Orel, 70 miles west of the city of that name. It is situated on the right bank of the Desna, is surrounded with earthen ramparts, and has a considerable trade in grain, hemp, wax, linen, cables, cordage, iron, &c., with Kherson, Odessa, and other ports on the Black Sea. B. has also imperial building-yards, and a cannon-foundry in the vicinity. Pop. 10,682.

BRIARE, a town in the department of Loiret, France, situated on the right bank of the Loire, at the point where the Canal de Briare enters that river, about 43 miles south-east of Orleans. The canal, which unites the Loire and the Seine, is remarkable as the first that was constructed in France, having been begun by Sully, and finished in 1642. B. has a considerable trade in wine, wood, and charcoal. It is supposed to occupy the site of the ancient *Brivodurum*. Pop. 3110.

BRIBERY. The corrupt practices known by the term B. might well form the theme of an extended essay. Here we can point only to a few of the more conspicuous features of this grave social disorder, and chiefly as concerns B. at elections.

Election B., a well-known form of corruption, may be called the canker and disgrace of constitutional government. Individuals, with little to recommend them but wealth, and it may be some local distinction, wishing to be elected representatives in the legislature, do not scruple, through various devices,

to buy the votes of the meaner order of electors by bribes. B. at elections is perhaps more openly and audaciously practised in various parts of the United States than it is in England; nor are base influences of this kind unknown in connection with the more meagre constitutional forms of some continental states. But in the eye of the world, England has the unenviable notoriety of being the country in which B. is reduced to a regular and continuous, though covert, system. It has been demonstrated by parliamentary inquiry, that masses of the population in certain towns—more particularly the class called freemen—look upon the franchise as a privilege which, for personal benefit, entitles them to exact so much money for their votes. Public considerations have no weight with them whatever. It seems to them to be alike their duty and their interest to sell their votes to the highest bidder. The Earl of Dundonald mentions in his *Autobiography*, that when, as Lord Cochrane, he offered himself as a candidate for Honiton, he was barefacedly told by one of the electors, 'that he always voted for Mister Most;' and not choosing to bribe, he lost his election. The amount of bribe ordinarily paid at elections in this venal class of boroughs, varies from £1 to £10, according to circumstances; as high a sum as £20, and even £50, has been known to be given in the extremities of a contest. For these corrupting and disgraceful practices, the law threatens certain penalties; but to avoid incurring these, as well as for the sake of decency, the candidates employ a mean class of agents, or are in some obscure way assisted by confederates, of whose proceedings it is difficult to substantiate any guilty knowledge on their part. The agents more immediately concerned transact the business of bribing in private, sometimes in darkened apartments, where no one can be seen. Formerly, the treating of voters in taverns was added to other varieties of corruption, and the demoralisation that ensued on occasions of this kind amounted almost to a universal saturnalia. The law having interposed to check this gross form of B., the evil has latterly subsided into a commonplace routine of secret money-dealings. Of course, by this illegal expenditure, along with the necessary outlays which the law allows, the cost of an election is in many cases enormous. Few seats of English borough members cost less than £1800; but double and triple this sum is a common outlay. It is a well-known fact, that for certain boroughs any man—no matter what be his political opinions or private character—may be returned by advancing £4000, and asking no questions as to what is done with it. As the B. is on both sides, it may be safely averred that the money spent at some contested elections amounts to £10,000. As regards elections for counties, the influences brought to bear are ordinarily of a different kind; but though morally wrong, they do not come within the scope of the present article. The Scotch have some reason to boast that their country is comparatively exempt from this social disorder—that their representatives are not so depraved as to offer, nor the electors so weak and needy as to accept, money-bribes. Such may be said as a general truth. Unfortunately, however, the national integrity is in this respect not quite unblemished, for the member returned for the Falkirk burghs in 1857 was unseated for bribery. To avert every form of corrupt influence, the ballot (q. v.) has been vehemently urged; but looking to the results of that method of voting in the United States and in France, and also to the venality of too many electors, it may be doubted whether the ballot would prove a sufficient remedy for this

monstrous abuse. The law on this subject will be found under CORRUPT PRACTICES ACT (q. v.); see also PARLIAMENTARY ELECTION.

BRIBERY IN MUNICIPAL ELECTIONS. By the Municipal Corporations Act, 5 and 6 Will. IV. c. 76, s. 54, persons convicted of bribery for votes shall forfeit the sum of £50, and be afterwards for ever disabled from voting at other municipal elections, and also from holding any office or franchise in the borough. See MUNICIPAL ELECTION.

BRIBERY OF CUSTOM-HOUSE AND EXCISE OFFICERS. By the Customs Consolidation Act, the 16 and 17 Vict. c. 107, s. 262, every person who shall give or offer any bribe, or make any collusive agreement with any officer of Customs or Excise, or other person employed for the prevention of smuggling, in order to induce him to neglect his duty, shall forfeit the sum of £200. A former act, passed in 1827, the 7 and 8 Geo. IV. c. 53, s. 12, still in force, specially enacts in the case of the Excise, that persons in such service taking money or reward, or entering into any collusive agreement contrary to their duty, shall for every such offence forfeit the sum of £500, and be incapable of serving the crown in any office or employment; and any person giving or offering money or reward to Excise officers, in order to corrupt and prevail upon them, shall forfeit the like sum of £500, but simply and without any further penalty of disqualification.

BRIBERY OF JUDGES. See JUDGES. This offence in the old Scotch law was called *BARRATRY* (q. v.).

BRICK, an artificial substitute for stone, which has been extensively used for building in all ages. B. is composed of argillaceous earth or clay, which, after being moistened and made fine by kneading, is formed into small blocks, usually oblong and hardened by burning in a kiln, or, in warm climates, sometimes by baking in the sun. The bricks used in the construction of the tower and city of Babylon were probably burned in a kiln ('Let us make brick, and burn them thoroughly,' Gen. xi. 3), whereas those which the Israelites were compelled to make for the Egyptians would seem to have been merely baked, straw or stubble being used to give them tenacity (Exod. v. 12). But though bricks were used probably by all the more civilised nations of the East from the earliest period, it was the Greeks who, according to Pliny (*H. N.* xxxv. 48), brought this, like all the other arts of construction, to perfection. That the Romans practised the art of brick-making with the greatest success, the Pillar of Trajan alone would be sufficient to testify; and there is not a province of the empire which does not still exhibit proofs of the durability of their work in this material. Both the processes of drying in the sun and burning in a kiln were employed by the Romans, bricks prepared in the former manner being called *lateres crudi*; those in the latter, *lateres cocti*. Even bricks which are to be afterwards burned in a kiln, must be previously dried, to prevent them from cracking. The Roman bricks were each stamped with the mark of the maker—which generally consisted of the figure of a god, a plant, or the like—encircled by his name, the consulate, the name of the legion by which the bricks were used, &c. The arrow-headed or cuneiform characters which are found on the Babylonian bricks, probably conveyed similar information. The use of glazed B. for purposes of ornament, or of forming figures or inscriptions, belongs to the middle ages. Roman bricks were also scratched on the surface, and some have lumps raised or notches cut in them, for the purpose of making the mortar adhere more firmly than if they had been smooth—a purpose which

BRICK.

must also have been served by the inscriptions above alluded to. They were of various sizes, and generally so much thinner than those now in use, as almost to resemble tiles. In many instances, the Roman bricks found in England have been removed from their original position, and employed in the construction of buildings of later date. The earliest instance in which bricks of the modern or Flemish make occur in England, is Little Wenham Hall, in Suffolk, 1260. They are paler than the common red B., but redder than the white B. now used in Suffolk.

The MANUFACTURE OF BRICKS, or brick-making, was, until about the commencement of the present c., carried on everywhere by manual labour, and in much the same way. In northern latitudes at least, the clay is turned out of the ground about the end of autumn, in order to expose it to the rains and frosts of winter. This has a peculiar tempering effect, rendering the clay, after it has been kneaded, more tough and plastic. When the clay is of a highly aluminous kind, a quantity of sand is mixed with it; for sand and clay make a stronger B. than pure clay. After exposure during the winter, the clay is ready for kneading, which, in the old system, is effected by the treading of the workers' feet, or by the trampling of cattle. The clay thus prepared is next carried or wheeled to the moulder's bench, where it is made up into lumps sufficient each for a single brick. The moulder or brick-maker is provided with a mould of the size and shape of the required bricks. The mould is simply a wooden case or box placed on a loose bottom, and into this the moulder dashes a lump of clay, after besprinkling it with dry sand, to prevent adhesion. The case being lifted up, the B. is left standing completely formed on the loose bottom. A block of wood, called a 'kick,' is sometimes attached to this loose bottom, in order to form a hollow in the bottom of the B., and thereby give it lightness, and form a bed for the mortar. This is required in smooth machine-made bricks that are used for outsides, and laid very close, leaving but little room for mortar. The bricks thus formed are removed from the bench, and piled up in walls, with spaces between the bricks, to dry in the open air. When sufficiently dry, they are piled either in a kiln or in a clump with coal intermixed, and haked by the burning of the coal.

The first step in the introduction of machinery into brick-making was the Pug-mill, which dispensed with the tedious process of puddling or kneading with feet. The clay is introduced into a hopper or cylinder about 5 feet in height, in which an upright shaft, with a number of cross-arms, is made to revolve; and the comminuting effect is increased by fixed arms projecting from the inside of the cylinder into the spaces between the arms of the shaft, or knives, as they are called. As these knives are set so as to act spirally, they press the clay down to the bottom of the tunnel, where it is discharged in a tempered or prepared state. For some time after the introduction of the pug-mill, the moulding of the bricks was executed by a separate machine, until, in 1839, a machine was brought out by Messrs Cook and Cunningham, in which the two operations were successfully combined. This machine still keeps its place among a host of subsequent inventions, and may be taken as representing the principle of most of them.

The annexed figure represents the essential parts of the machine. In addition to the pugging apparatus, *c*, above described, it has, on each of its two opposite sides, a sliding mould-frame, and two sorts of stampers—one in the middle for filling the moulds, and two at the sides for emptying them, or discharging

the bricks. (The fig. represents only one frame with its stampers.) The clay is pressed out of

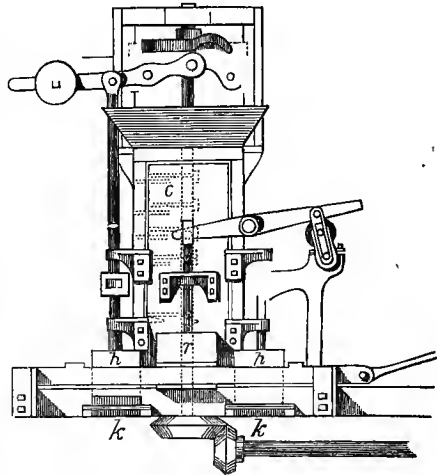

Brick-making Machine.

the pugging cylinder into a box at its lower end, at *r*, by two radial arms, attached inside to the pugging shaft. The mould-frame acts as the bottom to this box, and the clay, thus pushed in between it and the filling stamper, is pressed into the mould by the descent of the stamper. The moulding-frame is then made to slide until the brick thus formed is brought under one of the discharging stampers, *h*, *h*, which descends upon it, and forces it through an opening in the sole on which the frame slides, and which forms the bottom of the mould while under the filling-stamper. The brick, when forced through, is received on a board, *kk*, placed there by a boy in attendance for the purpose. The motion of the stampers, and the traversing of the mould-frames between the stampers, are effected by a combination of the usual shafts, cranks, wheels, &c., which it is unnecessary here to describe. This machine turns out about 18,000 bricks in ten hours, six boys being required to attend upon it, and its cost is about £250. There are some objections to machine-made bricks. They are more liable to cracks in drying, less porous, and therefore do not adhere so well to the mortar, and they are heavier and more costly for carriage. At the same time, they are smoother, and, if slowly dried, stronger than ordinary hand-made bricks, and are chiefly used for outside work. Patents have been obtained for perforated and for hollow bricks, the object being mainly to lighten the machine-made bricks and save clay. They are not much used.

The number of brick-making machines which have been brought out during the last twenty years is great, the most of them constructed on a principle of acting with moulds and stampers, but dividing themselves into two classes—the one for working according to the wet-clay system of moulding (above described), and the other for the dry. In the latter system, the material used is chiefly the shaly marl overlying the ironstone. It is reduced in the roller-mill to a coarse powder, and pressed, in a damp state, by the action of stampers, with great force into the moulds, so that in coming from them the bricks bear any handling, and are thus ready for immediate firing. This system of brick-making can be carried on throughout the year, in all weather,

BRICKLAYING, BRICKWORK.

with as much comfort to the workmen as any other partially indoor-work.

Fire Bricks, for building up furnaces, &c., are made chiefly from the Stourbridge fire-clay, and from clay found near Farnham, in Surrey. The clay has to be prepared with great care, in order to avoid unequal expansion and contraction, and they are baked at an intense heat. The clay differs from that of common bricks, in containing but a small quantity of lime, magnesia, and the oxide of iron, all of which form compounds with silica, that are much more fusible than the silicate of alumina, of which the best fire-bricks are almost entirely composed.

By several acts of parliament, duties were imposed on bricks; and so late as the year 1839, an act of parliament was passed, carefully regulating the raising and levying of such duties. But these exactions were felt to be a grievance, and were wholly repealed by an act passed in 1850, the 13 Vict. c. 9.

BRICKLAYING, BRICKWORK. The material of which a town is built depends mainly on the geology of the surrounding district. In a mountainous country like Scotland, cities of stone, such as Edinburgh, Glasgow, and Aberdeen naturally abound; while London, and most of the great towns of England, situated in alluvial valleys and plains, are built of bricks derived from the alluvial clay beneath and around them. In Holland, where the whole country is but the delta of the Rhine, and no stone is to be found, brick is universal, even to the paving of the streets.

The standard size of English bricks being 9 inches by 4½, the thickness of walls is regulated thereby. They are either half-brick, 1 brick, 1½, 2, 3, or 4 bricks in thickness. In moderate-sized modern English houses, the inside partition-walls are usually half-brick, the outer walls, 1 or 1½. In larger houses of superior construction, a thickness of two or three bricks is sometimes used. This latter thickness is seldom exceeded, except in large public works. Modern brick-houses are, for the most part, far less substantial than those erected by our forefathers. Building leases being usually granted for ninety-nine years, at the expiration of which term, the whole property reverts to the freeholder, the object of the builder is merely to make a house that shall stand for that period, and not to expend any money for the sake of further stability. Garden-walls are commonly built but half-brick in thickness; these, however, are strengthened by 9-inch piers at intervals of 10 or 12 feet. In laying the foundations of walls, the first courses should be thicker than the intended superstructure, and the projections thus formed, usually of quarter brick on each side, are called 'set-offs.' Before laying walls of houses, trenches are dug, and the foundation tried with a crowbar or rammer. If it is found to be loose, and the looseness due to superficial soil, this is removed, and its place supplied with fragments of stone and old broken bricks, which are closely rammed together. In some cases, inverted arches of brick are built for foundation, or a stratum of concrete laid down. See CONCRETE.

Mortar composed of lime and sand is the common cement for brickwork. It should be equally and carefully applied; and the bricks wetted, in order that the mortar may adhere more firmly, by being absorbed into their pores. The force with which good mortar is capable of adhering to bricks is very remarkable. It is found to be the greatest in old structures that have been exposed to the continuous action of water. Such B. is said to be 'water-bound' by workmen, and can scarcely be separated without breaking the bricks.

A fundamental principle to be rigidly observed in

laying all kinds of brick is, that *no two contiguous perpendicular joints shall fall immediately below each other*, or, to use the bricklayer's phrase, the work must 'break bond.' The mode of arrangement of the bricks to effect this is called the *bond*; a layer or stratum of bricks is called a *course*. Bricks laid with their lengths in the direction of the course, and their sides to the wall-face, are called *stretchers*; those laid across the line of the course, with their ends forming the wall-face, *headers*; a layer of headers, a *heading course*; of stretchers, a *stretching course*.

The two kinds of bond almost exclusively used in England are the English and Flemish bond. English bond consists of alternate stretching and heading courses; Flemish bond, of a stretcher and header laid alternately in each course (see figures). English bond is the strongest; Flemish bond, the more ornamental; and they are used accordingly.

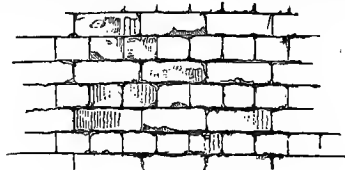

Old English Bond.



Flemish Bond.

There are two other kinds of bond occasionally used—*herring bond*, and *garden-wall bond*. The former is applied to form the core of thick walls, where Flemish bond is used for the facing. A course of bricks is laid obliquely at an angle of 45° to the face of the wall; then above it, another course at the same angle, but inclined in the opposite direction, so that the joints may cross the first. This is considered to add to the strength of Flemish bond, but is objectionable on account of the triangular interstices necessarily left between the oblique bricks and the bricks of the facing. Garden-wall bond is only used for 9-inch walls, and formed by laying three stretchers and one header, and so on in each course. In order to strengthen Flemish bond, bands of hoop-iron are sometimes laid flatwise between the courses. This 'hoop-iron bond' has superseded the old practice of using bond-timbers, which were inserted the whole length of the wall. The hoop-iron should be slightly rusted, to secure the complete adhesion of the mortar.

In constructing arches of brickwork, much care and skill are required. A wooden centring is always used; and when very rude work only is required, common bricks are laid upon the centring, and the gaping interstices at the upper ends filled with rough brick wedges. For better work, each brick has to be properly bevelled, according to the curve. When semicircular arches are made, all the bricks require an equal bevel, and therefore bricks moulded uniformly to the required angle may be used; but for other curves and for flat arches, each brick has to be separately shaped by the bricklayer. In order to do this, a drawing of the required arch is made of the full size on a board; the bricks are laid upon

this side by side, and shaped to the lines of the drawing; they are then transferred to their corresponding place in the structure. The bricks are first rudely shaped by the *brick-axe*, then finished on the *rubbing-stone*, a piece of rough grained stone about 20 inches in diameter. In all kinds of B., the walls should be built up level throughout, in order that the *settlement* may be equal. An unequal settlement may produce a rupture of the wall.

B. is measured by the rod or by thousand. A rod contains 272 square feet of standard thickness—that is, $1\frac{1}{2}$ brick. This is equal to 306 cubic feet, and will, on an average, require 4500 bricks, allowing for waste. The weight of a rod of B. containing 4500 bricks, 27 bushels of lime, and 3 single loads of sand, is about 13 tons. The bricklayer is always attended by a labourer or hodman, who carries his bricks and mortar in a 'hod'—a triangular wooden box, open at the top and one end, and supported on a round leg, by which the hodman holds it on his shoulder. A bricklayer's wages are usually about 26s. per week, the labourer's about 18s. The labourers are generally Irishmen.

The surface of brickwork is sometimes ornamented by *pointing*. This is done by raking out the mortar of the joints to a small depth, and filling up again with blue mortar, and marking the courses with the edge of the trowel. This is called *flat-joint pointing*. When the courses are marked by a neatly pared raised line of white plaster of about half an inch in thickness, laid upon the blue mortar, it is called *tuck* or *tuck-joint pointing*. Coloured bricks, as a means of external ornament, have been extensively and most effectively used in North Italy and Germany. The works of Mr Ruskin, Mr Gally Knight, Webb's *Continental Ecclesiology*, Street's *Brick and Marble of the Middle Ages*, and Fergusson's *Hand-book of Architecture*, may be consulted for illustrated examples of these.

Chromatic brickwork is now becoming very extensively used in England, especially by architects who are endeavouring to revive the style of architecture called by themselves English Gothic, and by some others Venetian Gothic, in which the pointed arch, formed of coloured bricks, forms one of the prominent features. These architects maintain that, as they are compelled to construct with B., it is more honest to use bricks ornamentally, than by means of stucco to obtain an external imitation of stone; and as B. admits of but little ornamentation in relief, they use variation of colour, of which B. is peculiarly susceptible, and thus produce a sort of architectural mosaic. The eloquent and popular advocacy of these views by Mr Ruskin, and the skill and enthusiasm with which many young and rising architects are carrying them out, seem likely to bring about a great development, almost amounting to a revolution in English domestic and ecclesiastical architecture.

BRICOLLE. See BALLISTA.

BRIDE, BRIDAL. The word Bride (the radical signification of which is thought by some to be 'appropriated,' 'owned') is common to all the Gothic languages, and also to Welsh (Ger. *braut*, Welsh *prïod*), and signifies betrothed or newly married. Alone, the word denotes the newly married woman; with the addition of the syllable *groom* (a corruption of *guma* = Lat. *homo*, a man), it denotes the newly married man (Ang. Sax. *brydguma*, Ger. *bräutigam*). In Welsh, *prïod-fab* (betrothed youth) is bridegroom, and *prïod-ferch* (betrothed maid) is bride. Bride is the root of a variety of terms connected with marriage, as *Bride-favours*, *Bride-cake*, &c. *Bridal* is for *Bride-ale* (Ang.-Sax. *bryd-eale*) the marriage-feast. *Bride-*

maids, or attendants on brides, appear to have been in use among the Anglo-Saxons, and are mentioned in early accounts of marriage-ceremonies. A part of their duty consisted in dressing and undressing the bride. *Bridemaids*, as mere ceremonial attendants at marriages, are still in use in England. The husband had an analogous body of attendants, called *bridegroom-men*; but they have disappeared in modern usage, and their only representative is one confidential friend in attendance. In Scotland, this personage is called the best man. One of his duties is to pull off the bridegroom's right-hand glove, while one of the bridemaids does the same service for the bride, when the pair are requested to join hands.

BRIDE-FAVOURS are small knots of white ribbons, which are pinned to the breasts of all who are in attendance at weddings, nor are even the post-boys and their horses' heads left undecorated with these gay trappings. The origin of the bride-favour is said to be the true-lovers'-knot—something symbolical of the union of hearts and hands on the occasion. In various old plays and poems there are allusions to bride-favours or ribbons, as that in Herrick's *Hesperides*:

What posies for our wedding-rings,
What gloves we'll give and ribbonings.

The **BRIDE-CAKE** is also symbolical in its origin. 'The ceremony used at the solemnisation of marriage among the Romans was called *confarreatio*, in token of a most firm conjunction between the man and wife, with a cake of wheat or barley. This, Blount tells us, is still retained in part with us, by that which is called the bride-cake used at weddings.'—Brand's *Popular Antiquities*. The old English and also Scottish custom of breaking a cake over the head of the bride on entering her new dwelling, perhaps points to a usage of the most remote antiquity—the sprinkling with wheat as a token of plenty. In modern times, the bride-cake is a stately piece of confectionary, consisting of a rich cake as a basis, on which is reared a castellated structure, with various fanciful devices, the whole being covered with a preparation of white sugar. This fabric is cut up and given in pieces to the guests, as part of the wedding joviality.

BRIDEWELL, a well between Fleet Street and the Thames, dedicated to St Bride, which has given its name to a palace, parish, and house of correction. A palace, described as 'a stately and beautiful house,' was built here, in 1522, by Henry VIII., for the reception and accommodation of the Emperor Charles V. and his retinue; and King Henry himself also often lodged here, as, for instance, in 1525, when a parliament was held in Blackfriars; and in 1529, the same regal personage and his queen, Catharine, lived in the B. while the question of their marriage was argued. In 1553, Edward VI. gave it over to the city of London, to be used as a work-house for the poor, and a house of correction 'for the strumpet and idle person, for the rioter that consumeth all, and for the vagabond that will abide in no place.' Queen Mary having confirmed the gift, it was formally taken possession of in 1555 by the lord mayor and corporation. The B. was afterwards used for other persons than the class above named, and at last became a place of punishment, as it now is. As a house of correction, it is not under the sheriff's charge, but is governed by a keeper wholly independent of that officer.

By the 15 and 16 Vict. c. 70, a new House of Correction is established for the city of London. See CORRECTION, HOUSE OF.

BRIDGE (Ang.-Sax. *bryeg*; Dutch, *brug*; Ger. *brücke*) is a structure for carrying a road over a

stream, river, ravine, low ground, or other impediment to its course. A bridge for carrying a canal or other water-course, is called an aqueduct (q. v.); one for carrying a railway is sometimes called by the recently coined, though not very correct, word *viaduct*. Bridges are formed of stone, brick, cast-iron, or timber arches; of timber beams or frame-work, supported on piles or on masonry; of iron rods or chains, in which case they are called suspension-bridges; of lattice-work; or of cast or wrought iron girders. Sometimes a combination of beams and suspension-rods is used. Of late years, the plan of tubular or hollow wrought-iron girders has been frequently and successfully employed, the first great example being the Britannia Bridge (q. v.).

Bridges are either fixed or movable. Of movable bridges there are various kinds. *Flying-bridges* and *floating-bridges* are, in fact, mere ferry-boats (see FERRY) with gangways attached, and other provisions for safe and ready transport, and which are drawn across the stream by ropes. *Draw-bridges* and *swing-bridges* are constructed in two parts, that turn on pivots—in the former, the parts are lifted vertically; in the other, they are moved round horizontally. A *sliding-bridge* runs backward and forward on wheels or rollers. Another kind is much in use in low districts like Norfolk, where the water flows lazily, and almost on the land-level. These are sometimes called pontoon-bridges, from the movable roadway being balanced at a small height above the water-level on a pivot working in a large pontoon or hollow cylinder sunk in the bed of the river—the ends of the roadway of the B., when laid across the river, resting freely on piers on either side. There are several such bridges in use over the Ouse. The pivot is set in the centre of the stream, and, when necessary, the B. is turned round on it by machinery, till it lies parallel to the banks, and permits the passage of barges on either side. In a flat district, these bridges are exceedingly appropriate. See also BRIDGE, MILITARY.

Convenience must have led men in a very rude state of society to form bridges, in order to the easier communication between districts separated by rivers. On most streams there occur fords, but often these are not to be found where they would be most desirable. The most rudimentary form of a B. may be assumed to be a series of stepping-stones, such as are yet almost everywhere to be found on river-courses at some point. Large stones deposited in the streams at the shallows or fords, would first give a chance to a passenger of getting across dry shod; by and by, where one or two stones were wanting to complete the steps in the passage, they would be supplied. Next, it would naturally occur to give greater security to the passage, by laying planks or trees across the stepping-stones, so as to avoid the risks attending stepping or leaping from the one to the other. In the arrangement of planks resting thus on stones, we have the first advance in the art of B.-building, the suggestion at once both of piers and roadways; and beyond this stage, the art would appear not to have advanced for a very long period. From the Greeks, we have accounts of bridges built by Semiramis, Darius, Xerxes, and Pyrrhus; and in Egypt, necessity early compelled the formation of bridges in connection with the canals constructed for the purposes of irrigation. But all these would appear to have been rudimentary in form, and to have consisted simply of piers, with the intervals between them spanned by beams of timber or large flat stones. Sometimes boats moored in the stream served the purpose of piers, as was the case with the famous B. of Xerxes across the Hellespont. Bridges of boats are in use to this day. The

principle of the arch was long known before it was applied to the art of B.-building. See ARCH. That application we owe to the Romans, whose first great work in which the arch was employed, the Cloaca Maxima (q. v.), is referrible to the time of the Tarquins. The Ponte de Rotto, or Senators' B. (127 B. C.), erected by Caius Flavius, appears to have been the first instance of its application to

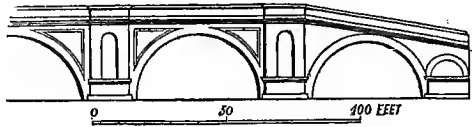

Ponte de Rotto.

bridges. In the course of the great engineering undertakings of the Roman empire under Augustus Cæsar for the formation of roads and supply of water to Rome, its application became general; and afterwards, the empire having extended its bounds, the necessity for ready communication between its provinces, led to the erection of numerous splendid bridges therein, many of which, indeed, surpassed in their greatness those of Rome itself. But although the Romans have unquestionably the merit of having originated the art of B.-building proper in Europe, yet it seems doubtful whether the principle of the arch was not applied by eastern nations to B.-building, long before the dawn of the greatness of the Roman empire. The Chinese are said to have been before the West in this as in other arts, though the antiquity of some of the bridges on which this assertion is rested may well be doubted, considering the uncertainty which pervades the chronology of that extraordinary people.

It is impossible here to trace in detail the progress of the art. For a long time after the decay of the Roman empire, it made no progress. It revived in the 11th c., but again languished to the beginning of the 18th, when the formation of the corps of the Ponts et Chaussées in France favoured its further growth. Henceforth, many splendid bridges were erected both in Britain and the continent. In 1775, Mr Pritchard of Shrewsbury, introducing the use of cast iron in the erection of bridges, originated a valuable style of construction. The genius and works of Telford bring us to the present time. Within half a century, the use of steam, the development of the canal system, and the necessity especially for railway-bridges, with the immense amount of capital at the disposal of engineers for purposes of B.-building, have caused a rapid evolution of all the principles and possible modes of the art. Among the new forms called forth within the century by the increasing demand for facilities of communication, are the suspension B., the wrought-iron girder and tubular bridges, and the lattice-bridges. Several of the new bridges over the Thames are models of engineering skill and taste. The Menai and Britannia bridges were regarded when erected as perfect marvels of the art, and yet they have since been surpassed. In America, the B. of Trenton, over the Delaware, the great Portage viaduct, and the Niagara suspension B., are equal to any similar works in the world.

Perhaps no art has afforded greater scope for the application of mechanical science and engineering ingenuity than that of B.-building. The variety of complex structures of wood and of iron that now span streams and hollows is endless. For some of the more important forms, see FRAME, LATTICE, TUBULAR, and SUSPENSION BRIDGES. What follows here, relates chiefly to arched or masonic bridges,

BRIDGE.

and is confined to the more general and obvious conditions which such bridges must fulfil, avoiding the mechanical theory of their stability as too abstruse for popular exposition.

An arched B. rests between masses of masonry on opposite sides of a river, called its *abutments* (q. v.). The intermediate points of support of the arches are the piers (q. v.), which are rarely built so strong as to be able of themselves to resist the lateral thrust of the arches resting on them, if the thrust of one arch did not counteract that of another. The arch itself is the curved construction between adjacent piers. The chief terms used in speaking of the arch itself are explained under ARCH. In addition, may be noticed the *spandril*, the name given to the filling in above the extrados to the roadway. The *chord* or *span* is the distance between the piers; while the *rise* of the arch is the perpendicular distance between the level of the springing and the horizontal through the key.

When a B. has to be erected, the question of what form it should be falls to be settled by a variety of considerations. Regard to appearance affects the question, but the material points are its sufficiency for the purposes for which it is intended, and its security and durability. The nature of the embankments and of the soil in the water-bed, together with the nature of the water-shed, or country drained by the stream, may make it necessary that the B. should not be an arched bridge at all, but a suspension or tubular bridge. But if it is to be an arched B., then the most important questions respect the number of its piers and the form of its arches. If vessels must be free to pass under it, the arches must be lofty, and the abutments high; so also must they be if the river is exposed to sudden elevations of its level by floods. Formerly, a prejudice existed against laying a B. across a stream at any other angle than at right angles to its course. The reason was, that, the theory of the skewed arch (q. v.) being unknown, the obliquity of the B. to the water-course involved a corresponding obliquity of its piers to the water, which greatly increased the risk of the B. suffering from floods. That

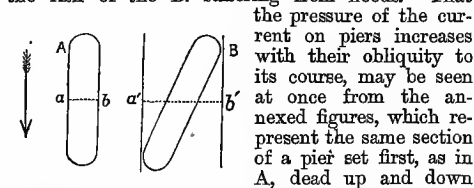

the pressure of the current on piers increases with their obliquity to its course, may be seen at once from the annexed figures, which represent the same section of a pier set first, as in A, dead up and down the stream, and next, as in B, obliquely to it. The mass of water which strikes B is equal in breadth to $a'b'$, the distance between lines through the extremities of B, parallel to the stream; while the mass which strikes A is in breadth only equal to ab , the thickness of the pier. But the skewed arch allows a B. to be thrown at any angle across a river, with its piers all parallel to the stream; and many an awkward turn in our public roads would have been spared us, had the skewed arch only been earlier known.

After making allowance for the requirements of position and traffic, the form next must be considered, more particularly in relation to the stream. The stream principally affects the form, through prescribing the number of piers. Each pier takes up so much of the water-course, and thus narrows the effective passage of the water. The immediate consequence of narrowing the channel is to increase the velocity of the stream. As the velocity of the stream increases, it tends more and more to carry off the soil in the neighbourhood of the piers, and finally, by deepening its course, to undermine them.

From this consideration, the effect of too many piers will be obvious; but indeed this is not matter of speculation, for many bridges—among others, a B. of Smeaton's at Hexham—have been destroyed from this cause, thus falling from the very overabundance of support! To know how many piers may with safety be used, the volume of water that flows through the channel, both ordinarily and in winter-floods, must be ascertained, which can be done very nearly by calculating the mean of many soundings taken at different states of the river, and at a succession of points across its bed. There is another way in which the stream affects the form. If it is liable to floods, care must be taken to make the piers so high as to elevate the spring of the arches above the highest level attainable by the water. The annexed figure sufficiently shews how greatly the pressure of the water on the B. increases whenever it reaches above the pier-head—the breadth above the springing, as at $abcd$, greatly exceeding the breadth of the pier itself. In connection with this part of the subject, it must be remembered, too, that floods are apt to carry down trees and other floating masses, which, if the arches do not afford them passage, become powerful levers for the destruction of the bridge.

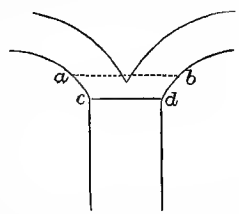

The form of the B. being determined on, the remaining questions relate to its stability. This depends on the strength of the abutments and piers, and the balanced equilibrium of the arches. The importance of securing proper foundations for the abutments and piers cannot be overestimated, and very frequently their foundations, owing to the nature of the soil, have to be artificially constructed. See PILES, COFFER-DAM, and CONCRETE. In considering the stability of the B., the first thing is to ascertain the forces which will act to destroy it. This is ascertained by calculating the extreme passing load, and also the weight of the structure above the arches, and of the arches themselves. A scientific and skilled engineer is then able to judge what amount of strain or destructive pressure will be exercised by these weights on the several parts of the structure, and thus to adapt the strength at every point to the strain. As to the passing load, it is usual to calculate on 240 lbs. per foot, superficial, of the whole area in ordinary bridges, and on 960 lbs. in railway-bridges. The weight of the superstructure and arches is a question for practical measurement. As to the remaining pressure—viz., that of the stream—it must be ascertained for the highest floods. It is calculated from knowing the mean velocity of the stream, and the amount of surface exposed to it. The surface velocity is readily observed by means of floats; and when this is under 10 feet per second, the mean velocity is found to be about one-fifth less. The stress of the stream on the bridge is diminished by the expedient known as a cut-water, which is an angular projection from the pier, as shewn in the annexed figure. The best form for a cut-water has practically been ascertained to be an equilateral prism, presenting an angle of 60° to the water-course. In all bridges, these are to be found on the sides of the piers presented to the stream; and in tidal rivers, they are built on the lower side as well.

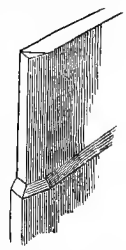

BRIDGE-BUILDING BROTHERHOODS—BRIDGE-HEAD.

After the conditions already mentioned are satisfied, taste has more to do with the form of the arches than anything else. The forms in use are the old semicircular, the elliptical—usually got at by putting together several circular arches of different radii—and the segmental arch. The semicircular arch was almost exclusively used in the more ancient bridges. This arch is the most solid and most easily constructed, as all the voussoirs may be worked from the same mould. It requires, however, high banking, as its height is equal half its breadth; and where the water-level greatly changes, it is particularly unsuitable, from the great height necessary to be given to the piers, to carry the intrados out of water-reach. The elliptical arch and the segmental of 60° are, besides, far more pleasing in appearance.

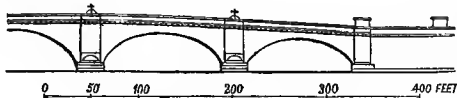

Elliptical Arches.—London Bridge.

In possible extent of span, the masonic bridge is far exceeded by suspension and girder bridges. At Chester there is a stone arch with a span of 200 feet, perhaps the greatest in Britain; in the Britannia Tubular Bridge the span is 460 feet; in the suspension-bridge over the Menai Strait, 600 feet; and in the suspension-bridge at Freiburg, Switzerland, 870 feet.

It has been already mentioned that bridges are built of various materials—wood, iron, stone, and brick. The principal objection to the wooden B. is its liability to decay, besides which it is liable to warping, through the swelling and contracting of its beams. The latter objection applies also to iron bridges, but in their case, the contractions and expansions from heat and cold may be compensated for, as in the compensation-balance of a watch, or the compensation-pendulum.

Public bridges are maintainable at the expense of the counties in which they are situated; but in many cities and boroughs, the inhabitants have acquired by prescription a liability for this expense, and by the 13 and 14 Vict. c. 64, the management and control of such bridges is given to the council of the city or borough. If part of a public bridge be within one county or other place on which the liability rests, and the other part of the bridge be within another, each party or body shall repair that part of the bridge which is within its own boundaries. Besides the bridge itself, the county liable is bound by the 22 Henry VIII. c. 5, to repair 300 feet of the road either way from the bridge. And such is still the state of the law as to all bridges built prior to the passing of the Highway Act, 5 and 6 Will. IV. c. 50. But by that act it is provided that, in the case of all bridges thereafter to be built, the repair of the road itself passing over or adjoining to a bridge, shall be done by the parish, or other parties bound to the general repair of the highway of which it forms a portion—the county being still subject, however, to its former obligation as regards 'the walls, banks, or fences of the raised causeways, and raised approaches to any bridge, or the land arches thereof.' See Stephen's *Com.*, vol. iii. p. 234. The neglect to make such repairs is treated in law-books as a kind of negative offence; but there are positive offences against bridges, which in the statutes are called nuisances, as to which, see the 43 Geo. III. c. 59, s. 1, by which it is enacted that the surveyors of county bridges shall have the power and authority of removing all nuisances in the form of obstructions

or other annoyances. Private bridges are those erected and maintained under contracts authorised by private acts of parliament. See *ROAD*.

BRIDGE-BUILDING BROTHERHOODS (Fr. *Freres pontifes*; Lat. *Frates pontifices*) were religious societies that originated in the south of France in the latter half of the 12th century. Their purpose was to establish hospices at the most frequented fords of large rivers, to keep up ferries, and to build bridges. The church during the middle ages regarded the making of streets and bridges as meritorious religious service. Whether or not the herdsman Benezet, subsequently canonised, was the founder or only a member of this fraternity, is as uncertain as the tradition which attributes to him the completion of the bridge over the Rhone at Avignon in 1180. The fraternity was sanctioned by Pope Clemens III. in 1189; its internal organisation was similar to that of the knightly orders, and the members wore as their badge or insignia a pick-hammer on the breast. In France, they laboured very actively, but were gradually absorbed into the order of St John. Similar associations sprang up in other lands, but under different names.

BRIDGE, MILITARY, is a temporary construction, to facilitate the passage of rivers by troops, cannon, and military wagons. The most efficient are described under **PONTOON**; but there are many other kinds. A *bridge of boats* is formed by small-craft, especially cargo-boats, collected from various places up and down the river; trestles are placed in them to bring their tops to one common level; the boats are anchored across the river, and balks of timber, resting on the trestles, form a continuous road from boat to boat across the whole breadth of the river; the boats ought to be of such size that, when fully laden, the gunwales or upper edges shall not be less than one foot above the water. *Rope-bridges* are sometimes but not frequently used by military engineers. A *boat-and-rope bridge* consists of cables resting on boats, and supporting a platform or road of stout timber. A *cask-bridge* consists of a series of timber-rafts resting on casks; the casks are grouped together in quadrangular masses; at certain intervals, timbers are laid upon them to form rafts, and several such rafts form a bridge; it is an inferior kind of pontoon-bridge. A *trestle-bridge* is sometimes made for crossing a small stream in a hilly country; it consists of trestles hastily made up in any rough materials that may be at hand, with planking or fascines to form a flooring, cables to keep the trestles in a straight line, and heavy stones to prevent them from floating. *Raft-bridges*, consisting of planks lashed together, are easily made of any rough materials that may be found on the spot; but they have little buoyancy, and are not very manageable. A *swing-flying bridge* consists of a bridge of boats, of which one end is moored in the centre of the river, and the other end left loose; this loose end is brought to the proper side of the river, the boats are laden, and they make a semicircular sweep across the river by means of rudders and oars, until the loose end of the bridge reaches the other bank. A *trail-flying bridge* is a boat or raft, or a string of boats or rafts, which is drawn across a river by ropes, in a line marked out and limited by other ropes.

BRIDGE-HEAD, or TÊTE-DU-PONT, in Military Engineering, is a fortified post intended to defend the passage of a river over a bridge. It is a field-work, open at the gorge or in the rear, and having its two flanks on the banks of the river. The most favourable position is at a re-entering sinuosity of

the river, where the guns can work better with the supporting batteries opposite. Bridge-heads are

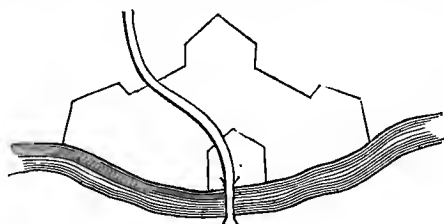

Bridge-head Defence Work.

usually temporary works, hastily constructed. Their most frequent use is to aid a retiring army to cross the river in good order, and to check an enemy pressing upon it. Openings are left to allow the retiring army, with guns and carriages, to file through without confusion; and parapets are so disposed as to flank and defend these openings.

BRIDGE OF ALLAN. See **ALLAN.**

BRIDGEMAN, LAURA. This famous blind mute was born in Hanover, New Hampshire, United States, on the 21st December 1829. She was a bright, intelligent child, but at two years of age was seized with a violent fever, which utterly destroyed both sight and hearing. For a time this so shattered her system, that there seemed no hope of recovery; but she rallied, and soon learned to find her way about the house and neighbourhood, and even learned to sew and to knit a little. A strong passion for imitation began to develop itself, and by assiduously cultivating this power, she was at last enabled to emerge out of her life of unbroken darkness and silence, and take her place among the educated people of the day. In 1839, Dr Howe of Boston undertook her care and education at the Deaf and Dumb School. The first attempt was to give her a knowledge of arbitrary signs, by which she could interchange thoughts with others. Then she learned to read embossed letters by the touch; next, embossed words were attached to different articles, and she learned to associate each word with its corresponding object. A pat on the head told her when she was right in her spelling-lesson. Thus far, however, the work was only an exercise of imitation and memory, roused into exertion by the motive of love of approbation, but seemingly without intellectual perception of the relation between words and things. It was like teaching a clever dog a variety of tricks. But at last the truth flashed upon her, that by this means she could communicate to others a sign of what was passing in her own mind. Her whole being seemed changed. The next step was to procure a set of metal types, with the letters cast at the ends, and a board with square holes for their insertion, so as to be read by the finger. In six months, she could write down the name of most common objects, and in two years had made great bodily and mental improvement. She grew happier, and enjoyed play like other children, amusing herself with imaginary dialogues, spelling old and new words, and with her left hand slapping the fingers of her right, if they spelled a word wrong; or giving herself a pat of approval, as the teacher did, when correct. Her touch grew in accuracy as its power increased; she learned to know people almost instantly by the touch alone. In a year or two more, she was able to receive lessons in geography, algebra, and history. She received and answered letters from all parts of the world, and was always employed, and therefore

always happy. Her brain seems to have been unduly excited for a blind person; she not only held imaginary dialogues with herself, but dreamed incessantly by night; and during these dreams, while asleep, talked much on her fingers. She learned to write a fair, legible, square hand, and to read with great dexterity, and at last, even to think deeply, and to reason with good sense and discrimination. Keen, sensitive, and lively, in various occupation, her days now pass rapidly and pleasantly, mainly owing to the unremitting skill and kindness of Dr Howe. She was saved by him from a life of hopeless, helpless darkness; educated and trained to take her part in the world; and now, as a teacher of the blind and deaf and dumb, is conferring on them the blessings she has herself received. She is probably among the most skillful of Blind teachers.

BRIDGENORTH, a town of Salop or Shropshire, on both sides of the Severn, 20 miles south-east of Shrewsbury. It consists of an upper and lower town, connected by a bridge over the Severn. The larger part of the town is on the right bank, and is built on a sandstone rock rising 60 feet above the river. Pop. 7160. It returns two members to parliament. The navigation of the Severn formerly employed many of the inhabitants, but the traffic has been greatly injured by the introduction of railways. The town, which was at one time called *Bruges* or *Brug*, is said to be of Saxon origin. In the beginning of the 12th c., the Earl of Shrewsbury defended the town unsuccessfully against Henry I. It was besieged in the same century by Henry II.; and during the civil wars it resisted the Parliamentary forces for three weeks. A great portion of the town was on this occasion destroyed by fire. It has carpet and worsted manufactories. Bishop Percy was born here.

BRIDGEPORT, a seaport of Connecticut, U. S., at the mouth of the Pequomock, which empties itself into an inlet of Long Island Sound. It is in lat. 41° 11' N., and long. 73° 12' W., being 178 miles to the south-west of Boston, and 58 to the north-east of New York. In 1850, the population was 7560, having gained 2990 in 10 years. B. is connected by railways both with the interior and with the other places generally on the seaboard. Though the harbour does not admit large ships, having only 13 feet on the bar at high-water, yet B. has a considerable coasting-trade, and a number of vessels engaged in the whale-fishery. Its manufactures are extensive, particularly of carriages and harness.

BRIDGET, St (or, more properly, *Birgit* or *Brigitte*), a famous Roman Catholic saint, was born in Sweden about the year 1302. Her father was a prince of the blood-royal of Sweden. When only sixteen, she married Ulf Gudmarson, Prince of Nericia, a stripling of eighteen, by whom she had eight children, the youngest of whom, named Catherine, born in 1336, died in 1381, became *par excellence* the female saint of Sweden. Her husband and she now solemnly vowed to spend the remainder of their lives in a state of continence, and, to obtain strength to carry out their severe resolution, made a pilgrimage to the shrine of St Jago de Compostella in Spain. On their return, Ulf died in 1344, and B. founded about the same time the monastery of Wadstena, in East Gothland. Sixty nuns and twenty-five monks were its first inmates. They received the rule of St Augustine, to which St B. herself added a few particulars. They constituted a new order, sometimes called the order of St B., sometimes the order of St Salvator, or the Holy Saviour, which flourished in Sweden until the Reformation, when it was suppressed, but it still possesses some establishments in Italy,

BRIDGETON—BRIDGEWATER TREATISES.

Portugal, and elsewhere. Subsequently, St B. went to Rome, where she founded a hospice for pilgrims and Swedish students, which was reorganised by Leo X. After having made a pilgrimage to Palestine, she died at Rome on her return, 23d July 1373. Her bones were carried to Wadstena, and she herself was canonised in 1391 by Pope Boniface IX. Her festival is on the 8th of October. The *Revelations of St Brigitta*, written by her confessors, was keenly attacked by the celebrated Gerson, but obtained the approval of the Council of Basel, and has passed through many editions. Besides the *Revelations*, there have been attributed to this saint a sermon on the Virgin, and five discourses on the passion of Jesus Christ, preceded by an introduction which was condemned by the congregation of the *Indes*.

Not to be confounded with this Swedish saint is another St Bridget, or St Bride, as she is more commonly called, a native of Ireland, who flourished in the end of the 5th and beginning of the 6th c., and was renowned for her beauty. To escape the temptations to which this dangerous gift exposed her, as well as the offers of marriage with which she was annoyed, she prayed God to make her ugly. Her prayer was granted; and she retired from the world, founded the monastery of Kildare, and devoted herself to the education of young girls. Her day falls on the 1st of February. She was regarded as one of the three great saints of Ireland, the others being St Patrick and St Columba. She was held in great reverence in Scotland, and was regarded by the Douglasses as their tutelary saint.

BRIDGETON, a port of entry in New Jersey, U.S., about 40 miles south of Philadelphia. It occupies both banks of the Cohansey Creek, about 20 miles above its entrance into Delaware Bay, its two divisions being connected by a wooden draw-bridge. Though the population, in 1850, was only 2446, yet the place is worthy of notice as containing two newspaper-offices, an iron foundry, a rolling-mill, a nail-factory, and a glass-work. It likewise owns upwards of 15,000 tons of shipping.

BRIDGETOWN, the capital of Barbadoes (q. v.). It stands on the west coast of the island, stretching along the north side of Carlisle Bay, which forms its roadstead. It contains 19,362 inhabitants, its lat. being 13° 4' N., and long. 59° 37' W. It is the residence of the Bishop of Barbadoes and of the Governor-general of the Windward Islands. B. was founded about the middle of the 17th c., taking the name of Indian Bridge, and subsequently its present appellation, from a rude aboriginal structure which spanned a neighbouring creek. The existing city, however, is less than 100 years old, its predecessor having been almost utterly destroyed by fire in May 1766. It also suffered very severely from fire in 1845. With the exception of Broad Street, the thoroughfares are very irregular; and the shops, from the want of windows in front, look heavy and unattractive.

BRIDGEWATER, a town and port of Somersetshire, on both sides of the Parret (which is here spanned by an iron bridge), 6 miles in a direct line, and 12 by the river, from the Bristol Channel, and 30 miles south-west of Bristol. It stands on the border of a marshy plain which lies between the Mendip and Quantock Hills, but the country around is well wooded. It is chiefly built of brick. St Mary's Church has a remarkably slender and lofty spire. The Parret admits vessels of 200 tons up to the town; it rises 36 feet at spring-tides, and is subject to a bore or perpendicular advancing wave, 6 feet high, often causing much annoyance to shipping. Pop. 10,317. B. returns two members to

parliament. Bath or scouring bricks, peculiar to B., are made here of a mixture of sand and clay found in the river. Admiral Blake was a native of this town, which suffered severely in the civil wars, when it was besieged by Fairfax, and ultimately forced to surrender, the castle being dismantled by the conqueror. The unfortunate Duke of Monmouth was proclaimed king by the corporation of B., before the battle of Sedgemoor, which occurred in 1685, 5 miles south-east of B., and in which he was defeated by the royal army. In 1859, 138 vessels, of 15,909 tons, belonged to the port; and in the same year the number of vessels entering was 3203, with an aggregate burden of 148,540 tons, clearing 1439, burden 67,490 tons.

BRIDGEWATER, FRANCIS EGERTON, DUKE OF, styled the 'Father of British Inland Navigation,' youngest son of Scroop, fourth Earl and first Duke of B., was born in 1736, and succeeded his elder brother, second duke, in 1748. In 1758—1760, he obtained acts of parliament for making a navigable canal from Worsley to Salford, Lancashire, and carrying it over the Mersey and Irwell Navigation at Barton by an aqueduct 39 feet above the surface of the water, and 200 yards long, thus forming a communication between his coal-mines at Worsley and Manchester, on one level. In this great undertaking he was aided by the skill of James Brindley (q. v.), the celebrated engineer, and expended large sums of money. He was also a liberal promoter of the Grand Trunk Navigation; and the impulse he thus gave to the internal navigation of England, led to the extension of the canal-system throughout the kingdom. In politics, though he took no active part, B. was a friend to the Pitt administration, and a contributor to the Loyalty Loan of no less than £100,000. He died unmarried, March 8, 1803, and with his death the dukedom became extinct. Before he began to realise profits from his great work, B. lived in privacy, and restricted himself to the simplest fare; and after his death his great wealth was distributed among collateral branches of his family. A monument was erected to his memory in Manchester.

BRIDGEWATER, FRANCIS HENRY EGERTON, EARL OF, son of John Egerton, Bishop of Durham, grandnephew of the first Duke of B., succeeded his brother as eighth earl, October 21, 1823. Educated for the church, he had previously been prebendary of Durham. He died unmarried, in February 1829, and the title became extinct. By his last will, dated February 25, 1825, he left £8000, invested in the public funds, to be paid to the author of the best treatise 'On the Power, Wisdom, and Goodness of God, as manifested in the Creation,' illustrating such work by such arguments as the variety and formation of God's creatures in the animal, vegetable, and mineral kingdoms, the effect of digestion, the construction of the hand of man, and by discoveries, ancient and modern, in arts, sciences, and the whole extent of literature. The then president of the Royal Society of London, Davies Gilbert, to whom the selection of the author was left, with the advice of the Archbishop of Canterbury, the Bishop of London, and a noble friend of the deceased earl, judiciously resolved, that instead of being given to one man for one work, the money should be allotted to eight different persons for eight separate treatises, though all connected with the same primary theme (see next article). B. also left upwards of £12,000 to the British Museum, the interest to be employed in the purchase and care of MSS. for the public use.

BRIDGEWATER TREATISES, eight celebrated works 'On the Power, Wisdom, and Goodness

of God,' by eight of the most eminent authors in their respective departments, published under a bequest of the last Earl of Bridgewater (q. v.), whereby each received £1000, with the copyright of his own treatise. They are: 1. *The Adaptation of External Nature to the Moral and Intellectual Constitution of Man*, by Thomas Chalmers, D.D. (Lond. 1833, 2 vols. 8vo). 2. *Chemistry, Meteorology, and the Function of Digestion, considered with Reference to Natural Theology*, by William Prout, M.D. (Lond. 1834, 8vo). 3. *On the History, Habits, and Instincts of Animals*, by the Rev. William Kirby (Lond. 1835, 2 vols. 8vo). 4. *On Geology and Mineralogy*, by the Rev. Dr Buckland (Lond. 1837, 2 vols. 8vo). 5. *The Hand, its Mechanism and Vital Endowments, as evincing Design*, by Sir Charles Bell (Lond. 1837, 8vo). 6. *The Adaptation of External Nature to the Physical Condition of Man*, by John Kidd, M.D. (Lond. 1837, 8vo). 7. *Astronomy and General Physics, considered with Reference to Natural Theology*, by the Rev. William Whewell (Lond. 1839, 8vo). 8. *Animal and Vegetable Physiology, considered with Reference to Natural Theology*, by Peter Mark Roget, M.D. (Lond. 1840, 2 vols. 8vo). All these works have since been republished by Bohn.

BRIDLINGTON, or **BURLINGTON**, a sea-coast town in the East Riding of Yorkshire (including Bridlington Quay, a port and bathing-place about 1 mile to the south-east), 6 miles west of Flamborough Head, and 40 miles east-north-east of York. B. is situated on a gentle slope in a recess of a beautiful bay. The country is hilly to the north, but subsides to the south into a flat alluvial and fertile tract called Holderness. It has the aspect of an old town with narrow irregular streets. Pop. 6846. It has a considerable trade in corn, and also some soap-boiling and bone-grinding works. B. is supposed to have been the site of a Roman station. The Danes had strongholds in this vicinity for nearly 300 years, and many engagements between them and the Saxons and Normans occurred here. Great numbers of ancient tumuli or barrows still exist. An Augustine priory of immense wealth, and which subsisted for 400 years, was founded here by a grand-nephew of the Conqueror, and obtained many privileges from Henry I., and also from King John. Some parts of it yet remain. In 1643, Henrietta, queen of Charles I., landed here with arms and ammunition from Holland bought with the crown-jewels. Bridlington Quay has a chalybeate mineral spring, as well as an intermitting one of pure water. B. is noted for its chalk-flint fossils. In the lacustrine deposits near B. were found, some years ago, the bones of a large extinct elk, with branching horns, measuring 11 feet from tip to tip.

BRIDPORT, a town in Dorsetshire, in a vale at the confluence of the Asker and the Birt, or Brit, or Bride, 16 miles west-north-west of Dorchester, and 2 miles from the English Channel. It stands on a gentle eminence surrounded by hills, and consists chiefly of three spacious and airy streets. Pop. 7566. It returns two members to parliament. The chief manufactures are twine, shoe-thread, cordage, fishing-nets, and sail-cloth; and ship-building is carried on to some extent. The vicinity is celebrated for its cheese and butter. B. was a considerable town before the Norman Conquest, and had a mint for coining silver. In 1859, 15 vessels of 1475 tons belonged to the port; and in the same year the number of vessels entering and clearing were respectively 164, with a tonnage of 12,259 tons, and 81 of 4877 tons. On the coast near, are sandy cliffs, 200 feet high, abounding in oolitic fossils.

BRIEF, or **BREVE**, **PAPAL** (Lat. *brevis*, short),

a word which, in the corrupt Latinity of the early ages, was made to signify a short letter written to one or more persons (hence the German *brief*, a letter). It is now used to denote certain pontifical writings, which, however, do not receive their name from the brevity of the composition, but from the smallness of the caligraphy. The papal B. differs from the papal bull (q. v.) in several points. It gives decisions on matters of inferior importance, such as discipline, dispensations, release from vows, indulgences, &c., which do not necessarily require the deliberations of a conclave of cardinals. Still, it is not to be confounded with the *motus proprii*, or private epistle of the pope as an individual, as its contents are always of an official character. His holiness speaks, as it were, with a kind of familiar parental authority, and the B. is consequently superscribed *papa*, while the person to whom it is addressed is termed *dilecte fili* (beloved son). It is signed not by the pope, but by the *Segretario de' Brevi*, an officer of the papal chancery, with red wax, and only with the pope's private seal, the fisherman's ring; hence it concludes *Datum Romæ sub annulo piscatoris* (Given at Rome under the ring of the fisherman). Like the bull, it is written on parchment, with this difference, that the bull is written on the rough side, and in ancient Gothic characters, while the brief is written on the smooth side, and in modern Roman characters.

BRIEF, in the practice of the English bar, is the name given to the written instructions on which barristers advocate causes in courts of justice. It is called a B. because it is, or ought to be, an abbreviated statement of the pleadings, proofs, and affidavits at law, or of the bill, answer, and other proceedings in equity, with a concise narrative of the facts and merits of the plaintiff's case, or the defendant's defence. But it is also used in forensic business generally, being applied, not only in the courts of law and equity, but also in all other tribunals, whether inferior or superior, original or appellate. In Scotland, the corresponding term is *Memorial*. The skill of the attorney or solicitor is shewn in the preparation of this important document, which should be characterised by arrangement and compression, without any material omission.

BRIEG, a town of Silesia, Prussia, about 27 miles south-east of Breslau. It is situated on the left bank of the Oder, and on the railway between Breslau and Vienna, and is surrounded with walls, which have been partly converted into promenades. The streets are wide and regular, and commercially B. is a thriving town, its manufactures including linens, woollens, cottons, hosiery, ribbons, lace, leather, and tobacco. The battle-field of Mollwitz (q. v.) lies a little to the west of Brieg. Pop. about 12,000.

BRIEL, **BRIELLE**, or **THE BRILL**, a fortified seaport town, on the north side of the island of Voorne, Holland. It is situated near the mouth of the Maas, about 14 miles west of Rotterdam, in lat. 51° 54' N., and long. 4° 10' E. B. possesses a good harbour, and is intersected by several canals. It has a population of about 5000, the male portion of which are chiefly engaged as pilots and fishermen. B. may be considered as the nucleus of the Dutch republic, having been taken from the Spaniards by William de la Marck in 1572. This event was the first act of open hostility to Philip II., and paved the way to the complete liberation of the country from a foreign yoke. In 1585, B. was one of the towns made over to England as security for certain advances made to the states of Holland; it was restored to the Dutch in 1616. B. was the first

town of Holland which, without extraneous aid, expelled the French in 1813. The celebrated admirals De Witt and Van Tromp were natives of this place.

BRIENNE-LE-CHATEAU, or **BRIENNE-NAPOLÉON**, a small town in the department of Aube, France, on the right bank of the river Aube, and about 14 miles north-west of Bar-sur-Aube. It is celebrated as the place where Napoleon I. received his earliest military education, he having entered the school here in 1779, when he was 10 years old, and remained until 1784. It is also remarkable on account of the battle fought here between the French and the allies in 1814. On the 29th of January, Bonaparte, who had collected his forces in the vicinity of B., with a view to check the advance of the allies on Paris, attacked Blucher, who was stationed in the town, and drove him out with considerable loss. In the struggle, the town, which was chiefly composed of wood, was almost reduced to ashes. On the 30th, the contest was renewed, and Blucher was forced to retreat to Trannes. On the following day, Napoleon deployed his forces in the plain between La Rothière and Trannes, and on February 1, the corps of the Crown-prince of Würtemberg and Count Giulay, and the Russian reserves of grenadiers, having joined Blucher, Prince Schwarzenberg gave orders to renew the combat. After a sanguinary struggle, during which Napoleon, feeling the importance of the contest, exerted all his influence over his troops, led several charges in person, and frequently exposed himself to danger, victory at length declared decisively for the allies at every point. During the night of February 1 and the morning of the following day, the French troops retreated from Brienne-le-Chateau. The loss on both sides was about equal, consisting of nearly 5000 killed and wounded. The allies took 9000 prisoners, and 70 pieces of artillery. This victory at B. opened the way to Paris, and led to the fall of the empire.

BRIENZ, a town of the canton of Bern, Switzerland, beautifully situated at the foot of the Bernese Alps, on the north-east shore of the lake of the same name, and about 30 miles east-south-east of Bern. Its cheese is held in high repute. Pop. 3102.—The Lake of B., which is about 8 miles long and 2 in breadth, is formed by the river Aar, at the foot of the Hasli valley, and by the same river it discharges its surplus waters into Lake Thun. The lake is situated at an elevation of 850 feet above the sea; its average depth is about 500 feet, but in some places it is said to have a depth of more than 2000 feet. It is surrounded by elevated mountains, the principal of which is the Rothorn, from which splendid views of the whole range of the Bernese Alps are obtained. A small steamer plies daily on the lake between B. and Interlaken, touching at the celebrated Giessbach Fall every trip.

BRIEUC, St, a seaport town, in the department of Côtes-du-Nord, France, situated on the right bank of the Gouet, about 2 miles from its mouth in the Bay of St B., a part of the English Channel, in lat. 48° 31' N., and long. 2° 45' W. The town is said to owe its origin to an Irishman, St Brieuc, who built a monastery here in the 5th century. St B. has the ruins of an old tower that formerly defended the entrance to the river, but was partially blown up by order of Henri IV. in 1598, and a cathedral, part of which dates from the 11th century. The ramparts were destroyed in 1788, and their site has been converted into a pleasant promenade, terminating in a terrace that commands a fine view of the Channel. St B. has manufactures of woollen stuffs, linen,

cotton, leather, paper, &c.; it has also ship-building yards, and a trade in agricultural produce. Pop. 10,764.

BRIG, BRIGANTINE. A brig is a square-rigged vessel with two masts. A brigantine, or hermaphrodite brig, is a two-masted vessel, with the mainmast of a schooner and the foremast of a

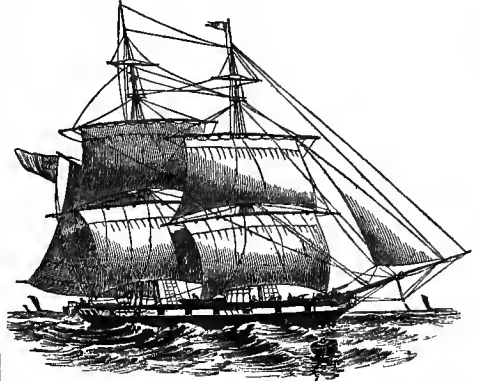

Brig.

brig. A brig's mainsail is the lowest square sail on the mainmast, whereas the mainsail of a brigantine is a fore-and-aft sail like that of a schooner.

BRIGADE, in the military service, is a group of regiments or battalions combined into one body. When a British army takes the field, it is customary for three battalions to form a *brigade*, and two brigades a *division*. Thus, at the battle of the Alma, each of the five divisions of British infantry comprised two brigades; and of these ten brigades, nine consisted of three battalions each, the tenth being somewhat stronger. It is nothing more than a temporary grouping, which can be broken up whenever the commanding officer thinks fit. The household troops, comprising the Horse Guards, Life Guards, and Foot Guards, are sometimes called the *Household Brigade*.

BRIGADE MAJOR is a military officer who exercises duties, in a brigade, analogous to those of the adjutant of a regiment. He attends to matters of discipline, and to the personal movements of the men. When regiments or battalions are brigaded, a brigade-major is appointed, usually from among the captains. He conveys orders, keeps the rollster or roster, inspects guards and pickets, and directs exercises and evolutions; but he nevertheless remains on the books of a particular regiment, and returns to his regimental duties when the B. is broken up.

BRIGADIER, or **BRIGADIER-GENERAL**, is an officer of a regiment (usually a colonel or lieutenant-colonel), who, for a limited time and for a special service, is placed upon brigade duties. He is then a general or commander of a brigade, which usually contains his own regiment as one of the number. When the brigade is broken up, he falls back to his colonelcy, unless his services lead to his promotion to the rank of Major-general.

BRIGANDINE, among the articles of armour worn during the middle ages, was an assemblage of small plates of iron, sewed upon quilted linen or leather, and covered with a similar substance to hide the glittering of the metal. It formed a sort of coat or tunic. The B. was named from the *Brigands*, a kind of light-armed irregular corps, employed something like the Cossacks and Bashi-bazouks of

recent days, and, like them, addicted to marauding and pilfering; hence the word *Brigand*.

BRIGANTES. See **BRITANNIA**.

BRIGANTINE. See **BRIG**.

BRIGGS, HENRY, a distinguished mathematician, was born in 1556, at Warleywood, near Halifax, Yorkshire, and studied at St John's College, Cambridge. In 1596 he was appointed first reader in geometry at Gresham House (afterwards College), London, and in 1619 first Savilian professor of geometry in Oxford. This office he retained till the time of his death, which took place at Oxford, January 26, 1631. B. made an important contribution to the theory of logarithms, of which he constructed invaluable tables. Napier the inventor had, in 1614, published a table of the so-called natural logarithms, when B. observed that another system, in which the logarithm of 10 should be taken as unity, would afford great facilities of calculation. Napier admitted the improvement on his own system, and intended to assist in carrying the plan into effect; but died in 1618, when the whole work was left to Briggs. In the same year he published his *Chilias Prima Logarithmorum*, containing the first thousand natural numbers calculated to eight decimal places, and in 1624 published his *Arithmetica Logarithmica*, the fruit of many years of unwearied application, and giving the logarithms of natural numbers from 1 to 20,000, and from 90,000 to 101,000, with fifteen places. His system of logarithms is that now commonly adopted. Leaving others to carry out his calculations, for which he had provided every facility, he next employed himself on a Table of Logarithms of sines and tangents, carried to the hundredth part of a degree, and to fifteen places, which, with a table of natural sines, tangents, and secants, was posthumously published at Gouda, in Holland, 1633, under the title of *Trigonometria Britannica*.

BRIGHT, JOHN, a popular politician, first brought into notice by the Anti-Corn-Law agitation, son of Jacob Bright, a Quaker cotton spinner and manufacturer at Rochdale, Lancashire, was born at Greenbank, near that town, November 16, 1811. In 1835, he made a foreign tour, which included a journey to Palestine, and, on his return, delivered before a literary institution at Rochdale, of which he was one of the founders, lectures on the subject of his travels, and on topics connected with commerce and political economy. When the Anti-Corn-Law League was formed in 1839, he was one of its leading members, and, with Mr Cobden, engaged in an extensive Free-trade agitation throughout the kingdom. In the spring of 1843, he offered himself as a candidate for the representation of Durham, and, though at first unsuccessful, he became, in July of the same year, M.P. for that city. At all times an animated and effective speaker, B. was incessant, both at public meetings and in parliament, in his opposition to the Corn Laws, until they were finally repealed. In 1845 he obtained the appointment of a select committee of the House of Commons on the Game Laws, and also one on the subject of cotton cultivation in India. An abridgment of the evidence taken before the former, published in one volume, contained from his pen an *Address to the Tenant Farmers of Great Britain*, strongly condemning the existing Game Laws. At the general election of 1847, he was elected one of the members for Manchester. He co-operated with Mr Cobden in the movement in favour of financial reform. On the formation of the first Derby ministry, February 27, 1852, B. aided in the temporary re-organisation of the Corn-Law League, in favour of the principles of Free Trade; and at the

general election which followed, was re-elected for Manchester. A member of the Peace Society, and strenuously opposed to the war with Russia in 1854, B. was one of the meeting of the Society of Friends, by whom a deputation was sent to the Emperor Nicholas to urge upon him the maintenance of peace; and the following year, in the discussion of the Eastern question, he took a prominent part in energetically denouncing the Crimean war. A severe illness compelled him to withdraw for a time to the continent, and in his absence he was rejected by Manchester. Elected in 1857 for Birmingham, he seconded Mr Milner Gibson's motion against the second reading of the Conspiracy Bill, which led to the overthrow of Lord Palmerston's government. During the recess, he addressed several public meetings, both in England and Scotland, in favour of parliamentary reform, and published an elaborate scheme of change in our representative system. B. is the head of the firm of 'John Bright and Brothers,' cotton-spinners and manufacturers, Rochdale.

BRIGHTENING, in Calico-printing, is the operation of rendering the colours of printed fabrics more bright or brilliant, by boiling them in solutions of soda and other materials.

BRIGHTON, originally BRIGHTHELMSTONE, a town and a celebrated watering-place on the sea-coast of Sussex, 50½ miles south of London. It is built on a slope ascending eastward to a range of high chalk-cliffs (backed by the South Downs), bounding the coast as far as Beachy Head; to the west, these hills recede from the coast, and leave a long stretch of sands. Anciently, BRIGHTHELMSTONE was a mere fishing-village on a level under the cliff; and more than once it was burnt and plundered by French marauders. It was fortified by Henry VIII., and more strongly by Elizabeth; but the sea proved more dangerous than the French, and now washes over the site of the village of those days. The inroads of the sea in 1699, 1703, and 1705, undermined many cliffs and destroyed many houses. Its further inroads are prevented by a sea-wall of great strength (60 feet high, 23 feet thick at the base, and 2 miles long), extending along the cliffs, and built at the cost of £100,000. The writings of Dr Russel, a celebrated physician of George II.'s time, first drew public attention to B. as an eligible watering-place, and the discovery of a chalybeate spring in the vicinity increased its popularity. The visit of the Prince of Wales in 1782, and his subsequent yearly residence there, finally opened the eyes of the fashionable world to its immense attractions, and B. thenceforth became the crowded resort of a health-seeking population. Its progress has been very rapid, and the town is still steadily increasing. B. is for the most part extremely well built, as becomes a favoured retreat of wealth and aristocracy. It mostly consists of new and elegant streets, squares, and terraces. The hotels are magnificent. A range of splendid houses fronts the sea for nearly 3 miles, including the famous sea-wall, and the beach is easily accessible by gaps in the chalk-cliffs. Formerly, trees were a great rarity in B.; but within the last twelve years they have been planted both in and around the town, and are now to be seen of considerable size in the North Steyne Enclosures, the Level, and the Queen's Park. Pop., in 1801, 7339; in 1821, 24,429; in 1851, 65,569. B. returns two members to parliament. The town was incorporated in 1854. It contains, on an average, 20,000 visitors, and the population during the fashionable season amounts to 90,000. Living and house-rent are about a third higher than in London.

BRIGHT'S DISEASE—BRINDISI.

Near the centre of the town is the Pavilion or Marine Palace, a fantastic Oriental or Chinese structure, with domes, minarets, and pinnacles, and Moorish stables, begun for the Prince of Wales in 1784, and finished in 1827. It is now the property of the corporation of B., and with its fine pleasure-grounds of above seven acres, it is devoted to the recreation of the inhabitants. It stands in the Steyne, an open space between the east and west parts of the town. The Marine Parade, a fine terrace, extends about a mile along the margin of the cliff, between the Steyne and Kemp Town, a handsome suburb on the east. The Chain Pier, 1136 feet long, and 13 feet wide, was erected in 1823 at the cost of £30,000; it is a favourite promenade. B. has no maritime trade and no manufactures; but fishing is carried on to a considerable extent. An increase of permanent residents is continually flowing to B. from its large migratory population in summer and autumn, drawn thither by the salubrity of the place and its various fashionable attractions, as well as by the number of its schools, there being nearly 200 boarding-schools. Before the opening of the London and Brighton Railway, 32 coaches passed between the two places daily. There is a proprietary college, a fine building in the Tudor style. The sons of the late Duke of Wellington were pupils of the vicar of Brighton, and a very handsome memorial to the memory of the duke has been erected in the old parish church.

BRIGHT'S DISEASE (of the kidneys), so called after the English physician, Dr Bright, who first investigated its character, consists of a degeneration of the tissues of the kidney into fat, and will be better understood after the anatomy of the organ has been studied. Suffice it to say now, that this degenerated condition impairs the excreting powers of the organ, so that the urea is not sufficiently separated from the blood. The flow of the latter, when charged with this urea, is retarded through the minute vessels, congestion ensues, and exudation of albumen and fibrin is the result. When we apply heat to the urine from a kidney so affected, it becomes opaque, shewing that it contained *albumen* (q. v.); and on examining a drop of it under the microscope, we observe the exuded lymph mixed with epithelium in the form of casts of the small ducts of the diseased organ. The patient presents a flabby, bloodless look, is drowsy, and easily fatigued. The disease may succeed any of the eruptive fevers, and is frequently associated with enlargement of the heart.

The *causes* of this terrible malady are any which cause congestion of the kidneys—indulgence in strong drinks, long-continued suppuration, exposure to wet and cold, the exanthematous fevers, and pregnancy. The indications for *treatment* are, to remove any of those causes which may be present, rectify the other secretions, relieve any temporary congestion of the kidneys, at the same time endeavouring to increase the number of red blood globules by the administration of iron and vegetable bitters. And in the advanced stages, when the blood is poisoning the nervous centres, attempts should be made to restore the secretion of urine by administering diuretics (q. v.), by giving hydrochloric and vegetable acids, sponging the patient with vinegar, and relieving the congestion of the brain by purgatives and local bleeding.

BRIGNOLES, a town in the department of Var, France, beautifully situated in a fertile valley, surrounded by forest-clad hills, and watered by a stream called the Calami, about 22 miles west-south-west of Draguignan. B., which is a very

salubrious place, has manufactures of broad-cloth, silk twist, soap, leather, pottery, &c.; and a trade in wines, brandy, olives, and prunes. Pop. about 5000.

BRIHUEGA, a town of New Castile, Spain, 20 miles east-north-east of Guadalajara, is situated on the Tajuña, and was formerly surrounded by walls, of which traces still exist. The remains of an old Moorish fortress now serve as a cemetery. B. has manufactures of woollens, linen, glass, and leather. Pop. 4500. Here, in 1710, during the War of the Succession, the English general Stanhope, owing to the dilatoriness of his allies in affording him support, was defeated by the Duke de Vendôme, and compelled to surrender, with all his force, amounting to about 5500 men.

BRILL, the name of two Dutch painters.—**MATTHÆUS B.**, born at Antwerp, 1550, went during his youth to Italy, and, under the patronage of Pope Gregory XIII., painted several frescoes in the Vatican. He was also distinguished as a historical and landscape painter. He died in 1584.—His more celebrated younger brother, **PAUL B.**, born 1554 or 1556, received instruction under Matthæus in Rome, and soon excelled his master. His pieces were at first conceived in the fantastic style which then prevailed; but gradually his style increased in power and beauty, until it exerted a striking influence over landscape-painting. The works of his riper age exhibit high poetical qualities, and a fine appreciation of the effects of light in the sky, which have been described as but little inferior to those of his great successor, Claude Lorraine. They have a character of solemn rest and calmness, and at times even an elegiac tone of melancholy, which well accords with representations of the glories of fallen Rome. A collection of excellent landscapes by B. is found in the palace Rospigliosi in Rome, and two beautiful landscapes enrich the gallery of the Pitti Palace, Florence. Besides landscapes, B. painted scenes from biblical history; among them, the 'Tower of Babel,' now in the Berlin Museum. Other pictures by B. are found in the galleries of Munich, Vienna, and the Louvre. He died at Rome in 1626.

BRILL (*Rhombus vulgaris*), a fish of the same genus with the turbot (q. v.), found in considerable abundance on some parts of the British coasts, and common in the markets of the larger towns. It resembles the turbot more than any other British species of this genus, but is at once distinguished by its inferior breadth, which (excluding the fins) is only equal to half its entire length; by the want of tubercles on the upper surface; by a few of the most anterior rays of the dorsal fin being elongated beyond the membrane; and by the colouring, which is reddish sandy-brown on the upper side, varied with darker brown and sprinkled with white pearly spots, the under side being (as in the turbot) white. The B. is taken both in sandy bays and in deep water. Although considered very inferior to the turbot, it is yet much esteemed for the table. It seldom or never attains so great a size as the turbot, rarely exceeding 8 lbs. in weight.

BRILLIANT is a popular name given to the diamond when it is cut in a particular way. See **DIAMOND**.

BRIMSTONE (Saxon, *Brenne-stone*, a stone that burns) is the vulgar name for sulphur (q. v.).

BRINDISI (the ancient *Brundisium* or *Brun-dusium*), a seaport town of Naples, in the province of Terra di Otranto, is situated on a small promontory in a bay of the Adriatic Sea, about 45 miles east-north-east of Taranto. B. is a city of very great antiquity. It was taken from the Salentines by the Romans 267 B. C., who some twenty years

later established a colony here. The town, partly owing to the fertility of the country, but chiefly on account of its excellent port—consisting of an inner and outer harbour, the former perfectly landlocked, and capable of containing the largest fleets and of easy defence on account of its narrow entrance, and the latter also very well sheltered—rapidly increased in wealth and importance. It soon became the principal naval station of the Romans in the Adriatic. In 230 B. C., B. was the starting-place of the Roman troops that took part in the first Illyrian War; and from this point the Romans nearly always directed subsequent wars with Macedonia, Greece, and Asia. And when the Roman power had been firmly established beyond the Adriatic, B. became a city second to none of South Italy in commercial importance. Horace, who accompanied Antony in a hostile movement on B., in 41 B. C., has made the journey the subject of one of his satires (*Sat.* i. 5). Virgil died here, in 19 B. C., on his return from Greece. The city appears to have retained its importance until the fall of the empire, but it suffered greatly in the wars which followed. When the Normans became possessed of it in the 11th c., the Crusaders made it their chief port for embarkation to the Holy Land; but with the decline of the crusades, B. sank into comparative insignificance as a naval station. The city subsequently suffered greatly from wars and earthquakes. Now its glory is utterly gone. It is a miserable, unhealthy place, with only about 6000 or 7000 inhabitants, hardly more than a tenth of what it had in the 12th c.; its fine inner harbour is choked up with sand; and it has even few remains of interest. The principal buildings are the cathedral, where the Emperor Frederick II. was married to Yolanda in 1225; and the castle, commenced by Frederick II., and finished by Charles V. The district around B. is still remarkable for its fertility, olive-oil being produced in large quantities. The Malta steamers have within recent years begun to call at B., on their way to Corfu and Patras, a royal decree having constituted the place an entrepôt for foreign goods.

BRINDLEY, JAMES, an eminent English mechanic and engineer, born in Thornsett, near Chapel-en-le-Frith, Derbyshire, in 1716. Apprenticed at 17 to a millwright, he afterwards became an engineer, and in 1752 shewed great ingenuity in contriving a water-engine for draining a coal-mine. A silk-mill on a new plan, and several others of his works, recommended him to the Duke of Bridgewater (q. v.), who employed him to execute the canal between Worsley and Manchester. Thenceforth he devoted his great skill and genius to the construction of navigable canals; commenced the Grand Trunk, and completed the Birmingham, Chesterfield, and others. Once, when under examination before a committee of the House of Commons, being jocularly asked for what purpose he supposed rivers to have been created, he is said to have replied: 'Undoubtedly to feed navigable canals.' He died in 1772.

BRINE is the term applied to water highly impregnated with common salt, and **BRINE SPRINGS** are those natural waters containing much salt, which in many parts of the world gush out from fissures in the ground. See **SALT**.

BRINE-SHRIMP (*Artemia salina*), a small crustacean, of the order *Branchiopoda* (q. v.), which, unlike the greater number of animals of that order, is an inhabitant not of fresh but of salt water, and is indeed remarkable, because it is to be found in myriads swimming about in the brine of salt-pans previous to boiling, when, having been concentrated

by exposure to sun and air for about a fortnight, it destroys the life of almost all other marine animals.

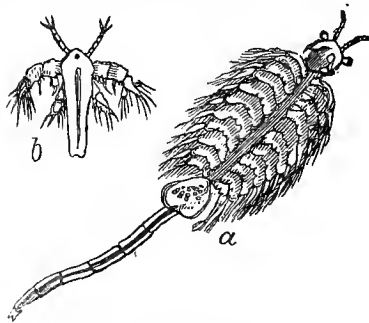

Brine Shrimp:
a, mature; b, young.

The full-grown B. is about half an inch long. The little animal is almost transparent, and is extremely active and graceful in its movements. The workmen at salt-pans so confidently ascribe to it the rapid clearing of the brine in which it occurs, that when it does not appear in their *salterns*, they transport a few from other salterns. They multiply with extraordinary rapidity.

BRINJAREE DOG, a rough-haired or long-haired variety of greyhound (q. v.), used in the Deccan, and said to be the best of the hunting-dogs of India. It is said to be superior in size and strength to the Persian greyhound, but not to be equal to the British greyhound in swiftness. It is generally of a yellowish or tan colour.

BRINVILLIERS, MARIE MARGUERITE, MARQUISE DE, notorious as a poisoner in the time of Louis XIV., was the daughter of Dreux d'Aubray, Lieutenant of Paris, and received a careful education. In 1651 she was married, while still young, to the Marquis de Brinvilliers. This nobleman seems to have been a gay and careless spendthrift, who allowed his wife to do very much as she pleased. He even introduced to her a young officer named Jean Baptiste de Gaudin, Seigneur de St Croix, who was exceedingly handsome, and who inspired her with a violent passion. Her easy husband, however, was wholly indifferent to his wife's conduct; but her father, who seems to have had a stricter sense of duty, caused St Croix to be arrested and imprisoned in the Bastille. It was here the latter learned the art of preparing poisons, from an Italian, and on his release he imparted his fatal knowledge to his mistress, who, during his incarceration, had affected the greatest piety, spending most of her time in visiting the hospitals and in attending the sick. The marchioness now resolved to destroy her father. St Croix eagerly abetted her, in the hope of obtaining a portion of the paternal inheritance; but in order to test the efficacy of the poison, she tried its effects upon the invalids of the *Hôtel Dieu*. Having satisfied herself, she commenced operations on her parent, kissing and poisoning him continually for eight months, until her diabolical patience was exhausted, and she was at last induced to administer a very violent dose. He died, and no one suspected the marchioness. With St Croix's assistance, and that of a domestic servant, Jean Amelin, *alias* Chaussée, she next poisoned, with the same fearful indifference to crime, her two brothers and her sisters; her object being to find means of supporting her extravagant style of living with her paramour. Several times she attempted to poison the marquis, her

husband; but he escaped, and, as was said, by means of antidotes given by St Croix, who dreaded that he should be compelled to marry the widow. St Croix died suddenly in 1672—his glass mask having fallen off while he was engaged in preparing a poison—leaving documents inculcating the marchioness. She was also accused about the same time by her accomplice Chaussée, who being arrested, confessed all, and was condemned to be broken alive. The marchioness escaped to England; afterwards she travelled into Germany, and next went to Liege, where she took refuge in a convent. From this, however, she was craftily decoyed by an officer of justice disguised as an abbé, and conveyed to Paris. Among her papers was found a general confession of her crimes, including the above-mentioned murders, and many others. One strange confession stated that, out of pity for a virtuous young lady who had been imprisoned in a convent, the marchioness had poisoned a whole family! It is a singular fact, that this infamous woman was a bigot in her religious tenets, and was quite exemplary in her attendance at church. At her trial in Paris, she at first denied all charges brought against her, and pretended that the 'general confession' had been written during the insanity caused by a fever; but after being put to the torture, she made a full confession, and was beheaded, July 16, 1676. Her career had excited such terror in France, that Louis XIV. instituted a distinct tribunal, the *Chambre Ardente* (q. v.), to investigate cases of poisoning by the 'succession powder' used by the marchioness.

BRIOUDE, a town of France, in the department of Haute-Loire, situated near the left bank of the river Allier, about 29 miles north-west of Le Puy. It occupies the site of *Briovos*, a town of the ancient Averni. Its principal buildings are the college and the church of St Julien, founded in the 9th c., on the site of a still more ancient edifice erected on the spot where the saint was martyred. B. has manufactures of linen and woollen, and a trade in the agricultural produce of the district. Lafayette was born here. Pop. 4670.

BRISBANE, a name applied to various localities in New South Wales in honour of Governor Brisbane (q. v.). 1. B., an inland county, about 120 miles to the north-north-west of Sydney. 2. B., a seaport, about 640 miles to the north of Sydney. It is the chief town of the Moreton Bay District, now erected into a separate colony under the name of Queensland; and it is by various routes from this place that the neighbouring interior is most easily attained. It stands near the mouth of a river of its own name, which falls into Moreton Bay. 3. B., the river just mentioned. It rises in the main ridge which divides the rivers of the interior from those of the coast.

BRISBANE, GENERAL SIR THOMAS MACKDOUGAL, a distinguished soldier and astronomer, was born at Brisbane, the hereditary seat of his family, near Largs, Ayrshire, July 23, 1773. At the early age of 16 he entered the army as an ensign, and in the following year, when quartered in Ireland, he formed an intimate acquaintance with Arthur Wellesley, afterwards Duke of Wellington. With a company he had raised in Glasgow in 1793, B. took part in all the engagements of the campaign in Flanders; and in the West Indies, to which he was sent in 1796, he greatly distinguished himself under Sir Ralph Abercromby. He afterwards served in the West Indies as colonel of the 69th; and in 1812 obtained command of a brigade under the Duke of Wellington in Spain. For his conspicuous bravery at the battle of the Nive he received the thanks of parliament. When Napoleon abdicated, B. was sent

in command of a brigade to North America, from whence he was recalled in 1815, but too late to admit of his being present at Waterloo. In 1821, B., on the recommendation of his friend the Duke, was appointed governor of New South Wales, a position he held for four years, during which time he introduced many wise reforms, especially in penal treatment; secured at his own expense good breeds of horses for the colony; promoted the cultivation of the sugar-cane, vine, tobacco, and cotton; and left at the close of his administration—which was marked by perfect tolerance and protection of all classes of Christians—50,000 acres of cleared land where he had found only 25,000. But high as B. ranks as a soldier and administrator, as a man of science he holds a still higher place. While in Australia, he catalogued no less than 7385 stars, for which great work—known as 'the Brisbane Catalogue of Stars'—he received the Copley medal from the Royal Society. On his return to Scotland, he had an astronomical observatory established at his residence at Makerstoun, and devoted himself entirely to scientific pursuits. He entered warmly into the plans of the British Association for ascertaining the laws of the earth's magnetism, and in 1841 had a splendid magnetic observatory erected at Makerstoun, the observations made there filling three large volumes, published in the *Transactions of the Royal Society of Edinburgh*, of which he was president, having been elected on the death of Sir Walter Scott. He founded two gold medals for scientific merit—one in the award of the Royal Society, the other in that of the Society of Arts. He died January 27, 1860.

BRISSET, JEAN PIERRE, one of the first movers in the outbreak of the French Revolution, and afterwards numbered among its victims, was born at Chartres in 1754, and educated for the bar. After completing his studies at Paris, he went into the office of a procurator, but quickly abandoned the legal profession for the more congenial one of authorship. From his earliest years he had devoted himself with passionate eagerness to literary studies, especially history, economy, and politics, and, among other lingual accomplishments, acquired a thorough mastery of English. His first work, *Théorie des Lois Criminelles* (1780), gained the approbation of Voltaire and D'Alembert, and was followed by his *Bibliothèque des Lois Criminelles*, which established his reputation as a jurist. Having removed to London, he there started a learned journal, under the title *Lyceum*, for which, however, he found no adequate support. He therefore returned to Paris, and soon afterwards was imprisoned in the Bastille, on a charge of having written against the queen a brochure, which, in fact, was penned by the Marquis de Pelleport. After four months in the Bastille, he was liberated through the intervention of Madame de Genlis and the Duke of Orleans. B. continued to write tracts on finance, &c., but his love of freedom and vehement hatred of despotism again involved him in danger, and, to escape from a *lettre-de-cachet*, he was once more compelled to retire to England. He afterwards visited North America, as representative of the *Société des Amis des Noirs*. On his return to France, he zealously assisted in the outbreak of the Revolution, and was in consequence elected by the citizens of Paris their representative in the Constituent Assembly, where he exercised a predominant influence over all the early movements of the Revolution. He also established a journal, called *Le Patriote Français*, which became the recognised organ of the earliest republicans; and, through his superior knowledge of politics, and the usages of constitutional countries, he gathered

round him all the young men of talent and spirit who were opposed to the court-theory of absolute sovereignty. It thus happened that, without his being formally considered the head of a party, all the movements of the early revolutionists were profoundly influenced by him, and he incurred the bitter hatred of the court reactionists, who affixed the nickname of Brissotins to all the advocates of reform. Afterwards, the Brissotins formed the Girondist party. In the Convention, B. was representative of the department of Eure-et-Loir. Here his moderation made him suspected as a friend of royalty, as he opposed the 'men of September' and the trial and condemnation of the king. When Louis XVI. heard his doom pronounced, he exclaimed: 'I believed that Brissot would have saved me!' But B. was weak enough to imagine that the best way to save the king would be to vote first for his death, and then appeal to the nation. B. and his party, which was perhaps the purest in principle and the weakest in action, ultimately fell before the fierce accusations of the Mountain, or Jacobin party, which believed, or at least pretended to believe, that the virtuous B. had received money from the court to employ against the Revolution. With 20 other Girondists, B. suffered death under the guillotine, October 30, 1793.

BRISTLES, the strong hairs growing on the back of the hog and wild-boar, and extensively used in the manufacture of brushes, and also by shoemakers and saddlers. They form an important article of British import, between 2 and 3 million pounds being annually imported, chiefly from Russia and Germany; but they are also obtained from France and Belgium, and small quantities of inferior quality have recently been received from China. From Russia, the average annual value of B. imported into Britain is £350,000, Siberia alone supplying about £150,000. Russian B. vary in value from £6 to £60 per cwt. From Germany, about £100,000 worth per annum is received, varying from £6 per cwt. to £35 per cwt. From France and Belgium, about £20,000, varying in value from 2s. to about 4s. 6d. per pound. The quality of B. depends on the length, stiffness, colour, and straightness—white being the most valuable. The best bristles are produced by pigs that inhabit cold countries. The Russian hog is a long, spare animal, and the thinner the hog, the longer and stiffer the bristles. When the Russian hog is sent to the south and fattened, the B. become soft, and of course depreciated in value. In the summer, the hogs are driven in herds through the forests, to feed on soft roots, &c., when they shed their B. by rubbing themselves against the trees. The B. are then collected, sewed up in horse or ox hides, and sent to fairs, whence they find their way, through agents, to all countries.

BRISTOL, an important maritime city in the west of England, long, 2° 35' 28" W., lat. 51° 27' 6" N., upon the rivers Frome and Avon, and partly in the counties of Gloucester and Somerset, joined with the former for ecclesiastical and military purposes, but otherwise a city and county in itself. The ancient portion of B. consists almost entirely of shops, warehouses, offices, manufactories, and other commercial buildings, of the estimated annual value of £258,228, which, at twenty years' purchase, gives £5,164,560 as the value of the old city parishes. The streets are, with few exceptions, narrow and irregular; but there are, nevertheless, many handsome shops, and other buildings of a superior character. Among the latter, may be especially mentioned the new banking-house of the West of England Company, the Guild Hall, Bank of England, New General Hospital, and Railway termin.

Among the ancient buildings are the Church of St Mary Redcliffe, the Cathedral, and Temple Church, remarkable for its leaning tower. Some remains still exist of the ancient castle and walls, traces of Roman encampments at Clifton and Leigh, and Druidic vestiges at Stoke and Stanton Drew. The modern portions of B., including Clifton, Cotham, &c., consist of handsome residences, in squares, terraces, crescents, and detached villas, and some creditable specimens of architecture in churches, chapels, assembly and club rooms. The population of B. proper was, in 1851, 65,781, and of the suburban districts, 116,094—total, 181,875, steadily increasing; total included in the municipal boundary, 137,328. The floating harbour and quays extend for more than a mile through the city, and are formed by embanking and locking the old courses of the rivers, which now flow through a new channel cut at a cost of about £600,000. There were entered inwards with cargoes during the year 1859, 790 vessels, with a tonnage of 202,620, engaged in the foreign, and 6615, of 477,410 tons, in the coasting trade, making a total of 7405 vessels, and 680,030 tons. The clearances outwards with cargoes for the same year shew 4921 vessels and 441,396 tons. The customs duties on imports produced £1,283,549. The chief trade is with Canada and the United States, West Indies and South America, Portugal, the Mediterranean, Russia, Mauritius, Turkey, France, and west coast of Africa. The principal exports are iron, copper and brass, coal, salt, and manufactured goods, to the annual value of about £500,000. The manufactures are chiefly cotton and woollen goods, glass, refined sugar, earthenware, lead, chemicals, and floor-cloths. The ship-building yards have the reputation of turning out excellent sea-going vessels. The *Great Western*, the pioneer of steam-communication across the Atlantic, the *Great Britain*, and the ill-fated *Demerara* were built here. The railways terminating in Bristol are, the Great Western from the east, the Midland from the north, and the Bristol and Exeter from the south and west. Another railway is in course of construction, for giving direct communication with South Wales. B. returns two members to the House of Commons; the number of registered electors is 12,548. The municipal government is vested in a mayor, 16 aldermen, and 48 town-councillors, a lord-lieutenant and lord high steward. A recorder attends the quarter-sessions, for the trial of minor offences and suits in the Tolzey, a peculiar local court; and assizes are held twice a year, for causes in the superior courts. The police arrangements are tolerably efficient, and the city jail well constructed and managed. It contains a church built in the prison-yard by the unaided labour of the convicts. The benevolent institutions of B. are numerous and well supported. The most important are the Infirmary, the New Hospital, the Blind Asylum, Orphan Asylum, Asylum for Deaf Mutes, alms-houses, reformatories, &c., and the extraordinary Ashley Hill Asylum for Orphans, built and maintained without any provision for meeting expenses, except the unsolicited contributions that happen to be sent to it, while admission is never refused to a destitute orphan child. Among charitable institutions must also be reckoned the well endowed Colston, City, and Red Maids Schools, and numberless other free schools. For the better classes, the educational establishments are—the Bishop's College and the grammar school, and many proprietary and private schools; there are also a medical school, fine arts academy, and trade school. Of places of worship in B., 44 belong to the Church of England, 25 to Wesleyan communities, 20 to Independents, and about 36 to other sects. Tho

first records of the history of B. speak of it under the ancient British name of *Caer-oder*; it then became a stronghold of the Romans; on their departure, was again occupied by the Britons, until, in 584, the Saxons drove them out, and giving it the name of *Brightstowe* or *Bricstowe*, made it a thriving place of trade—aboriginal slaves being a principal item in the commerce. It was sacked by the Danes. Henry III. gave it the rights of a corporate town; Edward III., those of a city and county in itself. In 1239, the new channel for the Avon was cut; in 1247, the parishes of Redcliffe, Temple, and St Thomas were added to Bristol. During the Civil Wars, it was alternately taken by Royalists and Parliamentarians, and by the latter, the castle and fortifications were razed. It afterwards became the principal port for trade with the West Indies, and carried on a flourishing business in negro slaves. In 1793, the 'Bridge Riots' occurred. In 1804 the Docks were begun, and in 1809 they were opened to shipping. In 1831, the 'Reform Bill Riots' resulted in the destruction of the Bishop's Palace, Custom-house, Excise-office, jail, toll-houses, a large number of private residences, and several hundred lives. The Bill itself, by the addition of Clifton, &c., gave the city its present municipal boundaries. Among the names of note identified with the history of B. are those of the Fitzhardinge family; William of Worcester; Canynge, the great merchant and restorer of Redcliffe Church; Colston and Whitson, the merchants and philanthropists; Sebastian Cabot, the navigator, said to have anticipated the discovery of America by Columbus; the poets Southey and Chatterton; Lawrence and Baily, artists; Sydney Smith, canon of Bristol Cathedral; Robert Hall, Coleridge, and Hannah More; the Misses Porter; Dr Pritchard, Dr Carpenter, and Miss Mary Carpenter.

BRISTOL BAY, an arm of the Pacific Ocean, in Russian America, lying immediately to the north of the peninsula of Alaska. B. B. receives the waters of two considerable lakes, which, communicating with each other, offer an opening into the interior.

BRISTOL CHANNEL, an inlet of the Atlantic Ocean, in the south-west of England, between South Wales on the north, and Devon and Somerset shires on the south; or it may be regarded as an extension of the estuary of the river Severn. It is about 80 miles long and 5 to 48 miles broad, the greatest breadth being between St Gowan's Head and Hartland Point, its most western and external points, this line passing through Lundy Isle. It is the largest inlet or estuary in Britain, having a very irregular coast-line of 220 miles, and receiving a drainage of 11,000 square miles. The chief rivers which flow into it are the Towy, Taff, Usk, Severn, Avon, Axe, Parrot, Taw, and Torridge. The tides in it rise to an extraordinary height—at Bristol, 40 feet; at King's Road, 48; and at Chepstow, sometimes 70. The rapid flow of the tides meeting the currents of the rivers produces, in the narrow parts of the Channel and in the mouths of the rivers which enter it, the phenomenon of the *bore*, the tide advancing like a wall of water often 6 to 9 feet high. The chief bays and harbours are, on the north Caermarthen and Swansea Bays, Cardiff Roads, the mouths of the Usk and Wye, and the Severn estuary; and on the south, Bideford or Barnstaple, Morte, Ilfracombe, Combe Martin, Minehead, Porlock, and Bridgewater.

BRITAIN, GREAT. See **GREAT BRITAIN.**

BRITAIN, NEW. See **NEW BRITAIN.**

BRITANNIA (perhaps from Celtic *brith* or *brít*, painted, the ancient Britons being in the habit of

painting their bodies blue with woad), the ancient name of the island of Great Britain (see **BRITANNICÆ INSULÆ**). The Romans under Julius Cæsar (who wished to chastise the Britons for aiding the Veneti, a tribe in Gaul, against the Roman power) invaded Britain in 55 and 54 B. C., but they did not, for a hundred years afterwards, proceed with vigour to subdue the country. After a desperate resistance by the native British princes, especially Caractacus and Boadicea, the south half of Britain was conquered by Vespasian, and made a Roman province in the reign of Claudius, about 50 A. D. Agricola, sent by Nero in 79 A. D., consolidated these conquests, and extended the influence of Rome to the Firths of Forth and Clyde, between which, in 84 A. D., he erected a chain of forts to repel the inroads of the northern Caledonians, in the line of the stone Wall of Antoninus, afterwards erected, in 140 A. D., by Lollius Urbicus. Agricola was the first Roman to sail round the island, and the first Roman general to come in contact with the Caledonians, whom, under their leader Galgacus, he overthrew, in 84 A. D., at a hill called the Mons Grampius, the situation of which has not been satisfactorily determined. The Romans made many ineffectual attempts to subdue the Caledonian barbarians, and penetrated, for this purpose, through the north-east part of Scotland as far as the Moray Firth, as is attested by the remains of Roman camps and stations still existing along their line of march, and the relics of Roman art found in connection with them. Not only did the Caledonians on their own soil resist the Roman sway, but by constant inroads into the Roman territory south of the Wall of Antoninus, they so harassed the Romans themselves, that the latter were forced to abandon their conquests for 80 miles south of that wall, and to secure permanently their remaining conquests in South Britain by a line of defensive works between the mouth of the Tyne and the Solway Firth, called the Wall of Hadrian (q. v.), begun by Agricola in 80 A. D., strengthened by Hadrian in 121, and rebuilt and completed by Severus in 210 A. D. After this last date the Romans did not attempt to regain their lost provinces. Subject to these incursions of the Caledonians, the opposition of the native British princes, and the invasion of tribes from the opposite shores of the continent, the Romans held sway in Britain down to about 420 A. D., soon after which time the Saxons invaded south Britain, and ultimately subdued it. Britain, south of the Solway Firth and the mouth of the Tyne, in the reign of Claudius, formed one Roman province under a consular legatus and a procurator. Ptolemy mentions 17 native tribes as inhabiting this tract. Toward the close of the 4th c. A. D. Roman Britain constituted a diocese in the præfecture of Gaul, and was divided into five provinces, of which the boundaries, though uncertain, are supposed to have been as follows: B. Prima, England south of the Thames and the Bristol Channel; B. Secunda, Wales; Flavia Cæsariensis, the country between the Thames, Severn, Mersey, and Humber; Maxima Cæsariensis, the rest of England to the Scottish border; and Valentinia—soon abandoned by the Romans—or Scotland south of the Wall of Antoninus. At this time, also, the inhabitants of Roman Britain included Phœnician, Roman, and Germanic elements, which had become incorporated with the native Britons, who were of Celtic or Gaelic descent. The Romans governed Britain by a vicarius or vicegerent resident at Eboracum (York), under whom were consulars, presidents, and other subordinate officers. To insure the obedience of the natives, at least three Roman legions—chiefly composed of Gauls, Germans,

Iberians, and but few pure Romans—were stationed in Britain; viz., at Eboracum, Deva (Chester), and Isca Damnoniorum (Exeter). Under the Romans, many towns (coloniae and municipia)—56 are enumerated by Ptolemy—arose in Britain, and diffused Roman law and civilisation over the country. The towns of Eboracum (York) and Verulamium (near St Albans) had the privileges of Roman citizenship. The Romans made many roads or streets (*strata*), of which there are still numerous remains, across the country, all centering in London. They also developed it into a corn-growing country. Druidism was the religion of the Britons at their conquest by the Romans, but the latter introduced Christianity and Roman literature into the country. There are many remains still extant of the presence of the Romans in Britain, such as camps, roads, ruins of houses, baths, flues, altars, mosaic pavements, painted walls, metallic implements and ornaments, weapons, tools, utensils, pottery, coins, sculptures, bronzes, inscriptions, &c. These remains shew that the Romans wished to render their British conquests permanent, and that they had greatly improved the arts of the ancient Britons, as is evident on comparing the remains with the far ruder native antiquities of the British pre-Roman or pre-historic era, such as tumuli, barrows, earthworks, so-called Druidical monoliths and circles, cromlechs, cairns, pottery, weapons, tools, utensils, ornaments, &c. Many of the Roman remains in Britain also shew that the Romans had introduced into the country the refinements and luxuries of Rome itself.



Under the term **BRITANNIA**, Great Britain has been personified in the fine arts as a female seated

on a globe or on an insulated rock, and leaning with one arm on a shield, the other hand grasping a spear or a trident. The first example of this personification is on a Roman coin of Antoninus Pius (died 161 A. D.). The figure reappears first on the copper coinage of England in the reign of Charles II. (1665); the celebrated beauty, Miss Stewart, afterwards Duchess of Richmond, is said to have served as model to the engraver, Philip Roetier. The Britannia that appears on the reverse of British copper coins since 1825 was the design of Mr W. Wyon. See **COINAGE**.

BRITANNIA METAL is an alloy very largely employed in the construction of the cheaper kinds of tea and coffee pots, tea-spoons, &c. The proportions of the metals used in its manufacture are various, but the average composition in 100 parts is: tin, 85½; antimony, 10½; zinc, 3; and copper, 1. B. M. is harder than pewter (q. v.), hence vessels or spoons made of it are not so liable to lose their shape, or to be indented with a slight blow. A variety of B. M., called *Queen's Metal*, is also extensively used for similar purposes, and it ranks intermediate in hardness between pewter and ordinary B. Metal. Queen's Metal is composed of—tin, 9; antimony, 1; bismuth, 1; and lead, 1.

BRITANNIA TUBULAR BRIDGE, a railway bridge over the Menai Strait, remarkable alike for its gigantic dimensions, and as being the first construction of the kind ever undertaken. With a view to facilitate communication with Ireland *via* Holyhead, the directors of the Chester and Holyhead Railway in 1845 sought the aid of Mr Robert Stephenson, the great engineer, to bridge the strait with such a structure as should admit of the safe passage of heavily laden trains without in any way interfering with the navigation of the channel. About a mile above the suspension-bridge, and nearer Carnarvon, a rock in the middle of the strait rose ten feet above the water at low tide; and on this site, provided by nature, it was resolved to erect the bridge in the form of a rectangular tube, composed of wrought-iron plates riveted together in a manner to combine the greatest strength with the greatest lightness. See **STRENGTH OF MATERIALS** and **TUBULAR BRIDGES**. In the spring of 1846, the undertaking was commenced;

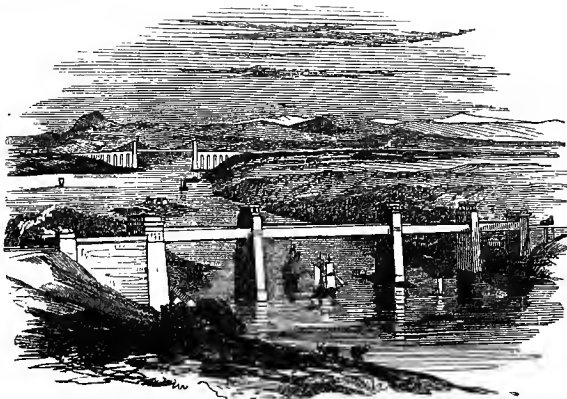

Britannia Tubular Bridge.

by the 22d of June 1849, the Britannia Tower on the rock in the centre of the strait was completed (height, 191 feet 6 inches above high-water mark). Other two towers, some 18 feet lower, were

erected on each side of the Britannia Tower; thus dividing the space into four spans, of which the two centre ones are 460 feet each, the other two being comparatively narrow. The short tubes

between the abutments and the shore towers were constructed, by means of strong scaffolding and stages, in the places they were to occupy when finished; the long central tubes were built at the water-edge, from whence they were floated off on pontoons to the base of the towers, which had grooves or recesses made to receive them, and then elevated gradually (supports being built under their ends as they ascended) by powerful hydraulic presses to the requisite height, 102 feet above high-water mark. On the 13th of October 1849, the first long tube, 472 feet in length (12 feet being allowed for the rest at both ends), and about 1800 tons in weight, was safely fixed at its proper height above the sea. The other centre tube was got up by December; and on the 5th of March 1850, a train swept through, and the bridge was open for traffic. In August the parallel line of tubes was completed, and the up and down trains could now pass over the Menai with as little delay and danger as over any other part of the line. The total length of the bridge is 1841 feet, of the tubes, 1513 feet. The extreme height of the tube at the Britannia Tower is 30 feet, diminishing to 22 feet 9 inches at the abutments, 'the difference being made to give a true parabolic curve to the top while the bottom is straight.' Inside, the width is 13 feet 8 inches throughout, and the height 26 feet at the middle, and 18 feet 9 inches at the ends. To provide for the expansion and contraction of the metal, the bed-plates in the shore towers and in the abutments, on which the tubes rest, are made to move freely on cast-iron rollers and balls. This precaution, for securing free movement to the tubes, was not unnecessary, as it has been found that between the expansion of summer and contraction of winter there is a difference of fully 12 inches. The total weight of iron used was nearly 12,000 tons, of which the tubes contain 9360 tons of malleable iron, 1015 tons of cast iron, and 175 of permanent railway. In their fabrication 186,000 different pieces of iron, fastened together by more than 2,000,000 rivets, were used; and in the towers, abutments, &c., there is 1,492,151 cubic feet of masonry. The total cost was about £602,000. The whole structure was completed in less than five years from its commencement.

BRITANNICÆ INSULÆ, a term used by ancient classic writers previous to Cæsar for the British Isles, including Albion (England and Scotland), and Hibernia or Ierne (Ireland), with the smaller isles around them. Aristotle, in the beginning of the 3d c. B. C., knew only of Albion and Ierne. Cæsar, about 54 B. C., was the first to apply the name Britannia to Albion. Ptolemy, in the 2d c. A. D., is the first to apply Little Britain to Ierne or Ireland, and Great Britain to Albion or England and Scotland. Herodotus, in the 5th c. B. C., is the first writer to mention Britain with any sort of definiteness; previous Greek writers speak of Britain only in connection with the Phœnician tin trade carried on with the Cassiterides or Tin Isles (the Scilly Isles and Cornwall), which they often confound with the Azores. The Phœnician trade with the British Isles began about 1000 B. C., the Phœnicians giving the native Britons salt, skins, and bronze vessels in exchange for tin and lead. Ptolemy enumerates 52 different Celtic or Gaelic tribes as inhabiting Britain in his time. See **CELTIC NATIONS**.

BRITISH ARMY. In **ARMIES, MODERN**, a succinct account is given of the relative strength and organisation of the chief European armies, with the exception of that of the British empire, reserved for consideration in the present article.

Like other modern armies, the British army originated in the feudal system (q. v.). When

regal power, tempered by a parliament, superseded that system, the people, according to their rank in life, were expected to provide themselves with certain kinds of weapons and defensive armour. The justices of the peace were empowered to see to these military duties of the people. When the nation was either actually engaged in war, or apprehensive of invasion, the sovereign issued commissions to experienced officers, authorising them to draw out and array the fittest men for service in each county, and to march them to the sea-coast, or to any part of the country known to be in most danger. See **ARRAYER**. It was in the time of Henry VIII. that lord-lieutenants and deputy-lieutenants of counties were first appointed as standing-officers for assembling and mustering the military force. During the earlier years of the Tudors, contracts were made by the king with 'captains,' who undertook to provide, clothe, and feed so many fighting-men, for a given money-allowance; but the power intrusted to the lord-lieutenants gradually changed this system, in relation at least to home-defence. In the reign of Charles I., the important question arose, whether the king of England did or did not possess the right to maintain a military force without the express consent of parliament? and this question was all the more bitterly discussed when the king billeted his soldiers on the people. After the troubles of the civil wars and the Commonwealth, Charles II. found himself compelled to agree, on his Restoration, to the abandonment of all the army except a kind of body-guard or household brigade of 5000 men, sanctioned by the parliament. In the 13th year of his reign, he succeeded in obtaining a statute, declaratory that 'the sole and supreme power, government, command, and disposition of the militia, and of all forces by sea and land, and of all forts and places of strength, is the undoubted right of his majesty; and both or either of the Houses of Parliament cannot nor ought to pretend to the same.' Both Charles II. and James II. found, however, to their mortification, that this statute did not in effect give them so much real military command as they had wished and intended—because the Commons, by holding the purse, virtually held the power.

It was in the time of William and Mary that the real basis for the modern B. A. was laid. The **DECLARATION OF RIGHTS** (q. v.) settled, in positive terms, 'that the raising and keeping of a standing army in time of peace, without consent of parliament, is contrary to law.' The first **MUTINY ACT** (q. v.) was passed in 1689, to last for six months only; but it has been annually renewed ever since, except in three particular years; and it constitutes the warrant on which the whole military system of England is exercised by the Sovereign, with the consent of parliament. During a period of 172 years, with only three interruptions, the ministers of the crown have annually applied to parliament for permission to raise a military force, and for money to defray the expenses. The Sovereign can make war, and can bestow military employments and honours; but the steadiness with which the Commons have always regarded themselves as the representatives of the tax-paying nation has, in however imperfect a degree, provided a check, even in the worst of times, on the grasping by courtiers of lavish military privileges.

The great distinction between the B. A. and that of almost every other state in Europe, is that the service is *voluntary*. The subjects of the crown engage, by free choice, to serve in the army for a definite number of years. In the rare cases where forced service by ballot is obtained, it is in the militia, not the regular army. See **MILITIA**. The British soldier has much hard colonial life to bear,

BRITISH ARMY—BRITISH ASSOCIATION.

and many long voyages to make; he is, moreover, almost entirely shut out from the chance of being a commissioned officer. As a consequence, the ranks are mostly filled from the more necessitous classes of the community—by those who from want of steady habits, or of education, are the least fitted for industrious pursuits; whereas in France and many other foreign countries, the profession of arms is regarded as an honourable one, of which even the private soldier feels proud. Mr Foublanque, comparing the peace establishments of the chief European armies in 1857, found that of England to be the smallest in ratio to population, but the most costly in relation to its strength. The English ratio was 1 in 128; the French, 1 in 95; the Prussian, 1 in 80; the Russian, 1 in 72; the Austrian, 1 in 68. English soldiers, officers, and men together, cost the country £52 each per annum; French, £36; Prussian, £31; Austrian, £18, 10s.; Russian, £13, 5s. The English cost per man is still higher in 1860 than it was in 1857, on account of increased attention being paid to the wellbeing of the soldier.

The B. A., in all its completeness, is supposed to be commanded by the Sovereign, assisted by the Secretary of State for War in some matters, and by the Commander-in-chief in others. The component elements are the household troops; the infantry of the line; the cavalry of the line; the ordnance corps, comprising artillery and engineers; and the marines. There are also certain corps raised in and belonging to the principal colonies; other bodies of troops, maintained out of the revenues of India; the militia; the yeomanry cavalry; the dockyard battalions; the volunteer artillery and rifles; the enrolled pensioners; and sometimes during war, foreign legions. The 'peace establishment' of the B. A. varies according to the political aspect of affairs abroad, and to the strength of the economising principle at home. In 1814, when England was engaged in tremendous contests abroad, the regular army reached 200,000 men, exclusive of fencibles, foreign legions, and militia. In the first few years after the termination of the great war against Napoleon, the reductions in the B. A. involved the compulsory retirement of no less than 10,000 military officers, who thereupon went on half-pay; these, by filling vacancies, transfers, and deaths, have been reduced by the year 1860 to about 2000. The elasticity which permits the enlargement or contraction of the army, arises from varying, not so much the number of regiments, as the number of battalions in a regiment, of companies in a battalion, or of men in a company. If we compare the strength of the regular army at various periods between 1820 and 1860, we shall find that the actual number of regiments has varied but little, the difference of strength being made up in the three modes just mentioned.

The strength of the B. A. declined from 1815 to 1835, since which last-mentioned year it has undergone many augmentations. These augmentations have been occasioned partly by the contests in China, India, Kaffraria, Persia, and the Crimea; and partly by a sense of the insecurity of many of our coasts and colonies. In comparing the strength of the forces at different periods, much confusion is apt to arise from different modes of interpreting the words 'British army.' This designation may include the whole of the royal troops in India, whether supported out of imperial or of Indian revenues; it may include the militia, the volunteers, the enrolled pensioners, the yeomanry cavalry, the foreign legions—or it may exclude any one or more of these. The 'British army,' and the 'military force of the British empire,' are often treated as convertible terms; to the production of much confusion where actual

numbers are given. Having, in ARMY ESTIMATES, noticed the number of men and the estimated cost for 1859—1860, we shall here, selecting the official year 1860—1861, shew of what component elements the B. A. now consists. The militia and the volunteer corps are not here included.

BRITISH ARMY VOTED FOR 1860—1861.

	Home and Colonies.	India.	Total British Army.
Cavalry,	11,667	7,243	= 18,910
Infantry,	103,169	66,345	= 169,514
Artillery,	22,675	5,482	= 28,157
Engineers,	4,730	...	= 4,730
Staff and Depots,	1,121	13,420	= 14,541
	143,362	92,490	= 235,852

Under the column 'India,' are only included those troops of the royal army which are *lent* to India, and paid for out of Indian revenues; the other military forces in that region are enumerated under EAST INDIA ARMY. Of the total 235,852 forming her Majesty's forces, 10,459 are officers, 17,670 non-commissioned officers, and 207,723 rank and file. There are voted for the use of this army 24,342 horses. A 'supplementary vote' has slightly added to the above numbers. The total cost cannot well be estimated per head; because, besides pay and sustenance for the soldiers, there are stores and wages for fortifications and military buildings, military weapons and combustibles, and the various kinds of half-pay and pensions. The total expenditure sanctioned by parliament may, however, conveniently be thrown under four headings, and given in round numbers as follows:

Military Pay and Allowances,	£5,500,000
Civil Salaries and Wages,	1,800,000
Stores and Works of every kind,	5,400,000
Pensions, retired Pay, &c.,	2,100,000
	£14,800,000

—the largest sum ever voted for a *peace* establishment.

All the component elements of the army, in *personnel* and *matériel*, and the organisation and duties of the troops, will be found noticed under their proper headings. A parliamentary paper supplies the information that, on the 1st of June 1860, the military forces actually within the United Kingdom—including all the various kinds of force, but excluding the troops in the East Indies and the colonies—comprised the following:

Regulars (Service Companies),	68,778
" (Depôt "),	33,302
Embodied Militia,	15,911
Disembodied " (out of 113,801),	52,899 Effectives.
Yeomanry Cavalry (out of 17,196),	15,000 "
Enrolled Pensioners (out of 16,120),	15,000 "
Volunteer Rifles and Artillery,	122,367
	323,259

If to these be added all the British troops in India and abroad, and all the colonial corps, the total swelled up to more than 500,000 men trained or training to arms—of whom, however, the regulars of the home army, actually available for field-service, barely exceeded 63,000. The sepoy or native army of India is wholly excluded from this enumeration.

BRITISH ASSOCIATION. An Association whose object is, by bringing together men eminent in all the several departments of science, to assist the progress of discovery, and to extend over the whole country the latest results of scientific research. A prevailing impression that England had fallen behind other countries, both as to the general estimation in which scientific men were held, and the prosecution of science itself, led to its formation. It was thought that an imposing union of men of science with the nobility, gentry, and clergy

might tend to revive the philosophic spirit of the country. Such meetings had already taken place in Germany, and probably suggested the idea of this institution. Many leading-men of the age took part in its formation, but the honour of being its founder must be ascribed to Sir David Brewster. By his exertions the first meeting of those who were favourable to the design was held at York in the year 1831. The Archbishop of York, the mayor and council of the city, entered warmly into the project. At this meeting the constitution of the society was determined, the several sections had their provinces assigned to them, and subjects were proposed on which reports were to be drawn up and read at the ensuing meeting. This took place at Oxford in 1832. The university had cordially welcomed the new Association, the papers which were read gave it at once the high character it has since sustained, and from this date it may be said to have been in complete and successful operation. An enumeration of the several sections of the society, each of which has its own committee and president, will shew the wide range of topics it embraces: Section A., Mathematical and Physical Science; B., Chemistry; C., Geology; D., Zoology and Botany, including Physiology; E., Geography and Ethnology; F., Economic Science and Statistics; G., Mechanical Science.

At the close of each meeting, it is determined at what town in the United Kingdom the next shall be held, and a president of the whole Association is appointed, who delivers an inaugural address, in which he is expected to present a general survey of the latest advances of science. The rules and by-laws of the society, it is not necessary here to particularise; but it should be mentioned that the subscriptions of a continually increasing membership have placed at its disposal a large fund, which has been expended in the prosecution of science. In many cases, as in long astronomical calculations, or extensive meteorological observations, the labour of subordinates is required, and a certain apparatus, and it is in defraying such expenses that the funds of the B. A. are very wisely employed.

Besides the immediate ends sought to be obtained by such an Association, its utility will be evident if we reflect on the intimate connection that exists between the several branches of science, and the impossibility there is that any one mind can be thoroughly conversant with them all. He who now hopes to make discoveries in science must limit himself to a few chosen studies; and yet such is the interlacing of all the several branches of inquiry, that he must often find it indispensable to know the last results of each. The botanist or the physiologist must consult the accomplished chemist; the chemist must call in the aid of those who have specifically studied the action of heat, light, and electricity; the geologist needs them all, and is in turn consulted by all. Thus, a certain brotherhood of science is formed, in which each has his specialty, and yet each leans upon his brother.

In ancient times it was otherwise. The facts on which a philosopher speculated were those which lay open to the eyes of all. A Thales could see the rain fall and plants grow, and forthwith pronounce that the vital energy of all things was to be found in water. He could exercise his imagination in perfect independence of the labour of all other men. The philosopher of modern times cannot move a step without a careful consideration of the theories of his predecessors and contemporaries; he has to take notice of the innumerable facts brought to light by various observers, aided by those artificial arrangements which convert observation into experiment.

Two classes of men, of the most opposite character,

are greatly aided by an Association such as this. The humble and plodding workmen are taught where their patient industry will most avail; they are cautioned against re-discoveries; they are told where their love of collecting or experimentalising may be best applied. And that other class of men, who love to generalise, who ever seek to embrace all the multifarious facts of science under a few great laws—these are provided with the very last intelligence from every department of inquiry, and may forthwith proceed to weave it into their own comprehensive scheme. Nor are we to overlook the benefit which the whole community derives from the rapid dissemination of the latest results or speculations of philosophy. Not only do our idle and fashionable, as well as our manufacturing towns and our universities, welcome the meetings of the B. A., but from this *Parliament of Science* the utterance of scientific opinion goes forth over the whole kingdom through the agency of the press. Within three days after one of its meetings, there is not a workshop or a tea-table in the country that has not derived from it a new topic of conversation. This kindling of an interest in science, through the whole population, we regard as amongst the greatest advantages of the British Association.

BRITISH EMPIRE. See GREAT BRITAIN AND IRELAND.

BRITISH GUM, DEXTRINE, or LEOFOME, is a substance extensively employed by calico-printers and others for the thickening of colours, instead of the much more expensive gum arabic. It is prepared from potato-starch (q. v.) or sago-starch by passing the grains through iron cylinders at a temperature about 500° F. It differs from starch in giving no blue colour with tincture of iodine, and in being readily soluble in water, and thus yielding a thick liquid resembling in consistency mucilage (strong solution of ordinary gum). B. G. is the material which is produced by baking in the crusts of loaf-bread (q. v.), and which communicates to them their very agreeable taste.

BRITISH MUSEUM. The British Museum, an important national institution in London, originated in a bequest of Sir Hans Sloane, who, during a long lifetime, gathered an extensive and, at the time, unequalled collection of objects of natural history and works of art, besides a considerable library of books and manuscripts. These, in terms of his will, were offered, in 1753, to the government, on condition that £20,000 should be paid to his family, the first cost of the whole having amounted to more than £50,000. The offer was accepted; the necessary funds were raised by a lottery! and the collection, along with the Harleyan and Cottonian Libraries, were arranged in Montague House, which had been purchased for £10,250. The new institution, thenceforth called the **BRITISH MUSEUM**, was opened in 1759. From time to time, purchases and donations succeeded each other rapidly. Montague House sufficed for the reception of all these acquisitions, till the Egyptian antiquities arrived in 1801. The purchase of the Townley marbles in 1805, necessitated the erection of a gallery for their reception. This, however, did not meet the increasing demand for space. The old house was condemned, and plans were prepared by Sir R. Smirke for new buildings; but none were undertaken till 1823, when the eastern wing of the present building was erected for the reception of the library of George III., which had been presented to the Museum by George IV. The subsequent progress of the works was very slow. The building was completed in 1847. It is a hollow square, whose sides are opposite to the four points of the compass.

BRITISH MUSEUM.

Throughout the exterior of the building, the Grecian Ionic is the order of architecture adopted. The principal front is towards the south, facing Great Russel Street, and presents an imposing columnar façade, 370 feet in length. The great entrance-portico, in the centre, is composed of a double range of columns, 8 in each range. The columns are 5 feet in diameter at their base, and 45 feet in height. The tympanum of the portico is ornamented with an allegorical sculpture by Westmacott, typical of the progress of civilisation. On either side of the Museum, there is a semi-detached house, containing the residences of the chief officers of the establishment. These give an additional length of 200 feet, making the whole length of the structure 570 feet. The interior of the building is admirably adapted to the purposes for which it is devoted. Some of the galleries, from their size and dimensions, have a very imposing appearance, as the King's Library, the Bird Gallery, &c. The grand entrance-hall is a noble and lofty apartment, built in the massive Doric style: it contains a statue of Sir Joseph Banks by Chantrey, and an ideal representation of Shakspeare by Roubilliac.

Scarcely had Smirke's plans been carried out, when demands were made from several of the departments for more accommodation. Additions have accordingly been made, rooms having been provided for the print department, and several new galleries for the recent acquisitions of antiquities; but the most important addition, is the magnificent reading-room which has been erected in the internal quadrangle. In no department of the Museum was additional accommodation more needed than in the library. The number of readers had increased beyond the means of accommodation, and so short of space were they for books, that the estimates for purchases were restricted to only the half of the sum which the trustees considered desirable, for the sole reason that the library would be inadequate for the reception of extensive additions. After considerable delay, and the consideration and rejection of several plans, nothing was done till Mr Panizzi, at that time keeper of the printed book department, suggested a plan which promised to meet the important requirements of speedy erection and economy in cost. The plan was at length adopted, and the result is a building than which none are better, few perhaps so thoroughly adapted to the purposes for which it is intended. Parliament voted the first grant for it in 1854. It was opened in 1857. The total cost was about £150,000, which includes the fittings and furniture, and the necessary shelves for immediate use. The building was erected in the interior quadrangle, which it completely occupies, with the exception of an interval of about 28 feet all round, necessary for lighting and ventilating the surrounding building. The reading-room is circular. It is constructed principally of iron, with brick arches between the main ribs. The dome is 106 feet in height, and its diameter 140 feet, being second only to the Pantheon of Rome, and that but by two feet. The use of iron has economised the space to an extraordinary degree, for while the piers which support the Pantheon fill 7477 feet, those on which the reading-room rests occupy only 200 feet. Equally remarkable has been the saving of space in the fitting up of the library. The shelves are formed of galvanised iron plates, edged with wainscot, and covered with leather, and are supported on malleable iron standards. In all the cases except against the external walls, the bookcases are double, a lattice of iron-work being fixed for the longitudinal separation of the books. Thus, throughout the whole interior of the new building, walls are dispensed with, the

divisions being in all cases formed of the double ranges of books. The building contains three miles lineal of bookcases eight feet high. Assuming them all to be spaced for the averaged octavo book size, the entire ranges form 25 miles of book-shelves, and would accommodate 1,000,000 such volumes. In addition to this, the dome-room, which is the reading-room, has accommodation for 80,000 volumes. This magnificent room contains ample and comfortable accommodation for 300 readers. Each person has a space of 4 feet 3 inches long. He is screened from the opposite occupant by a longitudinal division, which is fitted with a hinged desk, graduated on sloping racks, and a folding-shelf for spare books. In a recess between the two are placed an inkstand and penholders, thus leaving the table unencumbered. By an ingenious contrivance, one part of the iron framework is made to distribute fresh air, while another carries a stream of warm water for heating the building. The vitiated air is conveyed through apertures in the soffites of the window, into one of two separate spherical and concentric chambers, which extend over the whole surface of the roof, and escapes through outlets around the lantern. The other chamber, between the external covering of copper and the brick vaulting, has for its object the equalisation of temperature, during extremes of heat and cold out of doors. Every modern improvement, in short, has been applied, when it could be serviceable for the comfort or convenience of the readers. Much praise is due to the architect and builder, but a larger share is owing to Mr Panizzi, who not only supplied the original design, but daily, almost hourly, superintended the progress of the work, continually suggesting little improvements, and in the end, producing a room which is admired by all, especially those who daily use it.

This building, while supplying amply the demands of the printed book department, did nothing to meet the requirements of the other departments. This matter has been recently repeatedly under the consideration of the trustees. At a meeting on the 21st of last January, it was agreed to erect a building on the property of the Exhibition commissioners at Kensington, for the reception of the natural history collections; but this resolution has been so much opposed by scientific men, both within and outside of the Museum, that there seems little doubt that the trustees will depart from it, and provide the much needed accommodation in immediate contiguity with the present building. The whole matter is being investigated at present by a parliamentary committee.

Contents.—At first, the contents of the Museum were arranged under three departments—Printed Books, Manuscripts, and Objects of Natural History. Under the last head were included the antiquities, works of art, &c., comprised in the Sloane collection, their number being too scanty to entitle them to constitute a separate department. The progress of the Museum has caused a more precise division of its contents. From time to time, the number of the departments has been increased, so that instead of three, there are now eight—viz., Printed Books, Manuscripts, Prints and Drawings, Antiquities, Zoology, Botany, Geology, and Mineralogy. In noticing the contents of the Museum, we shall refer to them in this order. We can but allude here to the most important portions of the collection, and must refer for more particular information to works specially devoted to this subject; such as, the interesting little volume, *The British Museum*, issued by the publishers of this *Encyclopædia*, or the various handbooks and catalogues prepared by the officers of the Museum.

Printed Books.—This is the largest department in the Museum. It occupies the whole of the ground-floor on the north and east sides, the new building erected in the quadrangle, and a considerable portion of the basement of the Museum. The keeper of the department has the help of two assistant-keepers, and 29 assistants. There are in addition 16 transcribers, and 62 attendants.

The original bequest of Sir Hans Sloane consisted of 50,000 volumes. When these were placed in Montagu House, a small collection of 2000 volumes, bequeathed to the nation by Major Edwards in 1738, was added to them. In 1757, George II. presented the library of printed books which had been collected by the kings of England since Henry VIII., and which included the libraries of Cranmer and Casaubon. He also annexed the important privilege, which the Royal Library acquired in the reign of Queen Anne, of being supplied with a copy of every publication entered at Stationers' Hall. By this means, the library has been supplied with the current British literature without expense or trouble, and the trustees have been able to devote the funds of the Museum to the purchase of the earlier literature of the country and foreign publications. Among subsequent additions to the library, may be mentioned the voluminous collection of pamphlets, &c., relating to the civil wars of England between 1640 and 1660, presented by George III.; the musical libraries of Sir J. Hawkins and Dr C. Burney; Garrick's collection of old English plays; Dr Bentley's collection of the classics, annotated by his own hand; the law library of F. Hargrave; Sir J. Banks's valuable and extensive collection on natural history; and a large mass of tracts and pamphlets relating to the French Revolution, purchased by the trustees at different times, and of very great value. The most important addition was made in 1823, when George IV. presented the splendid library that had been collected by his father during his long reign at an expense of little less than £200,000. This library, which, from the terms of the gift, cannot be mixed with the general collection, occupies a large and handsome hall, extending along the whole of the ground-floor of the eastern side of the Museum. It is undoubtedly the finest and most complete library ever formed by a single individual. 'It contains,' says Sir H. Ellis, 'selections of the rarest kind, more especially works of the first ages of printing; it is rich in the early editions of the classics; in books from the press of Caxton; in the history of the states of Europe, in the languages of the respective countries; in the transactions of academies; and in a grand geographical collection.' The magnificent library of the Right Honourable Thomas Grenville, in importance second only to the King's Library, was bequeathed to the Museum in 1846. It consists of 20,240 volumes, which cost upwards of £54,000. In the same year was obtained also the extensive collection of Chinese works, amounting to 11,509 volumes, which belonged to Robert Morrison. By purchases, bequests, and donations, the library has become one of the first in the world, containing now (1860) nearly 700,000 volumes. See LIBRARIES. But even this figure, large though it is, does not represent the far larger collection of separate and distinct articles in tracts, pamphlets, and manuscripts. These not being yet accurately catalogued, their value and number cannot be estimated. Probably, the enormous quantity of pamphlets, political, theological, and scientific, of Great Britain, since the Reformation, constitutes the British Museum library one of the largest collections of printed literature in the world. Since the opening of the new reading-room, and the consequent acquisition of the book-accommodation, the

want of which for several years had hindered the proper increase of the library, the rate of increase has been enormous. In the year 1858, the additions numbered 32,152 volumes, and 23,995 parts of volumes. The whole number of additional articles for the year was 101,705. During the year 1859, there were added 29,167 volumes, including music, maps, and newspapers, of which 1715 were presented, 21,291 purchased, and 6161 acquired by home copyright. The number of parts of volumes was 31,235. In addition, the library had accumulated numerous maps, charts, plans, broadsides, and miscellaneous articles, variously obtained. The numbers of the pieces of music alone added were 5332 complete works, besides 727 parts and numbers of works in progress. The total number of articles received during the year amounted to the extraordinary number of 228,438.

A catalogue of the printed books, in seven octavo volumes, was published in 1813—1819. So great have been the additions to the collection since the publication of that catalogue, that the interleaved copy of it in which the new entries were made had expanded in 1846 into 82 folio volumes. This is now superseded by two manuscript catalogues in 1005 folio volumes. The General Catalogue, which, as far as it is finished, consists of 586 volumes, and contains all the books in the library falling under the letters A—G, with the exception of the Grenville collection, besides 10 volumes of indexes to various long headings. The Supplementary Catalogue, which occupies 409 volumes, contains the remainder of the alphabet, H—Z, comprising all the books under those letters which have been added to the library since 1847.

Besides these, there are catalogues of the Grenville library, in 7 volumes; of music, in 57 volumes; of maps, &c., in 79 volumes; of newspapers, in 4 volumes; of the prints, maps, and charts in the King's Library, in 2 volumes; of the pamphlets in the same library, in 9 volumes; and of the pamphlets published during the Civil War and Commonwealth, called the 'Thomason Collection,' in 12 volumes, all folio. These various catalogues are placed in the central circular stands in the reading-room, for consultation by readers.

The right of access to the library is easily obtained. Any person desiring it, is 'to apply in writing, addressed "To the Principal Librarian of the British Museum," and not otherwise, specifying his description and place of abode, and accompanying his letter with a written recommendation, satisfactory to an officer of the Museum; and thereupon, the principal librarian may grant him admission for a term not exceeding six months, or refer the application to the trustees at their next meeting. Any reader once admitted, may apply at the close of his term for the renewal of his ticket, without a fresh recommendation, but producing his last ticket of admission.'

Manuscripts.—The manuscripts are contained in several rooms in the south-east angle of the building. The work of the department is carried on by a keeper, assistant-keeper, and seven assistants. The manuscripts are for the most part bound in volumes, and placed in cases around the rooms. The collection consists of: 1. The Sloanean manuscripts, relating chiefly to medical and natural history subjects. 2. The Cottonian manuscripts, rich in documents referring to the early history of Britain, in registers of English monasteries, and in original letters of royal and illustrious personages. This collection contains the *Durham Book*—a copy of the Latin Gospels with an interlineary Saxon gloss, written about the year 800, and believed to have belonged to the Venerable Bede. 3. The Harleian

manuscripts, a collection rich in illuminated missals, in ancient, civil, and ecclesiastical records, in manuscripts of the classics, among which is one of the earliest known copies of the *Odyssey*, and in early English poetry. 4. The manuscripts of the Ancient Royal Library. These were collected by our kings, from Richard II. to George II.; many of them were obtained from the monasteries, on their destruction. Amongst the most valuable treasures here are the *Codex Alexandrinus*, a manuscript of the Bible written in uncial Greek, before the close of the 5th c.; and the *Basilicon Doron* of James I., in his own handwriting. 5. The Lansdowne manuscripts. This collection comprises the Burghley and Cæsar papers, the manuscripts of Bishop Kennett, and numerous valuable historical documents and state papers. 6. The Hargrave manuscripts, almost exclusively connected with law. 7. The Burney manuscripts, containing a large collection of the Greek and Latin classics. Among them is a copy of the *Iliad*, answering that of the *Odyssey* in the Harleian collection. 8. The Howard-Arundel manuscripts, obtained from the Royal Society. This collection is singularly rich in materials for the history of our own country and language. 9. The Oriental manuscripts, a collection composed of several purchases and bequests. It includes the manuscripts acquired by Mr Rich while consul at Bagdad, and consists of numerous Syriac, Arabic, Ethiopic, and other Oriental codices. The year 1859 added a valuable collection of 53 manuscripts, purchased from Dr Sternschuss. 10. Miscellaneous manuscripts. This collection consists of innumerable bequests, donations, and purchases, which from the establishment of the Museum have been and are still being acquired. During the last six years, there have been added to this collection nearly 3500 manuscripts, and 8000 charters and rolls, besides a considerable number of seals and impressions. Among these additions may be specified a charter of William the Conqueror; the original mortgage-deed of a house in Blackfriars, dated 11th March 1612, and signed by William Shakspeare; the holograph manuscript of Scott's *Kenilworth*, and of many of Burns's poems, including the *Cottar's Saturday Night*, and the songs published in Johnson's *Scots Musical Museum*; an extensive series of papal bulls; and several *Books of Hours*, including the famous *Bedford Missal*. During 1859, a large collection of original letters and papers relating to the affairs of Scotland during the 16th and 17th centuries, have been acquired by the Museum. Catalogues of the complete collections have at different times been published. The additions to the ever-increasing Oriental and Miscellaneous collections are at intervals published in supplements to each of the original catalogues. Copies of all these, with manuscript lists of the annual additions, are placed in the reading-room for consultation.

The right of using the reading-room includes the privilege of consulting the manuscripts. During 1859, the number of deliveries of manuscripts to readers in the reading-room amounted to 21,895. To artists and others in the rooms of the department, 2280 deliveries were made. These numbers do not include the volumes exhibited to visitors on private days.

Prints and Drawings.—The collections of this department, managed by a keeper and transcriber, are kept in rooms in the north-west angle of the building. They consist of prints and drawings bequeathed to the Museum, in 1799, by the Rev. C. M. Cracherode; of those bequeathed in 1824 by Mr Payne Knight; and of numerous smaller bequests and donations. No purchases were made for this department until about 1840, when a sum was

first included in the estimates for this purpose. Since that time, the prints and drawings have been increasing at a rate equal to any of the other departments of the Museum. The collection is arranged in schools. 1. The Italian school, containing original drawings by Leonardo da Vinci, Raphael, Correggio, Tintoretto, Paul Veronese, Michael Angelo, Guido Reni, Salvator Rosa, and others. 2. The German school, containing drawings by Albert Dürer, Hans Holbein, Dietrich, Hollar, and others; and engravings by Lucas Cranach, Martin Schon, Gauer, and others. 3. The Dutch school, containing several superb originals of Rubens, an extensive and nearly complete set of the works of Rembrandt, with many drawings by A. Cuypp, Teniers, Van Dyck, &c.; and engravings and etchings by Berghem, Lucas van Leyden, Rembrandt, Ostade, &c. 4. The French school, with drawings by Watteau, Claude Lorraine, &c., and etchings and engravings by Bourdon, Boisseaux, Le Prince, &c. 5. The Spanish school, represented by some drawings of Murillo, and others of less note. And, 6. The English school, containing drawings by R. Wilson, Wilkie, Stothard, Callcott, Gibson, &c.; a splendid collection of Hogarth's prints, and specimens of the works of Barlow, Gaywood, Raimbach, Finden, Worlidge, Geikie, &c.

This department contains also an extensive and very valuable collection of works in Niello; a beautiful silver cup, designed and carved by Benvenuto Cellini, and a wonderful stone-carving in alto-relievo by Albert Dürer, representing the birth of St John.

Antiquities.—This collection, at first so insignificant, now occupies more space in the Museum than any other of the departments, except the library. The basement, ground and upper floors of half the south, and all the west side of the building, are filled with the objects belonging to this department.

The collections are divided into two series—the first consisting of sculptures, including inscriptions and architectural remains; the second comprehends all the smaller remains of whatever nation or period, such as vases, terra-cottas, bronzes, coins, medals, and articles of personal or domestic use. The sculptures occupy the ground-floor, and consist of the Egyptian, Assyrian, Greek, and Roman remains.

1. *Egyptian Antiquities.*—The monuments in this collection date from a period as remote as 2000 years before the Christian era, and come down to the Mohammedan invasion of Egypt, 640 A.D. The collection has been obtained chiefly from these sources: the antiquities which fell into the hands of the British army at the capitulation of Alexandria, presented by George III.; presents from General Vyse, the Duke of Northumberland, the Marquis of Northampton, Sir Gardner Wilkinson, and others; and acquisitions from the Earl of Belmore, Mr Salt, and M. Anastasie. The sculptures are formed of granite and basalt; they represent human and allegorical figures, sometimes of colossal size. There are several beautifully sculptured sarcophagi. Most of the monuments are inscribed with hieroglyphics (q. v.). The key to this dead and forgotten language was furnished by the celebrated Rosetta Stone (q. v.), which is placed in the centre of the gallery. The smaller Egyptian remains are exhibited in a gallery on the upper floor; they consist of objects relating to religion, as representations of divinities and sacred animals, in wood, metal, stone, and porcelain; of objects relating to civil and domestic life, as dress, personal ornaments, household furniture, artistic and writing implements, armour, and weapons of war, &c.; and of objects relating to death and burial, as mummies and coffins, with the scarabæi, amulets, and other ornaments found with them. A collection of papyri is exhibited on the north-west

staircase, containing extracts from the ritual of the dead.

2. *Assyrian Antiquities*.—These are contained in a suite of rooms recently erected on the outside of the Egyptian Gallery, and in a spacious room on the basement, lately opened (1st June 1860). The collection consists of sculptures excavated at Nimrud, Khorsabad, and Koyunjik by Layard in 1847—1850, and more recently by Rassam and Loftus, under the direction of Sir H. C. Rawlinson. The Nimrud sculptures are the oldest, belonging to a period ranging from 930 B.C. to 747 B.C. Those obtained from Khorsabad seem to have been executed under a monarch who reigned about 747—721 B.C., while the collection from Koyunjik belong to a more recent date, apparently 721 B.C. and 625 B.C. The monuments consist chiefly of slabs of gypsum, alabaster, and limestone sculptured in low relief, the subjects being the exploits of the king whose palace walls they ornamented. Many of the sculptures are covered with cuneiform (q. v.) writing, which, by the labours of Rawlinson and Hincks, has been deciphered, giving us a history of this remarkable people, and corroborating the narrative of the sacred Scriptures whenever they refer to the same event. See ASSYRIA. Besides the series of sculptures, the Assyrian collection includes a variety of smaller but highly curious and instructive objects, discovered at Nimrud and Koyunjik.

3. *Greek Antiquities*.—This collection occupies three apartments, which run parallel to the Egyptian Gallery. The Lycian Gallery contains a series of architectural and sculptural remains from ancient cities in Lycia, obtained by Sir C. Fellows in 1842—1846. The Elgin Gallery contains the sculptures and inscriptions from Athens and Attica, the greater portion of which were obtained by the Earl of Elgin, and purchased from him by parliament in 1816 for £35,000. The most important series in the gallery is the decorations of the Parthenon (q. v.), which, notwithstanding their dilapidated condition, form the most valuable monument of Greek art which has descended to modern times. The gallery contains also sculptures from the Temple of Wingless Victory, the Temple of Theseus, and the Erechtheum, at Athens. The Hellenic Gallery contains a number of antiquities brought from Greece and its colonies at different times. The most important are 23 slabs of a frieze sculptured in mezzo-rilievo, which, from the locality, where they were found, are called the 'Phigalian Marbles.'

4. *Roman Antiquities*.—The gallery on the south side of the building is occupied with the Roman and Græco-Roman sculptures. The bulk of the collection was formed by Charles Townley, Esq., and purchased in 1805 for £20,000. Subsequent additions have been made by the bequest of the collection of R. P. Knight, Esq., in 1824, and by various purchases and donations. The collection contains an interesting series of Roman portrait sculptures, and a very extensive mythological series, amongst which are some of universal fame—the Venus, the Dione, the Apollo, the Diana, and many others. A room on the basement is appropriated to miscellaneous monuments, such as representations of animals, architectural and decorative fragments, and sacred and domestic implements. A fine collection from Southern Italy, exhibiting specimens of the arts of the Etruscans, Greeks, and Romans, was bequeathed to the Museum by Sir William Temple in 1856. They have been temporarily placed in the west side of the second Egyptian room on the second floor.

The collections of smaller remains are placed in a suite of rooms on the same floor. They consist of—

1. An extensive series of vases, commonly, though

not very correctly, known as Etruscan, formed from the collections of Sir W. Hamilton and Mr Burgon, and from purchases at the sales of the Prince of Canino, M. Durand, and others. 2. Bronzes of Greek, Etruscan, and Roman workmanship, consisting of sculptures, and various domestic and other articles, as candelabra, lamps, vases, horse-trappings, armour, &c. 3. The British collection, arranged in chronological order. The oldest series contains the antiquities of the Stone and Bronze Periods, consisting of celts, daggers, swords, shields, and early pottery. The British-Roman antiquities comprise specimens of earthenware, lamps, and miscellaneous articles. A small collection of sepulchral urns, weapons, and personal ornaments represents the Anglo-Saxon period. The antiquities found in London, and belonging to the late C. R. Smith, have been recently added to this collection. 4. The Ethnographical collection contains antiquities as well as objects of modern use belonging to all nations not of European race. The latest additions to this collection consist of two cases of specimens brought home by the late Arctic Expedition. In the medal-room of this department there is an extensive, very valuable, and ever increasing collection of coins and medals, arranged chronologically under the different countries to which they belong.

A very important addition to the Greek monuments has been made during 1857—1859, by the arrival from the East of an extensive collection of sculptures and architectural remains, which were obtained by C. Newton, Esq., from the Temple of Apollo at Calymnos, from Halicarnassus, Cnidus, and Branchida, and from the Greek Isles. Included amongst them are remains of the famous Mausoleum (q. v.), erected in honour of Mausolus, by his widow Artemisia. This collection has found a temporary resting-place in the colonnade in front of the building, which has been partially glazed, to protect them from the weather.

Zoological Department.—To give an idea of the contents of this and the other natural history departments, would be to write an epitome of the various sciences they illustrate. This department contains a collection of animals arranged in systematic order in the galleries, comprising stuffed mammals, birds, reptiles, and fishes, and the hard portions of radiata, molluscan, and articulate animals. A room is specially devoted to the fauna of Britain. In rooms on the ground and basement floors are arranged the collections of insects, of osteology, and of specimens preserved in spirits. An idea of the extent of the collection may be formed from the fact, that 142 separate publications, illustrative of the contents of the department, in the shape of catalogues, lists, &c., have been issued under the superintendence of the present indefatigable keeper, Dr Gray. During the past year, there were added to this collection 33,307 specimens of animals, of which 2914 were vertebrata, 5282 mollusca and radiata, and 25,111 annulosa. In May of this year, an extensive collection of valuable—many of them typical—specimens was obtained from the Museum of the East India Company.

Botanical Department.—The herbarium of Sir H. Sloane, the nucleus of this collection, consisted of about 8000 species, bound in 262 volumes. In 1820, the magnificent herbarium of Sir Joseph Banks was bequeathed to the Museum, and under the superintendence of the late Robert Brown, was transferred to two rooms prepared for it in the south-east angle of the building. The collection has since been rapidly increasing; during the year 1859, 5371 species of plants were added; and in June of the year 1860, the late Professor Nuttall's herbarium of 10,000 species was acquired by purchase. The

collection is second to no other in importance to the scientific botanist, from its containing an extraordinary number of typical specimens—the identical plants from which the original descriptions were taken by Linnæus, Aublet, Jacquin, Brown, Bentham, Bennett, and others. A series of specimens, suited for exhibition, are placed in a public room. They consist of woods, fruits, &c., and a suite of models of British fungi. An unrivalled collection of fossil woods, bequeathed by Robert Brown, is preparing for exhibition.

Geological Department.—This collection occupies the wall-cases of the principal gallery on the north side of the Museum. It contains an extensive series of the fossil remains of plants and animals from the various fossiliferous strata; it is especially rich in the fossils of the secondary formations. Amongst its more valuable contents may be mentioned the collections of Dr Mantell, the Tertiary fossils collected by Dr Falconer in India, and the remarkable fossil-birds from New Zealand.

Mineralogical Department.—The minerals are contained in the table-cases in the Geological Gallery. They are arranged according to a chemical classification. Many valuable and unique specimens exist in the collection, which is rapidly increasing. In 1859, the number of specimens added was 3186.

The management of the Museum is vested in a body of 48 trustees, of whom 23 are official, one is appointed by the sovereign, 9 represent the families of distinguished donors, and 15 are elected by the other trustees. The patronage to the various offices is vested in the three principal trustees—the Archbishop of Canterbury, the Lord Chancellor, and the Speaker of the House of Commons. The principal librarian is the responsible keeper of the Museum; as secretary, he also carries on the business of the establishment. During 1859, there were 272 persons regularly employed in or about the Museum. The expenses are paid by grants of public money. The total expenditure for the financial year 1859—1860 amounted to £100,997, 10s. According to the estimates, £100,850 are required during 1860—1861. Of this sum, £39,084 are for salaries, £25,282 for purchases, £8600 for bookbinding alone. The total expense of the British Museum to the nation, since its foundation in 1753 to March 1860, has been £1,382,733.

Admission to the Museum was at first obtained by printed tickets, which were delivered by the porter to persons making a written application. There could be no more than 45 visitors, at the utmost, per day, under the regulations then in force. Now, all who present themselves are freely admitted; and every open day (every Monday, Wednesday, and Friday) the Museum is visited by large numbers: as many as 43,000 holiday-folk have recently passed through the building in one day.

BRITISH NAVY. Under NAVIES, MODERN, will be found a brief description of the chief navies belonging to the continent of Europe, and to the United States of America. The B. N. is separately treated in this place.

While the Romans occupied Britain, they were obliged to maintain a fleet of war-vessels on the coasts, to protect it from the ravages of the Saxons, who were the pirates and bucaners of those times. When the Romans had departed, and the Saxons became dominant, the coasts were infested by another naval power—the Scandinavian Vikings. It was Alfred the Great who first established what may be called a navy in this island, consisting of efficient vessels well manned, for protection, and not aggression. Ethelred made the building of a ship a condition for holding a certain acreage of land. William the Conqueror strengthened the navy by the

institution of the CINQUE PORTS (q. v.). During the first three centuries after the Conquest, we read of British fleets of 240, 400, and even 730 sail—a proof that the vessels must have been very small even if there were no exaggeration of numbers. Until 1485, the fleets were collected just as wanted; but in this year, Henry VII. conceived the idea of a permanent navy, to be ready at all times. He built the largest ship of the age, the *Great Harry*. Henry VIII. pursued the course established by his father, and still further strengthened the navy by instituting the Admiralty, the Navy Office, the Trinity House, and the dockyards at Woolwich, Portsmouth, and Deptford. The *Henri Grace de Dieu*, the largest ship built by him, was of 1000 tons burden; but most of the vessels were high, unwieldy, and narrow, with the guns nearly down to the water's edge. The ships of the navy presented an aggregate tonnage of 12,000 tons at the period of Henry's death. Elizabeth made a large increase in the navy; but they were not all royal ships which were sent to struggle against the Spanish Armada. James I. made many improvements in ship-building, by encouraging a distinguished naval architect, Phineas Pett. Charles I., who built the *Sovereign of the Seas*, of 100 guns, was the first to group the royal ships into rates and classes. Cromwell brought up the navy to the strength of 154 sail, including a large number of two-deckers. Charles II. allowed it to fall into decay for a time; but his brother, the Duke of York, who afterwards became James II., not only restored it, but brought it to a higher state of efficiency and strength than ever. When William of Orange became king of England, he found a navy carrying 7000 guns and 42,000 seamen; he built many additional ships, some with as many as 80 guns, and established Plymouth dockyard. Queen Anne succeeded to the possession of a fine navy; which at her death had increased to 198 ships, mounting 10,600 guns, with a tonnage of 157,000 tons. George I. attended to the navy chiefly in repairing the ships after a period of war, and in supplying a new armament. George II. greatly added to the number of ships, established a naval uniform, and increased the renown of the B. N. during the war against Spain.

The long and eventful reign of George III. was especially distinguished by the achievements of the navy. When he came to the crown in 1760, he found himself in possession of 127 ships of above 50 guns, and 198 of 50 guns and under, manned by 70,000 seamen. These numbers, by building and by capture, were increased to 174 and 203 respectively, by the end of the American war. Throughout the European struggle, from 1793 to 1815, the B. N. exhibited a spectacle, for vastness and achievements, which had never before been equalled in any country. In the first nine years of this period, between 1793 and 1802, England lost by war 5 ships of the line and 46 smaller vessels; but she captured from the French, Dutch, Spaniards, and Danes, in various battles, 74 ships of the line and 519 smaller vessels; or rather, four-fifths of this number were captured, and one-fifth destroyed. Besides these, more than 800 privateers were taken and destroyed by the English. Of the total number of captures, 144 ships of war were at once converted into British ships, and added to our navy. When war recommenced in 1803, England had 189 ships of the line, and 781 smaller ships of war; during the next seven years, the seamen varied from 100,000 to 120,000, and in 1810 the number was raised to 140,000. At all times, many of the ships of the royal navy are unemployed or out of commission; but it frequently happened during that great war, that England had 450 liners, frigates, and sloops, besides

smaller armed vessels, employed simultaneously. The conquered vessels added to the navy between 1803 and 1815 were upwards of 100 in number.

After the termination of the great European struggle, a large number of ships of war were put 'in ordinary,' or out of commission, and their officers placed on half-pay. In 1820, the vessels in commission, in ordinary, and building, comprised 127 ships of the line, 311 frigates and sloops, and 27 smaller vessels; but in this total of 465, there were only 113 in commission. In the nineteen years that next followed, almost wholly years of peace, the total number of ships of the line, frigates, and sloops, decreased; the gun-brigs, schooners, and cutters increased in number; while the first germs of a new element, a *steam navy*, made their appearance.

The year 1839 must be viewed as a turning-point in the history of the British navy. Twenty-four years of peace had thrown the memory of warlike achievements into the background; and the House of Commons had insisted on the lessening of those estimates which provide for armies and navies. It was now found, however, that both Russia and France had accumulated formidable navies. Hence began a rivalry which has now endured twenty-one years (1839 to 1860). We cannot afford space to trace the steps by which ships of war have almost wholly changed their character within a quarter of a century; but it may be stated here, that when England sent 95 ships of war to fight against Russia in the Black Sea, the Baltic, and elsewhere, in 1854, no less than 79 of them were steamers. At the beginning of 1859, England possessed, either built, or building, 52 steam and 15 sailing ships of the line, 38 steam and 16 sailing frigates, 9 block-ships, 4 mortar-ships, 87 steam and 72 sailing corvettes and sloops, 168 steam gun-boats, 8 steam floating-batteries, 109 steam and 49 sailing gun-vessels, tenders, surveying-vessels, troop-ships, store-ships, depôt-ships, training-ships, gunnery-ships, &c.

Besides the change from sailing to steaming, the B. N. is undergoing much change in the armament of the ships. The guns used in 1860 are of a much larger average calibre than those employed during the great war; and they, in their turn, appear likely to be superseded by Armstrong or Whitworth guns of greater range and accuracy.

The expenditure on the B. N. has necessarily increased in a notable degree between 1839 and 1860, on account of the changes just adverted to. The number of seamen and boys, the average pay of each, the average cost of each in other ways, the number of ships, the cost per ship, the number of guns, the cost per gun—all have been increased. In 1839, the number of men and boys voted was little over 25,000; in 1860, it is about 66,000. Even as late as 1852, the expenditure was only £6,500,000, against £12,800,000 in 1860. The following are the votes for manning the navy in the official year 1860—1861:

Regular Fleet,	54,000 officers and men.
Troop and Store ships,	2,000 " "
Coast-guard service,	8,100 " "
Training-ships,	2,000 boys.
	66,100

A supplementary estimate has slightly increased the above numbers. The enormous sum of £12,800,000 for the support of this navy for one year may conveniently be separated into six items, as follows:

Pay, Officers and Seamen,	£3,500,000
Half-pay and Pensions,	1,300,000
Wages of Artificers (Dockyards, &c.),	1,500,000
Stores and Works,	3,700,000
Victualling,	1,500,000
Miscellaneous,	1,300,000

All the various matters relating to ships, seamen, naval organisation, and naval warfare, will be found noticed under their proper headings.

BRITTANY. See **BRETAGNE.**

BRITTON, JOHN, an eminent English topographical and antiquarian writer, the son of a small farmer and village shopkeeper, was born July 7, 1771, at Kingston-St-Michael, near Chippenham, Wiltshire, and, losing his parents young, received but a scanty education. Some short notices which he had contributed to the *Sporting Magazine* brought him into acquaintance with its publisher, Mr Wheble, who employed him to compile the *Beauties of Wiltshire*, which he did in conjunction with a young literary friend named E. W. Brayley. They also prepared the *Beauties of Bedfordshire* in the same manner. B. afterwards issued a more elaborate work, entitled the *Architectural Antiquities of England*. One of the most important of his subsequent publications was *The Cathedral Antiquities of England*, 14 vols. fol. and 4to, 1814—1835, with upwards of 300 highly finished plates. Altogether, his illustrated works in the department of architectural and topographical description and antiquities, number 87, besides others of a similar kind, of which he was editor.

BRIVE, a town of France, in the department of Corrèze, pleasantly situated in the midst of vineyards, and shut in by a fine circular avenue of elms, about 15 miles south-west of Tulle. It has manufactures of woollen, cotton-yarn, &c. Pop. 6504.

BRIZA. See **QUAKING GRASS.**

BRIZURE, BRIZÉ or **BRISÉ**, terms used in heraldry to indicate that a charge is bruised or broken. See **ROMPU.**

BROACH, or **BROCHE**, an old English term for a spire springing directly from a tower without any intermediate parapet. Such spires are common in England, and in some places in Scotland, particularly in Fife.



Broach.

BROAD ARROW, a government mark, thus stamped, cut, or otherwise fixed on all solid materials used in Her Majesty's ships or dockyards, in order to prevent embezzlement of royal naval stores. The origin of the mark is involved in obscurity. Previous to the year 1698, the naval authorities prosecuted a dealer in marine-stores, for having in his possession certain stores bearing the B. A. of his majesty. The defendant allowed the evidence against him to go on, and when asked what he had to say, replied, that it was *very curious* that the king and he, as a dealer, should both have the same private mark on their property! The receiver of stolen goods was acquitted, and this led to the passing of the act 9 and 10 Will. III. c. 41 (1698), which enacts that persons in possession of naval stores, or goods of any kind marked with the B. A., or other marks therein mentioned, and usually employed in marking naval stores for the navy, shall forfeit all such goods and £200, and also pay costs. The mark is for iron, wood, &c., what the colour-thread is for sailcloth and ropes, which enables the government to identify the smallest piece of such articles.

BROAD-BILL. See **SHOVELLER.**

BROAD-BOTTOM ADMINISTRATION, a name derisively applied to the ministry formed by Henry Pelham in 1744, because it professed to

include all parties of weight and influence in the state in a grand coalition, and comprised no less than nine dukes—viz., Dorset, Newcastle, Montagu, Bedford, Grafton, Richmond, Argyle, Devonshire, and Bolton, the first seven of whom were of the cabinet. Besides the prime minister, Pelham, the other principal members of the cabinet were Earls Gower and Harrington, the Marquis of Tweeddale and Lord Hardwicke. From this B. A. the particular adherents of Pulteney (newly created Earl of Bath) and Lord Cateret were carefully excluded. The ministry was dissolved in 1754, by the death of Pelham, though several of its original members had seceded long before that time.

BROADSIDE, in naval warfare, is the simultaneous discharge of all the guns on one side of a ship of war. The fighting-power of a ship is sometimes estimated by the weight of her broadside; i. e., the weight of all the shot and shell that can be fired off at once from one side or half of the ship. Thus, the broadside of the *Duke of Wellington*, 131-gun war-steamer, amounts to 2400 lbs. One among the reasons why a paddle-steamer is not so good for war purposes as a screw-steamer, is because the paddle-boxes and wheels interfere with the broadside.

BROADSWORD is a sword with a broad blade, for cutting only, not for stabbing, and therefore not sharp at the point, like a sabre. It is but little used in the British army.

BROCADE. This term is used to describe a silken fabric on which a figure of any kind is formed by the threads of the warp or weft being raised by the heddles, or, more generally, by the Jacquard-loom, in such order as to produce the pattern required. The word has much the same application to silk textures that damask has to linen textures or to worsted textures for upholstery uses. See **WEAVING**, and **JACQUARD-LOOM**.

BRO'CAGE. See **BROKER**.

BROCAGE BONDS TO **PROCURE MARRIAGE**, or **MARRIAGE BROCAGE BONDS**, as they are otherwise called, are void by the law of England, being against the policy of the law and the freedom of marriage. See Hurlstone's *Law of Bonds*, 1835, p. 15, and authorities there referred to. The Scotch law is the same.

BROCCOLI, a well-known and much esteemed garden vegetable, one of the many varieties which cultivation has produced of the *Brassica oleracea*, the common kale or cabbage. B. is said to have been originally brought to Italy and other parts of Europe from the isle of Cyprus about the middle of the 16th century. Its name is probably of Italian origin. It differs little from cauliflower (q. v.), of which it may be considered a mere variety, having coloured instead of white heads, and a deeper tinge of colour in the leaves, being also more hardy, the character from which its chief importance is derived, as it can be readily obtained at seasons when there is no cauliflower in the open garden. It is perhaps inferior to cauliflower, however, in delicacy of flavour. There are many subvarieties, the number of which is, of course, continually increasing; and some of these are preferred for early spring sowing, with a view to an autumn crop; others for later sowing, with a view to a crop in the following spring. The subvarieties differ in size, in their more cut or entire leaves, in the greater or less degree of colour—generally purple—with which the leaves are tinged, in the more or less compact form of the whole plant, in the more or less green, yellow, or purple colour of the head, &c. Some of the kinds

of B. preferred for late sowing and spring use are known by the general name of Cape B., the first of them being said—but on doubtful authority—to have been introduced into Britain from the Cape of Good Hope. The mode of cultivation of B. pretty much resembles that of cauliflower, except as to the times of sowing and transplanting, and that it is generally—even in Scotland—sown in the open ground, and not in a hotbed. A similar richness of soil is required. Various modes of protection in winter are adopted. In mild winters, protection is scarcely or not at all needed, but precautions are generally employed against severe weather. It is found very advantageous to plant in trenches of 6 inches deep, and to earth up the plants, as they are thus not only in some measure preserved from frosts, but also from the winds of winter, which are apt to shake and loosen plants, so as to cause their destruction. It is a common practice to take up some of the most advanced plants in the beginning of winter, and to lay them in a sloping position with their heads towards the north. The heads produced in this way are not in general so large as they might be, but they are sometimes procured when otherwise they probably would not.

BROCHURE, a French word (from *brocher*, to stitch), equivalent to the English word Pamphlet (q. v.).

BROCKEN (*Mons Bructerus*, *Melibocus* of the ancient Romans), popularly known as the *Blocksberg*, is the highest summit of the Harz Mountains. It is situated in the province of Saxony, Prussia, about 20 miles west-south-west of Halberstadt, and has an elevation of 3740 feet above the sea. The mountain is very frequently veiled in mist and cloud-strata, and is celebrated for the phenomenon known as the *Brockengespenst* ('Spectre of the Brocken'), which is nothing more than the shadow of men, houses, or other objects thrown upon the misty eastern horizon by the light of sunset. (See *Gallery of Nature*, published by W. and R. Chambers.) In clear weather, a fine view is obtained from the summit of the Brocken.

BROCKHAUS, **FRIEDRICH ARNOLD**, the founder of the well-known firm of Brockhaus in Leipsic, and publisher of the *Conversations-Lexicon* (q. v.), was born at Dortmund, May 4, 1772. In 1802, circumstances led him to Holland, where, however, his business schemes did not prosper. He returned to Germany in 1810, and in the following year commenced business in Altenburg. Before this, however (in 1808), B. had purchased the copyright of the *Conversations-Lexicon*, which had been commenced in 1796, and he completed the first edition, with the addition of two supplementary volumes, in 1809—1810. In 1812, a second improved edition of the work was commenced under the supervision of B. as editor. The peace of 1815 enabled B. to pursue prosperously his peaceful and civilising career. In 1817, his business had so increased, that he found it necessary to leave Altenburg for Leipsic, where, in the following year, he commenced book-printing in addition to book-publishing. In the course of a few years, the *Lexicon* passed through six editions; it has now arrived at the tenth edition. Through all the enterprises of B. as a publisher, a zealous devotion to the cause of liberty and general enlightenment may be traced. He died August 20, 1823. B. was not only an able and assiduous man of business, but distinguished for his literary culture, his knowledge of the world, and his numerous social accomplishments. He was also eminently patriotic, and furthered many literary undertakings, simply through a pure love of 'fatherland.'

The business is now carried on by HEINRICH BROCKHAUS, second son of the former, who was born at Amsterdam, February 4, 1804. Among the numerous publications issued by the house, may be mentioned the later editions of the *Conversations-Lexicon*, with an *Atlas*; the *Universal Encyclopædia*, by Ersch and Gruber; and the German *Penny Magazine*, founded in 1833.

BROCKHAUS, HERMANN, third son of F. A. Brockhaus, was born at Amsterdam, January 28, 1806; studied at Leipsic, Göttingen, and Bonn, and lived successively in Copenhagen, Paris, London, and Oxford. Since 1848, he has held at Leipsic the appointment of ordinary professor of the Sanscrit language and literature, to which his studies have been chiefly devoted. Among his several works on Oriental literature may be mentioned, the *First Five Books of the Large Collection of Fables, Katha Sarit Sâgara, in Sanscrit and German* (1839); an edition of the drama *Prabodha Candrodâya*, by Krishna Misra, with Hindu scholia (1845); Nachschebi's Persian version of the *Seven Wise Masters* (1845); and (in 1854) the Persian text of the *Songs of Hafiz*, with Sudi's *Commentary*. B.'s method of printing Sanscrit in Roman types is now generally adopted in Germany.

BROCKVILLE, a town of Upper Canada, or Canada West, taking its name from General Brock, who, during the last American war, died in the arms of victory on Queenston Heights, between the town and falls of Niagara. It stands on the left bank of the St Lawrence Proper, about 40 miles below Kingston, and about 160 above Montreal. Originally, its communications downward were interrupted by powerful and rugged rapids, which, however, are now, one and all, either avoided by canals or overcome by steam. B. is a thriving place, with about 3000 inhabitants.

BRODIE, SIR BENJAMIN COLLINS, BART., a distinguished surgeon, third son of the Rev. Peter Bellinger Brodie, rector of Winterslow, Wiltshire, was born there in 1783. He studied under Sir Everard Home at St George's Hospital, to which he was, in 1808, elected assistant-surgeon, and afterwards surgeon. He had previously lectured both on anatomy and on surgery. In 1810, he was elected a Fellow of the Royal Society, and in 1811 received their Copley medal for his physiological papers contributed to the *Philosophical Transactions*. In 1834 he was created a baronet, and he holds the appointment of serjeant-surgeon to Queen Victoria, as well as that of first surgeon in ordinary to the Prince Consort. He was made D.C.L. of Oxford in 1850; is president of the Royal Society, a corresponding member of the Institute of France, and a foreign member of other learned societies and academies in Europe and America. Author of *Lectures on Local Nervous Affections* (1837, 8vo); *Hunterian Oration*, 1837; *Lectures Illustrative of Subjects in Pathology and Surgery* (1840, 8vo); *Introductory Discourse on the Duties and Conduct of Medical Students* (1843, 8vo); *Psychological Inquiries as to Mental Faculties* (1854, 3d ed., 1856), and several other practical medical works. He has also contributed professional papers to the *Philosophical Transactions* and the *Transactions of the Royal Medical and Chirurgical Society*.—B.'s son, B. C. BRODIE, F.R.S., was in 1855 elected Aldrichian Professor of Chemistry in the University of Oxford.

BRODY, a town of Galicia, Austria, is situated on a swampy plain, surrounded by forests, about 58 miles east-north-east of Lemberg. B., which was made a free commercial town in 1779, has a large trade in the agricultural produce of the country with Russia, Poland, and Turkey. Its chief manu-

factures are leather and linen; jewellery, manufactured goods, and colonial produce are imported by way of Odessa. The trade is almost entirely in the hands of the Jews, who form so large a proportion of the inhabitants, that B. has been called 'The German Jerusalem.' Pop. 19,000.

BROG, or BROGUE, a rudely formed species of shoe, formerly in use by the aboriginal Irish and the Scottish Highlanders, and of which there were different varieties. See SHOES and SHOE-TRADE. The name has been applied to a modern kind of shoes, with some fanciful peculiarities.—The term Brogue is also used to signify the peculiar pronunciation of English that distinguishes natives of Ireland.

BROILING is a convenient and expeditious mode of cooking small pieces of meat, by laying them on a gridiron over a bright fire, or even on the coals themselves. This is perhaps the most primitive mode of preparing meat for eating, as may be supposed from the great ease and simplicity with which the operation is managed. B. is, in fact, a quicker sort of roasting. The albumen of the outside being sealed up at once, the meat is rendered extremely nutritious, and therefore this process is much to be recommended. But to broil meat so as to preserve its odour, juice, and fat, requires care. The meat should be prepared for the gridiron by being beaten slightly with the rolling-pin, trimmed of superfluous fat and skin, and cut so as to look well on the dish. The fire should be perfectly clear, and of a red-hot surface to answer to the size of the gridiron, that all parts of the meat may be equally cooked. Just before setting the gridiron over, some salt should be sprinkled on the fire to prevent the flare. The gridiron should be perfectly clean and smooth, being always rubbed when it is put away; and, before using, it should be warmed, greased with suet, and rubbed again with paper. When it is placed on the fire, the back should be higher than the front. The meat should never be touched with a fork, but turned rapidly with the broiling tongs; and when sufficiently done, should be served immediately on a very hot dish, being seasoned according to taste. In large ranges there should be a broiling stove, and an apparatus for B. suited to it; by this the heat of the fire can be easily regulated. But for all ordinary purposes, a fire of charcoal, or of common coal, and a grooved gridiron, to preserve the gravy, is all that is necessary. Sometimes a gridiron is used to hang before the fire, when a dinner

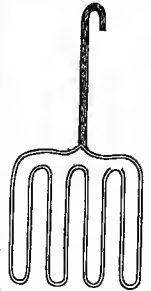

Gridiron.

is being dressed and the top of the fire occupied; this is convenient, but it is an inferior way of cooking, the meat being roasted rather than broiled. There is a gridiron sold in the streets which is very well adapted to small low fires, as it is easily put in between the bars (see fig.).

BROKEN KNEES. The part commonly termed the knee of the horse is the carpus or wrist of man, and from the peculiar conformation of a quadruped, is much exposed, and liable to serious injury. By *broken knee* is meant the abrasion or more serious injury of the joint by a fall; and even when the wounds are healed, the scar usually remains to indicate that the horse has once fallen, and is 'broken-kneed'—an animal is then regarded as unsafe, and seriously deteriorated in value.

Causes.—The fall is necessarily the immediate cause of the broken knee; as to the cause of the

fall, it is usually to be looked for elsewhere than in the horse himself. As a rule, the safety of a horse's action is very great, particularly about the age of from four to seven or eight years. Rarely does a horse at any age fall on his knees, unless his feet have suffered from improper shoeing; the animal then moves cautiously, and is very apt to 'stumble.' Undoubtedly, some horses of defective conformation and sluggish disposition are more likely to stumble and fall than a well made, high-acted steed; nevertheless, the most perfect animal may gradually be rendered unsafe by improper shoeing. See SHOENING.

Symptoms.—It is important, so soon as the injury is done, to determine the extent and depth of the wound. If it be merely a superficial wound, the case is a simple one; and unless the skin is much bruised, the hair will grow, and the animal not be permanently blemished. The sheath, however, through which the tendon over the joint passes, may be opened, and the tendon itself injured. The wound is then gaping, heals rather slowly, and sloughs have to be thrown off. Lastly, the joint itself may be opened, and this is indicated by a free discharge of the joint-oil or synovia, and by the bones being seen or felt on probing. The worst form of accident is that when the bones of the joint are fractured. The system suffers when the wounds are serious, and severe fever sets in.

Treatment.—Whatever may be the form of injury, the first injunction is to wash the wound thoroughly with cold water applied constantly for hours. The joint will swell, become hot and painful, and in some cases irritative fever occurs. Then the animal should be kept on low diet, and be purged with four, five, or six drachms of aloes, according to its size, &c. Should the wound be deep, much dirt remaining in the tissues, a large linseed-meal poultice should be applied over the joint for a day or two, until free suppuration sets in. If this is retarded, and in all cases when the poultice does not appear necessary, cold fomentations may be continued, using either some infusion of chamomile, or one part of tincture of arnica to twelve of water, or one part of Goulard's Extract to a similar quantity of water. The severe symptoms speedily subside, unless the bones are fractured or the joint otherwise seriously injured. Usually, the wound heals rapidly, the joint-oil ceases to flow; and in order to insure a contraction of the wound, mild astringent or caustic applications should be used, such as tincture of myrrh, sulphate of zinc lotion, or sulphate of copper in crystal rubbed over it. When the wound is thoroughly healed, the hair may not grow rapidly, even in parts where it should form; in this case its production may be accelerated by the use of a very mild caustharidine ointment, which should act as a mild irritant, but not as a blister. In some cases of severe broken knee, it is advisable to fix the limb so that the animal may not move the joint much. In veterinary jurisprudence, a broken knee is regarded as a *blemish*, not as an unsoundness.

BROKEN WIND, a disease or unsoundness of the respiratory organs of the horse, which, from the French *pousse*, was termed, by some of the old English writers on farriery, *purisness*. The Germans term it *Dämpfigkeit*, or asthma, though in many of their works it receives also the name of *Herzschlägigkeit*, from a belief that it consists in palpitation of the heart. The nature of the malady is not well understood, though it appears in the form of difficulty in the act of expiration, the horse making an extraordinary or spasmodic effort to expel from the lungs the air which has readily entered them in inspiration.

Symptoms.—A broken-winded horse is usually an animal that does not thrive, is lean, and has a dependent belly, the muscles of which are unusually active as expiratory muscles. The characteristic symptoms are best observed when the horse is exercised, the breathing becoming very laboured, the nostrils dilated, the eyes bloodshot, and even blue, shewing imperfect purification of blood in the lungs. On watching the chest and flank, the ribs are observed very actively moved, and after collapsing, when the air is expelled from the lungs, are further depressed by a spasmodic jerk brought about by the abdominal muscles. A broken-winded horse has a bad cough, of the kind referred to by veterinarians as characteristic of unsoundness, and termed a *hollow cough*. When the animal is oppressed by fast work, or dragging a load up a hill, the pulse is excessively rapid, and the heart beats energetically. From this circumstance, it is regarded by some as a disease of the heart. Others have believed the diaphragm affected, but in reality it is the lungs, or the apparatus for expelling the air from these organs, that is at fault. The diaphragm being a muscle of inspiration, it is probably in no way implicated. No doubt, when the heart is diseased, the function of breathing is sometimes much affected, but these are not the symptoms of true B. W., any more than when the lungs are in part rendered impervious to air, and the act of inspiration is rendered short. This condition constitutes *thick wind*, and is often one of the remote results of inflammatory disease of the lungs.

Causes.—Low-bred horses are liable to B. W., especially if improperly fed on innutritious and bulky food, and at the same time kept at hard and fast work. Whatever may be the way in which the condition of the alimentary canal operates in producing B. W., of this we are certain, that the function of digestion is much impaired. Indeed, the term B. W. is believed to have had reference originally to the constant escape of flatus. B. W. is far more rare now-a-days than of old, and it is at present most common in those countries where horses are worst managed, and fed almost exclusively on coarse, indigestible, or innutritious kinds of hay and beans.

Treatment.—The treatment of B. W. is very unsatisfactory; and we can only hope for palliation of the symptoms by keeping the alimentary canal in proper order, administering occasional purgatives, and feeding on a proper quantity of the best oats, which should always be bruised; also allowing the horse the best hay in spare quantities—viz., from 10 to 12 lbs. daily. Some veterinarians have vaunted their powers in curing this disease, and recommended large doses of camphor, digitalis, and opium; but these potent narcotics only operate for a very short time, and as their effects pass off, the symptoms return, and often with increased severity. We may say that B. W. is incurable; and horses very frequently drop down exhausted when at hard work, and die either from congestion of the lungs, hæmorrhage, or simple suffocation.

B. W. is so bad a form of unsoundness, that horse-dealers sometimes attempt, and even successfully, to hide the defect for the time they may be engaged in the sale of a horse, and this they do by causing the animal to swallow *shot* or *grease*. A certain portion of lead weighing in the stomach has a wonderful effect in diminishing the symptoms, which become again obvious enough a few hours after the ruse has been practised on some unwary purchaser.

BROKER (so called, from a Teut. and Slav. root, *brak* or *urak*, signifying refuse, blemish; as if the function had originally been to select good articles of merchandise and reject blemished ones: the German term is *mäkler*, from *makel*,

blemish), an agent employed to make bargains and contracts between other persons, in matters of trade, commerce, and navigation, for a compensation commonly called brokerage. Where he is employed to buy or sell goods, he is not intrusted with the custody or possession of them, and is not authorised to buy or sell them in his own name. In this respect, he differs from a factor, and he differs from an auctioneer in two particulars: a B. may buy as well as sell, but an auctioneer can only sell; a B. cannot sell personally at public auction, for that is the appropriate function of an auctioneer, but he may sell at private sales, which an auctioneer (as such) does not. A B. is strictly a middle-man, or intermediate negotiator between the parties, and for some purposes, he is treated as the agent of both parties, but primarily he is deemed merely the agent of the party by whom he is originally employed. There are several sorts of brokers, such as STOCK-BROKERS, SHARE-BROKERS, SHIP-BROKERS, INSURANCE-BROKERS, and BILL-BROKERS. See these special subjects under their respective headings. Persons who appraise goods, sell or distrain furniture for rent, are also called brokers, although differing entirely in their occupations from the preceding commercial agents. The business of a Pawnbroker (q. v.) is also of a different nature.

Brokers, in London, must be admitted by the lord mayor and aldermen, paying £5 on admission, and a like sum annually, under a penalty of £100. They are also required to take an oath, and enter into a bond for the observance of certain regulations. A B. who is not duly qualified cannot recover any compensation—6 Anne, c. 16; 57 Geo. III. c. 60.

By the fraudulent Trustees Act, the 20 and 21 Vict. c. 54, s. 2, it is enacted that any person, who, being a banker, merchant, B., attorney, or agent, and being intrusted for safe custody with the property of any other persons, shall in any manner convert or appropriate it to his own use, shall be guilty of a misdemeanour, and be liable to be kept in penal servitude for the term of three years, or to suffer such other punishment, by imprisonment for not more than two years, or by fine, as the court shall award. See FACTOR.

BROKERAGE is the remuneration or compensation allowed to a broker (q. v.).

BROMBERG, a town of Prussia, in the province of Posen, 69 miles north-east from the city of that name, is situated on the Brahe, about 6 miles from its junction with the Vistula. B. has manufactures of woollens, linen, chicory, tobacco, and Prussian blue; a large sugar-refinery, distilleries, breweries, potteries, and corn-mills. The *Bromberg Canal*, by uniting the rivers Netz and Brahe, connects the Oder and Elbe with the Vistula. Pop. about 10,000.

BROME-GRASS (*Bromus*; Gr. *bromos*, a kind of oat), a genus of Grasses, very nearly allied to FESCUE (q. v.), with flowers in lax panicles, glumes many-flowered, the outer palea bifid at the extremity, and awned beneath, and the very short stigma growing from the face of the germen, beneath its apex. The species are numerous, and some of them are very common British grasses—none more so than the **SOFT B.** (*B. mollis*), an annual or biennial, which has very soft downy leaves, grows well on poor soils, and is readily eaten by cattle, but is not much esteemed by farmers, either for the quantity or quality of fodder which it yields. Its seeds have also the reputation of possessing deleterious or poisonous properties: and those of two other species of this genus, *B. purgans* and *B. catharticus*, the former a native of North America, and the latter of Chili, are said to be emetic and purgative. The

whole subject of the existence of poisonous properties in the seeds of any of these grasses, requires further investigation. **SOFT B.**, although now disliked by farmers, was formerly sown as a fodder-grass, and its large seeds were even regarded as making hay more nutritious; so that there are some who view its present proscription as a thing which ought to be reconsidered, and who deem it not improbable that its weighty produce, both in foliage and seeds, and its adaptation to poor soils, may yet recommend it to the favour of agriculturists. Very similar to it are **SMOOTH B.** (*B. racemosus*), **FIELD B.** or **MEADOW B.** (*B. commutatus* or *B. pratensis*, and *B. arvensis*), all of which seem very much to resemble it in their properties.—The **TALL B.** (*B. giganteus*, also known as *Festuca gigantea* and *Bucetum giganteum*), a native of Britain, which reaches the height of four or even five feet, affords a great bulk of foliage, but is not much relished by cattle. Naturally growing in shady places, it succeeds even in dense woods, and is sometimes sown to form covert for game.—**RYE B.** (*B. secalinus*) is generally regarded as a troublesome weed, especially in fields of rye.



Rye Brome-grass (*Bromus secalinus*).

It is very abundant in some parts of Europe. In a young state it has a great resemblance to rye. Its seeds, which are large, retain their power of germination for years, and do not lose it by passing through the intestines of animals. Deleterious effects have been erroneously ascribed to bread made from rye, along with which these seeds have been ground; but poultry are very fond of them, as of those of other species of this genus.

BROMELIACEÆ, a natural order of monocotyledonous plants, allied to *Amaryllidaceæ* and *Iridaceæ*, stemless, or with short stems, and rigid, channelled, often spiny and scaly leaves. The flowers are in racemes or panicles; the calyx 3-parted or tubular, persistent, more or less cohering with the ovary; the petals three, withering or deciduous, equal or unequal, imbricated in bud. The stamens are six, inserted into the tube of the calyx and corolla, the anthers opening inwards. The ovary is 3-celled, the

BROMIC ACID—BRONCHI.

style single, the fruit capsular or succulent, many-seeded; the seeds with a minute embryo lying in the base of mealy albumen.—The order contains about 170 known species, all natives of the warmer parts of America, although some of them are now naturalised both in Asia and Africa. The best known plant of the order, and the only one much valued for its fruit, is the Pine-apple (q. v.). B., with their strong spiny leaves, cover the ground in many places, so as to form impenetrable thickets. Many of them are epiphytic, or grow upon trees, without being parasites, particularly the species of *Tillandsia*, one of which is the New Orleans Moss, Long Beard, or Old Man's Beard of the West Indies and of the southern parts of the United States, hanging from the trees like the lichens of colder climates. The leaves of some are so formed and placed as to retain near their base a quantity of water, often affording a delicious refreshment to the traveller in a hot climate. The water is, perhaps, of use to the plant itself in droughts. Not a few of the B. are capable of vegetating long without contact with earth, and of sustaining long drought without inconvenience, for which reason, and because of their beautiful and fragrant flowers, some of them are very frequently suspended from balconies in South America as air-plants. But the plants of this order are more generally valuable for their fibres than upon any other account. *Tillandsia usneoides*, the New Orleans Moss already mentioned, yields a fibre, easily obtained, and in great abundance, which is used instead of hair for stuffing mattresses. The fibres of the leaves of the pine-apple, and of some other species of this order, have been made into fabrics resembling the finest white muslin, whilst they are found also to possess sufficient strength for cordage. It is supposed that the produce of different species of *Bromelia* is often included along with that of the American Aloe or *Agave* (q. v.), under the name of *Pita* fibre or *Pita* flax, the appearance and properties of the fibres being very similar, as well as those also of the fibres of the species of *Yucca*. The fibre of the pine-apple is, in some countries, very frequently twisted into fishing-lines, and made into nets and into ropes intended for immersion in water, being very little liable to injury from this cause. Abundant as the plant is in its native regions, and now so perfectly naturalised as to form thickets in many parts of the old world, there seems no limit to the quantity of this fibre which might be procured.—The Pine-apple cloth of the Philippines is called *Pina muslin* and *Batiste d'ananas*. It is also sometimes erroneously called *Grass-cloth*. 'With a magnifier, the fibres may be seen to be very numerous and fine, but not twisted at all, as in grass-cloth or the finest muslins and cambrics.' The Philippine pine-apple fibre is obtained from a species called by the Spaniards *pigna* or *pina* (a cone), and which has by botanists been named *Bromelia Pigna*, although some regard it as a mere variety of the pine-apple, with small and rather dry fruit. It grows in great abundance in the Philippine Islands, and is cultivated by the Chinese near Singapore, and the fibre exported to China. This fibre is prepared also in Malacca, Java, Celebes, &c. When bleached, the pine-apple fibre can be spun like flax. A patent for this has been taken out in Britain by Mr Zincke.

The WILD ANANAS (*Bromelia Penguin*) of the West Indies, the *Bromelia Karatas*, common in South America, the *B. Sagenaria*, common in some parts of Brazil, and the *Billbergia variegata*, which grows in wild luxuriance in Mexico, where it is called *Caroa*, often covering miles of country—all yield fibres which are used for cloth, cordage, nets, &c. The

fibre of *Bromelia Sagenaria* is known as *Curratow* fibre. Very strong ropes are made of it.

The genus *Bromelia* has a 3-parted calyx shorter than the corolla, and the fruit is succulent. The species are pretty numerous, the leaves of all of them are more or less characterised by spiny serratures. The fruit of *B. Penguin*, already mentioned, affords a cooling juice, which is used in the West Indies mixed with water, to make a drink for patients in fever and dysentery. It is said to be diuretic. A vinous liquor is sometimes made from it.

BROMIC ACID is the only known compound of bromine and oxygen. It is prepared by acting upon bromine (Br) by caustic potash (KO), when much bromide of potassium (KBr) is formed, accompanied by bromate of potash (KOB₂O₆), a compound of potash and B. acid. It likewise combines with silver, lead, and mercury, yielding salts, all of which are styled Bromates.

BRO'MINE (Greek, *bromos*, disagreeable smell), one of the chemical elements, occurs in combination in sea-water to the extent of about 1 grain to the gallon. It is found more abundantly in certain saline springs, especially those at Kreuznach and Kissengen in Germany. It is also present in water and land-plants and animals. In the extraction of B. from concentrated sea-water, from which common salt has been separated in quantity, and which is then called *bittern*, or from salt springs, the liquor—which contains the B., as bromide of magnesium (MgBr)—has a stream of chlorine gas (Cl) passed through it, which forms chloride of magnesium (MgCl), and liberates the bromine. The liquid thus becomes of a more or less yellow tint, and if it be then agitated with ether, and allowed to settle, the latter floats up the bromine. The ethereal solution is then treated with potash, which principally forms bromide of potassium (KBr), and fixes the B., so that the ether may be distilled off. The residue is then treated with oxide of manganese and sulphuric acid in a retort with heat, which results in the liberation and distillation of pure bromine. It exists as a deep red liquid of density 2.966 (nearly 3), which readily evolves red fumes of a very irritating and suffocating nature. It is very poisonous, actually destroying the animal tissues. It is sparingly soluble in water, more so in alcohol and ether, and its water solution possesses great bleaching properties. When raised to the temperature of 145°-4 F., it boils, and reduced to 9°-5 F., it becomes a red crystalline solid. B. combines with great rapidity with the metals, occasionally with ignition, as with antimony, and forms a class of salts. Treated with hydrosulphuric acid, B. yields hydrobromic acid (HBr), which is the analogue of hydrochloric acid, as B. is of chlorine.

BRO'MSEBRO, a village of Sweden, in the län of Calmar, and 29 miles south-west of the town of that name. It is celebrated as the place where treaties were entered into between Sweden and Denmark in 1541, 1641, and 1645.

BRO'NCHI are the subdivisions of the trachea or windpipe. Opposite the third dorsal vertebra, the latter divides into two branches or B., of similar structure to itself—namely, round and cartilaginous in front; and flat, with muscular and fibrous tissue behind, lined with mucous membrane. Of these B., one goes to each lung, the right being little more than an inch; the left, about two inches in length. On entering the substance of a lung, the B. divide into smaller branches, which again subdivide, until they are no larger in diameter than one-fiftieth to one-thirtieth of an inch, which give origin to, or terminate in, small polyhedral cells, which seem to cluster round their extremities, and open into them.

These are the air-cells; they consist of elastic tissue, with a lining of mucous membrane, and beneath the latter, a layer of minute blood-vessels of the lung. See LUNGS and RESPIRATION.

BRONCHITIS, or inflammation of the lining membrane of the bronchial tubes, is a disease of very common occurrence in Great Britain, and one of the greatest importance, for, if neglected, it not only destroys life, but if carelessly treated, may lead to premature and miserable old age. The first symptoms are generally those which distinguish a common cold—viz., shivering, headache, and sense of weariness, with occasional cough; but the cough continues, and recurs in paroxysms; there is a feeling of oppression on the chest, and the person *wheezes* when he breathes. He also breathes more rapidly, six or ten respirations in the minute more than he did when in health, and his pulse is quicker; and the ear applied to his chest, after these symptoms have continued for two or three days, will hear a rattling, as if air was bubbling through thickish fluid, which is the case; he is breathing through an extraordinary amount of mucus secreted by the inflamed lining membrane of the tube. During his paroxysms of cough, this mucus is spit up. If the inflammation extend no further, it is termed *tubular B.*, and is seldom a fatal disease in the first attack; but, as may be expected, it will often extend, or, in some cases, begin in the small tubes—*vesicular B.*—when the symptoms just described will be present, but in a greater degree, the breathing being so embarrassed that the patient can no longer lie down, but requires to sit or stand up, and use all his muscles of respiration. Though he coughs, he spits very little, till about the third day, when he expectorates large quantities of yellow fluid. At last, prostration becomes so complete that he ceases to spit, and dies suffocated by the accumulated mucus, from the fifth to the seventh day. In less severe cases, or those which yield to treatment, the delicate tubes may be permanently injured by the inflammation. They may be thickened, which narrows their calibres; this will prevent the proper passage of the air, and gives rise to wheezing on any exertion, and cough, especially in winter. Moreover, after repeated attacks, one of the tubes may be blocked up entirely, so that the portion of lung to which it ought to conduct air, is no longer filled, and consequently collapses and wastes. This compels the adjacent tubes and air-cells to dilate to receive more air at the expense of their elasticity (*emphysema*, q. v.); the air-cells may even burst, and so by degrees the apparatus for aerating the blood becomes less and less perfect. The treatment of *B.* must vary with the patient's constitution; but in most cases, counter-irritation, applied through the medium of mustard or hot turpentine fomentations, will be found very useful. These remedies act more rapidly than a blister, and may be frequently repeated. It should be remembered that patients suffering from *B.* are very easily depressed. Such medicines as ammonia should be given, to promote expectoration, combined with the liquor ammoniæ acetatis, to produce perspiration. In very acute cases, after a brisk purge, salines, with ipecacuanha or squills, may be given, and an emetic will remove accumulations of mucus.

In the *B.* of old persons, chloric ether will be found very useful, and may be combined with sedatives, as henbane; but opium must be given with great caution, or not at all, as it tends to increase the congestion of the inflamed tubes. The paregoric elixir (compound tincture of camphor) is an old and popular remedy in *B.*, but enough has been said to impress on the reader the danger of tampering with bronchitis. In every case where it is possible, a

skilled medical man should be employed, to determine, by the stethoscope, not only the disease but its exact situation; and as it is but too likely to recur at some future period, or symptoms caused by it to appear, a skilled opinion has a permanent value to the patient. See CATARRH.

BRÖNDSTED, PETER OLUF, a learned antiquary, born near Horsens in Jütland, November 17, 1780. On completing his course of studies at the university of Copenhagen, he, in 1806, went to Paris, where he remained two years. He afterwards visited Italy and Greece, where he made excavations which furnished valuable materials for the study of classical antiquity. *B.*'s principal work is *Travels and Researches in Greece* (2 vols., Paris, 1826), a translation of which into French appeared at the same time. In addition to several smaller archaeological papers, amongst which was one in English, entitled *An Account of some Greek Vases found near Vulci* (Lond. 1832), and another on the bronzes of Siris, which appeared at Copenhagen, 1837, *B.* also wrote some valuable contributions to Danish history from Mediæval Norman Manuscripts (2 vols., Copenh. 1817—1818), and *Memoirs of Greece during the Years 1827 and 1828* (Paris, 1835).

BRONGNIART, ALEXANDRE, an eminent French chemist and naturalist, born at Paris in 1770, is said to have delivered a lecture on chemistry before he was 15. In 1790, he visited England for a scientific examination of the Derbyshire mines and pottery-works, and, on his return to France, published a *Mémoire sur l'Art de l'Émailleur*. Appointed in 1800 director of the porcelain manufactory at Sèvres, he held that office for the remainder of his life, and revived the almost lost art of painting on glass. In his *Essai d'une Classification des Reptiles*, 1805, he established the four divisions of reptiles, and first gave them the names of *Saurians*, *Batrachians*, *Chelonians*, and *Ophidians*. His *Traité Élémentaire de Minéralogie*, published in 1807, at the instance of the Imperial University, became a text-book for lecturers. In 1814 appeared his *Mémoire sur les Corps Organisés Fossiles nommés Trilobites*, a name which, as well as a basis of classification for those singular crustacea, naturalists owe to Brongniart. In 1815 he was elected a member of the Academy of Sciences of the French Institute; he was also a member of the Royal and Geological Societies of London, and of other learned bodies. In 1845, appeared his *Traité des Arts Céramiques*. He died 14th October 1847.

BRONGNIART, ADOLPHE THEODORE, son of the preceding, author of several botanical works held in high esteem, was born in 1801, and in 1834 was appointed professor of botany at the Jardin des Plantes, Paris, and member of the Academy of Sciences. In 1852 he was elected a foreign member of the Royal Society of London.

BRONI, a town of Sardinia, in the province of Alessandria, about 11 miles south-east of Pavia, in a beautiful situation at the foot of the Apennines. It has a singular old church, some portions of which date from the 10th century. In its vicinity is the castle of Broni, celebrated in history as the place where Prince Eugene obtained a victory over the French in 1703. Pop. 4558.

BRONN, HEINRICH GEORG, a German naturalist, was born at Ziegelhausen, March 3, 1800, and educated at Heidelberg University, where he devoted himself to the science of forests and natural history. In 1828, he commenced at Heidelberg a course of lectures on the physical and industrial sciences, and in 1833 was nominated ordinary professor of the same. After Leuckhardt's departure from Freiberg, *B.* was appointed to the zoological

lectureship. B. has written several important scientific treatises. His first was *A System of Antediluvian Conchylia* (Heidelberg, 1824), which was followed by *A System of Antediluvian Zoophytes*. In 1824, he visited the southern countries of Europe; and in 1827, made a second journey to Italy. On his return, he published the Results of his Journey (2 vols., Heidelberg, 1825—1830). In 1834 appeared his most important geological work—*Lethæa Geognostica*; in 1841—1849, his *History of Nature*; and in 1850, his *Universal Zoology*, which was the first attempt that had ever been made to develop zoology in its entirety with reference to extinct organisms.

BRO'NTÉ, a town in the province of Catania, Naples, situated at the western base of Mount Etna, about 22 miles north-north-west of the city of Catauia. B. has manufactures of woollen and paper, and the district produces oil, almonds, wine, &c. But the town is celebrated chiefly for its connection with Admiral Lord Nelson, who was created Duke of B. by the Neapolitan government in 1779, with an annual income of 6000 *oncie* (about £3750). Pop. 9150.

BRONTE, CHARLOTTE, one of the most distinguished of modern novelists, was born at Thornton, in the West Riding of Yorkshire, on the 21st of April 1816. Her father, a clergyman of Irish descent, removed, with six young children and an invalid wife, from Thornton to Haworth, in the same county, in 1821. Soon after their arrival, Mrs Bronte died, so that Charlotte, trying hard in after-life, could but dimly recall the remembrance of her mother. Her father, eccentric and solitary in his habits, and full of extravagant theories for making his children hardy and stoical, was ill fitted to replace a mother's love. When Charlotte was eight years old, she was sent with three of her sisters to Cowan's Bridge School, which, whether deservedly or not, had an unfortunate notoriety conferred upon it twenty-five years later in the pages of *Jane Eyre*. Her two eldest sisters falling dangerously ill, and dying a few days after their removal thence, and the low situation evidently disagreeing with Charlotte's health, she was sent home when little more than nine, and remained there, 'the motherly friend and guardian of her younger sisters,' till, in 1831, she was sent to Miss Wooler's school at Roe Head, where her remarkable talents were duly appreciated by her kind instructress, and friendships formed with some of her fellow-pupils that lasted throughout life. A few years later, she returned to Miss Wooler's school as teacher there, and also had some sorrowful experiences as governess in one or two families. It was with a view of better qualifying themselves for the task of teaching that Charlotte and her sister Emily went to Brussels in 1842, and took up their abode in a *penzionnat*. When Charlotte returned home in 1844, a new shadow darkened the gloomy Yorkshire parsonage. Her father's sight was declining fast, and her only brother was a source of continual anxiety. It now seemed plain that school-keeping could never be a resource, and the sisters turned their thoughts to literature. Their volume of poems was published in 1846; their names being veiled under those of Currer, Ellis, and Acton Bell, but it met with little or no attention. Charlotte's next venture was a prose tale, *The Professor*, and while it was passing slowly and heavily from publisher to publisher, *Jane Eyre* was making progress. In the August of 1847, it was submitted to Messrs Smith and Elder, and published by them two months later. It took the public by storm. It was felt that a fresh hand, making new harmonies, was thrown over the old instrument.

Henceforward, Charlotte B. had a 'twofold life, as author and woman.' Over the latter, the clouds closed thicker and thicker. Mr Bronte had indeed recovered his sight; but the sister Charlotte so intensely loved, and whose genius she ever delighted to exalt above her own, Emily—the Ellis Bell of *Wuthering Heights*—died in 1848. Her only brother also died in the same year; and Anne, the youngest of the family, following in 1849, Charlotte was left alone with her aged father in that dreary deserted home among the graves. Nevertheless, her energy never flagged. *Shirley*, begun soon after the appearance of *Jane Eyre*, was published in the autumn of 1849; and *Villette*, written under the frequent pressure of bad health and low spirits, came out in 1852. In the spring of 1854, Charlotte B. was married to her father's curate, the Rev. A. Nicholls, who had long known and loved her. It is a relief to find that a little bright sunshine was permitted to the close of a hitherto clouded life. It was, however, but brief; for serious illness set in, and on the 31st of March 1855 she died. A fragment of an unfinished novel appeared in the *Cornhill Magazine* for April, 1860.

BRONZE is a reddish-yellow, fine-grained alloy of copper and tin, in variable proportions. It was early known, and what is usually spoken of as *brass* in regard to the ancient nations, was in reality bronze. The brass or B. referred to in the Bible was probably composed of copper and tin, though some translators consider it likely to have been copper alone. The examination of the most ancient coins and metallic ornaments and implements leaves no doubt as to the acquaintance of the ancients with B.; so much so, that in the antiquarian history of European nations, there is a distinct period styled the *Bronze Period* (see next art.). At the present time, B. is largely used for house and church bells, Chinese gongs, ordnance or cannon metal, and speculum or telescope metal. In the preparation of the various kinds of B., great care must be taken to keep the tin from being burned away or wasted. To obviate this, it is customary to use much old B., as worn-out cannon, &c., and when that is fused in the furnace, to add the new copper and tin. The best Cornish and Banca tin are employed for the better kinds of castings, especially where strength of alloy is required. For inferior work, old scrap tin, which often contains lead, is used; and where strength of material is not an object, a little zinc and lead are added. In either case, during the fusion of the mixed metals in the furnace, at a high temperature, as little air as possible must be admitted to the furnace, otherwise the metals are oxidised, and the alloy is deteriorated. B., when well made, is, excepting gold, platinum, and some of the rare metals, the most durable metallic material with which we are acquainted; and this, coupled with its extreme hardness, rendering it difficult for time and ordinary wear and tear to efface inscriptions or medallions stamped on it, has led the mint in France, within the last few years, to issue a bronze coinage in place of copper; and at the present time (1860), arrangements are being made at the British mint for the issue of a bronze coinage.

The principal varieties of B. have the following average composition :

	Copper.	Tin.
Brass ordnance or bronze cannon,	9	1
Bronze for toothed wheels,	10	1
" for mathematical instruments,	12	1
" for bearings of machinery,	8	1
Chinese gongs and cymbals,	5	1
Musical bells,	6	1
House bells,	4	1
Large bells,	3	1

BRONZE.

Ancient.	Copper.	Tin.
Telescope or speculum metal,	2	1
Mirrors,	2	1
Hard bronze,	7	1
Medium bronze,	8	1
Soft bronze,	9	1
Flexible bronze nails,	20	1

Recently, B. has been deposited on small statues and other articles, in greater or less thickness, by the electrolytic process (see ELECTROTYPE), forming very pleasing ornaments at a cheaper rate than ordinary B. ornaments can be purchased for. The same process has been suggested for coating those parts of machinery which are liable to rust.

BRONZE, AGE OF (Dan. *Bronzealderen*), a term used by many modern archæologists to distinguish the second of the three successive periods into which, as they hold, the primitive or pre-historic antiquities of a country may be divided. They take for granted that among a rude or savage people, stone, being more easily fashioned, would come into use before any kind of metal; and that of metals, copper being oftener found ready for the hammer, would come into use before iron, which has generally to be smelted before it can be wrought. These assumptions—which, in so far, are only in accordance with what has actually been observed among uncivilised races—have obtained from a very early date. Lucretius, writing in the century before the Christian era, has recorded them with his usual vigorous precision :

*Arma antiqua, manus, ungues, dentesque fuerunt,
Et lapides, et item sylvarum fragmina rami :
Posterius ferri vis est ærisque reperta ;
Et prior æris erat quam ferri cognitus usus.*

De Rerum Natura, v. 1282.

Man's earliest arms were fingers, teeth, and nails, And stones, and fragments from the branching woods; Then copper next; and last, as later traced, The tyrant iron.—*Mason Good's Translation.*

More than one antiquary of the last century appears to have suggested the distribution of archæological objects into eras of stone, of copper or bronze, and of iron. But the proposed classification received scarcely any attention until about five-and-twenty years ago, when it was adopted and developed by Mr C. J. Thomsen, superintendent of the Ethnographical and Archæological Museum of Copenhagen, in his *Ledetraad til Nordisk Oldkyndighed* (Kjæbenhavn, 1836), and by Mr Nilsson, professor of zoology in the university of Lund, in Sweden, in his *Skandinaviska Nordens Urinvonare* (Lund, 1838—1843). According to the theory of these writers—which is held by almost all archæologists in Denmark, Sweden, and Norway, by many in Northern Germany and in Switzerland, and by a few in other parts of Europe—the first three stages in the progress of a nation from barbarism to civilisation are as clearly identified and defined by their relics of stone, of bronze, and of iron, as the comparative antiquity of geological strata, or periods of the world's creation, is determined by the fossils which they are found to contain.

The name of the 'age of stone' is given to the period when weapons and implements were made of stone, amber, wood, bone, horn, or some such easily wrought material, and during which very little or nothing was known of metals. During this era, the people, few in number, and savage in their habits, clothed themselves chiefly with skins of animals. They buried their dead in large sepulchral chambers, covered by what have been called *cromlechs*, or girdled round by the unhewn stone pillars called 'Druidical circles.' The bodies have most frequently been found unburned, and often with rude urns beside them.

During the 'age of bronze,' weapons and implements were made of copper or of bronze, and iron and silver were little or not at all known. The dead were burned, and their ashes kept in urns, or deposited in stone-chests, which were covered by conical mounds of earth or heaps of loose stones. In the urns, articles of gold and amber are found, but never of silver. Most articles of metal appear to have been cast; where marks of the hammer appear, it is contended that the forging or beating must have been by a stone hammer upon a stone anvil.

The 'age of iron' is the name applied to the third and last of the three supposed periods. During this era, it is conceived that iron displaced bronze in the manufacture of weapons and implements, and that silver and glass came into use. The dead were still occasionally burned; but they were frequently buried without burning, often seated on chairs, and, at times, with a horse in full war-harness laid beside the body of his master.

The Scandinavian and German antiquaries admit that their three periods run, more or less, one into another; that stone weapons continued to be used throughout the age of B.; that B. and gold were not unknown in the age of stone; and that weapons of stone and B. continued to be used in the age of iron. This admission obviously detracts very much from the practical value of the classification for chronological or other scientific purposes. But the late Mr J. M. Kemble, and other British antiquaries, have taken objections to the classification altogether, as irreconcilable with generally admitted facts, when carried out to its strict and necessary consequences. They point to the everyday discovery of objects of stone, B., and iron, in the same ancient urns, graves, and dwellings. They instance the case of the Huns, who had swords of iron, while they pointed their arrows with bones; the case of the Anglo-Saxons, who fought with stone mauls at Hastings; and the case of the Germans, who used stone-hammers in the Thirty Years' War. They shew stone weapons, in some of which the traces of metal are still fresh, while others attest for themselves that they could not have been cut but by a thin sharp metal point.* They prove from Greek and Roman writers that the nations of the north and west of Europe used iron weapons during what must have been their B. age. And they repudiate the proposed appropriation of different modes of burial to the different ages—a point on which the supporters of the theory appear to be hopelessly divided among themselves—on the ground, that graves assigned to the B. period have been found to contain more iron than B., and that other supposed characteristics of sepulchres of the B. age are quite as common in sepulchres of the iron age. But although the threefold classification of the Scandinavian and German archæologists cannot be relied upon for historical uses, it may be accepted as a very convenient mode of arranging archæological

* M. Frederic Troyon of Lausanne, one of the Swiss antiquaries who accept the three periods of their Scandinavian brethren, instances certain stone axes (now in the collection of Baron Renberg, at Prague), which were found, along with their cores, at the site of a primitive manufactory of these weapons in Bohemia. 'These cores,' he says, 'when replaced in the holes from which they had been taken (easily verified by the corresponding veins of the stone), left so little play-room, that it was evident they could only have been detached by a metal point, and not by a hollow cylinder, which could not have given to the hole its conical form, now quite apparent. Instead of the soft iron which is employed now-a-days in such operations, the ancients used copper or bronze; and, of course, water and silicious sand were likewise employed in the process.'

objects. It has been adopted, with some modifications, in the Gallery of British Antiquities in the British Museum at London, in the National Museum of the Antiquaries of Scotland at Edinburgh, in the Museum of the Royal Irish Academy at Dublin, and in other collections, where the articles are classed, for the most part, according to the materials of which they are made.

BRONZE-WING, BRONZE-WINGED PIGEON, and BRONZE PIGEON, names given in the Australian colonies to certain species of pigeon (see **PIGEON** and **COLUMBIDÆ**), chiefly of the genus *Peristera* of Swainson, on account of the lustrous bronze colour with which their wings are variously marked. They are otherwise also birds of beautiful plumage.—The **COMMON B.** or **Bronze-winged Ground Dove** (*Columba* or *Peristera chalcopetra*) is distributed over all the Australian colonies. It is often seen in flocks, feeds on the ground, and builds its nest chiefly on low branches of trees growing on meadow-lands or near water. It is a plump bird, often weighing fully a pound, and is acceptable at every table.—The **BRUSH B.** or **Little Bronze Pigeon** (*C.* or *P. elegans*) is not so plentiful nor so widely distributed, chiefly inhabiting Tasmania and the southern parts of Australia. It inhabits low swampy grounds, never perches on trees, resembles a partridge in its habits, and makes a loud burring noise like a partridge when it takes wing on being alarmed.—The **HARLEQUIN B.** (*C.* or *P. histrionica*) is found in the north-western parts of New South Wales in great flocks, feeding on seeds.—Some of the species of *Geophaps*, another of the genera or sub-genera of the *Columbidae*, are also sometimes called **Bronze-wing**. Their partridge-like appearance and habits have gained for them the name of **Partridge Pigeon** (q. v.).

BRONZING is the process of covering plaster or clay figures, and articles in ivory, metal, and wood, so as to communicate to them the appearance of ordinary bronze. Several of the materials employed are of little value, whilst others are expensive. Thus, *gold powder* is used for the finer work, and is prepared by grinding gold-leaf with honey on a stone slab till a very fine state of division is attained, then washing out the honey, and drying the gold powder. Inferior gold-leaf, or that which contains much silver and copper, yields the *German gold powder* employed in bronzing. *Copper powder* is prepared by introducing an iron bar or plate into a solution of copper, when the latter metal is precipitated as a finely divided red powder. *Mosaic gold*, or *musivum*, is made by fusing 1 lb. of tin, introducing $\frac{1}{2}$ lb. mercury, allowing the alloy or amalgam to cool, then pulverising and grinding up with $\frac{1}{2}$ lb. sal-ammoniac, and 7 oz. sublimed sulphur. Ultimately, the whole is subjected to the process of sublimation, when the tin, as a brilliant yellow powder, resembling gold, is left in the subliming vessel. The colour of mosaic gold may be deepened by the addition of red oxide of lead, and it then assumes a copper tint. *Gold size* is prepared by heating 1 lb. of linseed oil, and gradually adding 4 oz. of gum animi in very fine powder. When boiled sufficiently, it assumes the consistence of tar, and may then be strained through cloth. When employed in bronzing, some vermilion is added, to make it opaque, and turpentine, to make it thin and limpid enough to be easily laid on the plaster cast or other article with a brush, and the object may ultimately be rubbed over with soft chamois leather, which is occasionally dipped into the gold size. The other B. powders are best laid on with a solution of gum-arabic or isinglass, either of which acts as a cement. Gun-barrels are bronzed by acting upon them

with the chloride or butter of antimony (*bronzing salt*), or with hydrochloric or nitric acids, when the surface of the iron gets partially eaten into, and covered with a thin film of oxide; after which the gun-barrel is thoroughly cleaned, oiled, and burnished. A brownish shade is thus communicated to the barrel, which protects it from rust, and at the same time renders it less conspicuous to an enemy or to game. In the bronzing operation known as the *Damascus*, the barrel is treated with dilute nitric acid and vinegar, to which sulphate of copper has been added. The result is, that metallic copper is deposited irregularly over the iron surface; and when the latter is washed, oiled, and well rubbed with a hard brush, a very pretty appearance is communicated to the barrel. Articles in wood that require to be bronzed, are first coated with a mixture of size and lampblack, and dried, and then a bronze powder, consisting of very finely divided patent yellow, raw umber, pipe-clay, lamp-black, and Prussian blue, is put on with a brush. After being dried again, the article is burnished with cloth or leather, covered with a layer of Castile soap, and, lastly, cleaned up with a woollen cloth. Copper vessels, coins, &c., are bronzed by heating them in a copper boiler containing vinegar, with 2 parts of verdigris, 1 of sal-ammoniac dissolved in it, when, after sufficient boiling, a pleasant reddish-brown hue is imparted. Bronze and copper articles may have an antique appearance communicated by applying a solution of sal-ammoniac 1 part, cream of tartar 3, common salt 6, hot water 12, and more or less nitrate of copper, when an ancient greenish hue is obtained.

BROOCH (from a root signifying to pierce; comp. Eng. *to broach*; Fr. *brocher*, to spit, or to stitch; Wel. *proc*, to stab), an ornamental pin or instrument for fastening the dress, consisting for the most part either of a ring or disc, or of a semicircle, there being a pin in either case passing across it, fastened at one end with a joint, and at the other with a hook. Brooches were much used in antiquity, and varied in form as much as in modern times. They were worn both by men and women, and with a view both to ornament and use, from the time of Homer to the fall of the Western Empire. Nay, in the early portion of the middle ages, and even amongst semi-barbarous tribes, the art of making



Hunterston Runic Brooch.

fibula seems not only to have flourished, but to have attained marvellous perfection. Many of those found, both in Ireland and in Scotland, are wonderfully beautiful in workmanship, and still more so in design; and it is doubtful whether antiquity has left us anything in the way of personal ornament more perfect than the so-called Hunterston B., of which a wood-cut is subjoined. It was found in 1830, on the estate of Hunterston, in the parish of West Kilbride, Ayrshire, near to the scene of a conflict

which preceded the battle of Largs in 1262. It is of silver, richly wrought with gold filigree, and elaborately chased with lacertine and ribbon patterns. It is set with ornaments of amber; diameter, $4\frac{9}{16}$ inches. On the reverse are runes, which have been variously read. Dr Wilson says, 'what is decipherable reads in good Scottish Celtic into what he explains to mean—Malbritha, his friend, in recompense to Maolfridi.'—*Prehistoric Annals*. One of the most famous articles of the kind existing in Scotland is the *Brooch of Lorn*, in the

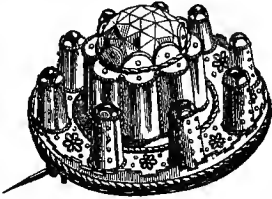

Brooch of Lorn.

possession of Macdougall of Dunolly, near Ohan. It is believed to be identical with one torn from the breast of Robert Bruce by Alexander of Lorn, the ancestor of Macdougall, in a personal contest with the king. This interesting article is of silver, about 4 inches in diameter, with a circle of jewelled obelisks.

BROOKE, HENRY, dramatist and novelist, was born in 1708, in the house of Rantavan, county Cavan, Ireland. His father was a wealthy clergyman. Young B. was first sent to school to one Felix Somerford, where he so distinguished himself that his tutor, in the fulness of his heart, prophesied that he would play a great part in life. His talent for rhyming first made itself evident here, and it received further development while he resided at Dr Sheridan's school in Dublin. In 1724, he went to study law in London, and became the chosen friend of Pope and Lyttleton. From the heart of this brilliant literary society he was recalled to Ireland by a dying aunt, who left him guardian of her child, a girl of twelve. B. put the child to a Dublin boarding-school, and married her secretly two years thereafter. Four or five years subsequently, when his wife had born him three children, he removed to London, and once more became a bright particular star in the galaxy of metropolitan genius. In London, he published a poem, entitled *Universal Beauty*, which Pope admired, and of which he perhaps turned a couplet here and there. Shortly after, B. returned to Ireland; but in 1736 he was again in London, and was introduced to the Prince of Wales, who cultivated his friendship, and made him presents of books and china. About this time, he published his play, entitled *Gustavus Vasa*, full of the noblest sentiments, and the most inconceivable characters. In 1740, B. was taken ill, and returned to his native country, where he published several books, and a tragedy, *The Earl of Westmoreland*, which was performed in Dublin. In his later years he removed to Dublin, and died there in 1783. The sonorous eloquence of his plays has not saved them from oblivion; and his novel, entitled *The Fool of Quality*, is the only work of his which is likely to meet the eyes of modern readers. It was originally published in five volumes, and was greatly admired by John Wesley. A new edition was published in 1859, with a preface by the Rev. C. Kingsley.

BROOKE, SIR JAMES, Rajah of Sarawak,

and Governor of Labuan—a man strongly imbued with the spirit of the old adventurers of the Elizabethan time—was born in Bengal in 1803. Being educated in England, he early entered the East India army, was seriously wounded in the Burmese war, and returning home on furlough, spent some time in travel on the continent. Shipwrecked on the voyage out to join his regiment, he was unable to reach India before his furlough had expired; his appointments consequently lapsed, and he quitted the service. He now conceived the idea of putting down piracy in the Eastern Archipelago, and of carrying civilisation to the savages inhabiting these islands. He purchased a yacht, which he manned with about twenty sailors, and after a three years' cruise in the Mediterranean, to test the sea-worthiness of his vessel and the seamanship of his crew, sailed from London for Sarawak, a province on the north-west coast of Borneo, October 1838. When he arrived there, Muda Hassim, the uncle of the sultan of Borneo, was engaged in a war with some rebel tribes. B. lent his assistance, and in return had the title of Rajah and Governor of Sarawak conferred upon him, the native governor being forced to resign. B. immediately set about reforming the government, instituted free trade, and framed a new code of laws. The murderous custom of head-hunting, prevalent among the Dyaks, he declared to be a crime punishable with death, and vigorously set about the extirpation of piracy. This was done so draconically as to occasion a very great deal of dissatisfaction in this country; and the result was, that parliament abolished the 'head-money' that had been previously paid for the slaughter of pirates, and which B. and those associated with him had claimed and received to the extent of £20,000. Certain charges, however, brought against B. in the House of Commons, in connection with this matter, were declared by a Royal Commission to be unsubstantiated. On his return to England, B. received a warm welcome, was made a D.C.L. of Oxford in 1847, created a Knight Commander of the Bath in the year following; and the island of Labuan, near Sarawak, having been purchased by the British government, he was appointed governor and commander-in-chief, with a salary of £2000 a year. In 1857, B., who had been superseded in the governorship of Labuan, but who still acted as Rajah of Sarawak for the sultan of Borneo, was attacked at night in his house by a large body of Chinese, who were irritated at his efforts to prevent opium-smuggling, and only escaped with his life by swimming across a creek. The Chinese committed great havoc on his property, but their triumph was short-lived. B. collected some natives, attacked the Chinese, defeated them in several successive fights, and ultimately forced them into the jungle, where they must have perished of starvation. Upwards of 2000 Chinese were killed, and all their flourishing settlements destroyed. Returning to England soon after this, B. has lectured in several of the chief towns on the advantages likely to result to this country from a possession of Sarawak, and urged the desirableness of the British government taking it under its protection, as otherwise it was likely to fall into the hands of the Dutch. To enforce this view, an influential deputation waited upon the Earl of Derby (then head of the government) in November 1858, but he declined to entertain it. Regarding the motives and the policy of B. in connection with Sarawak, opinion is greatly divided, but the fact cannot be disputed that the town has greatly prospered under his régime. He found it a place of some 1000 inhabitants, he left it a town of 25,000; and the exports to Singapore, which, on his instalment as ruler, amounted to some £25,000, were in 1858 about £300,000. B. is

still (1860) in England, broken in health, his nephew governing Sarawak in his stead.

BROOKLIME (*Veronica Beccabunga*), a species of Speedwell (q. v.) abundant in ditches, water-courses, and wet places near springs in Britain, common also in most parts of the continent of Europe. It is a perennial plant, with procumbent stems, rooting at the base; the leaves on short stalks, elliptical, obtuse, and slightly serrate, both stems and leaves smooth and very succulent; the small blue flowers, in form resembling those of the other Speedwells, in racemes, the stalks of which arise from the axils of the opposite leaves. The leaves and young shoots have a bland or a slightly bitter taste, and are a tolerable ingredient in spring salads. They are sometimes sold along with water-cresses.—See **CRESS, WATER**.—In Scotland, the plant is called *Water Purpie*.

BROOKLYN, a city at the west end of Long Island, in the United States, belonging to New York state, in lat. 40° 42' N., 73° 59' W. B. is one of the five socially united municipalities which encircle the basin formed by the junction of Long Island Sound and the Hudson—the central emporium of New York city on the island of Manhattan, with two suburbs on Long Island, and two in New Jersey. It stands at the south-west extremity of Long Island Sound, which is here appropriately known as East River, partly in allusion to the narrowness of its channel and the rapidity of its tide, and partly in contradistinction to North River as a second name of the Hudson. Between B. and New York there are numerous ferries of about three-quarters of a mile in width, on which ply steam-boats every few minutes by day, and every half-hour by night. In 1850, the population was 96,838, having been 36,233 in 1840, and 15,396 in 1830. B. was founded by the Dutch in 1625, and is thus several years older than Boston; and in 1776, its neighbourhood was one of the principal seats of the revolutionary war. Occupying comparatively elevated ground, B. commands a complete view of the adjacent waters and their shores, while, notwithstanding its inequalities of surface, it consists chiefly of straight streets, crossing each other at right angles. It is divided into wards, and governed by a mayor and a board of aldermen. B. has about 70 churches, several flourishing hanks, various literary institutions, and numerous seminaries of education—an ample share, in short, of all that characterises a wealthy, populous, and intelligent community. It possesses also a national navy-yard, which embraces 40 acres of land, while to a private company it owes a wet-dock for the largest vessels, the most extensive in the Union.

BROOM, a name given to a number of species of shrubs of the closely allied genera *Cytisus*, *Genista*, and *Spartium*, of the natural order *Leguminosæ*, sub-order *Papilionaceæ*—all of them having long slender branches, along which are produced axillary flowers. The genera differ in the form of the standard (see **PAPILIONACEOUS FLOWERS**), which is roundish in *Spartium*, broadly ovate in *Cytisus*, and oblongo-ovate in *Genista*, whilst *Spartium* has also an acuminate keel, and that of *Cytisus* is very obtuse, that of *Genista* being oblong, and not wholly including the stamens and pistil. The legume is many-seeded in all, the calyx 2-lipped, and the filaments united in a tube.—**COMMON B.** (*Cytisus scoparius*, the trivial name being from the Lat. *scopa*, long twigs, or a besom)—which has by different botanists been ranked in each of the genera just named, although it possesses the characters above assigned to *Cytisus*, but has recently been made the type of a new genus, under the

name of *Sarothamnus scoparius*, or *communis*—is a well-known native of Britain and of the continent of Europe, growing in dry soils, and ornamenting hedge-banks, hills, and bushy places, in May and June, with its large yellow flowers, which are on short stalks, drooping, solitary, but produced in considerable number along the straight slender branchlets. The whole aspect of the plant is graceful. The lower leaves have three oblong leaflets, the upper ones, or bracts, are simple; the branches are angular and of a very dark green, very tough, and much in use for making besoms. They have also been used for tanning and dyeing; and their fibre has been woven into a coarse strong cloth, and even made into paper. The whole plant is



Common Broom :

a, flowering branchlet; b, end of branchlet, not flowering, showing leaves with three leaflets; c, a pod; d, the tube of stamens out open.

very bitter, with a peculiar nauseous taste and smell when bruised. The young tops and seeds are used in medicine, being powerfully diuretic, and very beneficial in some kinds of dropsy. They are also mildly laxative, and in large doses emetic. They are commonly administered in the form of a decoction. B. inhabits colder climates than furze, reaching to a greater elevation on mountains, and being found beyond the northern limit of furze. It varies in size from a very humble shrub to one of 20 or even 30 feet in height, and when it reaches this size, the wood is of great value for the finer purposes of cabinet-makers and turners.—**IRISH B.** (*Cytisus* or *Sarothamnus patens*), not unfrequent as an ornamental plant in British shrubberies, is not at all a native of Ireland, but of Spain and Portugal.—**PORTUGAL B.** or **WHITE B.** (*Cytisus albus*), a native of the countries bordering on the Mediterranean, is very often planted in Britain as an ornamental shrub, and is much admired for the beauty of its fascicled white flowers, which are produced upon long filiform branches. Its leaves have three leaflets. It sometimes attains a height of 15 or 20 feet.—**SPANISH B.** (*Spartium junceum*) is

a native of the south of Europe, generally growing in dry soils and rocky situations, and attaining a height of 8 feet or upwards. Its branches are upright, round, and rush-like, a characteristic of this genus. They are smooth, and bear only a few small simple leaves, which soon drop off. The fibre of the branchlets is much used in some parts of Italy, France, and Spain, for making cloth, ropes, &c. In the south of France, the plant is cultivated on dry unproductive soils. The branchlets are made into bundles, dried, beaten, steeped, and washed, in order to the separation of the fibre: It possesses medical properties similar to those of the common broom.—A white-flowered species (*S^o monospermum*), occasionally to be seen in British shrubberies, grows abundantly on the loose sands of the coasts of Spain, and produces a similar fibre. It is mentioned by Barth as growing in great abundance in Africa to the south of the Great Desert. Many species somewhat resembling these are occasionally to be seen in Britain among ornamental plants, some of them often in greenhouses. The Canary Isles produce some remarkable for the fragrance of their flowers. The name B. is not given to those species of *Cytisus* (q. v.) and *Genista* (q. v.) which do not display in a marked degree the character of having long slender twigs.—**BUTCHER'S B.** (q. v.) is a plant of an entirely different family.

BROOMRAPE. See **OROBANCHEÆ.**

BRO'RA BEDS are a series of strata occurring at Brora, a village in Sutherlandshire, of the same age as the inferior oolite of Yorkshires. They are chiefly remarkable for the occurrence in them of a seam of coal of good quality 3½ feet thick, being the thickest stratum of true coal hitherto discovered in any secondary strata in Britain.

BROSSES, CHARLES DE, a learned French historian, was born at Dijon, February 8, 1709. His first work was *Lettres sur l'Etat de la Ville d'Herculanum*, the result of a tour through Italy in 1739. At the suggestion of his friend Buffon the naturalist, he wrote the *Histoire des Navigations aux Terres Australes* (1756), in which he described the supposed great southern continent under the several names Magellania, Australia, and Polynesia. The last two of these names, now commonly used, were first employed by Brosse. His next work was *Du Culte des Dieux Fétiches*, &c. (1760). It was followed by a *Traité de la Formation Mécanique des Langues* (1765), which, in spite of many errors, contains not a few novel and ingenious observations and conjectures. During the greater part of his life, B. was occupied in endeavouring to supply the lacunes in the works of Sallust; and having collected about 700 fragments by this historian, he published, with such interpolations as he deemed necessary, the *Histoire de la République Romaine dans le cours du Septième Siècle, par Salluste* (1777). B. died as president of the parliament of Burgundy, May 7, 1777. His letters from Italy, under the title *Italie il y a cent Ans*, were edited and republished by his son René, Count de Brosse, in 1834.

BROTH is an infusion or decoction of vegetable and animal substances in water. It is customary to use more or less meat, generally ox-flesh, with bone, and certain vegetables, as cabbage, greens, turnips, carrots, pease, beans, onions, &c. The whole are mixed together in cold water, heat slowly applied, and the materials allowed to simmer for some hours. The meat yields up certain ingredients, whilst others are retained in the residual flesh. The following table will illustrate this.

Ox-flesh heated with water

Yields to the Water.
Albuminous matter.
Gelatine.
Creatine.
Extractive matters or
Osmazome.
Lactic acid.
Salts.
Fat.
Saccharine matter.

Leaves in the Boiled Meas.
Fibrin.
Coagulated albumen.
Gelatinous tissue.
Fat.
Nervous matter.

The vegetables yield albuminous constituents, colouring and mucilaginous matter, and volatile oils and salts.

The real nutritive material present in broth is less than is generally thought, though it aids in satisfying the cravings of the appetite. To invalids, however, the form of broth known as Beef-tea (q. v.) is of great importance, as it affords the weak and sickly stomach a light palatable article of diet at a time when stronger food would do the weakened system much harm. See **NUTRITION.**

BROTHERHOODS, RELIGIOUS. These were societies instituted for pious and benevolent purposes, and were numerous in the middle ages. Their origin is probably to be traced to the desire which then prevailed to imitate the spiritual orders. They were usually founded at first without ecclesiastical authorisation, on account of which, several of the confraternities that either did not seek or did not obtain the recognition of the church, assumed the character of sects, and were suspected of heresy. To this class, among others, belonged the Beguines and Beghards (q. v.), the Brothers and Sisters of the Free Spirit (see below), the Apostolic Brethren (q. v.), the Flagellants (q. v.), who, tolerated by the church for a while, at last incurred its displeasure, and were severely persecuted. We may also reckon among religious B. the old building corporations, from which sprang the order of Freemasons, the religious character of whose secret societies indicated, in the opinion of the church, a peculiarly dangerous gnosis and symbolism. Others coming into existence under ecclesiastical oversight, or at least being confirmed by the church, had no *arcana*, but were simply dedicated to the promotion of religion, either by the imposition of new penances, the acceptance of new and severer devotions, or the assisting of strangers, travellers, the unprotected, the oppressed, the destitute, and the sick. Nor can we refuse our admiration and approbation to such self-denying fraternities, when we remember how defective were the early communities in charitable institutions. They were most numerous in Italy, Rome alone boasting more than a hundred.

BROTHERS AND SISTERS OF THE FREE SPIRIT, a sect which sprang up in the Rhine country during the 13th c., and afterwards spread into France and Italy. It grounded its peculiarities on the biblical doctrine, that the Holy Spirit is a spirit of 'freedom.' Misunderstanding the true nature of spiritual freedom, the members of this sect conceived themselves released not only from the thralldom of the church, but also from the obligations of morality. They set aside the marriage-tie, and indulged in licentiousness. A few even maintained that the deeds of the body could not possibly affect the soul. Intellectually, they are said to have been given to Pantheism. The synods of Cologne in 1306, and of Treves in 1310, decreed their suppression, and in the persecutions which ensued, they appear to have been completely dispersed.

THE BRETHEREN OF SOCIAL LIFE, BRETHEREN OF THE COMMON LOT, OR BRETHEREN OF GOOD WILL (also called **HIERONYMITES** and **GREGORIANS**, from

Hieronimus and Gregory the Great, whom they claimed as patrons), a fraternity founded about 1376 by Geert Groote (b. at Deventer, 1340—d. 1384), and Florentius Radewin (b. 1350, at Leerdam, in South Holland—d. 1400). This society—which professed to be a copy of the earliest Christian communities, and was in several respects a forerunner of the subsequently formed societies of United Brethren, now sometimes styled Moravians—was composed of persons who sought after pious and spiritual exercises without any conventional distinctions of order, &c. Community of goods, ascetic habits, industry, care of the education of young persons, and the use of the vernacular language in divine service, were some of the chief points insisted on by the brethren, who were not fettered by monastic or any other vows. Perfect community of goods was a rule of their societies. Despite the persecutions which they suffered from the mendicant friars, they were recognised and sanctioned by several popes and by the Council of Constance. They became most numerous in the Netherlands and North Germany, but also spread themselves in Italy, Sicily, and Portugal, so that, in 1430, they reckoned more than 130 societies. The last was founded at Cambray in 1505. Several brotherhoods of Gregorians assisted in the Reformation. In other cases, their institutions fell into the hands of the Jesuits. Though the original founders of these societies were opposed to all learning and science which was not purely moral and practical, their followers rendered most important services to popular education, having free schools in connection with many of their houses, supporting students at other schools, and distributing useful books. They have, indeed, been not incorrectly described as pioneers of the Reformation. After the revival of learning in Italy, the Brethren of Social Life entered into the spiritual activity of the time. The most important and distinguished members of the society were Gerhard Zerbold of Zütphen, Thomas à Kempis, and the learned Cardinal Nicholas Cusa.—Female societies, of a similar character, sprung up at the same time with those of the Brethren of Social Life. At the head of each was a superior or directress, who was styled the *Martha*.

BROTHERS, a name given to a group of six or eight rocky islets immediately outside the Strait of Bab-el-Mandeb, varying in height from 250 to 350 feet. They lie off the African coast about 9 miles south of the island Perim, now occupied by England. Of the loftiest point, the lat. and long. respectively are, 12° 28' N., and 43° 22' E.—Brothers is also the name given to three isolated mountains near the coast of New South Wales, between Harrington Inlet to the south, and Port Macquarie to the north, or between lat. 32° and 31½° S. They are valuable as landmarks.

BROTHERS, LAW OF DESCENT AMONG. In the law of England, this was immediate, without reference to the parent as the *commune vinculum*; but by the 3 and 4 Will. IV. c. 106, s. 5, it is enacted that no brother or sister shall be considered to inherit immediately from his or her brother or sister, but every such descent shall be traced through the parent. See **INHERITANCE**.

BROTHERS, LAY, an inferior class of monks, not in holy orders, but bound by monastic rules, and employed as servants in monasteries (q. v.).

BROTHERS AND SISTERS OF CHARITY. Under these names, there exist in the Roman Catholic Church two widely ramified beneficent societies, for the nursing of the poor and sick in hospitals, without distinction of faith, rank, or nation. The order of the Brothers of Charity, or Compassionate

Brothers, was established in 1540, at Seville, in Spain, by the Portuguese John di Dio (died 1550), who had served in Africa under Charles V. The funds for the purpose were obtained by begging. The primitive object of the society was the care of the sick, and the reformation of women of immoral character: it was composed of lay-members, under no rule. In the year 1572, the order received the papal recognition, and was subjected to the rule of St Augustine. All the privileges of the mendicant orders were conceded to it in the year 1624, and it was then divided into a Spanish congregation, with a major-general in Granada, and an Italian or extra-Spanish congregation, with a major-general in Rome. To the latter belong also the Brothers of Charity in Switzerland, Germany (where Austria is their chief seat), Poland, the Netherlands, France, and other countries. The European members of the order clothe themselves in black; the extra-European, who are under a separate general of their order in America, wear brown. Their services to distressed humanity continue to be held in high estimation. The Sisters of Charity, formerly also, on account of their dress, called *Gray Sisters*—independent associations of unmarried Christian females, for the alleviation of human suffering, especially for the tending of the sick and the poor—were first called into existence in France, in 1634, by Vincent de Paul (born 1576), greatly assisted by the noble-hearted and self-devoted widow, Le Gras, by birth De Marillac. The society was recognised in 1655 by Clement IX., and in 1685 already numbered 224 convents. The French Revolution sorely interrupted the abundant and benevolent labours of the Sisters of Charity by the suppression and proscription of their convents in France; but Napoleon restored the order in 1807 by the convocation of a General Chapter of the scattered sisters, under the presidency of the Empress Mother, and by the grant of the necessary funds; and there exist at present more than 300 associations in France, where, in the villages, elementary education is in great part conducted by them. They attend the sick in all the great hospitals. There exists in Germany a Roman Catholic association of unmarried females, not bound by conventual rules, and possessing the right of withdrawing from the association at pleasure, but placed under a strict supervision, and occupied in the same duties as the Sisters of Charity. The Institute of Deaconesses (q. v.) in the Protestant churches of the continent of Europe is of a very similar character.

BROTHERS, RICHARD, a fanatic, whose prophecies and writings excited an unusual sensation in his day, was at one time a lieutenant in the British navy, which he quitted in 1789. Refusing, from conscientious scruples, to take the requisite oath to enable him to receive his half-pay, he was reduced to great distress, and ultimately placed in the workhouse. Dating his first call from 1790, he announced himself, in 1793, the apostle of a new religion, 'the Nephew of the Almighty, and Prince of the Hebrews, appointed to lead them to the land of Canaan.' In 1794, he published a book, in two parts, entitled *A Revealed Knowledge of the Prophecies and Times, &c.*; and, in 1795, an *Exposition of the Trinity*. He was the author of several other publications, marked by a strange mixture of reason and insanity. In consequence of prophesying the death of the king, and the destruction of the monarchy, he was committed to Newgate, but soon liberated. Some of his political predictions, especially in reference to the state of the continent, were either altogether or partially fulfilled; and many persons were induced to sell their goods, and prepare to accompany him to his New Jerusalem,

which was to be built on both sides of the river Jordan, where he was to arrive in the year 1795. His disciples were not confined to the poor and ignorant, but even men of ability and education were deluded into believing in him, two of the most eminent being Nathaniel Brassey Halhed, Esq., M.P., the orientalist, and Sharp, the celebrated engraver. As a dangerous lunatic, he was at length, by order of government, committed to Bedlam, but released April 14, 1806, and died January 25, 1824.

BROUGHAM, HENRY, LORD BROUGHAM AND VAUX, was born in Edinburgh, 19th September 1778. His father, Mr Henry Brougham, was the descendant of an ancient family in Westmoreland, and his mother, Eleonora Syme, who was a woman of much talent, was a niece of Robertson the historian. B. received his education at the High School, and afterwards at the university, of Edinburgh. He gave early promise of future ability, some mathematical papers written by him at the age of eighteen having been considered worthy of publication in the Transactions of the Royal Society. He spent some time in travelling on the continent, and in 1800 was admitted to the Scotch bar. In company with Jeffrey, Horner, and Sydney Smith, B.'s first public efforts were given to the service of the *Edinburgh Review*, and he contributed to it some of its most powerful articles. His liberal political views excluded him from the hope of promotion in Scotland, and a character which he had acquired for eccentricity and indiscretion, excluded him from all legal practice, except the unremunerative practice of the criminal courts. After seven years of vain attendance in the courts at Edinburgh, he betook himself to a field more worthy of his ambition, and in 1808 passed at the English bar.

In London, B. first attracted public notice by the admirable appearance he made at the bar of the House of Commons, when he was employed on behalf of certain Liverpool merchants to ask the repeal of the Orders in Council. Soon after this, in 1810, he entered parliament, and within a few months of the time of taking his seat, brought in and carried his first public measure—an act making participation in the slave-trade felony. He was welcomed by the opposition leaders, to whose party he had attached himself, as a most powerful assistant in their attacks upon the government. B. succeeded in carrying the repeal of the obnoxious Orders in Council shortly before the general election of 1812, and then ventured to contest, along with another Whig, the membership for Liverpool against Canning and another Tory. He was defeated, and remained without a seat in parliament till 1816, when he was returned for Winchelsea, and again became an active member of the opposition. By this time he had also established some reputation in the courts of law. He never, indeed, acquired a very large practice, but he repeatedly distinguished himself by speeches of great vigour and ability in the defence of persons prosecuted for libel by the crown. His most famous appearance as an advocate, however, was in defence of Queen Caroline, when, along with Denman, he defended the injured queen with unequalled courage and disinterestedness, at the cost, as both well knew, of exclusion, for years to come, from all professional advancement. But his eloquence and boldness, though they forfeited for him the favour of the crown, gained him that of the people, and for the ten years between 1820 and 1830, B. was the popular idol. He made no bad use of his power. In 1822, he used it, though in vain, in support of a scheme of national education; and to his activity

is owing, in great measure, the establishment of the London University, of the first Mechanics' Institute, and of the Society for the Diffusion of Useful Knowledge. In 1830, B. delivered a most powerful speech against slavery, and in consequence of it—as he himself believes—was invited to stand, and returned, as member for the great popular constituency of the county of York. The aristocratically disposed Whigs would—had they dared—have excluded B. from the Reform ministry; but, in addition to having enormous popularity, he was virtually their leader in debate in the Commons, and was thus, in spite of his unmanageableness, indispensable. After various intrigues, B. was offered, and was persuaded, against both his interests and his inclinations, to accept a peerage and the chancellorship. He took his seat in the Lords in November 1830, and assisted very materially in carrying through that House the great measures then proposed by the liberal ministers. He shared in the general unpopularity which afterwards attached to them, and when they were dismissed by William IV. in 1834, B. left office, never to return to it. Since that time, he has held in the Upper House a position as nearly analogous as may be to that formerly held by him in the Commons, criticising freely the conduct of successive administrations, and steadily forwarding every measure for social progress.

It will be as a law-reformer that B. will be best remembered. He took up Romilly's uncompleted task, of carrying into practice the ameliorations suggested by Bentham. His efforts in this direction began as early as 1816, when he introduced into parliament a bill to remove various defects in the law of libel. In 1827, in a memorable speech which occupied six hours in delivery, B. enumerated the defects in nearly every branch of English law, and made proposals for dealing with law-reform on a proper scale. These, as might have been expected, met with little encouragement. It has been the fortune of many of his measures to be carried afterwards, in a mutilated form, by other hands. After he left office, B. also succeeded in carrying various reforms in the law, among which may be noted some very extensive changes in the law of evidence. Among the measures proposed by B., but left for future law-reformers to carry, were bills for the codification of the criminal law, for the establishment in England of a system of public prosecutors, and for the giving of compensation to parties acquitted. Lord B.'s acts and bills, as well those regarding the slave-trade, education, and other public questions, as those touching on law-reform, have been collected and published by Sir J. E. Eardley Wilmot (London, Longman, 1857). The large well-filled volume which they form is the most fitting monument that could be preserved of the activity, perseverance, and public spirit of the man.

As an orator, more especially as a debater in parliament, B. was, among the men of his time, inferior only to Canning. He was wont, however, to indulge in his speeches in too large an admixture of exciting elements: argument was mingled with fiery declamation; ridicule, sarcasm, invective, were freely used; and these he dealt out with a vehemence and energy that at times carried him far beyond bounds. The power of ready, rapid, and forcible diction was eminently his. In many other fields besides oratory, B. has won a high reputation. He has cultivated mathematical and physical science with success, and has ventured upon the domain of metaphysics, and even of theology. His miscellaneous writings are of great extent, and upon an almost incredible variety of subjects. They were, however, intended more to serve

purposes of the moment, than as permanent additions to our literature; and though they display great powers of rapid comprehension and nervous clear exposition, it cannot be said that we are indebted to their author for any new truths in politics or morals, or any original discoveries in science. The honours due to men of letters B. has not failed to acquire, having successively been made Lord Rector of Glasgow University, President of University College, London, Member of the Institute of France, Chancellor of the University of Edinburgh, and lastly, D.C.L. of Oxford.

Lord B. took a warm interest in legal and social reform. While not engaged in parliament, he resided chiefly at Cannes, in the south of France, where he died, May 7, 1868. His lordship married, in 1819, Mary Anne Eden, the granddaughter of a baronet in the county of Durham. The issue of this marriage was two daughters, one of whom died in infancy, and the other before reaching womanhood. The patent of the title was extended, so as to make the peerage descend to the family of a brother of Lord Brougham.

BROUGHTY-FERRY, a village of Forfarshire, on the Firth of Tay, 4 miles east of Dundee. Pop. 2772. It is connected by a railway-ferry over the firth, here a mile broad, with Ferry-Port-on-Craig, in Fifeshire; by which communication the Dundee and Arbroath and the Edinburgh, Perth, and Dundee Railways are brought into conjunction. It is a watering-place, and has cod and other white fisheries. On the shore stands an ancient castle, long in ruins, but lately repaired as a means of defence for the entrance to the river Tay.

BROUSSA, or **BOURSA**, the ancient *Prusa*, where the kings of Bithynia usually resided, situated in lat. 27° N., long. 40° E., at the foot of Mount Olympus, in Asia Minor. Prusa is said to have been built by Prusias, king of Bithynia, who waged war with Cressus or Cyrus. Seifeddulat, of the race of Hamadan, took it in 336 of the Hegira, but it was retaken by the Greek emperor in 947 A. D. In 1356, Orcan, son of Othman, the second emperor of Turkey, captured it, and made it the capital of his empire, and it continued so until the taking of Constantinople by Mohammed II. in 1453.

B. is most pleasantly situated, facing a beautiful and luxuriant plain, covered for many miles with plantations of mulberry-trees. The city and suburbs are about six miles in circumference. The town is divided from the eastern suburb by a deep channel or vale, over which there are several bridges, one of them—with shops on each side—being 90 paces long and 16 broad. The streets are remarkably clean, and the bazaars very good, being supplied with European goods from Constantinople. The population of B. is estimated at 85,000 souls, of whom about 2500 are Armenians. It contains a great number of mosques, some of which are very fine buildings. The silks of B. are much esteemed in the European markets, and great quantities are exported every year to France, Constantinople, and Smyrna. The inhabitants manufacture a kind of silk, like satin, mostly striped, which is used for the under-garment of the oriental dress; also a material from silk and flax used chiefly for shirts; and a sort of gauze, called 'brumjuck,' which is much worn by the Turkish ladies for under-garments. A great quantity of British manufactured goods, such as Manchester 'twists,' 'gray calicoes,' 'prints,' 'zebras,' &c., are imported into B., the goods being landed at Constantinople, and thence conveyed overland to Broussa. It is the official residence of a Turkish pasha, and the seat of a Turkish tribunal. B. is subject to frequent earthquakes. In ancient times,

it was famous for its thermal baths, or 'royal waters,' as they were called, which still exist.

BROUSSAIS, **FRANÇOIS JOSEPH VICTOR**, the founder of the school of medicine, was born at St Malo, December 17, 1772, and in early life, after studying at Dinon, served for a time first in the navy, and then in the army. In 1820, he was appointed first professor at the military hospital of Val-de-Grace. In 1832, he became Professor of General Pathology and Therapeutics in the Faculty of Medicine in Paris, and afterwards was made a member of the Institute. He died at his country residence at Vitry, November 17, 1838. In 1841, a statue was erected to his memory in the court of Val-de-Grace. B.'s peculiar views are ably explained in his chief works—the *Histoire des Phlegmasies ou Inflammations Chroniques* (1808), and *Examen de la Doctrine Médicale généralement adoptée* (1816), which assert the following principles: that life is sustained only by excitation; that this excitation may be either too strong (*surexcitation*) or too weak (*adynamie*), the latter case, however, being far less frequent than the former. These abnormal conditions of surexcitation and adynamie at first manifest themselves in a specific organ of the body; but afterwards, by sympathy, are extended to other organs; that is, all diseases are originally *local*, and become *general* only by sympathy of the several organs. The organs most subject to disease are the stomach and bowels, and therefore *gastro-enteritis* (inflammation of the stomach and the intestines) is the basis of pathology; consequently, B. resorted to local phlebotomy—especially the application of numerous leeches to the region of the abdomen—as a remedy in fevers and various diseases. His theory and practice gained many adherents in France, who took the name of the 'Physiological School.' But a more exact knowledge of physiology has demonstrated that the views of B. were one-sided and exaggerated. Yet they have not been without use in pathology, as they have led to a more careful study of pathological anatomy and physiological sympathies, and to a more exact observation of the so-called specific morbid processes of which the existence was denied by B. and his followers. Montègre, *Notice Historique sur la Vie, les Travaux, et les Opinions de Broussais*.—His son, **CASIMIR B.**, born 1803, professor at Val-de-Grace (1833), is a zealous adherent of the Broussais system, and is the writer of a work, *Hygiène-Morale*, based on phrenology.

BROUSSONETIA. See **MULBERRY**.

BROWN, **CHARLES BROCKDEN**, a celebrated American novelist, was born at Philadelphia, January 17, 1771. His early education was carried on under the care of Mr Robert Proud, author of the *History of Pennsylvania*. Afterwards he studied for the law, but the licence which he had already given to his imagination induced an unconquerable aversion to legal pursuits, and he consequently betook himself to literature. The French Revolution exercised on him, as on many other ardent spirits, a considerable influence; several of his writings at this period being penetrated with the new thoughts and sentiments which sprang out of that great convulsion. In 1798, he published *Wieland*, the first of his remarkable fictions; and in 1799, *Ormond*, or the *Secret Witness*. His next production was *Arthur Mervyn*, or *Memoirs of the Year 1793*—the fatal year of yellow-fever in Philadelphia. In 1801 appeared *Edgar Huntly*, or the *Adventures of a Sleep-walker*, 'a romance presenting a greater variety of wild and picturesque adventure, with more copious delineations of natural scenery, than is to be found in his other works.'—*Prescott*. This was followed

in the same year by *Clara Howard*, and in 1804 by *Jane Talbot*, first printed in England. He died of consumption in 1810.

Besides the writings which have been enumerated, B. composed a number of political pamphlets, contributed to various literary magazines, and founded three or four periodicals himself. The author who exercised the greatest influence on the development of his genius was Godwin, whom he occasionally imitated, while Godwin himself, on the other hand, acknowledged his obligations to B., and warmly admired him. The most striking quality of his mind is its ingenuity, both imaginative and psychological. He invents incidents and analyses feelings with remarkable subtlety, but his success is somewhat marred by his extravagant departure from the realities of everyday-life.

BROWN, JOHN, of Haddington, once the most popular, and still among the most revered, theological writers in Scotland, was born in 1722 at Carpow, near Abernethy, in Perthshire. Deprived of both his parents when only 11 years of age, he became assistant to a venerable and pious shepherd, named John Ogilvie, who tended his flock among the neighbouring hills, and nursed the religious ardour of the boy's heart. B., however, aspired to be wise as well as good. His thirst for learning was insatiable, and the most romantic yet well-accredited stories illustrative of this are related by his biographers. While still a friendless 'herd laddie,' he had made great progress in a self-acquired knowledge of Greek and Latin. The extent of his acquisitions, even at this early time, may be estimated from the fact, that the country-people round about believed he was in league with the devil, and that he had pledged his soul for unhallowed lore. At a later period of his life, 'he knew nine or ten languages, classical, oriental, and modern, and had amassed vast stores of Puritan, Scottish, and Dutch divinity.' After a brief career as a pedlar—an employment which English readers will understand from Wordsworth's *Excursion* was neither mean nor degrading—B. became a volunteer in a regiment of militia raised in Fifeshire during the rebellion of 1745, and in 1747, schoolmaster in the neighbourhood of Kinross. During the vacations of his school, he studied philosophy and divinity under the inspection of the Associate Synod, and the superintendence of the Rev. Ebenezer Erskine and James Fisher. In 1750, he was ordained pastor of the Secession Church at Haddington. Perhaps a more faithful, industrious, and holy minister never laboured in Scotland. David Hume was once prevailed upon to go and hear him, and the criticism of the great sceptic was: 'That old man preaches as if Christ were at his elbow.' Although self-educated, he had little of the narrowness which culture so obtained generally brings along with it; he corresponded on friendly terms with Episcopalians, and often expressed a warm affection for all true Christians. Although himself a sound Presbyterian, and a tolerably strict Calvinist, 'the love of the Lord' was his real and ultimate test of a man's orthodoxy. In 1758, B. first appeared as an author. His work was entitled *A Help for the Ignorant*, &c. In 1765, he published his famous *Christian Journal*, in which the common events of life are richly but quaintly, and perhaps somewhat artificially, spiritualised. In 1768, he was appointed professor of divinity under the Associate Synod, and in the same year issued his valuable *Dictionary of the Holy Bible*. In 1771 appeared his *History of the Church from the Birth of the Saviour*—a work good enough for cottage-reading, but possessing no merit otherwise; and in 1778, *The Self-interpreting Bible*. This last is B.'s *magnum opus*, and has been amaz-

ingly popular in Scotland; even high dignitaries of the English Church have praised and recommended it. Besides these works, B. published a great variety of sermons, tracts, &c., which had an extensive popularity. He died on the 19th June 1787.

BROWN, JOHN, D.D., grandson of the former, was born 12th July 1784, near Whitburn, Linlithgowshire. He studied at Edinburgh University, and afterwards at the theological hall of the Secession Church in Selkirk. In 1806 he was ordained to the pastorate of a church in Biggar, a small town in Lanarkshire, where he laboured for fifteen years, employing his leisure hours in those studies which subsequently enabled him to take a high rank as a biblical expositor. In 1822 he was transferred to Rose Street Church, Edinburgh, and in 1829 to Broughton Place Church in the same city. In 1834 he was appointed professor of pastoral and exegetical theology in connection with the Associate Synod. He died 13th October 1858. As a preacher, Dr B. was among the first of his time. For clearness of Scriptural exposition, chaste and powerful language, and majestic ardour and earnestness of manner, he had no equal in his denomination, and no superior in Scotland. The attractiveness of his delivery was heightened by a countenance singularly noble, tender, and sweet. Among his works are—*The Law of Christ respecting Civil Obedience*; *The Resurrection of Life*; and his important and scholarly *Expository Discourses on the Epistles of Peter, on the Epistle to the Galatians, and on the Epistle to the Romans*. See Dr Cairns's Memoir (1860).—JOHN BROWN, M.D., son of the above (born 1810), has attained a distinguished place among the medical practitioners of Edinburgh. He has also abundantly inherited the paternal genius, though in him it has taken a literary rather than a theological direction. In 1858 he published *Horæ Subsecivæ*, a volume of essays, most of which had previously appeared in periodicals. One of these, *Rob and his Friends*, has been since published separately, and has obtained a remarkable popularity. It excels in quaint fancy, rich delicate pathos, and abrupt but felicitous diction.

BROWN, SAMUEL, M.D., son of Samuel Brown (the founder of itinerating libraries, and grandson of the Rev. John Brown of Haddington), was born on the 23d February 1817, and entered the university of Edinburgh in 1832. He took his degree as M.D. in 1839, and immediately surrendered himself to the magical fascination of chemistry. One idea possessed him to the close of his life—the possibility of reconstructing the whole science of atoms. He never, in spite of crushing failures in experiment, abandoned his early conviction that chemical elements, usually considered simple, might be transmuted into each other. In 1843, he delivered in Edinburgh four critical lectures on the atomic theory. During the same year, he became a candidate for the chair of chemistry in the university of that city; but having perilled his claims on the experimental success of his fatal theory, and being again doomed to disappointment, he withdrew his application, and devoted himself with a kind of mournful austerity, and with more than the earnestness of a medieval alchemist, to the solitary work of his laboratory. In 1850 appeared his *Tragedy of Galileo*, a volume which indicates, but does not embody, the finely imaginative and philosophical genius of its author. B. died of consumption 20th September 1856. His fugitive essays were collected and published after his death; and though for the most part too comprehensive in their intent, they enable the public to understand why he was held in admiration by men like Hamilton, Ferrier,

De Quincey, Wilson, Carlyle, Hare, Jeffrey, and Chalmers.

BROWN, SIR GEORGE, a distinguished British general, born at Linkwood, near Elgin, Scotland, in August 1790, entered the army in 1806, became lieutenant in 1807, and was present in the latter year at the capture of Copenhagen. He served in the Peninsular War. At the battle of Talavera he was severely wounded, and at the storming of Badajoz was one of the forlorn-hope. He was appointed major, May 26, and lieutenant-colonel, September 29, 1814, in which year he embarked in Major-general Ross's expedition against the United States of America, and was wounded at the battle of Bladensburg. From February 6, 1824 to 1842, he commanded a battalion of the Rifle Brigade. He was made adjutant-general of the forces, April 1850, and lieutenant-general, 1851. In the Crimean war, 1854—1855, B. commanded the Light Division. At the battle of Inkermann, November 5, 1854, he was severely wounded, and obliged to retire for a short time to Malta. In 1855 he was created a Knight Commander of the Bath. In the expedition to the Sea of Azof, he commanded the British troops; and in the first unsuccessful attack on the Redan of Sebastopol, he had the chief command of the storming-party. He was gazetted April 3, 1856, 'General in the army for distinguished service in the field.' He is a Knight of Hanover, and the Turkish Order of the Medjidie of first class was conferred on him in 1855; and the Grand Cross of the Legion of Honour, 1856. In 1860 he was appointed commander-in-chief in Ireland.

BROWN, THOMAS, a Scottish metaphysician, son of the Rev. Samuel Brown, was born in 1778 at the manse of Kirkmabreck, Kirkcudbrightshire. After being some time at school in England, he went to Edinburgh in 1792, and for several years attended the lectures of Playfair, Black, Robison, and Dugald Stewart. He began the study of law, but shortly abandoned it for medicine; and having taken his diploma of M.D. in 1803, he became (1806) the partner of Dr Gregory in his large practice. But his strong bent was for literature and philosophical speculation. At the age of 18, he had published a refutation of Darwin's *Zoonomia*; was a member of an Academy of Physics, or society for 'the investigation of the laws of nature,' formed in 1797, and embracing the names of Erskine, Brougham, Leyden, Jeffrey, Smith, and others; and contributed at the outset to the *Edinburgh Review*. In 1804 appeared his essay on *Cause and Effect*, in which he holds that there is nothing in a cause but the fact of immediate and invariable antecedence to the change called its effect. Dugald Stewart, professor of moral philosophy in the university, being obliged, from bad health, to retire in 1810, got Dr B. appointed assistant and successor, which office he continued to discharge till his death in 1820. He was popular as a professor; and his *Lectures*, published after his death, have gone through a great many editions, though of late they have somewhat fallen out of notice. He also wrote a good deal of poetry, which is now forgotten. Dr B. attempted to overturn the psychological system of his predecessors Reid and Stewart, and to substitute a new and simplified scheme of mental phenomena. The greater part of this new philosophy was the production of his first session as professor, the writing of each lecture being begun on the evening previous to its delivery. A philosophic system thus improvised could not but be crude and inconsistent, however acute and imaginative its author might be. B.'s chief contribution to psychology is the establishment of a sixth or *muscular sense*.

BROWN, JOHN, M.D., founder of the Brunonian system of medicine, the son of a day-labourer, and himself first intended for a weaver, born in 1735, in Bunkle parish, Berwickshire, was educated at the grammar-school of Dunse, in which he was subsequently an usher. After studying medicine at the Edinburgh University, he became tutor to the children of the celebrated Dr Cullen, and assistant in his university lectures. Conceiving himself slighted by Cullen, he commenced giving lectures himself upon a new system of medicine, according to which all diseases are divided into the sthenic, or those depending on an excess of excitement, and the asthenic, those resulting from a deficiency of it; the former to be removed by debilitating medicines, as opium, and the latter by stimulants, such as wine and brandy. His system gave rise to much opposition, but his partisans were numerous; for a time his opinions had some influence. In 1779, B. took the degree of M.D. at the university of St Andrews, and in 1780 published his *Elementa Medicinæ*. He was also author of *Observations on the Old System of Physic*. In 1786, being overwhelmed with debt, he removed to London, where he died of apoplexy in 1788. His works, with a memoir by his son, Dr William Cullen Brown, appeared in 1804 (3 vols. 8vo).

BROWN, ROBERT, an English clergyman, founder of the sect of Brownists, born in 1549, the son of Anthony Brown, Esq., of Foltthorp, Rutlandshire, was educated at Cambridge, and was at first a preacher at Bennet Church, then a schoolmaster in Southwark, and a lecturer at Islington. In 1580, he began to attack the order and discipline of the Established Church, and soon after formed a distinct church on democratic principles at Norwich. Committed by Dr Freaque, bishop of that see, to the custody of the sheriff, he was released from prison through the influence of the lord-treasurer, Cecil, to whom he was nearly related. Having, in 1582, published a controversial work, entitled *The Life and Manners of True Christians*, with, prefixed, *A Treatise of Reformation without Tarrying for Any*, he was again arrested, but, through the lord-treasurer's intercession, again liberated. He afterwards formed several Congregationalist churches; but, with many of his followers, was obliged to take refuge in Holland. In 1589, he returned to England, reconciled himself to the Established Church, and became rector of a church near Oundle, Northamptonshire. Of a very violent temper, he was, when 80 years old, sent to Northampton jail, for an assault on a constable, and died in prison in 1630. The Brownists continued, notwithstanding the defection of their leader, to subsist as a separate sect for some time both in Holland (among the English there) and in England. In the former country, they were at last absorbed in, or reconciled to, the Presbyterian Church in 1701; in the latter, they may be said to have given birth to the Independents (q. v.), who rose into great importance in the 17th century.

BROWN, CAPTAIN JOHN, the leader of the Harper's Ferry (U.S.) insurrection (1859), designed to incite the slaves of the southern states of America to rebellion, was descended from a Puritan carpenter, one of the *Mayflower* emigrants, and was born at Torrington, Connecticut, in the year 1800. He intended to enter the ministry, but had to abandon his studies on account of weak sight, and subsequently became a wool-dealer. In 1854, having imbibed an intense hatred of slavery, he went to Kansas, in order to vote, and, if need were, fight against the establishment of slavery in that territory. In many of the conflicts which ensued between the pro-slavery party from Missouri and the free settlers, B. played

a prominent part, and in one of these he had a son killed, a circumstance which deepened his hostility against the Southern party. After the agitation in Kansas was settled by a general vote, B. travelled through the northern and eastern states, declaiming against slavery, and endeavouring to organise an armed attack upon it. In October 1859, at the head of 17 white men and 5 blacks, he commenced active hostilities by a descent upon Harper's Ferry, a town of some 5000 inhabitants, at the confluence of the Potomac and Shenandoah, and possessed of an arsenal containing from 100,000 to 200,000 stand of arms. The arsenal was easily captured, and 40 or 50 of the principal inhabitants were made prisoners; but instead of retreating at once to the mountains with arms and hostages, as his original design had been—meaning to exchange the hostages for slaves—B. lingered on in the town until the evening, by which time 1500 militiamen had arrived. Next day, an attack was made on his position, which, after some loss of life, was carried. B. was captured, and shortly after was tried for treason, and executed. He is described as a singularly brave and honest man.

BROWN, ROBERT, an eminent botanist, the son of an Episcopal clergyman, was born at Montrose, Scotland, December 21, 1773, and educated at Marischal College, Aberdeen. Having studied medicine at the university of Edinburgh, he became, in 1795, ensign and assistant-surgeon in a Scottish Fencible regiment, with which he went to Ireland. Devoting himself to the study of botany, he resigned his commissions in 1800, and the following year was, on the recommendation of Sir Joseph Banks, engaged as naturalist in the expedition sent out under Captain Flinders for the survey of the Australian coasts. On his return in 1805, he brought home nearly 4000 species of Australian plants, a large proportion of which were new to science. Soon after, he was appointed librarian to the Linnæan Society. To the *Transactions* of the Edinburgh Wernerian Society, and those of the Linnæan Society, he contributed memoirs on *Asclepiadææ* and *Proteaceæ*, and published *Prodromus Floræ Novæ Hollandiæ et Insulæ Van Diemen's*, vol. i. 1810; a supplement to this work appeared in 1830, relating to the *Proteaceæ* only. He also wrote the *General Remarks, Geographical and Systematical, on the Botany of Terra Australis*, attached to the narrative of Captain Flinders's expedition, 1814. His adoption of the natural system of Jussieu, the French botanist, led to its general substitution in place of the Linnæan method. B.'s numerous memoirs in *Transactions* of societies, and other contributions to botanical science, secured for universal approval the title conferred on him by Alexander von Humboldt of *Botanicorum facile Princeps*. In 1810, B. received the charge of the library and splendid collections of Sir Joseph Banks, which in 1827 were transferred to the British Museum, when he was appointed keeper of the botanical department in that establishment. In 1811, he was elected F.R.S.; in 1832, D.C.L. of Oxford; and in 1833 was elected one of the 18 foreign associates of the Academy of Sciences of the Institute of France. In 1839, the Royal Society awarded him their Copley medal for his *Discoveries during a Series of Years on the Subject of Vegetable Impregnation*. He was president of the Linnæan Society from 1849 to 1853. He died in London, June 10, 1858. A collected edition of B.'s works, in 5 vols. 8vo, has been published in Germany.

BROWN, WILLIAM, founder of the Free Public Library at Liverpool, born at Ballymena, Ireland,

in 1784; was educated at Catterick, near Richmond, Yorkshire; and in his 16th year accompanied his parents to the United States. Employed in the counting-house of his father, who was engaged in the linen trade in Baltimore, in a few years he was admitted a partner. Returning to England in 1809, he established a branch of the business at Liverpool, and laid the foundation of one of the largest mercantile firms in the world. Embarking in the American trade, he became an extensive importer of cotton, and by his rare energy, quick business habits, and sterling integrity, soon became distinguished for the magnitude of his dealings. A liberal reformer, he has taken a prominent part in local and public affairs, and unceasingly promoted the education of the people. In 1844, he contested South Lancashire upon the Anti-Corn-Law League interest without success, but was returned to parliament for that division of the county in 1846, and was subsequently three times re-elected. A series of letters in defence of free trade, which, in 1850, he contributed to the *Pennsylvanian* (Boston newspaper), attracted much attention. He is also an able advocate for the adoption of a decimal coinage. In 1857, he munificently subscribed £30,000 for the establishment of a Free Public Library at Liverpool, and the noble and elegant building erected for the purpose owes its existence entirely to his generosity.

BROWN COAL, a mineral substance of vegetable origin, like common coal, but differing from it in its more distinctly fibrous or woody formation, which is sometimes so perfect that the original structure of the wood can be discerned by the microscope, whilst its external form is also not unfrequently preserved. In this state, it is often called *Wood Coal*; and it sometimes occurs so little mineralised, that it may be used for the purposes of wood, as at Vitry, on the banks of the Seine, where the wood-work of a house has been made of it. From this to the most perfectly mineralised state, it occurs in all different stages. It is often brown or brownish black, more rarely gray. It burns without swelling or running, with a weaker flame than coal; emits in burning a smell like that of peat, and leaves an ash more resembling that of wood than of coal. Wherever it occurs in sufficient abundance, it is used for fuel, although very inferior to common coal. *Bovey Coal*, so called from Bovey Tracey, in Devonshire, where extensive beds of it occur, and where it has been long wrought, is B. C., and often exhibits the woody structure very beautifully. B. C. occurs in a number of other places in Britain, and more abundantly near Paris, and in Liguria and Hanover, where it forms thick beds in alluvial deposits.—The *Surturbrand* (q. v.) of Iceland is regarded as a variety of it. *Jet* (q. v.) is also sometimes regarded as a variety of brown coal. Although bearing the name coal, B. C. is rather a kind of *lignite* (q. v.) than of coal.

BROWN PIGMENTS, a term in art applied to those substances in which the three primary colours unite in unequal proportions, red being in excess. B. P. are chiefly mineral, and are used sometimes in a raw but usually in a burned state. The most important are bistre, asphaltum, umber, terra di sienna, Mars brown, Cassel earth, and brown madder.

BROWN SPAR, a name often given by mineralogists to certain varieties of Dolomite (q. v.), or magnesian limestone, of not unfrequent occurrence, distinguished by a brownish or reddish colour, and a pearly lustre, upon account of which they are also sometimes called *pearl spar*.

BROWNE, THOMAS, antiquary and physician,

was born in London, 1605. His father, a merchant, left him an ample fortune, and he was educated at Winchester and Oxford. He began the study of medicine, then travelled over France and Italy, and after taking the degree of M.D. at Leyden, returned and settled (1636) at Norwich, where he continued to practise as a physician. He was knighted in 1671 by Charles II., and died 1682. His chief works are: *Religio Medici* (1642), *Inquiries into Vulgar and Common Errors* (1646), and a *Discourse on Sepulchral Urns* (1648). He wrote also *The Garden of Cyrus, or the Quincunzial Lozenge*; besides a variety of tracts, published after his death. His writings are highly prized by many for their genial fancy, pleasing quaintness of style, and varied erudition.

BROWNIE, a domestic spirit of the fairy order in the old popular superstitions of Scotland. The common tradition respecting the B. is, that he was a good-humoured drudging goblin, who attached himself to farmhouses and other dwellings in the country, and occupied himself during night, when the family were in bed, in performing any humble kind of work that required to be attended to, such as churning, thrashing corn, &c.—a spirit not seen or spoken to, and only known by the obliging performance of his voluntarily undertaken labours—a most valuable adjunct to the domestic establishment, and unfortunately no longer obtainable by good housewives. In Cornwall, a goblin known as *Browny* is evoked to assist at the swarming of bees (*Borlace's Antiquities of Cornwall*). The resemblance of the Scotch B. to the *Robin Goodfellow* (q. v.) of the English, and the *Kobold* of the Germans, is also so conspicuous that we must necessarily refer the different fragmentary legends on the subject to one of the old superstitions generally prevalent in Europe.

BROWNING, ELIZABETH BARRETT, England's greatest poetess, was born in London about the year 1809. Her maiden name is *Barrett*. The culture which she received in her youth was of a kind far transcending the ordinary education even of 'ladies intellectual.' Classics, philosophy, and science were studied with enthusiasm and success. At a comparatively early period, she became a contributor to periodicals, and a series of articles on the Greek Christian poets indicated that she possessed both recondite learning and keen poetic insight. Her first important essay in authorship was a translation of the *Prometheus* of Eschylus in 1833. In 1838, appeared the *Seraphim, and Other Poems*, the external peculiarity of which was its endeavour to embody the ideas and sentiments of a Christian mystery in the artistic form of a Greek tragedy. Delicate health, arising from the rupture of a blood-vessel in the lungs, and the death by drowning of a favourite brother in the following year, compelled her to live in seclusion for a long time. At length her health was restored, and in 1846 she married Robert Browning (q. v.), himself a great poet. Since their marriage, they have resided chiefly in Italy, in whose welfare they are passionately interested. In 1850, Mrs B. published her collected works, together with several new poems, among which was *Lady Geraldine's Courtship*. In 1851, appeared the *Casa Guidi Windows*, a poem whose theme was the struggle made by the Tuscans for freedom in 1849. *Aurora Leigh*, her longest production, was published in 1856. *Poems before Congress* appeared in 1860. Her poetry is distinguished by its depth of feeling, by its true pathos, by its noble and generous sentiments. Apparently she pours forth her verse with dangerous facility; and there are few of her poems which would not be improved by the simple process of curtailment. But there is not a

thought or a sentiment of the many she has so beautifully expressed which any one would wish expunged. No writer has exerted a better, gentler, happier influence.

BROWNING, ROBERT, a distinguished contemporary poet, born in the neighbourhood of London in the year 1812, and educated at the London University. The drama of *Paracelsus*, which first brought him into notice, was published in 1836. In the following year appeared his tragedy of *Stratford*, which was brought out upon the stage, but proved unsuccessful, though Macready himself personated the hero. *Sordello* and *The Blot in the Scutcheon* also failed, through lack of vivid and impressive incident. *Pippa Passes* secured a greater measure of popular approbation. In 1855, B. published *Men and Women*, incomparably his greatest work, containing poems which for depth and subtlety of conception, profound analysis of the human mind in its most delicate and impassioned conditions, and abstract speculative insight, are unsurpassed in the English language. If, as some think, in vigour and brilliancy of thought he is above Tennyson, he is as far beneath him in melody of versification and artistic beauty of style. Often he shews a morbid love of obscurity, deeply to be regretted, as on other occasions he exhibits a Shaksperian clearness of idea and emphasis of expression. Some of his *Dramatic Lyrics* are faultless. Looking upon him as a whole, he must, unquestionably, be considered one of the most original, though also one of the most unpopular poets of the present age.

BROWNS on porcelain are generally imparted by a mixture containing more or less sulphate of iron, and which, when heated, leaves the red oxide of iron (rust) on the porcelain, forming a more or less deep-tinted ochre. See POTTERY.

BROWNS on cloth are communicated by arnotto (q. v.) and copperas, assisted by fustic, sumach, peachwood, logwood, and alum. See DYEING.

BRUCE, the surname of a family illustrious in Scottish history, descended from Robert de Bruis, a Norman knight, who accompanied William the Conqueror to England in 1066, and died soon after. His younger son, Adam, who acquired large possessions in Yorkshire, left a son, Robert de Brus of Cleveland, a companion in arms of Prince David of Scotland, afterwards David I., from whom he received a grant of the lordship of Annandale, held by the tenure of military service. At the commencement of the war in England between Stephen and Matilda, niece of the king of Scots, Robert de B. adhered to the former, and renounced his allegiance to David, resigning his lands in Annandale to his son Robert. In 1138 he was sent by the barons of the north of England to negotiate with David, who had advanced in support of his niece's claims as far as Northallerton, Yorkshire. In the battle of the Standard which followed, he took prisoner his son Robert, then fourteen years of age, who, as lord of Annandale, fought on the Scottish side. He died in 1141. His English estates were inherited by his eldest son, Adam, whose male line terminated in Peter de B. of Skelton, Constable of Scarborough Castle in 1271. Robert de B., second lord of Annandale, had two sons: Robert—who married a natural daughter of William the Lion, and died, without issue, before 1191—and William, whose son, Robert, fourth lord of Annandale, married Isobel, second daughter of David, Earl of Huntingdon and Chester, younger brother of William the Lion, and thus laid the foundation of the royal House of Bruce. He died in 1245.

BRUCE, ROBERT DE, fifth lord of Annandale, son of the fourth lord above mentioned, and the

competitor with John Baliol for the crown of Scotland, was born in 1210. On the death of his mother, the Princess Isobel, in 1252, he did homage to Henry III. for her lands in England, and in 1255 was made Sheriff of Cumberland, and Constable of the castle of Carlisle. About the same time he was appointed one of the fifteen regents of Scotland, in the minority of Alexander III. In 1264, he led, with Comyn and Baliol, the Scottish auxiliaries to the assistance of the English monarch at the battle of Lewes, where he was taken prisoner, but released after the battle of Evesham, the following year. On the Scottish throne becoming vacant at the death, in 1290, of Margaret, the 'Maiden of Norway,' granddaughter of Alexander III., Baliol and Bruce claimed the succession, the former as great-grandson of David, Earl of Huntingdon, by his eldest daughter, Margaret; the latter as grandson, by his second daughter, Isobel. Edward I. of England, to whom the dispute was referred, decided in favour of Baliol, 19th November 1292. To avoid swearing fealty to his successful rival, B. resigned Annandale to his eldest son, Robert de B., Earl of Carrick. He died at his castle of Lochmaben, Dumfriesshire, in 1295, leaving three sons and a daughter.

BRUCE, ROBERT DE, Earl of Carrick, eldest son of the preceding, accompanied King Edward I. of England to Palestine in 1269, and was ever after greatly esteemed by that monarch. On his return to Scotland, he married, in 1271, Martha Margaret, Countess of Carrick, and in her right became Earl of Carrick. Following the example of his father, to avoid doing homage to Baliol, he resigned the lordship of Annandale to his eldest son, Robert, the future king of Scotland, then a minor. Retiring to England, he was, on the death of his father, in 1295, appointed Constable of the castle of Carlisle; and in the following year, when Baliol renounced the authority of Edward, and assisted by the Comyns, had recourse to arms, B. fought on the side of the English. After the battle of Dunbar, in which the Scots were defeated, and Baliol compelled to relinquish the sovereignty, he made application to Edward for the vacant crown, but was refused it. He died in 1304.

BRUCE, ROBERT, the most heroic of the Scottish kings, eldest son of the preceding, was born March 21, 1274. In his youth he favoured the English interests, in the expectation, doubtless, of his father being preferred to the Scottish throne. In 1296, as Earl of Carrick, he swore fealty to Edward I. at Berwick, and the following year he renewed his oath of homage at Carlisle. Shortly after, he abandoned the cause of Edward, and with his Carrick vassals, joined the Scottish leaders in arms for the independence of their country. On the defeat of the Scots, a few months afterwards, at Irvine, B. made his peace with the English monarch. After Wallace's defeat at Falkirk, B. burned the castle of Ayr to the ground, to prevent its falling into the hands of the English, and retired into the recesses of Carrick. In 1299, the year after Wallace had resigned the regency, B., then in his 25th year, was admitted one of the four regents, who ruled the kingdom in the name of Baliol. In the three campaigns which subsequently took place, previous to the final subjugation of Scotland, B. continued faithful to Edward, and in 1305 was consulted in the settlement of the government. With John Comyn, called the Red Comyn, the nephew of Baliol, he appears to have entered into some agreement as to their rival claims to the throne. In an interview between them, in the church of the Minorite Friars, Dumfries, February 4, 1305—6, a quarrel took place, and B., in a paroxysm of

passion, stabbed Comyn with his dagger. Rushing out to his attendants, he exclaimed: 'I doubt I have slain the Red Comyn.' 'You doubt!' cried one of them; 'I mak sikker!' (i. e., sure), and running into the church with some others, slew Comyn and his brother, who attempted to defend him. B. hastened to Lochmaben Castle, assembled his vassals, and asserted his right to the throne. Two months after (March 27), he was crowned king at Scone. An English army, under the Earl of Pembroke, nominated by Edward governor of Scotland, took possession of Perth, and on the night of the 18th June, attacked B. in the wood of Methven, compelling him to retreat into the wilds of Athole. At Dalry, near the head of Loch Tay, B. was attacked by Alexander, Lord of Lorn, chief of the Macdougals, husband of the aunt of the Red Comyn, and compelled to retire. Sending his queen and her ladies to Kildrummie Castle, Aberdeenshire, under the charge of Nigel Bruce and the Earl of Athole, he, with 200 followers, crossed Loch Lomond, and had recourse for subsistence to the chase. B. next took refuge in the little island of Rathlin, on the north coast of Ireland, where he remained all winter, and was supposed to be dead. In his absence, the English took the castle of Kildrummie, hanged Nigel Bruce and other chiefs who had defended it, and tore the queen and Princess Marjory from the sanctuary of St Duthac, Ross-shire. All B.'s estates were confiscated, and himself and adherents excommunicated by the pope's legate at Carlisle. In the spring of 1307, with about 300 men, B. landed in Carrick, and at midnight surprised the English garrison in his own castle of Turnberry; but before a superior force he retired into the mountainous districts of Ayrshire. At Loudon Hill, May 10, 1307, he defeated the English under the Earl of Pembroke, and, three days after, overthrew another party under the Earl of Gloucester. In less than two years he wrested from the English nearly the whole of Scotland. His authority being now established, in 1309 B. advanced to Durham, laying waste the country. The same year, Edward II. of England invaded Scotland, but was compelled to retreat from Edinburgh to Berwick-upon-Tweed. In the harvest of 1312, the Scots again invaded England, but unsuccessfully. B. now reduced the Isle of Man also. On his return, in the autumn of 1313, he found his brother, Edward Bruce, engaged in the siege of Stirling Castle, held by Sir Philip Mowbray for the English. A treaty was entered into, by which Mowbray bound himself to surrender it, if not relieved before 24th June following. This led to the memorable battle of Bannockburn, 24th June 1314, at which B. commanded in person. The English, under Edward II., amounting, it is said, to about 100,000 men, were totally routed, leaving 30,000 dead upon the field; while the Scots, numbering only 30,000, and 15,000 camp-followers, lost about 5000. In 1317, B. passed over to Ireland, to assist his brother, Edward, elected king of that country, and defeated the Anglo-Irish under the Baron of Clare; and in the spring of 1318 the Scots army invaded England by Northumberland. Another invasion of Scotland by the English king, who was compelled to retreat, was followed by B. again marching into England. After bestieging Norham Castle, he defeated Edward once more at Biland Abbey, Yorkshire. A truce was, in consequence, ratified between the two kingdoms at Berwick, June 7, 1323, to last for 13 years. On the accession of Edward III., in 1327, hostilities recommenced; and the Scots being again victorious, a final treaty was ratified in a parliament at Northampton, March 4, 1328, recognising the independence of Scotland, and

B.'s right to the throne. His warfare was now accomplished, and suffering under the disease of leprosy, he spent the last two years of his life at Cardross Castle, on the northern shore of the Firth of Clyde. He died June 7, 1329, in his 55th year, and the 23d of his reign. His heart, extracted and embalmed, was delivered to Sir James Douglas, to be carried to Palestine and buried in Jerusalem. Douglas was killed fighting against the Moors in Spain, and the sacred relic of B., with the body of its devoted champion, was brought to Scotland, and buried in the monastery of Melrose. B.'s body was interred in the Abbey Church of Dunfermline; and, in clearing the foundations for a third church on the same spot in 1818, his bones were discovered. He was twice married: (1) to Isabella, daughter of Donald, tenth Earl of Mar—issue, a daughter, Marjory, wife of Walter the High Steward, whose son ascended the throne as Robert II.; and (2) to Elizabeth, daughter of Aymer de Burgh, Earl of Ulster—issue, one son, who succeeded him as David II., and two daughters.

BRUCE, EDWARD, king of Ireland, brother to the above, a chivalrous but rash and impetuous prince, was actively engaged in the struggle for Scotland's independence; and in 1308, after defeating the English twice, made himself master of Galloway. In 1315, the chieftains of Ulster tendered to him the crown of Ireland, on condition of his assisting them to expel the English from the island. With a small army of 6000 men, he embarked at Ayr, and reached Carrickfergus, May 25th of that year, accompanied by Sir Thomas Randolph, Earl of Moray, Sir John of Soulis, Sir John the Stewart, Sir Fergus of Ardrossan, and other Scottish knights of renown. His rapid victories soon made him master of the province of Ulster, and he was crowned king of Ireland, May 2, 1316, but was slain at the battle of Dundalk, October 5, 1317.

BRUCE, DAVID, son of King Robert Bruce, succeeded his father, in 1329, as David II., when only five years old. In terms of the treaty of Northampton, he had married, when four years old, Joanna, daughter of Edward II. of England, and on 14th November 1331 he was crowned with her at Scone. In 1333, the success of Edward Baliol and the English party obliged David's guardians to send him and his consort to France; but on the dispersion of Baliol's adherents, David returned to Scotland in 1341. He made three unsuccessful inroads into England, and on a fourth invasion, in 1346, was taken prisoner at the battle of Neville's Cross, near Durham, and conveyed to the Tower of London. Thence he was removed to Odiham, in Hampshire, and not released till 1357, when his ransom was fixed at 100,000 marks. His queen dying in 1362, he married Margaret Logie, a Scottish gentlewoman of singular beauty, whom he divorced in 1370. He had no issue; and in his latter years, he was engaged in several intrigues with England, with the view of excluding his nephew, Robert, the Steward of Scotland, the next heir, from the throne. He died at Edinburgh Castle, February 22, 1371.

BRUCE, JAMES, a celebrated traveller, born at Kinnaird House, Stirlingshire, December 14, 1730, was the eldest son of David Bruce, Esq., of Kinnaird, and Marion Graham, of Airth. Educated at Harrow, he was sent, in the winter of 1747, to the university of Edinburgh, with the intention of studying law; but changing his views, he went to London, and having, in February 1754, married the daughter of a wine-merchant's widow, became a partner in the business. His wife dying within a year, he made a tour on the

continent, and on his father's death in 1758, he succeeded to the estate of Kinnaird. In 1761 he retired from the wine-trade, and in 1763 was appointed consul-general at Algiers. He remained there about two years, studying the oriental languages, and acquiring the rudiments of surgery. He then went to Aleppo, where he took further instructions in the medical art, being resolved to travel in the character of a physician. In June 1768, he proceeded to Alexandria, and from Cairo set out on his famous journey to Abyssinia, which forms an epoch in the annals of discovery. Sailing up the Nile to Syene, he crossed the desert to Cosseir, and arrived at Jeddah in April 1769. After various detentions, he reached Gondar, the capital of Abyssinia, in February 1770; and on November 14 of that year, succeeded in reaching the sources of the Abawi, then considered the main stream of the Nile. This accomplishment of the chief object of his journey filled him with the greatest exultation. He remained about two years in Abyssinia, and returning by way of Sennaar and the desert of Assouan, after great hardship reached Alexandria, whence he embarked, March 1773, for Marseilles. In France he spent a considerable time, visiting the celebrated Count de Buffon, and other distinguished men, and in 1774 he returned to Scotland. In 1776, he married Mary, daughter of Thomas Dundas, Esq., of Fingask, by whom he had two sons and one daughter. His long-expected *Travels to Discover the Sources of the Nile, in the Years 1768—1773*, were published in 1790, in 5 large 4to vols., with plates and charts. The work contained such curious accounts of the manners and habits of the people of Abyssinia, that it startled the belief of many, and some of them were set down as fabrications. Among other doubters were De Tott in France, and Dr Johnson in England. Modern travellers, including Salt, Pearce, Burckhardt, Belzoni, and others, have, however, fully confirmed his statements. B. died April 27, 1794, at Kinnaird, of a fall down stairs.

BRUCE, MICHAEL, a minor Scottish poet, the son of a weaver, born at Kinnesswood, Kinross-shire, Scotland, March 27, 1746, was, in his younger years, employed as a herd-boy. In 1762, he was sent to Edinburgh University to study for the ministry, and when not at college, was engaged as a village schoolmaster. He had all his life to struggle with poverty, and his frame being weak, melancholy took possession of his mind, and his constitution began visibly to decline. He died of consumption, July 6, 1767, aged 21. His poems, few in number, and of a tender and pathetic description, were published by the Rev. John Logan, his fellow-student and associate at college, at Edinburgh in 1770. His last composition was a touching elegy on his own approaching death.

BRUCEA, a genus of shrubs somewhat doubtfully referred to one or other of the allied natural orders *Rutaceæ* (q. v.), *Simarubaceæ* (q. v.), and *Xanthoxyloaceæ* (q. v.).—*B. antidysenterica*, or *ferruginea*, is an Abyssinian species, the leaves of which are said to be tonic, astringent, and useful in dysentery. Those of *B. Sumatrana*, a native of the Indian Archipelago, China, &c., possess the same medicinal properties. They are intensely bitter.—The Abyssinian species acquired a factitious importance in the beginning of the 19th c., from a mistaken belief that it produced the dangerous False Angostura Bark (see ANGOSTURA BARK), and in this belief the name *Brucine* (q. v.) was given to an alkaloid really produced by the *Nux Vomica* (q. v.) and other species of *Strychnos* (q. v.).

BRUCHSAL, a town of the grand duchy of

Baden, situated on the Salzbach, and on the railway between Heidelberg and Karlsruhe, 12 miles north-east of the latter place. B., which is a place of considerable antiquity, is surrounded by walls; the old castle of the prince-bishops of Speier, who took up their residence here early in the 11th c., is still standing, and in the church of St Peter are some ancient tombs. The grand dukes of Baden, who became possessed of B. in 1803, have a fine palace here. Pop. 7386, who are chiefly engaged in the wine-trade.

BRÜCINE is one of the Alkaloids (q. v.) present in *Strychnos Nux Vomica* along with strychnine, &c. It is not so abundant as the strychnine, nor is it so poisonous. It is mainly characterised by giving a blood-red colour with concentrated commercial nitric acid, and, indeed, the red colour always yielded by nux vomica, and occasionally by strychnine, when treated with nitric acid, is due to the presence of brucine.

BRÜCKNEAU, a village of Bavaria on the Sinn, 36 miles north-east of Würzburg. It is famous in connection with the baths of B., which are picturesquely situated in a beautiful part of the valley of the Sinn, about 2 miles west from the village. The grounds are tastefully laid out in gardens, and charming walks traverse the surrounding woods. The place is a favourite summer resort of the Bavarian court. B. has paper-mills, and a population of about 1500.

BRÜGES (Ger. *Brügge*), a city of Belgium, capital of the province of West Flanders, is situated on a fertile plain about 8 miles from the sea, with which it is connected by the three canals of Ghent, L'Ecluse, and Ostend. Lat. 51° 12' N., long. 3° 14' E. B. derives its name from its many bridges, 54 in number, all opening in the middle to admit of the passage of vessels. The city is surrounded by walls pierced for seven gates. The streets have a venerable and picturesque appearance, but they are greatly deserted, the population of the city being now scarcely a quarter of what it was during the middle ages. Among the most interesting buildings are the town-hall, with a lofty tower and a celebrated set of 48 bells; a Gothic senate-house, built about the close of the 14th c.; a court of justice, containing a famous carved chimney-piece of the date 1559; the church of Notre Dame, with its spire 450 feet high, its many valuable paintings, and a statue of the Virgin (said to be by Michael Angelo), for which Horace Walpole offered 30,000 florins, and its splendid monuments of Charles the Bold and his daughter Mary, wife of the Emperor Maximilian; the cathedral of St Sauveur, not remarkable for its exterior, but containing paintings by eminent masters; St John's Hospital, with celebrated pictures by Hemling, &c. The Academy of Painting contains several fine pictures by J. van Eyck. B. has manufactures of woollen, linen, cotton, lace, leather, cordage, and tobacco; and distilleries, sugar and salt refineries, and ship-building yards; but its industry is not nearly so extensive as it once was. Population about 50,000, of whom more than a fourth are paupers. B. is a very ancient city. Here, it is said, St Chrysolus preached the gospel as early as the 3d century. In the 7th c., B. was the capital of the surrounding district called Flanders, and before the conquest of England by the Normans, its commercial importance was established. In the beginning of the 13th c., it became the central mart of the Hanseatic League; and in the following century it may be said to have become the metropolis of the world's commerce. Commercial agents from 17 different kingdoms

resided here, and no less than 20 ministers from foreign courts had mansions within its walls. Its population at this time amounted to upwards of 200,000. In 1488, the citizens rose in insurrection against the Archduke Maximilian, and with the harsh measures of repression which ensued, commenced the commercial decline of Bruges. Many of the traders and manufacturers, driven forth from their own country, settled in England, and from this time may be dated the beginning of English manufacturing superiority. In the 16th c., however, the tapestry of B. was still celebrated throughout Europe, and the famous Gobelin tapestry of Paris is said to owe its origin to a manufacturer of Bruges. The city was taken by the French in 1794, and soon after incorporated with the French empire; but in 1815 it was made a part of the kingdom of the United Netherlands, and in 1830 of the Belgian monarchy.

BRUGG, or BRUCK, a village of Switzerland, in the canton of Aargau, on the right bank of the Aar, and near the mouth of the Reuss, about 9 miles north-east of Aarau. It is interesting as occupying a part of the site of the ancient *Vindonissa*, the strongest fortress, as well as the most important settlement of the Romans in Helvetia; and also as the cradle of the House of Hapsburg, to whom, in early times, it belonged. The remains of the castle of Hapsburg, founded by Count Raddob of Altenburg in 1020, are still to be seen on a wooded height, about 2 miles from the village. Nearer, is the Abbey of Königsfelden, founded in 1310 by the wife and daughter of the Emperor Albert, who, two years before, was murdered on the spot by his nephew and others, for which a terrible revenge was taken on the relatives of the murderers. In the vaults beneath the abbey are interred many of the members of the Austrian royal family. High conical roofed towers guard the exit and entrance to B., which has a population of some 800. Zimmermann was a native of this place.

BRÜHL, a town of Rhenish Prussia, about 9 miles south-south-west of Cologne, on the railway to Bonn. It is surrounded by old walls, and has a splendid château, erected in the early part of the 18th c. by the Elector Clement Augustus of Bavaria. There is also an ancient Franciscan convent, now converted into a seminary for Roman Catholic schoolmasters. After his banishment from France in 1651, Cardinal Mazarin took up his residence in Brühl. Pop. 2300.

BRÜHL, HEINRICH, COUNT VON BRÜHL, prime-minister of Augustus III., king of Poland, and Elector of Saxony, deserves a place in history as a signal example of an unworthy minister and venal statesman. He was born in 1700, at Weissenfels, and in early life entered, as a page, into the service of the Duchess of Sachsen-Weissenfels. His winning address and tact gained for him rapid promotion through several offices of state, until, in 1747, he became prime-minister to that idle and unpatriotic ruler, Augustus III. Never was a ruler more slavishly obeyed by a statesman. B. would follow the prince, as he strolled about smoking, without speaking a word for a whole day; or, when his majesty lazily inquired: 'Brühl, have you any money for me?' 'Yes, sire,' would be the constant reply; but in order to be able to give this answer as frequently as it was demanded, B. drained the coffers of the state, and burdened the country with debt. He, however, contrived to enrich himself, and to accumulate honours and titles. By Elizabeth of Russia, he was invested with the order of St Andrew, and by Charles VI. of Austria, he was made a count of the empire. He kept 200 servants,

paid his body-guard better than Augustus did his, furnished the costliest table, possessed the finest wardrobe, and in short, maintained the most splendid establishment in the kingdom. 'Of all statesmen,' said Frederick II., 'Brühl has collected the greatest quantity of fine clothes, watches, lace, boots, shoes, and slippers!' The effect of B.'s reckless robbery of the national finances to gratify the dissolute Augustus and himself, made itself felt at the outbreak of the Seven Years' War, when the country could only furnish 17,000 men to oppose Frederick of Prussia, who surprised and captured the whole Saxon army in its camp at Pirna. Augustus and B. fled to Warsaw. When peace was concluded, they returned to Dresden, where Augustus died on the 5th October 1763, and was followed by his worthless parasite on the 28th of the same month. B.'s palace still remains as one of the principal buildings in Dresden, and his library of 62,000 volumes forms a chief part of the Royal Library, Dresden.

BRUMAIRE (Lat. *bruma*, winter), a division of the year in the republican calendar of France. It includes the time from October 22 to November 20. The celebrated 18th B., which witnessed the overthrow of the Directory and the establishment of the sway of Napoleon, corresponds with November 9, 1799, of the Gregorian calendar.

BRUNCK, RICHARD FRANÇOIS PHILIPPE, one of the most ingenious critics and philologists of modern times, was born at Strasburg, December 30, 1729. He was educated under the Jesuits in Paris; but abandoned his studies, and for some time was engaged as a military commissary during the Seven Years' War. A professor in Giessen, with whom B. happened to lodge while the army was in winter-quarters, revived in him the love of classical studies. Returning to Strasburg, he devoted all his spare time to Greek, and soon distinguished himself as an able but adventurous critic and emendator. His belief that all inaccuracies in ancient Greek writings were introduced by copyists, often led B. astray; but, since the revival of learning, few critics have done more for the progress of Greek literature. His first work, *Analecra Veterum Poëtarum Græcorum* (1772—1776), was followed by several editions of Anacreon (1778—1786), and editions of Apollonius Rhodius (1780) and Aristophanes (1781—1783), *Poëta Gnomici* (1784), Virgil (1785), and Sophocles (1786—1789). The last of these established a new era in the criticism of the tragic writers. The outbreak of the French Revolution interrupted B.'s studies. He ardently attached himself to the popular side. During the Reign of Terror, he was imprisoned, but was liberated after the downfall of Robespierre. His means, however, had been so much reduced, that he was compelled to sell his valuable library. From this time, 1801, he turned his attention from Greek to Latin literature, and published editions of Plautus and Terence. He died June 12, 1803.

BRUNE, GUILLAUME MARIE ANNE, a French marshal of the first empire, was born at Brives-la-Gaillarde, 13th March 1763. His education brought him at an early period into connection with the men of the revolution. Along with Danton, he helped to establish the Cordeliers' Club. After the conquest of Belgium, he was sent as civil commissary to that country, but his warlike aspirations soon induced him to enter the military service. In 1797, he became brigadier under Napoleon in the army of Italy, and distinguished himself at Arcola and Rivoli, where he was made general of division and leader of the advance-guard. Sent by the Directory to Switzerland in 1798, he executed his orders

with brilliant success. In 1799, he was appointed to the command of the army of Holland, where he achieved the reputation of being one of the best generals of his age. He vanquished the Anglo-Russians at Bergen on the 19th of September 1799, and on the 19th of October, forced the Duke of York, commander-in-chief of the combined armies, to capitulate at Alkmaar, under humiliating circumstances. In 1803, he was named ambassador to the Ottoman Porte, and was received by Selim III. with great distinction. In 1804, he obtained the dignity of marshal, and in 1805 returned to France. Two years afterwards, B. became governor-general of the Hanseatic towns, and was charged with the conquest of Pomerania; but circumstances having occurred which unnecessarily excited the distrust of Napoleon, he was recalled, and his future services dispensed with. After the fall of the emperor, he declared for the Bourbons, but his offers were rejected, and, in consequence, he joined Napoleon after his return from Elba. He was now made a peer, but the battle of Waterloo completely destroyed his prospects. He again made his submission, but was barbarously assassinated at Avignon, 2d August 1815, by the populace, who were infuriated against him on account of certain crimes laid to his charge, of which, however, he seems to have been entirely guiltless.

BRUNE ISLAND lies off the south part of the east coast of Tasmania, from which it is separated by D'Entrecasteaux Bay. It has a length of 32 miles, with a breadth varying from 1 to 6 miles; and its east or outside coast is indented by a bay, which takes its name from the *Adventure*, one of Cook's two vessels during his second voyage.

BRUNEL, SIR MARK ISAMBARD, the celebrated engineer of the Thames Tunnel, son of an agriculturist, was born at Haqueville, near Rouen, in France, April 25, 1769. He early shewed an inclination for mechanics, and at school preferred the study of the exact sciences to the classics. In 1786, he became a sailor in the French navy. In the revolutionary period of 1793, having compromised himself by his political opinions, he escaped from Paris to the United States. His career as an engineer began in 1794, when he was appointed to survey for the canal which now connects Lake Champlain with the river Hudson at Albany. He afterwards acted as an architect in New York. On his return to Europe in 1799, he married the daughter of William Kingdom, Esq., Plymouth, and settled in England. A plan submitted by him to government for making block-pulleys for ships by machinery was adopted, and he was for many years employed in carrying it into execution in Portsmouth dock-yard. He was also successful in the construction of other public works—in Woolwich arsenal and Chatham dockyard, &c. His most remarkable undertaking was the Thames Tunnel, formed beneath the bed of the river, and which, commenced in March 1825, was opened to the public in March 1843. Assisted by his son, the subject of the next article, he for ten years pursued a course of experiments for employing carbonic acid gas as a motive power, but the cost of the machinery prevented its introduction as a substitute for steam. Among the less important of B.'s inventions, were machines for making wooden boxes; for ruling paper; for shuffling a pack of cards without using the hands; for the manufacture of nails; and for making seamless shoes for the army—the latter, tried for two years, was abandoned from economical motives. Elected a Fellow of the Royal Society in 1814, he was appointed Vice-president in 1832. He was knighted in 1841; and died, December 1849, in his 81st year.

BRUNEL, ISAMBARD KINGDOM, an eminent engineer, son of the preceding, born at Portsmouth, England, in 1806, was educated at the college of Henri Quatre, Caen, in France. He commenced practical engineering in 1826, under his father at the Thames Tunnel, and in the progress of that great work was often exposed to danger from the water breaking in and flooding the excavations, having more than once to save his life by swimming. He assisted in his father's experiments for making carbonic acid gas a motive power, and was designer and civil engineer of the *Great Western*, the first steamship built to cross the Atlantic; and of the *Great Britain*, the first ocean screw-steamer. The *Great Eastern*, the largest vessel ever built in the world, was erected under his sole direction. In 1833, B. was appointed chief-engineer to the Great Western Railway, and designed and constructed the whole of the tunnels, bridges, viaducts, and arches on this line, and extension branches. Among other docks at English seaports, in the improvement and construction of which he was engaged, may be mentioned the Bute docks at Cardiff, and the old North Dock at Sunderland. In 1842, he was employed by government to construct the Hungerford Suspension-bridge across the Thames at Charing Cross, London. In 1850—1853, he constructed the works of the Tuscan portion of the Sardinian railway. Made a Fellow of the Royal Society in 1830, he was chosen on the Council in 1844. He was also Vice-president of the Institution of Civil Engineers, and of the Society of Arts; a Fellow of the Astronomical, Geological, and Geographical Societies, and Chevalier of the Legion of Honour. He died suddenly, September 1859.

BRUNELLESCHI, FILIPPO, one of the greatest Italian architects, was born at Florence in 1377. He first learned the art of a goldsmith; next, that of a sculptor; and finally devoted himself to architecture. He also studied zealously both mechanical and mathematical science, and is reckoned the first who established, on a sound basis, the theory of perspective. When still a young man, B. went to Rome, where he acquired a profound knowledge of ancient architecture, the result of which was, that two ideas completely possessed his mind: the one was, to revive the ancient style of architecture; the other was, to make himself master of the mechanical knowledge of the ancient architects. In 1407, he returned to Florence. In 1420, it was proposed to complete the structure of the cathedral of Santa Maria del Fiore, founded in 1296, and now only wanting a dome. A great assembly of architects from all quarters was convened to determine how it might be practicable to cover the vast octangular area. While the debate was going on, B. was earnestly elaborating his own designs; but when he first came forward and proposed his plan, it was so ill received, on account of its supposed absurdity, that B. was 'lifted off his legs, and carried out of the room.' He, however, obstinately persisted in explaining his scheme, and at last succeeded in convincing every one of its feasibility. The work was intrusted to him, and finished, with the exception of the lantern, with which he intended to crown the whole, but was prevented by his death in 1444. B.'s dome, measured diametrically, is the largest in the world, and served as a model to Michael Angelo for that of St Peter's. Besides this *chef-d'œuvre*, B. executed several other great works, such as the churches of San Spirito and San Lorenzo, as well as the designs for the Pitti Palace, which originated the beautiful style of Tuscan palace-architecture in the 15th century.

BRUNI, LEONARDO, a native of Arezzo, and

hence styled *Aretino*, was born in 1369. He merits notice as one of the most learned men who flourished during the epoch of the revival of Greek learning in Italy. He first studied law at Florence and Ravenna, but afterwards turned his attention to classical literature. He then went to Rome, where he filled several offices at the papal court. In 1414, he attended John XXII. to the council of Constance. On the deposition of that pope, he returned to Florence, where he was of service to the republic in several important matters. His *Historia Florentina* procured for him the rights of citizenship, and, at a later period, through the favour of the Medicean family, he was appointed state-secretary. He died 9th March 1444. Florence and Arezzo vied with each other in the splendour with which they celebrated his obsequies.

B. aided in advancing the study of Greek literature mainly by his literal translations into Latin of Aristotle, Demosthenes, Plutarch, and others. Of his original works, which are very numerous, many have never been printed, and most are nearly forgotten. We may mention *Commentarius Rerum suo Tempore Gestarum* (Ven. 1476), *De Origine Urbis Mantuæ, De Romæ Origine, Epistolæ Familiæres*, and *Vite di Dante e del Petrarca*.

BRÜNN, a fortified city of the Austrian empire, capital of the government of Moravia, is beautifully situated, partly on the slope of a hill, and partly in a pleasant valley, at the confluence of the Schwartza and the Zwittawa, in lat. 49° 12' N., and long. 16° 37' E. Behind the city, on an eminence, is situated the castle of Spielberg, formerly the citadel, but now used as a state-prison, and noteworthy as the place in which Silvio Pellico was confined from 1822 to 1830. Among the most interesting buildings of B. are the cathedral of St Peter; St James's Church, a Gothic edifice, with a tower 276 feet in height, and a valuable collection of ancient printed books; and the Church of the Minorites; and the Augustine convent. There are also several fine palatial residences belonging to the old nobility. B. is one of the most important manufacturing towns in the Austrian dominions. Its woollens are specially celebrated, and it has also manufactures of cotton, silk, ribbons, yarns, glass, leather, soap, tobacco, and dye-stuffs. Pop. 49,000. Napoleon made B. his head-quarters before the battle of Austerlitz.

BRUNNEN, a village of Switzerland, in the canton of Schwytz, of which it forms the port, near the mouth of the Muotta, in the Lake of Lucerne. It is beautifully situated at the south-eastern end of the lake, and is celebrated in history as the place where, in December 1315, the deputies of the Forest Cantons, who, eight years before, had formed a plan for the liberation of their country from the Austrian yoke, laid the basis of the Helvetic Republic.

BRUNNOW, PHIL. VON, a Russian diplomatist, was born at Dresden, 1797, and studied at the university of Leipsic. At the time of the Congress of Aix-la-Chapelle, he entered the Russian service, and the ministers Nesselrode and Capo d'Istria recognised at once his fitness for a diplomatic career. Among other posts, he attended the congresses of Troppau and Laybach, acted one year as secretary to the embassy in London, went to the congress of Verona, and then occupied for a time a high office in St Petersburg. He was present, in a civil capacity, in the campaigns of 1828 and 1829 against the Turks. In the autumn of 1839, he was sent on a special mission to London, to take advantage of the unpleasant feeling between Great Britain and France for

drawing the cabinets of St Petersburg and London closer together, and in the following spring was accredited as permanent ambassador. In this capacity he soon acquired distinction as a diplomatist. Among the negotiations between Russia and Great Britain conducted under his auspices, an important one was the Navigation Treaty of 1849. After retiring from London on the outbreak of the war in 1854, he represented Russia in Frankfort, and, along with Count Orloff, was sent to the conference of Paris, February 1856. Immediately after the treaty of peace had been concluded, he was sent on a special mission to London, to re-establish friendly relations between the courts of St Petersburg and St James's. He was afterwards appointed to the court of Prussia; but in 1858 he returned to his old place in London, where his amiable character and conciliatory disposition had made him a great favourite, and where he still resides.

BRUNO, GIORDANO, the precursor of the school of modern Pantheistic philosophers, was born at Nola, in the kingdom of Naples, about the middle of the 16th century. He entered, at an early age, the order of the Dominicans, but soon began to express his doubts in regard to the doctrines of Transubstantiation and of the Immaculate Conception, in consequence of which he was obliged to flee from his convent. Henceforth, his life was unsettled. In 1580, he went to Geneva, where he spent two years, but having excited the suspicion and dislike of the strict Calvinists of that city by his general scepticism, he judged it prudent to betake himself to Paris, where he delivered prelections on the 'Great Art' (Logie) of Raymond Lully. His disputes with the bigoted Aristotelians of the university of Paris compelled him, however, to leave France. He passed over into England, where he resided for two years in comparative quiet, enjoying the friendship of Sir Philip Sidney and the protection of the French ambassador, Michel de Châteaufort de la Mauvissière. Here he composed his most important works, but at last, having incurred the displeasure of the clergy by his vehement denunciation of the Aristotelian philosophy, and other grave heresies, he returned to Paris in 1585. In 1586, he proceeded to the university of Marburg, where he matriculated; and to Wittenberg, where he became professor; but being asked to join the Lutheran communion, he refused. On his departure from the city, he pronounced an impassioned panegyric on Luther. After spending some time in Prague, Brunswick, Helmstadt, and Frankfort-on-the-Maine, he resolved to go back to Italy. He fixed his residence at Padua; but after a stay of two years, he went to Venice, where he was arrested by the officers of the Inquisition, and conveyed to Rome in 1598. He was now subjected for two years to persecution, in the vain hope that he would recant; but when all the endeavours of his enemies proved ineffectual, he was brought to the stake on the 17th February 1600, and burned as an obstinate heretic.

B.'s writings, of which the most valuable are composed in Italian, display throughout a strong, courageous, excitable soul, susceptible of deep enthusiasm, but vainly labouring to attain perspicacity. The *Cena delle Ceneri*, or Evening Conversations on Ash-Wednesday, is an apology for the Copernican astronomy; the *Spaccio della Bestia Trionfante*, or Expulsion of the Triumphant Beast (Par. 1584), is a satirical but somewhat heavy allegory in the style of the times. His greatest works are metaphysical, such as the *Della Causa Principio ed Uno* (On the One Sole Cause of Things), and the *Del Infinito Universo e Mondi* (On the Infinity of the Universe and of Worlds).

The doctrine enunciated in these is Pantheistic. B. held that the infinite soul of God did not merely inhabit or pervade the universe, but that the universe was simply a manifestation of Him, and therefore itself divine. God was therefore, in the most literal and physical sense, all in all. B.'s philosophy, in later times, was quite unappreciated, and even neglected, until Jacobi drew public attention to it in his *Letters on the Doctrine of Spinoza*. Both Spinoza and Descartes were much indebted to Bruno. His influence is also discernible in the Pantheistic speculation of modern Germany. Original editions of B.'s works are very rare. Dr Wagner published, along with a life of the author, those written in Italian, under the title *Opere di Giordano Bruno Nolano, &c.* (Leip. 1830).

BRUNO, THE GREAT, Archbishop of Cologne, and Duke of Lorraine, one of the most eminent men of his time, was born about 928 A. D. He was the third son of Henry the Fowler, and the brother of Otto I., Emperor of Germany. Baldrieh, Bishop of Utrecht, and afterwards Israel Scotigena, and others, were his tutors. His surprising knowledge, sagacity, and eloquence secured for him an immense influence over the bishops and clergy, while, on the other hand, his liberality, meekness, and great earnestness of heart, won the affections and reverence of the laity. Summoned by Otto to the imperial palace, he quickly assumed an influential position among the chroniclers, poets, and philosophers of the court. At a later period, he was appointed Archbishop of Cologne, and Lord High Chancellor of the empire. He accompanied Otto to Italy in 951, and honourably distinguished himself by his fidelity to his brother, when Otto's own son, Conrad, and others of his kindred rebelled against him. As a reward, the emperor appointed him Duke of Lorraine. B. died at Rheims, 11th October 965. He wrote a commentary on the Pentateuch, and several lives of saints.

BRUNO, SAINT, the founder of the Carthusian order of monks, was born at Cologne 1051, and received his earliest education in the school attached to the Collegiate Church of St Cunibert. Subsequently, he studied at Rheims, where he distinguished himself so greatly, that Bishop Gervasius appointed him director of all the schools in his diocese. B., however, soon began to be troubled by the wickedness of his time, and, anxious to escape from what seemed to him the general pollution, he took refuge, along with six pious friends, in a desert place near Chartreuse, in the diocese of Grenoble. Here, in 1086, he founded one of the most austere of all the monkish orders, which received its name from the locality whence it had sprung. See CARthusians. B. and his companions had each a separate cell, in which they practised the severities of the rule of St Benedict, keeping silence during six days of the week, and only seeing one another on Sundays. Pope Urban II., who was one of B.'s most eminent scholars, in 1089 summoned the saint to Rome. B. obeyed the call reluctantly, and steadily refused all offers of preferment. In 1094, he established a second Carthusian monastery, called La Torre, in a solitary district of Calabria, where he died in 1101. He was not canonised until 1628. B. left no written regulations for his followers. These first made their appearance in a complete form in 1581, and were enjoined on all Carthusians by Innocent IX.

BRUNSWICK, DUCHY OF (Ger. *Braunschweig*), a state of Northern Germany, consisting of three larger and five smaller distinct parts, and lying mostly within lat. 51° 38'—52° 28' N., and long. 9° 23'—11° 30' E. Its entire area amounts to about 1525 square miles. Pop. in 1858, 274,069. For

administrative purposes, B. is divided into six circles—viz., Brunswick, Wolfenbüttel, Helmstädt, Gandersheim, Holzminden, and Blankenburg. Of the three larger parts, the principal one, forming the circle of Wolfenbüttel, and including the capital, lies between Prussia and Hanover; the second, extending east and west from Prussia to the Weser, divides Hanover into two parts; and the third, forming the circle of Blankenburg, lies to the south-east between Hanover, Anhalt, and Prussia. The smaller parts are the isolated bailiwicks of Calvörde in the east, Thedinghausen in the west (not far from Bremen), and some very small demesnes in the Hanoverian boundaries. B. belongs mostly to the basin of the Weser, which serves as a boundary on the west. The surface is mostly mountainous, particularly in the southern portions of the country, but B. has nevertheless level tracts of considerable extent. The rivers, with the exception of the Weser, are comparatively unimportant, though advantage is taken of one or two for the transport of timber. The climate in the low lands resembles the general climate of Northern Germany; but in the Harz district it is so much colder, that harvest is generally a month later than in the plains.

The mines and quarries of B. produce marble, alabaster, limestone, gypsum, alum, iron, copper, lead, sulphur, and salt in large quantities, with some portions of gold and silver. Agriculture, which is carried on with intelligence and energy, constitutes the chief wealth of the duchy. The products include, beside the ordinary cereals, large quantities of leguminous plants, potatoes, tobacco, and hops. The pasture-land is extensive, and great attention is paid to the rearing of cattle, and especially to the breeding of sheep, wool being an important article of commerce. A large number of persons are employed in the cutting and preparation of timber. The chief manufactures of B. are of linen, stockings, woollen cloth, metals, porcelain, paper, sugar, glass, beer, &c.

The inhabitants are mostly Saxons, and, with the exceptions of some 5000 or 6000 belonging to various other sects, all adhere to the Lutheran Church. The people in the rural districts speak a very broad Low-German dialect; but good High-German is spoken by the educated classes. The educational wants of the state are well looked after by the government, which is a limited monarchy, the duke being head of the state, and his power restricted by the legislature, which is partly hereditary and partly elective. The duke, however, has been of recent years manifesting strong tendencies towards absolutism.

Taxes are voted triennially in Brunswick. The estimated revenue for the three years ending 1860 was 4,693,500 thalers (about £700,000). The public debt in January 1858 amounted to 9,632,396 thalers, of which 6,108,000 thalers were borrowed for the construction of railways. The total effective force of the army of B. in time of war (including both infantry and cavalry) is 4857, with 502 artillerymen, and 12 pièces of ordnance; in times of peace, it is about half the number.

B. was included, as a part of Saxony, under the empire of Charlemagne. In 1235, B., with Lüneburg, was made a duchy under Otto, who died in 1252, and was succeeded, in 1267, by his son, Albrecht, founder of the older line of Wolfenbüttel. John, another son of Otto, was the founder of the older Lüneburg line, which became extinct with William of Lüneburg in 1369. In 1569, Henry, who styled himself Duke of Brunswick-Lüneburg-Dannenberg, founded the new House of Brunswick-Wolfenbüttel; and his brother William founded the new line of Brunswick-Lüneburg, which, in

1815, became the kingdom of Hanover. See HANOVER.

BRUNSWICK, the capital of the duchy of Brunswick, is situated on the Oker, in a level and fertile district, in lat. 52° 46' N., and long. 10° 4' E. B., which is a very old place, is supposed to have been first walled about the 9th c., by Bruno, Duke of Ostfalen. But Henry the Lion, in the 12th c., so greatly beautified and extended the city that he may be almost said to be its founder. In the 13th c., B. became a member of the Hanse League, and soon attained considerable commercial prosperity, but its importance declined with the decay of the League. The town is most irregularly built, with narrow and crooked streets, but possesses the advantages of good causeways and an abundant supply of water. The cathedral—in which are preserved some interesting relics brought by Henry the Lion from the Holy Land—with the churches of St Martin, St Catherine, and St Andrew, with its steeple 316 feet high, are among the principal buildings. In the museum, are some interesting antiquities and works of art by Jan Steens, Albert Dürer, Holbein, Rembrandt, Raphael, Guido, Ruysdael, Michael Angelo, and Benvenuto Cellini. The industry of B. consists chiefly in manufactures of woollen and linen, chicory, beet-sugar, tobacco, *papier-mâché*, lackered wares, &c. Its great annual fair, founded in 1498, is important. The old fortifications of B. have been demolished, and their site converted into pleasant promenades. A fine walk through an avenue of linden-trees leads from the town to the duke's palace. Pop. 40,000.

BRUNSWICK, NEW. See NEW BRUNSWICK.

BRUNSWICK BAY, on the north-west coast of Australia, in long. 125° E., and about lat. 15° S. It receives Prince Regent River.

BRUNSWICK BLACK is a varnish employed for coating over coarsely finished iron grates, fenders, &c. It is mainly compounded of lamp-black and turpentine, and when applied with a brush, quickly dries, and leaves a shining jet-black surface.

BRUNSWICK GREEN is a pigment used in the arts, and consisting of the hydrated chloride and oxide of copper ($\text{CuCl}_2 \cdot 3\text{Cu}_2\text{O} \cdot 4\text{H}_2\text{O}$). It may be prepared (1) by acting upon metallic copper with common salt and diluted sulphuric acid, (2) by acting upon metallic copper with moistened sal-ammoniac, or (3) by mixing sulphate of copper and common salt into a paste with water. It is found native at Atacama, in Peru, in the form of a green sand, hence the name Atacamite (q. v.).

BRUSSELS (Fr. *Bruxelles*), the capital of Belgium, is situated on the small river Senne, a tributary of the Dyle, in lat. 50° 51' N., and long. 4° 21' E. It communicates with Antwerp and the Baltic Sea, by means of the Scheldt canal, and railways connect it with Germany, France, and Holland, as well as with all the principal towns of Belgium. The city is built partly on the side of a hill, and partly on a fertile plain; and though some of the streets are so steep that they can be ascended only by means of stairs, B., on the whole, may be pronounced one of the finest cities in Europe. The Upper Town, situated on the side of the hill, is the newest and most fashionable, and is the residence chiefly of the great and wealthy. The king's palace, public offices, chief hotels, and mansions of foreign ministers are here. It is also much more healthy than the Lower Town, which, stretching along the canal and the Senne, is greatly subject to fogs. But the latter, with its numerous handsome old buildings, formerly belonging to the Brabant nobility, but now occupied by merchants

BRUSSELS CARPETS—BRUTUS.

and traders, has a fine picturesque appearance, while some of its public edifices are unrivalled as specimens of Gothic architecture. This part has also several noble churches, but it is now wholly given over to trade. French is spoken in the upper part of B.; but in the lower, Flemish is prevalent, and in one quarter the Walloon dialect is spoken. The English language, owing to the large number of English who reside in B. for economy, is also very common. The walls which formerly surrounded B. have been removed, and their place is now occupied by pleasant Boulevards, shaded by alleys of trees, extending several miles. The *Allée Verte*—a double avenue along the Scheldt canal—forms a splendid promenade, and leads toward the palace of *Læken*, the suburban residence of the royal family, three miles north of the city. Besides the fine park in the Upper Town, covering an area of some seventeen acres, ornamented with fountains and statues, and surrounded by the king's palace, the 'Palace of the Prince of Orange,' the Chamber of Representatives, and other buildings, B. has several other squares or places, among which the most noteworthy are—the *Place Royale*, with its colossal monument of Godfrey of Bouillon; the *Grand Place*, in which is situated the *Hôtel de Ville*, a splendid Gothic structure, erected in the beginning of the 15th c., with a pyramidal tower 364 feet high, surmounted by a statue of St Michael, the patron saint of B., and where, in 1568, the patriot counts, Egmont and Horn, were beheaded by order of the Duke of Alba; and the *Place des Martyrs*, where a memorial has been erected to those who fell here in the revolution of 1830. Among the churches of B., the largest and finest is the cathedral of St Gudule, which dates from the 12th c., and is built in the pointed Gothic style, with two towers of more modern date, rising on each side to a height of 264 feet, many richly painted windows, a pulpit considered the master-piece of Verbruggen, and monuments of the Dukes of Brabant and other distinguished persons. In the *Palais des Beaux Arts* is the picture-gallery, containing the finest specimens of the Flemish school of painting; the public library with its 200,000 volumes, and its 18,000 MSS., collected by the Dukes of Burgundy—MSS. interesting and valuable not only for their contents, but for the beautiful miniature paintings with which the scholars of Van Eyck adorned them. The Observatory is one of the finest in Europe, and is under the charge of the celebrated mathematician Quetelet. The educational establishments of B. are numerous, the principal being the free university, founded in 1834, with four faculties—viz., law, medicine, mathematical and physical sciences, and belles-lettres, and having a special school of pharmacy attached. It has also numerous charitable and benevolent institutions; and is the seat of the provincial government of South Brabant, as well as of the general government of the kingdom. B. is one of the chief centres of the industry of the country. Its lace is particularly famous. Of the esteemed carpets which pass under the name of B. carpets, only a few are manufactured here, most of those of Belgia make being produced at Tournai. It has also manufactures of damask, linen, ribbons, paper, jewellery, hats, soap, porcelain, mathematical and musical instruments, &c. Carriage-building is also an important branch of industry. Printing and lithographic establishments are numerous; and about a dozen newspapers are published daily. Pop. in 1858, 163,499.

As early as the 8th c., we find B. (*Bruchsellæ*), then probably a villa of the Frank kings, mentioned in old chronicles, and that a church existed here

in 966 is proved by a deed of the Emperor Otho I. Under Charles V., B. was made the court-residence in the Netherlands, and became afterwards, under Philip II., the chief arena of the revolution, and of the atrocities committed by the Duke of Alba and the Inquisition. B. suffered greatly in the war of Spain against Louis XIV.—in whose reign it was bombarded by Marshal Villeroi and upwards of 4000 buildings destroyed—and in that of Austria against Louis XV.; but still more from the continual prevalence of party animosities caused by the policy of Austria. Under the mild rule of Maria Theresa, B. flourished greatly, and in this time, many of its best institutions and public buildings were founded. In 1789 occurred the Brabant revolution under Joseph II.; and scarcely had Austrian rule been re-established, after a brief time of independence, when B. fell into the hands of the French, 1792. After other changes of fortune, B., with the other parts of Belgium, was incorporated with the kingdom of the Netherlands in 1815, and so remained until the revolution of 1830, by which it became the capital of the independent kingdom of Belgium.

BRUSSELS CARPETS. See CARPET.

BRUSSELS SPROUTS, one of the many cultivated varieties of *Brassica oleracea* (see BRASSICA and CABBAGE), distinguished by producing, in the axils of the leaves, little clusters of leaves which close together and form miniature cabbages. These are used, like other greens of this species, for the table, and are very delicate. The plant is cultivated much in the same way as cabbage or kale, requiring, however, less space than most of the varieties. It may be planted in shady situations, or between the rows of crops, such as pease, beans, scarlet-runners, &c., which are to be removed from the ground in autumn. The sprouts are fit for use chiefly in winter and spring. The stem sometimes attains a height of four feet, and the head resembles a small imperfectly bolted savoy; but there is a subvariety with shorter stems, preferable for many situations. In some places, it is customary to remove the head early in winter, in order to promote the development of the lateral shoots in spring; but if the head is allowed to remain, the plant becomes taller, and new shoots are formed as the lower ones are removed. The seed is sown in February or March. Seed is very generally imported from Belgium, as this vegetable is said to degenerate in Britain. Its use has of late rapidly extended, and none of the many varieties of the species to which it belongs is better deserving of cultivation.

BRUTUS, LUCIUS JUNIUS, figures in the legendary history of early Rome, as the hero who overturned the monarchical, and established the republican form of government. The legend runs that he was the son of a rich Roman. On his father's death, Tarquin the Proud took possession of the property, and put an elder brother to death, and B. himself only escaped the same fate by feigning idiocy (hence the name *Brutus*, stupid). The oracle of Delphi foretold that he should govern in Rome. Remembering his own wrongs, and gifted with the strength and wisdom of one who was fulfilling the decrees of fate, B., when the foul rape committed by one of the royal family upon Lucretia had shocked the people, convoked them, placed himself at their head, and drove the kings from Rome. He is said to have been then elected one of the two first consuls (509 B. C.). That his character as a stern old Roman hero might be complete, the legend adds that he sacrificed to the new republic his own sons, detected in a conspiracy to restore the monarchy;

and that at last he fell in mortal combat repelling an attack led on by one of the sons of Tarquin. Little more, however, can be said to be established upon sufficient historical evidence with regard to B., than that there existed a person of that name who held high office in Rome at a very early period.

BRUTUS, MARCUS JUNIUS, born 85 B. C., appears to have spent the early years of manhood in exclusive devotion to literary pursuits, and not to have taken part in the political dissensions agitating Rome till he had attained a mature age. When the civil war broke out between Pompey and Cæsar, he sided with the former; but after the battle of Pharsalia, made his submission to the latter, and, in the following year, was appointed governor of Cisalpine Gaul. On returning to Rome, he divorced his wife, in order to marry Portia, the daughter of Cato, of whose principles in politics he professed to be a disciple. The influence of Cassius prevailed upon him to join the conspiracy which ended in the murder of Cæsar. The efforts of B. to retain popular favour afterwards being unavailing to counteract the effects of the eloquence of Antony, he was forced to leave first Rome, and then Italy. The remainder of his life was spent partly in Athens, partly in Asia Minor, and partly as the leader of a marauding force which maintained itself by plundering the inhabitants of the eastern shores of the Adriatic. Defeated by Antony and Octavianus (Augustus) at the battle of Philippi (42 B. C.), he terminated his life by falling upon his sword.

BRÜX, a town of Bohemia, situated on the Bila, about 14 miles north of Saatz. In its vicinity are extensive coal-mines, and the famous mineral springs of Püllna and Seidlitz, from which the inhabitants of B. prepare a considerable quantity of salts. Pop. about 3000.

BRUYÈRE, JEAN LA. See LABRUYÈRE.

BRYANT, JACOB, an eminent English scholar, was born at Plymouth in 1715. He was educated at Eton and King's College, Cambridge, where he took his degree of M.A. in 1744. In 1756 he became private secretary to the Duke of Marlborough, and accompanied his Grace to the continent. Substantial proofs of the duke's esteem raised him above the region of pecuniary cares, and enabled him to devote his whole life to letters. He died 14th November 1804. Among his numerous publications, may be mentioned: *Observations and Inquiries relating to various Parts of Ancient History* (Cambridge, 1767); *A New System or Analysis of Ancient Mythology* (1774—1776); *Vindiciæ Flavianæ* (a defence of Josephus's testimony in regard to Christ), (1780); *Treatise on the Authenticity of the Scriptures and the Truth of the Christian Religion* (1792); *A Dissertation concerning the War of Troy, &c.* (1796); *The Sentiments of Philo-Judæus concerning the Logos* (1797); and a variety of Dissertations on the Difficult Passages of Scripture (1803). B. was a man of great and varied learning, but his intellect, although acute, was neither philosophical nor comprehensive enough to enable him to handle in a satisfactory manner the important questions on which he wrote.

BRYANT, WILLIAM CUTLEN, a distinguished American poet and journalist, was born in Hampshire, Mass., November 3, 1794. At the early age of 10, he published translations from some of the Latin poets; at 13, he wrote a terse and vigorous political poem, entitled *The Embargo*; and at 18, he composed his *Thanatopsis*, a poem full of beauty. In 1815 he was admitted to the bar, and for ten years practised with diligence and success. In 1825

he removed to a more congenial sphere, and in association with a friend, established *The New York Review*, to which he contributed many of his best poems. In 1826 he became principal editor of *The Evening Post*, the leading democratic paper of New York, which he still continues to conduct with a manliness and purity of tone of which the examples among his professional brethren might be increased with advantage. The first collected edition of his poems appeared in 1832. They were soon after republished in Britain, and were regarded as the highest efforts, up to that time, of the American Muse. In 1842 he published *The Fountain, and Other Poems*. B. visited Europe in 1834, and again in 1844 and 1849. The result of his observations was, *Letters of a Traveller in Europe and America*. In 1858 appeared a new edition of his poetical works, with 71 engravings. Although the popularity of B.'s writings has been eclipsed by that of Longfellow and Poe, he has still a large circle of readers and admirers. The general impression, however, is, that his mature genius has fallen far short of its early promise.

BRY'ONY (*Bryonia*), a genus of plants of the natural order *Cucurbitaceæ*, distinguished by triadelphous stamens, with distinct anthers, a trifid style, and a few-seeded fruit destitute of hard rind. The stems climb by means of lateral tendrils, the leaves are angular or 3-5-lobed, and the flowers campanulate, 5-partite, unisexual, and generally yellow. The COMMON BRYONY (*B. dioica*), the only British species, is frequent in hedgerows in England, but is not indigenous to Scotland. It has cordate palmate leaves, axillary bunches of flowers, and red berries about the size of a pea. It abounds in a fetid and acrid juice. The root is perennial, very large, white and branched, has a repulsive smell, and is acrid, purgative, and emetic. *B. alba*, common in the middle parts of Europe, possesses similar properties.



Common Bryony.

The root of both is applied topically to bruises, and was formerly very much in use as a purgative. It is now again much employed in homœopathic practice. A decoction made of 1 lb. of the fresh root is said by Withering to be 'the best purge for horned cattle.' It contains a bitter extractive, called *Bryonine*, to which it seems to owe its properties. The young shoots of both species are, however, so free from acrid and dangerous qualities, that they may be used as pot-herbs.—The roots of other species of the genus are also acrid and purgative; but it is said that the root of *B. Abyssinica*, when cooked, is eaten without danger.—BLACK BRYONY (*Tamus communis*) is a plant of a different natural

order (*Dioscoreacea*, q. v.). The genus is distinguished by an inferior ovary and succulent fruit. Black B. has long twining stems, cordate undivided leaves, greenish flowers, and red berries. Its roots are very large and fleshy, black externally. The berries are unwholesome, and the whole plant is acrid, the roots so much so as to have been formerly employed for stimulating plasters. But the young suckers, in which the acrid principle is not much developed, are eaten in Greece as asparagus, after careful boiling with change of water, as are also those of *T. Cretica*. The plant is common in most parts of Europe, and is found in England, in hedges and thickets.

BRYOZO'A. See ZOOPLYTES.

BRYUM (Gr. *bryon*, moss), a genus of Mosses (q. v.) distinguished by a terminal fruit-stalk, a double *peristome* (see MOSSES)—the outer one of 16 teeth, the inner a membrane cut into 16 equal



Bryum Longicollum :

a, Sterile shoots with leaves; *b*, fertile plant, shewing the spore-case and its stalk; *c*, the spore-case or capsule, magnified; *d*, the calyptra, magnified; *e*, the top of the spore-case or capsule, shewing the double peristome, magnified.

segments—and a dimidiate *calyptra*. The species are very numerous, and many of them are natives of Britain. They are all small, their stems short, and their leaves forming little rosettes, from the centre of which the fruit-stalk springs. They very generally grow in dense patches, on wet rocks, wet earth, the bark of trees, &c., beautifully clothing them with bright green.

BRZESC LITEWSKI, a walled town of Russia, in the government of Grodno, about 108 miles south from the city of the same name. Being advantageously situated on the right bank of the Bug, it has an extensive trade. It was the scene of a battle between the Russians and Poles in 1794. Pop. 17,431.

BRZE'ZAN, a town of Galicia, situated on the Zlota-Lipa, about 54 miles south-east of Lemberg. It has an old castle and a gymnasium, and manufactures of linen, sail-cloth, and leather. Pop. 8000.

BUA'CHE, or **GARDEN ISLAND**, an island of Western Australia, near the mouth of Swan River, in lat. 32° 10' S., and long. 115° 40' E. Though measuring only 6 miles by l, it is yet important as sheltering from the open ocean the deep and spacious anchorage of Cockburn Sound, which flows between it and the mainland of the colony.

BU'AZE, a South African plant, of which the botanical characters and relations are not yet known, but which is likely to prove of importance on account of its fibre. Dr Livingstone found it growing in large quantities in the Maravi country, north of the Zambesi; but he could not procure any specimen in flower or fruit, and Dr Hooker did not recognise the specimens of branches and

leaves. It is not cultivated, and the only use to which it is put by the natives is to afford threads



Buaze.

for stringing beads on; but Dr Livingstone thinks its fibre stronger and finer than flax, and says that a firm thread of it feels like catgut in the hand, and would rather cut the fingers than break.

BU'BALUS, **BU'BALIS**, or **BU'BALÉ** (*Antelope Bubalus*), supposed to be the *Bubalus* of the ancients—although that name is now generally appropriated to the buffalo (q. v.)—a species of antelope, of that section of the genus which is characterised as *bovi-*form or ox-like. The Arabic name is Bekker-el-Wash, which signifies wild ox. It is an animal about the size of a large stag, with very ox-like head and muzzle—the head, however, remarkably



Bubalis.

long; the horns about as long as the head, surrounded by a succession of thickened rings, curved so as somewhat to resemble the sides of a lyre, the points directed backward. The general colour is yellowish brown, but the tail is terminated by a black tuft. The B. is an animal of rather coarse appearance, very destitute of the gracefulness of the typical antelopes. It inhabits Barbary, and occasional wanderers make their way to the banks of the Nile. It is figured on the monuments of ancient Egypt. It is gregarious in its habits. It is said to be easily domesticated. The most nearly related species to this, of other antelopes known, is the **KAAMA** (q. v.) of South Africa.

BUBA'STIS, a goddess of the Egyptians, was, in their mythology, the child of Isis and Osiris, and the sister of Horus. She was identified by the Greeks with Artemis (Diana), though upon what grounds is unknown, as the best information with regard to her is, that she was the goddess who presided over pregnancy and childbirth. The chief temple erected to B. was at Bubastis (q. v.). B. is represented on monuments as having the head of a cat, an animal which was sacred to her.

BUBA'STIS (the *Pi-beseth* of Scripture, and modern *Tel Basta*), a ruined city of Egypt, about 14 miles north of Belbeys, in lat. 30° 36' N., and long. 31° 33' E. B. derived its name from the Egyptian goddess Bubastis, in whose honour a temple was erected here, which, if not so large and magnificent as some Egyptian temples, was, according to Herodotus, one of the most beautiful, and vast numbers of persons were wont to make annual pilgrimages to it. Nothing but some stones of the temple, which are of the finest red granite, now remain. There are some other ruins, and mounds of great extent, consisting chiefly of the remains of brick-houses and heaps of broken pottery.

BUBBLE, as a term, is defined by Blackstone as an unwarrantable undertaking by unlawful subscriptions, subjecting the parties who originate and put them in operation to the penalties of *præmunire* (q. v.). The *South-sea Company* (q. v.) was a terrible example of such a bubble.—The **BUBBLE ACT** is the name given to the 6 Geo. I. c. 18, 'enacted,' says Blackstone, 'in the year after the infamous South-sea project had beggared half the nation,' and which public fraud the act was intended to punish. But it was repealed by the 6 Geo. IV. c. 91, which at the same time left such companies to be dealt with by the common law.

BUBBLE SHELL. See **BULLA**.

BUBO, an inflammatory tumour, seated in the groin or the armpit.

BUBO. See **OWL**.

BUCANEE'RS, a celebrated association of piratical adventurers, who, from the commencement of the second quarter of the 16th c., to the end of the 17th, maintained themselves in the Caribbean seas, at first by systematic reprisals on the Spaniards, latterly, by less justifiable and indiscriminate piracy. The name is derived from the Caribbee *boucan*, a term for preserved meat, smoke-dried in a peculiar manner. From this the French adventurers formed the verb *boucaner* and the noun *boucanier*, which was adopted by the English; while, singularly enough, the French used, in preference, the word *flibustier* (see **FILIBUSTERS**), a corruption of our 'freebooter.' The B. were also sometimes called 'Brethren of the Coast.' The arrogant assumption by the Spaniards of a divine right—sanctioned by the pope's bull—to the whole New World, was not, of course, to be tolerated by the enterprising mariners of England and France; and the enormous cruelties practised by them upon all foreign interlopers, of which the history of that time is full, naturally led to an association for mutual defence among the adventurers of all other nations, but particularly among the English and French. The fundamental principles of their policy—for they, in course of time, formed distinct communities—were close mutual alliance, and mortal war with all that was Spanish. Their simple code of laws bound them to a common participation in the necessities of life; locks and bars were proscribed as an insult to the general honour; and every man had his comrade, who

stood by him when alive, and succeeded to his property after his death. The principal centre of their wild and predatory life was for some time the island of Tortuga, near St Domingo. When they were not hunting Spaniards, or being hunted themselves, their chief occupation and means of subsistence was the chase. From the flesh of wild cattle they made their 'boucan'; their skins and tallow they sold or bartered to Dutch and other traders. The history of these men embraces, as may be supposed, narratives of cruelty and bloodshed unsurpassed in the annals of crime. It has, however, not a few stories of high and romantic adventure, of chivalrous valour, and brilliant generalship. Among the 'great captains' whose names figure most prominently in the records of bucaneeering, were the Frenchman Montbars, surnamed by the terrible title of 'The Exterminator'; his countrymen, Peter of Dieppe, surnamed 'The Great'—as truly, perhaps, as others so distinguished—and L'Olonnais, Michael de Busco, and Bartolomeo de Portuguez, Mansvelt, and Van Horn. Pre-eminent, however, among them all was the Welshman, Henry Morgan, who organised fleets and armies, took strong fortresses and rich cities, and displayed throughout the bold genius of a born commander. He it was that led the way for the B. to the Southern Ocean, by his daring march in 1670 across the Isthmus of Panama to the city of that name, which he took and plundered after a desperate battle. This brilliant but most unscrupulous personage was knighted by Charles II., and became deputy-governor of Jamaica. A higher subordination of the love of gold to the passion for dominion in him, might probably have made him Emperor of the West Indies, some dream of which seems at one time to have occupied his mind. In 1680 and 1689, extensive bucaneeering expeditions were made to the Pacific, even as far as the coasts of China, of which the best record is preserved in the lively pages of William Dampier, himself an important partner in these bold adventures. The war between France and Britain, after the accession of William III., dissolved the ancient alliance of the French and English bucaneeers. After the peace of Ryswick, and the accession of the Bourbon Philip V. to the Spanish crown (1701), they finally disappeared, to make way for a race of mere cut-throats and vulgar desperadoes, not yet utterly extinct. The last great event in their history was the capture of Carthage in 1697, where the booty was enormous.—See the *Histories* of Burney and Thornberry, Dampier's *Voyages*, and the *Narratives* of Wafer, Ringrove, and Sharp.

BUCCINA'TOR (from Lat. *buccinare*, to sound a trumpet), the name of a muscle, situated in the substance of the cheeks; it is so called because, when the cheeks are distended with air, the contraction of the B. muscles forces it out.

BUCCINO, a town in the province of Principato Citra, Naples, pleasantly situated on the Botta, which at this point is crossed by an old Roman bridge, about 14 miles east from Campagna. In its vicinity are quarries yielding fine marble. Pop. 5460.

BUCCINUM. See **WHELK**.

BUCCLEUCH. The Scotts, Dukes of B., are one of the oldest and most distinguished families in Scotland. The family traces its descent from Sir Richard le Scott, in the reign of Alexander III. (1249—1255); but the ancestor who first becomes historically conspicuous is Sir Walter Scott of Branxholm and B., a brave and powerful chieftain on the border. B., which from this early period was

destined to be associated with the family title, is a lonely estate in the vale of Rankleburn, at the head of Etrick, Selkirkshire. The Sir Walter alluded to flourished in the reign of James V., and on some incidents in his life, his great namesake founded the *Lay of the Last Minstrel*. Sir Walter fought bravely at the battle of Pinkie, 1547, and was slain in an encounter with Sir Walter Kerr of Cessford in the streets of Edinburgh, 1552. He was succeeded by his grandson, Sir Walter Scott of B., a knight 'wise, true, and modest,' who was succeeded by his only son, who bore the same name. This Sir Walter is celebrated for his military exploits on the border, not the least daring of his enterprises being the rescue of one of his attendants, Kinmont Willie, from the castle of Carlisle. (See *Minstrelsy of the Scottish Border*.) For his services to the state, in which it is to be reckoned his carrying away of large numbers of the border marauders to foreign wars, he was raised to the peerage, 1606, as Lord Scott of Buccleuch. Dying in 1611, he was succeeded by his only son, Walter, who, in 1619, received an elevation in the peerage, as Lord Whitechester and Eskdale, and Earl of Buccleuch. Through his son Francis, the second earl, the family, by a grant, acquired the extensive domain of Liddesdale, formerly belonging to the House of Bothwell; also, by purchase, large territories in Eskdale; and in 1642, the barony of Dalkeith from the Morton family. Francis left only two daughters, the eldest of whom dying without issue, the titles and estates went to her sister, Anne, who, in 1663, was married to James, Duke of Monmouth, an illegitimate son of Charles II. In 1673, this pair were created Duke and Duchess of B., Earl and Countess of Dalkeith, &c. After a marriage of twenty-two years, the unhappy duke, on a charge of rebellion, was tried and beheaded, 1685; the duchess, however, retaining her honours, title, and estates, as in her own right. The duke left a family of four sons and two daughters. The duchess afterwards married Lord Cornwallis, by whom she had a son and two daughters, and died in 1732, at Dalkeith House, where she had occasionally resided in princely splendour. James, her eldest surviving son, predeceased his mother, and his son, Francis, by the death of his grandmother, succeeded to the title of Duke of Buccleuch. Notwithstanding the connection with the son of Charles II., the family still preserved the surname of Scott. Duke Francis, in 1743, obtained a restoration of his grandfather Monmouth's Earldom of Doncaster and Barony of Tynedale, and was hence a British peer. In 1720, he married a daughter of James, second Duke of Queensberry, and by this fortunate connection, a portion of the Queensberry estates, along with the dukedom, merged in the family of B. in 1810. Henry, third Duke of B., born 1746, was the greatest and most estimable of his family. He had for his tutor and friend Dr Adam Smith, and his beneficent talents were directed towards the improvement of his extensive estates in the south of Scotland. The amelioration of the soil, the planting of trees, the making of roads, the improving of the breed of sheep, and the social elevation of his numerous tenantry, uniformly engaged his attention. He died in 1812, and was succeeded by his eldest son, Charles, fourth duke, who, dying in 1814, was succeeded by his son, Walter Francis, born 1806, who bears the title of Duke of B. and Queensberry, Marquis of Dumfriesshire, Earl of Drumlanrig, B., Sanquhar, Dalkeith, &c., in the peerage of Scotland; and Earl of Doncaster, &c., in the peerage of England. His eldest son, William Henry, takes the courtesy title of Earl of Dalkeith. The duke, like his grand-

father, is noted for the improvement of his estates, which in Scotland are situated in Mid-Lothian, Dumfriesshire, Roxburghshire, Selkirkshire, Peebleshire, Lanarkshire, and stewardry of Kirkcudbright; his farms everywhere being noted for their good steadings and thriving tenantry. As an heritor, the number of churches and school-houses which the duke has been concerned in building is very considerable. He has one small possession in Fife—the island of Inchkeith (q. v.). The greatest public improvement ever executed in Scotland by an individual at his own private cost, has been carried by the Duke of B., after years of labour and at vast expense, to a successful issue. We allude to the creation of the deep-water harbour and port of Granton, on the Firth of Forth, two miles from Edinburgh—a work which, like the undertakings of the great Duke of Bridgewater, cannot fail to give lasting fame to its projector. The cost of this enterprise has been referred to in parliament as already not less than £320,000.

BUCENTAUR, the name of a ship which acquired much celebrity in Venice at the time when that state was a flourishing republic. A bucentaur was known as early as the end of the 12th c.; and a vessel of the same name was burnt when the French took Venice more than six centuries afterwards; but it is not certain whether this was the same vessel, maintained by being repeatedly patched up with new ribs and planking. The B. is described as having been a galley, about 100 feet long by 21 in extreme breadth; on a lower deck were 32 banks or rows of oars, manned by 168 rowers; and on an upper deck was accommodation for the illustrious visitors who occasionally came on board. The whole of the fittings were of the most gorgeous character. Although propelled mainly by oars, there were 40 mariners employed in other ways to manage the galley. The B. was employed only once a year, when the Doge 'married the Adriatic.' A splendid water-procession was formed, with the Doge and the chief notables in the B., and other distinguished persons in gondolas and feluccas; and when the vessels arrived at the mouth of one of the channels opening into the Adriatic, the Doge dropped a ring into the water, using the words: 'We wed thee with this ring, in token of our true and perpetual sovereignty.' This singular ceremony, which took place on Ascension Day, arose out of an honour or privilege conferred by the pope on the Doge in 1177, consequent on a splendid victory gained by the Venetians over the Emperor Frederic Barbarossa.

BUCEPHALUS (Greek, meaning 'ox-head'), the name of the favourite charger of Alexander the Great, was probably also the name of a peculiar breed of horses in Thessaly. According to tradition, Alexander in his boyhood was the first to break in the steed B., and thus fulfilled the condition stated by an oracle as necessary for gaining the crown of Macedon.—The town BUCEPHALIA, on the river Hydaspes, in India, was founded near the grave of Bucephalus, which died during Alexander's Indian expedition.

BUCER, MARTIN, one of the church reformers of the 16th c., was born, 1491, at Schlettstadt, in Alsace. His real name was *Kuhhorn* (cow-horn), but in accordance with the fashion of his time among scholars, he changed it into its Greek equivalent; Bucer being derived from *bous*, an ox, and *keras*, a horn. At the age of 14, he entered the order of Dominicans. At the suggestion of his superior, he went to Heidelberg to study theology, devoting his attention, however, at the same time to the Greek and Hebrew languages. While

young, he was appointed chaplain to the Elector of the Palatinate. An acquaintance with the works of Erasmus had already inclined B. toward Protestantism, and his views were confirmed by the influence of Luther at the Heidelberg disputations in 1518. Following the example given by Luther at the Diet of Worms (1521), B. became one of the boldest and most decided of the German reformers. In 1523, he went to Strasburg, where he introduced the doctrines of the Reformation. In the disputes between Luther and Zwingli, he adopted a middle course, and endeavoured to make reconciliation between them; but his view of the sacraments, which approached that of Zwingli, exposed him to Luther's harsh reprobation. At the Diet of Augsburg, where he conducted himself with great circumspection and moderation, he generally accorded with the Lutheran views; but, along with other Strasburg theologians, declined to subscribe to the proposed confession of faith, and afterwards drew up the *Confessio Tetrapolitana*. An agreement, however, was subsequently entered into between B. and the Lutherans, and as a disciple of Luther, he appeared at the religious conference of the Reformers held at Leipsic. In consequence of his refusal to sign the *Interim*—a temporary creed drawn up by order of the Emperor Charles V.—B. found his situation irksome in Germany, and therefore accepted the invitation of Archbishop Cranmer (1549), and came to England to teach theology at Cambridge, and assist Paul Fagius and others in forwarding the Reformation. His modesty, blameless life, and great learning gained many friends in England; but his labours were soon interrupted by death, February 27, 1551. His remains were interred in a church at Cambridge with great solemnity; but during the reign of Mary, his bones, with those of Fagius, were taken from their graves, and burned in the market-place. His constant attempts to express himself in language agreeable both to Luther and Zwingli, induced in him at times an obscure, ambiguous, and elusive kind of thought, to which, perhaps, Bossuet refers when he stigmatises B. as 'the great architect of subtleties.' B. was, of course, exposed to many censures and scandals by the assiduous malice of the Roman Catholic theologians, whose fertile imaginations during the Reformation period were exclusively devoted to the manufacture of indecent calumnies; but by Protestant writers he has been highly commended, and by some has been ranked above even Luther and Melancthon. His best work is a translation and exposition of the Psalms, which he published under the pseudonym Aretinus Felinus (Strasburg, 1529). Hubert intended to edit the whole of B.'s writings in ten volumes, but only one volume appeared (Basel, 1577).

BUCEROS. See HORNELL.

BUCH, LEOPOLD VON, one of the most celebrated of German geologists, was born at Stolpe, in Prussia, in 1774 or 1777, and received instruction under Werner at the Mining Academy, Freiberg. He afterwards travelled in pursuit of his favourite science, through all the states of Germany, through Scandinavia as far as the North Cape, and through several parts of Great Britain, France, and Italy, visiting the Canary Islands in 1815. His chief writings are—*Geological Observations during Travels in Germany and Italy* (1802—1809), a *Physical Description of the Canary Islands* (1825), *Travels in Norway and Lapland* (1810), and essays *On the Jura in Germany* (1839), and *On the Mountain Systems of Russia* (1840), with several monographs on Ammonites (1832), and

other fossils. He was also the author of an excellent geological chart of Germany and its neighbouring states, published in 42 plates (2d ed., Berlin, 1832). He died in Berlin, March 4, 1853. B. has been described by an eminent scientific man as 'the only geologist who has attained an equal fame in the physical, the descriptive, and the natural history departments of his science. In all these, he has been an originator and a discoverer.'

BUCHAN, the north-east district of Aberdeenshire, consisting of about a fourth of the county, lying between the Ythan and the Doveran. Its surface is undulating, the highest points being Mormond Hill in the north, 742 feet, and Dudwick Hill in the south, 562 feet. Portions of the coast are bold and precipitous, especially for a few miles east of the Doveran mouth, where Troup Head is 600 feet high, and south of Peterhead, where the coasts rise from 70 to 100 feet. Among the rocks five miles south of this town are the famous Bullers of B., a huge vertical well in the granite margin of the sea, 50 feet diameter, and 100 feet deep, into the bottom of which the sea rushes by a natural archway, and, in storms, dashes up the sides with great violence. The eastern parts of B. consist chiefly of granite and gneiss, and the western of clay-slate and old red sandstone. The chief seats of population are Peterhead, Fraserburgh, Macduff, and Turriff. B. contains several so-called Druid circles, as well as the remains of the Abbey of Deer, and of several castles belonging to the Comyns, who held the earldom of B., but forfeited their title and property in 1309.

BUCHAN-NESS, the easternmost promontory of Scotland, in the north-east of Aberdeenshire, three miles south of Peterhead, in lat. 57° 28' N., and long. 1° 46' W. A light-house, 130 feet high, with a revolving light, has been erected here. It may be stated that the low rocks at Peterhead stretch a little further east than the Buchan-ness. In the sea off the B. lie the Buchan Deeps, a great trough 50 to 90 fathoms deep, and 25 miles broad, and stretching south nearly as far as the Bell-rock. Outside lie the Long Forties, a bank at the depth of 35—45 fathoms, and 10—20 miles broad.

BUCHANAN, GEORGE, one of the most learned men of the 16th c., and a distinguished poet and historian, was born of poor parents at Killearn, in the county of Stirling, in February 1506. He was sent to the university of Paris by his uncle, who died two years afterwards, leaving B. without the means of prosecuting his studies. He returned home, served in one campaign against the English, and entered St Andrews University in 1524, where, in the following year, he took his degree of B.A. In 1526 he went to Paris, and became a student in the Scots College there. He subsequently obtained a professorship in the college of St Barbe, but returned to Scotland about 1537. During his residence on the continent, B. adopted the tenets of the reformed faith. A satire entitled *Somnium*, exposing the Franciscans, brought down upon him the wrath of the priests; and he had resolved upon seeking safety in his old college at Paris, when King James V. took him under his protection, and intrusted him with the education of one of his illegitimate sons. At the request of the king, B. wrote another and more pungent satire against the monks, entitled *Franciscanus*, increasing their anger, and rousing especially the bitter hatred of the powerful Cardinal Beaton, who, after a time procured B.'s arrest, and even went so far as to offer the king money for his life. Though to James was entirely due the publication of the offensive satire, he did not interfere to protect the

poet, who, however, contrived to effect his escape to Paris. After spending some years at Bordeaux and Paris in tuition, he accompanied the learned Portuguese, Govea, to the university of Coimbra, in Portugal, as one of his associates. After the death of Govea, B. was arrested as a heretic, and was for some time detained in a monastery, where he began his splendid Latin metrical version of the Psalms. In 1551, being restored to liberty, he went to England; but soon afterwards went to Paris. About 1560, he returned to Scotland, where he made an open confession of Protestantism. His reputation as a scholar gained for him a good reception at the court of the young queen, Mary, whose classical tutor he became. But his religious and political principles attached him to the party of the Regent Moray, by whose influence he was appointed Principal of St Leonard's College, in St Andrews University, in 1566. In the following year, he was chosen Moderator of the General Assembly—a very high honour for a layman. The doings of Mary, which scandalised the Scottish public, disgusted her tutor also, and he accompanied the Regent Moray to England, in order to give evidence against her before the commissioners appointed by Elizabeth to inquire into her guilt. His *Detectio Mariæ Reginae*, laid before these functionaries, was industriously circulated by the English court. In 1570, B. was appointed tutor to the young king, James VI. (afterwards James I.), who owed to him all the erudition of which in later life he was so vain. No considerations of the future position of his pupil were allowed to interfere with B.'s treatment of him, which was strict, if not even stern; and in dedicating his *De Jure Regni apud Scotos* to the young monarch in 1579, he warned him against favourites with a freedom remarkable not only in a subservient but in any age. In 1570, B. was appointed director of Chancery, which he soon resigned, and in the same year was made keeper of the Privy Seal, an office which he retained until within a short time of his death. The latter years of his life were devoted to the composition of his *History of Scotland* (published in 1582). He died thirty days after its publication, on the 28th September 1582, and was buried in Greyfriars Churchyard, Edinburgh. As a scholar, B. was unrivalled in his age; and he wrote Latin poetry 'with the purity and elegance of an ancient Roman.' He was alike humorous, sarcastic, and profound. His *History*, written in Latin, is remarkable for the richness, force, and perspicuity of its style, though it has been found fault with for the partiality of its narration of contemporary events; and two years after the author's death, it, as well as *De Jure Regni*, &c., was condemned by the Scottish parliament, and every person possessed of copies was ordered to surrender them within 40 days, in order that they might be purged of 'the offensive and extraordinary matters' they contained. Two collected editions of B.'s works have been published—one by Ruddiman in 1715, 2 vols. folio; and another by Burman, Leyden, in 2 vols. quarto, in 1725. The translations that have yet appeared are far from doing justice to the original.

BUCHANAN, JAMES, a distinguished American statesman, was born in Franklin county, Pennsylvania, April 13, 1791. He was educated at Dickenson College, adopted the profession of the law, and, in 1814, was elected a member of the Pennsylvania House of Representatives. In 1820, he was chosen a member of Congress, and remained so till March 4, 1831. In May of that year, he was nominated ambassador to Russia. He returned to the United States in 1834, and soon after was

elected a member of the Senate; he was re-elected in December 1836, and 1843. Appointed by President Polk, in March 1845, secretary of state, he held that office till the close of Polk's presidency. Ambassador to England in 1854, B. resigned that post the following year, and in 1856 was elected President of the United States. His administration has been, on the whole, popular, although his policy in regard to the question of slavery has given great dissatisfaction to the abolitionists of the northern states.

B'UCHANITES, an extraordinary sect of fanatics, which sprang up in the west of Scotland in 1783, but has now become extinct. The founder of the sect was Mrs or Lucky Buchan, born in Banffshire in 1733, of humble parentage. Her maiden name was Elspeth Simpson. She early fell into habits of vice, but with her licentiousness were combined a sort of religious fervour and extreme Antinomian opinions. In 1782, being resident in Glasgow with her husband, a potter, who ultimately divorced her, she became acquainted with the Rev. Hugh White, minister of the Relief congregation in Irvine, a weak vain man and coarse declamatory preacher, who adopted her opinions, for which he was deposed by his presbytery, and began along with her to found a new sect in Irvine. Popular tumults arose, which led to her expulsion from the town in May 1784. Mr White and his wife, with other devoted adherents, male and female, accompanied her, regarding her as a divinely commissioned person, and expecting her to lead them to the place where Christ was speedily to appear again on earth. She was addressed as 'Friend Mother in the Lord,' and among other more blasphemous pretensions, gave herself out to be the woman mentioned in Rev. xii., White being represented as the 'man-child' whom she had brought forth. She and her followers travelled towards Nithsdale, and found a resting-place in a barn at New Cample, near Thornhill, where they afterwards built for themselves a house of one apartment with a loft, in which they all dwelt, supported chiefly by the money of the more wealthy of their number. A few additional persons joined them. They lived in expectation of being translated to heaven without death; and on one occasion, after a fast of extraordinary duration, by which many of them were reduced to a very spectral condition, were led out by their prophetess to a hill-top to be immediately taken up, but returned disappointed. After this, dissensions began to arise among them; and some, recovering from their infatuation, left the society. Their expected heaven was one of mere sensual delights; and it is now sufficiently ascertained that they lived in unrestrained sexual intercourse—for they condemned marriage as unworthy of Christians—and that they systematically practised infanticide. Yet they were protected from the outbreaks of popular indignation, and no investigation was made by the authorities. On the failure of their means of subsistence, they took a farm in a moorish part of the stewartry of Kirkcubright; and those who remained of them accumulated by their industry the means of purchasing a small property, on which was built the first house of the village of Crocketford, where they finally became extinct, the last of them surviving till 1846, full even in his old age of the strange delusions of his youth, and preserving in his house the bones of Lucky Buchan, which were buried with him in his grave.—See *The Buchanites from First to Last*, by Joseph Train. (Edin. 1846).

BUCHAREST, BUKHAREST, or BUKHOREST, the capital of Walachia, in a rich and

extensive plain on the Dumbovitz, a tributary of the Argish, in lat. 44° 26' N., and long. 26° 5' E. It is a straggling and uninteresting town, with poor mean houses, many of them of mud; and unpaved and unlighted streets. There are, however, some handsome hotels; and the churches are numerous and many-spired, giving to the place a picturesque appearance. The hospodar's palace, a large structure in the centre of the town, has no claim to architectural beauty. The number of cafés and gambling-tables is excessive; and altogether B. has the unenviable reputation of being the most dissolute capital in Europe. The *corso*, or public promenade, is a miniature Hyde Park. B. is the entrepôt for the trade between Turkey and Austria, the chief articles of commerce being grain, wool, salt, honey, wax, building-timber, and cattle. It has some small manufactures of woollen cloths and carpets. B. has at various times suffered considerably at the hands of the Russians, and is remarkable as the place where in May 1812 a treaty of peace was concluded between Turkey and Russia, by which the former ceded to the latter the province of Bessarabia and a portion of Moldavia; Russia waiving her claim to all other territories she had conquered. This treaty also defined the Pruth as the boundary-line between the two empires. During the Crimean campaign, B. was successively occupied by Russians, Turks, and Austrians. Pop. 60,000.

BUCHEZ, PHILIPPE BENJAMIN JOSEPH, a French physician, writer, and President of the National Assembly in 1848, was born in 1796 at Matagne la Petite, in the department of Ardennes, and studied medicine in Paris, 1815. He became involved in several plots against the Bourbons, was active in the conspiracy of the French Carbonari (q. v.), and supported the doctrines of St Simon (q. v.); but, after editing for some time the communist journal, *Le Producteur*, he separated from his colleagues. Curiously enough, during all his active career of underhand politics, he was prosecuting his learned studies, and in 1825, published a *Précis Élémentaire d'Hygiène*, besides editing the *Journal des Progrès des Sciences et Institutions Médicales*. After the revolution, 1830, B. established and conducted the journal *L'Européen*, the organ of Neo-Catholicism; and in concert with M. Roux Lavergne, began a republican history of the French Revolution. All his writings are marked by original views and arguments in favour of the belief in human progress. After the February revolution, 1848, B. was made President of the National Assembly; but, by his want of energy during the disturbance of May 15, he incurred the censure of all parties. Since the inauguration of the Empire, B. has returned to his scientific studies.

BUCK, a name sometimes distinctively appropriated to the male of the **FALLOW DEER** (q. v.), the female of which is a *Doe*. But the term B. is often also applied to the male of other species of deer, as of the **ROEBUCK** (q. v.), although never to that of the **Red Deer** (see **DEER**), which, when mature, is a **STAG** or **HART**.

BUCKBEAN, or **MARSH TREFOIL** (*Menyanthes trifoliata*), a plant of the natural order *Gentianeæ* (q. v.), the only known species of its genus, widely distributed in all the colder parts of the northern hemisphere, and common in Britain. It has been described as 'perhaps the most beautiful' of all British plants. It grows in marshy places, its creeping root-stocks (or rhizomes) and densely matted roots often rendering boggy ground firm. The leaves are ternate, like those of the trefoils or clovers, and are supported on pretty long stalks.

The flower-stalk bears a compound raceme of 10—20 white flowers, externally tipped with red. The calyx is 5-parted; the corolla funnel-shaped, with a spreading 5-lobed limb, shaggy on the inner surface, with thick fleshy hairs. The fruit is a one-celled, two-valved capsule. The leaves are destitute of smell, but very bitter. From them is prepared a valuable bitter extract, which has long been used in



Buckbean.

cases of dyspepsia and disorders of the bowels, and which was also formerly employed in intermittent fevers. An infusion is also sometimes used, and sometimes the dried and powdered leaves. The whole plant seems to possess the same bitter and tonic properties. It is sometimes used in Germany as a substitute for hops. The root-stock, however, which is black and jointed, contains a considerable quantity of a kind of starch, which is separated from the bitter substance, and used as food in some of the northern parts of Europe.

BU'CKEYE. See **HORSE CHESTNUT**.

BU'CK-HOUND, a hunting-dog once common in Britain, when buck-hunting was a most fashionable amusement, but of which few packs now exist. The B. resembles a dwarf **STAG-HOUND** (q. v.), and possesses great strength and perseverance. Bucks are, however, often hunted by other kinds of hounds.

BUCKINGHAM, DUKE OF, GEORGE VILLIERS, the favourite of James I. and Charles I. of England, third son of Sir George Villiers, was born at his father's seat of Brookesley, Leicestershire, August 20, 1592. Knighted in April 1616, and sworn a gentleman of the bedchamber on January 1, 1617, he became Master of the Horse and a Knight of the Garter. Created the same year Baron of Whaddon and Viscount Villiers, and in January following Earl of B., and sworn of the privy-council, he was next made a Marquis, and appointed Lord-admiral of England, Chief-justice in Eyre of parks and forests south of the Trent, Master of the King's Bench Office, High Steward of Westminster, and Constable of Windsor Castle. In 1620, he married the daughter of the Earl of Rutland, the richest heiress in the kingdom. In 1623, while negotiations were in progress with the Spanish court for a marriage between the Infanta and the Prince of Wales, afterwards Charles I., B. persuaded the latter to go himself to Madrid and prosecute his suit in person. The ultimate failure of the negotiations has been ascribed to B.'s arrogance. In his absence he was created a Duke, and on his return nominated Lord-Warden of the Cinque Ports, and Steward of the Manor of Hampton Court. By his advice, James declared war against Spain. On the accession of

Charles I., in 1625, B. maintained his ascendancy at court, but after the ill-fated expedition against Cadiz, he became odious to the nation, and was saved from impeachment only by the king's dissolving parliament. The treaty for the marriage of Charles with the Princess Henrietta of France was concluded by him, but he was not allowed to return to Paris, in consequence of his audacity in lifting his eyes to the French queen. In 1627, with an armament of 100 sail and 7000 soldiers, he appeared before Rochelle, then in possession of the Huguenots, who refused him admission within the harbour. His troops then made an ill-conducted descent on the neighbouring Isle of Rhé, and returned to England beaten and disgraced. He soon after undertook a second expedition to Rochelle, and proceeded to Portsmouth for embarkation, when he was assassinated by a discontented subaltern-officer, named Felton, August 23, 1628, in his 36th year.

BUCKINGHAM, 2d DUKE OF (GEORGE VILLIERS), a brilliant but profligate nobleman, son of the preceding, was born at Wallingford House, Westminster, January 30, 1627, and studied at Cambridge. On the outbreak of the civil wars, he served in the royal army; his estates were confiscated by the parliament, and he took refuge on the continent. He attended Charles II. into Scotland, and after the battle of Worcester, in 1651, went again into exile. Returning secretly into England, he married, in 1657, the daughter of Lord Fairfax, the parliamentary general, to whom his forfeited estates had been assigned. Arrested by Cromwell, and committed to the Tower, he was afterwards removed to Windsor Castle, but released on the abdication of Richard Cromwell. At the Restoration, he recovered his estates, and was made Master of the Horse, and sworn of the privy-council. He was mainly instrumental in the fall of the chancellor, Clarendon, whom he made an object of ridicule to the king, and was one of Charles's confidential ministers, who, from the initial letters of their titles, were called 'the Cabal.' Engaging in 1666 in some treasonable practices for effecting a change in the government, he was deprived of all his offices at court, but, on his submission, soon recovered them. In 1670, he was sent ambassador to France, and was employed on some other embassies. He was elected chancellor of the university of Cambridge in 1671. Supporting the nonconformists in 1674, he opposed the Test Act, and was deeply engaged in the Popish Plot. After Charles's death, in 1685, B. retired to his manor of Helmsley, in Yorkshire, and amused himself with the chase. He died at Kirkby-Moorside, April 16, 1688, and was interred in Westminster Abbey. The manufacture of glass and crystal is said to have been introduced into England from Venice by him. B. was the author of several stage-plays, of which the best is *The Rehearsal*, a comedy; *A Satire against Mankind*; and some poems.

BUCKINGHAM, JAMES SILK, a modern traveller and popular lecturer, the son of a farmer, born in 1786, at Flushing, near Falmouth, Cornwall; when a boy, went to sea, and made several voyages to Lisbon. After years of unsettled and wandering life, he, in 1816, established a journal at Calcutta, but the boldness of his censures on the Indian government led to his expulsion from the presidency of Bengal. His lectures, on his return to England, against the East India Company monopoly, and in support of opening the trade to China, tended greatly to direct public attention to the subject. In London, he established *The Oriental Herald*, and *The Athenæum*, now the leading weekly literary journal. Subsequently, he travelled through the United

States, and from 1832 to 1837 was M.P. for Sheffield. He was projector and secretary of the British and Foreign Institute, literary club, 1843—1846; and president of the London Temperance League, 1851. B. is the author of numerous works of travel on the continent, in the east, and in America. He was engaged on his autobiography, two volumes of which were published before his death, which took place June 30, 1855.

BU'CKINGHAM, the old county town of Buckinghamshire, in the north part of the shire, is situated on the Ouse—which flows round the town, and has three bridges. B. is 61 miles north-west of London by rail. It returns 2 members to parliament. Pop. 8069. Bobbin lace is the chief manufacture, but it is on the decline. B. is a place of considerable antiquity. Edward the Elder fortified it in 978, and the Danes captured it in 1010. The Earls of Buckingham built a castle here soon after the Norman conquest. Edward III. made it a staple for wool. Here Catharine of Aragon received the news of the battle of Flodden, and Charles I. had his head-quarters in B. for a few days in 1644. It suffered much by fire in 1725.

BU'CKINGHAMSHIRE, a south-midland county of England, its greatest length being about 54 miles, its average breadth 18, and total area 738 square miles. The plastic clay tertiary strata occupy the southern parts of the county, which is finely diversified with hill and dale, wood and water. To the north is a broad chalk-band, including the Chiltern range of chalk-hills, which enter from Oxfordshire, and stretch across the county in a north-east direction into Bedfordshire, partly covered with heath and wood, and near Ivinghoe and Wendover, above 900 feet high. Sloping north from these hills, and crossed by narrower bands of greensand and oolite, is the extensive and very fertile vale of Aylesbury, watered by the Thame. The chief rivers are the Thames, bordering the county on the south-west, the Ouse, Ousel, Colne, and Thame, the latter two falling into the Thames. The Grand Junction Canal, and the Great Western and North-western Railways, intersect the county on the east and south. The climate of Bucks is mild and healthy; the soil is mostly good, chalk and clay predominating. About half the county is under tillage, the rest in meadows and pasture. The agriculture is not equal to the capabilities of the land, which is often overcropped and exhausted. The farms are generally small, averaging 200 acres. The cottages are generally good. Wheat and beans are the principal crops. The chief dairy product is butter, of which four to five millions of pounds are annually sold, chiefly in London. In the vale of Aylesbury, fattening of cattle is extensively carried on; the sheep are noted for their fine and heavy fleeces; and large numbers of ducks are reared for metropolitan consumption. Beech and oak are the chief timber-trees, but box and juniper are also grown. The chief manufactures are paper, straw-plait, and thread-lace. In 1851, the population was 163,723; schools, 475, with 19,048 scholars; places of worship, 499 (Church of England, 226; Wesleyans, 120). B. returns 3 members to parliament. The chief towns are Aylesbury, Buckingham, Marlow, and Wycombe. B. contains some Roman and British remains, as traces of Watling, Ickneld, and Akeman Streets or Ways. The chief ecclesiastical ruins are those of Missenden and Notley Abbey, the latter of which has been converted into farm-buildings. There are many examples of early English and decorated architecture. The church of Chetwode, near Buckingham (13th c.), contains some very fine examples of ancient glass-staining. Many

events of historical interest occurred in this county. It was the scene of contest in the civil wars of Stephen and John. At Chalfont St Giles, Milton finished his *Paradise Lost*, and at Horton, he wrote *L'Allegro*. At Hampden lived the great patriot of that name; Waller was proprietor of Beaconsfield Manor; Atterbury was born at Milton; Stoke Poges Churchyard suggested Gray's *Elegy*, and is the place of his burial; at Olney, Cowper lived; at Gregories, near Beaconsfield, Burke died and was buried; Scott, the biblical commentator, was rector of Aston Sandford; Herschel's great telescope still stands at Slough, where he made most of his important discoveries; and at Stowe is a magnificent mansion—one of the finest in England, alike for its extent and architecture and the beauty of its site—formerly belonging to the Duke of Buckingham, who disposed of it some years ago.

BUCKLAND, WILLIAM, D.D., a distinguished geologist, whose labours tended greatly to the advancement of science, was born at Axminster, Devonshire, England, in 1784. Educated at Winchester and Oxford, he was appointed, in 1813, Reader in Mineralogy in Oxford University. The same year, he was elected a Fellow of the Geological Society, and he was twice its president. In 1818, he became Reader in Geology at Oxford, and was elected Fellow of the Royal Society. In 1822, he received the Copley medal, for an account of an assemblage of fossil-teeth and bones of 22 different animals, discovered in a cave at Kirkdale, Yorkshire; and in 1823, he published a treatise founded on it, entitled *Reliquiæ Diluvianæ, or Observations on Organic Remains, attesting the Action of a Universal Deluge*, a theory which he afterwards saw cause to modify. In 1825, B. was appointed a canon of Christ Church, Oxford. In 1827, he was chosen a member of the Council of the Royal Society; in 1832, he was elected president of the British Association at Oxford, its second meeting; and in 1836, he published his *Bridgewater Treatise, Geology and Mineralogy considered with Reference to Natural Theology* (2 vols. 8vo). To the Transactions of the Geological Society he contributed many valuable papers; and his sketch of the structure of the Alps, in the *Annals of Philosophy*, is esteemed one of the most interesting of his geological writings. In 1845, he was made Dean of Westminster, and in 1847 a trustee of the British Museum. Under his great and continuous labours to benefit others, his mental faculties gave way some years before his death, which took place August 14, 1856.

BUCKLANDIA, a magnificent and beautiful evergreen tree of the natural order *Hamamelidææ* (q. v.), a native of the Himalaya mountains. It grows unbranched to the height of 40 feet, the trunk sometimes 21 feet in girth at 5 feet from the ground. The foliage is thick, bright, and glossy. The timber is not valuable. Dr Hooker thinks that this tree would probably succeed in the mild climate of the west of England.

BUCKLE, HENRY THOMAS, an author who attained a sudden notability in 1857 by the publication of the first volume of a work, entitled *The History of Civilisation in England*. He was born at Lee, in Kent, November 24, 1823, and was for a very short time at Dr Holloway's school in Kentish-Town, near London. No other school and no university claims credit for his education, which nevertheless was in the highest degree liberal. An easy fortune, a large library, and hitherto celibate condition, have enabled Mr B. to gratify, without any sort of impediment or restraint, an all-absorbing love of letters, and there are few men now in England

who could be said more completely to realise the ideal of a studious life.

The first volume of the *History of Civilisation in England*, although extending beyond 800 pages, only contains the Introduction, and even that is not complete. B.'s plan involved, before tracing the particular history of English civilisation, a general consideration of the progress of those European countries, England, France, Germany, Scotland, Spain, and America, in which the elements of modern civilisation are originally found. But the author's preliminary examination has overtaken only two of these countries—viz., England and France. His objects, however, are clear. They are (1.) to discover what is the essential spirit of a nation's history apart from particular men and events, and (2.) to trace out the causes of the progress which has been made in England and France. Under the first head, B. endeavours to shew that the spirit or character of a people is dependent on material circumstances, such as soil, climate, food, aspect of nature, and the like, and to be sought for in these; under the second head occurs the theory (the vigorous application of which by B. has startled and offended many readers), viz., that the progress of society depends upon scepticism; that the retarding force is credibility (under which term, however, B. includes more than will please churchmen); and that the excessive 'protection' exercised by governments, the nobility, the church, &c., over the 'people,' has dwarfed and held back the spirit of freedom and civilisation. These, and other positions, are defended by B. with great vigour, ingenuity, and lucidity of argument and expression, and have been acknowledged, even by the adherents of an exactly opposite school, to contain much sound truth, which is too often overlooked.

Two large editions of B.'s volume have been sold. The second volume is (1860) nearly ready for publication.

BUCKLER, in old armour, was a kind of shield worn on the left arm. The bucklers worn by the *hastati*, or spearmen, among the ancient Romans, were about 4 feet long, by 2½ in width, made of

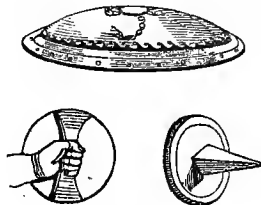

Bucklers.

boards, covered on the inside with linen and sheepskin, and on the outside with iron-plate. In the middle ages, the B. was round, oval, or square in shape, and was frequently made of wicker-work or of hide, strengthened by metal-plates.

BUCKLES, metal instruments, consisting of a rim and tongue, used for fastening straps or bands in dress and harness. The use of B., instead of shoe-strings, was introduced into England during the reign of Charles II. They soon became very fashionable, attained an enormous size (the largest being called Artois buckles, after the Comte d'Artois, brother of the king of France), and were usually made of silver, set with diamonds, and other precious stones. In the latter half of last century the manufacture of B. was carried on most extensively in Birmingham, there being at one time

BUCKSKIN—BUCKU.

not less than 4000 people employed in that town and its vicinity, who turned out 2,500,000 pairs of B. annually, at the average value of 2s. 6d. per pair. When the trade was at its height, however, fashion changed, and in 1791 we find buckle-makers petitioning the Prince of Wales for sympathy, on the ground that the introduction of shoe-strings had nearly ruined their trade. The prince promised to assist them as far as he could, by wearing B. himself, and enjoining his household to do the same; but fashion was too strong even for him, and B. became almost extinct. The opportunity, however, as is remarked by a writer in *Notes and Queries* for 1854, 'which buckles afford of ornament and expense has preserved them as a part of the court-dress; and of late years they have appeared a little in private society. They are generally, though not always, worn when a prince of the royal family is of the party; and at the king's private parties, although the rest of the dress be that usually worn, buckles are almost indispensable.' Large shoe-buckles, of silver or other metal, are still worn by the clergy of several continental countries, as part of their ordinary costume.

BU'CKSKIN is a fanciful name for a heavy-made, strong-twilled woollen fabric, for trousers—highly milled to about the usual width for such goods—27 inches; and cropped and finished, with the pile or nap so shorn as to shew the texture through it.

BUCKSTONE, J. B., a distinguished comedian and dramatic writer, was born in the suburbs of London, in 1802. Preferring the excitement of the stage to the monotony of an attorney's office, he sought and soon found an opportunity in a provincial town for the display of his theatrical abilities. After a probation in the country, he appeared at the Surrey Theatre in 1823, and his success was so unequivocal, that he was soon engaged by the 'management' of the Adelphi Theatre, where he continued for many years as leading low comedian. He afterwards played at the Haymarket and Drury Lane Theatres. He is now (1860) lessee of the Haymarket. B.'s acting is not more noted for its comicality and humour, which never degenerates into vulgarity, than for its distinct appreciation of the peculiar traits in each individual character he assumes. In all his delineations there is, as in the pictures of the old masters, the same broad general effect, but the details of each are wrought out with the care and minuteness of a pre-Raphaelite. But B. is fully more celebrated as an author than an actor. He has written more than 150 pieces for the stage, many of which enjoy a rare popularity. Among the best known are, *The Green Bushes*, *The Flowers of the Forest*, *Luke the Labourer*, *The Wreck Ashore*, *The Rough Diamond*, *Good for Nothing*, *The Irish Lion*, and *The Alarming Sacrifice*.

BU'CKTHORN (*Rhamnus*), a genus of shrubs or small trees of the natural order *Rhamnaceæ* (q. v.), distinguished by a bell-shaped 4-5-cleft calyx, which divides around the middle after flowering, the upper part falling away, and the base remaining and adhering to the fruit; which is globose, and sometimes succulent, sometimes rather dry or spongy, with 2-4 stones. The petals are sometimes wanting. Some of the species are dioecious, some hermaphrodite. They are numerous, and natives of most of the tropical and temperate regions of the world.—The COMMON BUCKTHORN (*R. catharticus*) is a deciduous shrub or low tree, frequent in England and in other parts of Europe and the north of Asia. The leaves are ovate, crenate, and bright green; the branches spiny; the flowers small, yellowish-green, and densely clustered; male and female flowers on

separate plants; the berries about the size of peas, globular, bluish-black, nauseous, and violently purgative. They were formerly much used in medicine, but now more rarely, and only in the form of a syrup prepared from their juice. They supply the *Sap Green* (q. v.) or Bladder Green of painters. The bark affords a beautiful yellow dye. The B. is sometimes planted for hedges, but is of too straggling a habit.—The ALDER BUCKTHORN, or BERRY-BEARING ALDER (*R. frangula*), is also a native of



Alder Buckthorn (*Rhamnus frangula*).

Britain, and is frequent in woods and thickets throughout Europe. It is a shrub, rarely a small tree, with spineless branches, oval entire leaves, and small, whitish, axillary flowers, which are in general somewhat clustered. The bark of the twigs is gray, and has a very disgusting smell and a nauseous bitter taste. It was formerly used in medicine, along with that of the last species, and has recently been recommended in many quarters as a remedy for intermittent fevers. It contains principally an acrid bitter extractive, a volatile oil containing hydrocyanic acid, and a yellow colouring matter called *Rhamnin*. The berries are small and black, and violently purgative. It is objected to their use in medicine that much sickness and thirst attend it. The charcoal of the wood is light, and is used for the preparation of gunpowder. The bark, leaves, and berries are used for dyeing; the bark for dyeing yellow, and with preparations of iron, black; the unripe berries to dye wool green and yellow; the ripe berries to dye it bluish-gray, blue, and green. The flowers are peculiarly grateful to bees.—DYER'S BUCKTHORN (*R. infectorius*) is a low shrub, abundant in the south of Europe, whose unripe fruit yields a brilliant yellow dye. The berries and inner bark of *R. tinctorius*, a native of Hungary, are also used in dyeing; and the berries of *R. saxatilis*, a procumbent shrub, growing amongst rocks as far north as Switzerland. The *French Berries*, *Avignon Berries*, or *Yellow Berries* of dyers, are the fruit of *R. infectorius*, *R. saxatilis*, *R. amygdalina* (or *oleoides*), and *R. Clusii*.—The SEA BUCKTHORN is a shrub of a different genus and order. See SALLOW-THORN.

BU'CKU, a name common to several small shrubs of the genus *Barosma* (formerly included in *Diosma*), natives of the Cape of Good Hope, the leaves of which are used in medicine—sometimes in the form of a powder, more generally of an infusion or a tincture—particularly on account of their powerful operation on the urinary organs, as in chronic inflammation of the bladder, urinary calculus, &c. They

BUCKWHEAT—BUD.

are also used in dyspepsia, rheumatism, and dropsy; and are stimulant and antispasmodic, diuretic, diaphoretic, and tonic. They generally appear in commerce mixed with stalks and fruit. They are smooth, leathery, and shining, more or less crenated or serrated, and are much covered with pellucid dots, which are glands filled with a strongly smelling yellowish volatile oil. The strong odour of B. leaves is generally regarded as disagreeable, but the Hot-tentots perfume themselves with them. They have a warm taste, resembling that of mint.—The genus *Barosma* belongs to the natural order *Rutaceæ*, and is distinguished by regular flowers with 5 petals, 5 fertile and 5 abortive scale-like stamens, anthers bearing a minute terminal gland, and a 5-lobed ovary. The species principally yielding the B. leaves of the shops are *B. serratifolia*, *B. crenata*, *B. crenulata*, and *B. venusta*.

BU'CKWHEAT (*Fagopyrum*), a genus of plants of the natural order *Polygonææ* (q. v.), or, according to many botanists, a subgenus of *Polygonum* (q. v.), distinguished by the central embryo, and by racemes of flowers grouped in panicles. COMMON B. (*Fagopyrum esculentum*, or *Polygonum Fagopyrum*) is a native of the basin of the Volga, the shores of the Caspian Sea, and many parts of Central Asia, from which it is said to have been introduced by the Moors into Spain, and thence to have extended over Europe, in many parts of which, and in some places in Britain, it is now naturalised. Another account represents it as having been brought to Europe by the Crusaders. In France, it is called *Blé Sarra-sin*, or Saracen wheat. It is cultivated on account of the farinaceous albumen of its seeds, which are used, as grain, for food of man and cattle. It is upright, branched, 1—3 feet in height; the leaves are between heart-shaped and arrow-shaped, the flowers pale red, the seed (nut) black and triangular, the angles even (not toothed). The resemblance of this seed in form to the beech-nut is supposed to be the reason of the German name *Buchweizen* (heech-wheat), from which the English name is derived. B. is a very common crop in some parts of Europe, and of the United States of North America; but is seldom sown in Britain, except as food for pheasants. It requires continued dry weather in autumn for profitable harvesting, and this in the climate of Britain cannot well be reckoned on. In Germany, B. is much valued as a crop, particularly for moor-lands and other poor soils. In Bretagne, also, it is as extensively cultivated as wheat. It yields very abundantly, and requires little attention and little manure. Forty bushels or more per acre may be expected, weighing 46 or 48 lbs. per bushel; and notwithstanding the resemblance of the seed to grain in its qualities and uses, wheat, or any other cereal crop, generally succeeds well after B., if care has been taken to keep the land clear by tilling. The seed is most frequently used in the shape of groats, or made into pottage, and in the United States thin cakes are very often made of it. It is very nutritious, containing about 10 per cent. of gluten and 52 per cent. of starch, besides about 6 per cent. of gum and sugar. It is said to be as good as barley for fattening cattle, and better for horses than oats. But as the seed is covered with a very hard rind or thin shell, it must always be shelled before being given to cattle. Poultry are very fond of it. Beer is sometimes brewed from it, and it yields a spiritous liquor of good quality; indeed, it is frequently used in gin-distilleries. As green fodder, the herbage of the plant is said to be more nutritious than clover; but it acts as a narcotic on sheep. Bees delight in its flowers, and in some parts of the United States it is sown on this account. In America the seed

is usually sown broadcast over the land which has been ploughed in autumn or early spring, and well scarified or harrowed. About a bushel and a half of seed is required when sown broadcast, but a bushel is sufficient if drilled with a machine. In the latter case it should not be sown in narrower drills than one foot apart, but two feet is recommended as being better for the succeeding crop, as the wider intervals can be properly cultivated. It should not be sown in England before the middle of May, as the least frost is injurious. When the lower seeds are ripe it should be mown, as they are easily shed out if allowed to stand too long. When bread made from B. forms the principal food of the people, it is thought to have an injurious action on the brain. As a supplementary article, however, it is a favourite among all classes where it is raised.—TARTARIAN B. (*F.* or *P. Tataricum*) is distinguished by the toothed edges of the seeds and its more vigorous growth. It is hardy, and adapted for cold situations. It is a native of Siberia. It is very productive, but the seed falls out when ripe more readily than that of the common species; and the flour is darker coloured, and somewhat bitter.—NOTCH-SEEDED B. (*F.* or *P. emarginatum*) is said to be a native of China. Its seeds are larger than those of Common B., and their angles are winged. When grown in Britain, many of its flowers are generally abortive.—PERENNIAL B. (*F.* or *P. cymosum*) is a native of Nepal, very vigorous in its growth, but producing, at least in Britain, comparatively little seed.—The triangular black seed of Climbing B. or Blackbine (*F.* or *P. Convolvulus*), familiar to every one who has eaten oatmeal cakes or porridge, greatly resembles B., but is smaller. The plant—a very common weed in gardens and cornfields in Britain—also exhibits much similarity, notwithstanding its different habit and twining stem.—DYER'S B. is *Polygonum tinctorium*. See POLYGONUM.

BUCOLIC, a term derived from the Greek, meaning 'belonging to herdsmen,' and equivalent to the Latin term *Pastoral*. See PASTORAL POETRY.

BUD (*gemma*), in Botany, that part of a plant which contains the rudiments of leaves or flowers prior to their development. Buds are distinguished into *leaf-buds* and *flower-buds*, the former producing leaves, and having a power of extension into a branch; the latter producing flowers only, and ordinarily destitute of this power of extension. The different parts of the flower being regarded, however, as *leaf-organs* or altered leaves (see FLOWER), the flower-bud may be regarded as merely a modified leaf-bud; and it is well known that by treatment which checks the luxuriant growth of a plant, it may be caused to produce flower-buds where only leaf-buds could otherwise have been expected to appear—a physiological fact, of which advantage is taken in various ways by gardeners, as by removing portions of the bark and even of the woody part of the stem, root-pruning, confining the roots in a flower-pot, &c. Buds usually appear in the axils of leaves, the terminal bud of a branch being no exception to this rule; and there is no leaf without one or more buds in its axil, although many never pass beyond the most rudimentary state. See BRANCH. In cold and temperate climates, buds are formed about midsummer, beginning to appear as soon as the young branch which bears them has itself been properly developed, and are generally covered with scales and often also coated with resinous matter, by which their tender contents are protected from the severity of winter; but in the trees of warm climates, the protection of scales is generally wanting. Within the leaf-bud, the future

leaves may be discovered, often very curiously folded or rolled up, and the different forms and positions which the leaves assume in the bud, are very characteristic of different kinds of plants. This is called the *vernation* (q. v.) of leaves, and is analogous to the *æstivation* (q. v.) of flowers.



Leaf-bud.

The buds of exogenous plants originate in cellular prolongations of the medullary rays bursting through the bark; those of endogenous plants are in communication with the cellular matter which lies between the bundles of woody tissue in the stem; and buds elongate into branches by the addition of new cellular matter to the extremity. Leaf-buds are capable of subsisting when separated from the parent plant and placed in favourable situations, developing themselves into new plants with the most exact correspondence in their characteristics to the parent plant; and of this gardeners avail themselves in the process of *budding* (q. v.), and in various ways for the propagation of plants. Some plants propagate themselves by a natural detachment of buds (*bulbils* or *bulblets*), modified into a character analogous to that of *bulbs* (q. v.); and bulbs themselves may indeed be regarded as subterranean leaf-buds with thickened scales. The *eyes* of the potato are also subterranean leaf-buds, the tuber being regarded as a thickened subterranean stem; and all plants with subterranean stems produce subterranean leaf-buds, sending above ground only herbaceous annual shoots, as *Asparagus*, the *Banana*, &c. Buds may be produced in exogenous plants from the extremity of any medullary ray, and may be made to spring from a leafless part of the stem by an incision, the effect of which is to direct a greater supply of sap to the part immediately beneath it. In a few plants, buds are produced on the edges, or even on the surface of leaves. In consequence of their power of independent existence, buds have been looked upon by some physiologists as distinct organised beings congregated in the tree or plant, a view which involves exaggeration, and therefore error.—Flower-buds cannot be used for budding, or otherwise for propagation of the plant, but when removed from their original stock, always die.

Some of the lowest animals propagate themselves by buds (*gemmation*), and many of the zoophyte systems or polypidoms extend in this manner. See GEMMATION, REPRODUCTION, POLYPE, and ZOOPHYTES.

BUDA (Slavonic, *Bu'din*; German, *Ofen*), a city of Hungary, forming with Pesth (with which it is united by a magnificent suspension-bridge) the capital of the kingdom, is situated on the right bank of the Danube, about 130 miles south-east of Vienna, in lat. 47° 29' N., and long. 19° 3' E. B. has a highly picturesque appearance, being built round the Schlossberg (Castle-hill) in the form of an amphitheatre, in the midst of a district covered with vineyards. Crowning this centre hill or rock, which has an elevation of 485 feet above the sea, is the citadel; the palace in which are preserved the royal insignia

of Hungary; and an old Gothic church. Behind, and towering above the rock, rises the Blocksberg, strongly fortified, with a precipitous face to the Danube, the slopes of the other sides being occupied with houses. B. has many educational and charitable institutions; and a fine observatory crowns the Blocksberg. It has some celebrated hot sulphur springs, with a temperature of 117° 5' F., from which it derives its German name, *Ofen* (*Oven*). Three of the baths erected by the Turks are still in a perfect state of preservation, and are much frequented by the common people. B. has some manufactures of silk, velvet, woollen, cotton, leather, and gunpowder; and cannon and type foundries; but its chief trade is in wine, of which it produces between four and five millions of gallons annually. This is known as the '*Ofenwein*,' and is of excellent quality. Pop. 50,200. B. is a place of great antiquity, but its importance dates from 1240, when the fortress was erected on the Schlossberg. During the inroads of the Turks, it was regarded as the key of Christendom. It was captured by Solymán the Magnificent in 1526, but retaken in the following year by Ferdinand I., king of Bohemia. In 1541 it was again taken by Solymán, who introduced into it a garrison of 12,000 janizaries; and it remained in the possession of the Turks until 1686, when it was captured by the Duke of Lorraine. During the Hungarian struggle of 1848—1849, the city suffered considerably. The fortifications of B., within recent years, have been greatly strengthened.

BUDAËUS (the Latinised form of *Guillaume Bude*), one of the greatest French scholars of his age, was born in Paris in 1467. He studied there and at Orleans. His works on philology, philosophy, and jurisprudence display extensive learning, but the two best known are the *De Asse et Partibus ejus* (Paris, 1514), which contains a very thorough investigation into ancient coins; and the *Commentarii Linguae Graecae* (Paris, 1519), which greatly advanced the study of Greek literature in France, and is still held in high estimation by classical scholars. B.'s knowledge of Greek was particularly good. His style both in Latin and French is nervous, but harsh, and abounds in Greek constructions. His abilities were manifested not only in literature, but in public business. Louis XII. twice sent him to Rome as ambassador; and Francis I. also employed him in several negotiations. At B.'s suggestion, Francis founded the *Collège de France*, and was also persuaded to refrain from prohibiting printing, which the bigoted Sorbonne had advised in 1533. During his life, B. held several important offices. He was Royal Librarian, *Maitre des Requêtes*, and Provost of Paris. He died 23d August 1540. A collected edition of his works appeared at Basel in 1557. B. was suspected of a leaning towards Calvinism. Certain circumstances render this highly probable. In his correspondence with his friend Erasmus, he repeatedly expresses his contempt for monks and ignorant ecclesiastics, and on one occasion terms the doctors of the Sorbonne 'prating sophists.' Besides, what is perhaps even more conclusive, shortly after his death, his widow and several members of his family went to Geneva, and openly abjured Catholicism.

BUDDHISM, BUDDHA. The religion known as Buddhism (from the title of 'The Buddha,' meaning 'the Wise,' 'the Enlightened,' acquired by its founder) has existed now for 2460 years, and may be said to be the prevailing religion of the world. In Hindustan, the land of its birth, it has now little hold, except among the Nepaulese and some other northern tribes; but it bears full sway in Ceylon, and over the whole Eastern Peninsula; it divides

the adherence of the Chinese with the systems of Confucius and Lao-tse, claiming perhaps two-thirds of the population; it prevails also in Japan (although not the established religion); and, north of the Himalayas, it is the religion of Tibet (where it assumes the form of Lamaism), and of the Mongolian population of Central Asia, and extends to the very north of Siberia, and even into Swedish Lapland. Its adherents are estimated at 400 millions—more than a third of the human race. Yet, until within the last sixteen years, nothing was known in Europe respecting the nature and origin of this world-religion, beyond the vaguest notices and conjectures. About the year 1828, Mr B. H. Hodgson, British resident at the court of Nepal, where Buddhism prevails, discovered the existence of a large set of writings in the Sanscrit language, forming the national canonical books. These books have since been found to be the texts from which the Buddhist scriptures of Tibet, Mongolia, and China must have been translated. The books of the Ceylon Buddhists are in the language called Pali; and though not translations of the Nepalese standards, they are found to agree with them in substance, and to be only another and somewhat later version of the same traditions. Translations from the Ceylon standards are used by the Buddhists of Burmah and Siam. Copies of the Sanscrit books of Nepal, having been sent by Mr Hodgson to the Asiatic Societies of London and Paris, engaged the attention of the eminent Oriental scholar, Eugène Burnouf, who published in 1844 his *Introduction to the History of Buddhism*; and this book may be said to have been the beginning of anything like correct information on the subject among the western nations.

The most diverse opinions had previously prevailed as to the time and place of the origin of Buddhism. Some looked upon it as a relic of what had been the original religion of Hindustan, before Brahmanism intruded and drove it out; a relic of a wide-spread primeval worship, whose ramifications it was endeavoured to trace by identifying Buddha with the Woden of the Scandinavians, the Thoth or Hermes of the ancient Egyptians, and other mythological personages. Others held that it could not be older than Christianity, and must have originated in a blundering attempt to copy that religion—so striking are the many points of resemblance that present themselves. Although the means are still wanting of giving a circumstantial history of Buddhism, the main outline is no longer doubtful. Oriental scholars now concur in fixing the date of its origin about the beginning of the 6th c. B. C., and in making it spring up in the north of Hindustan. According to the Buddhist books, the founder of the religion was a prince of the name of Siddhartha, son of Suddhodana, king of Kapilavastu, which is placed somewhere on the confines of Oude and Nepal. He is often called Sakya, which was the name of the family, and also Gautama, the name of the great 'Solar' race of which the family was a branch. The name Sakya often becomes Sakya-muni (*muni*, in San., means 'solitary,' and is allied to Gr. *monos*, the root of 'monk'), in allusion to the solitary habits assumed by the prince. To Gautama is frequently prefixed *Sramana*, meaning *ascetic*. Of the names, or rather titles, given to Siddhartha in his state of perfection, the most important is the *Buddha*,* which is from

the root *budh*, to know, and according to Wilson, means properly, 'he to whom truth is known:' it is indicative of the leading doctrine of his system. Others are—'The Blessed' (Bhagavat); 'the Venerable of the World;' 'the Bodhisatva,' the import of which will be afterwards explained. The history of this person is overlaid with a mass of extravagant and incredible legend; and at least one eminent Orientalist, Professor H. H. Wilson, thinks it still doubtful whether the Buddha was an actual historical personage, and not rather an allegorical figure. Agreeing that the doctrine was introduced about the time assigned, he thinks it more likely that it originated with a school formed of persons of various castes, comprising even Brahmans. But by Oriental authorities generally, the Buddha is received as the actual personal founder of the religion that goes by his name.

Assuming that the Buddha was a real person, and that there is a basis of fact under the mass of extravagant fable with which he is surrounded, the history of Buddhism may be thus briefly outlined: The Prince Siddhartha gives early indications of a contemplative, ascetic disposition; and his father, fearing lest he should desert his high station as Kshatriya (see HINDUISM and CASTE) and ruler, and take to a religious life, has him early married to a charming princess, and surrounded with all the splendour and dissipation of a luxurious court. Twelve years spent in this environment only deepen the conviction, that all that life can offer is vanity and vexation of spirit. He is constantly brooding over the thought that old age, withered and joyless, is fast approaching; that loathsome or racking sickness may at any moment seize him; that death will at all events soon cut off all present sources of enjoyment, and usher in a new cycle of unknown trials and sufferings. These images hang like Damocles' swords over every proposed feast of pleasure, and make enjoyment impossible. He therefore resolves to try whether a life of austerity will not lead to peace; and, although his father seeks to detain him by setting guards on every outlet of the palace, he escapes, and begins the life of a religious mendicant, being now about 30 years old. To mark his breaking off all secular ties, he cuts off the long locks that were a sign of his high caste; and as the shortened hair turned upwards, he is always represented in figures with curly hair, which induced early European writers to consider him as of Ethiopian origin. He commences by studying all that the Brahmans can teach him, but finds their doctrine unsatisfactory. Six years of rigorous asceticism are equally vain; and resolving to return to a more genial life, he is deserted by his five disciples, and then undergoes a fierce temptation from the demon of wickedness. But no discouragement or opposition can divert Sakya-muni from the search after deliverance. He will conquer the secret by sheer force of thinking. He sits for weeks plunged in abstraction, revolving the causes of things. If we were not born, he reflects, we should not be subject to old age, misery, and death; therefore, the cause of these evils is birth. But whence comes birth or continued existence? Through a long concatenation of intermediate causes, he arrives at the conclusion that ignorance is the ultimate cause of existence; and therefore, with the removal of ignorance, existence and all its anxieties and miseries would be cut off at their source. Passing through successive

* There is a confusing variety in the modes in which this name is spelled by European writers. S. Hardy, in his *Manual of Buddhism*, gives more than fifty forms that have come under his notice. Some of the more common are: Bud, Bod, But, Budh, Boedd, Bhood,

Budo, Buddow, Boutta, Poota, Poth, Pot. The Chinese, owing to the meagreness of their articulations, seem to have been unable to come nearer to the real sound than Fo, Foe, or Fohi; from the same cause, they convert Brahma into Fan.

stages of contemplation, he realises this in his own person, and attains the perfect wisdom of the Buddha. The scene of this final triumph received the name of Bodhimanda (the seat of intelligence), and the tree under which he sat was called Bodhidruma (the tree of intelligence), whence Bo-tree. The Buddhists believe the spot to be the centre of the earth. Twelve hundred years after the Buddha's death, Hiouen-Tsang, the Chinese Pilgrim, found the Bodhidruma—or a tree that passed for it—still standing. Although the religion of Buddha is extinct in the neighbourhood, there are, about 5 miles from Gaya Proper, in Bahar, extensive ruins and an old dagoba, or a temple, which are believed to mark the place. Near the temple there flourished, in 1812, a peepul-tree, apparently 100 years old, which may have been planted in the place of the original Bo-tree.

Having arrived at the knowledge of the causes of misery, and of the means by which these causes are to be counteracted, the Buddha was now ready to lead others on the road to salvation. It was at Benares that he first preached, or, in the consecrated phrase, 'turned the wheel of the law';* but the most important of his early converts was Bimbisara, the sovereign of Magadha (Bahar), whose dynasty continued for many centuries to patronise the new faith. During the forty years that he continued to preach his strange gospel, he appears to have traversed a great part of Northern India, combating the Brahmans, and everywhere making numerous converts. He died at Kusinagara (in Oude), at the age of 80, in the year 543 B. c.; and his body being burned, the relics were distributed among a number of contending claimants, and monumental tumuli were erected to preserve them. See TOPES.

The most important point in the history of Buddhism, after the death of its founder, is that of the three councils which fixed the canon of the sacred scriptures and the discipline of the church. The Buddha had written nothing himself; but his chief followers, assembled in council immediately after his death, proceeded to reduce his teaching to writing. These canonical writings are divided into three classes, forming the Tripitaka, or 'triple basket.' The first class consist of the *Soutras*, or discourses of the Buddha; the second contains the *Vinaya*, or discipline; and the third the *Abhidharma*, or metaphysic. The first is evidently the fundamental text out of which all the subsequent writings have been elaborated. The other two councils probably revised and expanded the writings agreed upon at the first, adding voluminous commentaries. As to the dates of the other two councils, there are irreconcilable discrepancies in the accounts; but at all events the third was not later than 240 B. c., so that the Buddhist canonical scriptures, as they now exist, were fixed two centuries and a half before the Christian era. The Buddhist religion early manifested a zealous missionary spirit; and princes and even princesses, became devoted propagandists. A prince of the royal House of Magadha, Mahindo, carried the faith to Ceylon, 307 B. c. The Chinese annals speak of a Buddhist missionary as early as 217 B. c.; and the doctrine made such progress, that in 65 A. D. it was acknowledged by the Chinese

emperor as a third state religion. The Chinese Buddhists have always looked on India as their 'holy land;' and, beginning with the 4th c. of our era, a stream of Buddhist pilgrims continued to flow from China to India during six centuries. Several of these pilgrims have left accounts of their travels, which throw a light on the course of Buddhism in India, and on the internal state of the country in general, that is looked for in vain in the literature of India itself. See HIouEN-TSANG. As to the spread of Buddhism north of the Himalayan mountains, we have the historical fact, that a Chinese general, having about the year 120 B. c. defeated the barbarous tribes to the north of the Desert of Gobi, brought back as a trophy a golden statue of the Buddha.

A prominent name in the history of Buddhism is that of Asoka, king of Magadha, in the 3d c. of our era, whose sway seems to have extended over the whole peninsula of Hindustan, and even over Ceylon. This prince was to Buddhism what Constantine was to Christianity. He was at first a persecutor of the faith, but being converted—by a miracle, according to the legend—he became its zealous propagator. Not, however, as princes usually promote their creed; for it is a distinguishing characteristic of Buddhism, that it has never employed force, hardly even to resist aggression. Asoka shewed his zeal by building and endowing viharas or monasteries, and raising topes and other monuments over the relics of Buddha and in spots remarkable as the scenes of his labours. Hiouen-Tsang, in the 7th c. of our era, found topes attributed to Asoka from the foot of the Hindu Kush to the extremity of the peninsula. There exist, also, in different parts of India, edicts inscribed on rocks and pillars, inculcating the doctrines of Buddha. The edicts are in the name of King Piyadasi; but Orientalists are almost unanimous in holding Piyadasi and Asoka to be one and the same. Not a single building or sculptured stone has been discovered in continental India of earlier date than the reign of this monarch, whose death is assigned to 226 B. c. A remarkable spirit of charity and toleration runs through these royal sermons. The 'king beloved of the gods' desires to see the ascetics of all creeds living in all places, for they all teach the essential rules of conduct. 'A man ought to honour his own faith only; but he should never abuse the faith of others. . . . There are even circumstances where the religion of others ought to be honoured, and in acting thus, a man fortifies his own faith, and assists the faith of others.'

For the glimpses we get of the state of Buddhism in India, we are indebted chiefly to the accounts of Chinese pilgrims. Fa-hian, at the end of the 4th c., found some appearances of decline in the east of Hindustan, its birthplace, but it was still strong in the Punjab and the north. In Ceylon, it was flourishing in full vigour, the ascetics or monks numbering from 50,000 to 60,000. In the 7th c.—that is, 1200 years after the death of the Buddha—Hiouen-Tsang represents it as widely dominant and flourishing, and patronised by powerful rajahs. Its history was doubtless more or less checkered. The Brahmans, though little less tolerant than the followers of Buddha, seem to have been in some cases roused into active opposition; and some princes employed persecution to put down the new faith.

It was probably during the first four or five centuries of our era, and as a result of persecution, that Buddhists, driven from the great cities, retired among the hills of the west, and there constructed those cave-temples which, for their number, vastness,

* From a too literal understanding of this phrase have arisen, probably, those praying-wheels, or rather wheels for meditation, seen standing before Buddhist monasteries in Tibet and elsewhere. The doctrines of Buddha are inscribed on the wheel, which is then set in motion by a windlass, or even by horse-power. The individual monks have portable ones, with which they perform their devotions wherever they may happen to be.

BUDDHISM.

and elaborate structure, continue to excite the wonder of all who see them. There are reckoned to be not fewer than 900 Buddhist excavations still

extant in India, nearly all within the presidency of Bombay. How the destruction of the Buddhist faith in Hindustan came about—whether from

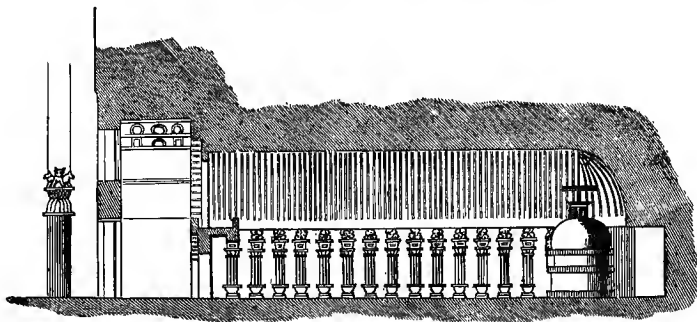

Section of Buddhist Cave-temple at Karli—from Fergusson's *Handbook of Architecture*.

internal corruption, or the persecution of powerful princes, adherents of the old faith—we are utterly in the dark. But it is certain that from the time of Hiouen-Tsang's visit, its decay must have been rapid beyond precedent; for about the 11th or 12th c., the last traces of it disappear from the Indian peninsula.

What, then, is the nature of this faith, which has been for so long, and is still, the sole light of so many millions of human beings? In answering this question, we must confine ourselves here to a brief outline of the intellectual theory on which the system is based, and of the general character of its morality and ritual observances, as they were conceived by the founder and his more immediate followers; referring for the various forms which the external observances have assumed to the several countries where it is believed and practised. See **BURMAH, CEYLON, CHINA, JAPAN, TIBET.**

Buddhism is based on the same views of human existence, and the same philosophy of things in general, that prevailed among the Brahmans. It accepts without questioning, and in its most exaggerated form, the doctrine of the transmigration of souls, which lies at the root of so much that is strange in the Eastern character. For a particular account of this important doctrine or notion, which seems ingrained in the constitution of Eastern minds, and without a knowledge of which no phase of thought or feeling among them can be understood, the reader is referred to **TRANS-MIGRATION**; while the peculiar cosmogony or system of the universe with which it is associated, and which is substantially the same among Hindus and Buddhists, will be described under **HINDUISM**. It is sufficient here to say, that, according to Buddhist belief, when a man dies, he is immediately born again, or appears in a new shape; and that shape may, according to his merit or demerit, be any of the innumerable orders of being composing the Buddhist universe—from a clod to a divinity. If his demerit would not be sufficiently punished by a degraded earthly existence—in the form, for instance, of a woman or a slave, of a persecuted or a disgusting animal, of a plant, or even of a piece of inorganic matter—he will be born in some one of the 136 Buddhist hells, situated in the interior of the earth. These places of punishment have a regular gradation in the intensity of the suffering and in the length of time the sufferers live, the least term of life being 10 millions of years, the longer terms being almost beyond the powers of even Indian notation to express. A meritorious life, on the other hand, secures the next birth either

in an exalted and happy position on earth, or as a blessed spirit, or even divinity, in one of the many heavens; in which the least duration of life is about 10 billions of years. But however long the life, whether of misery or of bliss, it has an end, and at its close the individual must be born again, and may again be either happy or miserable—either a god or, it may be, the vilest inanimate object.* The Buddha himself, before his last birth as Sakya-muni, had gone through every conceivable form of existence on the earth, in the air, and in the water, in hell and in heaven, and had filled every condition in human life. When he attained the perfect knowledge of the Buddha, he was able to recall all these existences; and a great part of the Buddhist legendary literature is taken up in narrating his exploits when he lived as an elephant, as a bird, as a stag, and so forth.

The Buddhist conception of the way in which the quality of actions—which is expressed in Pali by the word *Karma*, including both merit and demerit—determines the future condition of all sentient beings, is peculiar. They do not conceive any god or gods as being pleased or displeased by the actions, and as assigning the actors their future condition by way of punishment or of reward. The very idea of a god, as creating or in any way ruling the world, is utterly absent in the Buddhist system. God is not so much as denied; he is simply not known. Contrary to the opinion once confidently and generally held, that a nation of atheists never existed, it is no longer to be disputed that the numerous Buddhist nations are essentially atheist; for they know no beings with greater supernatural power than any man is supposed capable of attaining to by virtue, austerities, and science; and a remarkable indication of this startling fact is to be seen in the circumstance, that some at least of the Buddhist nations—the Chinese, Mongols, and Tibetans—have no word in their languages to express the notion of God. The future condition of the Buddhist, then, is not assigned him by the Ruler of the universe; the 'Karma' of his actions determines it by a sort of virtue inherent in the nature of things—by the blind and unconscious concatenation of cause and effect. But the laws by

* One legend makes Bhagavat, in order to impress upon the monks of a monastery the importance of their duties, point to a besom, and, by his supernatural insight, reveal to them that it had once been a novice, who had been negligent in sweeping the hall of assembly; the walls and pillars, again, he told them, had once existed as monks, who soiled the walls of the hall by spitting upon them.

which consequences are regulated seem dark, and even capricious. A bad action may lie dormant, as it were, for many existences; the taint, however, is there, and will some time or other break out. A Buddhist is thus never at a loss to account for any calamity that may befall himself or others.

Another basis of Buddhism is the assumption, that human existence is on the whole miserable, and a curse rather than a blessing. This notion, or rather feeling, is, like transmigration, common to Buddhism and Brahmanism, and is even more prominent in Buddhism than in the old faith. It is difficult for a European to conceive this state of mind, or to believe that it can be habitual in a whole people; and many signal errors in dealing with the Indian nations have arisen from overlooking the fact. The cause would seem to lie chiefly in the comparatively feeble physical organisation of Easterns in general. With a vigorous animal vitality, there is a massive enjoyment in mere bodily existence sufficient to drown a large amount of irritation and suffering, leaving life still sweet and desirable; while the spontaneous activity attending this vigour, makes it a pleasure instead of a pain to contend with and conquer difficulties. The Indian, on the contrary, even when he looks robust, has little intensity of animal vitality; and therefore, bodily existence, in itself, has to him little relish. Tedium of life, it is well known, arises more from negative than positive sources; and it requires but little bitter added to make his cup disgusting. So far, again, from finding activity a source of enjoyment, exertion is painful, and entire quiescence is, in his eyes, the highest state of conceivable enjoyment. When to this we add that want of security and peace, and that habitual oppression of the many by the few, with all the attendant degradation and positive suffering, which may be considered the normal state of things in the East, need we wonder that to men so constituted and so circumstanced, life should seem a burden, a thing rather to be feared than otherwise? The little value that Hindus set upon their lives is manifested in many ways. The punishment of death, again, has little or no terror for them, and is even sometimes coveted as an honour. For, in addition to the little value of their present existence, they have the most undoubting assurance that their soul, if dislodged from its present tenement, will forthwith find another, with a chance, at least, of its being a better one.

In the eyes, then, of Sakya-muni and his followers, sentient existence was hopelessly miserable. Misery was not a mere taint in it, the removal of which would make it happy; misery was its very essence. Death was no escape from this inevitable lot; for, according to the doctrine of transmigration, death was only a passage into some other form of existence equally doomed. Even the heaven and the state of godhead which form part of the cycle of changes in this system, were not final; and this thought poisoned what happiness they might be capable of yielding. Brahman philosophers had sought escape from this endless cycle of unsatisfying changes, by making the individual soul be absorbed in the universal spirit (Brahm); Gautama had the same object in view—viz., exemption from being born again; but he had not the same means of reaching it. His philosophy was utterly atheistic, like that of the original Sankhya school of philosophy, whose views he chiefly borrowed, and ignored a supreme God or Creator; it did not leave even an impersonal Spirit of the universe into which the human soul could be absorbed. Gautama sees no escape but in what he calls NIRVANA, the exact nature of which has been

matter of dispute. According to its etymology, the word means 'extinction,' 'blowing out,' as of a candle; and most Orientalists are agreed that in the Buddhist scriptures generally it is equivalent to annihilation. Even in those schools which attempt to draw a distinction, the distinction is of the most evanescent kind.

The key of the whole scheme of Buddhist salvation lies in what Gautama called his Four Sublime Verities. The first asserts that pain exists; the second, that the cause of pain is desire or attachment—the meaning of which will appear further on; the third, that pain can be ended by Nirvana; and the fourth shews the way that leads to Nirvana. This way to Nirvana consists in eight things: right faith, right judgment, right language, right purpose, right practice, right obedience, right memory, and right meditation. In order to understand how this method is to lead to the proposed end, we must turn to the metaphysical part of the system contained in the 'concatenation of causes,' which may be looked upon as a development of the second 'verity'—namely, that the cause of pain is desire—or rather, as the analysis upon which that verity is founded. The immediate cause of pain is birth, for if we were not born, we should not be exposed to death or any of the ills of life. Birth, again, is caused by previous existence; it is only a transition from one state of existence into another. All the actions and affections of a being throughout his migrations leave their impressions, stains, attachments adhering to him, and the accumulation of these determines at each stage the peculiar modification of existence he must next assume. But for these adhesions, the soul would be free; not being bound down to migrate into any determinate condition of life, it would follow that it need not migrate at all. These adhesions or attachments, good and bad, depend upon desire, or rather, upon affection of any kind in the soul towards the objects; as if only what moved the soul to desire or avoidance could leave its impress upon it. We thus arrive at desire—including both the desire to possess, and the desire to avoid—as one link in the chain of causes of continued existence and pain. Beyond this the dependence of the links is very difficult to trace; for desire is said to be caused by perception, perception by contact, and so on, until we come to ideas. Ideas, however, are mere illusions, the results of ignorance or error, attributing durability and reality to that which is transitory and imaginary. Cut off this ignorance, bring the mind into a state in which it can see and feel the illusory nature of things, and forthwith the whole train vanishes; illusory ideas, distinction of forms, senses, contact, perception, desire, attachment, existence, birth, misery, old age, death!

Morality and Religious Observances.—The eight parts or particulars constituting the theoretical 'way' (to Nirvana), was developed by Gautama into a set of practical precepts enjoining the various duties of common life and of religion. They are all ostensibly intended as means of counteracting or destroying the chain of causes that tie men to existence and necessitate being born again, especially that most important link in the chain constituted by the attachments or desires resulting from former actions; although the special fitness of some of the precepts for that end is far from being apparent. It is easy to understand how the austerities that are prescribed might subdue the passions and affections, and lessen the attachment to existence; but how the exercise of benevolence, of meekness, of regard to truth, of respect to parents, &c., on which Gautama laid so much stress, should have this effect, it is difficult to conceive. Luckily for the Buddhist

world, Gautama's moral nature was better than his logic, or rather than the perverse assumptions from which his logic starts; and as he felt strongly—what all men have felt more or less—that these things are essentially right and good, he takes it for granted that they must contribute to what was in his eyes the chief good—escape from existence, or Nirvana. In delivering his precepts, the Buddha considers men as divided into two classes—those who have embraced the religious life (*Sramanas*), and those who continue in the world, or are laymen. These last are considered as too much attached to existence to feel any desire or have any hope of emancipation, at least at this stage. But there are certain precepts which it is necessary for all to obey, that they may not bring greater misery upon themselves in their next births, and rivet the bonds of existence more indissolubly. There are ten moral precepts or 'precepts of aversion.' Five of these are of universal obligation—viz., not to kill; not to steal; not to commit adultery; not to lie; not to be drunken. Other five are for those entering on the direct pursuit of Nirvana by embracing the religious life: to abstain from food out of season—that is, after mid-day; to abstain from dances, theatrical representations, songs, and music; to abstain from personal ornaments and perfumes; to abstain from a lofty and luxurious couch; to abstain from taking gold and silver. For the regular ascetics or monks, there are a number of special observances of a very severe kind. They are to dress only in rags, sewed together with their own hands, and to have a yellow cloak thrown over the rags. They are to eat only the simplest food, and to possess nothing except what they get by collecting alms from door to door in their wooden bowl. They are allowed only one meal, and that must be eaten before mid-day. For a part of the year, they are to live in forests, with no other shelter except the shadow of a tree, and there they must sit on their carpet even during sleep, to lie down being forbidden. They are allowed to enter the nearest village or town to beg food, but they must return to their forests before night.

Besides the absolutely necessary 'aversions and observances' above mentioned, the transgression of which must lead to misery in the next existence, there are certain virtues or 'perfections' of a supererogatory or transcendent kind, that tend directly to 'conduct to the other shore' (Nirvana). The most essential of these are almsgiving or charity, purity, patience, courage, contemplation, and knowledge. Charity or benevolence may be said to be the characteristic virtue of Buddhism—a charity boundless in its self-abnegation, and extending to every sentient being. The benevolent actions done by the Buddha himself, in the course of his many millions of migrations, were favourite themes with his followers. On one occasion, seeing a tigress starved and unable to feed her cubs, he hesitated not to make his body an oblation to charity, and allowed them to devour him. Benevolence to animals, with that tendency to exaggerate a right principle so characteristic of the East, is carried among the Buddhist monks to the length of avoiding the destruction of fleas and the most noxious vermin, which they remove from their persons with all tenderness.

There are other virtues of a secondary kind, though still highly commendable. Thus, not content with forbidding lying, the Buddha strictly enjoins the avoidance of all offensive and gross language, and of saying or repeating anything that can set others at enmity among themselves; it is a duty, on the contrary, especially for a *sramana*, to act on all occasions as a peacemaker. Patience under injury, and resignation in misfortune, are strongly inculcated.

Humility, again, holds a no less prominent place among Buddhist graces than it does among the Christian. The Buddhist saints are to conceal their good works, and display their faults. As the outward expression of this sentiment of humility, Gautama instituted the practice of confession. Twice a month, at the new and at the full moon, the monks confessed their faults aloud before the assembly. This humiliation and repentance seems the only means of expiating sin that was known to Gautama. Confession was exacted of all believers, only not so frequently as of the monks. The edicts of Piyadasi recommend a general and public confession at least once in five years. The practice of public confession would seem to have died out by the time of Hiouen-Tsang's visit to India.

Such are the leading features of the moral code of the Buddha, of which it has been said, that 'for pureness, excellence, and wisdom, it is only second to that of the Divine Lawgiver himself.' But the original morality of Buddhism has, in the course of time, been disfigured by many subtleties, puerilities, and extravagances, derived from the casuistry of the various schools of later times; just as the casuistry of the Jesuits, for instance, perverted many of the precepts of Christianity. The theory on which the Buddha founds his whole system gives, it must be confessed, only too much scope to such perversions; for, on that theory, truth is to be spoken, self to be sacrificed, benevolence to be exercised, not for the sake of the good thus done to others, but solely for the effect of this conduct on the soul of the actor, in preparing him for escape from existence. To teach men 'the means of arriving at the other shore,' was another expression for teaching virtue; and that other shore was annihilation. On this principle, the Buddhist casuist can, like the Jewish, render of none effect the universal law of charity and the duty of respecting and aiding parents, on which the Buddha laid such stress. Thus, a *Bikshu*—that is, one who has engaged to lead a life of self-denial, celibacy, and mendicancy, and is thus on the high road to Nirvana—is forbidden to look at or converse with a female, lest any disturbing emotion should ruffle the serene indifference of his soul; and so important is this, that 'if his mother have fallen into a river, and be drowning, he shall not give her his hand to help her out; if there be a pole at hand, he may reach that to her; but if not, she must drown.'—Wilson.

Contemplation and science or knowledge (i. e., of the concatenation of causes and effects) are ranked as virtues in Buddhism, and hold a prominent place among the means of attaining Nirvana. It is reserved, in fact, for abstract contemplation to effect the final steps of the deliverance. Thought is the highest faculty of man, and, in the mind of an Eastern philosopher, the mightiest of all forces. A king who had become a convert to Buddhism is represented as seating himself with his legs crossed, and his mind collected; and 'cleaving, with the thunderbolt of science, the mountain of ignorance,' he saw before him the desired state. It is in this cross-legged, contemplative position that the Buddha is almost always represented—that crowning intellectual act of his, when, seated under the Bo-tree (q. v.), he attained the full knowledge of the Buddha, saw the illusory nature of all things, broke the last bonds that tied him to existence, and stood delivered for evermore from the necessity of being born again, being considered the culmination of his character, and the highest object of imitation to all his followers.

'Complete' Nirvana or extinction cannot, of course, take place till death; but this state of preparation for it, called simply Nirvana, seems

attainable during life, and was, in fact, attained by Gautama himself. The process by which the state



Colossal Gautama near Amarapura, Burmah.

is attained is called *Dhyana*, and is neither more nor less than ecstasy or trance, which plays so important a part among mystics of all religions. The individual is described as losing one feeling after another, until perfect apathy is attained, and he reaches a region 'where there are neither ideas, nor the idea of the absence of ideas!'

The *ritual* or *worship* of Buddhism—if worship it can be called—is very simple in its character. There are no priests, or clergy, properly so called. The *Sramanas* or *Bikshus* (mendicants) are simply a religious order—a kind of monks, who, in order to the more speedy attainment of Nirvana, have entered on a course of greater sanctity and austerity than ordinary men; they have no sacraments to administer or rites to perform for the people, for every Buddhist is his own priest. The only thing like a clerical function they discharge, is to read the scriptures or discourses of the Buddha in stated assemblies of the people held for that purpose. They have also everywhere, except in China, a monopoly of education; and thus in Buddhist countries education, whatever may be its quality, is very generally diffused. In some countries, the monks are exceedingly numerous; around Lhasa in Tibet, for instance, they are said to be one-third of the population. They live in *viharas* or monasteries, and subsist partly by endowments, but mostly by charity. Except in Tibet, they are not allowed to engage in any secular occupation. The vow is not irrevocable. This incubus of monachism constitutes the great weakness of Buddhism in its social aspect. Further particulars regarding Buddhist monks and monasteries, as well as the forms of Buddhist worship generally, will be given when speaking of the countries where the religion prevails.

The adoration of the statues of the Buddha and of his relics is the chief external ceremony of the religion. This, with prayer and the repetition of sacred formulas, constitutes the ritual. The centres of the worship are the temples containing statues, and the *topes* or *tumuli* erected over the relics of the Buddha, or of his distinguished apostles, or on spots consecrated as the scenes of the Buddha's acts. The central object in a Buddhist temple, corresponding to the altar in a Roman Catholic church, is an image of the Buddha, or a *dagoba* or shrine containing his relics. Here flowers,* fruit, and incense

are daily offered, and processions are made with singing of hymns. Of the relics of the Buddha, the most famous are the *teeth* that are preserved with intense veneration in various places. Hiouen-Tsang saw more than a dozen of them in different parts of India; and the great monarch Ciladitya was on the eve of making war on the king of Cashmere for the possession of one, which, although by no means the largest, was yet an inch and a half long. The tooth of the Buddha preserved in Ceylon, a piece of ivory about the size of the little-finger, is exhibited very rarely, and then only with permission of the English government—so great is the concourse and so intense the excitement. See CEYLON.

There appears at first sight to be an inconsistency between this seeming worship of the Buddha, and the theory by which he is considered as no longer existing. Yet the two things are really not irreconcilable; not more so, at least, than theory and practice often are. With all their admiration of the Buddha, his followers have never made a god of him. Gautama is only the last Buddha—the Buddha of the present cycle. He had predecessors in the cycles that are past (twenty-four Buddhas of the past are enumerated, and Gautama could even tell their names); and when, at the end of the present cycle, all things shall be reduced to their elements, and the knowledge of the way of salvation shall perish with all things else; then, in the new world that shall spring up, another Buddha will appear, again to reveal to the renescent beings the way to Nirvana. Gautama foretold that Mitraya, one of his earliest adherents, should be the next Buddha* (the Buddha of the future), and he gratified several of his followers with a like prospect in after-cycles. The Buddha was thus no greater than any mortal may aspire to become. The prodigious and supernatural powers which the legends represent him as possessing, are quite in accordance with Indian ideas; for even the Brahmans believe that by virtue, austerities, and science, a man may acquire power to make the gods tremble on their thrones.

The Buddha, then, is not a god; he is the ideal of what any man may become; and the great object of Buddhist worship is to keep this ideal vividly in the minds of the believers. In the presence of the statue, the tooth, or the footprint, the devout believer vividly recalls the example of him who trod the path that leads to deliverance. This veneration of the memory of Buddha is perhaps hardly distinguishable, among the ignorant, from worship of him as a present god; but in theory, the ritual is strictly commemorative, and does not necessarily involve idolatry, any more than the garlands laid on the tomb of a parent by a pious child.

The prayers addressed to the Buddha are more difficult to reconcile with the belief in his having ceased to exist. It is improbable, indeed, that the original scheme of Buddhism contemplated either the adoration of the statues of the Buddha, or the offering of prayers to him after his death. These are an after-growth—accretions upon the simple scheme of Gautama, and in a manner forced upon it during its struggle with other religions. For, a

offered on one occasion 6,480,320 flowers at the shrine of the tooth. At one temple it was provided that there should be offered 'every day 100,000 flowers, and each day a different flower.

* One who is on the way to become a supreme Buddha, and has arrived at that stage when he has only one more birth to undergo, is styled a *Bohisatva* (having the essence of knowledge); a mere candidate for Nirvana is an *arhat* (venerable).

* The quantity of flowers used as offerings is prodigious. A royal devotee in Ceylon, in the 15th c.,

system of belief that seeks to supplant other systems, finds itself enticed to present something to rival and outdo them, if possible, in every point. Even the Christian church, in the middle ages, adopted with this view many of the rites and legends of paganism that were quite inconsistent with its own character; merely casting over them a slight disguise, and giving them Christian names. Prayer, too, is natural to man—an irrepresible instinct, as it were, and had to be gratified. And then the inconsistency in uttering prayers when there is no one to hear or answer, glaring as it appears to us, is by no means great to the Eastern mind. Prayers, like other sacred formulas, are conceived less as influencing the will of any superior being to grant the request, than as working in some magical way—producing their effects by a blind force inherent in themselves. They are, in short, mere incantations or charms. Even the prayers of a Brahman, who believes in the existence of gods, do not act so much by inclining the deity addressed to favour the petitioner, as by compelling him through their mysterious potency—through the operation of a law above the will of the highest gods. The Buddhist, then, may well believe that a formula of prayer in the name of 'the Venerable of the world' will be potent for his good in this way, without troubling himself to think whether any conscious being hears it or not.

The element in Buddhism which more than any other, perhaps, gave it an advantage over all surrounding religions, and led to its surprising extension, was the spirit of universal charity and sympathy that it breathed, as contrasted with the exclusiveness of caste. In this respect, it held much the same relation to Brahmanism that Christianity did to Judaism. It was, in fact, a reaction against the exclusiveness and formalism of Brahmanism—an attempt to render it more catholic, and to throw off its intolerable burden of ceremonies. Buddhism did not expressly abolish caste, but only declared that all followers of the Buddha who embraced the religious life were thereby released from its restrictions; in the bosom of a community who had all equally renounced the world, high and low, the twice-born Brahman and the outcast were brethren. This was the very way that Christianity dealt with the slavery of the ancient world. This opening of its ranks to all classes and to both sexes—for women were admitted to equal hopes and privileges with men, and one of Gautama's early female disciples is to be the supreme Buddha of a future cycle—no doubt gave Buddhism one great advantage over Brahmanism. The Buddha, says M. Müller, 'addressed himself to castes and outcasts. He promised salvation to all; and he commanded his disciples to preach his doctrine in all places and to all men. A sense of duty, extending from the narrow limits of the house, the village, and the country, to the widest circle of mankind, a feeling of sympathy and brotherhood towards all men, the idea, in fact, of humanity, were first pronounced by Buddha.' This led to that remarkable missionary movement, already adverted to, which, beginning 300 B. C., sent forth a succession of devoted men, who spent their lives in spreading the faith of Buddha over all parts of Asia.

In the characteristic above mentioned, and in many other respects, the reader cannot fail to remark the striking resemblance that Buddhism presents to Christianity, and this in spite of the perverse theory on which it is founded. So numerous and surprising are the analogies and coincidences, that Mrs Speir, in her book on *Life in Ancient India*, 'could almost imagine that before

God planted Christianity upon earth, he took a branch from the luxuriant tree, and threw it down to India.'

It would be superfluous to attempt here any formal refutation of the religion of the Buddha. To the readers of this work, the fundamental errors of the theory will be apparent enough. By giving prominence to the extravagances and almost inconceivable puerilities and absurdities with which the system has been overloaded, it would have been easy to make it look sufficiently ridiculous. But this is not to depict, it is to caricature. It is only too common for Christian writers to treat of heathen religions in such fashion. The only fair—the only true account of any religion, is that which enables the reader to conceive how human beings may have come to believe it and live by it. It is this object that has been chiefly kept in view in the preceding meagre sketch of a vast subject. Those who wish to pursue it further are referred to Spence Hardy's *Manual of Buddhism* (Lond. 1853), consisting chiefly of translations from the sacred books used in Ceylon; and to an admirable digest of all that is now known of the subject, by J. Barthelemy Saint-Hilaire, entitled *Le Bouddha et sa Religion* (The Buddha and his Religion. Paris, 1860).

BUDDING, sometimes called INOCULATION, is an operation analogons to GRAFTING (q. v.), or indeed may be regarded as merely a particular mode of grafting, in which a leaf-bud is used as a graft instead of a young shoot. It is generally preferred for trees which are apt to throw out much gum when wounded, as the plum, cherry, peach, apricot, and stone-fruits in general, also for roses and many other flowering shrubs. The time for it is when the



bud is perfectly formed, about or a little after midsummer. The subjoined cut represents the various parts in budding: *a* is the bud cut out, with a shield of bark attached to it; *b*, the stem, with a slit in the bark to receive the shield attached to the bud; *c*, the bud inserted and the leaf cut away. The bud to be employed is taken, by means of a sharp knife, from the branch on which it has grown—generally a branch of the former year—a small portion of the bark and young wood being taken with it, extending to about half an inch above and three-quarters of an inch below the bud. The woody part is then separated from the bark and bud; but care is to be taken that the bud itself is not injured, which, however, is always the case when the operation is attempted before the bud is sufficiently matured, and is indicated by a hollow left at the bud when the wood has been removed. A longitudinal and a transverse cut are made in the bark of the stock intended to receive the bud, in the form of the letter T; the bark is raised on both sides, for which purpose the handle of the *budding-knife* generally terminates in a thin ivory blade, and the bud is inserted, the bark attached to the bud being cut across so as to join exactly to the transverse cut in that of the stock, that the bud may be nourished by the descending sap. The leaf in

the axil of which the bud grew is cut off. The newly inserted bud is for a time preserved in its place, and prevented from too much access of air by strands of bass-matting. The process just described is distinctively called *shield-budding*, and is the most common method of budding. Other methods are occasionally employed, as *reversed shield-budding*, in which the incisions are in the form of the letter T reversed, which is sometimes practised with trees of the orange family and others in which there is a very great flow of descending sap; and *scallop-budding*, in which a thin slip of bark is removed from the stock, and a similar slip bearing the bud is placed upon it, the upper edge and one of the lateral edges being made to fit exactly. Scallop-budding may be performed in spring, and if it fails, the ordinary method may be resorted to in summer. Budding is also sometimes performed by taking a tube of bark with one or more buds from a small branch, and placing it upon a branch of similar thickness in the stock, from which the bark has been removed.

BUDDLEA, a genus of shrubs of the natural order *Scrophularineæ*, of which many species are known, all natives of the warmer parts of the world, and some of them much admired for their beautiful flowers. *B. Neemda* has received the praise of being one of the most beautiful plants of India. *B. globosa*, a native of Chili, with downy branches, lanceolate leaves, and globose heads of orange-coloured flowers, is hardy enough to endure the climate of most parts of England, and has become a very common ornament of gardens, but in Scotland it needs the protection of the greenhouse or frame.

BUDE BURNER and **BUDE LIGHT**. The Bude Burner, so called from the name of the residence of the inventor, Mr Gurney, consists of two, three, or more concentric argand burners, each inner one rising a little above the outer. On the same principle, a powerful light is produced by a number of flat flames disposed in concentric circles like the petals of a rose.—The Bude Light, also the invention of Mr Gurney, depends upon introducing oxygen into the centre of the flame instead of air, as in the common argand. A light of the most dazzling brilliancy is thus produced. The House of Commons is lighted by this means, the brilliancy being softened by the intervention of a ceiling of ground-glass.

BUDGET, from the same source as the French *bougette*, means a small bag, and has been used metaphorically to express a compact collection of things, as a budget of news, a budget of inventions, and the like. Water-budgets or buckets were a very honourable blazon on a coat-armorial, as being generally conferred in honour of some valiant feat for supplying an army with water. Guillim, in his *Display of Heraldry*, thinks the three mighty men in David's army who broke into the host of the Philistines, and drew water from the well of Bethlehem, 'deserved to have been remunerated with such armorial marks on their coat-armours for their valour.'

The term, 'The Budget,' is in Britain, from long usage, applied to that miscellaneous collection of matters which aggregate into the annual financial statement made to parliament by the Chancellor of the Exchequer. It contains two leading elements—a statement how the nation's account of charge and discharge stands in relation to the past, and an explanation of the probable expenditure of the ensuing year, with a scheme of the method in which it is to be met, whether by the existing or new taxes, or by loan. The statement of the budget

is always an important, sometimes a very exciting occasion; as, for instance, Sir Robert Peel's adoption of an income-tax in 1842, and his legislation for free trade in 1846. Another instance is Mr Gladstone's reduction of the wine-duties and treaty with France in 1860.

BÜDOS HEGY, a mountain belonging to the Carpathians, on the eastern border of Transylvania, in lat. 46° 12' N., and long. 25° 40' E. It is quite isolated, steep, and of conical shape, densely wooded on the lower slopes, and has an elevation of 7340 feet. It has numerous caverns, that emit sulphurous exhalations, and from its base issue strong sulphur springs.

BU'DWEIS, a town of Bohemia, situated on the Moldau, about 77 miles south of Prague. B. is well built, is partially fortified, and has an old cathedral, manufactures of woollens, muslins, damasks, saltpetre, dyes, &c. Its position on the Moldau, and its connection with the Danube at Linz, by means of a horse-railway, the first constructed in Germany, give B. a considerable transit trade. Pop. 10,700. In the neighbourhood, is an old feudal fortress, the *Schloss Frauenberg*, one of the seats of Prince Schwarzenberg, and a fine new Gothic castle also belonging to the same nobleman. Here he keeps herds of wild swine, and in grand hunting-matches, as many as 300 are killed in a day.

BUEN AYRÉ in Spanish, or **BON AIR** in French, an island in that subdivision of the West Indies which runs parallel with the coast of Venezuela. It is in lat. 12° 20' N., and long. 68° 27' W., being 30 miles to the east of Curaçao, which, like itself, belongs to the Dutch. B. A. produces cattle and salt. It measures 20 miles by 4, and contains about 2500 inhabitants. It has a tolerable harbour on its leeward or south-west side.

BUENOS AYRÉS, a city of South America, on the right bank of the Plata, which here, at a distance of 150 miles from the open sea, is 36 miles across. It stands in lat. 34° 36' S., and long. 58° 24' W. Its disadvantages as a maritime town are great; the flood-tides of the ocean, when backed by easterly winds, being apt to make the estuary overflow its banks; and again, when westerly winds prevail, the estuary loses both width and depth. Monte Video, on the opposite shore, possesses a better harbour, and is nearer to the Atlantic, nor can it be doubted that, but for the greater facilities of B. A. in carrying on an inland trade, the former town would have proved a dangerous rival. Steam is rapidly placing both upon more equal terms. Of the trade, however, with Chili by Mendoza and the Andes—a trade which must always be carried on by land—B. A. must still command the monopoly. So familiar had B. A. become with land-carriage on an extensive scale, that its merchants, when blockaded in front during a war with Brazil, established, as it were, a new port of entry in the mouth of the Salado or Saladillo, at a distance of at least 150 miles. As a city, B. A. labours under some peculiar disadvantages. Its supplies of fresh water are received from the Plata in rudely constructed carts. Its immediate territory, purely alluvial, is almost as destitute of timber as of stones—the latter being brought either as ballast from Europe, or as freight from Martin Garcia, an island on the opposite side of the estuary; and the former from the province of Entre Rios, and from the islets of its bordering rivers, the Uruguay and the Parana. Fuel, too, is almost as scarce as building materials—peach-trees and the withered thistles of the prairies yielding the only indigenous supplies. B. A., which appears to deserve its name of *good air*, or rather *good airs*,

BUENOS AYRES—BUFFALO.

contains 122,000 inhabitants—about a fourth of whom are of European birth or descent. Among those of European birth, the vast majority are natives of France and of the United Kingdom. B. A. publishes newspapers both in French and in English as regularly and successfully as those in the vernacular tongue. The city, measuring 2 miles by 1½, is partitioned into rectangular blocks of about 150 yards square by granite-paved streets, most of the houses being flat-roofed, and only one story high. The principal buildings are the cathedral and its dependent churches, Episcopalian and Presbyterian chapels, a founding hospital, an orphan asylum, the university, a military college, several public schools, and the government offices; there are also printing establishments, and manufactories of cigars, carpets, furniture, and boots and shoes. In 1856 the exports amounted to £2,742,120, and the imports for the same year £2,776,660. The exports consisted of precious metals, hides, beef, wool, skins, tallow, and horse-hair; and the imports of cottons, linens, woollens, jewellery, perfumery, and deals. B. A. was founded in 1535; but having subsequently been twice destroyed by the Indians, it ought, in reality, to date only from 1580. In the beginning of the present century, it achieved, with very little aid from home, two triumphs over England. In 1806, one British force, which had just captured the city, was obliged to surrender; and in 1807, another, which attempted to recover the place, was repulsed with heavy loss; and there can be but little doubt that the consciousness of strength, which such successes over so formidable a foe inspired, mainly emboldened the colonists, three years afterwards, to throw off the yoke of comparatively feeble Spain.

BUENOS AYRES, a republic of South America, of which the city above noticed is the capital, extends itself along the Atlantic, from the mouth of the Plata to that of the Rio Negro on the 41st parallel; on the N.E., it is washed by the Plata and the Parana as far as the Arroyo del Medio; on the N. and the adjacent section of the W., it touches the province of Santa Fé. Elsewhere, its borders cannot be defined, constantly advancing, by slow and perilous steps, into the domain of the aborigines, for here the contest is not with the wilderness itself, which is a boundless prairie, but with its tenants, who, having an unlimited supply of horses for all purposes, are secured, in their every foray, alike against famine and fatigue. Its area is estimated at 200,000 square miles, with a population of 350,000. Besides the existing provinces of the name, it at one time comprised Uruguay or Banda Oriental, Paraguay, Bolivia, and the Argentine Confederation, being originally an appendage of Peru, under the immediate command of a captain-general, and becoming, in 1775, a separate viceroyalty of itself. Though the first three of these four divisions broke off chiefly in connection with the revolutionary struggle, yet the fourth continued, down to 1853, to recognise the city of B. A. as its head; and even during the interval down to 1860, the inland states have been endeavouring, both by war and by diplomacy, to re-annex the maritime province to the Argentine Confederation.

The country approaches so nearly to a plain, that most of the rain which falls is either absorbed or evaporated, or lost in salt-lakes, comparatively little drainage entering the Parana or the Plata. The climate, though on the whole healthy and agreeable, is yet by no means steady or uniform. Every wind, in general, has, to a remarkable degree, its own weather—sultriness coming from the north, freshness from the south, moisture from the east,

and storm from the west; and besides the periodical heats of every summer, successive years of more than ordinary drought occur. Agriculture, properly so called, is followed chiefly in the more temperate and humid districts of the eastern coast; while the interior presents almost uninterrupted pasturage to countless herds of horses and cattle. Under these circumstances, the business of grazing and hunting combined occupies or interests the great bulk of the population—a business that renders the province, whether as to the disposal of its productions or as to the supply of its wants, peculiarly dependent on that external commerce, which, throughout the whole of Spanish America, has naturally been identified with political freedom. Let it be added, that the Indians are intractable, and that the Africans, few in number at best, are principally menials; and it is seen at once why, in spite of national jealousies and sectarian prejudices, immigration from Europe has been not only tolerated by public opinion, but also encouraged by legislative enactment. Moreover, a comparatively congenial climate, as a recommendation to foreigners, has powerfully seconded the efforts of liberality and patriotism. It is perhaps mainly owing to this cause, which is common alike to Chili and to B. A., that these two states, notwithstanding their full share of wars and troubles, have so decidedly outstripped the other fragments of the same colonial empire in all the elements of liberty and civilisation. Hence their higher importance in the eyes of Europeans in general, and of Englishmen in particular. The receipts of B. A. for the year 1857 amounted to £823,000, and the expenditure to £798,000. In 1859, B. A. had an army of 6000 men, with 9 vessels of war and a commercial navy of 1211 ships, with an aggregate tonnage of 297,170 tons.

BU'FFALO (*Bos Bubalus*), an animal of the ox tribe, very important and useful to man. It is a native of the East Indies, where it has been long domesticated, and from which it was carried to Egypt and to the south of Europe. It was introduced into Italy about the close of the 6th c. A. D., and is now very generally used as a beast of draught and of burden in that country, as it is also in India.

The B. is larger than the ox, and its limbs are stouter. Its form is more angular and clumsy; the head is larger in proportion to the size of the body; and the forehead is rather convex, and higher than broad; the dorsal line rises into a considerable elevation above the shoulders; the dewlap and the tail resemble those of the ox; the horns are large, slightly compressed, recline towards the neck, and have their points turned up. It is characteristic of the B., when walking or running, to carry the head with the muzzle projecting straight forward, and the horns laid back on the shoulders. The hair is irregular and bristly, often very thin, so that the smooth brown hide 'shines with an unpleasant polish in the sunlight.' In this as in other respects, the animal is adapted for marshy situations, which it naturally affects; preferring for its food the rank coarse herbage which they afford, delighting to immerse itself in water till only its head appears above the surface, in which condition it will remain for hours, and often enveloping itself in mud as a protection against insects. On account of these propensities, the buffaloes used as beasts of burden in India are seldom laden with any goods liable to be spoiled by water, as the animal is always ready to take an opportunity of lying down with his head in any river or pond which presents itself. In Italy, the B. seems nowhere more at home than in the Pontine Marshes and the pestilential Maremma.

BUFFALO—BUFFALORA.

The very regions where malaria is most prevalent seem to be those most adapted to its constitution.

The B. is a very powerful animal, much more powerful than the ox, and capable of dragging or carrying a far heavier load. The female yields a much greater quantity of milk than a cow, and of excellent quality. It is from B. milk that the *ghee* or semi-fluid butter of India is made. The hide is greatly valued for its strength and durability, but the flesh is very inferior to that of the ox.

The B. exhibits a considerable amount of intelligence. In a state of domestication, it is capable of becoming very docile. In the south of Europe, it is generally managed by a ring passed through the cartilage of the nose, but in India by a mere rope. The Indian driver rides upon a B.; but these animals keep so closely together as they are driven along, that, if necessary, he walks from the back of one to that of another perfectly at his ease. In a wild state, the B. is savage and dangerous, and even in domestication it is apt to resent injury. The native princes of India make buffaloes and tigers fight in their public shows; and the B. is more than a match for the tiger, even in single combat. The appearance of a tiger excites a herd of buffaloes, much as we see oxen excited by the approach of a dog; and if his safety is not secured by flight, they kill him, tossing him from one to another with their horns, and trampling him with their feet.

The B. is used in some parts of the east in the shooting of waterfowl, being trained to the sport, and sold at a considerable price. The sportsman conceals himself behind the B., which, being a familiar sight, is not alarming to the birds.

The CAPE B. (*Bos Caffer*) is generally regarded as a distinct species. It seems never to have been reduced to the service of man, although there is reason to believe it to be very capable of domestication. The horns are very large; they spread horizontally over the top of the head, and are then bent down laterally, and turned upwards at the point. The head is carried, as by the common B., with projecting muzzle and reclining horns, but the bases of the horns nearly meet on the forehead, where they are from eight to ten inches broad. The length of a full-grown Cape B. is about 8 feet from



Cape Buffalo.

the root of the horns to the tail, and the height 5½ feet. This animal is regarded as more formidable than any other in South Africa; and the hunter will more readily risk an encounter with a lion than offer any provocation to a B. without great advantages for the combat, or great facilities for

escape. The B. is still found in large herds in the interior of South Africa, but in Cape Colony, where it was once plentiful, it has now become comparatively rare. The hide is so thick and tough that the Caffres make shields of it, impenetrable to musket-shot; and the balls used by the huntsmen in shooting the animal are mixed with tin, and yet are often flattened by the resistance. The Cape B. grazes chiefly in the evening, and lies in woods and thickets during the day.

An attempt has been made to establish a genus, *Bubalus*, having the common B. for its type; but the characters lack precision, and the limits are uncertain.—The *Buffalo* of the Anglo-Americans is the American Bison. See BISON.

BUFFALO, a city of the state of New York, standing at the mouth of Buffalo Creek, which enters Lake Erie within 2 miles of its outlet, the Niagara river. Its progress has been perhaps more marvellous than that of any of its rivals. In 1801, when B. was founded, the basin of its fresh-water sea contained certainly fewer than 50,000 inhabitants, and seemed cut off from commercial communication by the Niagara falls on the east, and the currents of the Detroit and St Clair on the west. But these, and other natural disadvantages, have been made to vanish. A pier of 500 yards in length, by narrowing and accelerating the stream, has in a great measure removed the bar, so as to give a depth of 12 or 14 feet for a mile upwards. Steam has brought Lakes Huron and Michigan within easy reach, and waits only the completion of works at the Sault Ste Marie to do the same for Lake Superior. British improvements along the Niagara and the St Lawrence, available as they are for sea-going ships, have rendered B. a maritime emporium. The Erie Canal, 364 miles long, has connected B. as its terminus with the tide-waters of the Hudson; while three other enterprises of the kind, commencing respectively at Erie, Cleveland, and Toledo, have linked Lake Erie at three or rather four points with the Ohio, and through it with the Mississippi. Add to all this, the multiplication of states to the westward, the increase of population all round, and half-a-dozen railways radiating in every direction, and even then one is scarcely prepared for imports and exports to the annual amount of 100 millions of dollars, or 20 millions of pounds sterling. Two summary statements will shew how rapidly B. has grown. In 1843, 1846, 1849, and 1852 respectively, the port-duties yielded 4346, 12,389, 46,939, and 69,723 dollars; and in 1810, 1820, 1830, 1840, and 1850 respectively, the census returned 1508, 2095, 8653, 18,213, and 42,261 inhabitants; while within three years the last-named number was estimated to have swollen to 60,000. There have been two turning-points in the history of the place: in 1814 the British burned it, and in 1825 the Erie Canal between B. and Albany was opened.

B. is situated in lat. 42° 53' N., and long. 78° 55' W. It is regularly built. Its streets are straight and broad—Main Street, in particular, being 2 miles long and 120 feet wide; and its squares, which are three in number, are shaded by rows of trees. Besides the ordinary establishments of a populous, wealthy, and intelligent town, B. has a court-house, a lyceum, and a university. It is largely engaged in ship-building, and possesses iron-foundries, wool-factories, and saw-mills. It is divided into five wards, and is governed by a mayor and council annually elected.

BUFFALO'RA, a small town of Lombardy, about 25 miles north-north-west of Pavia, on the Ticino, here crossed by a bridge. The Austrians commenced

the Italian campaign of 1859 by entering Piedmont at this point. The bridge was partially blown up by Austrian engineers. Pop. 1257.

BUFFET, an article of furniture formerly serving the same purpose as a sideboard, which has now superseded it. B. is also a name given to foot-stools.

BUFF LEATHER is usually made out of salted and dried South American light ox and cow hides. After being limed in the usual way, they are unhaird and rounded, so that only the best part of the hide is made into buff leather. The grain and flesh being then scraped or cut off, the true cuticle, which is of a flexible fibrous nature, alone remains. The hide is next sprinkled over with cod-oil, and placed in the *stocks*, where it is worked for about 15 minutes. Having been taken out and partially dried, it is again submitted to a similar process of oiling and stocking; and during the first day, these operations may be repeated six times, decreasing daily for about a week, when one oiling and stocking in a day is sufficient. The hides are then placed in a stove, and subjected to a process called 'heating off,' after which they are scoured and rendered free from oiliness by being soaked in a strong lye of carbonate of potash. They are next worked well in the stocks, hot water being poured copiously upon them until the water runs off pure. Having been dried, they are subjected to a process called *grounding*—i. e., they are rubbed with a round knife, and also with pumice-stone and sand, until a smooth surface is produced. The leather, which is very pliant, and not liable to crack or rot, is now ready for the market, and is generally used for soldiers' belts and other army purposes.

During the early part of this century, the principal seat of the B. L. manufacture was in the neighbourhood of Edinburgh, one manufacturer turning out, previous to the battle of Waterloo, about 1300 hides per week. In peaceable times, the demand for B. L. is comparatively small, and the manufacture is now almost confined to London and the neighbourhood, where the raw material is most readily procured, and the demand for the manufactured article is greatest. The natural colour of the leather is light-yellow, but for some purposes it is bleached white. The precise chemical operation of the oil in the process of the manufacture is rather obscure, but as no glue can be got from hide that has been made into buff, the gelatine of the hide must have entered into combination with some of the constituents of the oil, and had its nature completely changed.

BUFFON, GEORGE LOUIS LECLERC, COMTE DE, one of the most famous naturalists and writers of the 18th c., was born at Montbard, in Burgundy, September 7, 1707. He studied law at the college of Jesuits at Dijon, but shewed so marked a predilection for astronomy and mathematics, that his father allowed him to follow his own inclinations. At Dijon, he became acquainted with Lord Kingston, whose tutor, a man of learning and taste, directed the mind of B. to the study of the sciences. With Lord Kingston and his tutor, B. travelled through France and Italy, and came to England, where, to improve his knowledge of our language, he translated Newton's *Fluxions* and Hales's *Vegetable Statics*. In 1733, he wrote several original essays, which gained notice in the Academy, of which he had been made a member. His general love of science received a definite impulse toward zoology by his appointment, in 1739, as intendant of the royal garden and museum. Hitherto zoology, consisting of a series of unconnected observations and fruitless attempts at classification, had been commonly regarded by educated readers as a dry

study, and by savans as play-work. B. first conceived the idea of making it attractive to the first of these classes, and of securing for it, at the same time, the respect of the second. His plan was assuredly comprehensive enough, since he aimed at nothing less than a collection of all the separate known facts of physical investigation, and a systematic arrangement of these, to assist the author in forming a theory of nature; but B. possessed neither the science nor the patience necessary for such a task. Endowed, however, with a brilliantly rhetorical imagination, and always inclined to deliver himself from doubts and ignorance by sparking hypotheses, the elaboration of which cost him little trouble, he contrived to produce a work which, if not severely scientific in its method, at least shone with what many then conceived to be the brightest literary lustre. However, it is not to be denied that many of his views are very ingenious, although later researches have completely exploded them. The *Natural History* of B. made an epoch in the study of the natural sciences, though it has now little or no scientific value. His attempted explanations of natural phenomena were opposed by Condillac, who, with Helvetius, Diderot, D'Alembert, and others, also ridiculed, with a certain degree of justice, the excessive pomp of style used by Buffon. The most insignificant part of B.'s treatise is the mineralogy, for which he was quite unqualified by the deficiencies of his chemical, mathematical, and physical knowledge. The systematic and anatomical arrangement of the mammalia was executed by Daubenton, the colleague of Buffon. B.'s works passed through numerous editions, and several were translated into most of the languages of Europe. The best complete edition is the *Histoire Naturelle Générale et Particulière*, in 36 volumes (Par. 1749—1788). After receiving several high honours, being elevated to the rank of Comte de B. by Louis XV., and treated with great distinction by Louis XVI., B. died in Paris, April 16, 1788. In person and carriage, B. was noble; as a Parisian academician, and a self-complacent, theoretical naturalist, dressed in courtly style, pursuing his pleasant studies in the *allées* of the Royal Garden, and largely participating in the vices of his time, B. was quite a model of a French philosopher of the 18th century. His son, Henri Leclerc, Comte de B., born 1764, was attached, at the outbreak of the revolution, to the party of the Duke of Orleans, and fell under the guillotine. His last words were: '*Citoyens, je me nomme Buffon.*'

BUFFOON (Fr. *bouffon*), a low jester. The Italian *buffo* (from *buffa*, a farce) is the name given to a comic singer in an opera. In the corrupt Latinity of the middle age, *buffa* meant a slap on the cheek; and in the Italian, *buffare* signifies the puffing of wind through the mouth. It is probably from the favourite trick played by clowns in farces—one swelling out his cheeks with wind, the other slapping them, so as to make a ludicrous explosion—that the terms *buffones* in Latin, *buffoni* in Italian, *bouffons* in French, and in English *buffoon*, were derived. In Italy, the *buffo cantante* is distinct from the *buffo comico*; the former having greater musical talent, and sustaining a more important part, the latter having greater licence in jocoseness. The voice of a *buffo cantante* is generally a bass, but sometimes a tenor buffo is introduced.

BUG, or **BOG**. There are two rivers of this name in Russian Poland. The Western B., the largest tributary of the Vistula, rises in Austrian Galicia, and after a course of about 450 English miles, and receiving numerous tributaries, it joins the Vistula at the fortress of Modlin, near Warsaw.

It is navigable for a considerable distance. The Eastern B., the Hypanis of the ancients, rises in Podolia, and flows south into the estuary of the Dnieper. Its length is more than 400 miles. It is navigable for small-craft as far as Wosnessensk. At the junction of the Ingul with the B., stands the city of Nicolaiew (q. v.).

BUG, a name applied to a large family of insects, *Cimicidae*, of the order *Hemiptera* (q. v.), sub-order *Heteroptera*, and often still further extended in its signification so as to include the whole of that sub-order, the insects of the section *Geocorisæ* being designated land-bugs, and those of the section *Hydrocorisæ*, water-bugs, the latter including water-scorpions, boat-flies, &c. All these insects, and particularly the land-bugs, although some of them are radiant in beautiful colours, have a strong resemblance in form and structure to the annoying and disgusting HOUSE B. or BED B. (*Cimex lectularius*). The statement that this insect was introduced into England with timber brought from America to rebuild London after the great fire of 1666, must be rejected as erroneous; for although it appears to have been comparatively rare in England, it was well known in some parts of Europe long before that time, and is mentioned by Dioscorides. The Bed B. is destitute of wings—an anomalous peculiarity, as the insects of its order, and even of the same family, are generally furnished with them.

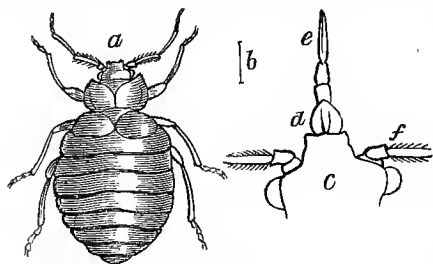

Bed Bug:

a, the insect, magnified; b, its natural length; c, the head, upper side; d, labrum; e, proboscis extended; f, base of antennæ—very highly magnified.

The body is very flat, of a somewhat oval form; the whole insect is of a dirty rust colour, emits an offensive odour, and is about three-sixteenths of an inch in length; the legs are moderately long, and capable of being employed for pretty rapid motion; the antennæ are thread-like and very slender, about half the length of the body; the mouth is formed for suction alone, and is furnished with a sort of proboscis, which is three-jointed, forms a sheath for the true sucker, and when not in use is recurved under the head and thorax. The B. lurks during the day in crevices of walls, of bedsteads, and of other furniture, but is sufficiently active during the night; and when it finds opportunity, sucks blood until it distends itself. It seems, however, to be capable of subsisting long without food. Young bugs resemble their parents in most things, except size and the want of *elytra* (q. v.), insects of this order not undergoing such marvellous transformations as those of some other orders. The best preventive of bugs in a house is *scrupulous attention to cleanliness*; but where the nuisance exists, it is not easily removed, and various means are employed for this purpose, of which one of the best and safest is thorough washing with spirit of turpentine, although recourse is even had to washing with a solution of corrosive sublimate.—Other species of B. (*Cimex*) suck the blood

of some of the inferior vertebrate animals, as pigeons, swallows, bats, &c.; but the greater number of insects of the B. family live by sucking the juices of vegetables. A small species (*Tingis pyri*), which sucks the leaves of the pear-tree, is very destructive in some parts of Europe, where it is popularly called the *tiger*. Some of these winged wood-bugs or field-bugs are capable of inflicting very painful wounds. Flying-bugs, 'enormous and fetid,' are among the pests of India. Night is the time of their activity. Warm countries generally have winged bugs of great size and beauty; but if touched or irritated, they 'exhale an odour that, once perceived, is never after forgotten.' A winged B., as large as a cockchafer, lodges in the thatch and roofing of houses in Chili, and sallies forth at night, like the Bed B., to suck blood, of which it takes as much as a common leech.—It is worthy of notice that a species of field-B. (*Acanthosoma grisea*), a native of Britain, is one of the few insects that have yet been observed to shew affection and attention to their young. De Geer observed the female of this species, which inhabits the birch-tree, conducting a family of thirty or forty young ones as a hen does her chickens, shewing great uneasiness when they seemed to be threatened with danger, and waiting by them instead of trying to make her own escape.

BUGEAUD, MARSHAL, was born at Limoges, in France, October 15, 1784. In his 20th year he entered the army as a private. His conspicuous bravery in the Prussian, Polish, and Spanish campaigns gained him rapid promotion. Shortly before the fall of Napoleon, B. was made a colonel, and in 1815 commanded the advance-guard of the army corps of the Alps. He afterwards retired to his estate, but was called into public life by the July revolution of 1830. He was elected deputy for Perigueux, and gained the esteem of Louis-Philippe, who created him a marshal. In 1835, he voted against electoral reforms and universal suffrage, denounced 'the tyranny of the press,' and soon contrived to make himself very unpopular. In December 1840, he was appointed governor-general of Algiers. He immediately set about organising the celebrated irregular force known as the Zouaves, and in a few years the French arms were everywhere triumphant over the Arab tribes. The cruelty of some of B.'s proceedings excited strong feelings of reprobation at the time, as well in France as in Europe generally. In 1844, he gained a victory over the Emperor of Morocco's forces at Isly, for which he was created Duc d'Isly. In the revolution of February 1848, Marshal B. had the command of the army in Paris, and would have dissuaded the king from signing the act of abdication; but panic made such counsel useless. Among all the friends of Louis-Philippe, Marshal B. seems to have been the only man who preserved firmness and presence of mind. When Louis Napoleon became president, he intrusted the chief command of the army of the Alps to B., who died of cholera in Paris, June 9, 1849.

BUGENHAGEN, JOHANN, surnamed *Pomeranus*, or Dr Pommer, one of Luther's chief helpers in the Reformation, was born at Wollin, near Stettin, in Pomerania, 1485; studied at Greifswald, and as early as 1503 became rector of the Treptow Academy. There he lived quietly, fulfilling the duties of his office until 1520, when his religious views were changed by reading Luther's little book, *De Captivitate Babylonica*. B. was now seized, as it were, by the zealous spirit of the Reformation, and, to avoid the persecutions of the Catholic party, he betook himself to Wittenberg, where his talents procured for him in succession

BUGLE—BUILDING.

several high positions. B.'s remarkable philological and exegetical powers were of great service to Luther in his translation of the Bible. In 1525, he opened the controversy between Luther and Zwingli by a treatise against the latter, to which Zwingli ably replied. He possessed a superior talent for organisation, establishing churches in Brunswick, Hamburg, Lubeck, and Pomerania. In 1537, he was called to Denmark by Christian III. to reform the ecclesiastical establishments of that country. He accomplished this so admirably, that the Danes to this day consider him their Reformer. In 1542, he returned to Wittenberg, and continued his energetic efforts to extend the new theology throughout his native land. He died 20th April 1558. His best work is his *Interpretatio in Librum Psalmorum* (Nürnberg, 1523).

BUGLE (*Ajuga*), a genus of plants of the natural order *Labiatae*, having an irregular corolla, with very short upper lip and trifid lower lip, the stamens protruding. The species are mostly natives of the colder parts of the Old World, and several are British. The Common B. (*A. reptans*) is abundant in moist pastures and woods. Its flowers are generally blue, but varieties occur with white and purplish flowers, which are often introduced into flower-borders. The Alpine B. (*A. alpina*) is one of the beautiful flowers of the Swiss Alps.

BUGLOSS, a name popularly applied to many plants of the natural order *Boraginæ* (q. v.), as to the species of *Anchusa* or Alkanet (q. v.), &c. In some botanical works it is confined to the genus *Lycopsis*, a genus differing from *Anchusa* in little but the curiously curved tube of the corolla, and of which one species, *L. arvensis*, is a common weed in cornfields in Britain. The beautiful genus *Echium* bears the English name of **VIPER'S BUGLOSS**.

BUHL-WORK, or **BOOL-WORK**, is the name applied to a sort of inlaying of brass scrolls and other ornamental patterns in wood. The name is derived from its inventor, Boule, an Italian cabinet-maker, who settled in France in the reign of Louis XIV. He employed veneers of dark-coloured tortoise-shell, inlaid with brass. Cabinets of his manufacture are highly prized, as are also those of his contemporary Reisner, a German, who used a ground of tulip-wood, inlaid with flowers, &c., in darker woods, and varied with margins and bands of light wood, with the grain crossed for contrast. This modification of B. W. is correctly called Reiser work. For details of the methods of working, see **INLAYING** and **MOSAIC**.

BUHRSTONE, a variety of quartz (q. v.), containing many small empty cells, which give it a peculiar roughness of surface, particularly adapting it for millstones. The name is given without reference to geological relations, but it is *vein quartz*, rather than true *quartz rock*, which ordinarily assumes the character of buhrstone. There are different varieties of B., some of which are more compact, or have smaller cells than others; and those in which the cells are small and very regularly distributed, about equal in diameter to the spaces between them, the stone being also as hard as rock-crystal, are most esteemed. Good B. is found at Conway in Wales, and at several places in Scotland; but the finest millstones are obtained from the quarries of La Ferté-sous-Jouarre, in the department of Seine-et-Marne, near Paris. A single millstone in one piece of 6 feet diameter, sells for about £50, and one formed of several pieces for about £33. It is not unusual to form millstones of pieces of B. cut into parallelepipeds, like great wedges of soap, and bound together by iron hoops.

The stone is found in beds or in detached masses, and the mode of quarrying is peculiar. When the mass is large, it is cut out into the form of a huge cylinder; around this, grooves are cut, at distances of about 18 inches, the intended thickness of the millstones; into these grooves, wooden wedges are driven, and water is thrown upon the wedges, which, causing the wood to swell, splits the cylinder into the slices required.—Millstones are not always made of B., but sometimes of silicious gritstones, of sandstone, and even of granite. B. millstones are extremely durable.

BUILDING, the art of erecting or building houses and other edifices, in which several distinct professions are usually and more immediately concerned. At the head of the building-trade is the architect, who is employed to draw plans and make out specifications of the work to be performed. The builder acts ministerially; his duty consists in carrying out the plans put into his hands, according to certain stipulated terms. The profession of the architect demands not only much imaginative power, but great artistic skill, along with a practical knowledge of details. Endeavouring to realise the wishes of his employer, the architect devises what shall be the external effect and interior accommodation of a building, and portrays the whole on paper with rigorous accuracy. Besides general designs to give an idea of the structure and its interior arrangements, he furnishes the working plans or drawings, which are to guide the different mechanics—masons, joiners, &c.—in their several operations. These services of the architect, of course, involve much thought and labour, and he is therefore under the necessity of employing a staff of assistants, by whom the plans are executed under his orders. The making out of the specifications is a matter of careful study. To perform this part of his duty properly, the architect needs to be acquainted with the qualities of different kinds of materials; such as stone, lime, sand, bricks, wood, iron, &c. A knowledge of the strength of timber is particularly desirable. When the specifications are made out, they and the contract are subscribed by the builder. To insure as far as possible a faithful adherence to the specifications, the architect appoints a 'clerk of works' to keep watch over the whole operations, and who is authorised to check any seeming fault. During the whole proceedings, the architect is paramount. For the due execution of his plans, he feels that his professional reputation is at stake; and, accordingly, having involved his responsibility, the employer cannot with propriety interfere to make alterations while the work is in progress. Such is the etiquette of the profession. Should alterations be desirable, they become matter for a fresh agreement among the parties. When the works are finished, the builder hands his account to the architect to be examined and checked. If satisfied of its correctness, he grants a certificate of the fact, and this is the warrant for payment by the employer. The builder having been settled with, the employer now pays the architect's fee, which closes the transaction. This fee may be one, two, or more per cent. on the entire cost of the B., according to local usage or terms agreed on; whatever it is, it covers all charges for advice, plans, and other professional trouble.

Builders undertake work by 'contract,' or by 'schedule of prices.' If by contract, they engage to execute the whole works for a stipulated sum. If by schedule of prices, they agree to abide by the measurements of valuers appointed by the architect. These valuers go over the works when finished, and, taking an exact account of everything,

compare it with the account rendered by the builder; the architect being the ultimate referee. It is exceedingly important, for the sake of an amicable adjustment of accounts, that the builder should adhere scrupulously to the letter of the specifications—i. e., the covenant under which he has become bound. He can justify no departure from the specifications, on the plea that something as good has been given or done, or that he was not checked at the time by the clerk of works. Being explicitly a person employed to do a certain piece of work, in a certain way, he is in no respect entitled to substitute his own notions for those of his employers.

It may happen that a proprietor acts as his own architect, and employs a builder to execute his designs, on the understanding that he is to pay for everything according to a schedule of prices. In many instances, the builder is proprietor as well as architect, and merely carries out his own plans. Such is generally the case in the neighbourhood of London, where builders speculate in leasing land and erecting rows of dwellings for sale. This plan is greatly facilitated by the opportunity of buying every article required in house-building ready for use; such as bricks, door-steps, hearthstones, joists, flooring, doors, windows, marble mantel-pieces, slates, &c. In fact, house-building in the metropolitan district is very much reduced to a system of purchasing and putting together certain articles from manufactories and depôts. For this kind of business, there may be said to be establishments for the sale of doors and windows, as there are shops for the sale of nails, locks, and hinges.

The application of a comprehensive manufacturing system in the preparation of various parts of a building is observable most particularly in certain establishments of great magnitude. The test is this—whether the builder conducts so gigantic a trade as to warrant him in setting up a steam-engine of great power, and in providing highly wrought machines for cutting and otherwise treating wood, stone, &c. When once this degree of magnitude is reached, the operations are conducted under very great advantage. The Crystal Palace in Hyde Park could never have been built at the stipulated cost, nor in the required space of time, but by the application of steam-power to work the machines which shaped and grooved the *two hundred miles* of sash-bars; by the resources of the largest English establishment in the glass-trade, in making one million square feet of sheet-glass; and by the skill and capital of our great iron manufacturers, in rapidly producing three thousand iron columns, and more than that number of iron girders. When the late Mr Thomas Cubitt was engaged in the vast building operations at Belgravia (a district in the west of London owned by the Marquis of Westminster), his factory on the banks of the Thames was the most complete ever known in the trade. It exemplified both the principles adverted to above—the manufacture of various articles by steam-worked machinery; and the collecting of large stores of other articles made in a similar way by other firms. There was a store of drawing-room and parlour doors, a store of window-sashes, a store of street-doors, and stores of mantel-pieces, stone and marble steps, balusters, slates, knockers, bells, and all the materials for house-building from the coarsest to the finest. There was also observed that systematic gradation of kinds and dimensions which is so much attended to in the higher kinds of machinery, and which so much expedites all operations; seeing that one particular piece would not only fit into or against another, but into or against any one of a whole class to which that other belonged. A house

built in this systematic way partakes a good deal in the nature of a large machine, in which all the parts fit together with very great accuracy. There can be little doubt that if skill and capital be judiciously applied in this way, a house ought to be better built and to cost less than if built in the ordinary un-systematic manner. It may also be mentioned here, that Mr Cubitt was the owner of a very large brick-making establishment on the banks of the Medway, between Rochester and Maidstone, where steam-power was employed in all the operations of making bricks. Some of the great railway contractors, who have become millionaires, were originally house-builders, alive to the grand results producible by the combination of steam-worked machinery with the labour of well-organised bodies of men.

As an art, B. is of vast antiquity, and has assumed different forms, according to the necessities of mankind and the materials readily at their disposal. In ancient Egypt, Greece, and Italy, B. in stone rose to a high state of perfection, and till the present day it may be said that the greatest progress in the art is made only where stone of a manageable kind is conveniently at command. Rome, and other Italian cities; Paris, Lyon, Bordeaux, and most cities in France; Brussels, Berlin, Leipsic, Munich, Geneva, Vienna, Edinburgh, and Glasgow are noble specimens of what may be achieved in stone workable with the chisel. On the other hand, London, the greatest city within the bounds of civilisation, is built of brick; so likewise are Manchester and Liverpool; also Amsterdam, Rotterdam, and other towns in Holland; and, as a general fact, it would appear that wherever brick has to be resorted to, there the allied arts of architecture and building, as regards domestic accommodation and elegance of style, are on a poor scale. B. with stone of a superior kind is now becoming common in New York, Philadelphia, and some other American cities. It is not necessary to trace in this article the various processes embraced in the comprehensive term BUILDING; seeing that all the materials used, and all the operations conducted, are noticed under the proper headings in the Encyclopædia.

BUILDING ACT FOR LONDON AND ITS NEIGHBOURHOOD. See METROPOLITAN BUILDING ACT.

BUILDING LEASES. In the law of England, a building lease is a demise of land for a long term of years, the lessee covenanting to erect certain houses or edifices thereon, according to specification. By the 19 and 20 Vict. c. 120, amended by the 21 and 22 Vict. c. 77, and which acts also apply to Ireland, the Court of Chancery is empowered to authorise leases of settled estates and B. L., which shall take effect in possession within one year next after the making of the same; the term for such building lease being ninety-nine years; or where the court shall be satisfied that it is the usual custom of the district, and beneficial to the inheritance to grant B. L. for longer terms, then for such term as the court shall direct. By a subsequent enactment, it is declared that the term building lease shall include a repairing lease, but such repairing lease to be for a term not exceeding sixty years.

By the 5 and 6 Vict. c. 108—passed to enable ecclesiastical persons to grant long leases for building, repairs, or other improvements—it is enacted that any ecclesiastical corporations, aggregate or sole, excepting as mentioned in the act, may, with consent of the *Ecclesiastical Commissioners for England* (q. v.)—to which, where the lessor is incumbent of a benefice, the consent of the patron also must

be added—demise by deed the corporate lands or houses for any term not exceeding ninety-nine years, to take effect in possession and not in reversion, to any person willing to improve or repair the same; provided, that on the grant of such leases, a small rent may be reserved during the six first years, with an increased rent afterwards; but no such lease is to comprise the usual house of residence, its out-buildings or pleasure-grounds. The act contains other regulations, and it declares generally that it is made without prejudice to any right that ecclesiastical persons have under the former law to grant or lease, whether by renewal or otherwise.

In the Scotch law, the term building lease is applied to the case of proprietors of entailed estates, who, in order to encourage the building of villages and houses upon property so settled, are to have it in their power to grant leases of land for the purpose of building, for any number of years not exceeding ninety-nine years. See this matter regulated by the 10 Geo. III. c. 51. By the 3 and 4 Vict. c. 48, proprietors of entailed estates in Scotland may feu or lease on long leases ground for the building of churches and schools, and for the dwelling-houses and gardens for the ministers and masters of the same, and also for burying-ground and play-ground attached to such churches and schools. See LEASES and LEASEHOLD.

BUILDING SOCIETIES. See BENEFIT SOCIETIES.

BUILDING STONE. The chemical composition of B. S. varies. The majority of kinds are more or less silicious, and are designated sandstones. These consist of particles of sand, united together by the force of cohesion, and by a small proportion of a natural cement; in some cases, ferruginous, consisting of a compound of iron; and in other instances, calcareous, composed of carbonate of lime. Igneous rocks furnish very durable B. S., though in general the hardness of the materials renders them so difficult to work, that they are seldom resorted to where softer stones can be procured. Thus, granite is largely employed in the construction of the houses in Aberdeen, in the erection of bridges, in the paving of streets, and wherever great durability is required. Greenstone and basalt are also occasionally used. The B. S. employed in the new Houses of Parliament is a magnesian limestone, or a double carbonate of lime and magnesia, which is very close and compact in texture, is soft enough to be easily cut with the chisel, but durable enough to resist weathering, and retain the sharp outline of the carving. The other forms of carbonate of lime exhibit considerable durability. In the vicinity of Bath, as also in the Isle of Portland, an oolitic limestone is quarried, which is easily cut, and stands well.

A very convenient and accurate way of determining the durability of a B. S.—in other words, its power of resisting the effects of frost and other atmospheric agencies—is to place a small block in a cold saturated solution of sulphate of soda; raise to the boiling-point, so as to expel air from cavities in the stone, which then become filled with the solution; then allow to cool, and suspend the block of B. S. in air. Every now and then, it is dipped into the solution, and subsequently air-dried. The result is, that the sulphate of soda crystallises on the outside, and partially in the interior of the block, and in this respect acts as water does when it is frozen during winter; and if the B. S. be porous, and liable to decay by natural agencies, it gradually breaks up, and particles scale off. The amount of this corrosion can be determined by weighing the detached portions. Some building stones contain iron pyrites in little nodules diffused

here and there throughout the mass, and such become discoloured from the pyrites being decomposed by atmospheric influence, and the brownish-red oxide of iron (rust) is left as a stain on the surface of the block. The liability to decay or to discoloration in a B. S. may be arrested to a great extent by coating the outer surface with boiled linseed-oil, which communicates a dark appearance to the stone, but prevents oxygen or moisture from gaining access to the block. Ordinary oil-paint is employed for the same purpose. For the preservation of B. S. from decay by means of various solutions, see STONE, PRESERVATION OF.

BUJALA'NOË, a city of Andalusia, Spain, about 20 miles east of Cordova. It is surrounded by a moat and a wall flanked with old towers, has an old Arab castle, and manufactures of woollens, glass, and pottery, exports of agricultural produce, and an important annual cattle-fair. Pop. about 9000.

BU'KKUM WOOD. See BRAZIL WOOD and SAPPAN WOOD.

BU'KKUR, a fortified island of the Indus, in Sind, in lat. 27° 39' N., and long. 68° 56' E. It is 400 yards from Roree on the left bank, and 100 from Sukkur on the right. In the ordinary state of low water, the western and eastern arms of the river are respectively 15 feet and 30 feet deep. In particularly dry seasons, however, the former has been known to disappear altogether, and even the latter is said to have occasionally been fordable. In 1839, a British force, on its march to Afghanistan, made a stepping-stone, as it were, of B. in crossing the Indus, having joined it to either mainland by a bridge of boats. B. is no longer of any military value against a civilised assailant, commanded, as it is, on both sides by higher grounds. It is composed of limestone, being 800 yards long, and 300 broad, and rising 30 feet from the average level of the stream.

BUKOWI'NA, formerly the south-eastern division of Galicia, now a distinct crown-land of the Austrian empire, on the Russian frontier, occupies an area of 3981 square miles, with a population in 1857 of 462,242. It is traversed by offsets of the Carpathians, gives rise to many rivers, and abounds in wood, along with considerable mineral riches. Wood-cutting and mining afford occupation for a great number of the inhabitants. Large numbers of cattle are reared, and also excellent horses. B., till the end of the 15th c., belonged to Transylvania, when it came under the dominion of the Turks, by whom it was ceded to Austria in 1777. Czernowitz is the chief town.

BULACA'N, a town of Luzon, Philippines, at the head of the Bay of Manilla, about twenty miles north-west of the city of that name. B. is chiefly composed of wooden houses, but has spacious streets, manufactures of silken mats and other fabrics, and large sugar-boiling establishments. Pop. between 9000 and 10,000.

BULB, in Botany, a subterranean bud covered with imbricated scales, having at their base a flattened disc, which represents the proper stem of the plant, and from which the roots proceed downwards, whilst from the midst of the scales an annual herbaceous stem and leaves are sent up. The scales are regarded as modified leaves, and sometimes are all fleshy, as in the lily; sometimes the outer ones are membranous, as in the onion, in which case the B. is said to be *unicated*. The B. is popularly but erroneously regarded as the root or part of the root of the plant, and plants in which it is found are very generally described as *bulbous-rooted*. New buds are formed in the axils of its scales, which grow at the expense of the parent B., and gradually

destroy it. In some plants, as the tiger-lily and some species of allium, leaf-buds (*bubblis* or *bubbllets*) are developed on the stem above ground, which spontaneously separate and serve for the propagation of the plant, and which are entirely of the nature of bulbs, being formed of thickened scales, sometimes so closely united as to form a solid mass. The CORN (q. v.) was formerly regarded as a kind of B., and described as a solid B., but its structure is essentially different, although both it and the TUBER (q. v.) may be included in the description which Linneus has given of the B. with reference to the purpose which it serves as 'the winter-quarters of the plant.' Many bulbs, if removed from the ground during the period when the vegetation of the plant is most dormant, may be kept in a dry place without injury for a considerable time, even for years. Bulbs serve also for the preservation of plants in periods of drought, and are particularly frequent in those which delight in sandy soils. The abundance of 'bulbous-rooted' plants is a remarkable characteristic of the flora of the Cape of Good Hope. 'Bulbous-rooted' plants are very often distinguished by the beauty of their flowers, and many of them are among the most esteemed ornaments of gardens, green-houses, and stoves. The bulbs of tulips, hyacinths, and other favourite flowers are important articles of trade. Some bulbs, as that of the onion, are valuable as articles of food; others, as that of the squill, upon account of medicinal properties.

BULBUL, an Armenian name for the night-ingale, which has found its way into English poetry chiefly through the patronage of Lord Byron. But the same name is given in India to a very different bird, *Pycnonotus hæmorrhous*, belonging to the great tribe of *Dentirostres*, and formerly ranked among the thrushes, to which it is pretty nearly allied. It is a little bird of brilliant plumage, and the male has a crest or tuft on its head. It is remarkable for its pugnacity; the Singhalese consider it the most game of all birds, and the training of it to fight was one of the duties intrusted by the king of Kandy to the Koorowwa or Bird Headman. When pitted against an antagonist, such is the obstinate courage of this little creature, that it will sink from exhaustion rather than release its hold.—*Sir J. E. Tennent's Ceylon*.

BULGARIA, an extensive province of European Turkey, in lat. 42° 8'—45° 20' N., and long. 22° 15'—29° 35' E. The Danube flows along the whole of its northern boundary; on the E. it has the Black Sea; and on the S. the Balkan range divides it from Rumelia and Macedonia. It has an area of about 33,000 square miles, with a population, in 1844 (the latest return), of 3,000,000. The country slopes terrace-like from south to north, and from the west to the east, acquiring a plain-like character before reaching the Black Sea. The rivers are rapid, and tributary to the Danube. The soil in some parts is very fertile, producing great abundance of corn; in others, it does not yield sufficient for the consumption. There is excellent pasture-land, and the lower terraces are richly wooded. The exports include horned cattle, sheep, corn, wine, iron, wood, honey, wax; and otto of roses is an important article. The government is in the hands of the Mohammedan Beglerbeg of Rumelia; and for administrative purposes, B. is divided into four sanjaks—viz., Silistria, Widdin, Nissa, and Sophia, with the city of Sophia for a capital. In a military point of view, B. holds a position of great importance, and has been, in consequence, often an arena of warfare, from the time of the Roman and Byzantine to that of the Turko-Russian campaign of 1854.

The earliest known inhabitants of B. were the Mœsians, who contended long against the Romans, and allied themselves with Gothic and Slavonic tribes against the Greek empire. Anastasius, the Greek emperor, in 507, built an extensive wall to defend his territories from Mœsian invaders. In the 7th c., the Bulgarians, a people of Finnish origin, whose original seat was the banks of the Volga, conquered the Mœsians, and established the kingdom of Bulgaria; they soon lost their own language and customs, and became assimilated to the other Slavonic inhabitants. After being tributary to the Greek emperors, and contending for some time against Hungary, B. became subject to the Porte in 1392; but the frightful oppression of despotic and sanguinary pashas has not, even to the present day, robbed the inhabitants of a distinctively national life and love of freedom. Since 866, the Bulgarians have chiefly belonged to the Greek Catholic Church.

The BULGARIAN LANGUAGE is divided into two dialects—Old Bulgarian and New Bulgarian; the former, the richest and best of the Slavonic dialects; the latter, very inferior, and chiefly remarkable for its store of popular songs.

BULGARIN, THEODORE, one of the best known Russian authors, was born in Lithuania, 1789; received a military education in St Petersburg; and, in 1805, served in the campaign against France. Later, however, he forsook the Russian army for the French, and after sundry reverses was, in 1814, appointed by Napoleon to the command of a division of volunteers. After Napoleon's fall, B. went to Warsaw, where he contributed several poetical and humorous works to Polish literature. But, ultimately, he settled in St Petersburg, and devoting himself to the study of Russ, soon became a popular author. In 1825, together with his friend Gretsck, he began the *Northern Bee*, and since then he has written several romances—of which *Demetrius* and *Mazeppa* are the best—and published different periodicals. B. is humorous and graphic as a writer, judicious as an editor, as a critic, severe, and by no means dispassionate. His large work, *Russia in its Historical, Statistical, Geographical, and Literary Aspect*, has been with his sanction translated into German, and published at Riga, 1839—1841.

BULGEWAYS are timbers so placed as to facilitate the launching of a ship; for which, see LAUNCHING.

BULKHEADS, in a ship, are the partitions between the several portions of the interior; whether to separate it into rooms, or as a safeguard in case of wreck. In ships of war, the B. or partitions between the several cabins and storerooms are chiefly of wood; and most or many of these are removed when preparing for action, in order to obtain clear space for working the guns. In emigrant ships, the B. between the cabins are frequently mere lattice-work.

Water-tight B. are among the improvements in modern ship-building; they are iron walls running athwart the hold, as a means of dividing it into several portions; the interior is thus cut off into cells, each water-tight in reference to its neighbours. When such a ship is leaking in any one of the compartments, there is thus a chance that the others may be kept dry until the damage is repaired. Most of the large passenger-steamers are to some extent provided with these bulkheads. The *Great Eastern* has no less than ten of them, extending nearly up to the level of the upper deck. The presence of these B. greatly lessened the amount of injury occasioned by the explosion on board that

ship, on the 9th of September 1859; seeing that the disruption was thereby wholly confined to the compartment in which it occurred.

BULL (Lat. *bulia*, primarily, anything round or swelling) was originally the name of the capsule of the seal appended to letters from emperors or from the pope. Afterwards, the word was applied to the seal, and next to the document itself, as in the case of the celebrated Golden Bull of the Emperor Charles IV., which was so named from the golden capsule appended to imperial letters and other important documents by the Byzantine and Frank emperors as early as the 9th century. They are issued by the apostolic chancellor, and are dated 'from the day of incarnation,' whereas briefs are always dated 'from the day of the nativity.' The name is now applied exclusively to letters or documents issued in the name of the pope. In cases of granting favours, &c., the seal is appended to the open letter by a yellow or red band of silk; but in the administration of justice, a gray hempen band is used. All bulls, excepting those addressed to the United Greek Christians, are written in Latin with Gothic letters, and on the rough side of the parchment. See **BRIEF**. All bear the name and title of the pope—for example, *Gregorius Episcopus Servus Servorum Dei*, &c., is prefixed; then follows a general introduction, of which the initial words are used to give a distinct name to the B., as in the examples: the B. *Eccurgete Domine*, issued by Pope Leo X. against Luther in 1520; the B. *In Cœna Domini*, the celebrated B. against heretics, often re-issued since 1536; the famous *Unigenitus*, or B. against Quesnel's writings, 1713; the *Dominus ac Redemptor Noster*, or B. for the abolition of the order of Jesuits; the *Ecclesia Christi*, or the B. which completed the *concordat* with France in 1801; the *De Salute Animarum*, or the B. for the regulation of the Catholic Church in Prussia. To every B., the leaden seal of the Church is appended, hearing on the obverse the arms of the pope, and on the reverse his name. Bulls issued during the interim between the election and consecration of a pope have no armorial bearings on the seal. A *bullarium* is a collection of papal bulls, as the *Bullarium Magnum Romanum a Leone Magno ad Benedictum XIII.* (19 vols., Luxembourg, 1727—1758), the *B. Romanum* (28 vols., Rome, 1737—1744), and the *B. Benedicti XIV.* (Mechlin, 1826—1827), and more recently, the continuation of the *Bullarium Romanum Magnum* by Barberini (Vienna, 1835).—From the same medieval Latin word *bulia* is derived the word *bulletin* (Italian, *bulletino*), commonly applied to dispatches from generals, reports of the health of royal personages, and on the continent, at least, to other brief authenticated documents, such as those of scientific societies, the best known of which are the bulletins of the St Petersburg and Belgic academies. It is, moreover, used as a title for periodicals, and, in France, also designates the slips of paper on which electors write their votes.

BULL, OLE BORNEMANN, a famous violinist, was born 5th February 1810, at Bergen, in Norway. No very authentic account of him is obtainable. His father, it is said, attempted to coerce him into the study of theology, and would not permit a musical instrument about the house. This foolish treatment only gave a more decisive character to the peculiar genius of the boy. Having gone to the university of Christiania in 1828, he found an opportunity to play at a concert, where his skill excited such enthusiasm, that he shortly after was offered the situation of music-director in the city. He accepted it, but in the following year went to Cassel, in

Germany, to study under Spohr. After several vicissitudes, he came to Paris in 1831, and afterwards travelled through Switzerland and Italy. During this period, he developed his peculiar style of playing, which was essentially that of the school of Paganini. B., however, wished to excel his model in originality, and in triumphing over the most extraordinary difficulties; but it was impossible for him to follow the flight of the great Italian, in whose brain some capricious musical demon seemed to lurk. Nevertheless, he was received in Italy with prodigious enthusiasm—Malibran herself embracing him on the stage at Naples. In 1836, he visited England, Scotland, and Ireland, and subsequently travelled in a professional capacity through Belgium, Holland, Russia, and Germany. After a long repose, he sailed for America, whence he returned in 1850; but he again went out, and was so successful, that he thought of retiring from public life. He purchased in Pennsylvania 125,000 acres of excellent ground, and founded a colony of Scandinavians. This turned out a complete failure, and B. has been again compelled to resume his violin. He has once more visited Europe, and in the early part of 1860 was giving concerts to enthusiastic audiences in Stockholm.

BULL, GEORGE, D.D., a learned prelate and theological writer, born at Wells, Gloucestershire, England, March 25, 1634; studied at Oxford, whence he retired in 1649, having refused to take the commonwealth oath imposed by the parliament. Receiving holy orders, his first charge was the parish of St George's, Bristol. In 1653, he obtained the rectory of Suddington St Mary's, near that city; and in 1662, was presented to the vicarage of Suddington St Peter's. In 1669, he published his *Harmonia Apostolica*, the object of which was to reconcile the apostles Paul and James on the subject of justification. This work occasioned considerable controversy among divines, and in answer, B. published his *Examen Censuræ*, and *Apologia pro Harmonia*. In 1678, he was presented to a prebend in Gloucester Cathedral, and made Rector of Avening, Gloucestershire. In 1679, he was installed Archdeacon of Llandaff, and received the degree of D.D. from Oxford University. In 1685, he published his *Defensio Fidei Nicenæ*, against the Arians and Socinians, Tritheists and Sabellians; and in 1694, his *Judicium Ecclesiæ Catholicæ*, for which the thanks of the whole French clergy were sent to him through the celebrated Bossuet. His last work was his *Primitive and Apostolical Tradition*, &c. He was consecrated Bishop of St Davids in 1705, and died February 17, 1709.

BULLA, a genus of Mollusca, which in the older systems, founded upon characters taken from the shell alone, contained a heterogeneous assemblage of species essentially very different. Some of those having been removed to other orders, according to their organisation, the genus *Bulla*, and the family *Bullidae*, of which it is the type, are placed in the order *Tectibranchiata* of Cuvier, an order of the class *Gasteropoda* (q. v.), and of that section of it called *Monacia*, having the male and



Bulla Aperta.

female organs of sex combined in the same individual. The *Bullidae* have a convoluted and generally thin shell, which serves as a covering and protection for the gills, and which in some of them is large enough to form a retreat for the entire animal, in others, is itself enveloped in the mantle. This shell forms a sort of transition link between the flat calcareous plate enclosed in the mantles of the *Aplysice*

or Sea-hares—to which B. is nearly allied—and the spiral shell of snails and other such conchiferous mollusks. The mouth of the shell is large, extending the whole length of the shell, widening towards one end, the lip acute. The gizzard of the *Bullidæ* is very muscular; and among its thick coats, in many species, are found calcareous bony plates, which being moved against each other by its muscles, serve to grind down the food. All the species are marine, some are found on the British coast. Some, from their form and fragility, are popularly called BUBBLE SHELLS, as the British *Bulla Hydatidis*.

BU'LLACE (*Prunus insititia*), a shrub or small tree, larger and much less spiny than the sloe, but very closely allied to it, as it is also to the plum, so that many botanists regard them all as one species, an opinion much confirmed by the circumstance that the varieties pass into each other by imperceptible gradations. The B. may be regarded as a form intermediate between the plum and the sloe. Its leaves, however, are generally broader in proportion to their length than those of either of these, and its fruit-stalks more frequently in pairs; it differs also from both of them in its downy fruit-stalks, and in having the under side of its leaves permanently downy. The flowers are rather larger than even those of the plum; the fruit is larger than the sloe, generally globose, and, although it partakes in some degree both of the acidity and the roughness of the sloe, it is not unpleasant, especially after having been mellowed by frosts, and makes excellent pies or tarts. 'A bullace-pie is a standing dish at the harvest-home supper in the south of England, only it requires rather more sugar than the housewife is always willing to allow.' The B. is common in hedges, coppices, and banks in England, and in many parts of Europe. It is rare in Scotland.

BULL-BAITING, a barbarous sport, once very popular in England, and in which all classes of society equally delighted, but now, through the progress of civilisation, almost entirely confined to the lowest, and rare even among them. It consists in causing a bull to be attacked by dogs; and in order that the bull might be made as furious as possible, his nose was sometimes blown full of beaten pepper before he was turned loose. Another form of this sport was to fasten the bull to a stake, by a rope of some yards long, and to send bull-dogs against him, one at a time, which were trained to seize him by the nose, and when this was accomplished, it was called *pinning* the bull. But no small part of the enjoyment of the spectators was derived from the success with which the attacks of the dogs were met by the bull lowering his head to the ground, and receiving them on his horns, often tossing them to a great distance. In some places, B. took place regularly as a sort of annual festival, and funds were sometimes left to provide for it. King James I. of England greatly delighted in this sport. When the late Emperor Nicholas of Russia visited England, before his accession to the empire, he was present at a boxing-match and a B., which were got up to shew him English tastes.

An equally barbarous sport, termed *Bull-running*, was formerly practised at Stamford and Tutbury, where men and women took the place of dogs, maddened the bull with hideous noise, and then pursued it with 'bull-clubs,' till the unfortunate animal expired beneath the blows of its brutal assailants.

BULL-DOG, a kind of dog which is regarded as peculiarly English, but concerning which it is doubted whether it has existed as a distinct race, at least from the Roman era, or has more recently

sprung up, as a variety of the mastiff, or a cross between the mastiff and some other breed. Buffon, indeed, represents the B. as the parent race, and the mastiff as derived from it, but this opinion is generally rejected as erroneous. The B. has been regarded as a distinct species by some naturalists, and named *Canis Anglicus*, *C. laniciarius*, &c. It is much smaller than the mastiff, but is very strong



Bull-dog.

and muscular. The breadth of muzzle is greater than in the mastiff, and the head is very large, almost appearing as of disproportionate size to the body. 'The forehead sinks between the eyes, and the line of the nose rises again at a considerable angle; the lower jaw projects beyond the upper, often shewing the teeth, which altogether, with the frequent redness about the eyelids, produces a most forbidding aspect; the ears are partially drooping, unless the terrier blood is crossed in the animal, and the tail is carried high.' The hair is short, and the tail taper, and not bushy. The present breed is commonly ochry or reddish buff, with the nose and chops alone black; but a brindled breed formerly prevailed, which was often exported to the continent for strengthening the packs of wolf and boar hounds. The B. is seldom to be seen except in the company of persons who delight in dog-fighting and other barbarous sports. It was formerly much employed in bull-baiting, from which it derives its name. It is chiefly remarkable for its savage ferocity, and the pertinacity with which it retains its hold, as if its jaws were locked, and it could not let go. It will hang to the jaw or nose of a bull, although lifted from the ground. Colonel Hamilton Smith says he has seen one 'pinning an American bison, and holding his nose down, till the animal gradually brought forward its hind feet, and, crushing the dog to death, tore his muzzle out of the fangs, most dreadfully mangled.' The B. is also bold enough to attack any animal, however superior in size and strength.

The BULL-TERRIER is probably a mere variety of the B., or a cross between the B. and the terrier. It is smaller than the B., more lively, 'and, if possible, still more ferocious.' The ears are always pointed; the colour is very commonly white, with some black about the head. It is unrivalled in rat-catching.

BULLER, CHARLES, born in Calcutta in 1806, was a gentleman whose name falls to be recorded more on account of the hopes which his death in 1848 disappointed, than for the performances of his life. He was educated at Harrow and Cambridge, at both of which he distinguished himself, and for a time studied in Edinburgh, where he had Mr Thomas Carlyle for one of his tutors. He was called to the English bar in 1830, and entering

parliament before the Reform Bill, continued a member of the Lower House till his death. He was still but a rising man when he died. In politics, a philosophical radical, he occupied successively the posts of Judge-advocate-general and President of the Poor-law Commission under Whig governments. The interest taken in his career, and his popularity, were, it would seem, largely owing to his amiability and accomplishments for society.

BULLET is the leaden projectile discharged from a musket, fowling-piece, pistol, or similar weapon. When the smooth-bore muskets alone were used by British infantry, the bullets were made by casting. Molten lead was poured into moulds; and the moulds were dipped in cold water, to hasten the solidification of the lead. The moulds were cooled after every few times of using; and the lead was heated only just to the degree for maintaining fluidity. At present, however, bullets are made more expeditiously, and more truly spherical in form, by a compressing machine, invented by Mr George Napier. The lead is first fashioned into a rod about a yard long by five or six eighths of an inch thick; this rod is passed between rollers to condense it; then between other rollers to press it into a row of nearly globular pieces; then a spherical die gives the proper form to each of these pieces; and, lastly, a treadle-worked punch separates them into bullets. With one of these machines, and two dies, nine boys can make 40,000 bullets in a day.

Spherical bullets for the old muskets, carbines, and pistols varied from 14 to 20 to the pound, and from 0.60 to 0.68 of an inch in diameter. There is a particular ratio, depending on the specific gravity of lead, by which the number to the pound will give the diameter, or *vice versa*.

Such bullets are, however, becoming every year less and less used in the army, being superseded by other forms better suited for rifles. These forms are singularly numerous. Robins's B. was egg-shaped, with the centre of gravity at the larger end;

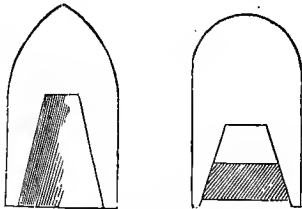

Minié and Enfield Bullets.

Beaufoy's was ovoid, with a hemispherical cavity at one end; Manton's was a spherical ball put into a wooden cup, with projections on the exterior; Greener's was oval, with a plug of mixed metal driven into a hole barely large enough for it; Norton's, Delvigne's, Minié's, and others, are, or were, of various elongated shapes, mostly with some kind of plug, which, driven into the lead by the force of the explosion, causes it to fill up the grooves in the rifling of the barrel. This expanding or dilating action has been claimed by many inventors; but the government, in 1857, awarded Mr Greener £1000, as the person who had practically solved the difficulty as far back as 1836. The bullets for the Enfield rifles are now made with extraordinary speed, by machinery of beautiful construction. The machine draws in a coil of leaden rod, unwinds it, cuts it to the required length, stamps out the

bullets with steel dies, drops them into boxes, and conveys them away. Each machine, with its four dies, makes 7000 bullets per hour; and four such machines, in an easy day's work, turn out 300,000 bullets. So nearly are the machines automatic, that one man can attend them all. Other machines, attended by children, produce an equal number of little boxwood plugs for filling the cavity at the hinder end of the bullet. To what degree the Minié, Enfield, and other bullets differ, will be briefly noticed in connection with the accounts of the rifles to which they belong.

BULLET-TREE, or **BULLY-TREE**, a tree found in Guiana, and valued for its wood, which is solid, heavy, close-grained, and durable, and also for its fruit, which is a drupe about the size of a cherry, and very delicious. It is supposed to belong to the genus *Mimusops* (natural order *Sapotaceæ*, q. v.).

BULLETTIN. See **BULL**.

BULL-FIGHT. Combats of men with bulls, for the entertainment of the public, were common in Greece, particularly in Thessaly, and in Rome under the emperors, though in later times they were forbidden both by emperors and popes. They are still a favourite pastime in Spain and Mexico. In Spain, they were abolished by Charles IV.; but Joseph, Napoleon's brother, re-established them, out of policy, the mass of the Spanish population being passionately fond of the sport. The most magnificent bull-fights were at one time instituted by the monarchs themselves; at present, both in the capital and in the larger towns of Spain, they are held either as private speculations, or for the benefit of public institutions. In Madrid, the bull-fighting season commences in April, and lasts until November. During that time, there is at least one afternoon in every week devoted to the sport. The proceeds go to the funds of the General Hospital. The fights take place in a kind of circus, called the *Plaza de Toros*, round which the seats rise one above another, like the steps of a stair, with a tier of boxes over them. The *Plaza* is capable of containing from 10,000 to 12,000 people, who pay a high price of admission, considering the rate of wages in Spain; and all go attired in their best to the spectacle. The best Andalusian bulls are bred at Útrera, the best Castilian ones on the Jarama, near Aranjuez. The latter are the breed usually chosen for fight in Madrid. They are fiercer and more active, but inferior in strength to British animals. The horses engaged in the conflicts are worthless brutes, fit only for the knacker. The men employed in the fight are generally those who have been bred to it as a profession, but occasionally amateurs may take part in it. The B. has been described as a tragedy in three acts. The principal performers in the first are the *picadores*; in the second, the *chulos* are the only actors; the third and last act devolves solely on the *matador*. The *picadores* are all mounted, dressed like Spanish knights of the olden time, and armed with a lance; they take up their position in the middle of the circus, opposite the bull-stalls. The *chulos*, who are on foot, are gay with ribbons, and wear very bright-coloured cloaks; they distribute themselves in the space between the barriers. The *matador*, or chief combatant, is also on foot. He is handsomely dressed, and holds in the right hand a naked sword, in the left the *muleta*, a small stick, with a piece of scarlet-coloured silk attached. On a sign given by the chief magistrate, a bull is let out from the stalls; the *picadores* stand ready in the arena waiting his charge. With a brave bull, they find all their skill requisite in acting on the defensive; with a cowardly one, they act on the offensive;

BULL-FINCH—BULLHEAD.

and should their stabs be ineffectual in rousing the animal to the requisite fury, the poor beast is hooted by the crowd, and ultimately stabbed ingloriously in the spine. Whenever a horse is wounded, the rider betakes himself to flight; and when either the above casualty happens, or a *picador* is thrown, the *chulos* rush in, and attract the bull by their cloaks, saving themselves, if need be, by leaping over the palisade which encloses the circus. At the same time, another *picador* calls off the bull's attention to himself by shouting. When the bull begins to flag, the *picadores* are succeeded by the *chulos*, who bring with them the *banderillas*—i. e., barbed darts about two feet long, ornamented with coloured paper-flags, which they stick into the neck of the animal. Sometimes these darts have crackers attached to them, the explosion of which makes the bull furious. The *matador* now enters alone to complete the tragic business. As soon as the bull's eye catches the *muleta*, he generally rushes blindly at it; and then the *matador*, if he is well skilled, dexterously plunges the sword 'between the left shoulder and the blade,' and the animal drops dead at his feet. The victorious *matador* is greeted with acclamations, and not less so the bull, should he wound or even kill the *matador*, in which case another *matador* steps forth into the arena; but human life is rarely sacrificed. Eight or ten bulls are often despatched in a single day; twenty minutes being about the time usually taken to slay one.

In Madrid, in June 1833, 99 bulls were killed in the course of a single week. Bull-fighters are regarded as the lowest class in Spain. They are very ignorant and superstitious; and those who are killed on the spot, and die without confession, are denied burial rites.

BULL-FINCH (*Pyrrhula vulgaris*), a bird of the great family of *Fringillidæ* (q. v.), a little larger than the common linnet, and of a genus closely allied to the Grosbeaks and Crossbills. The genus is particularly characterised by the short, thick, rounded bill, of which the sides are inflated and bulging, and the tip of the upper mandible overhangs that of the lower one. The B. is a bird of very soft and dense



Bull-finch.

plumage, of a delicate bluish-gray colour above, the under parts of a bright tile-red, the crown of the head and the beak jet black, which colour also appears in the greater wing and tail coverts, in the quills, and in the tail-feathers; the wings are crossed by a conspicuous white bar. The colours of the female are less bright than those of the male. The tail of the B. is almost even. This bird is not

unfrequent in England, Ireland, and the south of Scotland; and is found in most parts of Europe, from the south of Norway to the Mediterranean, extending eastward throughout Asia, even to Japan. It frequents woods and gardens, builds its nest in trees or bushes a few feet from the ground, feeds chiefly on seeds and berries in winter, and in spring is excessively destructive to the buds of fruit-trees in those localities in which it is abundant, selecting the flower-buds, and apparently finding them the most palatable of all food. Selby says: 'I have known a pair of these birds to strip a considerable sized plum-tree of every bud in the space of two days.' On this account, gardeners are sometimes compelled to wage war against the bull-finch.

The song of this bird, in a wild state, is very simple, and has no particular quality to recommend it; but it is remarkably susceptible of improvement by education; and trained bull-finches of superior acquirements are sold at a very considerable price. Some of these birds learn to whistle an air very accurately, and with a power and variety of intonation far exceeding their natural song. The ability to whistle several airs well, is rare. The training of these birds is a work both of time and trouble: it is chiefly carried on in Germany. Not less than nine months of training are requisite: it begins when the bird is a mere nestling, and must be carefully continued till after the first moulting; for it is a curious circumstance, that all which has been previously acquired is very apt to be lost at that time, or is afterwards so imperfectly remembered that the bird is of little value. The B. is capable of very strong attachment to those who feed and caress it, and often becomes so thoroughly domesticated as to exhibit no desire for liberty.—Curious variations of plumage are sometimes observed in it.—Other species of the genus *Pyrrhula* are known, natives of different parts of the world; and in this genus some ornithologists include *Corythus* of Cuvier, of which one species, the Pine-finch (q. v.), or Pine Grosbeak, is a native of Britain.

BULL-FROG (*Rana pipiens*), a species of frog (q. v.) found in most parts of the United States and Canada, but chiefly abundant in the southern states. It is of a large size, eight to twelve inches long, of an olive-green colour, clouded with black. It receives its name from the remarkable loudness of its voice, which has been compared to the bellowing of a distant bull, and comes in as a hollow bass in the frog concerts which take place in the evening and all night long in marshy places in America. Its voice can be distinctly heard at a distance of forty or fifty yards. It sits for hours during the day, basking in the sun, near the margin of a stream, into which it plunges with a great leap on the least appearance of danger. It does not confine itself to insect and molluscous food, like smaller frogs, but is said to be partial to young ducks, and to swallow them entire. Audubon says 'its flesh is tender, white, and affords excellent eating,' the hind legs, however, being the only part used for food. He adds that these parts make excellent bait for the larger cat-fish, and that he has generally used the gun for procuring them, loading with very small shot.

BULLHEAD, RIVER BULLHEAD, or MILLER'S THUMB (*Cottus Gobio*), a small fish, abundant in clear rivers and streams, in some parts of the British Islands, throughout the greater part of Europe, and in the north of Asia. It seldom exceeds four or five inches in length; is of a dark brown colour on the upper parts, and white beneath; has rather large fins, with rays slightly produced into spines and prettily spotted; and in

general appearance is not unlike the gurnards (q. v.). It is, however, generally regarded as a disagreeable object to the sight, on account of the great size and depressed form of its head, from which it derives its English names; the name, Miller's Thumb, alluding to the broad rounded form which the last joint of

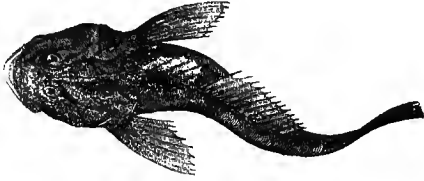

Bullhead.

the thumb of a miller used to acquire in times when machinery was ruder than now, by its continual employment in testing the quality of the flour produced, and in turning it over on the fingers for inspection, that it might be known if the mill was doing its work well. The appearance of the B. is rendered still more unattractive by the entire absence of scales, a characteristic of the genus to which it belongs, the whole body and head being covered with a soft skin. Yet it is said to be of a very delicate flavour, and in some countries is much sought after as an article of food. Its flesh, when boiled, is reddish, like that of the salmon. Izaak Walton speaks of angling for the B., and in his pleasant quaint style describes the habits of the fish: 'He does usually dwell and hide himself in holes, or amongst stones in clear water, and in very hot days will lie a long time very still, and sun himself, and will be easy to be seen upon any flat stone, or any gravel, at which time he will suffer an angler to put a hook baited with a small worm very near into his mouth, and he never refuses to bite, nor indeed to be caught, with the worst of anglers.'—The other British species of the genus *Cottus* (q. v.) are marine. The name B. is not usually given to any of them. A sea-fish of a nearly allied genus (*Aspidophorus*) is sometimes called the ARMED BULLHEAD; it is also known as the POGGE (q. v.).—The River B. differs from the marine species of the same genus, in having only one short spine on each side of the head, on the *preoperculum*.

BULLINGER, HENRY, the friend of Zwingli, and one of the chief reformers in Switzerland, was born at Bremgarten, in the canton of Aargau, July 18, 1504. He studied at Cologne, where he became acquainted with the writings of Luther; and during the year 1527, he attended the theological exhibitions of Zwingli, and went along with the latter to the religious conference held at Bern in 1528, the result of which was the reformation of the canton. In 1529, he married Anna Adlischwyler, formerly a nun, who here him eleven children. By a powerful sermon which he preached at Bremgarten, on Whitsunday 1529, B. induced his whole congregation to make a profession of Protestantism. In 1531, he was compelled by the Catholic party to flee from the canton, and went to Zurich, where, in the following year, he was appointed pastor of the principal church. In the controversy on the eucharist and the affairs of the Anabaptists, B. distinguished himself by his integrity and moderation; and in his house at Zurich several German theologians, compelled to leave their country, were hospitably sheltered. He took part in drawing up the first Helvetic Confession at Basel, in 1536, and in establishing a close relation between the Swiss and Anglican Churches. He died September 17, 1575.

His writings are numerous. The most important is a *History of the Reformation*, which was first published at Zurich, 1838. His sermons (translated) have also been recently published at Cambridge by the Parker Society.

BULLION usually means uncoined gold and silver, in bars or other masses; but in discussions on the currency, the term is frequently employed to signify the precious metals coined and uncoined. The origin of the word B. in its present sense, as well as that of the French *Billon* (q. v.), and the corresponding Spanish *vellon*, seems to be as follows: B. originally meant the mint, where the alloy for the coinage was prepared, and the coin stamped (either from the Lat. *bullā*, a round boss or stud, or stamp; or from the verb *bullare*, to boil or bubble); and hence it came in England to signify the standard metal of which the coins are made. In France, where the kings debased the currency much more than ever took place in England, *billon*, the mint, came to signify the base mixture issued therefrom.

It is a question not yet satisfactorily settled, how far any great increase in the supply of B. has that effect in lessening the value of money, and consequently raising prices, which has always been very naturally attributed to it. It may indeed be maintained with some plausibility, that if B. were capable of being produced to such an extent beyond the actual demand for it as to glut the market, it would cease to be that general standard of money value which it has become, just because it is of all others the article which is steadiest in requiring a certain outlay of labour to produce it. Rises in prices have accompanied large supplies of gold, but they have also accompanied large supplies of other commodities indicative of a great increase in riches. It is certain that great increases in the supply of B. do not, as in the case of other goods, glut the market. For some years past, the supply of gold, owing to the new fields opened in America and Australia, has been quadrupled, with certainly no more influence on prices than what a general increase in prosperity might cause. There is, it will be observed, this great difference between gold and other commodities, that besides what may be within the crust of the earth, there is a great mass which has been accumulating for thousands of years in the possession of mankind, which comes forth as it is wanted. A few millions of tons of iron, or hales of cotton, beyond the usual annual average, would perhaps add a hundred per cent. to the available quantity for consumption; but a few millions of pounds worth of gold, having to be counted with all the gold in existence in the world, makes a scarcely perceptible addition to the stock.

The term B. is in this country associated with the memorable BULLION REPORT of 1810. In the year 1797, by what was called the Restriction Act (see BANK), the Bank of England was restrained from paying its notes in gold. There thus came to be two separate and independent currencies in the country—one of B., the other of paper. They came to differ in value from each other so much that in the year 1813, gold, of which the mint price was £3, 17s. 10d. per ounce, was actually worth, in bank paper, £5, 10s., or, in other words, the one-pound bank-note was worth 14s. 2d. There were various opinions on the cause of this difference. Some people simply said, that gold was dear, taking paper as the standard of value; others said, it was owing to our exports not balancing our imports; others, to too great facilities in discounting, by which money was advanced on had security; and in general, it was held, that there could be no over-issue of paper-money, if it was backed by good security, and

employed only for genuine transactions, and not in fictitious credits. In the meantime, the select committee on the high price of gold B., had been wishing to get, not through theories or speculations but through actual facts, at the truth. The work of the committee was chiefly conducted by Mr Horner, aided by Sir Robert Peel, then a young man; and both of them entered on the task without any prepossession, and the desire to find the truth. They established the conclusion, among other important truths, that paper-money is always liable to be over-issued, and consequently depreciated, unless it be at all times immediately convertible into gold, and the monetary policy of the empire was subsequently established on this principle. A full analysis of the B. report will be found in Macleod's *Dictionary of Political Economy*.

BULL'S EYE, among the rigging of a ship, is a sort of small pulley in the form of a ring, with a rope spliced round the outer edge, and another sliding through a hole in the centre.—B. E., in rifle practice, is the small black centre within the circle on the target. See RIFLE PRACTICE.

BULL TROUT (*Salmo Eriax* or *S. griseus*), a fish nearly allied to the salmon, and like it, migratory in its habits, ascending rivers, in which it deposits its spawn, but living chiefly in the sea. It occurs in many of the rivers of Britain, but is 'probably better known in the Tweed than elsewhere,' being 'there as abundant as the salmon' (Yarrell). It is often called the GRAY TROUT,

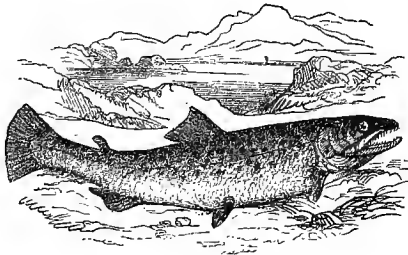

Bull Trout.

sometimes simply the GRAY, and is the SEWEN of the Welsh rivers. It sometimes attains the weight of 20 lbs., although it is more commonly under 15 lbs. weight. It is less elegant in form than the salmon; the head and nape of the neck are thicker in proportion; and the tail, beyond the adipose fin, is more bulky and muscular; the tail fin is square at the end in young fish (in some places called *whitlings*), and in older ones, becomes convex by the elongation of the central rays, whence the name *roundtail* sometimes given to this species. The scales are rather smaller than those of a salmon of equal size, and the colour is less bright; the males in the spawning season being reddish brown, the females blackish gray; at other times the general colour is like that of the salmon trout. The B. T. agrees with the salmon in having only a few teeth on the most anterior part of the *vomer* (the bone which runs down the centre of the palate); while the salmon trout, the common trout, and the great lake-trout, have a long line of teeth there: the teeth are larger and stronger than those of the salmon; there are differences also in the form of the gill-covers. To anglers, the B. T. is next to the salmon as a prize, and by many is mistaken for it. The flesh is paler in colour, coarser, with much less flavour, and is much less esteemed.—The name B. T. has been also given to the HUCHO (*Salmo*

Hucho), or salmon of the Danube, which sometimes attains the size of 30, or, it is said, even of 60 lbs.

BULOW, FRIED. WILH. VON, a famous Prussian general in the war of liberation, was born in 1755, entered the army young, and soon distinguished himself. When Prussia declared war with France in 1813, it was B. that commanded in the first successful encounter with the French at Möckern, April 5, and revived the self-confidence of the army after the adverse battle of Lützen. His victories over Oudinot and Ney at Grossbeeren and Dennewitz, saved Berlin, and inflicted severe loss on the enemy. He acted a conspicuous part in the battle of Leipsic, and by taking possession of Montmartre, finished the campaign of 1814. The king acknowledged his services by an estate worth £30,000, and the title of Count Dennewitz. In the campaign of 1815, he joined Blücher by forced marches, and headed the column that first came to the aid of Wellington at Waterloo. He died at Königsberg, 11th January 1818.

BULRUSH, an English popular name for large rush-like or reed-like plants growing in marshes, not very strictly limited to any particular kind. Some authors employ it in a restricted sense as the designation of plants of the genus *Typha*, also known as Cat's-tail or Reed-mace. See TYPHA. It is perhaps more commonly restricted to large species of the genus *Scirpus* (q. v.), also called Clnb-rush, and particularly to *S. lacustris*, a common British plant, found also in all the northern parts of the world, growing about the muddy margins of lakes and ponds, with a creeping root and round stems varying from 2 to 8 feet in height, which are almost leafless, and bear their flowers in compound umbels of small brown spikelets on their side. The root is astringent and diuretic, and was formerly employed in medicine; but the stems are the most useful part of the plant, being much employed for making chair-bottoms, mats, &c.; also by coopers for filling up spaces between the seams of casks, to which purpose their spongy nature particularly adapts them, and not infrequently for thatching cottages.

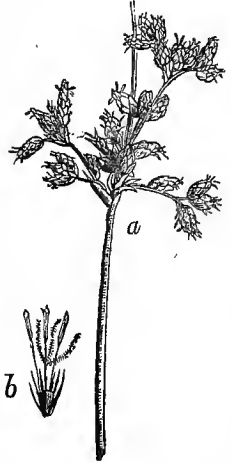

Bulrush (*Scirpus lacustris*):
a, top of stem and flowers;
b, a single floret.

BU'LTU, or **LITTLE TIBET**, a territory lying on the Upper Indus beyond the Himalaya, and forming a sort of debatable land between India and Tatar. It is immediately to the north of the Valley of Cashmere, with which it has been politically connected by conquest. It occupies about 8000 square miles, extending in N. lat. between 34° 30' and 36°, and in E. long. between 75° and 77°. With an average elevation of about 7000 feet above the sea, B. is surrounded by mountains of nearly the same height above its own level. Hence the temperature is such that only snow falls in what ought to be the rainy season, though in summer the thermometer ranges at noon from 70° to 90° F. European fruits are said to be plentiful. The inhabitants are of the Mongolian race, and chiefly

Mohammedans. Among the animals are the sha, the large-horned goat, the sheep, the musk-deer, and the ibis. The only town of consequence is the capital Iskardoh, which, in fact, sometimes gives its name to the whole province.

BULWARK, in military matters, was the old name for a rampart or bastion. In a ship, the bulwarks are the hoarding above the level of the upper deck, nailed to the outside of the timber-heads and stanchions. In ordinary vessels they form a parapet, protecting the seamen from the waves, and prevent loose articles from being swept off the deck; in men-of-war they, in addition, serve to protect the men from an enemy's shot. In an inquiry made a few years ago concerning the availability of merchant-steamers as ships of war, it was found that the bulwarks would not afford sufficient protection to the men from musket-shot; but that if hammock-stanchions were fixed all round the bulwarks, and the men's hammocks placed in a netting upheld thereby, a very good protection might be obtained.

BULWER LYTTON, SIR EDWARD. See LYTTON.

BULWER, SIR HENRY LYTTON, G.C.B., the RIGHT HON., diplomatist and author, an elder brother of Sir E. Bulwer Lytton, was born in 1804, entered the diplomatic service in 1827, and was attached successively to the British Embassy at Berlin, Brussels, and the Hague. In 1830, he entered parliament, and during the following seven years he represented, in order, the constituencies of Wilton, Coventry, and Marylebone. In 1837, he became Secretary of Embassy at Constantinople, where he negotiated and concluded a treaty which is the foundation of our present commercial system in the East. In 1843, he was made Minister Plenipotentiary to the court of Madrid, and concluded the peace between Spain and Morocco in the following year. Whilst in Spain, his firmness and candour proved a source of great inconvenience to Narvaez, the Spanish soldier-diplomatist of that day, and who, pretending to have discovered the complicity of the British plenipotentiary in certain plots against the Spanish government, ordered him to leave Madrid. Both parties in the House of Commons approved of the whole course of B.'s conduct while at the court of Madrid, and her Majesty awarded to him the highest decorations of the order of the Bath. He afterwards proceeded to Washington, where he evinced equal art in conciliating the temper of the people, and maintaining the interests of his own country. In 1852, he was sent to Tuscany as envoy extraordinary; and in 1856 was nominated by Lord Palmerston commissioner at Bucharest for investigating the state of the Danubian Principalities. As British commissioner, he called forth from every minister and from every government concerned the warmest expressions of approval, and all concurred in recommending him for the post of ambassador to the Ottoman Porte, on the return of Lord Stratford de Redcliffe, in the spring of 1858. He has published *An Autumn in Greece*; *France, Social and Literary*; *The Monarchy of the Middle Classes*; and a *Life of Byron*. Sir Henry Lytton B. married a sister of Earl Cowley, British ambassador at Paris.

BU'MBOAT, a boat employed to carry provisions and other articles from harbours and ports to vessels lying at some distance from the shore. Boats of this kind belong to a class of petty traders, who in England are, for the most part, women. The provisions commonly offered for sale are soft bread, butter, fruit, vegetables, fish, and fresh meat—the fish fried, and the meat roasted, if wanted. Among

the other articles are included shirts, drawers, stockings, gloves, pipes, needles, thread, and a variety of odds and ends. The less respectable of the B. traders try to smuggle spirits on board; but if this is discovered, it leads to instant punishment. In fitting out and also in paying off ships in H.M. navy, the B. people are allowed on board for a certain length of time daily; but when a ship is in active commission, they come alongside only at meal-hours. Among the class of B. people generally, there is no little acuteness and enterprise. They learn all particulars about ships going and coming, and will even write to far-distant ports to secure a vessel's patronage. In their dealings, they of course prefer ready money, but in certain cases they give credit, and it is understood lose little by their liberality; for any attempt at evasion of payment by any of the crew, meets the displeasure of commanding officers. From Hong-kong up to the Bogue Forts, and in other Chinese waters, bumboats frequently accompany vessels, and are apt to become troublesome. From Malta, and some other places in the Mediterranean, the bumboats also haunt vessels on short cruises, in the hope of doing a little trade.

BU'MKIN, or BOO'MKIN (diminutive of *boom*), on shipboard, is a short boom which projects over each bow of the ship, to aid in extending the lower edge or clue of the foresail to windward—in nautical phrase, 'to board the fore tack to.' In a boat, the B. is a small outrigger over the stern, used for extending the mizzen.

BUMMALOTI (*Saurus ophiodon*), a fish of the family *Scopelidae* or *Sauridae*, often regarded as a subdivision of the great family *Salmonidae*. It is a marine fish, a native of the coasts of India, particularly of the Bombay and Malabar coasts, from which it is exported in large quantities, salted and dried, to other parts of India, being highly esteemed for its rich flavour, and often used as a relish. In commerce, it is known not only by the name B., but by the singular appellation of *Bombay Duck*. It is a fish of elongated form, with large fins and a very large mouth, the gape of which extends far behind the eyes, and which is furnished with a great number of long, slender teeth, barbed at the points. It is extremely voracious.

BUNDELCUND, a territory of Hindustan, between Gwalior on the west, and the Jumna, which separates it from the Doab, on the north-east. It extends in N. lat. from 23° 52' to 26° 26', and in E. long. from 77° 53' to 81° 39', containing rather more than 18,000 square miles, and about 2,500,000 inhabitants. Studded, as B. is, with isolated rocks rising precipitously from its surface—each of them a nucleus, as it were, of independence—it has generally been very much subdivided. Besides five or six sections belonging to the North-west Provinces of British India, it embraces nine rajahships, and numerous principalities of inferior name, known as jaghires. The country, notwithstanding that it is well watered, has a climate which renders irrigation indispensable; and it is accordingly interspersed, at the cost of great labour and considerable ingenuity, with artificial dams. B., though not destitute of woodlands, presents rather jungle and copse than heavy timber. It is said to possess inexhaustible deposits of iron-ore, and to have given indications also of coal. The principal towns are Calpee, Jhansi, Callinger, Banda, Jalun, and Chaturpur. The first three will be noticed in their places, Callinger being famous for its cave-temples, and Jhansi and Calpee having acquired celebrity in the mutiny of 1857—1858.

BUNGALOW, a species of rural villa or house,

so called in India. Bungalows which form the residence of Europeans, are of all sizes and styles, according to the taste and wealth of the owner. Some are of two stories, but more usually they consist of only a ground-floor, and are invariably surrounded with a verandah, the roof of which affords a shelter from the sun. In the chief cities of Calcutta, Madras, and Bombay some of the bungalows are really palatial residences, while in the mofussil they are of more moderate pretensions. In general, they are provided with exterior offices, to accommodate the large retinue of domestics common in Indian life. Besides these private bungalows, there are military bungalows on a large scale for accommodating soldiers in cantonments; likewise public bungalows, maintained by government for the accommodation of travellers, and in which seem to be blended the characters of an English road-side inn and an eastern caravanserai. These bungalows, though they vary greatly in actual comfort, are all on the same plan. They are quadrangular in shape, one story high, with high-peaked roofs, thatched or tiled, projecting so as to form porticos and verandahs. The B. is divided into 'suits' of two, three, or four rooms, provided with beds, tables, and chairs; windows of glass, and framed glass-doors. Off each room is a bath-room, and earthen jars of cool water. Travellers are expected to carry their servants, cooking-apparatus, wine, beer, bedding, &c., with them; but the *khitmutgar* of the better class of bungalows supplies table-ware, condiments, and even sometimes food and liquors, and he is usually skilled in cooking. Government charges one rupee, or two shillings a day, to each traveller for the use of the bungalow. A book is kept, in which travellers enter their names, the time of their arrival and departure, with the amount paid, and any remarks regarding the state of the B. and its attendance he may think proper. Natives seldom stop in these public bungalows, for though legally open to all, they are almost exclusively resorted to by Europeans; and natives even of good condition are fain to seek 'the squalid desolation of a tottering caravanserai,' or village 'dhurumsala.' At every travellers' B. is stationed a government peon, who acts as watchman, and is bound to assist travellers' servants in procuring supplies of fuel and food in the nearest village. The distance between each B. on



Bungalow.

a trunk-road is generally about 12 or 15 miles—an Indian day's journey. The annexed cut represents a B. in the jungle. The introduction of railways will very soon put an end to the present system of travelling in India—a fact greatly to be desired, as the annoyance experienced moving slowly on with

baggage and servants, at the rate of a stage a day, is almost inconceivable.

BUNIAS, a genus of plants of the natural order *Cruciferae*, distinguished by *incumbent* linear spirally twisted cotyledons (q. v.), and a nut-like silicle (or round pod) with 2—4 cells. Only a few species are known, natives of the Levant. One of these, *B. Orientalis*, is cultivated in some countries—particularly in France—as a field-crop, for the sake of its leaves, which are used for feeding cattle. It was introduced into Britain more than 100 years since, and is quite hardy; but its cultivation has never become general, the amount of herbage which it yields being regarded as comparatively small. It is a perennial plant, with an upright branching stem, linear leaves, and yellow flowers, and is sometimes called **HILL MUSTARD**. It seems to succeed best in a rich, dry, and rather light soil.

BUNION is a painful condition met with in the joints of the feet, most commonly at the junction of the great toe with its metatarsal bone. It is caused by a gradual displacement of the bones, the toe itself turning outwards, and leaving the head or further extremity of the metatarsal bone projecting inwards. Over the latter, the skin is generally thin, and occasionally a bursa (q. v.) is present between the skin and bone. The pressure of a boot causes this bursa to inflame, and this may go on to suppuration or painful ulceration. Rest, poulticing, and such remedies are generally sufficient to subdue any inflammatory attack, and wearing a shoe so constructed as to save the B. from pressure, will probably prevent a recurrence of painful symptoms; but amputation and excision of the ends of the bones have been resorted to for the cure of the troublesome distortion.

BUNKER'S HILL. See **CHARLESTON**.

BUNKUM, a phrase used in the United States to signify an oratorical display in favour of a sham proposal, in order to catch popular applause. A member of the legislature, for example, desirous of standing well with his constituents, makes a flaming speech in favour of a measure in which they are interested; but with the knowledge that the measure is impracticable, and will not be carried. In fact, the speaker does not want to carry it; his sole object is to impose on his supporters, and acquire the character of a meritorious public leader. Such is speaking for bunkum. In some instances, the state legislatures enact laws brought forward on these dishonest grounds—the whole members, or at least a large majority of them, having no other object than bunkum. The consequence is, that many laws, agitated for by popular factions, remain a dead-letter, unless they happen to be enforced by clubs organised for the purpose.

BUNSEN, **CHRISTIAN KARL JOSIAS**, **BARON**, one of the most distinguished statesmen and scholars of Germany, was born, 25th August 1791, at Korbach, in the principality of Waldeck, and studied philology at Göttingen (1809—1813) under Heyne. He had been appointed teacher in the Gymnasium of Göttingen in 1811, but quitted the position in 1813; and in pursuance of a course of study of Old and Middle High German, begun in company with Lachmann, and to extend his knowledge of the Germanic tongues, went to Holland, and afterwards to Copenhagen, where he learned Icelandic from Finn Magnussen. The historical works of Niebuhr and his character as a politician had filled B. with enthusiasm, and he spent some months of 1815 in Berlin, in order to become personally acquainted with the historian. In 1816, he went to Paris, and studied Persian and Arabic under Sylvestre de Sacy, and in the same year to Rome, where he married.

Niebuhr, then Prussian ambassador, took the greatest interest in the scientific pursuits of B., and procured (1818) his appointment as secretary to the embassy. The residence of the king of Prussia, Friedrich Wilhelm III., in Rome in 1822, had a decided influence on his subsequent career. In the course of a conversation in which B. had disagreed with the king, the latter asked his views on the Prussian ritual (*Agende*) and hymn-book question, then much agitated. Though these views were very different from what the king had been accustomed to hear, he took them in good part, and with expression of his personal regard, requested B. to continue in the state service. On Niebuhr's departure from Rome (1824), B. conducted the embassy provisionally for a time, and was then appointed resident minister (1827). Living in intimate intercourse with Niebuhr, B. had employed the time in deepening his investigation into the philosophy of language and religion; and had made, on the one hand, the philosophy of Plato and the constitutions of antiquity; on the other, biblical inquiries, church history, and liturgies—objects of special attention. Though not within the scope of the great plan of his life, he contributed largely to the *Beschreibung der Stadt Rom* (Description of Rome), 3 vols. (Stutt. 1830—1843); the greater part of the topographical communications on ancient Rome, and all the investigations into the early history of Christian Rome, are by him.—The first visit of Champollion to Rome formed an epoch in B.'s antiquarian studies. He was a zealous hearer of Champollion himself, and also encouraged Lepsius (q. v.) to the study of hieroglyphics. The Archaeological Institute, established in 1829, found in B. its most active supporter. When he founded the Protestant hospital on the Tarpeian Rock (1835), he also built, adjoining his own house, a place of meeting for the Institute; and laboured earnestly for the cause of Protestantism. The king of Prussia had often asked his advice in the matter of the ritual, but had not adopted it. B. then, along with the chaplain, introduced (1825) into the chapel of the embassy at Rome a liturgy modelled after his own views, and sent a report (1828) to the king of the result. The king had this liturgy printed, and wrote the preface with his own hand. This work never came into the hands of the trade; but the most part of it was embodied in the *Allgemeine evang. Gesang- und Gebetbuch*, printed (1846) without the author's name, in the *Rauhe Haus*, Hamburg, which may be considered as the second edition of the *Versuch eines allgemeinen evang. Gesang- und Gebetbuchs* (Attempt at a General Evangelical Hymn and Prayer Book), Hamb. 1833.

In 1841, he was sent on a special mission to London, to negotiate the erection of an Anglo-Prussian bishopric in Jerusalem, and was shortly afterwards appointed ambassador at the English court. It is understood that, on occasion of a visit to Berlin in 1844, he was asked to write down his views on the question of granting a constitution to Prussia; and that in consequence he presented a series of memorials representing the urgency for a deliberative assembly, and also made a complete plan of a constitution closely resembling the English. In the Schleswig-Holstein question, B. strongly advocated the German view, in opposition to Denmark, and protested against the London Protocol of 1850. But in the midst of all his political duties, B. continued unabated his literary and philosophical pursuits, the results of which have from time to time appeared. His views regarding the part that Prussia should act in the Eastern question not being, it is understood, in accordance with those of his court, he ceased, in 1854, to represent Prussia at the

court of England, and retired to Heidelberg. In the estimation of Englishmen, B. must ever hold a high place. No foreigner has ever shewn a deeper appreciation of their national characteristics, or a heartier love of their social and political liberty. It must also be acknowledged that he has done service to the cause of enlightened Christianity, for, while in England, he was regarded by those who knew him both as the most philosophical and most reverent of lay-theologians. His chief works are: *De Jure Atheniensium Hæreditario* (Gött. 1813); *Die Kirche der Zukunft* (The Church of the Future—translated into English, and published by Longman), Hamb. 1845; *Ignatius von Antiochien und seine Zeit* (Ignatius of Antioch and his Time), Hamb. 1847; *Die drei echten und die vier unechten Briefe des Ignatius von Antiochien* (The Three Genuine and the Four Spurious Epistles of Ignatius of Antioch), Hamb. 1847; *Ägyptens Stelle in der Weltgeschichte* (Egypt's Place in the World's History—translated into English by Cottrell), Hamb. 1845—1857; *Die Basiliken des Christlichen Roms* (The Basilicas of Christian Rome), Mun. 1843; *Hippolytus und seine Zeit* (Hippolytus and his Time), Lond. 1851; *Christianity and Mankind*, Jena, 1854; *Gott in der Geschichte* (God in History), Leip. 1857; and the *Bibelwerk*, which B. hopes to make his chief work, of which only the Introduction is published.

BUNT, a disease of wheat and other grains, or the parasitic fungus which causes that disease. The name B. is supposed to be a corruption of *burnt*, or at least derived from the same root, a derivation perhaps suggested by the analogy of *Brand* (q. v.). B. is also called *Pepper Brand*, and sometimes *Smut Ball*. It is one of the most common and injurious diseases of wheat, often affecting great part of a crop, although its prevalence has been greatly diminished by care on the part of farmers, and particularly by the selection of clean seed, and the dressing of the seed, before sowing, with some substance, which, without injuring its vitality, destroys that of the spores or granules of the fungus. Even washing with water has a good effect, but greater benefit is derived from dressing with salt, quicklime, chloride of lime, Glauber's salt (sulphate of soda), and quicklime, or blue vitriol (sulphate of copper). Even arsenic and corrosive sublimate are used for this purpose.

The parasitic fungus which causes B., or which itself bears the name of B., is *Uredo caries* (see **URED**o), also known as *U. foetida* and *U. sitophila*, and which it has been recently proposed to constitute into a separate genus under the name *Tilletia*, on account of the want of filaments in the fully developed fungus, which consists of a mere mass of very small blackish grains or spores. This powdery mass is very soft and almost greasy to the touch, and when rubbed between the fingers, gives forth a very disagreeable smell, which has been compared to that of decayed fish. In their earlier stages, the spores are attached in great numbers by short stalks to common trunks or filaments, which are colourless, slender, and brittle, and disappear as the spores attain maturity. Sometimes all the grains

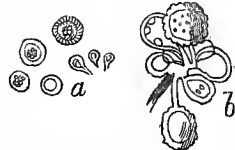

Bunt (magnified):
a, spores in various stages;
b, spores, and branching stalks.

in an ear are infected, sometimes part of them only. The infected plants are generally of more than usual luxuriance. The parasite appears before the ear is free from the sheath, and is supposed to

enter the plant from the infected seed on its first germination, and to be propagated not only by its own seeds or spores, but by still smaller granules from its *mycelium*. See FUNGI. The old notion that B. is owing to foggy weather, damp soil, or too shady situations, is in a great measure exploded, it being found to appear in all situations and circumstances; and it is now believed to be propagated by any contact of sound with unsound grain; by thrashing, which causes the B. dust to fly about; or by manure, in which the straw of infected grain has been mixed. Upon this knowledge, the means now adopted for its prevention are founded.

A considerable mixture of B. is not supposed to render flour absolutely unwholesome, at least when made into fermented bread, but the bread is of a peculiar flavour, and a very dark colour. It is said that such flour is used to no small extent in the manufacture of gingerbread, the treacle disguising both the colour and the flavour.

BUNTER SANDSTEIN, or 'variegated sandstone,' is the lowest member of the Triassic Period. As the trias is more perfectly developed in Germany than in Britain, the German beds are considered the typical group of this period. The B. S. consists of various coloured sandstones, interstratified with red marls and thin beds of limestone, which occasionally, as in the Harz, are oolitic, but in other places dolomitic. They attain a maximum thickness of 1500 feet. The English representatives of the B. S. are chiefly developed in Lancashire and Cheshire, and consist of red and mottled sandstones with beds of marl, and thick rather irregular bands of partially consolidated conglomerate called 'pebble beds.' Thirty species of fossil plants have been found in the B. S. near Strasburg, consisting chiefly of ferns, cycads, and conifers. But the most remarkable fossils in this formation are the remains of huge batrachians. Originally, the footprints which had been left by the animals on the moist sand were alone observed. From their resemblance to the impressions made by a human hand, the animal producing them was provisionally named *Cheirotherium* (q. v.). The subsequent discovery and examination of the remains of teeth and bones in the same beds, have afforded sufficient materials to enable Owen to reconstruct an animal named by him *Labyrinthodon* (q. v.), which undoubtedly produced the footprints. These remains have been detected in Lancashire and Cheshire, as well as in Germany.

BUNTYNE, or BUNTING, is a thin woollen material, of which the flags and signals of ships are usually made.

BUNTING (*Emberiza*), a genus of birds closely allied to finches and sparrows, and included with them by some ornithologists in the great family *Fringillidae* (q. v.), but by others made the type of a distinct family, *Emberizidae*, of which the most marked characteristics are a short, straight, conical bill; a curved form of the gape, produced by a narrowing of the sides of the upper mandible, and a corresponding enlargement of the under one, and a hard rounded knob on the palate or inner surface of the upper mandible. This knob probably aids in crushing the seeds, which are a principal part of the food of these birds. The species of the B. family are numerous, and are arranged in several genera. The true buntings (forming the restricted genus *Emberiza*) have the hind claw moderately short, curved, and strong, and the palatal knob large and bony. The COMMON B. or CORN B. (*E. miliaria*)—a bird considerably larger than a house-sparrow, brown, with darker streaks on the upper parts, whitish brown, with spots and lines of dark

brown on the under parts, and with a slightly forked tail—is frequent, particularly in low cultivated

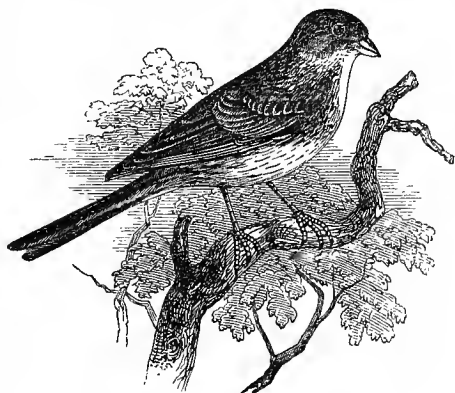

Common Bunting (*Emberiza miliaria*).

grounds in Britain, and in most parts of Europe, extending also into Asia, living in pairs during spring and summer, but in flocks in winter, and often visiting barn-yards at that season, along with chaffinches and sparrows. It is the largest of the British buntings. It is supposed that the winter flocks in Britain are much increased by migration from more northerly regions. This B. often passes the night on the ground in stubble-fields, and is taken in the nets employed for catching larks, and brought with them to market. It usually builds its nest on or very near the ground. Its notes are harsh and unmusical.—The REED B., or BLACK-HEADED B. (*E. Shoeniclus*), is a species common in marshy situations, both in Britain and on the continent of Europe; a very pretty little bird, with black head and throat, strikingly contrasted with the white nape and sides of the neck.—The CIRC B. (*E. Cirrus*), of which the head is olive-green, with black streaks, and with patches of bright lemon-yellow on the cheeks and over the eyes, is a rare British bird, and belongs chiefly to the south of Europe and the north of Africa. To this genus belong also the ORTOLAN (q. v.) and the YELLOW-HAMMER (q. v.).—The SNOW B. (q. v.), or SNOWFLAKE (*E. nivalis* of many authors), has been placed in the new genus *Plectrophanes*. The name B. has been often very vaguely used, and many species have been almost indiscriminately called buntings or finches. The palatal knob affords the best distinctive character. North America has a number of species of bunting.—The BLACK-THROATED B. (*E. Americana*) is extremely plentiful on the prairies of Texas and other south-western parts of the United States; extending, however, as far as to Ohio, and even to Massachusetts. In the middle and northern states, it occurs only as a summer bird of passage. In its habits, it closely resembles the Common B. of Europe; but the palatal knob is less hard.

BUNTING, JABEZ, an eminent Wesleyan minister, was born at Manchester in 1779. At the age of 20, he devoted himself to ministerial work, in which he was very successful. He was elected president of the annual conference in 1820, and again in 1828, 1836, 1844. In 1834, he was chosen president of the theological institution belonging to the Wesleyan Methodist body, and he acted as one of the secretaries to the Missionary Society in connection with his denomination, for a period of more than twenty years. He was the chief authority in all matters relating to the government

and polity of Wesleyan Methodism. On his retirement from official life in 1857, his friends presented him with an annuity of £200, in consideration of the great services he had rendered to Methodism. He did not live, however, to profit by their kindness and forethought, having died in June 1858.

BUNYAN, JOHN, one of the most popular religious writers of any age, was born at Elstow, near Bedford, in 1628. He was brought up to his father's trade of tinker, and spent his youth in the practice of that humble craft, of which his name alone now serves to lessen somewhat the disrepute. It has generally been taken for granted that his early life was very loose and profligate, on the sole ground of his terrible self-accusations in after-years, when, from the height of religious fervour and Puritan strictness, he looked back on dancing and bell-ringing as deadly sins. This point is satisfactorily disposed of by Macaulay (*Encycl. Britann.*, art. 'Bunyan'). In his 16th or 17th year, he enlisted in the Parliamentary army, and in 1645, was present at the siege of Leicester, where he escaped death by the substitution of a comrade in his place as sentry. Nothing further is known of his military career. After leaving the army, he married, and soon after began to be visited by those terrible compunctions of conscience, and fits of doubt, sometimes passing into despair, which, with some quieter intervals, made his life, for several years, a journey through that Valley of Humiliation of which he afterwards gave so vivid a picture. Hope and peace came at last, and in 1655, B. became a member of the Baptist congregation at Bedford. Soon after, he was chosen its pastor, and for five years ministered with extraordinary diligence and success, his preaching generally attracting great crowds. The act against conventicles, passed on the Restoration, put a stop to his labours; he was convicted, and sentenced to perpetual banishment. In the meantime, he was committed to Bedford Jail, where he spent the next 12 years of his life, supporting the wants of his wife and children by making tagged laces, and ministering to all posterity by writing the *Pilgrim's Progress*. His library consisted of a Bible and Fox's *Martyrs*. The kindly interposition of a High Church bishop, Dr Barlow of Lincoln, at length released him, and he at once resumed his work as a preacher, itinerating throughout the country. After the issuing of James II.'s declaration for liberty of conscience, he again settled at Bedford, and ministered to the Baptist congregation in Mill-lane till his death, at London, of fever, in 1688. B.'s whole works were published in 1736, in 2 vols. folio. The most popular of them, after the *Pilgrim's Progress*, are the *Holy War*—another allegory, much less successful—and *Grace Abounding to the Chief of Sinners*, an autobiographical narrative. It is supposed that no other book, except the Bible, has gone through so many editions, and attained to so wide a popularity, in all languages, as the *Pilgrim's Progress*.

BU'NZLAU, a town of Prussia, in the province of Silesia, is situated on the Bober, about 25 miles west-north-west of Liegnitz. B. is surrounded by a ditch and a double line of walls, and has manufactures of woollens, linens, hosiery, and earthenware, the latter forming a considerable article of export. An obelisk to the Russian general, Kutusow, who died here in 1813, adorns the market-place. Pop. about 7000.

BU'NZLAU, JUNG, a town of Bohemia, on the left bank of the Iser, about 32 miles north-east of Prague. B. is well built, has an old castle, and manufactures of cotton, woollen, soap, leather, &c.

It is said to owe its origin to King Boleslaf, who founded it in the 10th century. Pop. 5200.

BUOL-SCHAUENSTEIN, KARL FERD., COUNT, Austrian statesman, was born 17th May 1797. After filling subordinate diplomatic posts, he became ambassador at Carlsruhe in 1828, afterwards at Stuttgart (1838) and at Turin (1844). Leaving Turin on the outbreak of the war in 1848, he went as ambassador to St Petersburg, and it fell to him to uphold the interest and dignity of his country, on occasion of the aid given by Russia in the Hungarian war. A not less difficult task was assigned him when, in 1851, he was sent to represent Austria in London; his address and conciliatory bearing contributed not a little to bring about a more friendly feeling between the two governments. On Schwarzenberg's death, B. was recalled to Vienna, and became foreign minister. In this position, he carried out the new politics of Austria no less firmly and successfully, though more moderately and quietly, than his predecessor. In the negotiations during and after the termination of the Crimean war, B. shewed himself a skilful and able statesman. After defending with zeal and ingenuity, in diplomatic notes and circulars, the position which Austria had taken up with reference to Sardinia, B. suddenly, on the actual commencement of the Italian campaign of 1859, resigned his place, which was immediately filled by Count Rechberg. Failing health was the cause officially assigned for the step, but the general belief was, that it indicated a triumph of the war-party in the council of Francis Joseph.

BUOY is a floating body, intended as a mark for the guidance of mariners. It is made either of wood or metal, and is mostly hollow, to make it float better. Buoys are generally moored by chains to the bed of the river or channel. They are of various shapes and sizes, and are painted of various colours, partly to render them conspicuous, and partly to distinguish them one from another. Sometimes floating buoys mark out the best channel for entering a dock; sometimes they warn the mariner away from sands, spits, and shoals; sometimes they mark out a continuous double line, as at Spithead,

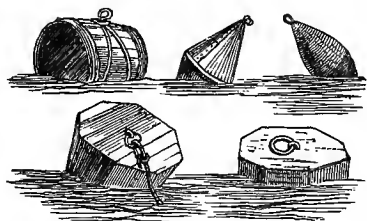

Various shapes of Buoys.

between which ships can alone with safety enter a harbour. The Trinity House has lately adopted a form of B., invented by Mr Herbert, in which, by due attention to the centre of flotation, and to the point where the mooring-chain is fixed, the tendency to pitch and roll is much lessened, and the B. kept nearly upright in all weathers. Messrs Brown and Lenox's *bell-buoy*, of recent invention, is an ingenious contrivance for rendering a B. audible, whether it is visible or not; so long as any stream of water, whether caused by a tide or a current, passes through the lower part of the B., it moves an undershot water-wheel, which rings a bell.

A *buoy-rope*, on shipboard, is the rope which connects the anchor with a B. floating above it. It is simply intended to point out the locality of

the anchor; but if it be strong, it is useful in assisting to raise the anchor, at times when the proper cable is cut or injured.

BUOYANCY, of ships, is the amount of weight which can be buoyed up by the hull. The B. of a vessel is proportionate to the weight of water displaced by its presence (see **HYDROSTATICS**), and is found in this way. The cubic feet of the part of a vessel to be immersed being known, multiply it by the weight of a cubic foot of water (62·5 lbs.), and the product will be the weight of water displaced. From this subtract the weight of the vessel, and the result will be the B. or the weight a vessel will carry without sinking lower than the given line. It is admitted, however, by naval architects, that all the old rules concerning B., displacement, and flotation, must undergo modification by the introduction of iron ships, paddle and screw propulsion, and the increased weight of broadside.

BUOY-DUES. Buoys are under very stringent regulations, on account of their importance to the safety of ships. The public buoys, for guiding into channels, and warning from shoals and rocks, are usually marked on the best charts relating to that particular water-way. The corporation of the Trinity House has a peculiar jurisdiction over the buoys and beacons in the Thames, and along the Essex and Suffolk coasts; as well as on other coasts in England and Wales. All ships which enter the ports within this jurisdiction pay a small sum as buoy-dues. The payment is sometimes a tonnage rate, varying from 0½d. to 2d. per ton; sometimes a rate per vessel, varying from 4d. to 3s.; sometimes a payment on entering only, at others on departure as well as on entering; while some kinds of coasting-vessels pay 5s. per annum, whatever may be the number of voyages. From the Thames buoys alone, the Trinity House receives £14,000 per annum as dues.

BU'PHAGA. See **BEEFEATER**.

BUPRE'STIS, a Linnæan genus of Coleopterous (q. v.) insects, now divided into a number of genera, and forming a tribe or family, *Buprestidæ*, of which some hundreds of species are known, most of them belonging to tropical countries, and remarkable for the splendour of their colours. The colours are generally metallic in their lustre, have frequently a burnished appearance, and are often beautifully iridescent. One of the largest species, *B. gigas*, is a native of Cayenne: it is about 2 inches long. The

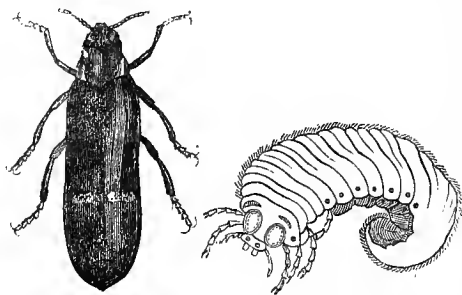

Buprestis bicolor.

Larva of *Buprestis gigas*.

English and other European species are all comparatively small. Most of the species spend the night on trees, shrubs, and other plants, flying about during the hottest part of the day. Some of them are popularly known as **GOLDEN BEETLES**. Plants are sometimes seen studded with them in the

morning, as with gorgeous flowers. The golden *elytra* (wing-cases, see **ELYTRA**) of some species are used to enrich the embroidery of the Indian zenana; and the lustrous joints of the legs are strung on silken threads, and form necklaces and bracelets of singular brilliancy. The species of *Buprestidæ* found in England are few; none have yet been found in Scotland. The larvæ seem sometimes to be transported from one country to another in timber.

BUR, in an engraving, is a slight ridge of metal raised on the edges of a line by the *graver* or the *dry point*. As the bur produces an effect like a smear, it is usually regarded as a defect, and scraped off. Some etchers, however, take advantage of it to deepen their shadows, and Rembrandt made use of it in this way with telling effect.

BURANHEM, or **BURUNHEM**. See **MONESIA BARK**.

BURANO, an island and town of Northern Italy, in the Adriatic, about 5 miles north-east of Venice. The island supplies a large proportion of the vegetables consumed in Venice. B. has some lace-manufactures, boat-building, and an extensive ropework, but the inhabitants are chiefly employed in fishing. Pop. 8000.

BURBOT (*Lota vulgaris*), a fish of the same genus with the Ling (q. v.), and of the same family with the Cod, Haddock, &c., being the only British fresh-water species of that family, *Gadida*. It is found in the Cam, the Trent, and other rivers of the eastern and midland counties of England, but is one of the most local of British fresh-water fishes. It is found also in various parts of the north of Europe, and at least as far south as Switzerland; in Siberia and other parts of Asia, even, it is said, in India. In English rivers, it often reaches 2 or 3 lbs. in weight, but has been taken of 8 lbs. weight; and in some parts of Europe, it is said to reach 10 or 12 lbs. weight. In appearance, the B. very

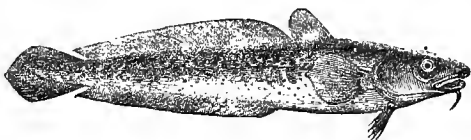

Burbot.

much resembles the ling, but is rather thicker at the neck, and tapers rather more rapidly, although still of a somewhat elongated form. It has two dorsal fins, the first short, the second very long, and a very long anal fin. It differs from the ling in the form of the tail-fin, which is oval and slightly pointed; but agrees with it in having a single barbule on the lower jaw. It is of a yellowish-brown colour, clouded and spotted with darker brown on the upper parts, the under parts lighter; the scales are small; and the whole body is covered with a mucous secretion. The flesh is white, firm, and of good flavour; 'and as the B. is in its nature extremely hardy, few difficulties present themselves in the way of their increase in quantity, while the value of the fish would amply repay the trouble or the cost of the experiment.'—*Yarrell*. The B. is capable of living for a long time out of water. It is commonly taken by trimmers and night-lines, as it feeds principally during the night. Its food consists of small fishes, worms, mollusca, &c. Its liver yields an oil similar to cod-liver oil.

BURCKHARDT, JOHN LEWIS, an enterprising African traveller, was born at Lausanne, in

Switzerland, November 24, 1784. In 1806, he came to London, and was introduced by Sir Joseph Banks to the African Association, which accepted his services to explore the route of Hornemann into the interior of Africa, and he embarked for Malta, February 14, 1809. He had previously qualified himself for the undertaking by a study of Arabic, and also by inuring himself to hunger, thirst, and exposure. From Malta he proceeded, under the disguise of an oriental dress and name, to Aleppo, where he studied about two years, at the end of which time he had become so proficient in the vulgar Arabic, that he could safely travel in the disguise of an oriental merchant. He visited Palmyra, Damascus, Lebanon, and other remarkable places, and then went to Cairo, his object being to proceed from thence to Fezzan, and then across the Sahara to Sudan. No opportunity offering itself at the time for that journey, he went into Nubia. No European traveller had before passed the Derr. In 1814, he travelled through the Nubian desert to the shore of the Red Sea and to Jeddah, whence he proceeded to Mecca, to study Islamism at its source. After staying four months in Mecca, he departed on a pilgrimage to Mount Arafat. So completely had he acquired the language and ideas of his fellow-pilgrims, that, when some doubt arose respecting his Mohammedan orthodoxy, he was thoroughly examined in the Koran, and was not only accepted as a true believer, but also highly commended as a great Moslem scholar. In 1815, he returned to Cairo, and in the following year ascended Mount Sinai. The Fezzan caravan, for which he had waited so long, was at last about to depart, and B. had made all his preparations for accompanying it, when he was seized with dysentery at Cairo, which terminated his life in a few days, October 15, 1817, at the early age of 33. As a holy *sheik*, he was interred with all funeral honours by the Turks in the Moslem burial-ground. His collection of oriental MSS., in 350 volumes, was left to the university of Cambridge. His journals of travel, remarkable alike for their interest and evident truthfulness, were published by the African Association. B. was a man born to be a traveller and discoverer; his inherent love of adventure was accompanied by an observant power of the highest order. His personal character recommended him to all with whom he came in contact, and his loss was greatly deplored, not only in England, but in Europe. His works are—*Travels in Nubia*, 1819; *Travels in Syria and the Holy Land*, 1822; *Travels in Arabia*, 1829; *Notes on the Bedouins and Wahabis*, 1830; and *Manners and Customs of the Modern Egyptians*, 1830.

BURDEN, a term of law in Scotland, used to signify any restriction, limitation, or encumbrance affecting either person or property. Burdens are said to be either personal or real. Where a party is taken bound by acceptance of a right to pay a certain sum to another, but where there is no clause charging the subject conveyed with the sum, the burden is said to be *personal*; that is, it will be binding upon the receiver and his representatives, but will constitute no real encumbrance on the lands, or other subject conveyed, nor amount, indeed, to anything more than a mere personal obligation on the grantor. But where the right is expressly granted under the burden of a specific sum, which is declared a burden or charge on the lands themselves, or where the right is declared null if the sum be not paid, the burden is said to be *real*.

By the 10 and 11 Vict. c. 48, real burdens need not be inserted in full in conveyances, if they have already been set forth in an instrument of title, in

which case, they may be referred to in the terms, or as nearly as may be in the terms, set forth in schedule C annexed to the act. A similar provision is made in regard to lands held in burgage tenure, by the 10 and 11 Vict. c. 49.

BURDEN, or **BURTHEN**, of a ship. See **TONNAGE**.

BURDEN OF PROOF, in legal procedure, signifies the obligation to establish by evidence certain disputed facts; and, as a general rule, this burden lies on the party asserting the affirmative of the issue to be tried or question in dispute, according to the maxim *ei incumbit probatio qui dicit non qui negat*—that is, proof is incumbent on him who asserts, not on him who denies. The principle of the law is, that the B. of P. is on the party who would fail if no evidence were adduced on either side. Accordingly, it almost always rests on the plaintiff in an action, or on the party asserting the facts on which the result of the litigation must depend. In one case tried before the late Baron Alderson, that learned judge laid down that the proper test was, *which party would be successful, if no evidence at all were given?* the B. of P., of course, falling on the party not in that position. This test has since been generally adopted and applied; but Mr Best, in his learned work on the *Principles of Evidence*, improves on it by the suggestion, that in strict accuracy the test ought to be, 'which party would be successful, if no evidence at all, or *no more evidence*, as the case may be, were given?' a consideration on which the discretion and judgment of counsel frequently depend. But although such, in general, is the position of the plaintiff, it sometimes happens that the B. of P. is imposed on the defendant, in consequence of his having the affirmative of the material issue to be tried.

It is this rule as to the B. of P. that demonstrates the real nature of the plea of *not guilty* in a criminal prosecution, and which divests that plea of the objections to it which are frequently heard expressed by over-scrupulous sentimentalists; for the meaning of that plea is not necessarily an assertion by the prisoner that he is absolutely guiltless or innocent, but that he wishes to be tried, and that as the B. of P. is on the prosecutor, while he has meanwhile the presumption of innocence in his favour.—Besides the work referred to, see on the subject of this article Starkie on the *Law of Evidence in England*, and Dickson on the same subject in Scotland.

BURDENS, PUBLIC. See **PUBLIC BURDENS**.

BURDER, REV. GEORGE, an active and influential minister of the Congregational body, was born in London, June 1752. After studying some time as an artist, he devoted himself to the ministry, and in 1778 was appointed pastor of an Independent Church at Lancaster. He afterwards removed to Coventry, and in 1803 to London. Here he became secretary to the London Missionary Society, and editor of the *Evangelical Magazine*, the duties of which offices he discharged with great zeal, until failing health compelled him to resign. B. took a prominent part in all the religious movements of his time. He died May 1832. His *Village Sermons* have been translated into several European languages; and he was the author of other series of sermons and publications which have had an immense circulation.

BURDETT, SIR FRANCIS, Bart., the most popular English politician of his time, born January 25, 1770. Educated at Westminster School and Oxford University, he spent some years on the continent, and was a witness to the progress of the first French Revolution. In 1793 he married Sophia, youngest daughter of Thomas Coutts,

Esq., the wealthy London banker, and in 1796 was elected M.P. for Boroughbridge, Yorkshire. In 1797, on the death of his grandfather, he succeeded to the baronetcy. In the House of Commons, he made himself conspicuous by his opposition to government and the war, and his advocacy of parliamentary reform, Catholic emancipation, and other liberal measures, most of which were afterwards carried. One of the most effective political speakers of that excited period, he for many years prominently occupied public attention, and was the idol of the London populace. Having succeeded in obtaining a parliamentary inquiry into the abuses of the metropolitan prisons, he became, in 1802, a candidate for Middlesex. He was first returned, then unseated, and after a second contest, defeated. At the general election of 1806, B. again became a candidate for Middlesex, but was defeated. In May 1807, he fought a duel with Mr James Paull, one of the candidates for Westminster the previous year. Soon after, he was returned, with Lord Cochrane, for Westminster, which he represented for nearly thirty years. B. having in 1810 published, in Cobbett's *Political Register*, a Letter to his Constituents, declaring the conduct of the House of Commons illegal in imprisoning John Gale Jones, the Speaker's warrant was issued for his apprehension, as being guilty of a breach of privilege. Refusing to surrender, he for two days barricaded his house; the populace supported him in his resistance, and in a street contest between them and the military some lives were lost; but on April 9, the serjeant-at-arms, aided by the police and military, obtained an entrance, and conveyed him to the Tower. The prerogation of parliament restored him to liberty. Prosecuted in 1819 for a libel contained in a Letter to his Constituents, strongly animadverting on the proceedings of the magistrates and yeomanry at the memorable Manchester meeting, he was sentenced to three months' imprisonment in the King's Bench, and to pay a fine of £1000. Some time after the appointment of the Melbourne ministry in 1835, he deserted the Liberal party, and joined the Conservatives. In July 1837, he was returned for Wiltshire. His death took place January 23, 1844.

BURDOCK (*Arctium*), a genus of plants of the great natural order *Compositæ* (q. v.), tribe *Cynarcephalæ*. The heads of flowers are globose, or nearly so; and each of the scales of the involucre runs out into a long rigid prickle, which is hooked at the point. By means of these hooks, the flower-head, popularly called a *bur*, readily lays hold of the clothes of a passer-by, the wool of a sheep, or the like, and thus the seeds are transported from one place to another, the short hairy pappus being insufficient to waft them far on the wind. The common B. (*A. Lappa*), of which varieties very slightly distinguished have sometimes been described as species (*A. Bardana*, &c.), is abundant in waste and bushy places, by waysides, &c., in Britain and throughout Europe, scarcely, however, growing except in rich land. Its root is biennial, large, and fleshy, somewhat carrot-shaped; the root-leaves large, stalked, heart-shaped; the stem stiff, upright, somewhat branched and leafy, three feet or more high. The whole aspect of the plant is coarse, and it is somewhat clammy to the touch. The root is sometimes used in medicine, being diaphoretic and diuretic, and acting upon the cutaneous system and the kidneys. It is capable of being made a substitute for sarsaparilla. When fresh, it has a disagreeable smell, but when dry, it is inodorous; it has a sweetish mucilaginous taste, becoming afterwards bitterish and rather acrid, and contains chiefly

inulin, bitter extractive, mucilage sugar, and a little tannin. In many countries, the roots, young shoots, and young leaves of B. are used in soups; and the



Burdock.

plant is cultivated for this use in Japan. The roots are said to resemble artichokes in taste. The leaves and their expressed juice are sometimes applied to burns and suppurations.

BURDWAN, a city in the sub-presidency of Bengal, on the Grand Trunk Road from the Hoogly to the North-west Provinces, in lat. 23° 12' N., and long. 87° 56' E., being 74 miles from Calcutta, with which it is connected by railway, and 346 from Benares. In point of architecture, it is a miserable place—an aggregate, as it were, of second-rate suburbs. Pop. 54,000.

BURDWAN, the territory of the last-mentioned city, lying between Beerbhoom on the north, and Hoogly on the south. It stretches in N. lat. from 22° 52' to 23° 40', and in E. long. from 87° 21' to 88° 23'. With a length of 70 miles, and a breadth of 60, it is said to contain only 2224 square miles, with 1,854,152 inhabitants, or about 840 to the square mile—a proportion which certainly seems to justify a name that signifies *productive*. The district is largely engaged in the refining of sugar. It exports also iron and coal; chiefly, however, brought from the mines of Bancoorah, the district on the west. Next to the capital, Cutwa and Culna are the chief towns.

BUREAU, a French word signifying a writing-table or desk; also an office for transacting business, a department of government, or the officials that carry it on. **BUREAUCRACY** is popularly applied to signify the kind of government, exemplified in many continental states, where a host of government officials, regularly organised and subordinated, and responsible only to their chiefs, interfere with and control every detail of public and private life—the evil which the Germans call 'much-government' (*vielregieren*).

BUREN, MARTIN VAN, a president of the United States of America (1837—1841), was born at Kinderhook, in Columbia, New York, December 5, 1782. Educated for the bar, he was elected, in 1812, senator in the legislative assembly of New York, and in 1821 took his seat in Congress, where he supported democratic measures. In 1829 he was made Secretary of State, and in 1837 he succeeded General Jackson in the presidency, being elected by a majority of twenty-four votes over his rivals, Clay, Webster, and Harrison. On beginning the duties of his office, he found himself involved in such financial perplexities, that he immediately

summoned Congress to an extraordinary session, and proposed an entire separation of state-finance from the banks of the Union, a proposition which was decisively rejected, and B.'s popularity was greatly damaged. In 1840, he had to yield his place to General Harrison, the Whig candidate; and in 1844, when he again stood for the presidency, he was defeated by Polk. The result of this vote divided the Democrats into two parties, one of which, at a convention at Utica, unanimously declared for Van B. as president for 1848; but his election was prevented by the military renown of General Taylor, who left both Van B. and Cass with minorities. In 1856, he was again named for the presidency; but the majority of the Democratic party preferred Mr Buchanan.

BURG, a town of Prussia, in the province of Saxony, situated on the Ihle, about 13 miles north-east of Magdeburg. It is walled, and has long been famous for its extensive woollen manufactures. It has also manufactures of linen, yarn, steel, pottery, and leather; dye-works, distilleries, foundries, &c., and a large trade in agricultural produce. Pop. 14,570.

BURGA GE TENURE is a species of holding in the law of real property which prevailed both in England and Scotland, although somewhat differently regarded in these two countries. In England, it is a species of free *socage* (q. v.) holding, and it prevails where the king or other person is lord of an ancient borough in which the tenements are held by a certain and determinate rent, and subject to a variety of customs, the principal and most remarkable of which is that called *Borough English* (q. v.). Among the other customs was a law that the wife shall be endowed with all her husband's tenements, and not with the third part only, as at common law.

In Scotland, by this tenure is meant a peculiar sort of military holding affecting property in royal burghs, the sovereign being superior or over-lord, and each individual proprietor or burghess holding direct of the crown, for the *reddendo* or service of *watching and warding* (q. v.). This service is otherwise termed 'service of burgh used and wont,' and is now merely nominal. Although the burghesses hold immediately of the crown, they do not receive their formal entry directly from the sovereign, but from the magistrates of the burgh, as the crown's commissioners. If the burgh, as such, ceases to exist, the crown does not thereby lose its rights over the proprietors, for they continue as crown vassals (q. v.). By the 10 and 11 Vict. c. 49, facilities are given for the transference of land in Scotland held under this tenure. See **TENURE**.

BURGA'S, or **BURGHAZ**, a town of European Turkey, in the province of Rumelia, on a promontory in the Black Sea, about 76 miles north-east of Adrianople. B., which is well built and clean, has manufactures of pottery of a superior kind, and a good trade in agricultural produce. Pop. about 6000. The Gulf of Burgas, at the head of which the town is situated, is about 14 miles in length, and has a depth varying from 5 to 12 fathoms.

BUR GEO ISLANDS, belonging to England, and lying between Newfoundland and Cape Breton, in lat. 47° 33' N., and long. 57° 44' W. Besides being valuable as a fishing-station, they occupy a commanding position with respect to British North America in general, and the Gulf of St Lawrence in particular. The group has 700 inhabitants.

BÜRGER, **GOTTFRIED AUGUST**, one of the most popular German poets, was born, January 1, 1748, at Molmerswende, near Halberstadt, in Prussian Saxony. In his boyhood, he displayed no capacity

for hard study, and was particularly averse to Latin; but he at the same time shewed a relish for verse, though destitute of any other model than the Psalm-book. In 1764, he went to Halle, and applied himself to theology. In 1768, he abandoned this science for jurisprudence, which he studied at Göttingen. Here his conduct was careless and immoral, and he would probably have sunk into obscurity, if the intimacy which he happily formed with Voss, the two Stolbergs, and other young poets, had not stirred up his better nature, and inspired him with an earnest ambition to excel. He laboured hard at the classics of ancient and modern times, but the study of Shakspeare and Percy's *Reliques* had the greatest influence in deciding the style of poetry which he was to adopt. With regard to the intrinsic merits of his poems, which consist chiefly of ballads and songs, even German critics—such as Schiller, Ger-vinius, and Villmar—differ widely in their opinions; but all agree in praising the popular style and fluent, spirited versification of his ballads, *Leonora*, *Leonardo and Blandine*, the *Parson's Daughter of Taubenhausen*, the *Wild Huntsman*, &c. B.'s life was spent in great poverty and misery, partly the result of misfortune, and partly induced by his own errors. He married thrice, in two instances very unhappily; lost his property by an unfortunate speculation; and, though the favourite poet of the German people, was left to earn his bread by translations and similar literary labours. He died June 8, 1794. Though a popular writer, B. was very careful as to style, and was one of the first who wrote good hexameter verse in German. His collected works were first published by Karl von Rheinhard, 1796—1798; latest edition, 1844.

BÜRGERMEISTER, the German title of the chief magistrate of a city or town, analogous to the French *maire*, the English *mayor*, and the Scotch *provost*.

BURGESS, or **BURGHER**, from the same origin as burgh, means, when taken in a general sense, much the same thing as the word citizen, but has a variety of special meanings, according to local institutions. In French literature, the word *bourgeois* is generally used to personify the excess of plebeian vulgarity; while, on the other hand, in England, the aristocratic member of parliament for a city is technically called a burghess. In almost all parts of Europe, when used in a technical sense, the word means a person who holds some peculiar privilege in a town or municipal corporation. The burghesses of the European towns, indeed, were, and still nominally are, an interesting relic of ancient Roman institutions, existing in contest and rivalry with the institutions of feudality. The B., with a different name, is virtually the civis or citizen of the Roman municipality. It was a rank always of some moment, but especially valuable when the citizenship was of Rome, the metropolis. St Paul, when he was to be scourged, raised the alarm of the chief captain by stating that he was a Roman. Such an event might often have happened in the middle ages, when a B., brought before the court of a feudal lord, claimed the privilege of pleading in his own burghal court, or the king's tribunal. The European monarchs found it their interest to support the burghesses, as a check on the influence of the feudal aristocracy; and thus was nourished the great system of city communities, which have exercised so important an influence on the fate of the world. See **MUNICIPAL INSTITUTIONS**.

In the law of England, a B. is a member of the corporation of a corporate town, or he may be

BURGESS LIST—BURGH.

described as a freeman duly admitted as a member of the corporate body. This privilege was, and, to some extent, still is, acquired by birth or servitude—that is, by being born of a freeman, or by apprenticeship for seven years within the borough to a freeman. It might also be obtained by gift or purchase; and the Municipal Corporation Act, the 5 and 6 Will. IV. c. 76—with the exception of abolishing the last-mentioned mode of admission by gift or purchase—expressly reserves the rights of such freemen and their families; and it also provides for the making up and preservation of a list of burgesses so admitted, to be called the *Freeman's Roll* (q. v.); but that act, for the purposes of its own enactments, defines a B. to be a male person, who, on the last day of August in any year, shall have occupied any house, warehouse, counting-house, or shop within the borough, during that year and the whole of the two preceding years; and during such occupation shall also have been an inhabitant householder within the borough, or within seven miles thereof; and shall during such time have paid all poor-rates and all borough-rates in respect of the same premises, except those payable for the last six calendar months; and shall be duly enrolled in that year as a B. on the *B. Roll* (q. v.). Such burgess, however, must be of full age, not an alien, nor one who has received within the last twelve months parochial relief or other charity. This definition, however, is subject to the following rule, that where the premises come by descent, marriage, marriage-settlement, devise, or promotion to any benefice or office, the B. shall be entitled to reckon in the occupancy and rating of the former party from whom they were so derived.

In the Scotch law, the old definition of B. is still maintained. This is very similar to the old English one above mentioned, with the addition of admission to the privilege by *election of the magistrates of the burgh*—the burgesses taking, on the occasion of their admission, a quaint form of oath, in which they confess the religion of the country, loyalty to the Queen, to the provost and bailies of the burgh and their officers, and declaring, *inter alia*, that they will 'make concord where discord is, to the utmost of their power.' By the Scotch Municipal Reform Act, 3 and 4 Will. IV. c. 76, s. 14, it is enacted that councillors must be entered burgesses of the burgh before their induction—that is, wherever there is any body of burgesses in any such burgh; but it is provided that no merely honorary B. shall be entitled to be so inducted. One of the peculiar privileges of a B. in Scotland is, that his heir has a right to *heirship movables*—that is, that peculiar portion of the personal property which, besides the real estate, goes to the heir-at-law. See *HEIRSHIP MOVABLES*.

BURGESS LIST AND BURGESS ROLL are lists made under the provisions of the Municipal Corporation Act, 5 and 6 Will. IV. c. 76, amended in this respect by the 20 and 21 Vict. c. 50. The overseers of the poor of every parish wholly or in part within any borough, are directed to make out an alphabetical list, called the *burgess list*, of all persons who may be entitled or qualified to be enrolled on the burgess roll of that year, such list to be open for perusal by any person, without the payment of any fee, at all reasonable hours, between the 1st (when the list must be signed and delivered) and 15th days of September in every year. This list is afterwards revised by the mayor and his assessors, and the names of those persons allowed, on revision, to remain, are then transferred to the *Burgess Roll*, which is copied into a general alphabetical list in a book provided for that purpose by the town-clerk or clerk of the peace, and which book must be

completed on or before the 22d of October in every year; every such book being the burgess roll of the burgesses entitled to vote for councillors, assessors, and auditors of the borough. Copies of such burgess roll, so completed, shall be made in writing, or printed, for delivery and sale to all persons applying for the same, on payment of a reasonable price for each copy. There are other regulations respecting these lists, and with respect to neglect and informality in making up the burgess roll; and there is an enactment to the effect, that burgess rolls shall not be called in question by reason of the defect or want of title in the mayor or assessors, it being sufficient that these latter were, when the lists were revised, in actual possession and exercise of their office.

In regard to Scotland, it has been already explained (see **BURGESS**), that persons entitled to the privileges of burgesses must be admitted according to the old form, and councillors, before induction, must be entered burgesses, such burgesses, of course, being fully privileged in all other respects. But the list, which corresponds to the English burgess roll, is the list of municipal *electors* qualified according to the provisions of the 3 and 4 Will. IV. c. 76, passed for amending the laws for the election of magistrates and councils in the royal burghs in Scotland.

BURGH is a descriptive name of towns and cities in Scotland, corresponding to the English word *Borough* (q. v.). There were *burghs of barony*, *free burghs*, *burghs of regality*, and *royal burghs*. Since 1832, there have been what are called *parliamentary burghs*—that is, towns or burghs not being royal burghs, but sending or contributing to send representatives to parliament, under the Act 1 and 2 Will. IV. c. 65. By the General Police Act for Scotland, the word B. is declared to mean also any populous place, the boundaries of which are fixed by the act. Among parliamentary burghs are Paisley, Greenock, Leith, Kilmarnock, Falkirk, Hamilton, Peterhead, &c.; and by the 3 and 4 Will. IV. c. 77, amended by the 4 and 5 Will. IV. c. 86, and the 16 Vict. c. 26, a new constitution has been conferred on them for the election of their magistrates and councillors, and for the appointment of other officers; the election being with the persons qualified to vote for a member of parliament—to be concluded in Paisley, Greenock, Leith, and Kilmarnock, by open poll in one day, the polling-books to be summed up, and the result declared by the provost: in Falkirk, Hamilton, Musselburgh, Airdrie, Port-Glasgow, Peterhead, Portobello, Cromarty, and Oban, to be by signed lists: a third of the council to go out, and others to be elected every year; and the provost and magistrates to be chosen by the council from their own number.

The police of burghs, and their paving, draining, cleansing, lighting, and improvement are regulated by the 13 and 14 Vict. c. 33, passed in 1850.

BURGHs of BARONY are corporations consisting of the inhabitants of determinate tracts of ground within the *Barony* (q. v.), and municipally governed by magistrates, whose election is either dependent on the baron or lord of the district, or vested in the inhabitants themselves. Sometimes their charter of incorporation gave them power to create subordinate corporations and crafts, as in royal burghs; but all exclusive privileges of trading in burghs are abolished by the 9 and 10 Vict. c. 17. In other respects, the general corporate law of the country applies to burghs of barony, as to which see below, **BURGHs, ROYAL**. They have power to administer their common good, to elect their burgh-officers, to make bye-laws, and their burgesses are entitled to

BURGH—BURGH ACRES.

challenge the sale or other disposition of the burgh's property.

BURGHES, FREE, were burghs of barony enfranchised by crown charter with rights of trade, both home and foreign, but subjected; at the same time, to the same class of public burdens and taxation which royal burghs had to bear as the price of their peculiar privileges. Since the gradual decay and ultimate suppression of commercial monopoly, this class of burghs has become extinct, or rather *all* burghs may now be said to be *free*.

BURGHES OF REGALTY were burghs of baronies, spiritual or temporal, enfranchised by crown charter, with regal or exclusive criminal jurisdiction within their own territories, and thence called *regalities* (q. v.). Some of these burghs of regality, especially those which were dependent on the greater bishops and abbots, were of high antiquity, and possessed jurisdiction and privilege of trade only distinguishable from those of royal burghs, by being more circumscribed in their limits. Since the abolition of hereditary jurisdictions, by the Act 20 Geo. II. c. 43, the distinction between burghs of regality and burghs of barony has ceased to be of any practical importance.

BURGHES, ROYAL. A royal burgh is a corporate body deriving its existence, constitution, and rights, from a royal charter—such charter being either actual and express, or presumed to have existed, and by the accident of war and time, to have perished. By a Scotch act passed in 1469, a constitution was given to royal burghs, by which the right of appointing their successors belonged to the old councils, the act also containing the singular provision, that when the new council was chosen, the members of it, *along with those of the old council*, should choose all the office-bearers of the burgh, each craft or trade corporation being represented at the election by one of themselves. But this simple plan was not universally adopted, and the election gradually lost its former free and popular form—a close and exclusive proceeding being ultimately established in its place. This 'close system,' as it has been called, notwithstanding its repugnancy to the spirit of the times, and modern ideas of public administration, continued in force until the year 1833, when an act of parliament was passed, the 3 and 4 Will. IV. c. 76, amended by the 4 and 5 Will. IV. c. 87, and the 16 Vict. c. 26, by which it was abolished, and an entirely new constitution given to royal burghs, with the exception of nine of them, which, on account of the smallness of their population, are excepted from the provisions of the act, the election in these being conducted as it was before the act was passed. These nine burghs are: *Dornoch, New Galloway, Culross, Lochmaben, Bervie, Wester Anstruther, Kiltrenny, Kinghorn, and Kintore*. Of the other royal burghs, being those to which the reforming acts apply, the principal are—*EDINBURGH, Glasgow, Aberdeen, Dundee, Perth, Dunfermline, Dumfries, and Inverness*. The leading provisions of these acts are as follow: All persons within the burgh qualified under the Parliamentary Reform Act, 2 and 3 Will. IV. c. 65, in respect of property or occupancy of premises, and who have resided for six months next previous to the last day of June, within the royalty, or within seven miles of it, are entitled to vote in the election of councillors. In such burghs as do not now send members to parliament, property of the same value is required for the qualification, and claims for this privilege must be lodged with the town-clerk on or before the 21st of July, in a particular form. The councillors are chosen from among the electors residing, or personally carrying on business, within the royalty; and where there is a body

of burgesses in the burgh, each councillor, before his induction, must be entered a burges—a requisite clearly unnecessary for the purposes of the municipal administration contemplated by the act, and which, it is expected, will be done away. The number of councillors in each burgh is such as, by the *sett* or constitution existing at the passing of the act, formed the common council, or, where this was variable, the smallest number making a full council. The electors of Edinburgh, Glasgow, Aberdeen, Dundee, Perth, Dunfermline, Dumfries, and Inverness, are divided into wards or districts. At the election immediately succeeding the passing of the act, each ward elected six councillors; but as every year the third part of the council goes out of office, in the order prescribed by the act, two councillors are now annually chosen by each ward, there being no bar, however, to the re-election of an outgoing councillor. The electors in other burghs choose the whole council exactly as these wards do their proportion of it, and consequently elect each year a third part in place of that which has retired. Upon the third lawful day after the election succeeding the passing of the act, the councillors meet and choose, by a plurality of voices, a provost, bailies, treasurer, and other office-bearers, as existing in the council by the *sett* or usage of the burgh; and vacancies occurring among such office-bearers, in consequence of the annual retirement of the third part of the council, are directed to be supplied from the councillors in like manner, as soon as the election of the new third has taken place, the first attending magistrate having a casting vote in cases of equality. Vacancies taking place during the year by death or resignation are supplied, *ad interim*, by the remaining members of the council, and the persons so elected by the councillors retire at the succeeding election. The rights of the guildry, trades, &c., to elect their own dean of guild, &c., are still preserved; but they are now no longer recognised as official or constituent members of the council, their functions being performed by a member of the council, elected by a majority of the councillors. In Aberdeen, Dundee, and Perth, however, the dean of guild, and in Edinburgh and Glasgow, the convener of trades and the dean of guild are, *ex officio*, members of council; and the electors in all the above-named burghs choose such a number of councillors as, together with these officers, makes up the proper number. No magistrate or councillor can be town-clerk. The magistrates and council possess the same powers of administration and jurisdiction as were enjoyed by the magistrates and town-council before the passing of the act; and none of them is responsible for the debts of the burgh, or the acts of his predecessors, otherwise than as a citizen or burges. The existing council in all burghs royal must every year make up, on or before the 15th of October, a state of their affairs, to be kept in the town-clerk's or treasurer's office. The act 16 and 17 Vict. c. 26 provides for the supplying of vacancies in town-councils of burgh, consequent on void and irregular elections.

The police of burghs and other populous places, and the paving, draining, cleansing, lighting, and improving the same, are regulated by the 13 and 14 Vict. c. 33; and the 16 and 17 Vict. c. 93, enables burghs to improve and maintain their harbours.

The exclusive privilege of trading in burghs is abolished by the 9 and 10 Vict. c. 17.

BURGHERS, a name popularly given to a religious denomination in Scotland. See **UNITED PRESBYTERIANS**.

BURGH ACRES are acres or small patches of land lying in the neighbourhood of *Royal Burghs*

(q. v.), usually feued or leased out to burghesses or persons resident within the burgh. A Scotch act of parliament, passed in 1695, relating to the division or partition of lands lying runrig, excepts burgh acres, or, as the act calls them, 'burrow and incorporate acres,' from its provisions; but this is to be understood only of royal burghs, and not of burghs of barony or others.

BURGHs, CONVENTION OF. See **CONVENTION OF ROYAL BURGHs.**

BURGMAIR, HANS, a noted old German painter and wood-engraver, was born at Augsburg, 1473. He was the father-in-law of the elder Holbein, and the friend of Albert Dürer, whose influence is manifest in B.'s works. Several excellent paintings by B. are preserved in the galleries of Munich, Berlin, Augsburg, and Vienna. But he is best known as a wood-engraver; his cuts amounting in all to nearly 700. Among the most celebrated of these is his 'Triumph of the Emperor Maximilian,' in 135 cuts, with a description by the emperor himself. Another fine series of 237 cuts, called 'The Wise King,' represents the deeds of Maximilian. B. is supposed to have died about the year 1559.

BURGLARY (through the old Fr. from Lat. *burgi latro*, a robber of a burg or enclosure), in the criminal law of England, is defined to be a breaking and entering the mansion-house of another in the night, with intent to commit some felony within the same, whether such intent be executed or not. It is peculiar to this crime, that it can only be committed in the *night-time*, which, by the 7 Will. IV., and 1 Vict. c. 86, s. 4, is considered as commencing at nine in the evening, and concluding at six in the morning of the next day. The next requisite of the crime, according to the definition we have given, relates to the *place* of its commission. It must be in a *mansion-house*, for such is the technical expression; but this is construed to mean any private dwelling, or any building temporarily or permanently used for that purpose. It cannot be committed in a distant barn, warehouse, or the like, unless there be a communication with the dwelling-house, nor in a house where no one resides. But it is B. to break into a house which is used as an occasional residence, and which the owner is in the habit of leaving for a short period, with the intention of returning, even although no one be in the house at the time of the offence. A chamber in a college, or an inn of court, is also within the meaning of a mansion-house; so likewise is a room or lodging in any private house, if the owner and the lodger enter by different outer doors; but if they both enter by one outer door, then the offence can only be committed against the owner. For the same reason, a building belonging to a corporation, and separately inhabited by the officers of the body corporate, is the mansion-house of the corporation, and not of the officers. Again, a shop which is part of another man's house, and hired merely for the purpose of work or trade, is not a dwelling-house, and B. cannot be committed in it, neither as against the shopkeeper, nor against the person who occupies the other portion of the house. This offence cannot be committed in a tent or booth erected in a market or fair, though the owner may lodge therein, for his doing so makes it no more B. to break open such an erection, than it would be to uncover a tilted waggon under the same circumstances. But it may be committed by breaking open a church, which, according to Sir Edward Coke, is *domus mansionalis Dei*, the mansion-house of God.

As to the *manner* of committing B., it is laid down by Blackstone that there must be both a

breaking and an entry to complete it. There must, in general, be an actual breaking, a substantial and forcible irruption—as, at least, by breaking, or taking out the glass of, or otherwise opening a window; picking a lock, or opening it with a key; nay, by lifting up the latch of a door, or unloosening any other fastening. But if a person leaves his doors or windows open, it is his own folly and negligence, and if a man enters therein, it is no B.; yet if he afterwards unlocks an inner or chamber door, it is so. To come down a chimney is held a burglarious entry, for that is as much closed as the nature of things will admit; so also to knock at a door, and upon its being opened, to rush in with a felonious intent; or, under pretence of taking lodgings, to fall upon the landlord, and rob him. If the servant conspires with a robber, and lets him into the house by night, this is B. in both.

The *intent* must also appear, otherwise the offence will amount only to a trespass; and it must be an intent to commit felony, which may be inferred from the conduct of the offender while in the house.

The punishment for this crime is now regulated by the act 7 Will. IV. and 1 Vict. c. 86, amended by the 16 and 17 Vict. c. 99, and the 20 and 21 Vict. c. 3. The provisions are to the effect, that any one convicted of B. shall be liable to penal servitude for life, or any term not less than ten years, or to be imprisoned for any term not more than three years; and in the case of imprisonment, hard labour and solitary confinement may be superadded. It is further enacted, that whosoever shall burglariously break and enter into any dwelling-house, and shall assault with intent to murder any person being therein; or shall stab, cut, wound, beat, or strike any such person, shall be guilty of felony, and suffer death. By another statute, the 14 and 15 Vict. c. 19, also amended by the 16 and 17 Vict. c. 99, and the 20 and 21 Vict. c. 3, it is enacted that any person found *by night*, armed with any dangerous or offensive weapon or instrument, or with housebreaking implements, or with face blackened or disguised, with intent to enter any buildings, and to commit felony therein; or if he be found by night in any building with intent to commit a felony therein—is guilty of a misdemeanour, punishable with imprisonment, not exceeding three years; and in case of a second conviction, is liable either to such imprisonment, or to penal servitude for not less than three, and not exceeding ten years.

Blackstone observes, that this offence was anciently called *Hamesecken*, as, he adds, it is in Scotland to this day. But the Scotch law on this subject has some points of difference—*hamesecken*, or *hamesucken*, as it is spelled in the Scotch books, not being quite identical with B.: thus, the former is an offence exclusively against the *person*, and it may be committed in the daytime as well as at night; and there are other points of dissimilarity. The Scotch law relating to *housebreaking* and *stouthrief* affords analogies. See **HAMESUCKEN, HOUSEBREAKING, STOUTHRIEF, LARCENY, ROBBERY, ASSAULT.**

BÜRGLEN, a village of Switzerland, in the canton of Uri, about two miles from Altorf. It is celebrated as the birthplace of William Tell. The supposed site of the patriot's house is now occupied by a chapel, upon the walls of which are represented certain well known scenes from his history.

BURGOMASTER. See **GULL.**

BURGOS, a city of Spain, capital of the new province of the same name, and of the former kingdom of Old Castile, is situated in a fertile valley at the foot of the Sierra d'Oca, and on the right bank

BURGOYNE—BURGUNDY.

of the river Arlanzon, in lat. 42° 20' N., and long. 3° 45' W. Pop. 15,924. B. is a very ancient place, having been founded in 844. Many of the gloomy old houses of its early history still remain. In the castle of B., Edward I. of England was married to Eleanor of Castile. The cathedral of B., founded in 1221, is one of the noblest specimens of Gothic architecture in Spain. Its various chapels are rich in fine sculpture and tombs. It was the birth-place of the Cid (q. v.). B. has manufactures of woollens, linens, and hats, but it depends chiefly on the traffic which its position on the great road from France and the northern Spanish provinces to Madrid secures it. B. has several charitable and educational institutions. It formerly had a much larger population—as many as 50,000—but on the removal of the court to Madrid in the 16th c., B. began to decline in population and importance. It was further greatly injured in November 1808 by the French, who sacked it. In 1812, the castle was four times unsuccessfully besieged by Wellington, who, however, took it in the following year, when the French blew it up, as well as the fortifications.—The province of B. has an area of 7082 square miles, and a population, in 1857, of 347,693. The surface is elevated, the soil fertile, yielding grain and fruits. The hills afford rich pasturage; and the minerals gold, silver, iron, lead, and copper are found.

BURGOYNE, JOHN, a British general and dramatist, natural son of Lord Bingley, early entered the army, and in August 1759 was appointed lieutenant-colonel commandant of the 16th Light Dragoons. In 1761 he served at Belle Isle, and in 1762 commanded a force sent into Portugal for the defence of that kingdom against the Spaniards, when he surprised and captured Alcantara. In 1776 he served in North America, and in the summer of 1777 he was appointed to the command of a large force ordered to penetrate from Canada into the rebellious districts. The early part of the expedition was marked by his capture of Ticonderoga; but neglecting to preserve his communications with Canada, he encountered the greatest difficulties, and was at last obliged to surrender with his army to General Gates, at Saratoga. Soon after his return to England, having been denied an audience of the king, and refused a court-martial, he went over to the opposition party, and voluntarily resigned all his appointments. On a change of ministry, at the close of the American war, he was appointed commander-in-chief in Ireland. This office he resigned two years after, and subsequently seems to have devoted his time to light literature. He was the author of some pamphlets in defence of his conduct, and of *The Maid of the Oaks* (1780), *The Heiress* (1786), *The Lord of the Manor*, and other stock dramatic pieces. B. was one of the managers for conducting the impeachment of Warren Hastings. He died June 4, 1792.

BURGOYNE, SIR JOHN FOX, Bart., an eminent engineer-officer, born in 1782, entered the Royal Engineers in 1798. From 1800 to 1807, he served in the Mediterranean and the Levant; proceeded with Sir John Moore's force to Sweden, and subsequently to Portugal, and was at Corunna in 1809. The same year, he became attached to the Third Division of the army under Sir Arthur Wellesley in the Peninsula, and till the conclusion of the war in 1814, was present at all its sieges, distinguishing himself in those of San Sebastian and Burgos, and was twice wounded. He became Lieutenant-colonel April 27, 1812; in 1814, was commanding engineer of the expedition to New Orleans, and in 1826, of

that sent to Portugal. In 1830 he was appointed chairman of the Board of Public Works in Ireland; and in 1845, Inspector-general of Fortifications in England. In 1851 he obtained the rank of Lieutenant-general, and in 1854 was made D.C.L. of Oxford University. During the same year he was sent to Turkey, to devise measures against the advance of the Russians; and in the Crimean war he was chief of the engineering department of the British army till recalled in 1855. For his services at Sebastopol, he received from the Sultan the order of the Medjidie, and from the French emperor that of grand officer of the Legion of Honour. He was made general in 1855, and created a baronet in 1856.

BURGUNDY (Fr. *Bourgogne*), an ancient province of France, now forming the departments Côte d'Or, Saone-et-Loire, Ain, and part of Yonne. Dijon was the capital of Burgundy. The ancient Burgundians (*Burgundi* or *Burgundiones*), originally a German tribe, were at first settled on the banks of the Oder and the Vistula, and afterwards extended themselves to the Rhine and the Neckar, and, in 407, penetrated into Roman Gaul. Their conversion to Christianity took place in the course of eight days! They adopted a brief Arian confession of faith, and were baptized. From 407 to 534, the kingdom of B. was several times divided; and in 451, Gundicar, king of B., with 10,000 men, confronted Attila, but was defeated and slain. The tradition of this overthrow of the old Burgundians is preserved in a confused form in the *Nibelungen Lied*.

In 534, B. passed under the rule of the Franks; but the weak government of the later Carolingian kings allowed it to become once more independent, and it was named the kingdom of Arles, from the residence of its first king, Boso, who died in 887. He was succeeded by his son Louis; and after a time of contention and division of the French territories, Duke Rudolf, nephew of King Hugo of France, made himself ruler of Upper B., and was followed by Rudolf II. (912), who was crowned king of Italy in 921, and united Lower B., or Arles, to his own kingdom in 928. Conrad the Peaceable succeeded, and after him, Rudolf III., who, dying without male issue in 1032, bequeathed his kingdom to the Emperor Conrad II. of Germany, whose son, Henry III., made it a duchy of the German empire.

With Philip the Bold, the founder of the new ducal dynasty of B., a new and splendid era was commenced, in 1363, and was continued to the death of Charles the Bold (q. v.), in 1477, who left no male issue. B. was then incorporated with France.

BURGUNDY, LOUIS, DUKE OF, the grandson of Louis XIV. of France, and Dauphin of France after the death of his father, was born at Versailles in 1682. Even in childhood he was ungovernable, and became excessively violent and haughty, and abandoned to all gross and sensual passions. Although educated under the care of the Abbé Fénélon, he used, when 30 years of age, to divert himself with drowning flies in oil, and blowing up living frogs with gunpowder. He had the misfortune to be deformed; his deportment and manners were undignified, and his mind was imbued with bigotry. When only about 15 years of age, he was married to the Princess Adelaide of Savoy, and spent his time wholly in amusements in the company of his spouse and of the ladies of the court. Nevertheless, in 1701, he was nominally appointed generalissimo of the army, really under the command of the Duke de Vendôme, and is said to have shewn some spirit in a cavalry-fight at Nimeguen; but he quarrelled with Vendôme, chiefly because he had once been compelled to establish his head-quarters

BURGUNDY PITCH—BURIAL.

in a nunnery. He lost the respect of the army, and was exposed to many humiliations, partly proceeding from intrigues set on foot against him out of envy by his father. He returned to the court more eccentric, gloomy, and unsociable than before. But when he became, on his father's death, the second person in the kingdom, all his defects vanished from the sight of the courtiers, and flattery bestowed on him the title of the Great Dauphin. He died suddenly in the year 1712. A few days previously, his wife and her son, the Duke of Bretagne, had died, and the same hearse carried father, mother, and child to St Denis. The Duke of Orleans, subsequently regent, and his daughter, the Duchess of Berri, were accused, but without reason, of having caused them to be poisoned.

BURGUNDY PITCH, a resinous substance prepared from common frankincense (q. v.), the spontaneous exudation of the Norway spruce-fir (*Abies excelsa*; see FRU) by melting it in hot water, by which means it is freed from a considerable part of the volatile oil which it contains. By straining it through a coarse cloth, impurities are also removed. B. P. is of a yellowish-white colour, hard and brittle when cold, but softening by the heat of the hand, and readily adhering to the skin. It has a not unpleasant resinous odour, and a slightly bitter taste. It is used in medicine as an external application only, and generally acts as a mild irritant. A very common application of it is as a plaster in complaints of the chest, and in rheumatic complaints. It enters also as an ingredient with resin, oils, &c., into a compound plaster of similar use. The B. P. of commerce is now principally brought from Hamburg; but the greater part of what is sold under that name is really manufactured of common rosin and palm-oil, or from American turpentine. It has a fuller yellow colour than the genuine B. P., and a less agreeable odour.

BURGUNDY WINES are chiefly the produce of vineyards cultivated on the hilly lands forming the Côte d'Or, between Dijon and Chalons. These hills average about from 800 to 1000 feet in height; the vineyards ascend up the slopes in terraces, and spread along the table-land on the summit. 'In richness of flavour and in perfume, and all the more delicate qualities of the juice of the grape, the wines grown here unquestionably rank as the finest in the world.' The most celebrated of the red wines of Burgundy are the Closvougot (near Beaune), Nuits, Chamberlain (the favourite wine of Louis XIV. as well as of Napoleon), the Romané-Conti, Richebourg, Volnay, and Pomard. Of other red wines of Burgundy not grown on the Côte d'Or, those of Pitois, Perrière, Preaux, and Auxerre, are held in most repute. The white wines of Burgundy are also the finest in France, but being produced in less quantity, they have less celebrity. The quantity of wine annually produced in Burgundy averages 3,500,000 hectolitres (77,000,000 gallons), of which only about a fifth is consumed in the district.

BURIAL, a word of Teut. origin (Ang.-Sax. *birgan*, to conceal), is applied to the prevalent method among civilised nations of disposing of the dead, by hiding them in the earth. As there is almost nothing else so deeply interesting to the living as the disposal of those whom they have loved and lost, so there is perhaps nothing else so distinctive of the condition and character of a people as the method in which they treat their dead. Hence, funeral customs associate themselves with a wide variety of sentiments, from gentle and rational sorrow, up to deification of the departed, accompanied sometimes with cruelty

and ferocity towards the living. People of a low and barbarous type carelessly permit the remains of the dead to lie in the way of the living, and there are a few instances in which the object of artificial arrangements has been to preserve a decorated portion of the body—as, for instance, a gilded skull—among survivors. The general tendency of mankind, however, has always been to bury the dead out of sight of the living; and various as the methods of accomplishing this end have been, they have resolved themselves into three great classifications: 1. The simple closing up of the body in earth or stone; 2. The burning of the body, and the entombing of the cinders; and, 3. The embalming of the body. The first of these seems to be the earliest form of which we have any record, and it is the form most amply sanctioned by the existing practice of the civilised world. It is the method referred to in the earliest Scriptures; and all are familiar with the touching scene in which Abraham buries Sarah in the cave in the land of Canaan which belonged to Ephron, but was, after a solemn and courteous negotiation, secured to Abraham for a possession to bury his dead in (Gen. c. 23). The horrible fate of being left unburied, either from scorn or neglect, is powerfully told in the prophecy of Jeremiah against Jehoiakim: 'He shall be buried with the burial of an ass, drawn and cast forth beyond the gates of Jerusalem.' There is frequent allusion in the later Scriptures, and especially in the New Testament, to the embalming of the body in antiseptics and fragrant substances; and the burning of the bodies of Saul and his sons is accounted for by commentators on the supposition that they were too far decayed to be embalmed. The Israelites may have learned the practice of embalming from the Egyptians, among whom it was an art so greatly cultivated and extensively practised, that Egyptian corpses, as inoffensive as any article of wood or stone, are scattered over Europe in museums, and are even to be found as curiosities in private houses. The soil and climate of Upper Egypt seem to have afforded facilities for embalming unmatched in any other part of the world; and in other places the vestiges of the practice are comparatively rare, though it is usual even yet to embalm royal corpses, and in some places to preserve a series of mummies, as in the vault of the monastery of Kreuzberg, at Bonn, where the monks have been successively preserved in their costume for centuries. The practice of incineration, or of the burning of the body, and the entombing of the ashes, deserves more inquiry than it has yet obtained. In Greece, in Etruria—both before and after it came under the Romans—and in the north of Europe, the simple burial of the body, and its prior reduction to ashes, were both practised, and sometimes contemporaneously. The tombs of Etruria are rich in art, much of it going to the adornment of the urns of baked clay in which the ashes of the dead are kept. Vessels of *terra-cotta*, or cooked earth, containing human remains, have been found, often so large that they appear to have served as coffins for containing the whole body. Vessels of this kind were found in the valley of the Scamander by some British officers while spending their leisure time after the siege of Sebastopol, upon the ground supposed to have been occupied by the besiegers of Troy. Smaller cinerary urns have been found over so extensive a portion of the world, that it is difficult to define the limits to which they belong. The Danish antiquaries say, that in their stone period, when the use of metals was unknown, the dead were all buried unburned in stone chambers, and that the burning of the bodies and the preservation of the ashes in urns came in with the age of bronze. These antiquaries associate

BURIAL—BURIAL ACTS.

with the older system those amorphous mounds of earth or stone called barrows or tumuli, which are to be found all over the north of Europe. Mr Bremner, in travelling among the steppes of the Ukraine, saw multitudes of these small mounds, which reminded him at once of what he had seen on the plain of Troy, at Upsala in Sweden, in Scotland, and in Ireland. The Irish tumulus of New Grange is perhaps the most remarkable of all, forming a connecting link between the simple harrow on the moor and the pyramids of Egypt, which are the perfection of the same kind of structure applied to the same purpose—the burial of the distinguished dead. These structures open up a large field of curious inquiry. The simple theory, that they were raised over the dead, has lately been disturbed by the discovery that many of them are not artificial, but relics of sheets of alluvial matter, the mass of which has been carried away; and even in these, human remains have been found, the natural mounds having been used as monuments. Even when human remains are connected with barrows, cromlechs, or the large shapeless pillars commonly called Druidical, it is often questionable whether the monument was made to receive such remains. It is certainly ascertained to have been a practice in ancient times to bury bodies in tombs which were themselves ancient when they received their inmates.

Some of the grandest buildings in the world have been tombs; such are the pyramids, the castle of St Angelo, the tomb of Cæcilia Metella, and many temples scattered over Hindustan and other eastern countries. Thus, the respect paid by the living to the dead has preserved for the world many magnificent fruits of architectural genius and labour. A notion that the dead may require the things they have been fond of in life, has also preserved to the existing world many relics of the customs of past ages. The tombs of Egypt have supplied an immense quantity of them, which have taught the present age more of the manners of ancient nations than all the learned books that have been written. It is an awful remembrance, at the same time, that inanimate things were not all that the dead were expected to take with them. Herodotus tells us of favourite horses and slaves sacrificed at the holocaust of the dead chief: The same thing has been done in our own day in Ashantee. In many countries, the wives had the doom, or privilege, as it was thought, of departing with their husbands; and down to the present generation the practice has lived in full vigour in the Hindu *sutti*. Among the Jews, the Greeks, the Romans, and many ancient nations, the dead were buried beyond the towns. The 'stop, traveller!' was a usual memorandum on Roman tombs. In Christian countries, if the remains of the saint to whom a church was dedicated could be obtained—or anything passing for the remains—they were buried near the altar in the choir. It became a prevalent desire to be buried near these saints, and the bodies of men eminent for their piety, or high in rank, came thus to be buried in churches. The extension of the practice was the origin of churchyards. These, in crowded towns, became offensive and unhealthy. It can scarcely be said that this practice, so detrimental to the public health, as the burial within churches, was checked in this country until the whole system of intramural interment, as it was called, was attacked, about the year 1844, by Mr Chadwick and other sanitary reformers. Measures were afterwards carried for shutting graveyards in crowded cities, and placing interments in open cemeteries under sanitary control. The first great measure was passed in 1850, when the Board of Health was made a Burial Board for the Metropolis, and power

was given to the Privy Council to close the city graveyards. The act was modified two years afterwards, by transferring the duties of managing cemeteries to local boards appointed by the vestries. It was in London that the danger was most urgent and the remedy immediate. It was extended to the English provinces in 1853, and to Scotland in 1855.

In England, burial in some part of the parish churchyard is a common law right, without even paying for breaking the soil, and that right will be enforced by mandamus. But the body of a parishioner cannot be interred in an iron coffin or vault, or even in any particular part of a churchyard, as, for instance, the family vault, without the sanction of the incumbent. To acquire a right to be buried in a particular vault or place, a faculty must be obtained from the ordinary, as in the case of a pew in the church. But this right is at an end when the family cease to be parishioners. All such rights, by faculty or otherwise, are expressly saved by the BURIAL ACTS (q. v.).

By the canons of the Church of England, clergymen cannot refuse or delay to bury any corpse that is brought to the church or churchyard; on the other hand, a conspiracy to prevent a B. is an indictable offence, and so is the wilfully obstructing a clergyman in reading the B.-service in a parish church. It is a popular error, that a creditor can arrest or detain the body of a deceased debtor; and the doing such an act is indictable as a misdemeanour. It is also an error, that permitting a funeral procession to pass over private grounds creates a public right of way. By the 3 Geo. IV. c. 126, s. 32, the inhabitants of any parish, township, or place, when going to or returning from attending funerals of persons in England who have died and are to be buried there, are exempted from any toll within these limits. And by the 4 Geo. IV. c. 49, s. 36, the same regulation is extended to Scotland; the only difference being, that in the latter case the limitation of the district is described by the word *parish* alone. The 6 and 7 Will. IV. c. 86 regulates the registry of deaths. The 4 Geo. IV. c. 52 abolished the barbarous mode of burying persons found *felo de se*, and directs that their B. shall take place, without any marks of ignominy, privately in the parish churchyard, between the hours of nine and twelve at night, under the direction of the coroner. The B. of dead bodies cast on shore is enforced by 48 Geo. III. c. 75. See Wharton's *Laws Lexicon*.

In Scotland, the right of B. in a churchyard is an incident of property in the parish; but it is a mere right of B., and there is not necessarily any corresponding ownership in the *solum* or ground of the churchyard. In Edinburgh, however, the right to special B.-places in churchyards is recognised.—For B. in cemeteries in England and Scotland, see CEMETERY.

BURIAL ACTS. These are the 15 and 16 Vict. c. 85, for London; the 16 and 17 Vict. c. 134, the 17 and 18 Vict. c. 87, and the 18 and 19 Vict. cc. 79* and 128, for places in England beyond the limits of the metropolis—all as amended by the 20 and 21 Vict. c. 81, and the 22 Vict. c. 1. The regulations relate to the appointment of

* By some clerical error or inadvertence, this act is erroneously described in the preamble of the 20 and 21 Vict. c. 81, which professes to amend it. It is there described as the 18 and 19 Vict. c. 78, and it is also erroneously entitled. The effect of this mistake may be serious, for it is plain that the act intended to be amended by the 20 and 21 Vict. cannot strictly be said to be affected by the provisions of the latter.

burial-boards for parishes—the authorising new burial-places, proper sanitary regulations, the control by the government, and by order in council, and many other details too numerous to specify here. Our readers must be content with our referring them to the acts themselves, or to their lawyers.

The corresponding acts for Scotland are the 18 and 19 Vict. c. 68, amended by the 20 and 21 Vict. c. 42.

BURIAL SOCIETIES are friendly societies constituted in the usual manner, and with the express object of supplying a fund for paying the funeral expenses of the members on their death. See **FRIENDLY SOCIETIES**. It became customary to enter the names not only of adults, but of children, in such societies. The proceedings of the criminal courts have shewn that, in some instances, children on whose lives such an insurance was effected have been killed or allowed to die of neglect, and the alarm created by such instances, was enhanced by the discovery that children were frequently insured in more than one society. To obviate this calamitous use of a beneficial arrangement, it was provided that no insurance of a child under six years of age in a burial society should be legal. It was attested to the Select Committee of the Commons on Friendly Societies in 1849, that the practice of such insurances continued in uncertified societies; and at the same time it was stated on behalf of the friendly societies: 'In our long experience with these societies in Liverpool, in which are nearly 100,000 members, approximating to nearly one-third of the population of this great town, we have not had one instance of death by violence for the sake of the burial money.' In the Friendly Societies Act of 1850, and in subsequent enactments, stringent arrangements for certifying the cause of death have been adopted as a sufficient protection from this crime.

BURIDAN, JEAN, a scholastic metaphysician of the nominalist party, was born at Bethune, in Artois, in the 14th c., and studied at Paris under Occam, where he also became a teacher of philosophy. The events of his life, as well as the manner of his death, are very obscure. One account states, that he was thrown into the Seine, by command of Marguerite de Bourgogne, daughter-in-law of Philippe le Bel, whose infidelities he had rebuked. Another, later, but less mythical-looking account, states that B. was driven from France as a disciple of Occam, and fled to Austria, where he founded a school. His elucidations of Aristotle are among his most useful writings. In his *Logic*, his great endeavour was to facilitate the discovery of middle terms for all kinds of syllogisms. The celebrated sophism known to the schoolmen under the name of **BURIDAN'S ASS**, has been discussed at superfluous length, and with needless ingenuity, by Bayle. It is not at all likely that it was ever adduced by B., but more probably by his adversaries, who wished to ridicule his metaphysical doctrine of *Determinism*—viz., that in every mental and bodily action the will must be determined by something out of itself. The sophism referred to is, that if a hungry ass be placed exactly between two bundles of hay of equal size and attractiveness, it must starve, as there is nothing to determine the will of the animal towards either bundle. His chief works are—*Summula Dialectica* (Paris, 1487), *Compendium Logice* (Venice, 1489; Oxford, 1637), *In Aristotelis Metaphysica* (Paris, 1518).

BURIN, or **GRAVER**, the principal instrument used in copper-engraving, is made of tempered steel, and is of prismatic form, the graving end being ground off obliquely to a sharp point. The style of a

master is frequently described by the expressions *soft B.*, *graphic B.*, *brilliant B.*, or whatever other character may belong to it.

BURITI PALM (*Mauritia vinifera*; see **MAURITIA**), a beautiful palm, which grows in great abundance in the swamps of some parts of the north of Brazil. It is one of the loftiest of palms. Its leaves are fan-shaped, and form a large globular head at the top of the stem. It produces a great number of nuts about the size of a small hen's egg, covered with rhomboidal scales arranged in a spiral manner. Between these scales and the albuminous substance of the nut, there is an oily reddish pulp, which is boiled with sugar, and made into a sweetmeat. An emulsion is also prepared from it, which, when sweetened with sugar, is a very palatable beverage, but if much used, is said to tinge the skin of a yellow colour. The juice of the stem also makes a very agreeable drink; but to obtain it, the tree must be cut down, when several holes about 6 inches square, 3 inches deep, and 6 feet apart, are cut in the trunk with a small axe; and these in a short time are filled with a reddish-coloured liquid, having much the flavour of sweet wine.

BURKE, EDMUND, a philosopher and politician, distinguished over all the men of his times for eloquence and political foresight, was born in 1730, in Dublin, where his father had an extensive practice as an attorney. As a school-boy, he displayed those traits of character and the germs of those powers which ultimately gave him greatness. In 1744, B. entered the university of Dublin, of which he became a scholar. His undergraduate course was not unmarked by the ordinary distinctions of successful application; but it would appear that he mainly devoted himself to his favourite studies of poetry, oratory, history, and metaphysics. In February 1748, he graduated B.A., and in 1751 took his degree as Master of Arts. In the interval (1750), being destined for the English bar, he proceeded to London, to keep his terms at the Middle Temple. To legal studies, however, he never took kindly, and ultimately he abandoned the idea of becoming a barrister. During the years 1750—1756 he would appear to have occupied himself in travelling through England, enjoying the society of literary men, in study, and finally in writing for various periodicals.

B., when yet at the university, had achieved a local reputation for literary talent and eloquence. Among the compositions of his undergraduate life, the most noticeable perhaps is his translation of the conclusion of the second *Georgic* of Virgil, which shews poetic talent of no mean order. His first important publication, however, was the celebrated *Vindication of Natural Society*, written in imitation and ridicule of the style and reasoning of Lord Bolingbroke, in which, with well-concealed irony, he confutes his lordship's views of society by a *reductio ad absurdum*. This work, published anonymously in 1756, at the age of 26, attracted considerable attention. Soon after, in the same year, appeared his well-known essay, *A Philosophical Inquiry into the Origin of our Ideas of the Sublime and Beautiful*—a work containing a comprehensive induction of the various sources of the ideas referred to, but which must be pronounced a failure, so far as it pretends to analyse into their primary elements the emotions of the sublime and beautiful.

The essay on the *Sublime and Beautiful* attained a rapid popularity, and its author soon found himself courted by all the eminent men of his time. Garrick was already one of his friends; among them he soon could count Reynolds, Soame Jenyns, Lord Lyttelton, Warburton, Hume, and Dr

Johnson. Notwithstanding this popularity, however, his progress continued slow; for three years yet, he had to occupy himself with periodical writing, devoting his leisure principally to political subjects. What is considered a joint work of B. and his cousin, William Bourke, appeared in 1757—viz., *An Account of the European Settlements in America*—and shews how carefully at this date he had studied the condition of the colonies. In 1761, Mr W. G. Hamilton ('Single-speech Hamilton'), then Secretary for Ireland, having appointed him his private secretary, he returned to Dublin, where, during two years' service, he demonstrated his aptitude for political business, receiving in 1763, in reward of his services, a pension on the Irish establishment of £300, which, however, he did not long enjoy.

Returning to London, B., in 1764, along with Reynolds, founded the Literary Club, the history of which is associated with almost every considerable name in the literature of the period. But literary society did not call off his attention from the chances of a political career. He became private secretary to the Marquis of Rockingham, on his becoming premier, and at the same time entered parliament as member for Wendover. Here his eloquence at once made him the reputation of being 'the first man in the Commons.' The Rockingham administration, however, lived only a few months, and with it terminated this his second political employment. To trace his subsequent career in parliament is more than the limits of this article will allow; it must suffice to state briefly that his parliamentary life extended from 1766 to 1794 without intermission; that he was successively member for Wendover, Bristol, and Malton; twice held the post of Paymaster of the Forces, once under Rockingham, and again under Lord North, with the standing of a privy councillor; that after a career in parliament remarkable for the laboriousness, earnestness, and brilliancy with which every duty was discharged, and extending over nearly 30 years, he retired at last, receiving the thanks of the Commons for his numerous public services, and rewarded by government, on the express request of his sovereign, with pensions amounting in all to £3700. It would be wrong, however, to omit that as Paymaster of the Forces he, with a scrupulous regard to public economy, sacrificed all the perquisites of his office, exhibiting a severe integrity unexampled among public men; and that in his relation with the constituency of Bristol, which was alienated from him by his advocacy of the claims of the Roman Catholics and of the opening up of the trade of Ireland, he was the first to maintain the doctrine of the independence of parliamentary representatives—that they are not machines to vote for measures approved by their constituencies simply for that reason, but men and thinkers chosen by them to calmly consider and legislate for the good of the commonwealth. It must also be mentioned, that during his career he rendered more important service to the cause of humanity than any man of his time; he prepared the way for the abolition of the slave-trade, a measure which was destined to ripen to success in the hands of Wilberforce; he advocated the cause of humanity in India against the voracious greed of stockholders, who regarded its millions simply as materials for plunder, and largely contributed to improve the government of that country. Towards America he advocated a policy of justice and conciliation, which, had it been adopted, would have averted the horrors of the War of Independence, and retained the colonies in amity with the mother-country. And to the advocacy of every cause which he espoused, he brought a capacity

for patient research that was unlimited, and an eloquence that has never been transcended.

Before proceeding to remark on the character and powers of B., a very brief notice must be taken of his leading literary efforts connected with his political labours. Little more than a catalogue can here be given of them. Omitting a variety of valuable letters—several on the condition of Ireland—notice must be taken of his *Observations on a Pamphlet on the Present State of the Nation*, being his first political pamphlet, published in 1769, in answer to one variously ascribed to Fox or Grenville. In 1770, he published a pamphlet, *On the Cause of the Present Discontents*. On the 13th February 1788, he commenced his celebrated speech opening the trial of Warren Hastings (q. v.), the most remarkable trial, perhaps, in the history of the world. This speech lasted over four days, and has been characterised as 'a tempest of invective and eloquence.' No idea can be conveyed of the effect which it produced. The trial lasted seven years, and closed with another great and splendid oration from B., lasting over nine days. Hastings, it is well known, was acquitted. While this trial was advancing, B. found time to take part in all the current business. In 1790 appeared his *Reflections on the Revolution of France*, which sold in tens of thousands, and is said to have produced an effect never produced before nor since by any political essay. Hereafter, the world showered honours on B., of which space forbids even the enumeration. Having, in 1791, withdrawn from the Whigs on the French question, he offered for the consideration of government, *Thoughts on French Affairs*, which, however, was not published till after his death. *Heads for Consideration on the Present State of Affairs*, and *Reply to a Noble Lord*, next followed, the latter being relative to himself personally. His last work, *Thoughts on a Regicide Peace*, shewed that he retained to the end of his life his whole powers unimpaired.

Few men have been the subjects of higher panegyric than B., and, on the whole, few have better deserved praise. He was noble-minded, pure in his life, and a purist in politics. Intellectually, he was most richly endowed; with much imagination, rare powers of observation, and indefatigable industry, there was no subject which he could not master, and none which, having mastered, he could not expound with unparalleled richness of language. But with these virtues and powers were conjoined defects, which, without bating their greatness, largely neutralised their influence. He was, it may be said, too literary to be a philosopher, and too philosophic to be a politician. His career would seem to illustrate this position. His oratory astounded by its brilliancy rather than persuaded by its tone and argument; and in the long-run, the eloquence which failed to command the reason, ceased to captivate the ear. The man who at first evoked the enthusiasm of the House by the brilliancy and power of his eloquence, did actually at last empty it by persistence in the monotonous splendours of his speeches. Passionate, and in a great degree untractable, he was unsuited for party politics, and drifted from all his connections, breaking up slowly all party ties, and even the ties of friendship, till he reached at last a state of almost political isolation. At the same time, it must not be forgotten how great an influence he, half philosopher half politician, exercised on the counsels of the state; many of his views on politics and public economy were anticipations of science, as many of his previsions of the course of events were prophecies.

B. died on the 7th July 1797, in his 68th year.

A collected edition of his works in quarto was published in 1827. His life has been written by Dr Croly. More recently (1842), his works have been collected by Dr Henry Rogers, who has prefaced the collection by an able biographical and critical sketch.

BURKING. See ANATOMY (in Law).

BURLEIGH, WILLIAM CECIL, LORD. See CECIL.

BURLESQUE (from Ital. *burla*, jest, mockery), denoting a style of speaking, acting, writing, drawing, is a low and rude grade of the comic. The legitimate comic brings together contrasts with a final view to harmonising and reconciling them; the B. distorts and caricatures, and brings the incongruities into stronger relief. The farce is the B. of comedy. Deformities and monstrosities that excite disgust do not belong to the burlesque. The lofty and the abject, the great and the little are conjoined, with the sole view of exciting a laugh. Nor does the true B. turn real greatness and nobility into laughter, but only sham greatness—false pathos, and all hollow pretension and affectation. The B. style appears to have been unknown to the ancients; it originated among the Italians, more particularly with the poet Berni (q. v.). The genuinely national *buffone* of the Italians personates the burlesque. Carlo Gozzi, in his *tragi-comedies*, is perhaps the greatest in the B. vein. Scarron among the French, and *Hudibras* in English, are examples. Parody or travesty (q. v.) is a species of burlesque.

BURLETTA, a comic operetta or musical farce.

BURLINGTON, the name of two cities of some note in the United States.—1. A port of entry in New Jersey, on the Delaware, about twenty miles above Philadelphia, with which, as well as with New York, it is connected by the Camden and Amboy Railway. Here is an Episcopalian college, founded in 1846, which, in 1852, numbered 118 students. B. is in lat. 40° 5' N., and long. 75° 10' W., and has about 5000 inhabitants, with about 13,000 tons of shipping.—2. The most populous city in Vermont, containing about 8000 inhabitants, more than twice as many as Montpelier, the capital of the state. It is in lat. 44° 27' N., and long. 73° 10' W.; and is beautifully situated on the east shore of Lake Champlain, the ground gradually rising as it recedes from the lake. It communicates with the St Lawrence by means of the Richelieu River—the outlet of the lake—and its artificial substitute the Chambly Canal; while through the Champlain Canal it has access to the Hudson. It is connected also by railway with Montreal, Boston, and New York. The Vermont university crowns the slope on which the city stands, and commands an extensive view of the opposite coast of New York.

BURLINGTON. See BRIDLINGTON.

BURMAH, EMPIRE OF, called also the EMPIRE OF AVA, an important kingdom of the Indo-Chinese peninsula, formerly of great extent; but by two contests with the British power in India, it lost several provinces, and is now, in its widest sense and including tributary states, comprehended between 19° 29' and 28° N. lat., and 93° and 100° E. long., having an area of 157,500 square miles, and a scanty population estimated at about 3,000,000. It is bounded on the N. by lofty mountains, separating it from Assam and Tibet; on the E., by China; on the S., by the British province of Pegu; and on the W., by Munnipore and mountain-ranges dividing it from Tipperah, Chittagong, and Aracan. The Burman empire, as it now exists, has

three well-marked divisions: 1. Northern B., inhabited chiefly by Singphos, Shans, and other tribes; 2. B. Proper; 3. The Eastern Shan tributary states. The area of B. proper, from lat. 24° N. to the frontier of Pegu, is 44,450 square miles, with a population of about 1,200,000.

Physical features.—From the eastern extremity of the great transverse mountain-barrier of Northern India, longitudinal ranges strike away southwards, and between two of these the Burman territories are situated. The country slopes from the highland regions of the north towards the coast, and has been fitly described as 'a varied surface of rolling upland, interspersed with alluvial basins and sudden ridges of hill.'

The principal river, the Irrawaddy (q. v.), having its source amid the snowy mountains from which descends the Brahmaputra, is the great commercial highway of the country, through the heart of which it takes its course. Passing Amarapura, Ava, and other towns, it enters Pegu, and, 90 miles below Prome, divides into an eastern and western branch, the former flowing past Rangoon, the latter forming the Bassein river. The Kyen-dwen is its principal tributary. To the east of the Irrawaddy, the Salween, after an almost parallel course, enters the British territories in nearly the same latitude.

Climate.—On the coast, only two seasons are known—the dry and the rainy, which are regulated by the north-east and the south-west monsoons; but in B. proper, less rain falls, and there are three seasons—the cold, the hot, and the rainy. Some showers fall in May or June, but the great rains last from the middle of August to the end of October. The cool season is from the middle of October till the beginning of April, and from this month till the great rains is the hot part of the year, the thermometer ranging from 85° to 100°. The climate is, on the whole, healthy, but the jungles are very pestiferous.

Minerals.—B. has vast fields of mineral wealth, but little enterprise and capital are brought to bear upon them. There are gold mines at Bamo, near the Chinese frontier. Auriferous sand is found in many of the streams. Silver is obtained at Bau-dwen, likewise on the confines of China, and also in the Shan country, from whence comes the chief supply of lead. Iron is quarried at Poukpa, a lofty mountain a few miles east of Pagan. The celebrated ruby mines of B. are situated 60 or 70 miles north-east from the capital, and are jealously guarded. Sapphires of great size are found in the same stratum, but are more rare. The annual value of the gems is estimated at from £12,000 to £15,000 sterling, and they are the property of the king. Wells of the mineral oil, petroleum, are worked at Ye-nan-gyoung, on the Irrawaddy, above Prome. Marble, noble serpentine, and amber are likewise found in large quantities.

Vegetable productions.—A few only of the most striking of these can be noticed. Of the graceful palm-tribe (*Palmaceæ*), the cocoa-nut, the betel, the palmyra, and the nipa, or water-palm, are the most prized. The useful bamboo is widely diffused. The teak, of which B. possesses inexhaustible forests, and the hopœa, are amongst the most valuable of the timber-trees. Forests of pine grow to the eastward of Amarapura. The wood-oil tree is found on the higher Salween, one trunk of which will produce from 30 to 40 gallons of oil every season. The staple fruit of the country is the plantain or banana. The jack is prized by the natives. The mango reaches the height of 100 feet, and produces a delicious fruit. Rice, wheat, tobacco, indigo, and cotton are cultivated.

Animals.—The *Felidæ*, or cat family, abound,

tigers, leopards, and tiger-cats being met with in every part of the country. Of the *Pachydermata*, the elephant and rhinoceros are the most noteworthy. The elephant, buffalo, and Indian ox have been domesticated.

Ethnology.—The Burmans belong to that branch of the Mongolidae characterized by a monosyllabic language; they are short-headed, broad-skulled, and flat-faced. The hair is black, and the skin of a deep brown colour. Their *dress* is simple, but peculiar. The *in-gie*, a white linen jacket, is common to both sexes. Wrapped round the lower part of the body, the men wear the *put-so*, which is several yards in length; the women, the *te-mine*, a scant garment of cotton or silk. Silks, muslins, and valuable gold ornaments are worn on especial occasions. Betel-nut chewing and cigar-smoking are greatly practised by both men and women. The Burmans are, generally speaking, fine, well-made men, and excel in wrestling, boxing, rowing, football, and other athletic exercises; they are clever as carpenters and smiths. Burman houses are made of a framework of bamboo, thatched with the leaf of the water-palm, and are invariably raised on posts several feet from the ground. The women are more industrious than the men; they buy, sell, weave, and attend to the domestic concerns. Both sexes delight in merry-making, feasting, buffoonery, and sight-seeing. A *poogy*, or theatrical representation, is a very favourite amusement, and a buffalo-fight attracts crowds of spectators. The Burman has little patriotism, but is attached to his home. Without individual cruelty, he is indifferent to the shedding of blood by his rulers. Though temperate and hardy, he dislikes discipline and continued employment; and when in power, is too often arrogant, arbitrary, and corrupt.

Besides the true Burman, a great variety of races inhabit the Burman territories. The *Telains*, or *Moans*, descendants of the ancient Peguans, are pretty well amalgamated with the Burmans. The *Shans*, or *Tai*, perhaps the most numerous and widely diffused of the Indo-Chinese peoples, are scattered over the peninsula, from Munnipore to Bangkok. Of the eastern Shan states, some are tributary to B., others to Siam, while those west of the Irrawaddy are wholly under Burman rule. The *Singphos* cluster round the mountains of the north, and along the western mountain-boundary of Burmah, wild *Kybens*, and many tribes under different names, live in varying degrees of civilization. The *Karens* are met with chiefly in Southern Burmah.

Religion.—Buddhism (q. v.) is the prevailing religion of B., where it has been preserved in great purity. Its monuments, temples, pagodas, and monasteries, are innumerable; its festivals are carefully observed, and its monastic system is fully established in every part of the kingdom. While directing the reader to the special article on BUDDHISM for an account of its doctrines, history, &c., we may here glance at its development, institutions, and edifices among the Burmans.

The members of the monastic fraternity are known in B. as *pon-gyees*, meaning 'great glory'; but the Pali word is *rahm*, or holy man. The *pon-gyees* are not priests, in the usual acceptation of the term, but rather monks. Their religious ministrations are confined to sermons, and they do not interfere with the worship of the people. They are a very numerous class, living in monasteries, or *kyoungs*, and may at once be known by their yellow robes (the colour of mourning), shaven heads, and bare feet. They subsist wholly by the charity of the people, which, however, they well repay by instructing the boys of the country. The

kyoungs are thus converted into national schools. The vows of a *pon-gyee* include celibacy, poverty, and the renunciation of the world; but from these he may at any time be released, and return to a secular life. Hence, nearly every youth assumes the yellow robe for a time, as a meritorious act, or for the purpose of study, and the ceremony of making a *pon-gyee* is one of great importance. The ostensible object of the brotherhood is the more perfect observance of the laws of Buddha. The order is composed of five classes—viz., young men who wear the yellow robe and live in the *kyoungs*, but are not professed members; those on whom the title and character of *pon-gyees* have been solemnly conferred with the usual ceremonies; the heads or governors of the several communities; provincials, whose jurisdiction extends over their respective provinces; and, lastly, a superior general, or great master, who directs the affairs of the order throughout the empire.

No provision is made for religion by the government, but it meets with liberal support from the people. A *pon-gyee* is held in profound veneration; his person is sacred, and he is addressed by the lordly title of *pra* or *phra*; nor does this reverence terminate with his death. On the decease of a distinguished member, his body is embalmed, while the limbs are swathed in linen, varnished, and even gilded. The mummy is then placed on a highly decorated cenotaph, and preserved, sometimes for months, until the grand day of funeral. The Burman rites of cremation are very remarkable, but we cannot here enlarge upon them. On the whole, a favourable opinion may be passed on the monastic fraternity of B.; although abuses have crept in, discipline is more lax than formerly, and many doubtless assume the yellow robe from unworthy motives.

In B., the last Buddha is worshipped under the name of Gautama. His images crowd the temples, and many are of a gigantic size. The days of worship are at the new and full moon, and seven days after each; but the whole time, from the full moon of July to the full moon of October, is devoted by the Burmans to a stricter observance of the ceremonies of their religion. During the latter month, several religious festivals take place, which are so many social gatherings and occasions for grand displays of dress, dancing, music, and feasting. At such times, barges full of gaily-dressed people, the women dancing to the monotonous dissonance of a Burman band, may be seen gliding along the rivers to some shrine of peculiar sanctity. The worship on these occasions has been described by an eye-witness, in 1857, as follows: 'Arrived at the pagodas and temples, the people suddenly turn from pleasure to devotion. Men bearing ornamental paper-umbrellas, fruits, flowers, and other offerings, crowd the image-houses, present their gifts to the favourite idol, make their *shet-ho*, and say their prayers with all dispatch. Others are gluing more gold-leaf on the face of the image, or saluting him with crackers, the explosion of which in nowise interferes with the serenity of the worshippers. The women for the most part remain outside, kneeling on the sward, just at the entrance of the temple, where a view can be obtained of the image within.' On another occasion, we read: 'The principal temple being under repair, was much crowded by bamboo scaffolding, and new pillars were being put up, each bearing an inscription with the name of the donor. . . . The umbrellas brought as offerings were so numerous, that one could with difficulty thread a passage through them. Some were pure white, others white and gold, while many boasted all the colours of the

rainbow. They were made of paper, beautifully cut into various patterns. There were numerous altars and images, and numberless little Gautamas; but a deep niche or cave, at the far end of which was a fat idol, with a yellow cloth wrapped round him, seemed a place of peculiar sanctity. This recess would have been quite dark, had it not been for the numberless tapers of yellow wax that were burning before the image. The closeness of the place, the smoke from the candles, and the fumes from the quantity of crackers constantly being let off, rendered respiration almost impossible. An old pon-gyee, however, the only one I ever saw in a temple, seemed quite in his element; his shaven bristly head and coarse features looking ugly enough to serve for some favourite idol, and he seemed a fitting embodiment of so senseless and degrading a worship. Offerings of flowers, paper-ornaments, flags, and candles were scattered about in profusion. The beating a bell with a deer's horn, the explosion of crackers, and the rapid muttering of prayers, made up a din of sounds, the suitable accompaniment of so misdirected a devotion.

The rosary is in general use, and the Pali words *Aneitya! doka! anatta!* expressing the transitory nature of all sublunary things, are very often repeated. The Burman is singularly free from fanaticism in the exercise of his religion, and his most sacred temples may be freely entered by the stranger without offence; indeed, the impartial observer will hardly fail to admit that Buddhism, in the absence of a purer creed, possesses considerable influence for good in the country under consideration. Reciprocal kindnesses are promoted, and even the system of merit and demerit—the one leading to the perfect state of Nirvana, the other punishing by a degrading metempsychosis—has no doubt some moral effect.

The religious edifices are of three kinds: 1. The *pagoda* (*Zadee* or *Tsa-dee*), a monument erected to the last Buddha, is a solid, bell-shaped mass of plastered brickwork, tapering to the summit, which is crowned by the *tee*, or umbrella, of open iron-work. 2. The *temple*, in which are many images

of Gautama. The most remarkable specimen of Burman temple-architecture is the *Ananda* of Pagan. The ground-plan takes the form of a perfect Greek cross; and a tapering spire, with a gilded tee at the height of 168 feet from the foundation, crowns the whole. 3. The *kyoung* is generally constructed with a roof of several diminishing stages, and is often adorned with elaborate carved work and gilding. Burman architecture differs essentially from that of India in the frequent use of the pointed arch, not only for doors and windows, but also in the vaulted coverings of passages.

Cities.—Amarapura, the present capital of B., and seat of royalty, is built on a peninsula of the Irrawaddy, a few miles above Ava. It is laid out four-square, and bounded by a defensive wall of brick; the palace occupies the centre. Ava, for a long time the capital of the empire, has been for years almost a desert. Pagan represents the past of B., and is remarkable for its magnificent ruins of temple-architecture, extending over a space of 8 square miles; the prevailing type is the cruciform vaulted temple.

Government.—The government of B. is a pure despotism, life and property being at the mercy of the reigning sovereign. Many instances of the cruel abuse of arbitrary power, by even recent kings, might be given. The present monarch is, however, mild, approachable, and apparently desires the welfare and happiness of his subjects. The *Lot-dau*, or High Court of Council, is composed of the four *woon-gyees*, or principal ministers of state. The *atwen-woons*, or household ministers, are likewise four in number. They receive the royal commands, and are in close attendance upon the king. The *woon-douks* are a third order of ministers, and act as assistants to the *woon-gyees*. The decisions of the *lot-dau*, when sanctioned by the king, become law. The *Dam-a-that*, a Burman translation of the *Institutes of Menu*, is also in force. White umbrellas and white elephants are regarded as insignia of royalty. The 'Lord White Elephant,' indeed, is looked on as an estate of the realm, a mark of universal sovereignty, and a sacred being. It has a palace, a minister, and numerous attendants.—The

၆၇

သော်ဝင်: ဝိညာဉ်မသေနိုင်ကြောင်း ကို နှစ်သုံး သွင်း
 ကြဝါ ယော။ သင်တို့ ကိုယ် ခန္ဓာ သေသော နောက်၊
 ဝိညာဉ်သည် ချမ်းသာစွာ နေရအောင် အသဝံသာ ပြုရ
 မည်ကို၊ သရာဇိဘလီတောင်းပန် မေးမြန်း ရကြမည်။
 ငါသည် ဝဏ္ဏ်း သင်တို့ ဝိညာဉ် အကြောင်းကို၊ အခြား
 သာစာငယ် နှင့် ပြောကောင်း ပြောထေဦးမည်လှ။ သင်
 တို့၏ ဇိတ်ဆွေ ဖြစ်သော အမေရိကံ ဆရာ ဂတောဒကံ
 ပြော၍ နှလုံး ဆက်ပေ၏။

Specimen of Burmese Writing.

military power of the country is not great, and of musketeers it is probable that the king could not command more than 18,000.

The *civilisation* of B., if not retrograde—which the ruins of Pagan would almost seem to indicate—is stationary and stereotyped, like that of China. All the wealth of the country is lavished on religious edifices, £10,000 sterling being sometimes expended

on the gilding and beautifying of a single pagoda or temple, whilst roads, bridges, and works of public utility are neglected.

The *vernacular tongue* of B. belongs to the monosyllabic class of languages, and is without inflection; the character is formed of circles and segments of circles. It is engraved on prepared strips of palm-leaf, and a number of these form a book. Printing

is unknown except where introduced by the missionaries. *Pali* is the language of the religious literature.

Commerce.—Exports and imports, by way of Pegu, pay a duty of 10 per cent. at the British frontier custom-house, established at Thayet-myo. The principal exports (from B. Proper) consist of Sesamum oil, teak-timber, petroleum, sweet-oil, tobacco, lackered boxes, gold-leaf, silver, lead, copper, stick-lac, indigo, cocoa-nuts, &c.; ponies, wheat, pulses, and cotton, pass Thayet-myo duty free. The imports (into the Burman empire) are *ngapee* (a paste of rank pickled fish, which is eaten with rice, the staple food of the Burman), paddy, rice, dried fish, salt—all these being imported by thousands of tons annually. Cotton piece-goods, silk do., and woollens, pass free. The value of this trade up and down the river, for one year, from June 1, 1855, was £338,880. B. carries on likewise an overland traffic with China, the cotton of Ava being exchanged for the silk of the Celestial Empire.

The standard *currency* of B., called *ywet-ni* (red-leaf), is silver, but there is no coinage. This metal is used, however, of varying degrees of purity, which complicates mercantile transactions, and assayers are employed to find the value of the metal.

History.—Of the early and mythical history of B., nothing need here be said. The kingdoms of Ava and Pegu long contended for mastery. The latter was in its zenith in about 1580 A.D. Passing on to 1752, it appears that the Peguans, after a period of subjection, obtained the advantage. At this time, however, Alompra, or *Aloung Pra*, the most celebrated warrior-king in Burman history, rose to power, founded the present dynasty, subdued the Peguans, and incorporated their country, as well as many neighbouring states, with his own. The Burman empire attained its greatest expansion in 1822. The wars of 1822—1824 and 1852 with the British, have reduced the kingdom to its present contracted limits. See *Narrative of the Mission from the Governor-general of India to the Court of Ava*, 1855, by Captain Yule (Lond. 1858); Mason's *Natural Productions of B.*; Winter's *Six Months in B.* (Lond. 1858); Malcom's *Travels in the Burman Empire*; Missions of Symes, Cox, Canning, Crawford, and Burney to the Court of Ava, and personal observation.

BURMAH, BRITISH. The provinces composing this portion of the Anglo-Indian empire have all been wrested from the kings of Ava, and are as follow:

	Area in Square Miles.	Approximate Statement of Population.
Tenasserim Provinces (q. v.),	30,000	210,187
Martaban (q. v.),	3,800	76,000
Pegu (q. v.),	32,300	540,180
Arracan, or Aracan (q. v.),	10,700	362,797
	76,800	1,189,164

Of these, the Tenasserim provinces of Maulmain (or Amherst), Tavoy, and Mergui, together with Aracan, were ceded to the British government by the treaty of Yandaboo, signed on the 24th of February 1826, at the close of the first war with Burmah. Pegu and the province of Martaban were retained as compensation, after the war of 1852, and annexed to the British dominions by proclamation of the governor-general of India.

BURMANN, PETER, the most important member of a Dutch family celebrated for learning, was born at Utrecht 1668, studied law at the university of that city and of Leyden, and, after taking his degree in 1688, travelled through Germany and Switzerland. After practising as an advocate for some years, he was appointed professor of history and rhetoric in the university of Utrecht; which

office he subsequently exchanged for the professorship of Greek. In 1715, after the death of Perizonius, he removed to the university of Leyden, where he died 31st March 1741.

His literary career was very active, and his hot temper and intolerant spirit involved him in many controversies. Among his most distinguished adversaries were Le Clerc and Bentley. His chief works are editions of the Latin classics—Petronius, Velleius Paterculus, Quintilian, Valerius Flaccus, Phædrus, Ovid, the *Poëtæ Minores*, Suetonius, Lucan. The first of these appeared in 1709, and the last in 1740. They are characterised less by taste and critical acumen than by learning, fulness of matter, and beauty of type.

BURN, RICHARD, was born in 1720 at the village of Winton, in Westmoreland. After being educated at Queen's College, Oxford, he received the living of Orton, in his native county, which he continued to hold until his death in 1785. He is widely known as the compiler of two very useful law-books, the *Justice of the Peace* and *Ecclesiastical Law*, which have each passed through many editions. He also published a *History of the Poor-laws*, an edition of Blackstone's *Commentaries*, and several sermons and works of a religious nature.

BURNES, SIR ALEXANDER, a distinguished traveller in Central Asia, was born at Montrose, in Scotland, 1805, where his father, who was a cousin of Robert Burns the poet, was an active magistrate. He early entered the Indian army, and his knowledge of Oriental languages gained him rapid promotion. After performing some important missions for the Indian government, he was, at his own suggestion, sent on an expedition into Central Asia. Starting from Lahore on the 11th February 1832, B., having adopted the dress and usage of the Afghans for greater safety, passed through Peshawur and Cabul, and crossing the Indian Caucasus, reached Balkh on the 9th June. Thence he passed on to Bokhara, Astrabad, and Teheran, and journeying through Ispahan and Shiraz, reached Bushire on the Persian Gulf, from whence he embarked for India. He received the special thanks of the governor-general for his travels; and on his return to England in 1833, he received a warm welcome from the India House and Board of Control, and was highly honoured by the Royal Geographical and other societies. In September 1839, having previously, for his important services, been knighted and promoted to the rank of lieutenant-colonel, he was appointed political resident at Cabul, where he was murdered on the breaking out of the insurrection in that city in November 1841. B. was the author of several papers in the *Journal of the Geographical Society*, also of *Travels into Bokhara*, and of *Cabul*, being a narrative of a journey to and residence in that city, which was published after his death.

BURNET, the English name of two genera of plants, *Sanguisorba* and *Poterium*, belonging to the natural order *Sanguisorbeæ* (q. v.)—very generally regarded as a sub-order of *Rosaceæ*—which have much resemblance to one another, and receive a common name also in other languages. *Sanguisorba* has hermaphrodite flowers with four stamens; in *Poterium*, the flowers are polygamous, and the stamens indefinite in number. In both, the calyx is 4-fid, and the corolla wanting.—**GREAT B.** (*Sanguisorba officinalis*) is common in meadows in all parts of Europe, and not unfrequent in some parts of England, particularly where the soil is calcareous. It has a stem 1—2 feet high, pinnate leaves, with about four pair of ovate serrated leaflets and an odd one; the flowers are crowded in dark red spikes,

BURNET.

It is cultivated in Germany for feeding cattle, and is much esteemed for this use, as it grows well even

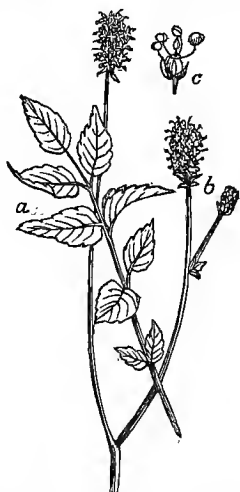

Great Burnet (*Sanguisorba officinalis*):
a, a leaf; b, spikes of flowers; c, a flower.

on very poor soils, and the produce is abundant. Cattle are very fond of it. The root is astringent, and was formerly used in medicine.—COMMON B. (*Poterium Sanguisorba*) grows in sunny places on hills in the middle and south of Europe, and is



Common Burnet (*Poterium Sanguisorba*):

common in England, especially in the chalk districts. In habit and foliage, it much resembles the Great B., but the leaflets are smaller, and the flowers are in heads of a dull purplish colour. It has been much cultivated in some parts of England as a substitute for clover on chalky soils, and is relished by cattle. It forms great part of the natural pasture of the South Downs, and of the excellent sheep-walks of Salisbury Plain. It is regarded as a plant particularly suitable for poor and soils. It is sometimes cultivated in gardens, and its leaves, which are slightly astringent, are used in salads or soups. They are said to form one

of the ingredients of the famous *cool tankard*, and the name *Poterium* is from a Greek word signifying a drinking vessel.—Both this and the preceding are perennial plants.—There are several other species both of *Sanguisorba* and *Poterium*, some of the latter shrubby, natives chiefly of the warmer temperate parts of the world.

BURNET, GILBERT, Bishop of Salisbury, was born at Edinburgh on the 18th September 1643. He was educated at home, and afterwards at Marischal College, Aberdeen, where he pursued his studies so diligently, that he took his degree of M.A. before he was fourteen. In the course of a year he made up his mind to enter the church, and read so hard at theology, that in less than three years he had mastered the chief systems of divinity, besides having gone over the Old and New Testaments in the original, with all the Commentaries of note in his time. In 1663, he visited Cambridge, Oxford, and London, where he met with many of the leading divines of England. Next year, he passed over into Holland, and perfected his knowledge of Hebrew under a learned rabbin of Amsterdam. In 1665, he was presented to the parish of Saltoun, where he remained five years. In 1669, he was appointed Professor of Divinity in the university of Glasgow, but having mixed himself up in the politico-ecclesiastical affairs of the time, he brought upon himself the enmity of Lauderdale, and found it prudent to resign his chair in 1674. He now removed to London, and was made preacher at the Rolls' Chapel by Sir Harbottle Grimston, and afterwards lecturer at St Clements. In 1676, he published his *Memoirs of the Dukes of Hamilton*, and in 1679, the first volume of his *History of the Reformation*, which procured him a vote of thanks from both Houses of Parliament. Next year appeared *Some Passages in the Life and Death of the Earl of Rochester*, in which B. records the religious interviews which he had with that profligate nobleman during his last illness, and which led to the latter's conviction of the truth of Christianity. In 1681, he published the second volume of his *History of the Reformation*, and in 1682, his *Life of Sir Matthew Hale*. The efforts which had previously been made, were now repeated, to induce him to break with the liberal and moderate party, and to attach himself to the king. He was offered the bishopric of Chichester, but refused it. In 1683, he narrowly escaped being brought into trouble in regard to the Ryehouse plot. He conducted the defence, attended the execution, and vindicated the memory of his friend Lord William Russell. The king exhibited his unkingly spite by depriving B. of his St Clements lectureship. On the accession of James II., he went to the continent, and travelled through France, Italy, Switzerland, and Germany. In 1684, he was introduced to the Prince of Orange, with whom he became a great favourite, and by whom he was frequently consulted in reference to the great scheme for the deliverance of England. When William came over, B. accompanied him in the capacity of royal chaplain, and shortly after, was appointed Bishop of Salisbury. He entered on the duties of his diocese with great ardour; but his first pastoral letter, in which he founded the right of William to the throne on conquest, gave so much offence to both Houses of Parliament, that they ordered it to be burned by the hands of the common hangman. William, however, who knew the excellent qualities of the bishop, was not greatly impressed by this solemn performance, and continued to trust B. to the end of his life. In 1698, B. was appointed preceptor to the Duke of Gloucester; in 1699, he published his celebrated exposition of the 39 Articles, which was condemned as heterodox by that not

very competent assembly, the House of Lords. In 1714, appeared the third volume of his *History of the Reformation*. In the spring of 1715, he was attacked by a pleuritic fever, and carried off on the 17th of March, in the 72d year of his age. B. was thrice married: his first wife was remarkable for her beauty; the second, for her fortune; and the third, for her piety.

Soon after B.'s death, appeared *Bishop B.'s History of his Own Time, from the Restoration of King Charles II. to the Conclusion of the Treaty of Peace at Utrecht, in the Reign of Queen Anne*. It was sarcastically but foolishly abused by the Tory writers of the day—Swift, Pope, Arbuthnot, and others. B. was a man of strict, almost of puritanic virtue; yet his charity, geniality, and moderation of sentiment might be imitated with advantage even in our own day. His style is neither elegant nor correct, and his judgment is not always reliable, yet the honesty, earnestness, simplicity, and vigour of his writings, as well as their fulness of details, make his works very valuable to the student of history.

BURNET, JOHN, a painter, engraver, and author, was born at Fisharrow, near Edinburgh, March 1784. He was first brought under the notice of the public through his engravings of Wilkie's works, which he executed in a most admirable manner. Of his own paintings, the best known engraving is that of 'Greenwich Pensioners receiving News of the Battle of Trafalgar.' He has written several works on art, illustrated by drawings and engravings of his own, the most important of which is a *Practical Treatise on Painting*. He is also the author of *Rembrandt and his Works*, 4to, 1849; and in conjunction with Mr Peter Cunningham, of the *Life and Works of J. M. W. Turner*, 4to, 1852.

BURNET, THOMAS, best known from his *Theory of the Earth*, was born in Yorkshire, 1635, and studied at Cambridge. After acting as travelling-tutor to several noblemen, he was elected Master of the Charter-house (1685), and later, succeeded Archbishop Tillotson as clerk of the closet to William III. But having (1692) published a work, *Archæologia Philosophica, sive Doctrina Antiqua de Rerum Originibus* (also in English), displaying great learning, but treating the Mosiac account of the Fall as an allegory, he was obliged to retire from the clerkship, and lived in the Charter-house till his death, in 1715. His *Telluris Theoria Sacra* (first part, 1680; second, 1689) was written in Latin, but translated, or rather recomposed in English, by the author. It is an ingenious speculation, written in ignorance of the facts of the earth's structure, and is therefore a mere system of *cosmogony*, and not geology. But it abounds in sublime and poetical conceptions and descriptions, conveyed in language of extraordinary eloquence, and called forth the highest applause at the time.

BURNETT PRIZES, THE, are two theological premiums, founded by Mr Burnett of Dens, Aberdeenshire. This gentleman (born 1729—died 1784) was a general merchant in Aberdeen, and for many years during his lifetime spent £300 annually on the poor. On his death, he bequeathed the fortune he had made to found the above prizes, as well as for the establishment of funds to relieve poor persons and pauper lunatics, and to support a jail-chaplain, in Aberdeen. He directed the prize-fund to be accumulated for 40 years at a time, and the prizes (not less than £1200 and £400) to be awarded to the authors of the two best treatises on 'The evidence that there is a Being all-powerful, wise, and good, by whom everything exists; and particularly to obviate difficulties

regarding the wisdom and goodness of the Deity; and this independent of written revelation, and of the revelation of the Lord Jesus; and from the whole to point out the inferences most necessary and useful to mankind.' The competition is open to the whole world, and the prizes are adjudicated by three persons appointed by the trustees of the testator, together with the ministers of the Established Church of Aberdeen, and the principals and professors of King's and Marischal Colleges, Aberdeen. On the first competition in 1815, 50 essays were given in; and the judges awarded the first prize, £1200, to Dr William Lawrence Brown, Principal of Marischal College and University of Aberdeen, for an essay entitled *The Existence of a Supreme Creator*; and the second prize, £400, to the Rev. John Bird Sumner, afterwards Archbishop of Canterbury, for an essay entitled *Records of Creation*. On the second competition, in 1855, 208 essays were given in; and the judges, Rev. Baden Powell, Mr Henry Rogers, and Mr Isaac Taylor, awarded the first prize, £1800, to the Rev. Robert Anchor Thompson, Lincolnshire, for an essay entitled *Christian Theism*; and the second prize, £600, to the Rev. Dr John Tulloch, Principal of St Mary's College, St Andrews, for an essay on *Theism*. The above four essays have been published in accordance with Mr Burnett's deed.

BURNETT'S DISINFECTING LIQUID AND ANTISEPTIC FLUID is a liquid introduced by Sir W. Burnett for the purpose of deodorising the bilge-water of ships, sewerage-water, &c. It is a strong solution (sp. gr. 2) of chloride of zinc, accompanied by a small amount of chloride of iron; and when intended to be used, it is mixed with water in the proportion of one pint to five gallons of water. The liquid acts only as a *deodoriser* and *antiseptic* (see ANTISEPTICS), and does not yield any vapour which can exhibit the properties of a disinfectant (q. v.). It is of service in preserving dead animal tissues, as in the dissecting-room, and in jars containing anatomical specimens. It has little action on knives or steel instruments. When added to bilge or sewerage-water, the chloride of zinc (ZnCl) mainly acts by decomposing the offensive sulphide of ammonium (NH₄S), which it does by forming the sulphide of zinc (ZnS) and chloride of ammonium (NH₄Cl), both of which are odourless. The strong solution of chloride of zinc has also been applied to the preservation of timber, and the process of so treating wood is called, after its inventor, *Burnettising*. *Crewé's* disinfectant liquid is chemically the same as the above.

BURNEY, DR CHARLES, a musical composer, celebrated as the author of the *General History of Music*, was born at Shrewsbury, 1726. Having studied music in his native city, in Chester, and under Dr Arne in London, he commenced giving lessons in music himself. After composing three pieces—*Robin Hood*, *Alfred*, and *Queen Mab*—for Drury Lane, B. left London, and settled at Lynn, in Norfolk, where he designed his work on the *History of Music*. In 1770—1772, he travelled in France, Italy, the Netherlands, and Germany, collecting materials for his proposed work, and published an essay on the *Present State of Music in France and Italy*, &c. (2 vols., Lond. 1772). This was followed by his *General History of Music from the earliest Ages to the present Period* (4 vols., Lond. 1776—1789). Beside other minor works, B. wrote a *Life of Handel*, and nearly all the musical articles in *Rees's Cyclopaedia*. He was appointed organist to the Hospital at Chelsea in 1789. He died in 1815. He was intimately acquainted with many of the most eminent men of the day, including Edmund

Burke and Dr Johnson.—His second daughter, FRANCISCA B. (afterwards Madame D'Arblay), became distinguished as authoress of *Evelina*, *Cecilia*, *Georgina*, and *Camilla*—novels formerly very popular, and still retaining some interest.

BURNING GLASSES AND MIRRORS. See LENS, and MIRROR.

BURNLEY, a thriving town in Lancashire, situated in a narrow vale on the banks of the Brun, a mile and a half above its junction with the North Calder, and 24 miles north of Manchester. Pop. now upwards of 30,000. It has manufactures of cottons and woollens, calico-printing works, iron and brass foundries, machine-making works, breweries, tanneries, and rope-works. Its prosperity greatly depends on the collieries in the vicinity, and traffic is facilitated by railways and canals, which unite it with the principal centres of trade in Lancashire and Yorkshire.

A Roman vicinal way passed through the town, part of which is still known and used as the 'Long Causeway.' Roman coins, pottery, urns, &c., have been found near the town, and an extensive series of beacons, encampments, dikes, &c., occupy the slopes of the hills in the neighbourhood for a linear distance of more than 10 miles. From the name of the river, *Brun*, and other circumstances, these slopes are supposed to furnish a very probable site for the battle of Brunanburh, so celebrated in Saxon history.

BURNOUF, EUGENE, one of the most distinguished orientalist of modern times, was born at Paris, April 1, 1801, and after entering on the study of law, betook himself to the oriental languages, especially those of India and Persia. In conjunction with Professor Lassen of Bonn, he published, in 1826, *Essai sur le Pali*, which was followed, in 1827, by *Observations Grammaticales sur quelques Passages de l'Essai sur le Pali*. His great aim, however, at this time, was to obtain a complete knowledge of the remains of the religious literature in the Zend, or old Persic language, which had been neglected since the time of Anquetil du Perron, or, at least, not philologically and critically examined. B. undertook to decipher those curious MSS. which Anquetil du Perron had brought home with him, and which lay unregarded in the *Bibliothèque Imperiale*. He commenced by causing the *chef-d'œuvre* of old Persic literature, the *Vendidad-Sadé* (one of the books of Zoroaster), to be lithographed with great care, and published from time to time in the *Journal Asiatique* the brilliant results of his laborious studies, which drew upon him the regard of the learned world. In 1834, he published the first volume of his *Commentaires sur le Yaçna l'un des Livres Liturgiques des Perses*, a work which, for the first time, rendered possible a knowledge not only of the dogmas, but also of the language of Zoroaster. It is a master-piece of conscientious industry, united with copious lingual and antiquarian lore. His studies in the Zend language induced him to make an attempt to decipher the cuneiform inscriptions of Persepolis, in his *Mémoire sur deux Inscriptions Cunéiformes* (Par. 1836). In 1840, he published the text along with a translation of the *Bhâgavat-Purâna*, a system of Indian mythology and tradition. As the fruit of his study of the Sanscrit books of the Buddhists, appeared in 1845 the *Introduction à l'Histoire du Bouddhisme*. See **BUDDHISM**. This great work absorbed for six years the whole energies of B., who was now recognised as the worthy successor of Silvestre de Sacy. It is to be regretted that death did not permit this illustrious orientalist to continue his labours further. He died May 28, 1852.

BURNS, ROBERT, the great lyric poet of Scotland, was born 25th January 1759, in a small cottage near Ayr. His father, then a nursery-gardener, and afterwards the occupant of a small farm, had to struggle all his life with poverty and misfortune, but made every exertion to give his children a good education; and the young poet enjoyed an amount of instruction and miscellaneous reading which, to those unacquainted with the habits of the Scottish peasantry, would seem incompatible with the straitened circumstances and early toil which were his lot. About his sixteenth year, he began composing verses in the Scottish dialect, which attracted notice in the vicinity, and extended the circle of his acquaintance; and thus he became exposed to temptations which, acting on an extremely sociable and passionate disposition, broke in upon the previous sobriety and correctness of his life. A small farm, on which he had entered with his brother in 1781, proved far from a prosperous undertaking; and being harassed and embittered by other misfortunes—the results of imprudence—he resolved to leave his native land, and go to Jamaica. Partly to procure the means of paying his passage, he published a collection of his poems at Kilmarnock in 1786. The reception these met with was highly favourable, and his genius was recognised in quarters where he had not looked for notice. While preparing to embark, he received a letter encouraging him to go to Edinburgh, and issue a new edition. This was the turning-point of his life. During his stay in the Scottish metropolis, he associated with all that was eminent in letters, rank, and fashion, and his conversational powers excited little less admiration than his poetry. The profits of the publication were considerable, and enabled him to take the farm of Ellisland, near Dumfries, where he settled in 1788, having publicly ratified his marriage with Jean Armour. With his farm he conjoined the office of an exciseman; but after three or four years, he was obliged to give up farming, and from that time lived in Dumfries, dependent on his salary from the Excise, which, at first, only £50, never rose above £70. The striking contrasts in the lot of the rich and the poor with which his residence in Edinburgh had impressed him, made him hail the French Revolution with enthusiasm; and some imprudent expressions of his having been reported to the authorities, destroyed his prospects of promotion in the service, and only the interference of an influential friend prevented him from losing his office. Such was then the terror of innovation, and the hatred of everything like liberal opinions, that many of the better classes, who had fettered the poet, now shunned the 'Jacobin,' as they stigmatised him. Imbittered by what he felt to be injustice, he recklessly allowed those habits of dissipation to grow upon him which made the more respectable of all classes look coldly on him; and the remorse thus occasioned in his calmer moments aggravated that tendency to melancholy which the gloom and toil of his early years had probably implanted in his constitution. Broken in health, he died 21st July 1796.

The poetry of B. is purely the outpouring of the moment—the response of the feelings to the immediate circumstances of life. Its charm and power lie in the justness of the feelings expressed, and in the truthfulness and freshness which it derives direct from life. Seldom have such manliness, tenderness, and passion been united as in the songs of Burns. They formed the first awakening of the spirit of true poetry in Britain after a long slumber. The popularity that B. instantly acquired has continued unabated, not only in his native Scotland, but wherever English is spoken; his poems

have also been translated into almost every European tongue. Dr Currie, of Liverpool, published the first collected edition of his poems and letters, with a life (4 vols. Lond. 1800), for the benefit of the poet's widow and family. Several more complete collections have appeared since, of which that by Allan Cunningham, in 8 vols. (Lond. 1834), may be mentioned. A life of B., by Lockhart, appeared,

Edin. 1828. In *The Life and Works of Burns* (Edin. 1851-2), by R. Chambers, the poems are incorporated in the narrative in chronological order.

In 1859, the centenary of B.'s birth was celebrated with unparalleled enthusiasm, not only in every city and almost in every village of Scotland, but in the chief cities of England, and throughout America, the British colonies, and India.

God bless you!
 Robt Burns

Autograph of Burns.

BURNS AND SCALDS are injuries to the surface of the living body arising from excessive heat—a scald implying that the heat proceeded from a fluid medium, as boiling water; a burn, from a solid. The injury is much the same in both cases; therefore the directions for the treatment of burns will be applicable also to scalds. These injuries may be divided into three classes: 1. Burns resulting in simple redness of the skin; 2. Burns resulting in vesication or blistering; 3. Burns resulting in sloughing, or death of the part. The first object, after the accident has occurred, is to relieve the suffering; and cold applied either in the form of ice or water seems in most cases to have almost a specific power in allaying pain and checking the advance of inflammation. In other cases, moderate warmth is found more efficacious, and we must be guided mainly by the sensations of the sufferer as to which of these remedies we make use of. In very severe cases, opium or chloroform may be employed. But if the injury the body has received be very serious, the patient complains less of pain than of cold; he shivers, is much depressed, and must be well supplied with stimulants, to prevent his dying from the shock.

The best local application is the Carron-oil, which derives its name from the famous ironworks, where it has been used for many years. It consists of equal parts of olive-oil and lime-water, and should be applied on linen rags or cotton-wool. Blisters may be pricked, and the contained serum allowed to trickle away, but on no account is the raised skin to be removed. The dressings should not be changed oftener than cleanliness requires; and as each portion of the old dressing is removed, it must at once be replaced with fresh, so that as little exposure as possible of the burnt surface may take place. The main principle of treatment is exclusion of the air from the injured part; and so long as this is effected, it matters but little what remedial agent is employed. Great care must be taken in the treatment of a sore resulting from a burn, that the contraction of the scar does not cause distortion of the neighbouring parts.

When the clothes catch fire, the person should lie down on the floor, and roll herself, or be rolled, in the rug, table-cover, or anything sufficiently voluminous to stifle the flames; and afterwards the clothes, especially stockings, should be removed with great care, lest the cuticle should separate with them, which would materially increase the sufferings of the patient.

Extensive scalds or burns are very fatal to young children; and it must be remembered that their skin is more susceptible to external impressions, and will suffer from a degree of heat innocuous to an adult. Infants have frequently been scalded to death in too hot baths, or by too hot fomentations. The principles of treatment for burns produced by the contact of chemical agents to the skin, are the same as those for burns by fire.

BURNT OFFERING. See SACRIFICE.

BURNT SIENNA, a fine orange-red pigment, transparent and permanent, used both in oil and water colour painting. It is obtained by simply burning the ferruginous ochreous earth known as Terra di Sienna. Excellent greens are produced by mixing it with Prussian blue. It mixes well with other pigments generally, and dries quickly.

BURNT STONES, antique carnelians found in ruins, and seeming to have been acted upon by fire, having a dull appearance externally, but exhibiting a beautiful-red colour when held up to the light. They are sold at a very high price, particularly if to the natural beauty of the stone is added the merit of fine workmanship. They were once, however, more esteemed than now, and an imitation of them, by burning the upper surface of carnelians with a hot iron, was very fashionable.

BURNT UMBER, a pigment of a russet-brown colour, is semi-transparent, mixes well with other pigments, and dries quickly. It is obtained by burning umber, an ochreous earth containing manganese, and deriving its name from the place where it was first discovered—Umbria in Italy.

BURNTISLAND, a seaport town of Fifeshire, on the north shore of the Firth of Forth, about 8 miles north-north-west of Edinburgh. It consists of one long street, clean and well kept, with a back street running parallel, and some diverging lanes. B. is a station on the Edinburgh, Perth, and Dundee Railway, a steam-boat ferry connecting it with Granton, the station on the opposite side of the Forth. It has a commodious harbour on the west. Its trade consists principally of distilling, fisheries, and herring-curing; and in the summer season it is now considerably resorted to as a convenient watering-place. It unites with Kinghorn, Dysart, and Kirkcaldy to send one member to parliament. Pop. (1851) 2724.

BURRIANA, a town of Spain, in the province

of Castellon-de-la-Plana, about 8 miles south from the town of that name, is situated on the left bank of the Rio Seco, about 1 mile from its mouth in the Mediterranean. It has a population of 6200, who are chiefly engaged in agriculture and fishing; and exports wine, oil, and fruit.

BURRITT, EMU, a distinguished advocate of the doctrines of the Peace Society, and widely known as 'the learned blacksmith,' was born at New Britain in Connecticut, United States, in 1811. He was brought up to the trade of a blacksmith; but devoted all his leisure to study, especially to mathematics and languages. In the latter field of study, his range has been very wide, embracing more or less Latin, Greek, Hebrew, Arabic, and other oriental tongues, and almost all modern European and Slavonic languages. He is, however, much better known to the world as an earnest apostle of peace than as a scholar. To preach the doctrine of 'universal brotherhood,' he has travelled through the United States and a great part of Europe. His chief works are, *Sparks from the Anvil*, *A Voice from the Forge*, and *Peace Papers*. He has taken a prominent part in the Peace Congresses of Brussels, Paris, Frankfort, London, and Edinburgh; and is an eloquent advocate of an ocean penny-postage. He has edited many journals promoting peace-views; and his tracts have been translated into all the languages of Europe.

BURSARY (Fr. *bourse*, Lat. *burra*, a purse), a stipend paid to a student at a university, being generally the annual proceeds of a bequest, permanently invested for that purpose. The bursaries of the Scottish universities correspond very nearly to the scholarships (q. v.) of the English. They are more numerous in Aberdeen than in any of the other universities; and, what seems strange, considering the antiquity and dignity of the foundation, they are least numerous at St Andrews, and smallest in amount. At King's College, Aberdeen, there were, at the date of the report of the University Commission of 1831, 134 bursaries, being one to every third student; and at Marischal College, there were 106, being more than one to every third student, taking the divinity students who attend both colleges as included in the number attending King's College. The amount of these provisions is, in general, very small. At King's College, none exceed £50 a year, and the highest at Marischal College is £26, whilst in both there are several which do not exceed £5, and, at Marischal, eight which are under £5. At Glasgow, at the same date, there were 71 bursaries, exclusive of ten exhibitions to Balliol College, Oxford, on the Snell Foundation (q. v.), and four smaller ones to the same college on that of Bishop Warner. The ordinary bursaries at Glasgow range from £50 to £5. At St Andrews, there are 55 bursaries, the highest being £25, and the lowest £5. At Edinburgh, though not numerous in proportion to the attendance—only 80 in all—the bursaries are somewhat better; three of them being worth £100 a year each. Many of these bursaries were destined for the education of persons bearing particular names, and, till the report of the Commission of 1831, few of them were disposed of by competition. Since that period, this system has been adopted in almost every case in which it is not expressly excluded by the conditions of the bequest.

As very extensive changes, both in the number and mode of disposal of these endowments, are likely to result from the labours of the existing University Commission (1860), it is needless to dwell on the details of the present arrangements with regard to them. But the opinions expressed on the subject

by the former commissioners may not be without interest at the present time, as indicating the direction which it is not impossible that the reforms of their successors will take. 'We entertain,' they say, 'very strong apprehensions that the laudable object which it is proposed to promote by such bequests, has not been very satisfactorily or usefully accomplished, and that the number of small bursaries has been attended with consequences very prejudicial to the interests of the universities. The number of bursaries is greatly beyond the proportion necessary for the encouragement of extraordinary merit, or to provide for individual cases of unusual poverty and hardship. It is completely proved that many are attracted to the university in the hope of obtaining a bursary, and are induced to continue their attendance without any natural turn for any of the learned professions. It appears that some of these persons are at last left in the most distressing of all situations—disqualified for the occupations in which they might otherwise have been employed, and unable to turn to any account the education which they have received in the university. Under such circumstances, many are induced to direct their views to the church, and very painful instances have been mentioned to us of their occupations and condition in after-life.' The opinion is gaining ground, that what is wanted in Scotland is not so much provision for encouraging learning in its earlier stages, as adequate inducements to persons who have passed the preliminary stages to make it the business of their lives; and that donors to the universities would do much more for the advancement of education by the foundation of fellowships than of bursaries.

BURSLEM, a town of Staffordshire, on the Trent and Mersey Canal, in the centre of the pottery district, 20 miles north of Stafford. Part of the town stands on a height, and part on low ground, filled up and raised considerably by the refuse of the local manufacture. The footpaths are mostly paved with blue bricks. It forms a portion of the parliamentary borough of Stoke-upon-Trent. Pop. 19,725. The abundance of coal and the variety of clays, both of which are essential to the manufacture of porcelain and earthenware—especially for the production of saggars, in which those goods are passed through the kilns—have made B., since the 17th c., one of the chief seats of the fictile manufacture. The native clays are also used in making fine articles of *terra cotta*, and coarse ones for kitchen utensils, of a red, yellow, and brown colour. There is also a glass manufactory here. The affairs of the town are managed by a 'local Board of Health.' At Birche's Head, a mile and a half from B., stands a large service reservoir of the Staffordshire Water-works Company, from which the town and neighbourhood are supplied with excellent water. B. was the native place of Josiah Wedgwood, who in the middle of the 18th c. greatly improved the manufacture of pottery.

BURTON, JOHN HILL, advocate (member of the Scottish Bar), has achieved for himself a place in the world of letters by a variety of works, all remarkable for ability, and several for original thought. B. was born at Aberdeen on the 22d of August 1809; his father was an officer in the army, and his mother the daughter of an Aberdeenshire laird. Having graduated at Marischal College, Aberdeen, he became an apprentice to the profession of law in his native city; which, however, he afterwards abandoned for the higher sphere of the Edinburgh bar. Here, with time on his hands, he devoted himself to study and letters. For a long series of years, from 1833 downwards, he was a contributor to the *Westminster Review* of articles on

law, history, and political economy; and for several years he has contributed to *Blackwood's Magazine* literary sketches, among which may be mentioned the series entitled *The Scot Abroad*. Among his original works may be mentioned, *The Life and Correspondence of David Hume*, 2 vols. 8vo (Edin. 1846); *Lives of Simon Lord Lovat and Duncan Forbes of Culloden*, 8vo (Lond. 1847), both excellent biographies; *Political and Social Economy*, 16mo (Edin. 1849), a work in which he has shewn high capacity for economical and social speculation, and which is indeed a valuable, condensed, and lucid contribution to the literature of social science; *Narratives from Criminal Trials in Scotland*; *A Manual of Scottish Law*; *A Treatise on the Law (Scottish) of Bankruptcy*; and *A History of Scotland from the Revolution to the Extinction of the Last Jacobite Insurrection*, 2 vols. 8vo (Lond. 1853). He is now occupied (1860) with *The History of Scotland from the Earliest Period to the Revolution of 1688*. The high merits of his *History* already published have been universally admitted. Besides the numerous works already mentioned, B. has among his other labours edited the works of Jeremy Bentham (nominally in conjunction with Dr, now Sir John, Bowring), with an able introduction; in addition to this, he has the merit of having conferred a benefit at once on the public and the memory of his author by a volume of *Benthamiana*, being a collection of choice and leading passages from Bentham's works, illustrative of his style, and explanatory of his doctrines, accompanied by a memoir (prefixed), and view of Bentham's system (appended). As a reward for his indefatigable labours in the fields of law, history, and politics, B. was, in 1854, appointed secretary to the Prison Board of Scotland.

BURTON, ROBERT, author of the *Anatomy of Melancholy*, was born at Lindley, in Leicestershire, in 1576, and studied at Brasenose and Christ Church, Oxford. In 1616, he was appointed to the vicarage of St Thomas, and in 1628, to the rectory of Segrave in his native county. He appears, however, to have continued all his life at Christ Church, where he died in 1640, leaving legacies of £100 each to the Bodleian and Christ Church libraries, and as many of his books as they did not already possess. A monument was erected to his memory in Christ Church Cathedral. B. is described by Anthony Wood as a good mathematician, a dabbler in nativities, a well-read scholar, and a thorough-paced philologist. 'As he was by many accounted a severe student, and a melancholy and humorous person, so by others who knew him well, a person of great honesty, plain-dealing, and charity. I have heard some of the ancients of Christ Church often say that his company was very merry, facetie, and juvenile.' His *Anatomy of Melancholy*, in which he appears under the title of Democritus Junior, is one of the most curious *melanges* of heterogeneous elements ever put together. It consists mainly of an extraordinary mass of quotations from old and obscure writers, strung on a thread of rambling reflection; often tiresomely pedantic, but relieved by quaint touches of humour and feeling. In his own lifetime, it was highly popular, and went through five editions; after that, it fell into comparative oblivion, but is now again popular among lovers of quaint literature. Dr Johnson said it was the only book that ever took him out of bed two hours before his usual time.

BURTON-ON-TRENT, a town in Staffordshire, 21 miles east of Stafford, on the Trent. Pop. 7934. The Grand Trunk or Trent and Mersey

Canal passes B. and, a mile below the town, enters the Trent, which flows into the Humber. The Trent here is crossed by a freestone bridge of 36 arches, and 1545 feet long, built before the Norman Conquest. In the 11th c., the Earl of Mercia founded an extensive abbey here, some of the abbots having seats in parliament. B. was once celebrated for its alabaster works, and is now noted for its ale. Bass, Allsopp, Worthington, and several other large brewers of bitter ale have their premises here. In the manufacture of this ale, hard-water instead of soft is used.

BURTSCHIED, or **BORCE/TTE**, a town of Rhenish Prussia, about half a mile distant from Aix-la-Chapelle, with which it is connected by an avenue of trees. It has manufactures of woollen cloths and cassimeres, and celebrated sulphur springs and baths, with a temperature of 106° to 155° F. Pop. 6000.

BURWHA, or, as Dr Barth spells it, **BARUWA**, a town of Bornu, Central Africa, situated on the west bank of Lake Tsad, about 80 miles north-north-west of Kuka. The town, which consists of closely packed huts, is surrounded by high clay-walls, which, however, 'owing to the high mounds of rubbish imbedding them on all sides,' afford no protection whatever from the attacks of the Tawarek, to whom the inhabitants have to pay tribute. Fish in great quantities are caught in the adjoining lake, and form the chief food of the inhabitants, as well as their only article of commerce. Pop. about 6000.

BURY, a flourishing manufacturing town in the south-east of Lancashire, on a rising ground backed by hills on the north and east, between the Irwell and the Roche, 9 miles north-west of Manchester. It was early a seat of the woollen manufactures, carried on by Flemings, but these now yield in importance to those of cotton. Besides spinning and weaving factories, there are important print, bleach, paper, and dye works, and some large foundries. In the vicinity, are excellent freestone quarries, and abundant coal-mines. The town has been much improved of recent years, and is respectably provided with educational and literary institutions. Pop. 31,262. B. returns one member to parliament. There once stood a castle here, which was besieged by the parliamentary forces in 1644. Some improvements in the cotton manufacture arose here—viz., the invention by John Kay of the fly-shuttle, which is thrown by the picking-peg instead of the hand; and that of the drop-box, by his son, Robert, whereby the weaver can use at will any one of three shuttles, so as to produce a party-coloured fabric. The late Sir Robert Peel was born in B., where his father established his great print-works.

BURY ST EDMUNDS, or **ST EDMUNDS-BURY**, an ancient borough in Suffolkshire, on the Upper Larke, 26 miles north-west of Ipswich. It is well built, and delightfully situated. Pop. 13,900. It returns two members to parliament. The guildhall is built of flint and freestone. It has a botanic garden. It has a trade in wool, butter, corn, and cheese, but no manufactures. It received its name from Edmund, the Saxon king and martyr, who was crowned here on Christmas Day, 856; taken prisoner, and put to death by the Danes, and soon after canonised. On the site of his tomb, six priests founded a monastery; and here Canute raised a Benedictine abbey—505 feet by 212, with 40 chapels, churches, cloisters, &c.—which in time became the richest and most important in England, save that of Glastonbury. From 1020 to its dissolution by Henry VIII., it was ruled

BURYING BEETLE—BUSCHING.

over by a line of 33 abbots. The abbot was a spiritual baron of parliament, had judicial authority in all causes within the liberty of B., had the power of inflicting capital punishment, and the privilege of coining. At the dissolution, the annual income was equivalent to £50,000 of our money. Of this magnificent establishment, little now remains but the western gate, erected in 1327, a noble relic of the decorated Gothic style; and the 'Church-gate,' a quadrangular tower of massive simplicity, 86 feet high. The churchyard, to which this tower formed the portal, includes, besides the abbey ruins and some other buildings, the fine old churches of St Mary and St James, the first containing the tomb of Queen Mary of France. It has a fine avenue of tall lime-trees. The celebrated grammar-school of B. was founded by King Edward VI. in 1550, and is free to sons of the inhabitants of the town. It has two annual exhibitions to the universities, and has produced many eminent scholars. Among the many religious and charitable institutions connected with the abbey, of which portions still exist, is St Saviour's Hospital, founded by that notable abbot, Samson, whose life and actions, as recorded by Jocelyn of Brakelond, Mr Carlyle has so vividly recalled in his *Past and Present*. The poet Lydgate was a monk in this abbey; and Sir Nicholas Bacon was born here. At B., King John first met his indomitable barons before he signed Magna Charta. Parliaments were held here in 1272, 1296, and 1446, the last of which ordered the arrest of Humphrey, the good Duke of Gloucester, who was found dead in his bed the morning after his arrest; and sovereigns, as late as Elizabeth's time, were often nobly entertained at St Edmund's town. Three miles south-west of B., the Marquis of Bristol has a splendid seat, Ickworth Park, a circular pile 90 feet in diameter, and 140 feet high, with grounds 11 miles in circuit.

BURYING BEETLE (*Necrophorus*), a genus of Coleopterous (q. v.) insects, of the tribe or family *Silphales*, with short club-shaped antennæ, remarkable for their habit of burying the bodies of mice,



Burying Beetle.

moles, and other small animals, in order to deposit their eggs in them, and to provide a supply of food for their larvæ. Some of the species are natives of Britain, among which is *N. Vespillo*, the species of which the habits were first observed, which is, however, more common in some parts of continental Europe. It is a black beetle, about an inch long, with two bright orange bands across its back, and having an excessively fetid smell, which long adheres to whatever it touches. Its sense of smell would seem to be extremely acute, and a dead animal soon attracts it, a pair generally arriving together, male and female, to feed upon the body, and the male to proceed to its interment, if sufficiently small, previous to which, however, they

have sometimes to drag it to some distance to a place suitable for their purpose. The head of the insect is the only tool employed in the operation, and is held sloping outwards, and employed in a manner which exhibits great muscular power. A furrow is first made around the body, then another within the first, and so on till the earth is so excavated from beneath, that the body begins to sink, when the insects, by great efforts, drag it down into the hole, and when it is fairly in, the excavated earth is thrown back over it. The female then lays her eggs in it; and when this is accomplished, and the cravings of appetite are satisfied, it is left for the larvæ, which are of a lengthened form, with six feet, whitish, and a brown head.—The known species of B. B. are mostly natives of Europe and of North America.

BUSACHINO, or **BUSAQUINO**, a town of Sicily, in the province of Palermo, about 29 miles south-south-west of the city of that name. It has manufactures of linen, and a population of 8100.

BUSA'CO, a ridge or serra on the north side of the river Mondego, in the province of Beira, Portugal, about 20 miles north-north-east of Coimbra. Here Wellington, with about 40,000 British and Portuguese troops, repulsed the attack of Massena with 65,000 French, 27th September 1810. Unable to force the position, Massena turned it by a pass over an adjoining ridge, and Wellington retired behind the lines of Torres Vedras, which indeed it was his intention to do, even if there had been no battle.

BUSBY, RICHARD, the most famous of English schoolmasters, was born at Lutton, Northamptonshire, September 22, 1606. Educated at Westminster School, and Oxford, he was, in 1640, appointed headmaster of Westminster School, the duties of which office he continued to discharge until his death in 1695. He is the type of pedagogues alike for learning, assiduity, and the application of the birch. He was a most successful teacher, and at one time could point to no less than sixteen occupants of the bench of bishops who had been educated in his school; and altogether, he has the reputation of having 'bred up the greatest number of learned scholars that ever adorned any age or nation.' He published several works, but they were chiefly for school use.

BU'SCA, a town of Piedmont, situated on the left bank of the river Maira, an affluent of the Po, about 9 miles north-west of Coni. Excellent wine is produced in the vicinity. Pop. 9375.

BÜSCHING, ANT. FRIEDR., a celebrated geographer, was born 27th September 1724, at Stadt-hagen, in the principality of Schaumburg-Lippe, Germany. He studied theology at Halle, where he enjoyed the friendship of Baumgarten. In 1754, he was appointed extraordinary professor of philosophy in Göttingen, but soon incurred the displeasure of the Hanoverian government by his religious heterodoxy. Göttingen thus becoming an unpleasant residence to him, he accepted an invitation, in 1761, to St Petersburg as preacher to a Protestant congregation there. In 1765 he returned to Germany, and in 1766 was called to Berlin as Upper Consistorial Councillor and Director of a *gymnasium* in Berlin, where he died, 28th May 1793. Until the appearance of B.'s *Erdbeschreibung*, the first volume of which was published at Hamburg in 1754, neither Germany nor any other nation possessed a geographical work which made any pretension to scientific treatment or completeness of execution. The changes in the political arrangements of the world have, however, deprived the work of its original value, but it has been corrected and edited

by subsequent writers. Of his other numerous publications, the most important is the *Magazin für Historie und Geographie* (25 vols. Hamburg, 1767—1793).

BUSEMBAUM, HERMANN, a theologian of the order of the Jesuits, was born in 1600 at Nottelen, in Westphalia. About 1640, he taught ethical philosophy at Cologne, and later, was appointed rector of the College of Jesuits at Münster. He died 31st January, 1668. His work entitled *Medulla Theologiae Moralis* (1645), was celebrated as a standard authority in the seminaries of the Jesuits, though several of its propositions were condemned by the pope. It has gone through more than fifty editions. It was enlarged by the Jesuit Lacroix (1707), and re-edited, with improvements and additions, by the Jesuit Montausan in 1729, and again by Alfonso de Ligorio in 1757. As it was found that the work contained doctrine in favour of regicide, it was burned, by order of the parliament of Toulouse, on the occasion of an attempt made on the life of Louis XV. by Damiens in 1757. Subsequently, the Jesuits Zacharia and Franzoja of Padua wrote in defence of B.'s work.

BUSH ANTELOPE, BUSH BUCK, and BUSH GOAT, names common to a number of species of Antelope (q. v.), natives chiefly of the southern and western parts of Africa, forming a section of the genus *Antelope*, which some naturalists have attempted to erect into a distinct genus (*Philatomba* or *Cephalopus*). They are animals of more compact form, shorter limbs, and greater strength, but much less agility, than the true or typical antelopes. They are remarkable for the arched form of the back. They have short, straight, or slightly curved horns, situated far back, and generally peculiar to the male sex, with usually a long tuft of hair between them. They have no tear-pits, but instead of them, a naked glandular line, formed of two series of pores, on each cheek. They frequent jungles, thick forests, and beds of reeds, and when pursued, seek to escape by diving into a thicket. The common or white-backed B. A. of Sierra Leone (*Antelope sylvicultrix*) is about three feet high at the shoulder: it is a dull, heavy, awkward-looking animal; keeps concealed in the thickets during the day, living singly or in pairs, and feeds in the open spaces in the early mornings only. To shoot it, sportsmen place themselves on the margin of the woods, and watch their opportunity as it comes out to graze. Its flesh is more esteemed than that of the more agile antelopes. Nearly twenty other species are usually ranked in this section of antelopes, among which is the *Kleene Boc* (*Antelope pygmaea*) of South Africa, a species abundant in many parts of Cape Colony, of very small size, not more than one foot in height at the shoulder, and with horns only about 1½ inch in length. It is a timid, gentle animal, easily domesticated. It differs from the typical Bush Antelopes in the great activity which it displays.

BUSHEA'B, a low flat island in the Persian Gulf, about 11 miles from the Persian coast, in lat. 26° 50' N., long. 53° 12' E. It is about 18 miles long, narrow, and well peopled, with a town and harbour at its western extremity. Its proper name is *Khoshaub*, signifying 'good water.'

BU'SHEL [Fr. *boisseau*, allied to *boi(s)te*, box, butt; Lat. *butta*, a measure in general], a dry measure used in Britain for grain, fruit, &c. The quarter contains 8 bushels, and the bushel 8 gallons, the gallon measuring 277·274 cubic inches, and holding 10 lbs. avoirdupois of distilled water. Hence the imperial bushel contains 80 lbs. of water, and measures 2218·2 cubic inches. The old Winchester

bushel measured 2150 cubic inches; hence 33 Winchester bushels = 32 imperial bushels nearly.

BUSHIRE. See **ABUSHEHR**.

BU'SHMAN'S RIVER, or **BO'SJESMAN'S RIVER**, in the east part of the Cape Colony, South Africa, is about 200 miles long, and forms on its lower course the west boundary of Albany, whose capital is Graham's Town. Its general direction is from north to south, its mouth being about lat. 33½° S., and about long. 26¼° E.

BU'SKIN, a kind of half-boot, lacing tight to the leg. The ancient tragedians wore buskins (*cothurni*), often with thick soles, to add to their stature. Hence the B. is often put for Tragedy, as the sock (*soccus*, a flat-soled shoe) for Comedy. In ancient sculpture, Diana, and hunters in general, as well as men of rank and authority, are represented in buskins often highly ornamented.



Buskin.

BUSS is the name of a small vessel, usually from 50 to 60 tons' burden, much used in the herring-fishery, especially by the Dutch. The B. has two small sheds or cabins—one at the prow, to serve as a kitchen, and the other at the stern. The remaining space is a receptacle for fish.

BUSS PALM (*Manicaria saccifera*), a South American palm, growing in the tidal swamps of the Amazon, the only known species of its genus. The stem is only 10—15 feet high, curved or crooked, and deeply ringed. The leaves are simple or undivided, and are the largest of the kind produced by

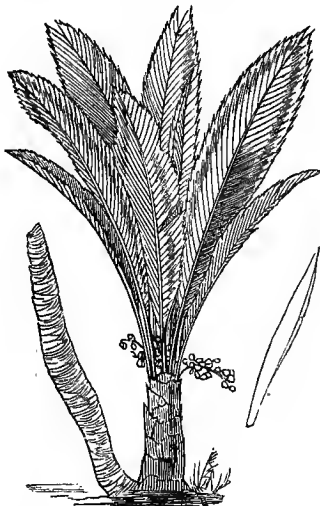

Bussu Palm.

any known palm, being often 30 feet long, and 4 or 5 feet wide. They are simply branched, drooping, and the fruit is of an olive colour, large, hard, and three-seeded. The leaves make excellent and durable thatch, being split down the midrib, and laid obliquely on the rafters, so that the furrows formed by the veins lie in a nearly vertical direction, and serve as so many little gutters to carry off the water. The *pathe*, taken off entire, is used by the Indians as a bag, or the larger ones are stretched out to make caps.

BUST (Ital. *busto*; Fr. *buste*), in plastic art, the

BUST—BUSTARD.

name given to a sculptural representation of the head and upper part of the human body. The earliest busts formed by the ancients were probably those heads of Mercury which, when elevated on tall square blocks of stone, received the name of *Hermæ* (q. v.). These *hermæ* were afterwards frequently surmounted by representations of other divinities, such as Minerva; and as they gradually assumed more and more of the human form, they passed



Bust of Aristotle.

into busts, which were made of marble, bronze, &c. But it was not till very late in the history of art that busts, in the sense of portraits of individuals, came to be used, either in Greece or Rome; and it is remarkable that neither Greeks nor Romans designated them by any special name, for the Latin word *bustum* had a quite different meaning. It was not till Alexander's time that busts were used for purposes of portraiture in Greece; and most of the Roman busts which we possess belong to the period of the emperors. During the learned period of Greece, which commenced with Aristotle, portraits of men of letters formed an important department of art; and it became an object with the founders of museums and libraries to procure complete sets of them. The artists of this period exhibited remarkable ability in expressing the characters of the individuals whom they represented. In this way, we have well authenticated busts of Socrates, Plato, Zeno the Stoic, and other philosophers; of poets and orators, such as Isocrates and Demosthenes; of Athenian statesmen and distinguished women. In Rome, representations of the kings, and persons of distinction belonging to the earlier period, were probably made from the *imagines majorum* which every patrician preserved in his atrium, and which were commonly made of wax. These, no doubt, were often merely fanciful representations, partly taken, it may be, from the more prominent features which belonged to the existing members of the family. The earliest well authenticated Roman B. which we possess, is probably that of Scipio Africanus the Elder. During the empire, busts for the most part were accurate portraits, and still furnish us with the means of becoming acquainted with the features, not only of the emperors themselves, but of most other persons of distinction. Busts of poets and men of letters are far less frequently met with amongst the Romans than amongst the Greeks. The chief marks of the authenticity in these busts are the names which very frequently are inscribed on them, and, where these are not found, the comparison which we are enabled to make between them and coins. Private

collectors of busts were not unknown in antiquity, as, for example, M. Terentius Varro and Pomponius Atticus. In our own time, King Louis of Bavaria made, in his celebrated Valhalla, the most remarkable collection of busts which perhaps anywhere exists. The first complete collection of engravings from antique busts was made by Fulvius Ursinius in his *Illustrum Imagines* (Rome, 1569, and Antwerp, 1606). Recently, we have been indebted to Visconti's *Iconographie Grecque* (Paris, 1811) and *Iconographie Romaine* (Paris, 1817) for a similar collection.

BU'STARD (*Otis*), a genus of birds, sometimes made the type of a family, *Otidæ*, usually ranked in the order *Grallæ* (q. v.). The general structure seems to agree best with that of the *Grallæ*; but there are points of strong resemblance to gallinaceous birds, both in the appearance and habits of the bustards; while their power of running, and the use which they make of their wings to aid in running, are indicative of a relation to the *Struthionidæ*, or ostrich tribe. They differ, however, from these birds in possessing wings quite capable of flight, although even when pressed by danger they often seek to escape by running, and the great B. of Europe has been pursued and taken by greyhounds.—Bustards are birds of bulky form, with long neck and long naked legs; the toes, three in number, all directed forward, short, united at the base, and edged with membrane; the wings rather rounded; the bill of moderate length, straight, or nearly so. They are mostly inhabitants of open plains, to which all their habits are adapted.—The GREAT B. (*Otis tarda*) was at one time plentiful in some parts of England, and was also an inhabitant of the south-east of Scotland; but extending cultivation, and the



Great Bustard.

persecution to which it has been subjected, have now rendered it a very rare British bird. It is common in the south and east of Europe, and abounds in the wide steppes of Tatory. It is the largest of European birds, the male sometimes weighing nearly 30 lbs. The female is much smaller than the male. The plumage is of a pale chestnut colour on the upper parts, beautifully varied with black—much white and black on the wings, the tail tipped with white. The tail is short, spreading, and rounded. A tuft or plume about seven inches long, springing from the chin, passes backwards and downwards on each side, in the summer dress of the

BUTCHER BIRD—BUTEA.

male, partly concealing a long stripe of bare skin on each side of the neck. The anatomy of the male exhibits a remarkable peculiarity in a large bag or pouch, capable of holding several pints, the entrance to which is between the under-side of the tongue and the lower mandible. The use of this bag is unknown; but it has been conjectured to be for conveying water to the females and young, in wide arid plains. The Great B. feeds indiscriminately on animal and vegetable food, swallows frogs, mice, worms, &c., and is very fond of turnip-tops. Its flesh is highly esteemed for its flavour. It is polygamous. No difficulty is found in taming it, but all attempts to reduce it to a state of true domestication have hitherto failed, from its not breeding in the poultry-yard.—The LITTLE B. (*O. tetraea*), frequent in the south of Europe and north of Africa, is only an accidental visitant in Britain. It is not half the size of the Great Bustard.—The BLACK-HEADED B. (*O. nigriceps*) is found in large flocks in the open plains of the Mahratta country. Its flesh is esteemed one of the greatest delicacies which India produces.—The KORI B. (*O. Kori*) of South Africa, a magnificent bird, standing upwards of five feet in height, has a similar reputation as one of the best kinds of game.—Australia possesses a B. (*O. Australasianus*) somewhat exceeding the Great B. of Europe in stature. It is called Wild Turkey by the colonists of New South Wales. Its plumage is finely freckled or spotted; the prevailing colour is brown. It has become comparatively rare in the more settled districts, its flesh being particularly delicate and well flavoured, but may be seen stalking majestically in the grassy plains, wheresoever human footsteps are still rare.

BUTCHER BIRD. See SHRIKE.

BUTCHERS' BROOM (*Ruscus*), a genus of plants of the natural order *Liliaceae*, with male and female flowers on separate plants, a perianth of six leaves, filaments united, one style, and the fruit a berry. The common B. B. (*R. aculeatus*) is a shrubby, or almost shrubby evergreen plant, with a biennial



Butchers' Broom :

a, branch, with flowers; b, a berry; c, a seed; d, a female flower.

stem, 1–3 feet high, sending out many short branches and ovate alternate sharp-pointed false leaves of the same substance as the branches, the flowers minute and arising from the disk of the false leaves, solitary; the berries red, almost as large as wild-cherries, and of a sweetish taste. It is common in many parts of the south of Europe,

and in the south of England in woods and hedges. The English name is derived from the use made of the plant by butchers, to sweep their blocks. It grows well under trees or shrubs, and can often be advantageously introduced for ornamental purposes. The root was formerly much used in medicine. It is aperient and diuretic.—*R. hypophyllum*, a native of Italy, had once a considerable reputation as a stimulant of the uterus.

BUTE, an island in the Firth of Clyde, Scotland, separated from the coast of Argyre by a narrow winding strait, called the Kyles of Bute, mostly under a mile wide, about 6 miles distant from the west coast of Ayrshire, and 8 miles north of Arran. It is about 16 miles long, of irregular breadth, and with an area of 60 square miles. The surface to the north is high, rugged, and barren; in the centre and south, it is low and undulating, and comparatively fertile. The highest point rises 875 feet. The coast is rocky, and has some bays. The island has several small lakes. The climate is milder than in any other part of Scotland, and though moist, less so than on the west coast generally; hence, it is much resorted to by invalids. In the south, the soil is sandy; towards the north, clay predominates. Most of the arable land is under tillage, and agriculture is in a good state. The chief crops are oats and wheat. Pop. 10,661. The principal town is Rothesay. Most of the island belongs to the Marquis of Bute, whose beautiful seat, Mount Stuart, is about 4 miles south from Rothesay. Among the antiquities of B. are Rothesay Castle, Kames Castle, Kilmorie Castle, St Blaine's Chapel, Dungyle, a remarkable vitrified fort on a high crag on the south-west coast, and the Devil's Caldron, a circular erection, the original purpose of which is not well known. B. and the neighbouring isles were for many centuries subject to the Norwegians.

BUTESHIRE, a county in the south-west of Scotland, comprising the isles of Bute (q. v.) and Arran (q. v.), and the Cumbrays, Holy Isle, Pladda, Inchmarnoch, and other smaller islands. The estimated area of the whole is about 257 square miles. Pop. in 1851, 16,608; day-schools, 33, with 2096 scholars; places of worship, 26. B. returns one member to parliament. The county town is Rothesay, in Bute.

BUTE, JOHN STUART, third EARL OF, was born in 1713, and died in 1792. About 1737, he attracted the favourable notice of Frederick Prince of Wales, who made him one of his Lords of the Bedchamber. After the death of the prince, he became Groom of the Stole to his son, afterwards George III., over whose mind he obtained a strong influence. In March 1761, he was appointed one of the principal Secretaries of State; and from the 29th May 1762 to the 8th April 1763, he was Prime Minister. His government is memorable only as one of the most unpopular that ever held office in Britain, its fundamental principle being the supremacy of the royal prerogative, of which the executive government were merely the humble servants. Lord Bute was given to scientific pursuits, especially botany, and shewed himself a liberal patron of literature and art. He married the only daughter of Lady Mary Wortley Montagu.

BUTEA, a genus of plants of the natural order *Leguminosae*, sub-order *Papilionaceae*, remarkable for the great length of the *standard* of the flower, and having a compressed one-seeded pod, membranaceous at the apex. The best known species are *B. frondosa* and *B. superba*, natives of India; and the former very widely diffused throughout that country, generally appearing as a sort of shrub in

the neighbourhood of villages, but in the jungles growing into a small tree. These trees present a gorgeous sight when covered with racemes of large deep scarlet flowers. They have trifoliate leaves, with roundish leaflets, velvety beneath. They yield a resinous exudation, which occurs in the form of lurid red tears, often covering the twigs, and is one of the kinds of Lac (q. v.) brought to the market in India. The juice of the tree is not red, and the lac is supposed to be elaborated by insects, but of what species is unknown.—*B. frondosa* is called the *Dhak* Tree in India. The bark and roots are very fibrous, and the fibre is used for calking boats. The flowers, called *Teesoo* or *Keesoo*, yield 'a beautiful dye, which is likely to come into extensive use' (Royle).

BUTLER, JOSEPH, one of the most eminent of English divines, was born in 1692 at Wantage, in Berkshire, where his father kept a shop. With a view to the ministry of the Presbyterian Church, he attended a dissenting academy at Tewkesbury, in Gloucestershire. At the age of 22, he gave proof of high metaphysical ability in a letter to Dr Samuel Clarke, usually appended to that celebrated writer's *a-priori* demonstration, to which it offers some objections. About this time, he made up his mind to join the Church of England, and in March 1714 entered Oriel College, Oxford. Soon after, he took orders. In 1718, he was appointed preacher at the Rolls Chapel, where he preached those remarkable sermons which he published in 1726. The first three, *On Human Nature*, constitute one of the most important contributions ever made to moral science. The scope of the reasoning is briefly, that virtue is consonant with, and vice a violation of, man's nature. In 1725, B. was presented to the rich benefice of Stanhope, in the county of Durham, to which he removed in the following year. Here he resided in great retirement till 1733. His friend Secker, the archbishop, desired to see him promoted to some more important position, and mentioned his name once to Queen Caroline. The queen thought he had been dead, and asked Archbishop Blackburne if it were not so. 'No, madam,' said the archbishop; 'but he is buried.' In 1733, B. became chaplain to his friend Lord Chancellor Talbot, and at the same time a prebendary of Rochester. In 1736, he published the great work of which the germs were contained in his three sermons, and which has entitled him, in the eyes of his eloquent disciple Chalmers, to be called 'the Bacon of theology.' The leading aim of the *Analogy* is to shew, that all the objections to revealed religion are equally applicable to the whole constitution of nature, and that the general analogy between the principles of divine government, as revealed in the Scriptures, and those manifested in the course of nature, warrants the conclusion that they have one Author. Soon after the publication of this work, B. was appointed clerk of the closet to the queen, who greatly prized his conversation. In 1738, he was made Bishop of Bristol; in 1740, Dean of St Paul's; and in 1750, he was translated to the see of Durham. He lived only to make one visitation of his diocese. His 'charge' on the occasion, in which he pointed out, with characteristic depth of insight, the importance of a due maintenance of the externals of religion, as a means of keeping alive the thought of it in the minds of the people, subjected him to much censure as betraying a tendency to Roman Catholicism—a charge unworthy now of serious notice. B.'s private character was such as became a Christian prelate: grave and judicious, he was at the same time meek and generous. His intercourse with his clergy and people was frank and humane; his episcopal treasures were wisely

and munificently distributed, as not his own; and no anxious legatee looked with hope to his death. That event took place at Bath, June 16, 1752, and the good bishop's remains were buried in Bristol Cathedral. His works, notwithstanding a dry and uninteresting style, have gone through numerous editions. The best is that edited with a life, &c., by Fitzgerald.

BUTLER, SAMUEL, poet, was born at Strensham, Worcestershire, in 1612. His father was a farmer in that place, and said to be a person of some education. Young B., after acquiring the rudiments of his education at home, was placed at the college school at Worcester. His progress there was rapid, and on leaving it, he proceeded to one of the universities. After finishing his education, he was appointed clerk to T. Jeffreys, Esq., justice of the peace, and in his leisure hours devoted himself to the study of music and poetry. He afterwards entered the household of the Countess of Kent, which he left, and went to live with Sir Samuel Luke, who resided in the same county. After the king's restoration, he was made secretary to the Earl of Carberry, which office he held till 1661. About this time, B. married a Mrs Herbert, a lady of good family and some property, which, however, was afterwards lost by being invested in bad securities. He published the first part of *Hudibras* in 1663, and its reception at court was immediate and triumphant. It received all the favour Charles could spare from his spaniels and his mistresses, and he deigned even to garnish his royal conversation with its wit. The courtiers took up the fashion, the coffee-houses and taverns followed suit, and finally the mob went into raptures, in imitation of its betters. *Hudibras* was pirated within four weeks of its publication. The king had wit enough to see the merit of the work, but he lacked generosity to relieve the necessities of the writer. There seems to be no good reason to believe that B.'s palm ever tingled to the touch of royal pension or gratuity. Poverty is almost the only thing in B.'s life that one is certain of. In 1664, he published the second part of his book, and a third part appeared in 1678. He died in Rose Street, Covent Garden, in 1680; and while some say that he starved from pride, all agree that at his death he was very poor.

Hudibras is a kind of metrical *Don Quixote*; and if the work of Cervantes stands at the head of its class in the literature of Spain, *Hudibras* occupies the same place in the literature of England. The Puritans are the subjects of B.'s derision, and King Charles must have felt that the poet avenged for him the battle of Worcester. The weight, compression, and plenteousness of the wit is wonderful. *Hudibras* is like a mass of crystals, every point flashes. It is beyond any other book, of wit 'all compact.' B. thinks in witty couplets, he argues in them, he spears his foes with a jest, he routs and chases them into oblivion with unextinguishable laughter. His best things have become proverbs. His mass of wit has been grated down into common speech, and particles of it may be found any day glittering in the talk of English ploughmen and artisans.

BUTLER, WILLIAM ARCHER, a religious and philosophical writer of singularly high promise, was born in 1814, at Annerville, near Clonmel, Ireland. He was originally a Roman Catholic, but subsequently became a Protestant, and studied at Trinity College, Dublin, where he was appointed Professor of Moral Philosophy in 1837. He died in 1848. The principal work on which his reputation is based, is the *Lectures on the History of Ancient Philosophy*,

edited with notes by W. Hepworth Thomson (Cambridge, 1856, 2 vols.). These lectures are remarkable for their great learning, eloquence, and depth of judgment. Besides his lectures, there have appeared, *Sermons*, with a memoir by the Rev. Thomas Woodward (Dublin, 1849); *Letters on the Development of Christian Doctrine* (Dublin, 1850); *Letters on Romanism* (Lond. 1854).

BUTLERAGE OF WINE, as described by Blackstone and Stephen, is a very ancient hereditary duty belonging to the crown, and is otherwise called the *prisage* of wines. This duty is taken notice of in the Great Roll of the Exchequer, 8 Richard I., still extant. Under the right to levy it, the crown could take two tuns of wine from every ship (English or foreign) importing into England twenty tuns or more, one before, and one behind the mast; which, by charter of Edward I., was exchanged into a duty of two shillings for every tun imported by merchant strangers, and called butlerage, because paid to the king's butler.

BUTOMUS, a genus of aquatic plants, of which one species, *B. umbellatus*, is frequent in ditches and ponds in England, Ireland, and many parts of Europe, but is very rare in Scotland. It is popularly called Flowering Rush, and is one of the plants to which the praise has been assigned of being the



Butomus umbellatus.

most beautiful in the British flora. The leaves are all radical, 2—3 feet long, linear, triangular, their sharp edges sometimes cutting the mouths of cattle, whence the generic name (Gr. *ax-cutting*). The scape, or flowering stem, is longer than the leaves, terminating in a large umbel of rose-coloured flowers, readily distinguished from those of all other British plants by having nine stamens, six in an outer, and three in an inner row.

BUTTER (Ger. *butter*; Fr. *beurre*; Lat. *butyrum*) is the fatty substance present in the milk of the mammalia, and capable of being extracted from it. In ancient times, the Hebrews seem to have made copious use of butter as food; but the Greeks and the Romans used it only as an ointment in their baths, and it is probable that the Greeks obtained their knowledge of the substance from

the Scythians, Thracians, and Phrygians, whilst the Romans obtained it from Germany. In Southern Europe, at the present time, B. is very sparingly used; and in Italy, Spain, Portugal, and Southern France, it is sold by apothecaries as a medicinal agent for external application. The amount of B. in cows' milk (q. v.) is about 4 per cent., though the kind of pasture, quantity of milk, and general condition, influence the relative quantity of the several ingredients of milk. In the extraction of B., the milk is allowed to cool, and the cream which rises to the surface is skimmed off, and put into a large, deep, earthenware vessel, where it lies for several days till enough has been collected for a *churning*. Any difference in the exact mode of treatment of the milk yields a B. with some peculiarity or other. Thus, the B. and cream of Devonshire, which are famed for their superior richness, owe this in greater part to the mode of manipulating the milk, and not to the special character of that fluid, or to the richness of the pastures in those districts. The milk in Devonshire is not allowed to cool slowly, as elsewhere, but is at once placed in large deep pans, and carefully heated. A scum quickly rises, which is pushed to the side; and whenever the bubbles of steam appear, the milk is removed, and allowed to cool in the ordinary way, when a good deal of the milk thickens to the consistency of B., and is skimmed off as the celebrated *Devonshire clouted cream*. In England, the B. of Epping and Cambridge is highly esteemed, and in every part of Great Britain, the Dutch B., in a salted form, is very largely consumed; indeed, three-fourths of all the foreign B. consumed in Great Britain is imported from Holland.

In order to separate the B. from milk, recourse is always had to the process of agitation in *CHURNS* (q. v.). The principle involved in each, and all of the forms of this apparatus is the thorough agitation of the contents, so as to cause the rupture of the minute fat globules present in the milk, and the incorporation or kneading of these ruptured fat globules into larger or smaller masses of butter. The cream is strained through cloth into the churn, to remove any foreign matter; and the agitators being set in motion, the friction of the movement, combined with the admission of air, and the chemical changes it induces, raises the temperature of the whole contents. At one time, it was thought that one great object of the agitation was the admission of the oxygen of the air, which becoming thoroughly incorporated with constituents of the milk, combined therewith, and, as a consequence, led to the separation of the butter. It is found, however, that B. can be obtained from milk by mere agitation, without the admission of the oxygen of the air. At the same time, in the ordinary way of churning, oxygen does play a subordinate part by combining with the sugar of the milk, and forming lactic acid, which in its turn *sours* the milk, and separates therefrom the caseine (q. v.)—cheese-matter—in minute clots or flakes, yielding what is commonly called *sour* or *butter milk*. The process of churning must be conducted at a medium rate. If too quickly performed, the B. is soft and frothy, and is said to be *burst*; whilst when too slowly made, it is highly tenacious, strong tasted, and badly flavoured. When all the B. has *come*, which is known by the particles agglutinating into irregular masses, the B. is *made* by taking the lumps, and well washing and kneading them on a wooden board in a tub of pure spring-water till all the butter-milk has been expressed; it is then divided into the requisite size of lumps, fashioned into rolls, or moulded into forms, and usually stamped with some device. In

BUTTER—BUTTERFLY.

the making up of the B., the hands of the operator must be scrupulously clean, and be free from the slightest taint of soap. Persons who are subject to moist hands should never knead B., as it is very liable to be contaminated by the slightest foreign matter, especially animal secretions; and it is better always for the operator to wash the hands with water containing some oatmeal before commencing. So important is this source of contamination regarded in America, that every endeavour is made to get quit of manual labour in working the B., and a wooden *butter-worker* has been invented, and is largely used there. When newly prepared, the B. is called *fresh* or *sweet* B., and is of a yellow colour, which is well known to be deeper as the pasture on which the cows have been fed is richer, and hence the poorer kinds of B. are often artificially coloured with a little annatto (q. v.), and rarely with the juice of carrots.

A large quantity of the B. sent into market has more or less common salt added, for the purpose of preserving it. For use within a week or two, the proportion of common salt employed is about half an ounce to two pounds of B., though, where it has to be kept for some time, as much as one ounce of salt to one pound of B. is used. The incorporation requires to be carefully and dexterously done, so that the resulting material may be uniform; and the better plan is to add only a portion of the salt at a time, and to knead and re-knead the B. till the whole is thoroughly mixed. When the less amount of salt has been employed, the result is *powdered* B., and the larger quantity yields *salt* butter. Much of the latter is closely packed in small wooden firkins or *kits*, and occasionally in stoneware, and sent into market. Great care must be taken to have these kits, and indeed to have every vessel used in the preparation, as clean or *sweet* as possible. Constant rinsings with cold water, and scaldings with boiling water, are resorted to. Attention must likewise be paid to the atmosphere of the apartments in which the milk is first placed, and in which the subsequent operations go on, as a tainted atmosphere always tends to injure the quality of the marketable commodity.

The adulterations liable to be present in B. are an undue proportion of salt and water, and these run up occasionally to upwards of 33 per cent., or one-third of the total weight. Another adulteration is the presence of lactate of zinc, derived from the milk being placed in zinc pails and basins, from the impression that by some imaginary electrical influence an increase in the amount of cream will be the result; but though this is not attained, yet the milk tending to form lactic acid, the latter attacks the zinc vessel, and forms lactate of zinc, which dissolves in the milk, and thereby contaminates it, imparting an unpleasant taste, and, when present in larger quantity, leading to violent spasmodic vomiting. When B. is allowed to get old, it becomes rancid, and tastes and smells disagreeably. To some extent, an acid is formed, called *Butyric Acid* (q. v.). The use of B. in diet will be considered under **FOOD** and **NUTRITION**.

BUTTER, in Chemistry, is often applied generically to any substance of the consistence of B., and is therefore used to designate palm, cocconut, shea, and nutmeg oils. It is also applied to certain metallic substances which have an oily aspect and consistence resembling melted B.; thus we have B. of antimony, bismuth, zinc, and tin.—**BUTTER** of Antimony is a thick, dense, oily compound, produced by acting upon the native sulphuret of antimony (SbS_2) by concentrated hydrochloric acid (HCl) and heat, when the oily chloride of antimony (SbCl_3) is formed. See **ANTIMONY**.

BUTTER, Rock, a mineral which may be regarded as a variety of Alum (q. v.)—an iron alum, appearing as a pasty exudation from rocks that contain alum or its constituents, particularly alum-slate and other schistose rocks. It occurs at Hurlet alum-work, near Paisley, Scotland, and in a number of places on the continent of Europe. It is not unlike butter in colour, varying from yellowish white to sulphur yellow. It is rather greasy to the touch, and is easily broken in pieces.

BUTTER TREE, a name given to several tropical trees, of different natural orders, the fruits of which yield concrete fixed oils, having the appearance and used for the purposes of butter. The B. trees of India and Africa belong to the genus *Bassia* (q. v.), of the natural order *Sapotaceæ*; the B. trees of Guiana and Brazil to the genus *Caryocar* (q. v.), of the natural order *Rhizophoraceæ*. The Oil-palms (q. v.), and the *Cocos butyracea* (see **COCOA NUT**), may also be regarded as B. trees, although not generally receiving that name.

BUTTERCUP. See **RANUNCULUS**.

BUTTERFISH. See **GUNNEL**.

BUTTERFLY, the common English name of all the diurnal Lepidopterous (q. v.) insects, corresponding with the genus *Papilio*, as originally defined by Linnæus, but forming many genera in the most recent entomological systems. Butterflies exhibit a great similarity in almost all respects to other lepidopterous insects, the common characters of which will be found in the article on that order; but are distinguished even more than the rest of them generally, by brilliancy of colouring, which in butterflies also belongs to the under as well as the upper side of the wings, whilst the beauty of moths and hawk-moths appears chiefly on the upper side. Accordant with this circumstance, is the further peculiarity, that almost all butterflies, when at rest, usually hold their wings erect, the under side being thus chiefly exhibited; whilst the other lepidopterous insects, when at rest, hold their wings in a horizontal or somewhat inclined position, and some have them wrapped round the body. Butterflies are also the only lepidopterous insects which have no spines, bristles, or hooks on the margins of their wings, by which the second wing on each side can be attached to the first, but both when flying and

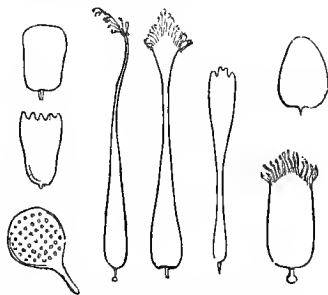

Various forms of Scales (highly magnified) from the Wings of Butterflies.

at rest, have all their wings quite separate. The manner in which the scales of the wings are imbricated, gives those of butterflies a smoother appearance than those of moths and hawk-moths. The antennæ of butterflies are generally simple, slender, and elongated, and terminated by a little club. Their caterpillars have always sixteen feet (see **CATERPILLAR**). The pupa or chrysalis is angular; is seldom enveloped in a cocoon; is generally

BUTTERFLY.

suspended by the tail, by means of a silky substance, often to a leaf or twig, but is sometimes supported by bands around the middle; and generally exhibits more or less of that golden colouring from which both the names *aurelia* (Lat. *aurum*) and *chrysalis* (Gr. *chrysos*) are derived.

Butterflies are found in all parts of the world; they are to be seen during the sunshine of the brief summer extracting nectar from the flowers even of Greenland and Spitzbergen, but they are most numerous in the warmest regions; where, however, many of them live chiefly in the shade of moist foliage, in woods and jungles. Dr Hooker, describing the scenery on the banks of the Great Runjeet in the Sikkim Himalaya, says, that 'by far the most striking feature consisted in the amazing quantity of superb butterflies, large tropical swallow-tails, black, with scarlet or yellow eyes on their wings. They were seen everywhere, sailing majestically through the still hot air, or fluttering from one scorching rock to another, and especially loving to settle on the damp sand of the river edge, where they sat by thousands, with erect wings, balancing themselves with a rocking motion, as their heavy sails inclined them to one side or the other, resembling a crowded fleet of yachts on a calm day.'

Butterflies possess no small power of wing; some of them, indeed, of which the wings are comparatively thin and delicate, are inferior in this respect, and have a sort of zigzag flight; but others soar in the air with a steady and continuous motion. Short-lived as they are all generally believed to be, some of the tropical species perform wonderful migrations; concerning which, however, nothing but the fact is yet well known. 'Frequently,' says Sir James Emerson Tennent in his work on *Ceylon*, 'the extraordinary sight presents itself of flights of these delicate creatures, generally of a white or pale yellow hue, apparently miles in breadth, and of such prodigious extension as to occupy hours and even days uninterruptedly in their passage, whence coming no one knows, whither going no one can tell.'

The number of species of *B.* is very great, and the arrangement of them has been found difficult, chiefly upon account of the great similarity in all important respects which prevails among them all. They are divided, however, into two well-marked sections, of which the first is characterised by having only a single pair of spurs or spines on the tibiae (or fourth joints of the legs), placed at their lower extremity; whilst in the other section, the tibiae of the hinder legs have two pair of spurs, one pair at each extremity. This distinction, seemingly unimportant in itself, is accompanied by other differences. The second section of butterflies may be regarded as forming a sort of connecting link between butterflies and hawk-moths. A few British species belong to it, but the species are generally tropical, and some of them, found in tropical America, are remarkable for their rapidity and power of flight, and for the migrations which they perform, besides being amongst 'the most splendid insects in creation,' a resplendent green, inimitable by art, relieving the velvet black of their wings, and varying with every change of light. The beautiful iridescence of the wings of these and many other butterflies is owing to the peculiar position of the scales.

Some groups of butterflies are remarkable for the imperfect development of the first pair of legs, so that they are generally described as having four legs instead of six.

The eggs of butterflies are deposited on the plants, the leaves of which are to supply the food of the caterpillars. In cold and temperate climates, the eggs deposited in autumn are not hatched till the following spring; but it is believed that many

species produce several broods in a year, as the eggs in summer may be hatched in a few days. The

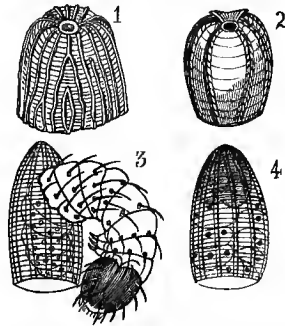

Eggs of Butterflies, highly magnified :

1. Egg of Queen of Spain Fritillary (*Argynnis Lathonia*);
2. Egg of Peacock Butterfly (*Vanessa Io*);
3. Larva of Large Garden White Butterfly (*Pieris Brassica*), in the act of hureting from the egg;
4. Egg of same insect, ready to hatch, showing the head and curved body of enclosed caterpillar through the transparent envelope.—For these illustrations we are indebted to Westwood's excellent treatise on British Butterflies.

caterpillars of each species are generally confined to some particular kind of plant, the leaves of which they devour; their ravages are well known, but the excessive increase of their numbers is in part restrained by many enemies, and by none more than by the ichneumons (q. v.) and other insects which deposit their eggs in them, and the larvæ of which feed on them. The annexed cut represents a common species of *B.*, with its larva and pupa; an account of *B.* transformations will be given under INSECT TRANSFORMATIONS.

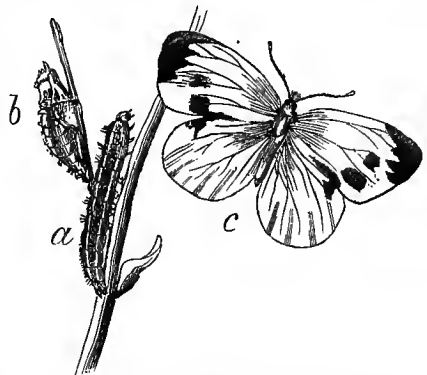

Large Garden White Butterfly (*Pieris Brassica*),
reduced :

a, caterpillar; b, chrysalis; c, perfect insect.

Butterflies vary in size from less than an inch to almost a foot across the expanded wings. The largest species are tropical. Some of the species are very widely distributed: *Cynthia cardui*, of which the caterpillar feeds on the leaves of thistles, is found not only throughout Europe, but in Egypt, Barbary, Senegal, Cape Colony, Madagascar, China, Java, Australia, Brazil, and North America, being, in fact, one of the most widely distributed of all insects. The geographical limits of other species appear to be very restricted. The diversity of colouring is almost endless, but a prevalence of certain hues, or of certain modes of the disposal of them, is observable throughout large groups. The

BUTTERFLY FISH—BUTTON.

caterpillars of many species are variously furnished with spines, those of others—none of them British—have long fleshy prominences, horny at the tip, probably intended as means of defence. The hinder wings of many butterflies are curiously prolonged into tail-like appendages, one or more on each wing, which vary in form, being sometimes long and linear, sometimes broad and widening towards the extremity. These are, however, little seen in British species.

Butterflies are chiefly known to us as objects of admiration and of pleasing contemplation, enhancing the charms of the most delightful weather, and always associated with the most lovely scenes, or—it must be added—as a cause of annoyance and vexation by the ravages of their caterpillar young in our fields and gardens. There is, however, one small species (*Euplaea humata*) which affords a supply of food to some of the wretched aborigines of Australia. Butterflies of this species congregate in such vast numbers on the masses of granite in the mountains, that they are collected by simply making smothered fires under the rocks, in the smoke of which they are suffocated. Bushels of them are thus procured, and they are baked by placing them on the heated ground, the down and wings removed, and the bodies made into cakes which resemble lumps of fat. The months of November, December, and January are quite a season of festivity from the abundance of this food.

Brief notices of a few of the principal kinds of B. will be found in other parts of this work. See CABBAGE BUTTERFLY, CAMBERWELL BEAUTY, PURPLE EMPEROR, &c.

BUTTERFLY FISH. See BLENNY.

BUTTERFLY WEED, or PLEURISY ROOT (*Asclepias tuberosa*, see ASCLEPIAS), a plant found in all parts of the United States, and which has obtained a considerable reputation for the medicinal virtues of its root. The root is large, formed of irregular tubers or spindle-shaped branches, externally yellowish brown, internally white, with a somewhat acrid nauseous taste when recent, merely bitter when dried. It yields its properties to boiling water, and is usually administered in the form of a decoction, sometimes in that of a powder. It is diaphoretic and expectorant, and has been found useful in the commencement of pulmonary affections, in rheumatism, and in dysentery.—The stem of the plant is erect and hairy, with spreading branches; the leaves oblongo-lanceolate, alternate, hairy, and somewhat crowded; the flowers orange-yellow, forming numerous umbels.

BUTTERMILK is the form of milk from which the butter or oily matter has been abstracted. See BUTTER. Buttermilk contains the caseine, sugar, and salts of ordinary milk, and is only deficient in oily matters. It is therefore nutritious, and is largely used in Ireland and Scotland as an article of food, being very generally partaken of with porridge and with potatoes. It may be drunk *ad libitum*, is a very agreeable cooling beverage, and is therefore useful in certain febrile and inflammatory conditions.

BUTTERWORT (*Pinguicula*), a genus of plants of the natural order *Lentibulariaceae* (q. v.), distinguished by a two-lipped calyx, the upper lip trifid, the lower bifid; a spurred corolla, two-lipped and gaping, the upper lip arched; and a globose germen. The species are small plants with only radical leaves, found in the bogs and marshes of different quarters of the world. Some of them possess much beauty when in flower, particularly *P. grandiflora*, a rare native of the south of France and of Ireland. The common B.

(*P. vulgaris*) is abundant in the northern parts of Britain and of Europe. It has the power of coagulating milk. The Laplanders pour reindeer milk,



Butterwort (*Pinguicula vulgaris*):
a, the entire plant; b, a flower.

warm from the animal, upon the leaves of this plant, instantly strain it, and set it aside for two or three days, till it acquires the consistence of cream, and some degree of acidity, when it is with them a favourite article of food. A little of it in this state will produce the same effect on warm reindeer milk which was at first produced by the leaves of the plant. The origin of the English name B. is sometimes referred to the power of coagulating milk, sometimes to the peculiar sliminess of the leaves.

BUTTISHOLZ, a village of Switzerland, in the canton of Lucerne, and 11 miles north-west from the city of that name. Near to B. is a large mound called the English Barrow, because here are buried 3000 Englishmen, followers of De Cuncy, son-in-law of Edward III. of England, who, while devastating the cantons, were defeated and killed by Swiss peasants in 1376.

BUTTMANN, PHILIPP KARL, one of the most distinguished philologists of modern times, was born at Frankfurt-on-the-Main in 1764, and studied at Göttingen under Heyne. He became, in 1789, assistant in the Royal Library in Berlin, and rose successively to be secretary and librarian (1811). He held at the same time (1800—1808) a professorship in the Joachimsthal Gymnasium in Berlin, which he afterwards exchanged for a professorship in the newly founded university of that city. He died 21st June 1829. B. is best known by his Greek grammars, the *Griech. Grammatik* (Berl. 1792; 18th ed. by his son, Alexander Buttmann, 1849), and an abridgment of it, *Griech. Schulgram.* (11th ed. 1843); both have been translated into English. His *Lexilogus* (translated by Fishlake) and *Ausführliche Griech. Sprachlehre*, or Larger Greek Grammar, which have gone through several editions, are designed for scholars. In his *Mythologus*, he has collected his essays on the myths of the ancients.

BUTTON. The term B. is applied to the well-known appendages to dress used for fastening or for ornament; and to a sort of oblong latch moving

BUTTON.

upon a pivot in the middle, that is applied by carpenters and cabinet-makers for fastening the lids of boxes, doors of presses, &c. The mass of fused metal found at the bottom of a crucible or cupel, after fusing or assaying, is also technically called a button.

Buttons used for dress are of four kinds—shank buttons, hole buttons, covered buttons, and wire buttons. The chief seat of manufacture is Birmingham, though recently a very keen competition has been established in France and Germany, especially in fancy buttons. Shank buttons are for the most part of brass, which is supplied to the maker in sheets rolled to the thickness he requires. Circular discs, called 'blanks,' are cut from these by means of fly-presses and punches. The fly-press consists of a vertical iron screw with a triple thread, to which screw is attached a horizontal arm, bending downwards at the end to form a handle, by swinging which the screw is made to descend rapidly and firmly, carrying the punch with it. The presses are worked by women and girls, who hold the sheet-metal in the left hand, and push it under the punch while the screw, which is worked by the right hand, is ascending. More complex machines are also used, by means of which a row of 8 or 10 blanks are cut at once, the machine itself pushing the metal forward; but hand-punching is still the method most extensively adopted in Birmingham. The edges are next trimmed, to remove the burr, and the blank is planished by stamping with a plain die, and the name of the maker embossed in like manner. The shanks are made by a machine which is fed with a coil of wire, which it pushes in short lengths to a pair of shears; these, when cut off, are, by another part of the machine, forced into a kind of vice, which bends them to the required loop shape; the ends are then struck out flat with a hammer, and the complete shank is pushed out of the machine. These shanks are soldered to the blanks, and the buttons are finished in the lathe. They are then lackered or gilded. See GILDING and LACKERING.—'Shell' buttons are those with a convex face, a flat or convex back, and hollow. These are made of two blanks, that forming the face being larger than the back to which the shank is attached. These blanks are pressed into the required shape by dies worked in the fly-press, and then, by another die, the edge of the larger blank is lapped over the smaller, and thus attached without soldering. Livery and other buttons having a device in strong relief are stamped by a die attached to a heavy weight or 'monkey.' This monkey is suspended by a rope working over a pulley, and terminating in a stirrup, into which the workman places his foot, and thereby lifts the weight and die; then raising his foot, suddenly lets it fall upon the B, which rests in another die fixed in the bench below. The monkey and die are guided in their descent by working in a groove between two upright posts. While the die is ascending, the workman holding the blank next to be stamped under his thumb, pushes it to its place, at the same time pushing out the one that has been stamped. This is done very rapidly; and the consequence of a moment's inattention is a crushed thumb—by no means an uncommon accident.—Common white metal-buttons are cast in moulds, in which the shanks are previously placed, and are thereby attached without soldering. When the body of the B. is of pearl-shell, bone, or wood, the blanks are cut out by means of a tubular saw—i. e., a tube toothed at one end; this is made to revolve in a lathe, and the shell is pressed against it. The shanks are fixed by cutting a cavity half way through the blank; this is undercut, so that it is enlarged as it deepens. The stem of the shank

is shaped like a hollow cone, with its base just large enough to enter the cavity; and after insertion, a blow spreads it out, so as to fill up the inner and larger part of the cavity, and thus it is dove-tailed in.

Buttons with holes, technically called 'four-holes,' 'three-holes,' and 'two-holes,' when of pearl-shell, wood, bone, or ivory, are cut with the tubular saw as above, turned separately in a lathe, and drilled. When of metal, the blanks are punched, then stamped in dies to the required form; the holes are punched, and again stamped, to round the sharp edges that would otherwise cut the thread.

The semi-paper B. is an important improvement recently made upon the metal four-hole. A very thin sheet-iron blank is struck with the edge turned up; into this is laid a blank of thick brown paper or rather thin mill-board; another stamping squeezes the raised edge round the paper, and clasps it tightly, thus incorporating together the metal and paper. The holes are then punched, and again pressed, so that the metal edges may be well rounded and sunk into the paper. After being japanned, these buttons appear as if of solid metal; but they are superior on account of their lightness, and the absence of any edges to the holes that can cut the thread.

Wire buttons are simply rings of wire covered by machinery with threads radiating from the centre, and embracing the wire-ring. These are almost entirely superseded by linen-covered buttons.

Covered buttons were formerly made by sewing cloth upon 'bone-moulds'—i. e., flat bone discs with a hole in the middle. These have been quite superseded by the various modifications of the 'flexible shank,' 'florentine,' and other buttons, the subjects of a multitude of patents. The details of these are somewhat complex, but the general principles of construction are nearly the same in all. A metal blank is punched, and its edge is turned up by a die in a fly-press; then another blank is punched with a hole in the middle, and of such size, that, when flat, it shall fit into the upturned edge of the first: this perforated blank, or *collet*, is next pressed into a concave or dished shape. Two cloth blanks are now punched, one considerably larger than the metal blank, the other somewhat smaller; the larger cloth blank is laid upon the flat face of the metal blank, and its edges turned over; these edges are covered by the smaller cloth, and then the collet laid upon them with its concavity towards the cloth. They are now all pressed together in a sort of die or mould, by which means the collet is flattened and spread out, while the upturned edge of the metal blank is turned forcibly over it, thus securing the collet, and with it the cloth which is strained tightly on the face, and its edges bound between the blank and the collet, so that the whole is firmly held together. This process is variously modified according to the kind of button. The linen B. before referred to is formed simply of the blank and collet, both being perforated in the middle, and the linen stretched over them, forming the flat B. used for underclothing. This has recently been improved by leaving a bar of metal across the central hole of the blank, over which bar the thread is passed in sewing on the button. The flexible-shank buttons have a padding of paper and cloth between the blank and collet; and this padding, covered with the smaller cloth or silk blank, is made by the pressure to project through the hole of the collet, and form the shank.

Many four and two hole buttons are now made of plastic materials, which are pressed in moulds to the shape required. Horn buttons are made by pressure, the horn having been softened by heat.

BUTTONWOOD—BUTYRIC ACID.

Very elaborate and elegant patterns in relief are at the same time produced on the surface. In this branch of the manufacture the French excel us, both in quality and cheapness.

A very cheap substitute for pearl buttons is made by forcibly compressing clay into moulds. There are several compositions of this kind used, and most of them patented. An attempt is now being made by Messrs Dain, Watts, and Manton of Birmingham, to supersede the French horn buttons by means of a mixture of vegetable fibre and resinous matter. The patent is not yet (1860) completed; but from the specimens that have been shewn to the writer, it appears very likely that this branch of the trade will return to Birmingham—a matter of some importance, as buttons of this kind are now much in request. Buttons made of horn, vegetable ivory, the coquilla nut (see VEGETABLE IVORY, COQUILLA NUT), various hard woods, glass, &c., are now to a great extent superseding covered buttons, as the covered B. has superseded those of gilded brass.

According to the census of 1851, only 11 males and 4 females were employed in Scotland in manufacturing buttons. The number in England and Wales was 2988 males and 3950 females; total, 6938, of whom 4980 were employed in Birmingham. Of these, there were 770 males under 20 years of age, and 1350 above; 1265 females under 20, and 1595 above. Nearly all the fly-press stamping and punching is done by women and girls. The stirrup-stamping is done chiefly by men; and the bone, ivory, and other buttons that are turned in lathes, are chiefly made by men. A considerable number of skilled workmen, receiving high wages, are employed in making dies, punches, and other tools for this trade. The carding of buttons—i. e., sewing the cards on which they are sold—employs a large number of girls. The cost of paper and cards is a serious item in this trade, and the paper-duty presses very heavily. The cards and paper of some of the cheaper pressed four-holes, cost more than the buttons themselves.

BUTTONWOOD. See PLANE.

VARIOUS FORMS OF BUTTRESSES.

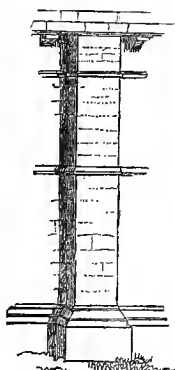

Fountains Abbey,
c. 1170.

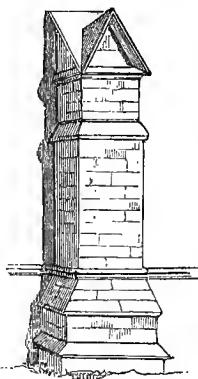

Dorchester, Oxfordshire,
c. 1300.



Canterbury Cathedral.

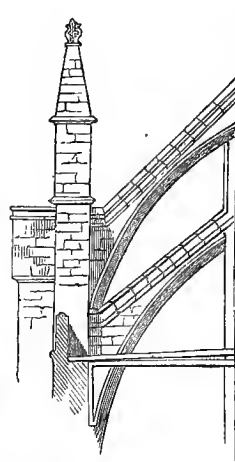

Flying Buttress,
Westminster Abbey.

BUTTRESS (Old Eng. *botress*; Fr. *buttée*), a projection for the purpose of giving additional support or strength to a wall. In the classical style, there were no buttresses, their place being, to a certain extent, supplied by pilasters, antæ, &c. The different stages of Gothic architecture are marked by the form of buttresses employed, almost as distinctly as by the form of the arch. The Norman B. was broad, often semicircular, sometimes dieing into the wall at the top, and never projecting from it to any great extent. Early English buttresses project much more holdly, and are considerably narrower, than the Norman. They are frequently broken into stages, which diminish in size as they ascend. In the decorated style, this division into stages is almost invariable, the B. being often supplied with niches terminating in pinnacles, and very highly ornamented with carving, statues, &c. In the perpendicular style, they retain the forms which had been introduced during the decorated period, the ornamentation, of course, being varied to suit the character of the style. Flying buttresses—i. e., buttresses of which either the upper portion or the whole upright part are detached from the wall, with which they are connected by an arch—were introduced into England

at the period of the Early English, though they existed on the continent previously, where they continued to be used to a greater extent. They were also very common in Scotland. In England, they are generally called arch-buttresses.

BU'TUA ROOT. See CISSAMPELOS.

BUTYRIC ACID may be best obtained by saponifying butter with potash, then adding dilute sulphuric acid till an acid reaction is attained, and distilling about one half of the mixture, adding a little water, and continuing the distillation till the residue is not acid. B. A. may also be obtained by allowing a small quantity of milk-curd to act upon a solution of sugar at a temperature of 77° to 86°, which excites a peculiar process of fermentation resulting in the formation of butyric acid. Some chalk is added to take up the B. A. whenever produced, and the better proportions to employ are 100 sugar, 8 to 10 fresh curd, and 50 chalk, with sufficient water to make a thin liquid. The butyrate of lime is left in the vessel, and on acting upon that by dilute hydrochloric or sulphuric acid, and redistilling, the free B. A. passes over in vapour, and is condensed. B. A. is a transparent, thin, oily liquid, with a most persistent

rancid odour. It is mixable in all proportions in water, alcohol, ether, and oil of vitriol; has the specific gravity 973 (water being 1000), boils at 314°; though it volatilises at ordinary temperatures, as appears from the rancid odour of its vapour. Its chemical symbol is $\text{HO}, \text{C}_4\text{H}_7\text{O}_2$, and it combines with bases, such as lime, soda, &c., to form salts.

BUTYRIC ETHER, or **PINE-APPLE OIL**, is an exceedingly fragrant oil obtained by distilling butyric acid (or the butyrate of lime), alcohol, and sulphuric acid. The material which passes over is the B. E., and it is generally mixed with alcohol, and sold in commerce as *Artificial Pine-apple Oil*. It possesses the same very pleasant flavour which belongs to pine-apples, and there is little doubt that pine-apples owe their flavour to the presence of natural butyric ether. The artificial variety is now extensively used for flavouring confections, as pine-apple drops, for sophisticating bad rum, and for flavouring custards, ices, and creams, as also an acidulated drink or lemonade named Pine-apple Ale. B. E. alone cannot be used in perfumery for handkerchief use, as, when inhaled in even small quantity, it tends to cause irritation of the air-tubes of the lungs and intense headache, but it is employed as one material in the manufacture of compound perfumes. It is composed of ordinary ether ($\text{C}_4\text{H}_8\text{O}$) and butyric acid ($\text{C}_4\text{H}_7\text{O}_2 + \text{HO}$), and its strict chemical name and symbol is the butyrate of the oxide of ethyl ($\text{C}_4\text{H}_5\text{O}, \text{C}_2\text{H}_5\text{O}_2$). It is remarkable that a substance possessing such a disagreeable odour as butyric acid (that of rancid butter) should be capable of forming, in part at least, a substance with such a pleasant flavour as artificial pine-apple oil.

BUXAR, a town of Shahahad, in the sub-presidency of Bengal, situated on the right bank of the Ganges. It is chiefly remarkable as the scene of a victory gained in 1764 by Sir Hector Munro. At the head of 7072 men, of whom only 857 were Europeans, he defeated a native army of 40,000, and captured 133 guns. B. is 62 miles north-east of Benares, and 398 north-west of Calcutta. Pop. 3000.

BUXBAUMIA, a genus of Mosses, of which only one species is known, *B. apylla*, a very rare British plant, remarkable for its apparent want of leaves; the whole plant above ground seeming to consist of a little conical hulk, with minute scales, which are, however, really its leaves.

BUXTON, a town in Derbyshire, 33 miles north-west of Derby. It lies 900 feet above the sea, in a deep valley, surrounded by hills and moors, which have been tastefully planted; the only approach being by a narrow ravine, by which the Wye flows into the Derwent. The new part of the town is much under the level of the old. Five miles to the east of B. is Chee Tor, a perpendicular limestone rock, rising to a height of between 300 and 400 feet from the Wye. B. has for 300 years been famous for its calcareous springs, tepid (82° F.), and cold (discharging 120 gallons of water per minute), and its chalybeate springs. It is visited annually, from June to October, by 12,000 to 14,000 persons, the waters being taken for indigestion, gout, rheumatism, and nervous and cutaneous diseases. Nearly 5000 strangers can be accommodated at one time. There is an institution, called the Devonshire Hospital, containing 100 beds, supported by subscription, where nearly 1000 patients are annually boarded and lodged free of charge. The baths and public walks are numerous. Much of the splendour of B. is due to the Dukes of Devonshire, one of whom, in the last century, at the cost of £120,000, erected an immense three-storied pile of buildings,

of gritstone, called the Crescent, a curve of 200 feet, with wings of 58 feet. It includes two hotels, a library, assembly rooms, &c. Near B. is the Diamond Hill, famous for its crystals; and Poole's Hole, a stalactitic cavern 560 yards long. The Romans had baths here. Mary Queen of Scots resided for some time at B., when in the custody of the Earl of Shrewsbury. B. is approached by railway both from north and south; and the baths, which have been recently rebuilt, are considered among the finest in Europe. The town, which in 1851 had a population of 1235, is rapidly increasing; above 50 new houses are now (1860) in course of erection.

BUXTON, SIR THOMAS FOWELL, a man of singular earnestness and force of character, belonging to the class termed 'philanthropists,' was born in 1786 at Earl's Colne, Essex. The eldest son of a wealthy family, and early deprived of paternal guidance, his youth was distinguished chiefly by a strong development of animal energy, natural enough to a young Englishman whose full stature exceeded 6 feet 4 inches. At the university of Dublin, his mind at length asserted its claims, and the new consciousness of needing to raise the family fortunes animated him to extraordinary efforts. His preparatory education had been almost thrown away, but at 21 he left the university its most distinguished graduate. In that year he married a sister of the celebrated Mrs Fry, and entered business as a brewer, with an energy which in due time was crowned with splendid prosperity. His warm religious and moral impulses soon brought him prominently forward as an advocate of philanthropic interests. Prison discipline formed one of the earliest subjects of his efforts. In 1818, he entered parliament as member for Weymouth, which he continued to represent for about 20 years, taking a prominent part in every debate on such questions as the amelioration of criminal law and of prison discipline, widow-burning and slave emancipation. The latter, in particular, engrossed a large share of his activity for many years, and no man on that side displayed more indomitable zeal and firmness in its advocacy. In 1837, he was rejected by his constituency, and refused ever after to stand for a borough. His philanthropic labours, however, terminated only with his life. In 1840, he received the well-merited distinction of a baronetcy. He died on the 19th February 1845.

BUXTORF, JOHANN, a celebrated orientalist, was born 25th December 1564, at Kamien, in Westphalia; studied at Marburg, Herborn, Basel, and Geneva. After travelling through Germany and Switzerland, he settled at Basel, where he became professor of Hebrew in 1591. He died of the plague, 13th September 1629. In a knowledge of rabbinical literature, he surpassed all his contemporaries. The two works which prove his extensive acquaintance with this recondite branch of theological study, are his *Biblia Hebraica Rabbinica* (Basel, 1618—1619), and his *Tiberias seu Commentarius Masorethicus* (Basel, 1620). The most useful of his grammatical works is the *Lexicon Hebraicum et Chaldaicum* (Basel, 1607).

BUXTORF, JOHANN, the son of the former, was born at Basel, 13th August 1599, and displayed at an early period a decided predilection for the same studies with his father. At five years of age—according to his rather credulous biographers—he could read German, Latin, and Hebrew. To perfect his knowledge of these tongues, he visited Holland, France, and Germany; and in 1630 was appointed to succeed his father in the chair of Hebrew at Basel, where he died 16th August 1664. Besides his *Lexicon Chaldaicum et Syriacum* (Basel, 1622),

and a work of Maimonides, entitled *More Nevochim* (Basel, 1629), which is an exposition of obscure passages of the Old Testament, he published from the MSS. of his father a *Lexicon Chaldaicum, Talmudicum, et Rabbinicum* (Basel, 1639), and *Concordantia Bibliorum Hebraicorum* (Basel, 1632).

BUYXUS. See Box.

BUYING OF PLEAS by lawyers is prohibited by an old Scotch act passed in 1594. It will be explained under the English term *champerty*, to which it is analogous.

BUYKDEREH, a beautiful suburb of Constantinople, from which it is a few miles distant, situated on the Bosphorus, in the midst of the most charming scenery. It forms the summer residence of many of the Christian ambassadors, some of whom have splendid mansions here.

BUZZARD (*Buteo*), a genus of *Accipitres* (q. v.), or birds of prey, of the family *Falconidae*, having a rather small and weak bill, which bends from the base, and is not notched, as in falcons. The legs are short and strong, the tarsi covered with scales or with feathers, the toes short, and the claws strong. Buzzards may be regarded as an inferior kind of eagles; they do not possess courage equal to that of eagles and falcons, nor equal strength of bill or claws. They are large birds; the COMMON B.



Common Buzzard.

(*B. vulgaris*) measuring almost 4 feet from tip to tip of its outstretched wings. It is a bird still pretty common in Britain, although much less so than it formerly was. It is subject to variations of plumage; the prevailing colour is brown, with a considerable mixture of black on the upper parts, and of white or grayish-white on the under. It is sluggish and inactive, in comparison with many other birds of the same family; is usually slow in its flight, and often sits long on a tree, watching for prey, which, when it perceives, it glides silently into the air, and sweeping rapidly down, seizes it in its claws. This B. is plentiful in all the wooded parts of Europe; it is found also in the north of Africa, and is known to exist in the western parts of Asia; but it is doubtful how far it extends over that continent, a distinct although very similar species occurring in the Himalaya Mountains. The Common B. is, however, a North American bird. Tame female buzzards have been known in several instances to exhibit so strong a propensity for incubation, and the rearing

of young, at the proper season, that they have hatched hens' eggs and brought up the chickens, although if chickens not of their own hatching were brought within their reach, they devoured them. Meat given to the B. nurse was carefully divided among her nurslings, but they found out by their own instincts the use of grain and other vegetable food.—The ROUGH-LEGGED B. (*B. lagopus*) is very similar to the Common B., but is at once distinguished by having the tarsi feathered to the toes, whilst in the Common B. they are covered with scales. It is a rarer British bird, yet not of unfrequent occurrence; it is very widely diffused, being found in the Old World from Lapland to the Cape of Good Hope, and equally common in North America. It is most frequently to be seen in marshy districts, and often skimming over marshes, where it makes prey of frogs.—The RED-TAILED HAWK of North America is a species of B. (*Buteo borealis*). It is in very bad repute among American farmers and housewives for its frequent invasion of poultry-yards, from which it has acquired the name of *Hen-hawk*.—Several other species of B. appear to be limited to particular parts of the world, as *Buteo Jackal*—so called from the resemblance of its voice to that of the jackal—to South Africa, and *B. melanosternon* to Australia. The Australian species has the head, chest, and centre of the belly deep black.—The HONEY BUZZARDS (q. v.) belong to a different genus, although nearly allied to the true buzzards, as are also the HARRIERS (q. v.), of which the most common British species, the Marsh Harrier, is sometimes called the *Moor Buzzard*.—BALD B. is a name of the OSPREY (q. v.).

BYBLOS, an ancient city of Phœnicia, now called Jubel, situated at the base of the lower range of the Libanus, about half-way between Tripoli and Beyrout. B. was famous as the birthplace of Adonis, or Thammuz, in whose honour a splendid temple was erected, which attracted many worshippers. The name given to the town by the Jews was Giblah, and its inhabitants the Giblites are noticed in the Scriptures as stone-squarers and calkers of ships. A wall belonging, apparently, to the era of the Crusades, surrounds the town, and the remains of a Roman theatre are still visible.—B. was also the name of a town in the Egyptian Delta, celebrated for its manufacture of papyrus from the byblus or papyrus plant.

BY-LAWS are the private regulations which are usually made by corporate bodies for the control and government of the corporation. They are binding, unless contrary to the laws of the land, or to the charter, or act of incorporation, or, as it has been decided in England, unless they are manifestly unreasonable. Blackstone tells us that the right of making B. was allowed by the law of the Twelve Tables at Rome; and Mr Stephen, in his *Commentaries*, states that in the law of England such a right is so much of course, as regards every corporation, that if the charter by which certain persons are incorporated give to a select body, out of their whole number, a power to make B. as to certain specified matters, the body at large is nevertheless at liberty to make them with regard to all matters not specified. Every corporation, too, can of course alter or repeal the B. which itself has made. By the Municipal Corporation Act, 5 and 6 Will. IV. c. 76, s. 90, borough councils have power to make B. for the government of the borough, and for the prevention and suppression of nuisances; such by-laws, however, not to be of force till the expiration of forty days after the same, or a copy, shall have been sent to one of the secretaries of state, during which period

Her Majesty, with the advice of her privy council, may either disallow the B., or a part, or enlarge the time within which they shall not come into force. Railway companies are required to lay before the Board of Trade, for the approbation of that authority, certified copies of the B. and regulations by which the railway is governed, which B. may be disallowed by the Board at its pleasure. See CANAL ACTS, CARRIER, RAILWAY.

BYNG, GEORGE, VISCOUNT TORRINGTON, a British admiral, born January 27, 1663, eldest son of John Byng, Esq., of Wrotham, Kent, entered the navy as a volunteer at the age of 15, and rapidly rose to the rank of lieutenant. In 1688, he recommended himself to the Prince of Orange by his activity and zeal in attaching the officers of the fleet to the cause of the Revolution, and was advanced to the rank of captain. In 1702 he took part in the capturing and burning of the Spanish fleet at Vigo, and in the following year was made rear-admiral of the red. The attack on Gibraltar was solely confided to his command, and for his gallant conduct at the battle of Malaga he was knighted by Queen Anne. In 1708 he became admiral of the blue, and commanded a squadron fitted out to oppose an intended invasion of Scotland from France, on the part of the Pretender. He pursued the French fleet to the Firth of Forth, took one ship, and forced the fleet back to Dunkirk, on which occasion he was presented with the freedom of the city of Edinburgh. On the breaking out of the rebellion of 1715, he was appointed to the command of a squadron in the Downs, and for important services against the French, was created a baronet. In 1718, he commanded the English fleet sent to Sicily for the protection of the neutrality of Italy, and gained a victory over the Spanish fleet off Messina. Soon after, he was appointed treasurer of the navy and rear-admiral of Great Britain. In January 1721, he was sworn one of the privy council, and in September following, created Baron Southhill and Viscount Torrington. On the revival of the Order of the Bath, in 1725, he was installed one of the knights; and, on the accession of George II., was nominated First Lord of the Admiralty. He represented Plymouth in parliament from 1706 until 1721. Died January 17, 1733.

BYNG, JOHN, a brave but ill-fated British admiral, fourth son of the preceding, born in 1704, entered the navy early, served under his father, and, in 1727, became captain. In 1743, he had attained the rank of admiral of the red. In 1756, he was appointed to command a squadron of ten ships of the line in the Mediterranean, destined for the relief of Minorca, at that time blockaded by a French fleet under La Galissoniere. On the 20th May, B. made the signal to engage, which was obeyed by Rear-admiral West with such impetuosity that several of the enemy's ships were driven out of the line; but B. not advancing to his support, the French were allowed to escape, and Minorca was lost. The dissatisfaction in England, on the news arriving, was taken advantage of by the ministry to avert the public odium from their own inefficient measures. B. was tried by a court-martial, and condemned to death, for a breach of the 12th article of war, but recommended to mercy. Sacrificed to the general indignation, he was shot on board the *Monarch*, at Portsmouth, March 14, 1757, meeting his fate with firmness and resignation. In the fleet, he was not popular, being a strict disciplinarian.

BYNKERSHOEK, CORNELIUS VAN, a Dutch juriconsult, was born at Middelburg, in Zealand, 29th May 1673. He studied at the university of

Franker, took the degree of doctor in 1694, and immediately after commenced to practise as an advocate at the Hague. In 1703, he was elected by the states-general a member of the supreme court, and in the exercise of his functions, soon had occasion to observe how defective and vague was the common law of the country. In 1710, with a view to remedy this, he published the first part of his *Observationes Juris Romani*; in 1719, his *Opuscula Varii Argumenti*; and in 1724, he was elevated to the dignity of president of the supreme court. In 1733, appeared the rest of his *Observationes Juris Romani*. B. now began to devote himself earnestly to the study of Dutch and international law, acquiring, of the former in particular, a most extensive and solid knowledge. His great work on this subject is his *Quaestiones Juris Privati*, which he did not live to finish, and on the other, his *Quaestiones Juris Publici*. In addition to these, B. collected (from his notes) the decisions and proceedings of the supreme court in his time, under the title *Observationes Tumultuariae*, and besides (what is perhaps his most valuable work) made a digest under the title of *Corpus Juris Hollandici et Zelandici*, of all the laws of his own country, whether statutory, or existing in the decisions of courts, or in the practice of the bar, or in the customs of particular places. He died 16th April 1743. A complete edition of his works was published by Professor Vicat of Geneva, in 1761.

BYRGIUS, JUSTUS, or, more properly, JOBST BÜRGI, the inventor of various astronomical instruments, was born 28th February 1552, at Lichtensteig, in the canton of St Gall, Switzerland. In 1759, he went into the service of the learned Landgraf of Hesse, Wilhelm IV. His first work was a celestial globe, the surface of which was plated with silver, and in which the stars were placed according to his own observations. The landgraf sent it to the Emperor Rudolf II., who thought it so beautiful, that in 1604, he appointed B. his own mechanician. B. subsequently went to Austria, but returned to Cassel in 1622, where he died in 1633. Many of his reputed discoveries and inventions are questioned, such as those of logarithms and the proportional compasses; but he seems to have hit upon something like both, while it is certain that he was the inventor of a method of resolving spherical triangles.

BYRLAW, BIRLAW, or BURLAW, the name given to a sort of popular jurisprudence formerly in use in Scotland, in villages and among husbandmen. Sir John Skene, writing in 1597, when the system was in full force, defines B. as '*leges rusticorum, de re rustica latae*—laws made by husbandmen, concerning neighbourhood to be kept among themselves.'—*Reg. Majest.* lib. iv. c. 39; *De Verb. Signif.* voce *Bvrlaw*. As the B. was enacted by the common consent of the villagers or neighbours, so it was administered by judges chosen by them from their own ranks. These judges were commonly called 'byrlaw men,' a name which is still applied in some parts of Scotland to an arbiter, oddsman, or umpire. The courts which they held were called 'byrlaw courts,' and took cognizance of disputes between neighbour and neighbour. B. is supposed to be derived from *boor*, or *baur*, a countryman.

BYRON, GEORGE GORDON, LORD, a great English poet, was born in Holles Street, London, on the 22d of January 1788. He was the only son of Captain John Byron, of the Guards, and Catherine Gordon of Gight, an heiress in Aberdeenshire. Captain Byron and his wife did not live happily. Domestic peace perished in the conflict of their ungovernable tempers.

The husband's habits were profligate in the highest degree, and the wife's fortune was soon squandered in the debauch and at the gambling-table. Separated from her husband, the lady retired to the city of Aberdeen with her little lame boy, whom she passionately loved, her sole income at this time being about £130 per annum. In his 11th year, B. succeeded his grand-uncle, William Lord Byron; and mother and son immediately left the north for Newstead Abbey, the ancient seat of the family, situated a few miles distant from Nottingham, in the romantic district which Sherwood Forest shadowed, and which was once familiar with the bugle of Robin Hood. On succeeding to the title, B. was placed in a private school at Dulwich, and thereafter sent to Harrow. The most remarkable thing about B.'s early years was his extraordinary attachments. Like almost every member of the poetic tribe, he 'had a passion for the name of Mary.' In his 8th year, in Aberdeenshire, he fell in love with Mary Duff. Margaret Parker, a cousin of his own, and who died early, was his next idol. His strongest passion was, however, for Mary Chaworth. This lady he first met when on a visit to Newstead in 1803, at which date he was in his 15th year. Miss Chaworth's father had been killed in a duel by Lord Byron, the grand-uncle of the poet, and marriage would have healed the family feud, and would have joined rich estates. But it was not to be. Miss Chaworth was B.'s senior by two years, and evidently felt little flattered by the worship of the lame Harrow boy. Next year came the parting interview described in *The Dream*, with which every Englishman is familiar now as with a personal experience. In 1805, B. removed to Trinity College, Cambridge; and two years thereafter his first volume of verse, entitled *Hours of Idleness*, was printed at Newark. The poems therein contained were not absolutely without merit, but they might have been written by any well-educated

Autograph of Byron.

lad, who, in addition to ordinary ability, possessed the slightest touch of poetic sensibility. The volume was fiercely assailed by Lord (then Mr) Brougham in the *Edinburgh Review*, and his sarcasms stung B. into a poet. The satire, *English Bards and Scotch Reviewers*, was written in reply to the article in the *Edinburgh*, and the town was taken by a play of wit and a mastery of versification unequalled since the days of Pope. In the babble of praise that immediately arose, B. withdrew from England, visited the shores of the Mediterranean, and sojourned in Turkey and Greece. On his return in 1812, he published the first two cantos of *Childe Harold*, with immense success, and was at once enrolled among the great poets of his country. During the next two years, he produced *The Giaour*, *The Bride of Abydos*, *The Corsair*, and *Lara*. While these brilliant pieces were flowing from his pen, he was indulging in all the revellies and excesses of the metropolis. What was noblest in the man revolted at this mode of life, and, in an effort to escape from it, he married Miss Milbanke, daughter of Sir Ralph Milbanke, a baronet in the county of Durham. This union proved singularly infelicitous. It lasted only a year, and during that brief period, money embarrassments, recriminations, and all the miseries incident to an ill-assorted marriage, were of frequent occurrence. After the birth of her child Ada, Lady Byron retired to her

father's house, and refused to return. This event, from the celebrity of one of the parties, caused considerable excitement in the fashionable world. B. became the subject of all uncharitable tongues. The most popular poet, he was for a space the most unpopular individual in the country. In one of his letters, written from Italy some years later, referring to the slanders current at the time, he thus expresses himself: 'I was accused of every monstrous vice by public rumour and private rancour. My name, which had been a knightly or a noble one since my fathers helped to conquer the kingdom for William the Norman, was tainted. I felt that if what was whispered, and muttered, and murmured was true, I was unfit for England; if false, England was unfit for me. I withdrew.' The separation from his wife, and the departure from England, mark a stage in B.'s genius. A new element of power had entered into his verse; the reader feels it quite distinctly in the magnificent burst of exultation that opens the third canto of the *Childe*—

Once more upon the waters, yet once more!

Misery and indignation stimulated him to remarkable activity. Six months' stay at Geneva produced the third canto of *Childe Harold* and *The Prisoner of Chillon*. *Manfred* and *The Lament of Tasso* were written in 1817. The next year, he was at Venice, and finished *Childe Harold* there; and, in the gay and witty *Beppo*, made an experiment in the new field which he was afterwards to work so successfully. During the next three years, he produced the first five cantos of *Don Juan*, and a number of dramas of various merit, *Cain* and *Werner* being opposite poles. In 1822, he removed to Pisa, and worked there at *Don Juan*, which poem, with the exception of *The Vision of Judgment*, occupied his pen almost up to the close of his life. Morally, his Italian life was unsatisfactory, and his genius was tainted by his indulgences. At the close of his career, he was visited by a new inspiration; the sun, so long obscured, shone out gloriously at its setting. In the summer of 1823, he sailed for Greece, to aid the struggle for independence with his influence and money. He arrived at Missolonghi on the 4th of January 1824. There he found nothing but confusion and contending chiefs; but in three months, he succeeded in evoking some kind of order from the turbulent patriotic chaos. His health, however, began to fail. On the 9th April, he was overtaken by a shower while on horseback, and fever and rheumatism followed. Medical aid was procured, and copious bleeding recommended; but this, B., with characteristic wilfulness, opposed. Before death, he sank into a state of lethargy, and those who were near heard him murmuring about his wife, his sister, and his child. After twenty-four hours' insensibility, he expired on the evening of the 19th April 1824. His body was conveyed to England; and, denied a resting-place in Westminster Abbey, it rests in the family vault in the village church of Hucknall, near Newstead.

Lord B. is a remarkable instance of the fluctuations of literary fashion. Elevated to the highest pinnacle of fame in the heyday of his early popularity, he was unduly depressed after his death, when the false romance which he threw around himself and his writings began to wear away; and it is only during the last ten or twelve years that the proper place has been found for him in the public estimation. He is high, but not the highest. The resources of his intellect were amazing. He gained his first reputation as a depicter of the gloomy and stormful passions. After he wrote *Beppo*, he was surprised to find that he was a humorist; when he reached Greece, he discovered

BYRON BAY—BYTTNERIACEÆ.

an ability for military organisation. When all the school-girls of England fancied their handsome idol with a scowling brow and a curled lip, he was laughing in Italy, and declaring himself to be the most unromantic being in the world. And he was right. Take away all his oriental wrappings, and you discover an honest Englishman, who, above all things, hates cant and humbug. In *Don Juan* and his *Letters* there is a wonderful fund of wit, sarcasm, humour, and knowledge of man. Few men had a clearer eye for fact and reality. His eloquence, pathos, and despair; his *Manfreds* and *Childe Harolds*, were only phases of his mind. Toward the close of his life, he was working toward his real strength, and that lay in wit and the direct representation of human life. If his years had been extended, he would in all likelihood have deserted poetry for prose, gaudy coloured fiction for sober fact; and the assertion may be hazarded, that the English novel would have boasted of another and a greater Fielding.

BYRON BAY lies on the north-east coast of Labrador in North America, its lat. and long. being respectively 54° 40' N., and 57° 30' W.

BYRON ISLAND is situated in the Mulgrave Archipelago of the Pacific Ocean, its lat. and long. being respectively 1° 18' S., and 177° 20' E.

BYSSUS, a name given from ancient Greek and Roman times to the bundle of silky filaments by which many lamellibranchiate mollusks—bivalve shells—attach themselves to rocks or other fixed substances. The B. springs from a cavity at the base of the solitary foot of the mollusk, and its filaments, which are capable of being reproduced if destroyed, are secreted by a glandular tissue which occupies a

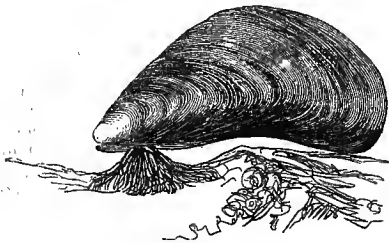

Byssus of Common Mussel.

furrow running nearly to the extremity of the foot. They are united together at the base in a common mass, and are often considerably divergent. They are guided to their place by the foot, and expand into a sort of disc at the point of attachment, so as to have a firm hold. A few common mussels in an aquarium readily afford an opportunity of observing the B., particularly when the filaments are attached to the glass-sides of the vessel. In the *Pinna* (q. v.) of the Mediterranean, the B. is remarkably long and delicate, has a beautiful silky lustre, is very strong, and is capable of being woven into cloth, upon which a very high value is set; but the animal which produces it is now so rare, that it is almost exclusively an article of curiosity. This manufacture was known to the ancients.

BYSSUS (Gr., a fine flaxen or silky substance), a genus established by Linnæus to include some of the lowest and most obscure forms of vegetation, and defined as having a substance like fine down or velvet, simple or feathered. Botanists sometimes ranked it among *Algae*, sometimes among *Fungi*; it has been made the type of a group

Byssaceæ, and placed among Lichens. Some have regarded this group as entitled to the rank of a distinct order, 'comprehending the filamentous fungi found in cellars, and similar plants;' but others reject the genus as altogether spurious. Some of the species once included in it have now been satisfactorily shewn to be Lichens, others to be *Conferveæ*, whilst many appear to be really not distinct vegetable forms, but cryptogamic plants prevented by unfavourable circumstances from proper development. The green incrustations formerly regarded as species of B., have been found to be the primary germination of mosses, often species of *Polytrichum* and *Tortula*. It cannot be said, however, that the nature of all the vegetable forms which have been referred to the genus B., has yet been satisfactorily ascertained. Some of them are very phosphorescent, and are generally found where some higher form of vegetation is undergoing decay.

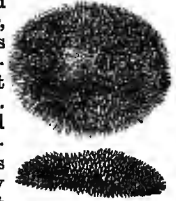

Black-rock Byssus (*Byssus nigra*).

BYSTRÖM, JOH. NIKOLAUS, a celebrated sculptor, was born 18th December 1783, at Philippsstadt, in the province of Wermeland, Sweden, and educated under Sergell of Stockholm. In 1809, he obtained the highest prize in the Swedish Academy of Arts, and in the following year went to Rome, where he executed his first independent work, a 'Drunken Bacchus,' and sent it home. It was received with great approbation, and B. was compelled to repeat it thrice. In 1815, he returned to Stockholm, and surprised the newly elected crown-prince by exhibiting a colossal statue of himself, which he had finished all but the head in Rome, and which he had found means to complete quietly in Stockholm. The crown-prince was highly gratified, and commissioned B. to execute colossal statues of Charles X., XI., and XII. B. returned to Rome, but has since taken up his residence in Stockholm. His chief works are: 'A Nymph going into the Bath,' 'A reclining Juno, suckling the Young Hercules,' 'Hygieia,' 'A Pandora combing her Hair,' 'A Dancing-girl,' a statue of Linnæus, and colossal statues of Charles XIII., Gustavus Adolphus, and Charles XIV. B. excels in the delineation of females and children, but his male figures want strength of character; his conceptions are always true to nature, his grouping skilful and pleasant, and his execution is clear and distinct.

BYTTNERIACEÆ, a natural order of exogenous plants, sometimes united with the order *Sterculiaceæ* (q. v.), and also closely allied to *Malvaceæ* (q. v.), from which it differs, especially in the stamens not being columnar—although more or less united, generally into a cup or tube—also in the anthers being turned inwards, and 2-celled. The species of this order are trees, shrubs, or half-shrubby plants, abounding chiefly in tropical climates, although some are natives of the temperate zones. About 400 have been described. The flowers of many are beautiful. The most important product of the order is COCOA (q. v.). The fruit of *Guazuma ulmifolia*, a native of Brazil, is eaten, being filled with a sweet and pleasant mucilage. The young bark of this tree yields, when macerated, a copious mucilage, and is therefore used in Martinique for clarifying sugar, as is that of *Kydia calycina* in the northern provinces of India. *Guazuma ulmifolia* was introduced into India, and at one time largely cultivated in the Madras presidency, under the name of Bastard Cedar, that its foliage and young shoots might be employed as fodder for cattle. Its straight,

luxuriant young branches yield a strong fibre. The bark of other species of this order also affords a tough fibre, which is employed for making cordage, particularly that of *Microtena* (or *Schillera*) *spectabilis* in the regions on the southern base of the Himalaya, *Abroma augustum* in various parts of India, *Dombeya spectabilis* in Madagascar, and *D. umbellata* in the Isle of Bourbon. *Abroma augustum* has been especially recommended to attention and cultivation on account of its fibre, which is beautiful, white, fine, and strong, and is produced in great abundance. The plant grows to be a handsome small tree, having hairy lobed leaves and beautiful drooping purple flowers; but may be treated much as willows grown for basket-making, and in this way yields two, three, or even four crops of cuttings annually, which are peeled and the bark macerated in order to the separation of the fibre.

BY-TOWN, a town of Upper Canada, on the Ottawa, taking its name from Colonel By of the Royal Engineers. It is now *Ottawa* (q. v.), the capital of United Canada.

BYZANTINE ART. From the time of Constantine the Great, the emperors of the East arrogated to their imperial city the pre-eminence which, for so long a period, ancient Rome had actually possessed; and, as a necessary consequence of this assumption, Constantinople, or Byzantium, as it still continued sometimes to be called, became the rival of the mother-city in the richness and variety of its artistic monuments. In Rome, and, indeed, in the whole of Western Europe, the first effect produced by the influx of the mighty stream of barbarian life, and the consequent dissolution of existing society, was the almost total suppression of artistic effort. It was then that the artists of the West, willing and eager to avail themselves of the invitation held out to them, poured into Constantinople, carrying with them what yet remained of the artistic life of the ancient world. Byzantium was the hearth on which, during the dark period of the middle ages, those feeble sparks of ancient art were kept alive, which served to kindle the new and independent artistic life of the modern world. Not only were the painters and sculptors of Italy indebted to the art of Byzantium for the tradition of that ideal mode of conception to which the term classical is peculiarly applied, but artists in every department derived thence the elements of that technical knowledge without which the embodiment of such conceptions is impossible. This practical acquaintance with the technical rudiments of their respective arts, which could scarcely have been derived from a mere examination of ancient works, was communicated to the fathers of Italian art by living Byzantines, some of them probably the descendants of those whom barbarian conquests had driven into the East, and whom the conquests of a still more barbarous race now restored to Western Europe. It is impossible to doubt that modern art was largely indebted to this circumstance for the marvellous stride which it took immediately after the taking of Constantinople by the Turks. But though its chief value may consist in its having thus transmitted to us the succession of antiquity, B. A. was by no means devoid of original and individual character; and it is only in so far as it possesses this, and not when regarded as a mere conservation of antique types and processes, that it takes rank as a school of art. The characteristic element in B. A. may be described as the earliest artistic recognition and representation to the senses of what was new and peculiar in Christian as opposed to heathen life. To the fullest extent to which it could claim a separate and individual existence, B. A. was Christian art; and

consequently in Germany, where the subject has received more attention than in this country, the two terms are frequently used as synonymous. The appearance of B. A., in this its only peculiar sense, dates from the age of Justinian, i. e., from the earlier half of the 6th c., and its productive period may be said to terminate with the conquest of the Eastern Empire by the Crusaders in 1204. But though its declension dates from this event, B. A. continued to exist in considerable vigour down to the final destruction of the Empire of the East in 1453; and even now may be seen as the inseparable handmaid of the Greek Church, both in Europe and in Asia. It is in this point of view, and more particularly as forming the basis of artistic life in Russia, that B. A. possesses its chief living interest in our day. What Rome was to the Western, Byzantium was to the Eastern European; and the relation of the latter to his mother-city, if it commenced at a somewhat later date, continued during the whole period of the middle ages.

Though the inhabitants of Eastern Europe thus derived their traditions of antiquity from a meaner source than the Romanic nations, they received them more unbroken; and, from first to last, were subjected to their influences during a much longer period. To them the living voice and hand continued to communicate what for nearly a thousand years Italians, Spaniards, and Franks had had to seek in the dead image and letter alone; and if anything still remains unrecorded of ancient thought, it doubtless dwells on Greek, and not on Roman or German tongues. Indolent, luxurious, and dissolute as their ancestors had been in classical times, the citizens of Constantinople were distinguished by an intellectual character, which, unfruitful and enfeebled though it was, was systematic, subtle, mystical, and pedantic. They were eminently an instructed people; but, like individuals whose glory is in the past, they were more conservative than original; and, however justly we may despise the chaff which they engendered, it is impossible to overestimate the value of the corns of gold which clung to their memories.

BYZANTINE ARCHITECTURE. The typical form of B. Architecture, at least as applied to ecclesiastical



Church of St Sophia at Constantinople:
Specimen of Byzantine Architecture.

purposes, was fixed by the church of St Sophia, which still exists as the great mosque of Constantinople. It was built, or rather rebuilt, by the orders of Justinian, the architects being Anthemius of Tralles, and Isidorus, the Elder, of Miletus, and completed 537 A. D. Though the largest and most magnificent, the church of St Sophia was but one of twenty-five churches which were erected in the

capital, and of a vastly greater number of ecclesiastical structures with which the provinces were adorned by the pious emperor. The style thus introduced largely influenced the architecture even of Western Europe; and in St Mark's at Venice, the churches at Ravenna and elsewhere on the Adriatic, and even in the cathedral of Aix-la-Chapelle, we have examples of churches almost purely Byzantine. The fundamental principle in the construction of Byzantine churches was an endlessly varied application of the Roman arch, whilst its exhibition in the form of the cupola was their most characteristic feature. In the St Sophia, as was generally the case, the cupola covered the principal central portion of the church, and was supported by strong and lofty pillars, bound together by bold arches. To this central space were usually joined others of smaller size, which were covered by half-cupolas or arches of more ordinary construction. Though frequently in the form of a Greek

cross, with the great cupola rising in the centre, and smaller or semi-cupolas surmounting the four arms, neither this nor any other plan was consistently adhered to in Byzantine churches. The windows were always semicircular, similar to those in the Romanic churches of Germany, and in our own Saxon or early Norman churches; but the doors were frequently square-headed, after the classical model. Many of the details, such as the square capitals tapering downwards, and the bold projecting mouldings ornamented

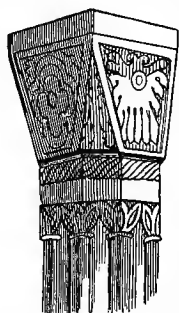

Byzantine Column.

with foliage, seem to have owed their origin entirely to the ingenuity of Byzantine architects. The earlier Byzantine churches were profusely ornamented with mosaics, which, after the admixture of the Gothic element, and the adoption of the pointed arch, gave place to fresco-paintings. The constant use of the Apse (q. v.) is, after the cupola, perhaps their most marked feature. The following division into periods, though, like most divisions of the kind, somewhat arbitrary, has the authority of M. Couchaud, an eminent French architect, in its favour, and is, apparently, adopted by Parker: 1. From the time of Constantine to the middle of the 6th c.; 2. From the beginning of Justinian's reign down to the 11th c., which comprises the greater part of the existing buildings of the pure Byzantine type; 3. From the 11th c. to the conquest of Greece by the Turks, when the influence of the Venetian conquests is apparent in the intermixture of Italian and Gothic details and characteristics.

BYZANTINE SCULPTURE. When contrasted with the ignoble, tasteless, and meaningless productions of the later plastic art of Rome, that of Constantinople claims both admiration and respect. The figures are not deficient in dignity either in form or in attitude, and a deeply Christian spirit is traceable both in their general conception, and in their rich and significant symbolical accompaniments. In sculpture, as in architecture, the peculiar Byzantine type first exhibits itself towards the beginning of the 6th century. Alongside of unmistakable reminiscences of the antique, it exhibits characteristics which are as unquestionably oriental. The figures are positively laden, not with drapery alone, but with costume, which obscures the nobler and freer lines in which the ancients

delighted. The execution is careful, even painful. All this becomes more and more the case as we advance in the order of time, the earliest Christian works, and those immediately suggested by the antique, exhibiting such faults only to a limited extent. Down to the 12th c., the defects which we have described were the worst which could be laid to the charge of B. sculpture, and it is scarcely earlier than the 13th c. that it assumes that mummy-like aspect by which it is too generally known. The art of carving in ivory was practised with great success at Constantinople, and in the examples of it which remain, the gradual decline—the *benumbing process*, as it has been aptly called—may be traced with great distinctness. Of this species of work, in its earlier and better time, a fine specimen in alto-relievo of the 'forty saints' may be seen in the museum at Berlin. The decorations of the churches, and of the sacred vessels used in the service of the altar, formed no insignificant objects of art in the better Byzantine period. Cups, plates, lamps, candlesticks, crosses, and the like, were either of gold or silver, and frequently adorned with jewels; whilst the altar itself, the chancel, and sometimes the whole interior of the church, were covered with precious metals, the panels being adorned with mosaics or frescoes.

BYZANTINE PAINTING. The same characteristics which we have ascribed to the sculpture belonged to the pictorial efforts of the artists of Byzantium, and of its neighbouring countries who were mostly their imitators. The execution was careful and anxious rather than skilful, and such skill as still remained was exhibited in the mechanical perfection with which the gilding of the backgrounds and other details were managed. Of B. pictures, the best existing specimens are to be found in Italy, and belong especially to the school of Sienna. The picture of the Virgin in the church of St Domenico at Sienna by Guido, bearing date 1221, deserves special mention. Much labour was expended on the illumination of MSS. of the Scriptures, and of these many beautiful examples, as fresh as when they were painted, may be seen in most of the larger public libraries of Europe. The chief interest attaching to B. painting consists in the parental relation in which it stood to the art of Italy. Cimabue may be regarded as its immediate heir; and in the works of Giotto, Leonardo da Vinci, Pietro Perugino, and even of Raphael in his earlier time, the traces of the inheritance are quite unmistakable. See PAINTING.

BYZANTINE EMPIRE, also styled the EAST ROMAN, EASTERN, or GREEK EMPIRE, was founded in 395 A. D., when Theodosius the Great, at his death, divided the Roman empire between his two sons, Arcadius and Honorius. The former, a weak and luxurious character, was made emperor of the eastern division, formerly included under the prefectures of the East and of Illyricum—namely, Syria, Asia Minor, and Pontus, stretching along the shores of the Black Sea in Asia; Egypt in Africa; and Thrace, Mœsia (now Bulgaria), Macedonia, Greece, and Crete in Europe. Arcadius left the government of the empire in the hands of his minister, Rufinus, from whom it passed to the eunuch Eutropius, and afterwards to Gainas, the murderer of Rufinus. Gainas fell by his ambition in 401, and the shameless and avaricious Empress Eudoxia ruled until the time of her death, 404. See ARCADIVS. After Theodosius II., a minor, under the guidance of the prefect Prætorio Anthemius, had held the reins during six years, he resigned the government in favour of his sister Pulcheria (Augusta), who ruled powerfully while her brother was kept apart from all state

affairs. Western Illyria (comprehending Pannonia, Dalmatia, and Noricum) was ceded to the Eastern empire by the Roman emperor, Valentinian, III.; and after several victories achieved by the Byzantine general, Ardaburius, over the Persians, a part of Armenia was also annexed. But, nevertheless, Thrace and Macedonia could only be secured from the destructive conquests of Attila by the payment of tribute. After the death of Theodosius II., Pulcheria married the senator Marcianus (450—457), whose firmness repelled the invasions of Attila. Marcianus was followed by Leo I., surnamed Macella (the Butcher), a Thracian of low birth, but elevated to the throne by the commander-in-chief, Aspar, who, being himself an Arian, would not venture to encounter the perils that sovereignty might have entailed on one of his religious views. Leo II., grandson of the former, succeeded, but died after a few months, in consequence of which the crown came into the possession of his father; Zeno (474—491), who was banished by Basiliscus (475), but who re-ascended the throne in 477. Though a weak and unpopular ruler, he contrived to retain his power in spite of several serious revolts. The internal distraction of the empire, to which, as at other times, religious strifes added considerably, increased greatly during the reign of Zeno, and the invasions of the Goths were prevented only by gifts and stratagems. Ariadne, widow of Zeno, by her second marriage, raised the courtier Silentiarius to the throne under the title Anastasius I. (491—518). By the help of the Goths, this monarch overthrew, after a six years' contest, the robber tribes of Mount Taurus. A new enemy, however, now appeared on the Danube in the Bulgarians, against whose desolating raids Anastasius built the Long Wall, to protect the peninsula on which Constantinople lies. The war with the Persians also broke out anew during his reign, and religious tumults often purpled the streets of Constantinople itself. After his death, the army raised Justinus I. to the throne. He maintained his position mainly through the favour of the clergy, whom he had conciliated by his severe persecution of heretics.

His nephew, Justinian (q. v.), succeeded (527—565), and became celebrated by his code of laws, and by the victories of his great generals, Belisarius (q. v.) and Narses (q. v.). But the rapid decline of the empire after his death shewed that he had not been able to give it any internal consolidation or vitality. It was during the reign of Justinian that those pestilent contests of the Blues and Whites against the Greens and Reds (political factions so named from the colours respectively worn) first attained any consequence; and though the first disturbance was terribly chastised by Belisarius in 532, they continued to distract the capital periodically down to the 7th century. Justin II. (565—578), a weak man, governed by his wife, Sophia, yielded a part of Italy to the Longobards, was unsuccessful against the Persians, allowed the Avari to plunder the Danubian provinces, and ultimately became insane through vexation and anxiety. Tiberius, the captain of the guard, was then made regent, and after the death of Justin II., received the imperial dignity. He ruled with mildness and prudence (578—582), purchased a peace with the Avari, concluded the war with Persia, and left as his successor the commander-in-chief, Mauricius, who reigned from 582 to 602. Having replaced on the throne the Persian king, Kósroes II., who had been banished by his subjects, he thus secured the peace of his eastern frontiers; but, on the other hand, the war against the Avari did not prosper. His niggardly treatment of the army caused a military insurrection, in which he was slain along with his son; and

Phocas, one of his generals, was elevated to the throne. Phocas proved a bad ruler. Through his monstrous vices, tyranny, and incapacity for government, the empire lapsed into still deeper anarchy. Suddenly, however, a deliverer appeared in the person of Heraclius (q. v.), son of the exarch or governor-general of Africa, who headed a conspiracy, marched to Constantinople, overthrew the tyrant, and ascended the throne, 610. But great as was the genius of Heraclius, he had to submit to twelve years of defeat before he could organise and discipline a victorious army. In 622, he opened those magnificent campaigns in which the power of Persia was crushed, and which, in the opinion of Gibbon, were equal to those of Scipio or Hannibal. He lived, however, to see more formidable foes in the Arabs, who, inspired by fanatic zeal, and led by the Calif Omar, captured, during 635—641, the countries on the Euphrates, with Syria, Judæa, and Egypt. The power of the Greeks, which was demanded to resist the Arabian invasions, was miserably divided and weakened by their unending religious quarrels, especially the controversy of the Orthodox against the Monothelites (q. v.). The empire was breaking asunder, and Heraclius, now worn out with the fatigues of war, had abandoned his enfeebled senses to pleasure, and his enfeebled intellect to theological discussions. He died in 641. Constantine III., who succeeded his father, Heraclius, also died soon after, and was followed by Heraclionas, who lost the crown, and was mutilated in an insurrection. The next ruler was Constans, son of Constantine III., who ruled from 642 to 668, made himself odious by cruelty, and perished in an insurrection. His son, Constantine IV., Pogonatus (668—685), enforced a treaty of peace on the invading Arabs (675) by his successful use of the Greek fire in warfare. On the other side, he was compelled to pay tribute in 680 to the Bulgarians, who had established themselves in ancient Moesia. Justinian II. (685—711), son and successor of Pogonatus, was victorious in war against the Monothelite Maronites; but was defeated by the Bulgarians (688), and by the Arabs (692). His cruelty caused an insurrection, at the head of which was Leontius, who, in 695, deposed him, cut off his nose (hence his surname *Rhinotmetus*), and banished him to the Tauric Chersonese; in 705, he was restored to the throne, but adversity had taught him no wisdom. A part of his subjects revolted, and the king, abandoned by his army and by the Bulgarians, was assassinated in 711. With him the dynasty of Heraclius expired.

Philippicus Bardanes (the leader of the last insurrection against Justinian II.) was next raised to the throne (711); but having made himself odious by favouring the metaphysical tenets of the Monothelites, he was deposed, and brutally deprived of eyesight (713). His successor, Anastasius II., prudently screened himself from a mutinous army by retiring into a monastery (716), and left the crown to Theodosius III., who abdicated in 717, when Leo, the Isaurian, and general of the army of the East, did not recognise him, and marched with hostile intent to Constantinople. Leo (q. v.) himself ascended the throne in 717, and drove back the Arabs from Constantinople, but unhappily gave occasion, in 726, for that contest concerning the worship of images, which rent the empire for more than a century. In 728, the exarchate of Ravenna was lost, and the eastern provinces became the prey of the Arabs, over whom, however, he won a great victory in Phrygia. He died in 741. Constantine V. (741—775), son of Leo III., on account of his zeal as an iconoclast, was hated by the monks, who gave him the surname 'Coprnyomos,' because

BYZANTINE EMPIRE.

(according to their malicious and uncleanly statement) he had polluted the font at his baptism. He was a brave ruler, recovered from the Arabs parts of Syria and Armenia, and ultimately defeated the Bulgarians, against whom he had long been unsuccessful. His son, Leo IV. (775—780), was a mild ruler; but by the ability of his generals, he made the boundaries of the empire secure against the Arabs. After him, Constantine VI. ascended the throne under the guardianship of his ambitious mother, Irene (q. v.), who raised a powerful party in favour of image-worship. Constantine having made an attempt to liberate himself from the influence of his mother and her paramour, Stauratius, Irene barbarously caused her own son to be blinded (797). He died soon after this atrocity; and Irene, who had boldly conceived the design of marrying the Emperor Charlemagne, and thus uniting the east and west of Europe in one vast realm, excited the opposition which, in 802, placed her treasurer, Nicephorus, on the throne. Irene was banished to Lesbos, where she died in 803. Nicephorus, who fell in battle against the Bulgarians (811), was succeeded by his son, Stauratius, who soon yielded the throne to his brother-in-law, Michael I., from whom it was taken by the Armenian general, Leo V., a powerful ruler, who conquered the Bulgarians, but fell (820) in a conspiracy excited by his zeal against image-worship. Michael II., the Stammerer, was raised from a dungeon to the throne, and ruled until 829. In his reign, Crete and Sicily passed into the hands of the Arabs. Under the rule of his son, Theophilus, who is praised by the Byzantine historians for his love of justice (829—842), the general, Manuel, gained some indecisive victories over the Arabs. Theodora, widow of Theophilus, and guardian of Michael III. (842—867), brought the controversy about images to a close at the council of Nicea (842), when the worship of these was fully sanctioned and re-introduced. During this reign, the government busied itself in the persecution of the Paulicians (q. v.), while the Arabs devastated the Asiatic provinces. Theodora, having been banished to a convent by her son, the government was for some time held by Bardas, uncle of Michael III., and after his assassination, by Basilus I., the Macedonian, who caused Michael to be put to death, and afterwards ruled ably from 867 to 886. But though on the whole successful against the Arabs, the latter contrived to make themselves masters of Syracuse. His dynasty (the Macedonian) maintained itself on the Byzantine throne, with some few interruptions, until 1056. The reign of his son, Leo VI., the Philosopher, (886—912), was not prosperous. The inroads of the Bulgarians and of the Arabs, who, in 904, plundered Thessalonica, continued to increase during the government of his son, Constantine VII., Porphyrogenitus, who ruled mildly but feebly (912—959). Under his son, the dissolute Romanus II. (959—963), Crete was retaken from the Arabs by the vigour of his general, Nicephorus Phocas, who, on the death of the emperor, married his widow, Theophania. She, however, caused him to be murdered in 969, as she wished to marry John Tzimiskes, who ruled till 976, and, like his predecessor, was victorious against the Arabs and Bulgarians, as also the Russians, who about this time began to emerge from obscurity as an enemy of the Byzantine power. His successor, Basilus II. (976—1025), the son of Romanus, conquered the Bulgarian kingdom, and attached it as a province to the empire, which it remained till 1186, when it again became independent. His brother, Constantine VIII. (1025—1028), did not resemble him. Romanus III. next ascended the throne, but was assassinated by his

wife, Zoe, a profligate but crafty princess, who raised successively to the imperial dignity Michael IV. (1034), Michael V. (1041), and Constantine IX. (1042). Meanwhile, Russians and Arabs devastated the realm. In Asia, the Seljuk Turks proved dangerous enemies; while in Lower Italy, the Normans narrowed the Byzantine power to the possession of Otranto. After Constantine's death in 1054, Theodora, sister of Zoe, was elected empress; and on her death in 1056, Michael VI., who was deposed by Isaac I. Comnenus.

With Isaac I. Comnenus, who came to the throne in 1057, the dynasty of the Comnenian emperors began. He retired to a monastery (1059), and was succeeded by Constantine X., whose widow, Eudocia, married Romanus IV., and raised him to the throne. Romanus was deposed in 1071 by Michael VII. (son of Constantine X.), who, in his turn, was dethroned by Nicephorus III. (1078), who reigned until 1081, when he was deposed by Alexius I. Comnenus (q. v.), (1081—1118). This last reign was marked by the commencement of the Crusades. The successors of Alexius—his son, Kalo-Joannes (1118—1143), and Manuel I. (1143—1180)—were able rulers, and victorious in their engagements with the Turks. Manuel's son, Alexius II., was murdered by his guardian, Andronicus (grandson of Alexius I.), who raised himself to the throne. He was the last prince of the Comnenian dynasty, and fell in an insurrection excited by his own cruelty, 1185.

After the first turbulent reign of Isaac II., who was blinded and deposed by his brother, Alexius III., who took the surname of Comnenus in 1195, the Crusaders restored Isaac to the throne (1203), and also crowned his son Alexius IV.; but the restless citizens of Constantinople elected Nicolaus Kanabos, who took the title of Alexius V., and pursuing the usual bloody course, put his predecessor to death.

In 1204, the French and the Venetians (collectively named *Latins*) advanced on Constantinople, and captured the city, April 12, having made themselves masters of the European provinces. The whole was divided into four parts, of which the first, including the metropolis, fell to the lot of Baldwin, Count of Flanders, who was made emperor, and to whom the other participants in the expedition did fealty for their respective shares. The Venetians obtained the coasts of the Adriatic and Ægean seas, a part of the Morea, and several islands; Bonifacius, Count of Montferrat, Macedonia and part of Greece; several dukedoms, countships, &c. were also established at Athens, Philippopolis, and other places for French knights; while a number of Greek princes, both on the mainland and in the islands, maintained their independence. In the west of Asia Minor, Theodorus Lascaris, who had been elected emperor at Constantinople, formally transferred the seat of government to Nicea; and finally, in the north-east of Asia Minor, the governor of the province of Colchis, Alexius Comnenus, ruled at Trebizond with absolute authority; while one of his successors, John Comnenus, even assumed the title of emperor. At Constantinople, neither Baldwin nor his successors could strengthen the sinking empire. Baldwin himself died (1206) a prisoner in the hands of the Bulgarians. After him came his brother Henry, who ruled bravely and wisely till 1216. For the next four years, the empire was actually without a ruler, and a prey to utter anarchy. In 1221, Robert, son of Peter, Count of Auxerre and Courtenay, came to the throne; and was succeeded by John of Brienne, titular king of Jerusalem (1228—1237); and the latter by Baldwin II. (1237—1261).

During these reigns, a great part of the empire was seized by John Vatazes, successor of Theodorus Lascaris of Nicæa (1222—1255). This ruler was followed in Nicæa by Theodorus II. (1255—1259), whose son, Johannes, during his minority, was superseded by Michael VIII., Palæologus, who, by the help of the Genoese, captured Constantinople (July 25, 1261), and thus put an end to the Latin dynasty; though some few Latin principalities maintained themselves till the fall of the Byzantine empire.

Michael, the first of the Palæologi, a powerful prince, really endeavoured to strengthen the realm; but by his unhappy attempt to unite the Greek Church with the Latin, from which it had decisively separated (1054), he gave great offence to the clergy and the people. His son, Andronicus II., who came to the throne, 1282, re-established the Greek ritual. After the death of his son and co-regent, Michael IX. (1320), Andronicus II. was compelled to divide the throne with his grandson, Andronicus III., who became sole emperor, 1328. This monarch unsuccessfully opposed the Turks, who took Nicæa and Nicomedia in 1339, and wasted the European coasts. He died in 1341. Under his son, Johannes V., the Turks first gained a firm footing in the European provinces, and spread themselves from Gallipoli (which they captured in 1357) over other districts. Sultan Murad took Adrianople, 1361, and made it the seat of government. He and his follower, Bajazet, conquered all the Byzantine territories as far as Constantinople. Manuel II., son and successor of Johannes, was besieged in Constantinople by Bajazet, who defeated an army under Sigismund of Hungary, at Nicopolis, in 1396, and compelled the Byzantine monarch to cede to the Turks one of the main streets of the city, which was saved from capture only by Timur's incursions into the Turkish territories, 1402. By this diversion Manuel recovered some portion of the Byzantine provinces; but made so little use of the occasion, that, in 1422, the metropolis was again besieged by Murad II., who, after he had overthrown the force sent to aid the emperor by Ladislaus, king of Hungary, at the battle of Varna, made Constantinople, in 1444, the limit of the domains of Johannes VI., son of Manuel, and compelled him to pay tribute. Constantine, XI., brother of Johannes, bravely but fruitlessly contended against the overwhelming Turkish forces, and fell heroically in the defence of Constantinople, which was captured by Mohammed II., May 29, 1453, when the B. E. was brought to a close. The petty Latin princes who existed here and there in Greece, and the despots, Demetrius and Thomas, who ruled in the Morea, were subdued by Mohammed in 1460; while David, a member of the Comnenian dynasty, the last emperor of Trebizond, submitted in 1461.

It is almost superfluous, after this painful and bloody record of dynastic crimes and tumults, continuing century after century for upwards of a thousand years, to affirm that the history of the world never witnessed so miserable and degraded a caricature of imperial government as the B. E. affords, or to express the conviction, that nature was sternly satisfied to behold it finally swept from the face of the earth, even by the hands of barbarous Turks.

The constitution of the B. E. was founded on the institutions of Diocletian and Constantine the Great, and was purely despotic. The emperors, who were consecrated by the Patriarchs of Constantinople, claimed, as the true descendants of the Cæsars, a sovereignty over the West as well as the East, and styled themselves 'rulers of the

Romans,' even after Charlemagne had founded a new dynasty. Though great influence was at various times exercised by the clergy as well as by women, courtiers, and ministers, the emperors were pure autocrats, having supreme power in all departments of government, and being themselves superior to all laws. By pompous titles, by great splendour of costume, and by a strict observance of an elaborately minute court ceremonial, as well as by the cruel penalties inflicted for any insult offered to the imperial dignity, or to the dignity of the emperor's relatives, they kept themselves sacredly apart from the people. Gradually everything disappeared that might have been a check upon the utter despotism of the supreme power. As early as the 6th c., the consulate was absorbed into the mass of imperial honours, while the traces of the senate which Constantine had established at Byzantium, and which was composed of those on whom the emperor had bestowed the dignity of patriciate, as well as the chartered privileges of the towns, had entirely vanished in the 10th century. The privy council, to whom the conduct of the state was intrusted, was arbitrarily chosen by the emperor. The state-officials were very numerous, and their respective ranks carefully distinguished. They were raised far above the populace by titles and privileges, but were utterly dependent on the throne. Among these, the *Domestici* (including many eunuchs), claimed the highest rank as immediate attendants on the emperor. The rank of the *Courpalates*, who had charge of the four chief imperial palaces, became, in course of time, subordinate to that of the *Protovestiarus*, who was invested with the highest dignity of all. The *Domestici* were made commanders-in-chief of the army. Among them, the *Domesticus* of the East (styled, *par excellence*, *Megadomesticus*) held the highest rank, and finally, under the Palæologi, was considered the first civil and military officer of the realm. The provinces were ruled by governors bound to contribute certain sums to the royal revenue, which gave rise to oppressive exactions. No distinction was made between the state-revenue and the privy-purse. For military service, the land was divided into districts (*Themata*); and the army, down to the later times, consisted almost entirely of foreign mercenary troops, the imperial body-guard, or *Spatharii*, who were mainly Germans, holding the highest rank. The admiral of the fleet was styled *Megas Duca*. In the midst of constant internal and external disturbances, the administration of justice was grossly neglected and abused, though Justinian and other emperors earnestly endeavoured to establish just laws.

BYZANTINE HISTORIANS are those Greek writers who have handled the history of the Byzantine empire. They are divided into three classes—1. Those whose works refer exclusively to Byzantine history; 2. Those who professedly occupy themselves with universal history, but at the same time treat Byzantine history at disproportionate length; 3. Those who write on Byzantine customs, antiquities, architecture, &c. The B. H. are far from faultless, yet, as they are the only sources of information regarding the vast empire of the East, they are invaluable to us. The most interesting and instructive among them, however, are those who confine their attention to a limited number of years, and to the events which transpired under their own observation, or in which they took part. The principal B. H. were collected and published at Paris in 36 vols., with Latin translations under the editorship of P. Philippe Labbé, a Jesuit and his successors (1648—1711). This magnificent collection was reprinted, with additions, at Venice, 1727—1733. In 1823, Niebuhr, assisted by Bekker, the

BYZANTINES—BYZANTIUM.

two Dindorfs, Schopen, Meinecke, and Lachmann, began a new *Corpus Scriptorum Historiæ Byzantinæ*, of which many volumes have already appeared.

BYZANTINES, in Numismatics, is the term applied to coins of the Byzantine empire. Byzantine coins are of gold, silver, and bronze; bear impressions distinct from those of the earlier Roman coins; and were copied in several countries where the Byzantine standard was adopted. The commercial relations of the Eastern empire served to distribute its coinage over almost all the then known world. It was current in India, as well as in the north of Europe. Recently, an increased attention has been paid to the study of Byzantine coins as aids to history.—Saulcy, *Essai de Classification de Suites Monétaires Byzantines* (Metz, 1836).

BYZANTIUM, a city which stood on the Thracian Bosphorus, was first founded by emigrants from Megara in 667 B. C., and rapidly rose to importance as a seat of commerce. Its position was at once secure and enchanting; it commanded the shores of Europe and Asia, had magnificent facilities for trade, and was also encircled with rich, picturesque, and varied scenery. After a time of subjugation under Darius Hystaspes, B. was liberated from the Persian yoke by Pausanias. Along with other Grecian seaports, B. revolted from Athens in 440 B. C., but was captured by Alcibiades (408). Lysander recovered it for the Lacedæ-

monians in 405. Shortly afterwards, it renewed its alliance with Athens, and in 390, Thrasybulus altered its form of government from an oligarchy into a democracy. When Athens again acquired a dangerous importance as a naval power, B., in 356, leagued itself with Chios, Rhodes, and King Mausolus II. of Caria, and crippled the trade of the former city; with which, however, it again formed an alliance, through the influence of Demosthenes, in opposition to Philip of Macedon, who, in 341—340 B. C., vainly besieged Byzantium. Under Alexander the Great, B. retained a certain degree of independence. For some time, B. was tributary to the Gauls, who settled in Thrace, after the death of Brennus (280 B. C.). After the second Punic war, when the Romans began to interfere in the affairs of Grecian and Asiatic cities, B. attached itself to Rome, and, retaining almost entire its former liberties, maintained also its commercial importance. In the civil war between Septimius Severus and Pescennius Niger, B. sided with the latter. It was therefore besieged by Severus, and, after a brave defence of three years' duration, was captured in 196 A. D., and reduced to ruin. Severus, repenting of the desolation which he had made, rebuilt a part of the city under the name of *Augusta Antonina*, and ornamented it with baths, porticos, &c. Caracalla restored to the inhabitants their ancient privileges; and, in 330 A. D., under the name of New Rome or Constantinople, it was made the metropolis of the Roman empire. See CONSTANTINOPLE.



C



THE third letter in all the alphabets derived from the Roman. It corresponds in place to the Greek gamma (Γ), and had originally the same sound—viz., that of *g* in *gun*; as is expressly recorded, and as is proved by very old inscriptions, on which we read *leciones*, *lee*, for what were afterwards written *legiones*, *lege*. This medial or flat guttural sound of *c* was at an early period of Roman history lost in the sharp guttural or *k*-sound (see ALPHABET), and this continued to be the pronunciation of the letter *c* in Latin down at least to the 8th c. of the Christian era, not only in such words as *comes*, *clamo*, but also before the vowels *e* and *i*. Such Latin words as *Cicero*, *fecit*, are uniformly represented in Greek by *Kikero*, *phakit*; and in the times of the Empire, the Germans borrowed *Kaiser*, *keller*, from *Cæsar*, *cellarium*.

It seems difficult, at first sight, to account for the same letter having sounds so different as those heard in call and in civil. The beginning of the transition is to be found in the effect produced upon certain consonants by their standing before *i* followed by a vowel. Thus, in *nation*, *ti* has the effect of *sh*; and out of *diurnal* has sprung *journal*. In such combinations, *i* is originally a semivowel having the force of *y*, and it is easy to see that *tyon*, *dyur*, pronounced in one syllable, cannot but slide into the sibilant or hissing sounds of *shon*, *jur*. A precisely similar effect is produced on the *k*-sound before *ia*, *iu*, *io*; in *Lucius*, *Porcia*, or rather *Lukyus*, *Porkya*, *ky* tends to slide into a hissing sound similar to that of *ty* and *dy*. This tendency shewed itself early in the Latin tongue; and in the vulgar Latin of later ages, and in the Romanic tongues that sprang out of it, it fully developed itself, so that the Italian came to pronounce *Lucia* as if written *Lutshia*. Combinations like *ceo*, *cea*, are little different from *cio* and *cia*, and would naturally follow the same course; and the *s* sound being once associated with the letter *c* in these positions, was gradually extended to it in cases where the *e* or *i* was not followed by a vowel.

The Anglo-Saxon alphabet resembled the Roman, from which it sprang, in having no *k*, and in always using *c* with the sound of *k*; *king* and *keen* were spelled *cyming* and *cene*. It was also without *q*, for which *cw* was used—*quick* being spelled *cwic*. By a process analogous to that described above, such Anglo-Saxon words as *ceorl*, *ceosan* (pro. *kyorl*, *kyosan*), became transformed into the English *churl*, *choose*. And this suggests a natural explanation of the multitude of cases where the *c* of the Latin has been transformed into *ch* in French, and has passed in this form into English—e. g., Lat. *caput*, Fr. *chef*, Eng. *chief*; Lat. *caminus*, Eng. *chimney*; Lat. *carmen*, Eng. *charm*. For as the Anglo-Saxons turned the *karl* or *kori* of the other Gothic nations into *kyorl*, so doubtless the Romanised Gauls corrupted the pronunciation of the Latin *camera*, for example, into *kyamera* (compare

Eng. *cart*, pro. by some *kyart*), which would then readily slide into *chambre*.

In the other Germanic alphabets, which were derived partly from the Roman and partly from the Greek, the Greek *kappa* or *k* is used almost to the exclusion of *c*, which, in German, Swedish, &c., appears only in words borrowed from the Romanic languages. See letter *K*.

In modern English, *c* is pronounced like *k* before the vowels *a*, *o*, *u*, and like *s* before *e*, *i*, and *y*; and where the sharp guttural sound has to be represented before *e*, *i*, and *y*, the Germanic *k* has superseded the Anglo-Saxon *c*, as in *king*, *keen*. In so far as mere sound is concerned, *c* is a superfluous letter in English; in every case its power could be represented either by *k* or by *s*. In the corresponding words of the several Aryan languages, we find various substitutions for *c*, thus: Lat. *calamus*, Eng. *halm* (stalk), Rus. *soloma*; Lat. *cord*, Eng. *heart*, Rus. *serdtse*; Lat. *collum*, Ger. *hals* (neck); Lat. *acer* (sharp), Fr. *aigre*, Eng. *eager*; Lat. *duc* (lead or draw), Ger. *zog*, Eng. *tug*; Gr. *pepo*, Lat. *coquo*, Eng. *cook*; Lat. *dictus*, Ital. *ditto*. *C* sometimes disappears before *l* and *r*; thus: Gr. *kleo* (to sound one's fame, allied to *kaleo*, to call or shout), Lat. *laudo*, to praise, Ger. *laut*, voice, Eng. *loud*, Old Ger. *hlud*, fame (hence *Hludwig* or *Clodowig*, *Clovis*, *Louis*).

C, in Music, is the name of one of the notes of the gamut. The scale of *C* major has neither flats nor sharps, and therefore is called the natural scale. The different octaves of the gamut, beginning with *C*, are called by the Germans the great, small, one-stroked, two-stroked, &c., beginning with

; thus, *C*, *c*, \bar{c} , $\bar{\bar{c}}$.

C is also the sound on which the system of music is founded, and from which the mathematical proportions of intervals are taken; that is, a string of a given length sounding *C*, when divided into certain proportions, is made to produce harmonically the intervals of the different fundamental chords.

C MAJOR, the first of the twelve major keys in modern music; being the natural scale, it has no signature.

C MINOR, the tonic minor of *C* major, has three flats for its signature—viz., B flat, E flat, and A flat.

CAABA. See KAABA.

CAA'ING WHALE (*Globicephalus deductor*), an interesting cetaceous animal, which has been very generally included by naturalists in the genus *Delphinus* with dolphins (q. v.) and porpoises (q. v.), being named by some *Delphinus melas* (Gr. black), by others *D. globiceps*, from the round form of its head, but which has recently been separated from the true dolphins, either as a species of porpoise (*Phocæna*), or as the type of a distinct genus, *Globicephalus*, principally characterised by the rounded muzzle, and the convex and rounded top of the head. The general form of the animal is not unlike that of the

common porpoise, but it is much larger, being from 16 to 24 feet in length. The body is thick, its circumference at the origin of the dorsal fin, where it is greatest, being rather more than 10 feet, tapering towards the tail, which is deeply forked. The

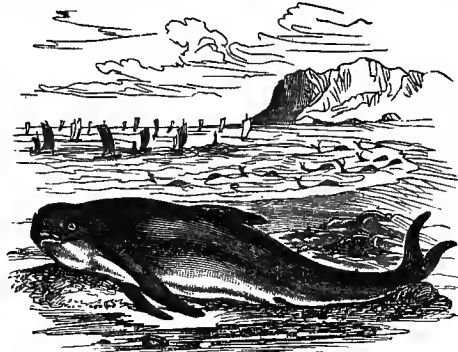

Caaing Whale.

pectoral fins are remarkably long and narrow, fully 5 feet in length, differing very much in this respect from those of every other known cetaceous animal. The whole number of vertebrae is 55. The colour is black, with a white streak from the throat to the vent; and the skin is beautifully smooth, shining like oiled silk.

The C. W. feeds on cod, ling, and other large fishes, but also to a great extent on cephalopodous mollusca, the cuttle-fish, indeed, seeming to be its principal food. It is the most gregarious of all the Cetacea, great shoals or herds being usually seen together in the northern seas which it inhabits. These herds exhibit the same propensity with flocks of sheep, when pressed by any danger, to follow their leaders, so that when they are hemmed in by boats, if one break through to the open sea, all escape; but if one is driven ashore, the rest rush forward with such blind impetuosity as to strand themselves upon the beach, where they become an easy prey and rich prize to their pursuers. The appearance of a herd of caaing whales in a northern bay produces a scene of great excitement, and every boat is in requisition. From 50 to 100 whales are often captured, and it is recorded that 1110 were killed, in the winter of 1809—1810, at Hvalford, in Iceland. The word *caaing* is not the Scottish form of *calling*, as has been supposed, but is a totally different Scotch word, which signifies *driving*. C. W. appears to be originally an Orkney or Zetland name. The same animal is known to sailors as the Black Whale, the Howling Whale, the Social Whale, and the Pilot-fish.—Another species of the same genus, *G. Rissoanus*, 9 or 10 feet long, the male of a bluish-white colour, the female brown, both sexes marked with irregular white lines and brown spots, is found in the Mediterranean.

CABAGAN, a thriving town, situated at the northern extremity of the island of Luzon, one of the Philippines, with a population of about 11,000.

CABAL, a term employed to denote a small, intriguing, factious party in the state, and also a union of several such, which, for political or personal ends, agree to modify or sacrifice their principles. The word was used to describe an English ministry in the reign of Charles II., the initials of whose names composed CABAL—viz., Clifford, Ashley, Buckingham, Arlington, and Lauderdale. This was not the origin of the word, however, as

some have supposed; but merely the ingenious application of a word previously in use, and which appears to have been derived from the French *cabale*, possessing a similar signification.

CABANIS, PIERRE JEAN GEORGES, a French physician, philosophical writer, and partisan of Mirabeau in the Revolution, was born at Cosnac, in the department of the Charente-Inférieure, 1757. When he had completed his studies in Paris (1773), he went to Warsaw, in the capacity of secretary to a Polish magnate. On his return to Paris, he was for some time engaged in literary pursuits, from which he turned his attention to an earnest study of medicine. At the outbreak of the Revolution, he attached himself to the liberal side, but detested the cruelties which followed. For Mirabeau, whose opinions he received, he wrote a work on national education, which was published after the death of that great orator (1791). C. was one of the Council of Five Hundred, afterwards member of the senate, and administrator of the hospitals of Paris. He died May 5, 1808. His chief work, *Rapports du Physique et du Moral de l'Homme*, completed in 1802, gained its author a considerable reputation as a writer and philosopher. The work displays no mean power of observation and analysis, but is vitiated by a sensationalism so absolute, that it seems at first sight as if the author were burlesquing with grave irony the doctrines of his brother-materialists. He denies that the soul is an entity; it is only a faculty; and declares the brain to be merely a particular organ specially fitted to produce thought, as the stomach and the intestines perform the function of digestion. C. traces this grotesque analogy through all its niceties, and at last triumphantly concludes, 'that the brain digests impressions and organically secretes thought!'

CABATUAN, a city of the province of Iloilo, on the island of Panay, one of the Philippines. It is situated on the banks of the river Tiguin, which so abounds with crocodiles that fishing is unsafe. Navigation is very uncertain, the river being sometimes nearly dry, while at others it overflows its banks, and deluges the surrounding country. The city was founded in 1732, and possesses a population of 23,000, who are chiefly engaged in the production of rice, and of cocoa-nut oil.

CABAZERA, capital of the province of Cagayan, island of Luzon, Philippines. Pop. 15,000. Tobacco is grown very extensively in the province, and its manufacture affords employment to large numbers of people.

CABBAGE (*Brassica oleracea*; see BRASSICA), a plant in most general cultivation for culinary purposes in Europe and other countries, cultivated also to a considerable extent for feeding cattle. It is a native of the rocky shores of Britain and other parts of Europe, more plentiful on the shores of the Mediterranean than in more northern latitudes, and in its wild state is generally from a foot to two feet high. This plant has been cultivated in Europe from time immemorial; it has likewise been cultivated from an early period in gardens and about villages in India. Few plants shew so great a tendency to vary in their form through cultivation; and among the varieties of this one species are reckoned several of our most esteemed culinary vegetables, such as Kale (q. v.) or Greens, Borecole, Colewort (q. v.), Savoy (q. v.), Kohl Rabi (q. v.), Cauliflower (q. v.), and Broccoli (q. v.)—plants which differ much in their appearance and in the particular qualities for which they are valuable, both from each other and from the original wild plant.

The wild C. has smooth sea-green leaves, waved

CABBAGE BARK—CABBALA.

and variously indented; the boiling of the leaves, or their forming close heads at a certain stage of the growth of the plant, so that the inner leaves are blanched, is peculiar to those cultivated varieties which commonly receive the name of cabbage.

The ordinary varieties of C. are often called by the general name of *White C.*, to distinguish them from the *Red C.*, which is of a deep brownish-red or purplish colour, and is chiefly used for pickling, for which purpose it is much esteemed. The *Tree C.*, or *Cow C.*, is a variety cultivated for cattle, especially in the Channel Islands and the north of France, of which the leaves do not close together into compact heads, but which is remarkable for its great height—reaching, when it is in flower, ten feet on rich soils—and for its branching stem. The stems of this kind are sometimes used as stakes for pease, and even as cross-spars for thatched roofs. The *Portugal* or *Tranchuda C.*, also known as *Couve Tronchuda*, is a variety remarkable for its delicacy, and for the large midribs of its leaves, which are often used like sea-kale. It is an article of luxury like cauliflower, and requires a somewhat similar cultivation.—C.-seed is sown either in spring or autumn, and the seedlings transplanted in rows at distances of two feet or upwards, according to the size of the variety. They are often planted closer, and the alternate plants cut young for open greens, for which the sprouts that arise from the stem of some varieties after the head has been cut off are also used. Cabbages require a rich, well-manured soil, and the earth about the roots ought to be often stirred. By sowing and planting at different dates and of different varieties, a succession is secured in the garden; and when winter approaches, part of the principal crop may be taken up and laid in a sloping position, so that only the heads are above the earth, in which way they are generally preserved without injury. In some places, cabbages are completely buried in the earth, the plants not being allowed to touch each other; and this method succeeds well in peaty or sandy soils.

The C., considered as food, contains more than 90 per cent. of water, and therefore cannot be very nutritious: 100 parts of the ordinary C. consist of

Extractive,	2.34
Gummy matters,	2.89
Resin,	0.05
Vegetable albumen,	0.29
Green fecula,	0.63
Water and salts,	93.80

The digestibility of C. varies according as it is partaken of raw or boiled: thus, raw C. alone is digested in 2½ hours; raw C. with vinegar, in 2 hours; and boiled C. takes 4½ hours. Immense quantities of cabbages are used in Germany as *Sauer Kraut* (q. v.).

CABBAGE BARK. See ANDIRA.

CABBAGE BUTTERFLY, a name common to several species of butterfly, the larvæ of which devour the leaves of cruciferous plants, especially of the cabbage tribe, and are popularly known as cabbage-worms or kale-worms. The **LARGE C. B.**, or **Large White Garden Butterfly** (*Pontia Brassicae*, or *Pieris Brassicae*), is one of the most common of British butterflies. It is white; the wings tipped and spotted with black. The wings, when expanded, measure from 2½ to 3 inches across. The antennæ terminate in an ovoid club. The female lays her eggs, which are conical and bright yellow, in clusters of 20 or 30, on the leaves of the plants which are the destined food of the caterpillars. The caterpillars, when fully grown, are about 1 inch or 1½ inch long, and are excessively voracious, eating twice their own weight of cabbage-leaf in 24 hours. When full grown, they suspend themselves

by their tails, often under ledges of garden-walls, or similar projections, and are metamorphosed into shining pale-green chrysalids, spotted with black, from which the perfect insect emerges, either in the same season or after the lapse of a winter—no longer to devour cabbage-leaves, but to subsist delicately upon honey, which it sucks from flowers. See INSECTS.—The **SMALL C. B.**, or **Small Garden White Butterfly**, sometimes called the **TURNIP BUTTERFLY** (*Pontia* or *Pieris Rapæ*), very much resembles the **Large C. B.**, but the expanse of the wings is only about 2 inches. The eggs are laid singly on the under side of the leaves of cabbages, turnips, &c., and the caterpillars, which are of a velvety appearance, pale green, with a yellow line along the back, and a yellow dotted line on each side, sometimes appear in great numbers, and prove very destructive. They bore into the hearts of cabbages, instead of merely stripping the leaves, like those of the last species, and thus are a greater pest, even when comparatively few. The chrysalis is of a pale reddish-brown colour, freckled with black.—A third species, also common in Britain, the **GREEN-VEINED WHITE BUTTERFLY** (*Pontia* or *Pieris Napi*), very nearly resembles the small cabbage butterfly.—The excessive multiplication of these insects is generally prevented by small birds, which devour them and their caterpillars, and by insects of the *Ichneumon* (q. v.) tribe, which lay their eggs in the caterpillars, that their own larvæ may feed on them.

CABBAGE FLY (*Anthomyia Brassicae*), a fly of the same family with the house-fly, flesh-fly, &c., and of which the larvæ or maggots often do great injury to the roots of cabbages, and sometimes to those of turnips. It is of the same genus with the fly generally known as the **Turnip Fly** (q. v.), and also with the **Potato Fly** (q. v.), **Beet Fly** (q. v.), &c. It is about one-fourth of an inch in length, and half an inch in expanse of wings; of an ash-gray colour; the male having a silvery gray face, and a long black streak on the forehead; the female, a silvery white face, without any black streak; the abdomen of the male is linear, that of the female terminates conically; the eyes of the male nearly meet on the crown, those of the female are distant, with a broad black stripe between them. The larva is very similar to that of the flesh-fly—yellowish white, tapering to the head, which has two black hooks. The pupa is rust-coloured and horny.

CABBAGE MOTH (*Mamestra* or *Noctua Brassicae*), a species of moth, the caterpillar of which feeds on cabbage and turnip leaves, and is sometimes very destructive. The caterpillar is greenish-black, and changes to a brown pupa in autumn. The perfect insect is of a rich mottled-brown colour, the upper wings clouded and waved with darker brown, and having pale and white spots, a yellowish line near the fringe, the fringe dotted with black and ochre, the under wings brownish and white.

CABBAGE PALM, or **CABBAGE TREE**, a name given in different countries to different species of Palm, the great terminal bud of which—the **Palm Cabbage**—is eaten like cabbage. The C. P. of the West Indies is *Areca oleracea*. The Southern States of America have also their C. P. or **Cabbage Tree**, otherwise called the **Palmetto** (*Chamaerops Palmetto*). See **ARECA**, **EUTERPE**, **PALM**, and **PALMETTO**.

CABBALA (from Heb. *kibbel*, to receive), the received doctrine, by which is not to be understood the popularly accepted doctrine, but that inner or mystical interpretation of the Law which the Cabbalists allege that Moses received from God in the mount, and subsequently taught to Joshua, who in his turn communicated it to the seventy elders, and

which has ever since been the treasure of the select Jews. Since the 12th c., the study of this secret lore has gradually resulted in a distinct school and literature, the elements of which, however, are already visible in the Macedonian epoch, and the real or historical source of which is to be found in the eastern doctrine of emanation. In Philo, in the Talmud, &c., we certainly find theological-philosophical conceptions, which were at a later period taken up and modified; but the first book on cosmogony is *Jezirah*, a production of the 7th c., attributed to Akiba. After the second half of the 12th c., the Cabbalistic doctrines, which had at first been confined to such high themes as God and creation, began to include exegesis, ethics, and philosophy, and so became a kind of mystical religious philosophy. The numerous cabbalistic writings composed during the three subsequent centuries, professed to teach the secret or mystical sense of Holy Writ, and the principles on which it is grounded, the higher meaning of the Law, as well as the method of performing miracles, by the use of divine names and sacred incantations. The cabbalists, moreover, prepared books, which they attributed to the oldest authorities—for instance, *Sohar*, a work written in Aramaic, during the 13th c., and fathered upon Simeon-ben-Joachai, a scholar of Akiba. This became the Bible of the Cabbalistic neophytes. The chief opponents of the Cabbalists were the philosophers, and in part the Talmudists. Towards the close of the 16th c., the Cabbalistic wisdom, which by that time had degenerated into magic and word-juggling, received a new impulse from its teachers in Palestine and Italy. Since the time of Reuchlin, many Christian scholars have investigated the subject.

CABEIRI, divinities anciently worshipped in Egypt, Phœnicia, Asia Minor, and Greece. The ancients have left us very obscure notices of the C., and learned men have been unable to reach any satisfactory conclusions with regard to them and their worship. It is certain that the worship had both its mysteries and its orgies, and it appears also that the C. were amongst the inferior divinities, and regarded as dwelling upon the earth, like the Curetes, Corybantes, and Dactyles, and were probably representatives of the powers of nature.

CABÈS, or **KHABS**, **GULF OF** (ancient *Syrtris Minor*), an inlet of the Mediterranean Sea, lying between the islands of Kerkenna and Jerba, on the north-east coast of Africa, in lat. about 34° N., and long. from 10° to 11° E. The town of Cabes (ancient *Tacape*) stands at the head of the gulf.

CABET, **ÉTIENNE**, a notable French communist, was born at Dijon, January 2, 1788, and educated for the bar, but turned his attention to literature and politics. Under the Restoration, he was one of the leaders of the Carbonari (q. v.), and in 1831 was elected deputy for the department of Côte d'Or. Soon afterwards, he published a *History of the July Revolution* (1832), started a Radical Sunday paper, *Le Populaire* (1833), and, on account of an article in this paper, was sentenced to two years' imprisonment, but escaped to London. Here he wrote brochures against the July government, and began his communistic studies. After the amnesty, 1839, he returned to Paris, and published a *History of the French Revolution* (4 vols., 1840), bestowing great praise on the old Jacobins. He attracted far more notice by his *Voyage en Italie* (1840), a 'philosophical and social romance,' describing a communistic Utopia. The work obtained great popularity among the working-classes of Paris. C. next proceeded to turn his 'philosophical romance' into a reality, and published (1847) in his journal, *Le Populaire*,

the statutes for the formation of an 'Icarian colony' on the Red River in Texas; inviting his followers to emigrate. The first division sailed on the 2d February 1848, but a short experience convinced them that Texas was anything but a Utopia. Their complaints reached Europe, but did not deter C. from embarking at the head of a second band of colonists. On his arrival, he learned that the Mormons had just been expelled from Nauvoo, in Illinois, and that their city was left deserted. The Icarians established themselves there in May 1850. C. now returned to France, to repel the accusations against his probity which had been circulated during his absence, and to obtain a reversal of the judgment which had been formally pronounced against him, 30th September 1849. Having succeeded in this, he went back to Nauvoo, where he governed, as a sort of dictator, his petty colony, until 1856, when he was deprived of his office, and obliged to flee to St Louis, where he died 9th December of the same year. C. was a shallow thinker, a weak ruler, and a poor writer; but his success, such as it was, is a proof of what can be accomplished by what has been termed, with more vigour than elegance, 'pig-headed perseverance.'

CABEZA DEL BUEY, a town of the new province of Badajoz, Spain, about 86 miles east-south-east of the city of Badajoz. It is situated on the northern slope of the Sierra Pedregosa, has manufactures of woollens and linens, and a trade in cattle and agricultural produce. Pop. 5395.

CABEZÓN DE LA SAL, a town of Spain, in the province of Valladolid, about 7 miles north-north-east of the city of that name. It is situated on the Pisuerga, and is celebrated as the scene of one of the first battles of the Peninsular campaign, in which the Spaniards were signally defeated by the French. Pop. 2000.

CABIN is the general name for a room or apartment on shipboard. In ships of war, the living-rooms of the admirals and captains are called 'state' cabins, and are fitted up with much elegance, with a gallery or balcony projecting at the stern. The chief officers below the captain have their cabins on either side of the main-deck; while those of the subordinate commissioned officers are, in large ships, on either side of the lower or orlop deck. All the cabins of a ship of war are enclosed by light panelling, which is quickly removable when preparing for action.

CABINET (Ital. *gabinetto*), a small chamber set apart for some special purpose, such as the conservation of works of art, antiquities, specimens of natural objects, models, and the like. From signifying the chamber in which such collections are contained, the term C. has recently come to be employed by us, in imitation of the French, to signify the collections themselves, and this even when they fill many rooms or galleries. It often means simply a small room appended to a larger one, when it is also called an anteroom, a retiring-room, and the like. See **CLOSET**.—**CABINET PICTURE**, a picture suited for a cabinet or small room. C. pictures are generally small in size, highly finished, and thus suited for close inspection.

CABINET. See **MINISTRY**.

CABLE is either a large rope, or a chain of iron links, chiefly employed on shipboard to suspend and retain the anchors. Rope cables are made of the best hemp, twisted into a mass of great compactness and strength. The circumference varies from about 3 inches to 26. A certain number of yarns are twisted to form a *lissum*; three *lissums* are twisted in an opposite

CABLE-MOULDING—CABOT.

direction to form a *strand*; and three strands are twisted (in the same direction as the yarns in a lissum) to form a *cable*. The number of yarns in a C. of given size is not always alike, because the yarns slightly vary in thickness; but the following is one among many tables which have been prepared relating to cables of 120 fathoms, and of the usual degrees of thickness:

Inchcs. Circumference.	Yarns.	Lbs.
3	= 48	= 192
6	= 174	= 696
9	= 393	= 1572
12	= 699	= 2796
15	= 1093	= 4372
18	= 1574	= 6296
20	= 1943	= 7772

Some cables are made with four strands, but three is the common number. If a C. be twisted too much, it is stiff; if too little, it is weak. The strength of a C. of 18 inches' circumference is found to be about 60 tons; and for other dimensions, the strength varies according to the cube of the diameter. On shipboard, cables receive the names of *chief cables*, *bower cables*, &c., according to the anchor to which they are attached. During the last great European war, the largest ships in the British navy carried ten cables, most of which were about two feet, or a little more, in circumference. Although ships seldom anchor at a greater depth than 40 fathoms, it is not deemed safe to trust the anchor to a C. of 120 fathoms, lest the C. should be jerked by a high sea when too nearly perpendicular; two are spliced together at the ends, and the C. of 240 fathoms thus produced acts more like an elastic spring.

CHAIN CABLES are made of links, the length of each of which is generally about six diameters of the iron of which it is made, and the breadth about three and a half diameters. In government contracts, chain cables are required to be made in 12½ fathoms lengths, with one swivel in the

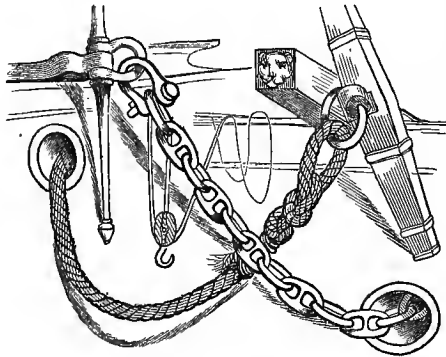

Chain and Hemp Cables.

middle of every alternate length, and one joining-shackle in each length. The stay-pins, to strengthen the links, are of cast iron. The bar or rod from which each link is made, has the two ends cut diagonally; it is bent into the form of a nearly complete oval ring; and then the two ends are joined and welded, the stay-pin being at the same time introduced at the proper place. Besides the ordinary links, there are end-links, joining-shackles, splicing-tails, mooring-swivels, and bending-swivels. The sizes of chain cables are denoted by the thickness of the rod-iron selected for the links. The following table gives certain ascertained quantities concerning the cables in ordinary use:

Thickness of Iron.	Weight of Stay-pin.	Weight per Fathom.	Breaking Strain.
½ inch.	¼ oz.	13½ lbs.	6 tons.
1 "	3½ "	54 "	24 "
1½ "	12 "	121 "	60 "
2 "	28 "	215 "	99 "
2½ "	40 "	272 "	126 "

There are a few defects in chain cables as compared with those of hemp: such as the greater weight, the less elasticity, and the greater care required in management; but the advantages more than counterbalance these defects, and have led to the very extensive adoption of chain cables both in men-of-war and in merchant-ships.

CABLE-MOULDING, in Architecture, is a moulding cut in the form of a rope, the twisting being prominently shewn. It was much used in the later Norman style.

CABLING, the moulding by which the hollow parts in the flutes of columns and pilasters in classical architecture are often partially filled. The C. seldom extends beyond the third part of the shaft from the ground.

CABOCHED, or CABOSSED, an heraldic term, from the old French word *caboche*, the head. When the head of an animal is borne, without any part of the neck, and exhibited full in face, it is said to be caboched.



Stag's Head
Caboched.

CABOISE, or CAMBOOSE (Danish, *kabyse*, a cook's room in a ship; Ger. *kabuse*, a little room), is the name of the kitchen or cook-room in a merchant-ship. In coasting-vessels, the term is applied to a portable cast-iron stove on the deck, where food is cooked.

CABOT, the name of two Venetians, father and son, both celebrated as navigators and discoverers. —GIOVANNI CABOT, or CABOTTO, the father, whose business compelled him to reside much in Bristol, was appointed by Henry VII., March 5, 1496, to the command of a squadron of five vessels on a voyage of discovery in the Atlantic Ocean. In this expedition he was accompanied by his sons Ludovico, Sebastiano (horn at Bristol, 1477), and Sanzio. On the 24th of June 1497, the coast of Labrador, North America, was sighted. The merit of this discovery has been generally ascribed to the navigator's second son, Sebastian C., the most scientific of the family; but an extract from a chart preserved by Hakluyt mentions the father before the son. The expedition returned in August 1497. In 1498, a second was made, with what results we do not know; and in 1499, a third to the Gulf of Mexico. About this time, Giovanni, the father, appears to have died, and we hear no more of *Sebastian* till 1512, when he entered the service of Ferdinand, king of Spain. During the year 1515, he was engaged in revising maps and charts, in connection with his profession, and in planning an exploration of the North-west Passage to Asia, which, however, was laid aside on account of the death of Ferdinand in 1516. C., who seems to have been no favourite with the Spanish courtiers, was now subjected to a series of contemptible insults. This usage induced him to return to England, and in 1517, he was appointed by Henry VIII. to the command of an expedition to Labrador. He reached lat. 67½° N., and entered Hudson's Bay, where he gave names to several places; but the expedition proved on the whole a failure, on account of the cowardice or malice of his vice-commandant, Sir Thomas Perté. C. now entered again into the Spanish service, was made pilot-major of the kingdom by Charles V., and commanded an expedition which examined the coast of Brazil and La Plata, which he attempted to colonise. In

1531, he returned to Spain, and resumed his old situation; but in 1548, he once more betook himself to England, where he was well received by King Edward VI., who made him Inspector of the Navy, and gave him a pension. To this monarch he seems to have explained the variation of the magnetic needle in several places, which he was among the first, if not the very first, to notice particularly. In 1553, C. was the prime mover and director of the expedition of Merchant Adventurers which opened to England an important commerce with Russia. It is not known exactly when C. died.—Memoir of Sebastian Cabot (Lond. 1831).

CABOTZ. See CUSO.

CABRA (ancient *Ægabrum*), a town of Spain, in the province of Cordova, 30 miles south-east of the city of that name. C. is irregularly built between two hills, and surrounded with gardens; vineyards in the neighbourhood produce excellent wine. It is chiefly agricultural; but it has manufactures of woollen, linen, hats, soap, earthenware, &c. Pop. 11,576.

CABRAL, or CABRERA, PEDRO ALVAREZ, the discoverer of Brazil, was descended from an old and patrician Portuguese family. Nothing is known of his early life, save the fact, that he must have recommended himself by talent and enterprise to King Emanuel of Portugal, who, after the first voyage of Vasco de Gama, appointed C. to the command of a fleet of 13 vessels, carrying 1200 men, and bound for the East Indies. On the 9th March 1500, he sailed from Lisbon. To avoid the inconvenience of being becalmed on the coast of Africa, he took a course too far westerly, fell into the South American current of the Atlantic, and was carried to the unknown coast of Brazil, of which he claimed possession for the king of Portugal, April 24, 1500, naming the new country 'Terra da Santa Cruz.' After sending home one vessel to bear news of this great accidental discovery, C. sailed for India; but on the 29th of May, four of his vessels foundered, and all on board perished, including Diaz the great navigator; and soon afterwards three more vessels were lost. C. therefore landed at Mozambique, on the east coast of Africa, of which he first gave clear information, and also discovered (August 23) the Antschedives Islands, of which he described correctly the position. Hence he sailed to Calicut, where, having made the terror of his arms felt, he was permitted to found a factory; entered into successful negotiations with native rulers, and thus established the first commercial treaty between Portugal and India. He returned from India, bringing with him a considerable booty, and arrived in the port of Lisbon, July 31, 1501. It appears probable that the king was dissatisfied with the results of the expedition (although it had annexed Brazil to the crown of Portugal), for subsequently we find no mention made of C. among other discoverers. At the request of C., Sancho de Teor wrote a description of the coast of Sofala. C.'s voyages are described in Ramusio's *Navigazione e Viaggi*, 3 vols. (Venice, 1563; new ed., Venice, 1835).

CABRE'RA, a small island in the Mediterranean, lying off the southern point of Majorca. It is about three miles in length and breadth, with an irregular coast, and is little else than a barren calcareous rock. The only interest attached to C. is, that during the war in the Peninsula it formed a Spanish dépôt for French prisoners, who were crowded in thousands into the desolate spot, and treated with great barbarity; of which an account is given in a popular work, entitled the *Adventures of a French Sergeant*.

CABRE'RA, DON RAMON, the boldest leader of

the Carlist party in Spain, was born at Tortosa, in Catalonia, 31st August 1810. The death of Ferdinand, in 1833, gave the signal for a civil war, and first brought C. into notice. Placing himself at the head of some guerilla troops, he joined the Absolutists, or partisans of Don Carlos, and by his vigilance, energy, and daring soon rose to be second in command in the Maestrazgo district. Throughout Aragon and Valencia his name became a by-word for cruelty. After penetrating as far south as Andalusia, his forces were completely routed by the royal troops, on the borders of Aragon, and he himself, severely wounded, escaped with difficulty into the woods. It was now rumoured that C. was dead, when all at once he reappeared at the head of 10,000 foot and 1600 horse. Invading the province of Valencia, he overthrew the royal army at Buñol, 18th February 1837, and again on the 19th March at Burjasot; but was in his turn vanquished at Torre-Blanca, and once more compelled to seek a hiding-place. Shortly after, he re-opened the war with fiery energy. Madrid itself was threatened by C., who, about this time, received the title of Count of Morella for his vigorous defence of the fortress of that name, and was also appointed governor-general of Aragon, Valencia, and Murcia. The Carlists now believed that the triumph of absolutism was approaching, when the treachery of the Carlist general, Marotto, changed the whole aspect of affairs, and Don Carlos fled from Spain. C. held out until Espartero forced him to quit the country in the summer of 1840. He then entered France, where he was taken prisoner, and confined for a short time in the fortress of Ham. In 1845, he strongly opposed Don Carlos's abdication of his rights. On the outbreak of the French revolution in 1848, he renewed the struggle on behalf of absolutism in Spain; but the adventure proved a miserable failure, and on the 17th January 1849, he recrossed the Pyrenees, and has since lived in exile. He took no active part in the recent attempt of General Ortega (April 1860) to disturb the peace of Spain.

CABU'L, a river in Afghanistan, rises in lat. 34° 21' N., and long. 68° 20' E., on the southern declivities of the Hindu Kush or Indian Caucasus. Its source is 8400 feet above the level of the sea; and an eastward run of 320 miles, with a fall of about 7500 feet, along North Afghanistan, through the Khyber Mountains, and across Peshawur, carries it into the Indus, opposite to Attock, in the Punjab. The point of confluence marks the head of navigation on the main stream, while the tributary itself is practicable about 50 miles upwards for craft of 40 or 50 tons. By means, therefore, of the two taken as one line, there exists an available communication of about 1000 miles between the Khyber Mountains and the Indian Ocean. The C. washes the cities of Cabul, Jelalabad, and Dohundee.

CABU'L (city) stands in lat. 34° 30' N., and long. 69° 6' E., near the point where the river, here crossed by three bridges, ceases to be fordable. Elevated about 6400 feet, and overtopped, within a short distance to the north, by pinnacles of the Indian Caucasus, about 14,000 feet higher than itself, C. differs widely in climate from most places on the same parallel. The winter is severe, and the summer is temperate, ranging from 75° to 85° F., though sudden vicissitudes of temperature are common at every season, and more particularly in the warmer months. C. is celebrated all over the East for the variety and excellence of its fruits. Within a circuit of three miles, it has a population

of about 60,000, which, besides the various tribes of Afghans, comprises representatives of nearly every part of Central and Southern Asia. As the different races live, as much as possible, apart from each other, the city, in addition to its being fortified as a whole, is separated into different quarters, for the purposes of defence, by stone-walls—the Bala Hissar, or citadel proper, being on the east, and the Kuzzilbash or Persians having a strongly fortified quarter on the south-west. The thoroughfares are often too narrow for one horseman to pass another. The residences of the wealthy display extensive courts and gardens. The trade of the city is considerable. Independently of its markets for native productions, it forms an *entrepôt* between India on the one hand, and Turkestan and Tatory on the other. In the days of Sultan Baber, whose tomb is in the immediate neighbourhood, C. was the capital of the Mogul Empire. In more recent times, it has witnessed some of the most momentous events in Anglo-Indian history. In 1839, it was taken by the British; in 1841, it was lost through a treacherous outbreak, which led (6th January 1842) to the massacre of about 4000 soldiers and 12,000 followers; and, finally, after being recovered by General Pollock in the same year, it was abandoned, its bazaars and public buildings having previously been hurned to the ground.

C. is also the name given to the territory of which the above city is the capital. It nearly coincides with North Afghanistan, extending from the south of Ghiznee to the Hindu Kush, and from Bamian (q. v.) to the Khyber Pass. This region has long occupied a prominent position in the world. Through it, as the passage from Persia to India, Alexander the Great marched in order to complete his eastern conquests; from it issued Mahmoud of Ghiznee, the first Mohammedan invader of Hindustan; and, as above stated, it has been twice overrun by England, with the view of counteracting the ambition and influence of Russia. See AFGHANISTAN.

CACA'O. See COCOA.

CACCA'MO, a town in the province of Palermo, Sicily, about 6 miles south-west of Termini, with a population of 6394.

CA'CERES, a town of Spain, capital of the new province of Caceres, is situated on a river of the same name, about 25 miles west of Truxillo, in a rich agricultural district. It is famous for its bacon; has manufactures of linen, woollens, leather, hats, soap, &c.; dye-works and flour-mills, and a large trade in the produce of the district. It is the *Castra Cacsilia* of the Romans, and many relics of its antiquity are still found. It is rich in architecture of the feudal period, and has one of the largest and finest bull-rings in Spain. Pop. 12,051.

CA'CERES, NUG'VA, a town of the Philippines, in the province of South Camarines, on the island of Luzon. It is situated on the river Naga, or Santa Cruz, between the Bay of San Miguel and the Gulf of Ragay, about 175 miles south-east of Manilla. Pop. 12,000.

CACHA'O, capital of the province of Tonquin, and the largest city of the kingdom of Anam (q. v.), having an estimated population of 100,000. It stands about 100 miles from the sea, on the Tonquin River, which is thus far navigable for small-craft. It has a considerable trade, sufficient to have at one time attracted English and Dutch factories. The exports are bullion, silks, and lackered ware; and the imports are pepper, arms, long cloths, chintzes, and manufactured goods generally.

CACHA'R, or HAI'RUMBO, a British district

of Farther India, lying to the south of Assam, between 24°–26' N. lat., and 92°–93° 30' E. long. With an area of 4000 square miles, it is said to contain only 60,000 inhabitants, being mostly mountainous, and chiefly uncultivated. Its principal river is the Barak, which, after a singularly tortuous course of 350 miles, enters the Brahmaputra about 40 miles above Dacca. The territory produces rice, cotton, sugar, timber, bamboo, iron-ore, wax, and ivory, and imports salt, cloths, tobacco, and ghee or half-liquid butter.

CACHE (Fr. a lurking-hole), the name given by parties of travellers in the great western prairies of the United States to places for concealing provisions and other articles. Designing to return on their tracks after crossing the Rocky Mountains, they disburden themselves of what articles can be spared, and to conceal them from the Indians, construct places of deposit in the wilderness. The making of a C. is a matter of much labour and ingenuity. A hole is dug to a depth of perhaps six or eight feet and several feet broad, and then the articles being interred, the surface is replaced with the utmost possible care. The excavated earth is also carefully removed, so as to leave no trace whatever of the excavation. The situation of the C., however, is known to the party by some landmark, and returning months afterwards, they probably find its contents undisturbed.

CACHET, LETTRES DE. See LETTRES DE CACHET.

CACHE'XIA, a name applied by physicians sometimes to a group of diseases, and sometimes to the constitutional state accompanying a particular disease—e.g., Cancerous C., Gouty C., Mercurial Cachexia. The word is derived from the Greek *kakos*, bad, and *hexis*, a habit, and signifies simply *a bad habit of body*, without reference to the cause of illness. From Cullen's having in modern times given extensive circulation to the word, as indicating a large group of chronic diseases, in most of which there are complicated changes in the blood and in the solid textures, C. has come to be chiefly employed with reference to diseases in which the general nutrition of the body is at fault, and in which the local disorders are supposed to be the result of a constitutional cause. Thus, Cancerous C. indicates the peculiar impoverished state of the blood and general debility which are associated with the deposits of cancer in various parts of the body; Gouty C., the state of the general system in gout, as opposed to the mere local attack of gout in the foot, &c. The cachexiæ differ from the fevers in being much slower in development, and, for the most part, in having no natural termination at a fixed period. See CRISIS.

CA'CHOLONG, a beautiful mineral, regarded as a variety of Opal (q. v.). It is sometimes called Pearl Opal, or Mother-of-pearl Opal. It is generally of a milk-white colour, rarely with a yellowish or reddish tinge, opaque and dull or pearly and shining, and has a flat conchoidal fracture. Among the localities in which C. is found are the Giants' Causeway and the Farøe Islands.

CA'CHOLOT, SPERMACE'TI WHALE, or, by contraction, SPERM WHALE (*Physeter macrocephalus* or *Catodon macrocephalus*), one of the largest of the *Cetacea* (q. v.), very peculiar in form and appearance, much sought after not only on account of the oil, but still more on account of the Spermaceti (q. v.) which it yields. Ambergris (q. v.) is also obtained from it. The C. belongs to the family of *Cetacea* called *Physeteridae*, or *Catodontidae*, of which some naturalists still think that there is only one well-ascertained species. There appears, however, to be pretty good reason for thinking

CACHOLOT.

that at least two species exist, both of which are occasional visitants of the British shores—the Common C., having no dorsal fin, and the High-finned C. (*Physeter Tursio*), having a very high dorsal fin. The Common C. has a very wide geographical range. It may almost be said to inhabit all seas, although it is most abundant in those of the southern hemisphere. It is not of frequent occurrence on the European shores, although it sometimes enters the Mediterranean, and is occasionally stranded on the coasts of Britain. An individual, fifty-four feet long and thirty in circumference, ran ashore on Cramond Island in the Firth of Forth in 1769, and was very particularly described in the Philosophical Transactions by Mr Robertson of Edinburgh. Twelve were caught at Walderwich, on the Suffolk coast, in 1788. The C. sometimes reaches the length of seventy or eighty feet. The head is enormously large, forming about one-half of the entire bulk of the animal, and occupying more than one-third of the entire length. From the head, the body tapers to the tail, and at last rather rapidly. The general colour is very dark gray, nearly black on the upper parts, lighter beneath. Old males, or, in the language of the South Sea whalers, old bull-whales, usually have a large gray spot on the front of the head. The muzzle is very obtuse, almost as if suddenly cut off in front, the breadth of it almost equalling the thickness of the body. In a protuberance on the upper part of it, is the blow-hole, which is

The pectoral fins are small, and seem scarcely if at all to aid in progression, which is accomplished by the large and powerful tail-fin. The tail-fin is very broad, and is divided into two lobes, called by South Sea whalers *the flukes*.

The enormous head of the C. is in great part occupied by a cavity in front of and above the skull, called by whalers *the case*, which is a receptacle for spermaceti (q. v.). This substance being light, it is

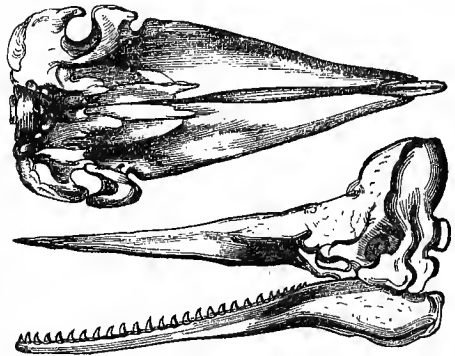

Skull and lower jaw of Cacholot.

not wonderful that the animal in swimming raises its head above the surface of the water, which it also often does even when at rest, 'like a black rock in the ocean.' The *case* frequently holds as much as ten large barrels of spermaceti. It is not formed of bone, but of a strong tendinous integument, and is divided into compartments communicating with each other. The substance which it contains is in a semi-fluid state, but hardens on cooling: it consists of spermaceti and oil; the oil is separated by draining and squeezing, and the spermaceti further purified, till, instead of being a yellow unctuous mass, in which state it is brought home by the whalers, it assumes a beautiful pearly white, flaky, almost crystalline appearance. When the spermaceti whale is killed, and towed alongside the whaling-ship, the *case* is emptied of its valuable contents through a hole made in front of the muzzle, and by means of a bucket attached to a pole. The spermaceti was at one time imagined to be the brain of the whale; what purpose it serves in the animal economy, is not well known, except that already alluded to of giving buoyancy to the forepart of the huge body; and perhaps this is its chief use, respiration even more than progression depending on it; but it is distinct enough from the brain, which is comparatively very small, and is indeed, as well as the skull which contains it, small in proportion to the whole bulk of the creature. Cavities filled with spermaceti are distributed over the body, and even ramify through the external fat or blubber, although the principal mass is in the head. The blubber of the C. is not nearly equal in thickness to that of the Greenland whale, being only about fourteen inches thick on the breast of a large whale, and from eight to eleven inches on other parts of the body. It is called by whalers the *blanket*, is removed from the body of the captured whale in great stripes, and is heated in large pots, the skin of the whale serving for fuel, when the oil known as SPERM OIL (q. v.) flows from it. The *junk*, a thick elastic mass, which occupies the forepart of the head, immediately under the *case*, yields also a considerable quantity of sperm oil.

The C. feeds upon fishes and cephalopodous mollusks. Squids and cuttle-fishes appear to be its

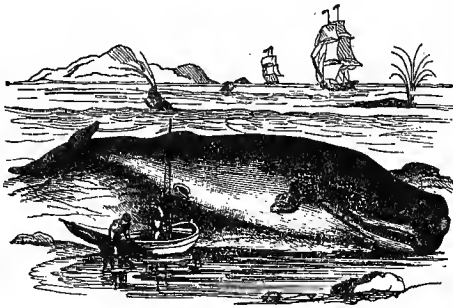

Cacholot, or Sperm Whale.

single, situated a little on the left side, and in form not unlike the letter S elongated. The mouth is very large and wide; and the throat, unlike that of the Greenland whale, is very wide, sufficiently so to admit the body of a man. The upper jaw projects some feet beyond the lower, and is destitute both of teeth and whalebone; the lower jaw has from 20 to 25 teeth on each side, according to the age of the animal. The teeth are conical and slightly recurved, projecting about two inches from the gum. The lower jaw is extremely narrow, the two branches being in contact throughout the greater part of its length: it fits into a groove in the upper, in which are cavities for the teeth. The eyes are small, and placed far back in the head, above the angles of the mouth; the left eye is said to be smaller than the right. Just above the eyes, the dorsal line rises considerably; the dorsal fin is also represented by a protuberance about half-way between the neck and the tail; and these parts are seen above water in the ordinary swimming of the animal, which is at the rate of from 3 to 7 miles an hour, and just under the surface of the water, although when alarmed it swims with greater velocity, striking the water upward and downward with its tail with great force.

chief food. It is gregarious in its habits, and the herds are called *schools* by whalers. Five hundred or more have been seen in a single herd. Large herds generally consist of females, with only a few males; herds of young males also occur; when solitary individuals are met with, they are almost always old males. Terrible conflicts often take place among the males, and it is not unusual to find the lower jaw deformed in consequence of having been dislocated or broken in them. See WHALE-FISHERY.

CACIQUE, or CAZIQUE, the designation given to the chiefs of Indian tribes in works relating to the central and southern parts of America. The word was derived by the Spaniards from the language of the former inhabitants of St Domingo.

CACODÆMON. See DEMON.

CA'CODYLE, or KA'KODYLE, is an organic substance containing carbon, hydrogen, and arsenic (C_2H_2As). It has recently been proposed to employ the oxide of C. (C_2H_2AsO) as a deadly agent in war. This compound, otherwise known as *Cadet's fuming liquor* or *alkarsine*, has the remarkable property of taking fire spontaneously when exposed to the air, and evolving abundant fumes of arsenic. Thus, a shell filled with it would, on bursting, saturate a space of ground, or the rigging or deck of a man-of-war, with a liquid which would quickly take fire of its own accord, and besides causing destruction by burning, would likewise spread death by its fumes.

CACO'NGO, or MALLE'MBA, an independent state of South Guinea, Africa, extending along the South Atlantic Ocean, in lat. 5° S., and stretching south-east as far as the river Bell. Its limits interiorly are not well defined. The country is generally flat, and the soil fertile. The principal towns are Kinguele, and Cacong and Mallemba on the coast, the last once a great mart for slaves.

CA'CTEÆ, or CACTA'CEÆ, a natural order of exogenous plants, consisting of succulent shrubs of very singular appearance. Linnaeus included all the C. in the single genus *Cactus*, which is now divided into a number of genera; the name *Cactus*, however, still continuing in popular use, common to the whole order. Nearly 500 species are known, but the real number is probably much greater. The C. are, without exception, natives of America, and their extraordinary forms constitute a remarkable feature in the vegetation of its warmer regions. All of them have fleshy stems, either simple or branched, often very soft and juicy; but in many, at least when old, having an easily distinguished woody axis, composed of annual rings, and covered with a layer of inner bark, so that the thick fleshy part may be regarded only as a layer of bark. Most of them are leafless; the *Pereskia* alone have true leaves, which are fleshy; and the *Opuntia* have rudimentary leaves, which soon fall off; but, instead of leaves, most of the order have clusters of hairs or prickles, where buds are formed in their stems, and these are very numerous, even in the species which in ordinary circumstances most rarely develop branches. The multiplicity of curious forms exceeds imagination; in many species (*Melocactida*, or Melon Thistles), the stem swells out into a globe; in others (*Torch Thistles*), it rises up as a column with many angles; in others (*Opuntia*, Indian Figs, or Prickly Pears), it divides in leaf-like articulations; in some (*Pereskia*) it assumes a tree-like form, in which the thick stem bears a head of branches, and reaches a considerable height, sometimes even 30 or 40 feet. Those which have angular, ribbed, and channelled, or flat and two-edged stems, shew a tendency to the cylindrical

form as the stem advances in age. Some species have long creeping or trailing stems. The whole organisation of the C. adapts them for the endurance of long droughts; they vegetate vigorously during a



Melon Cactus or Thistle (*Melocactus*).

part of the year, and then rest; the very absence of leaves concurring with the absence of pores or *stomata* in their tough skin to enable them to resist the action of a dry atmosphere and powerful sunshine, and to occupy arid soils and bare rocks, on which they are very generally found, often covering large tracts. Some of them grow rapidly on old lavas, and disintegrate them by their penetrating roots, thus preparing a soil for other plants; and the Prickly Pear is often planted in Sicily by the mere insertion of a branch or joint of it in a fissure of lava. Many species occur as *epiphytes* (q. v.) on the trees of American forests. Some also grow on high mountains, a few even reaching almost to

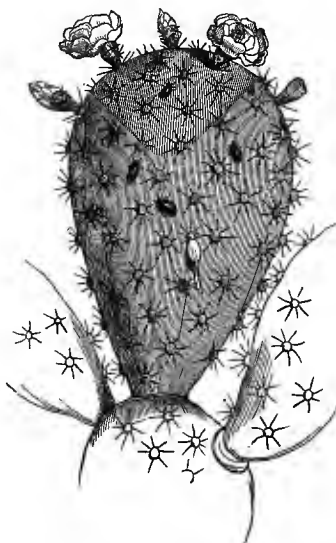

Cochineal or Nopal Cactus (*Opuntia Cochinellifera*), with Cochineal Insects.

the border of the snow. The plants of this order are a great boon to the regions in which they chiefly abound, which are, at least during great part of the year, very destitute of water; their stems containing a store of insipid and wholesome juice, of which both men and cattle avail themselves.—Some species, as the Prickly Pear (q. v.),

CADDICE—CADE.

produce a pleasant fruit.—The fruit of *Opuntia Tuna* affords a valuable pigment of the richest carmine colour.

The flowers of the C. are in general very short-lived; those of some night-flowering species, as of *Cereus grandiflorus*, well known in our hothouses, endure only for part of a single night. In the greater number, they are large and splendidly coloured, in some they are very fragrant. The order is regarded as botanically allied to *Mesembryaceæ* (q. v.) and to *Grossulariaceæ* (q. v., Gooseberry, Currant, &c.).

The cultivation of the C. in green-houses and hothouses has been much in fashion for more than 20 years. The gardener must imitate the natural conditions of their growth, by giving water freely during a few months, and withholding it almost entirely during the rest of the year. Most of them are easily propagated by branches, taken off, and allowed to dry a little before being planted. The *Melocactideæ*, which do not readily produce branches, are made to do so by cutting off or burning out the central bud, that the means of propagating them may be obtained.

CA'DDICE, or CA'DDICE-FLY (*Phryganea*), a Linnaean genus of insects of the order *Neuroptera*, a family in subsequent entomological systems, and constituted by Mr Kirby into a distinct order, *Trichoptera* (Gr. hairy-winged). The caddice-flies certainly differ in important particulars from the other neuropterous insects, and exhibit points of resemblance to the *Lepidoptera*. They have no mandibles, and the maxillæ and lower lip are membranous and united; the head is small, with prominent eyes, and two additional small simple eyes situated on the forehead; the antennæ are long and bristle-like, composed of very numerous indistinct joints. Both wings and body are generally very hairy, and the wings, when at rest, are raised, and meet above the back like those of butterflies, from which, however, they differ very much in form, being much more elongate: the legs are long. Caddice-flies are extremely active, particularly in the evening and at night, when the

cylindrical form, the head and first three segments hard, the remainder—the abdominal segments—soft. To the thoracic segments are attached the feet, six in number, as in the perfect insect. The larva lives always in water, feeding on aquatic vegetables. It spins by its mouth silken threads, by means of which, together with a viscid substance, it attaches together—and often in a very symmetrical manner, and with interesting peculiarities which differ in the different species—small hard substances, such as small stones, bits of stick, or small shells, even although they happen to contain living inmates, and thus constructs a case for itself, in which its soft body is protected, and from which only the head and hard thoracic segments are voluntarily protruded. When it changes into the pupa state, in which it differs little from the perfect insect, except in the imperfectly developed wings, it fixes its case to some solid substance beneath the water, and closes the two extremities with a kind of grating, which admits the free passage of water, necessary for respiration. Before assuming the perfect form, the pupa of the larger species breaks out of its case by means of a pair of hooks on the forepart of the head, and swims actively by means of the hind legs, or crawls by the other two pair. Many of the smaller species bring their pupa case to the surface of the water, and there take wing from it as from a boat. The species of caddice-fly are very numerous, and they are said to be more so in the north than in the south of Europe. About 200 British species have been described.—The angler looks for cad-bait about the edges of streams and under stones, or on the stalks of water-cresses, and other aquatic plants. As a bait for angling, the caddice is almost as deadly as the May-fly, and more so, in clear running streams, than the ordinary worm; the usual-sized bait-hook is used, upon which two of the baits are fixed, the angler proceeding exactly as in ordinary worm-fishing.

CADE, JACK, a historical character, leader of an insurrection which broke out in Kent, June 1450. Little is known of his personal history, further, than that he was an Irishman, and an illegitimate relation of the Duke of York, and hence called himself Mortimer. With 15,000 or 20,000 armed men of Kent, C. marched on London, and encamped at Blackheath, whence he kept up a correspondence with the citizens, many of whom were favourable to his enterprise. The court sent to inquire why the good men of Kent had left their homes; C., in a paper entitled 'The Complaint of the Commons of Kent,' replied, 'that the people were robbed of their goods for the king's use; that mean and corrupt persons, who plundered and oppressed the commons, filled the high offices at court; that it was 'noised that the king's lands in France had been aliened;' that misgovernment had banished justice and prosperity from the land; and that the men of Kent were especially ill-treated and overtaxed, and that the free election of knights of their shire had been hindered. In another paper, called 'The Requests by the Captain of the Great Assembly in Kent,' C. demanded that the king should resume the grants of the crown, which he complained the creatures about the royal person fattened on, the king thus being compelled to live on taxation; that the false progeny of the Duke of Suffolk should be dismissed; and that the Duke of York and others should be restored to favour, and a number of persons punished. The court sent its answer in the form of an army, before which C. retreated to Sevenoaks, where he awaited the attack of a detachment, which he defeated. The royal army now objected to fight against their countrymen; the court made some concessions, and C. entered London on the 3d July.

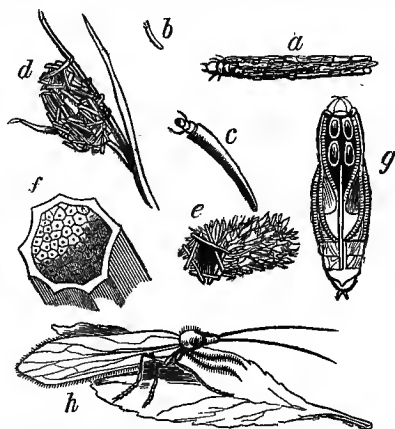

Various shapes of Caddice Cases, and perfect Insect: a, case of bark; b, case of sand; c, case of sand, magnified; d, case of grass stems; e, case of grass; f, orifice of case, shewing the silk grating, magnified; g, pupa; h, stone, or caddice-fly.

smaller species often fly in great numbers above streams and ponds. These insects are most interesting, however, on account of their larvæ, of which the larger kinds are the well-known *Caddice-worms*, or *Cad-bait* of anglers. They are of a long, almost

For two days, he maintained the strictest order; but he forced the mayor and judges to pass judgment upon Lord Say, one of the king's hated favourites, whose head C.'s men immediately cut off in Cheap-side. On the third day, some houses were plundered, the leader himself, it is said, setting the example. C., who at night lodged his army in the Borough, got news that the citizens intended to prevent his entrance into the city on the morrow, and in the night he made an attack on the bridge, but was defeated. A promise of pardon now sowed dissension among his followers, who dispersed, and a price was set upon C.'s head. He attempted to reach the Sussex coast, but was followed by an esquire, named Alexander Iden, who fought and killed him, July 11. His head was stuck upon London Bridge, as a terror to traitors.

CADELLE (*Trogosita Mauritanica* or *caraboides*), an insect sometimes found in granaries in Britain, but seemingly imported from more southerly countries, where, as in France, its larvæ often commit great ravages among stored corn. They also live on bread, almonds, and even rotten wood. When full grown, they are about three-quarters of an inch long, flattened, fleshy, rough with scattered hairs, whitish, tapering towards the head; which is black, horny, and furnished with two curved jaws. The perfect insect is a glossy beetle of a deep chestnut colour, marked with dotted lines. It belongs to the family of *Xylophagi*, of the order *Coleoptera* (q. v.), section *Tetramera*. The name C. is French.

CADENCE, in Music, is the finish of a phrase (in German, *Schlussfall*), of which there are three principal species—viz., the whole, the half, and the interrupted cadence. The whole C., which finishes on the harmony of the tonic, is also called the perfect C., and is always used at the end of a composition, and frequently called the final cadence. In its most perfect use, it consists of three chords—the one before the final being always the dominant, as for example:



The half C., also called the imperfect C., is used to mark the termination of an idea or phrase, like the colon and semicolon; shewing a considerable division, but at the same time that a continuation is necessary. The harmony of the half C. is the reverse of the whole C., as it falls from the tonic to the dominant, and sometimes to the subdominant, as follows:



In the interrupted C. (Ger. *Trugschluss*; Ital. *Cadenza d'inganno*), the preparation for the ordinary perfect C. is made; but instead of the harmony of the tonic following the dominant, another harmony quite strange is introduced, so that the ear is deceived. The more particular the preparation for the usual C. is made, the more strange and unexpected is the interruption, which can be made in so many ways that Reicha, in his *Traité de*

Haute Composition Musicale, gives 129 interrupted cadences. The following are those generally in use:



CADENCY (from Lat. *cado*, to fall or decline). The marks by which the shields of the younger members of families are distinguished from those of the elder, and from each other, is an extensive, and, in so far as that term can be applied to heraldry at all, an important branch of the science. No distinction is usually made by writers on heraldry, and probably the practice of heralds in general scarcely admits of any being made, between marks of C., differences, distinctions, or even *brisures*, though the last term is pretty constantly, and quite appropriately used to include not only differences in general, but also abatements (q. v.) or bearings by which the arms of the family are broken or diminished. See BASTARD BAR. But there is a manifest convenience in the practice which is usually followed in Scotland, of appropriating the label, the crescent, the mullet, and the rest of the series of marks, commonly known as marks of C., to the purpose of distinguishing the sons from the father, and from each other, during the father's lifetime; and of adopting other distinctions—such as the border of various kinds, the chief engrailed, embattled, and the like, as differences between the coats of brothers, after the death of their father, and of the houses descended from them. Another very common mode of differencing the shields of brothers in early times, was by changing the tinctures; but this is now regarded as too extensive a change for such a purpose. The method of differencing by means of the ordinary marks of C. will

First House.



Second House.



Distinction of Houses:

In the First House, the first, second, &c., sons are denoted by 1, the label; 2, the crescent; 3, the mullet; 4, the martlet; 5, the annulet; 6, the fleur-de-lis; 7, the rose (not figured in the cut); 8, the cross moline; 9, the double quarterfoil. In the Second House, or family of the second son, the first son is denoted by (1) the crescent, with the label upon it; the second, by (2) the crescent, with the crescent upon it; and so on. In the Third House, or family of the third son, the first son is denoted by the mullet, with the label upon it; the second, by the mullet, with the crescent upon it; and so on.

be understood from the accompanying illustration. Fanciful reasons have been imagined by heralds for assigning these different marks to the different sons.

The differences at present used by the royal family will be found in most of the peerages. The rule with regard to them seems to be that, unlike subjects, they all bear the label of three points argent; but the label of the Prince of Wales is plain, whilst those of the other princes and princesses are charged with crosses, fleurs-de-lis, hearts, or other figures, for the sake of distinction. One of the most

frequent reasons for matriculating the arms of the younger branches of families of distinction in the Lord Lyon's Register, is that they may be properly distinguished from those borne by the head of the house.

CADENZA, in Music, an ornamental succession of notes introduced at pleasure by the performer at the finishing of a phrase.

CA'DER I'DRIS (Chair of Idris, a reputed giant), a picturesque mountain in Merionethshire, Wales, 5 miles south-south-west of Dolgelly. It consists of an immense ridge of broken precipices, 10 miles long, and 1 to 3 miles broad; the highest peak reaching an elevation of 2914 feet. It is composed of basalt, porphyry, and other trap rocks, with beds of slag and pumice. The view from the summit, which is very extensive, includes the Wrekin in Shropshire, and St George's Channel almost to the Irish coast.

CADET, MILITARY (Fr. *cadet*, younger, junior in service—allied in derivation and meaning to cadency (q. v.) in heraldry), is a term applied in a general sense to a junior member of a noble family as distinguished from the eldest; and in France, any officer junior to another is a C. in respect to him. In a strict military sense, however, a C. is a youth studying for the public service.

In England, military cadetship has presented two aspects, according as it related to the East India Company's or to the royal service. When the Company possessed political and military authority in India, there were about 5000 English officers in their pay. Those who commanded the Company's own regiments had been professionally educated by the Company. A youth, nominated by the directors, was examined as to his proficiency in an ordinary English education, and admitted between the ages of 14 and 18 to Addiscombe School or College, near Croydon. If a probation of six months resulted satisfactorily, he entered upon a two years' course of study. If he passed through this ordeal well, he became a C. in the Company's service, receiving pay or salary, and being available for service in India, as opportunity might offer. The system of Indian cadetship underwent various modifications, by the introduction of competition in the appointments, and by the transference of the Company's powers to the Crown; and the proposed (1860) amalgamation of the Indian and royal armies, will (if acted upon) nullify the distinctive characters of East India cadets.

The second aspect of military cadetship in England, adverted to above, is that of the Royal or Queen's cadets. The arrangements in operation until recently will be found noticed under SANDHURST COLLEGE; and the present arrangements under CADETS' COLLEGE and STAFF COLLEGE.

CADET, NAVAL, is the lowest grade of officer in the royal navy. The cadets enter the royal service at 12 to 14 years of age. Every captain, on being appointed to a ship in commission, is allowed to nominate one C.; every flag-officer (admiral, &c.), two, on receiving his flag; but all the rest are nominated by the First Lord of the Admiralty, subject to regulations recently made concerning competitive examinations. The candidates are examined at the Royal Naval College at Portsmouth; if they pass, they are sent for three months to a training ship at Portsmouth or Plymouth, to learn the elements of rigging and seamanship. If they do not progress sufficiently in the training ship, they are rejected; but if the report is favourable, they become cadets, and are put into sea-going ships. While on board, the C. is expected to watch and learn as much as possible of what is going on—saluting officers, tying knots,

splicing ropes, arranging rigging, learning technical terms, going aloft, keeping the log, keeping watch, &c. If the C. serves satisfactorily for 3 months in a training ship, and 15 months in a sea-going ship, he becomes eligible for the next higher rank in the navy—that of midshipman. The cadets mess with the midshipmen on shipboard. There are 375 cadets on the navy estimates for 1860—1861.

CADETS' COLLEGE was established in 1858 by a remodelling of the Junior Department of the Royal Military College at Sandhurst. Its objects are, to give a sound military education to youths intended for the army, and to facilitate the obtaining of commissions when the education is finished. The age of admission is between 16 and 19. The friends of a youth, able to pay the sums of money presently to be named, apply to the commander-in-chief for permission to place the youth on the list of candidates; this permission is usually granted on production of satisfactory certificates and references. The youth may go up for examination on any half-year. The list of subjects includes English composition, continental languages, mathematics, history, geography, natural sciences, experimental sciences, and drawing. After the examination, the candidates are reported to the commander-in-chief in their order of merit. Those who have the most marks are admitted as cadets as soon as vacancies occur in the college. When entered, they study for two years on a great variety of subjects connected with military science and practice. The friends supply clothing, books, and instruments. The annual payment for education, board, and lodging varies from £100 per annum down to £20; the highest sum being demanded for 'the sons of private gentlemen,' while the lowest is deemed sufficient for 'the sons of officers of the army or navy who have died in the service, and whose families are proved to be left in pecuniary distress.' Twenty of the youths are 'Queen's cadets,' sons of officers 'who have fallen in action, or have died from the effects of active service, and have left their families in reduced circumstances.' These 20 cadets are admitted and educated gratuitously. When the course is completed, the cadets are eligible to the reception of commissions in the cavalry and infantry, a certain number of which are placed at the disposal of the college.

At the most recent competitive examination, in June 1860, the examiners announced that 40 cadets were fitting recipients of commissions in the army. The commander-in-chief had, however, only 20 commissions for bestowal, owing to the difficulties connected with the system of army purchase.

CADETS' FUMING LIQUOR. See CACODYLE.

CA'DI, an Arabic word signifying a judge or person learned in the law, the title of an inferior judge amongst the Mohammedan nations, who, like the Mollah (q. v.), or superior judge, must be chosen from the higher ranks of the priesthood, as all law is founded upon the Koran.

CA'DIZ (ancient *Gades*), an important commercial city of Spain, capital of the modern province of the same name, which forms a part of the great division of Andalusia; is situated at the extremity of the long narrow isthmus of the Isle of Leon, in lat. 36° 32' N., and long. 6° 17' W. The Atlantic Ocean washes its western and part of its southern side, and on the north and north-east it is enclosed by the Bay of Cadiz, a deep inlet of the Atlantic, forming an outer and an inner bay. Connected by only a narrow strip of ground (in some places not above 200 yards across) with the mainland, C. is admirably situated for defence; but though it has several sea and land fortifications, these are by no means considered

impregnable. The town, which is surrounded by walls, forms nearly a square, each side being about a mile and a half in length. The houses being built of white stone, the city presents a remarkably bright and clean appearance from the sea. The streets are well paved and lighted, regular, but narrow, and there are some pleasant public walks, the most frequented of which is the Alameda. It has few public buildings of note; its two cathedrals are, on the whole, but poor specimens of ecclesiastical architecture, and its pictures, with the exception of one or two excellent pieces by Murillo, are of little value. As a commercial city, C. has greatly declined since the emancipation of the Spanish colonies in South America; but it is still, so far as the amount of tonnage of vessels entering and leaving, and the value of exports are concerned, the chief of Spanish ports, though with regard to the value of imports it stands below Barcelona and Santander. Ships with tonnage to the amount of 231,253 tons, and 151,992 tons, respectively, entered and cleared out of the port of C. in 1856; the value of imports and of exports in the same year being 138,343,590 reals (£1,383,435) and 187,001,584 reals (£1,870,015); in the latter case, little more than a third of what it was in 1849. The exports consist of wine, olive-oil, fruits, salt, and metals; and the manufactures of glass, coarse woollen cloth, soap, hats, leather, &c. Pop. (1857) 71,914.

C. is one of the most ancient towns in Europe, having been built by the Phœnicians, under the name of Gaddir, 347 years before the foundation of Rome, or about 1100 B.C. It afterwards passed into the hands of the Carthaginians, from whom it was captured by the Romans, who named it Gades, and under them it soon became a city of vast wealth and importance. Occupied afterwards by the Goths and Moors, it was taken by the Spaniards in 1262. In 1587, Drake destroyed the Spanish fleet in the bay; nine years later, it was pillaged and burned by Lord Essex; and in 1625 and 1702, it was unsuccessfully attacked by other English forces. After the revolution (1808), C. became the headquarters of the insurrectionary junta, by whose orders it was separated from the mainland. The French, in February 1810, commenced a blockade, which they vigorously persevered in, capturing several of the forts, until August 25, 1812, when the victories of the Duke of Wellington forced them to abandon it. The city was besieged and taken by the French in 1823, and held by them until 1828.

CADMIUM is the term applied to the crust formed in zinc furnaces, and which contains from 10 to 20 per cent. of cadmium.

CADMIUM is a metal which occurs in zinc ores, and, being more volatile than zinc, rises in vapour, and distils over with the first portions of the metal. See ZINC. C. is represented by the symbol Cd, has the atomic weight or equivalent 55.74, and the specific gravity 8.6. It is a white metal, somewhat resembling tin; is malleable and ductile; fuses at 442° F., and rises in vapour a little above 600°. It is rarely prepared pure, and is not employed in the arts as a metal, though one or more of its salts have been serviceable in medicine. The sulphide of C., CdS, occurs naturally as the mineral *Greenockite*, and when prepared artificially, is of a bright yellow colour. It is known as CADMIUM YELLOW, and is of great value to the artist. A great variety of tints are produced by mixing it with white-lead. Much of what is sold as Naples Yellow (q. v.) is thus prepared; but the genuine Naples Yellow has a greenish tint, which renders it easily distinguishable from the imitation. Cadmium

Yellow, however, has many valuable qualities, which are causing it rapidly to supersede Naples Yellow.

CADMIUS (according to Apollodorus and others) was the son of Agenor and Telephassa, and the brother of Europa. When the latter was carried off by Zeus, he and his brothers, as also their mother, were sent in quest of her, with injunctions from Agenor not to return without her. Their search was vain, and the oracle at Delphi told C. to relinquish it, and to follow a cow of a certain kind which he should meet, and build a city where it should lie down. He found the cow in Phocis, followed her to Bœotia, and built there the city of Thebes, about 1550 B.C. The myth of C., however, like other early Greek myths, abounds in contradictions, and it is wholly impossible to disentangle the historical facts from the meshes of fable in which they are imprisoned. To him is ascribed the introduction into Greece of an alphabet of 16 letters, derived from Egypt or Phœnicia, and the discovery of brass, or introduction of its use.

CADOUAL, GEORGE, a distinguished leader in the Chouan or Royalist war in Brittany, was born near Auray, in Lower Brittany, where his father was a miller, in 1771. He was among the first to take up arms against the Republic, and soon acquired great influence over the peasants. Captured in 1794, he was sent as a prisoner to Brest, from which he soon made his escape, imprisonment having only increased his loyal ardour. Annoyed at the dissensions between the Vendean generals and the emigrant officers, and the disasters consequent thereon, C. organised an army in which no noble was permitted to command, and which Hoche, with all his great military talents, was unable to subdue or disperse. In 1799, C. was the soul of the conspiracy to overthrow the First Consul, and place a Bourbon on the throne; but the events of the 18th Brumaire disarranged the plans of the conspirators. Bonaparte recognised C.'s energy and force of character, and offered to make him a lieutenant-general in his army, which offer C. refused, as well as another of a pension of a hundred thousand francs, if he would only consent to remain quiet. Bonaparte attempted to arrest him, but he fled to England, where, in 1802, he conspired with Pichegru for the overthrow of the First Consul. With this design he went to Paris, but was arrested, condemned, and executed June 25, 1804. C. was a man of stern honesty and indomitable resolution. 'His mind was cast in the true mould; in my hands he would have done great things,' was Napoleon's estimate of him.

CADUCEUS, the winged staff of Mercury, or Hermes, as he was called by the Greeks, which was supposed to give the god power to fly. The C. in the actual world was the staff or mace carried by heralds and ambassadors, from which circumstance, no doubt, it came to form one of the attributes of the messenger of the gods. Originally, it was simply an olive-branch, the stems of which were afterwards formed into snakes, in accordance with several poetical tales invented by the mythologists. One of these was to the effect that Mercury, having found two snakes fighting, divided them with his rod, and that thus they came to be used as an emblem of peace. Many miraculous virtues were ascribed to the caduceus. On the coinage of antiquity, the C. is often given to Mars, who holds it in the left hand, a spear being in his right, to shew how peace and war alternate. It is also seen in the hands of



Caduceus.

Hercules, Bacchus, Ceres, Venus, &c. Amongst the moderns, the C. is used as an emblem of commerce, over which Mercury was the presiding divinity.

CÆCILIA (Lat. *cæcus*, blind), a genus of reptiles, formerly placed among serpents, on account of their form, although, in their anatomical structure,

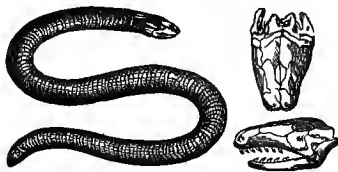

Two-handed Cæcilia.

peculiarities were observed alling them to Batrachians, with which they are now ranked, the important fact having been ascertained of their breathing by gills when young, and undergoing a metamorphosis. The body is almost cylindrical or worm-like, the head small, the eyes very small, and nearly hidden by the skin; in some species, indeed, imperfect or wanting, upon which account the name C. was given to them, and an attempt has been made to transfer to them the English name Blindworm, commonly given to the *Anguis fragilis*. The skin is smooth, viscous, and annularly wrinkled, appearing naked, although, upon dissection, minute scales are found disposed between its wrinkles, at least in some species. The vertebrae are articulated as in fishes and in some of the other lower Batrachians, not as in serpents, and the skull is united to the first vertebra by two tubercles. The ribs are imperfectly developed, and much too short to encircle the trunk.—The original genus C. has been subdivided, now forming a family, *Cæciliadae*. The species are inhabitants of warm climates, and of marshy or moist places.

CÆCUM (Lat. *cæcus*, blind), a blind sac; that is, a sac or bag having only one opening, connected with the intestine of an animal. In man, there is only one C., very small, and apparently not performing any important function, situated at the extremity of the small intestine, where it terminates in the large intestine or colon. In many of the mammalia, however, and particularly in most of those which are herbivorous, it is comparatively large, and is found to secrete an acid fluid resembling the gastric juice. It therefore appears that, where the nature of the assimilatory process is such as to require the detention of the food for a considerable time, this provision is made for it, in order that digestion may be more completely accomplished. The C. is entirely wanting in some quadrupeds, as in bats, and the bear and weasel families. Birds have two cæca, which are generally long and capacious in those that are omnivorous or granivorous, and the position of which is the only circumstance that marks the division of the intestine into two parts, the small and the large intestine, or the *ileum* and the *colon*. In reptiles, a C. is of very rare occurrence. Fishes have none in the position occupied by those of quadrupeds and birds, but many of them have cæca attached to the intestine at its uppermost part, and very generally regarded as appendages of the stomach. The number of these cæca is, however, extremely various; sometimes there are only 2, and sometimes more than 100. The number is different even in very nearly allied species of the same family; thus, there are only 6 in the smelt, but 70 in the salmon; 24 in the herring, and 80 in the shad. In some fishes, as the cod, the cæca consist of large trunks ramified

into smaller ones.—The intestinal canal of some of the *Infusoria* is furnished throughout its whole length with numerous cæca, no other organ corresponding to a stomach appearing to exist.

CÆDMON, the first Anglo-Saxon writer of note who composed in his own language, and of whom there are any remains. The date of his birth is unknown, but his death occurred about 680 A. D. He was originally a cow-herd, attached to the monastery of Whithy, and, according to Bede, 'even more ignorant than the majority of his fellows, so that in the evenings, when the domestics assembled in the hall to recreate themselves with music after the labours of the day, Cædmon was frequently obliged to retire, in order to hide his shame when the harp was moved towards him.' One night, however, as he was sleeping in the stable-loft, a stranger appeared to him, and commanded him to sing. C. declared his ignorance, but the stranger would take no refusal, and imposed on the poor cow-herd the sublime task of hymning the glories of creation. Suddenly, a poetic inspiration seized him, and he began to pour forth verses. When he awoke from his dream, the words remained fast-rooted in his memory, and were recited by him to others with new confidence. The Abbess Hilda, and the learned men who were with her in the monastery, immediately declared that he had received the gift of song from Heaven. He was now educated, became a monk, and spent the rest of his life in composing poems on the Bible histories and on miscellaneous religious subjects, many of which have been preserved, and are altogether in bulk nearly equal to the half of *Paradise Lost*, to parts of which some of them bear a striking resemblance. Satan's Speech in Hell is characterised by a simple yet solemn greatness of imagination, which may possibly have influenced at some period of his life the more magnificent genius of Milton.

CÆLATU'RA. See CHASING.

CAEN, the chief town in the department of Calvados, France—formerly the capital of Lower Normandy—is situated on the left bank of the Orne, about 9 miles from its mouth in the English Channel, and 122 miles west-north-west of Paris. C. is built in the middle of a fertile plain; its streets are wide and clean, it has several fine squares, and many noble specimens of ancient Norman architecture. Among the best examples are the churches of St Etienne, founded by William the Conqueror, and which contained his monument, erected by William Rufus, and destroyed by the Huguenots in 1562; La Trinité, called also *Abbaye aux Dames*, founded by Matilda, wife of the Conqueror; St Nicholas, now used as a shot-factory; St Pierre and St Jean. The castle, founded by the Conqueror, and finished by Henry I. of England, was partially destroyed in 1793. Little trace of the ancient defences of the town now remains. There are several beautiful promenades in the city, which has manufactures of lace, blonde, erape, cutlery, cotton-yarn, &c.; and breweries, dye-works, wax-bleaching, and ship-building yards. Its Angora gloves, made from the unwashed, undyed fur of Angora rabbits, which are reared in great numbers in the district, are celebrated. Quarries in the neighbourhood produce an excellent stone, called Caen Stone (q. v.). Trade is facilitated by a canal, which intersects the city, and by a maritime canal connecting the port with the sea, and admitting larger ships than can enter the Orne. Nothing is known of C. before the 9th century. It was a place of importance in 912, when it came into the possession of the Normans, under whom it increased rapidly. William the Conqueror and his queen made it their residence, and greatly

improved it. In 1346, it was taken and pillaged by the English, who again captured it in 1417. It was held by them until 1450, when the French compelled them to surrender. During the revolution of 1793, several of the Girondist chiefs, proscribed by the Jacobins, went to C., and organised a revolt against the Mountain, which proved unsuccessful. Pop. about 33,000.

CAEN STONE. The neighbourhood of the town of Caen, in Normandy, has been celebrated for its stone-quarries from a very early period. The excellence of the stone, and the facility of transport by sea, led to C. S. being very extensively used in England in the 15th and 16th centuries. In 1460, the Abbot of Westminster obtained a licence to import C. S. for the repairs of the monastery. Later, it became a regular article of importation; and in 1582 it is rated at the custom-house at 6s. 8d. the ton. Winchester and Canterbury cathedrals, Henry VII.'s Chapel at Westminster, and many country churches, are built of C. S., which is still frequently used in England. The stone is an oolite, resembling Stonesfield slate, but without its slaty structure. The quarries are subterraneous, and the stone is brought up through vertical shafts in blocks 8 or 9 feet long, and about 2 thick.

CAERLE'ON (Castle of the Legion), a small but ancient town in Monmouthshire, on the right bank of the Usk, 2 miles north-east of Newport. It is the *Isca Silurum* of the Romans, and is supposed to have been the capital of the Roman province *Britannia Secunda*, now Wales, and the residence of the famous King Arthur. It was the seat of an ancient archbishopric, which was removed to St Davids about 519 A.D. An abbey of Cistercian monks existed here before the Reformation. C. was an important place in the 12th c., but it was afterwards ruined by the frequent wars between the Welsh and Anglo-Saxons. Many Roman relics have been found here, as aqueducts, baths, pavements, altars, tiles, coins, inscriptions, and statues; many of the smaller antiquities are deposited in a museum in the town; besides half-melted ore and cinders, and the remains of a fortress, with walls 12 feet thick and 1800 yards long, and of an amphitheatre, called King Arthur's Round Table, 222 by 192 feet in size. Pop. 1281, the chief occupation being the manufacture of tin-plates.

CAERMARTHEN (Welsh, *Caer Fyrdwyn*, the *Maridunum* of Ptolemy), a seaport town, capital of Caermarthenshire, South Wales, on the right bank of the Towy, 9 miles from Caermarthen Bay. It lies in a picturesque situation, but the streets are irregular, steep, and often narrow. The Towy is navigable for vessels of 200 tons up to the town, and salmon and sewin are caught in the river. There are tin and iron works near the town. C. exports tin-plates, cast iron, timber, marble, bark, slates, lead ore, bricks, grain, butter, and eggs. The Welsh language is used in most of the churches. C. is a county borough, having a separate jurisdiction from the shire. It unites with Llanelly in returning one member to parliament. Pop. 10,524. There is a college for Welsh teachers. Near C. are the remains of two Roman camps. In the 5th c., Merlin, the Welsh prophet, is said to have been born here. It was long the residence of the native princes of South Wales. Caermarthen Castle often changed hands in the contests of the Welsh chiefs with each other, and in the subsequent wars of the Welsh with the Saxons and Normans.

CAERMA'RTHENSHIRE, a maritime county in South Wales, on the Bristol Channel; bounded N. by Cardigan, from which it is separated by

the Teify; E. by Brecknock; S. by Glamorgan and Caermarthen Bay; and W. by Pembroke. It is the largest of the Welsh counties; length, 53 miles; greatest breadth, 33 miles; area, 974 square miles, nearly a third of which is waste. The county is mountainous in the north and east, and is characterised by productive though narrow valleys and deep, wooded glens. Caermarthen Van or Beacon rises to the height of 2596 feet, being the greatest elevation in the county. The coast of C. is marshy, and is all situated on Caermarthen Bay, which washes also small portions of the coasts of Glamorgan and Pembroke, is 17 miles across, 10 miles deep, 35 in circuit, and receives the rivers Taff or Tave, Towy, and Lhoughor. The chief rivers of C. are the Towy, Cothy, Taff, and Teify. The Towy has a course of 60 miles, of which 50 are in Caermarthenshire. It yields plenty of salmon, sewin, trout, eels, and lamprey, and is navigable for the last 9 miles of its course. On this river is the celebrated vale of the Towy, 30 miles long, with an average breadth of 2 miles. C., north and west of the Towy, comprising three-fourths of the county, consists of lower Silurian clay-slate and grauwacke. In the south-east corner of the county is a band of carboniferous limestone and grit, to which succeeds a small part of the South Welsh coal-field of Glamorgan and Monmouth, chiefly composed of stone-coal and culm. The mineral productions of the county are iron, coal, copper, lead, slates, lime, dark-blue marble. These, with tinned iron, grain, cattle, horses, sheep, and butter, are exported. The climate of C. is mild, but moist; the soil is stiff and poor in the uplands, affording pasturage for small cattle; but the rest of the county is well wooded, and in the south part along the rivers very fertile. Oats and barley are the chief crops. The chief towns are Caermarthen (the county town), Llanelly, Llandeilo-vawr, Llandoverly, Newcastle-in-Emlyn, and Kidwelly. The chief manufactures are woollens and hides. Pop. (1851) 110,632. The county contains remains of so-called Druidical circles, cromlechs, and Roman roads, besides many baronial and ecclesiastical ruins. In this county originated the 'Rebecca' riots, which in South Wales, in 1843—1844, were directed against the number and position of the turnpike-gates.

CAERNAR'VON (*Caer-ym-ar-Fon*, Fort opposite Mon or Anglesea), a parliamentary and municipal borough and seaport in North Wales, the capital of Caernarvonshire, situated near the south end of the Menai Strait, on the right bank of the Seiont, 245 miles north-west of London. C. has a castle situated at the west end of the town, the building of which was commenced by Edward I. in 1284. It is one of the noblest ruins in the kingdom, the walls being still entire, and enclosing an oblong of three acres. The walls are 7 to 9 feet thick, and are pierced by a covered gallery, with loopholes to discharge arrows. There are thirteen embattled towers, with five, six, or eight sides, and surmounted by turrets. The gateway under the great square tower has four portullises. The town itself was once surrounded by walls and round towers. These walls, with several of the gates, still exist, but are now within the town. The streets are narrow, but regular, and at right angles to each other. In the churches and chapels, the services are in Welsh and English. C. unites with Pwllheli, Nevim, Criccieth, Conway, and Bangor in returning one member to parliament. In 1858, 1334 vessels, with a burden of 68,215 tons, entered, and 437 vessels, with a burden of 28,920 tons, cleared the port, chiefly small-craft and steamers to and from Liverpool. The harbour admits of ships of 400 tons. The chief exports are copper ore, coal, and slates. There is also a great

iron and brass foundry. C. is a bathing-place, and is much frequented by tourists, on account of its vicinity to the grandest scenery in North Wales. Many families of the upper ranks reside in and around the town. Pop. (1851) 8674. Half a mile from C. are the remains, covering seven acres, of Segontium, or *Caer Seiont*, a Roman station or city. Gold, silver, and copper coins and ornaments, and other Roman relics, have been found here. There is a Roman fort on the left bank of the *Seiont*, still almost complete, with walls 11 feet high, and 6 feet thick, and with parallel rows of holes 3 inches in diameter. C. was the seat of the native princes of North Wales down to 873. In 1284 was born here the first Anglo-Norman Prince of Wales, afterwards the unhappy Edward II. In 1294, the town and castle were burned, and the English inhabitants massacred by the Welsh under Madoc, the illegitimate son of Llewelyn, a native prince of Wales. From a rocky height near *Uxbridge Hotel*, there is a fine view of *Snowdon* and the island of *Anglesea*.

CAERNARVONSHIRE, a maritime county in North Wales, bounded N. by the Irish Sea; E. by Denbigh, with the *Conway* between; S. by *Merioneth* and *Cardigan Bay*; and W. by *Caernarvon Bay* and the *Menai Strait*, the latter separating it from *Anglesea*. It is 51 miles long; greatest breadth, 22 miles; average, 9; area, 544 square miles, of which $\frac{1}{2}$ is in pasture, and only $\frac{1}{10}$ th in tillage. The surface is mountainous, and is traversed by the grandest and highest ranges in South Britain, and it is the highest and most mountainous county in North Wales. The *Snowdonian* or chief range runs through the middle of the greatest length of the county, from south-west to north-east, and is very bold and rocky. It attains its greatest elevation in *Snowdon* (q. v.), 3571 feet, in the centre of the county, and the highest mountain in South Britain. *Caernarvon Bay* is 30 miles across, 15 long, with 2 to 30 fathoms water, and communicates with the Irish Sea through the *Menai Strait*, which is 17 miles long, and $\frac{3}{4}$ to 4 miles broad. The rivers of C. are numerous, but small, from the nearness of all parts of the county to the sea. The *Conway*, navigable for 10 miles, which runs along the east border, is the chief. Almost all the streams flow through small lakes or tarns—of which there are 50 or 60 in the county—around the central or *Snowdonian* group of mountains. There are many fine cataracts on these streams. The mineral products of C. are copper, lead, zinc, coal, roofing and writing slates, slabs, chimney-piers, honestone. The slate-quarries employ many thousands of workmen. The climate is mild in the peninsular part of C., but severe among the hills. The chief branch of rural industry in C. is the rearing of black-cattle for the dairy, and of small sheep. Wheat, oats, barley, and potatoes are raised in the valleys. Pop. (1851) 87,870. The chief towns are *Caernarvon* (the county town), *Bangor*, *Pwllheli*, *Conway*, *Nevin*, and *Criccieth*. In addition to the above boroughs, several flourishing towns have recently sprung into existence in the county—*Llandudno*, *Tremadoc*, and *Bethesda* being the principal. It returns two members to parliament—one for the county, and one for these six towns. Connected with C. is the *Chester and Holyhead Railway*, on the great route from London to Dublin, which crosses into *Anglesea* by the *Britannia Tubular Bridge* over the *Menai Strait*. C. contains the remains of British or Celtic camps and hill-forts, especially around *Snowdon*, several cromlechs and stone circles, and some ancient castles. The *Snowdonian* mountains were long the stronghold of the Welsh against the Romans, Saxons, and Normans in their efforts to subjugate

Wales, and here the Welsh, under *Llewelyn*, were at last defeated in 1283 by *Edward I.*

CÆSALPÍNIA, a genus of trees of the natural order *Leguminosæ* (q. v.), the type of the sub-order *Casalpínea*. This sub-order is characterised by irregular flowers, which are not papilionaceous (q. v.), and contains upwards of 700 known species, among which many are notable for their purgative properties, as *Senna* (q. v.); some produce eatable fruits, as the *Tamarind* (q. v.), the *Carob* (q. v.), and the *West Indian Locust Tree* (q. v.); some yield resinous and balsamic products, as *Copaiva* (q. v.), *Aloes-wood* (q. v.), &c.; some produce important dye-woods, as *Logwood* (q. v.), *Brazil Wood* (q. v.), *Camwood* (q. v.), &c.; and some are trees of great size, and very valuable for their timber, as the *Purple-heart* (q. v.) and the *Wallaha* (q. v.), trees of *Guiana*. No species of the sub-order is British, and it generally belongs to warm climates.—The genus C. contains a number of species, trees with pinnate or bipinnate leaves, natives of the warm parts of Asia and America, which yield the *Brazil Wood*, *Pernambuco Wood* (see *BRAZIL WOOD*), and *Sappan Wood* (q. v.) of commerce, also the astringent pods called *Dividivi* (q. v.), used in tanning.

CÆSAR, the name of a patrician family of the *Julia gens*, one of the oldest in the Roman state, claiming to be descended from *Iulus*, the son of *Æneas*. When or from what cause the surname of C. was first acquired, is in the highest degree uncertain. *Spartianus*, in his *Life of Ælius Verus*, mentions four different opinions respecting its origin: 1. That the word signified an elephant in the language of the Moors, and was given as a surname to one of the *Julii* because he had killed an elephant; 2. That it was given to him because he had been cut (*cæsus*) out of his mother's womb after her death; 3. Because he had been born with a great quantity of hair (*cæsaries*); or, 4. Because he had azure-coloured eyes (*cæsi*). The opinion to which we most incline is the third of these, but who was the original 'shock-head' of the gens we cannot say; the first, however, mentioned in history is *Sex. Julius Cæsar*, prætor in 208 B. C. The greatest individual of the family, and one of the greatest men the world has ever seen, was

CÆSAR, CAIUS JULIUS, son of a Roman prætor of the same name, was born 12th July, 100 B. C. Two external circumstances conspired to determine his political sympathies in favour of democracy, and against a republican oligarchy: the first was the marriage of his aunt *Julia* with *Caius Marius*; the second, the marriage of C. himself, in 83 B. C., with *Cornelia*, daughter of *L. Cinna*, one of the principal enemies of *Sulla*. The anger of the dictator at this cost C. his rank, property, and almost his life itself. Feeling that he would be safer abroad for a time, he went to Asia, 81 B. C.; but on learning the death of *Sulla* (78 B. C.), he hurried back to Rome, where he found the popular party in a state of great ferment, and anxious to regain what it had lost under the vigorous despotism of the aristocratic dictator. C., however, took no part in the attempts of *Lepidus* to overthrow the oligarchy; but he shewed his political leanings by prosecuting (77 B. C.) *Cn. Dolabella*—a great partisan of *Sulla*—for extortion in his province of *Macedonia*. To improve his eloquence, he went to *Rhodes* to study under the rhetor *Apollonius Molo*. In 74 B. C., he returned to Rome, where he had been elected pontifex, and now for the first time threw himself earnestly into public life. In the year 70 B. C., he attached himself to *Pompey*, whose political actions at this time were of a decidedly democratic character. In 68 B. C., C. obtained a questorship in Spain.

On his return to Rome (67 B. C.), he married Pompeia, a relative of Pompey, with whom he was daily becoming more intimate. In 66 B. C. he



was elected to the curule ædileship, and lavished vast sums of money on games and public buildings, by which he increased his already great popularity. For the next few years, C. is found steadily skirmishing on the popular side. In 63 B. C. he was elected pontifex maximus, and shortly after, prætor. During the same year occurred the famous debate on the Catiline conspiracy, in which the aristocratic party vainly endeavoured to persuade the consul, Cicero, to include C. in the list of conspirators. In 62 B. C., Pompey returned from the East, and disbanded his army. Next year, C. obtained the province of *Hispania Ulterior*. His career in Spain was brilliant and decisive. On his return, he was elected consul, along with M. Calpurnius Bibulus. Shortly before the passing of the agrarian law (59 B. C.), C., with rare tact and sagacity, had reconciled the two most powerful men in Rome, who were then at variance, Pompey and Crassus, and had formed an alliance with them, known in history as the *First Triumvirate*. Both of these distinguished men aided C. in carrying his agrarian law; and to strengthen still further the union which had been formed, C. gave Pompey his daughter, Julia, in marriage, though she had been promised to M. Brutus; while he himself also married Calpurnia, daughter, of L. Piso, his successor in the consulship. On the expiry of his term of office, he obtained for himself, by the popular vote, the province of *Gallia Cisalpinga* and *Illyricum* for five years, to which the senate added—to prevent the popular assembly from doing so—the province of *Gallia Transalpinga*. Nothing could have been more favourable for C.'s aims. He had now an opportunity of developing his extraordinary military genius, and of gathering round him an army of veterans, whom perpetual victory should inspire with thorough soldierly fidelity and devotion to his person. This was the very thing he wanted to give him a reputation equal to that of his coadjutors, Pompey and Crassus, whom, in genius, he far surpassed. Leaving, therefore, the political factions at Rome to exhaust themselves in petty strifes, C., in 58 B. C., after the banishment of Cicero, repaired to his provinces, and during the next nine years, conducted those splendid campaigns in Gaul, by which, had he done nothing else, he would have 'built himself an everlasting name.' C.'s first campaign was against the Helvetii, whom he totally defeated near Bibracte (Autun). Out of 368,000 only 110,000 remained. These were commanded by C. to return home, and cultivate their lands. The eyes of the Gauls were now turned upon the new conqueror. His help was solicited, among others, by Divitiacus, an Ædnan chief. This involved C. in a second war with a German prince, named Ariovistus, who was utterly overthrown; and now C., having in the course of one campaign successfully

concluded two important wars, led his troops into winter-quarters.

Next year (57 B. C.) occurred the Belgic war, in which C. successively routed the Suessiones, Bellovaci, Ambiani, and Nervii, who, alarmed at the progress of the Roman arms, had entered into an alliance with each other against the invaders. When the senate received C.'s official dispatches, it decreed a thanksgiving of 15 days—an honour never previously granted to any other general. During the winter and the spring following, C. stayed at Luca; and after spending large sums of money in hospitality, and in other less praiseworthy purposes, he departed for Gaul, where the flames of war had burst out in the north-west. The Veneti, a maritime people of Brittany, were the chief instigators of the insurrection. C.'s plans were laid with consummate skill, and were crowned with the most splendid success. The Veneti were totally defeated, and most of the other Gallic tribes were either checked or subdued. C. wintered in the country of the Auleri and Lexovii (Normandy), having, in the course of three campaigns, conquered Gaul. Next year (55 B. C.), Crassus went to Syria, and Pompey to Spain, while C.'s provincial government was prolonged for five years. He now undertook a fourth campaign against two German tribes who were about to enter Gaul. He was again successful; and pursuing the fleeing enemy across the Rhine, spent eighteen days in plundering the district inhabited by the Sigambri. He next invaded Britain, about the autumn; but after a brief stay in the island, returned to Gaul. The Roman senate, astonished at his hardihood and his successes in regions where no Roman army had ever been before, accorded him a public thanksgiving of 20 days. In 54 B. C., C. opened his fifth campaign by a second invasion of Britain. On his return to Gaul, C. was compelled—on account of the scarcity of corn, arising from drought—to winter his army in divisions. This naturally aroused the hopes of the Gauls, who thought the time had come for recovering their independence. An insurrection broke out in the north-east of Gaul, which was at first partially successful, but was ultimately crushed. C. resolved to winter at Samarobriua (Amiens), in the vicinity of the malcontents. In 53 B. C., C. commenced his sixth campaign. It was chiefly occupied in crushing a second insurrection of the Gauls. C. now returned to Northern Italy, that he might be able to communicate more easily and securely with his friends at Rome. That city was gradually becoming more anarchic, the evils of weak government more apparent; the hour for decisive action seemed to be approaching, and doubtless C.'s heart beat with expectation of the mighty future, when all at once the plot that Fate was weaving in his favour, appeared to be completely marred by a tremendous rebellion over the whole of Gaul, headed by a young warrior named Vercingetorix. It was in the dead of winter when the news came to C., who instantly saw that, at all hazards, he must preserve his fame and his army. Leaving, therefore, Pompey to succeed at Rome, he hurried to meet the insurgent hordes. His great difficulty was to collect his scattered legions. First crossing, with some Cisalpine and provincial troops, the mountains of Auvergne, though they lay six feet deep in snow, he suddenly appeared among the Arverni, who, terrified at his unexpected approach, sent for their chief, Vercingetorix, to come to their assistance. This was what C. wished. After some wonderful exhibitions of military skill, and numerous successes, Vercingetorix was shut up in Alesia (Alise in Burgundy) with all his infantry. C. besieged him, and though harassed by nearly 300,000

Gauls without, who attempted, but in vain, to break through the well-defended Roman lines, forced Vercingetorix to capitulate. Many of the tribes now hastened to submit to C., who prudently determined to winter among the vanquished. The senate, of course, voted him another public thanksgiving. Next year (51 B.C.), C. proceeded to quell the tribes who still held out. This he successfully accomplished, and having in addition reduced the whole of Aquitania, passed the winter of his eighth campaign at Nemetocenna, in Belgium, where he spent the time both in a magnanimous and politic manner. The Gallic princes were courteously and generously treated; the common people were spared the imposition of further taxes, and everything was done to render it possible for him to visit Italy with safety in the spring. This he did, and took up his residence at Ravenna, where he was informed of everything that was going on by the tribune C. Curio. There can be no doubt that at this moment he was the most popular man in the state, while his soldiery were devoted to him with a loyalty as enthusiastic as that which Bonaparte inspired when fresh from his Italian victories.

Meanwhile, Pompey, whose vanity could not endure the greatness of C., had been gradually veering round again to the aristocracy, whose dread of the new conqueror was hourly increasing. After much futile diplomatic finessing on all sides, the senate carried a motion 'that C. should disband his army by a certain day; and that if he did not do so, he should be regarded as an enemy of the state.' The tribunes, Mark Antony and Q. Cassius put their veto on this motion; but they were violently driven out of the senate-chamber, and fearing for their lives, they fled to C.'s camp. The senate, in the madness of their terror, now declared war, and intrusted the conduct of it to Pompey, whose pride in the invincibility of his military prowess hindered him from taking the necessary measures for the defence of the state. He fancied that his name would bring thousands to his standard, and he was even led to believe that C.'s troops were willing to desert their general: the result of which delusion was, that when hostilities formally commenced, he had hardly any soldiers except two legions which had recently been in the service of his rival. C., on the other hand, perceiving that the time for decisive action had at length come, harangued his victorious troops, who were willing to follow him anywhere; crossed the Rubicon (a small stream which separated his province from Italy Proper), and moved swiftly, amid the acclamations of the people, towards Rome. Pompey fled to Brundisium, pursued by C., but contrived to reach Greece in safety, 17th March, 49 B.C. The Italian cities had everywhere gladly opened their gates to the conqueror as a deliverer. In three months, C. was master of all Italy.

C. next subdued Pompey's legates in Spain, who were at the head of considerable forces. On his return, he took Massilia, where he learned that he had been appointed dictator of the republic—a function which at this time he retained only for 11 days, but these were honourably distinguished by the passing of several humane enactments. Pompey, now thoroughly alive to the magnitude of his danger, had gathered in Egypt, Greece, and the East, a powerful army, while his fleet swept the sea. C., however, crossing the Adriatic at an unexpected season, made a rush for Dyrrhachium, where Pompey's stores were; but was nevertheless outstripped by his opponent. Pompey entrenched his army on some high ground near the city, where he was besieged by C. The first encounter was favourable to Pompey, who drove back C.'s legions with much loss. The latter now

retreated to Thessaly, followed by his exulting enemies. A second battle ensued on the plains of Pharsalia, 9th August, 48 B.C. Pompey's army was utterly routed; Pompey himself fled to Egypt, where he was murdered. See POMPEY.

No sooner had the news reached Rome, than C. was again appointed dictator for a year, and consul for five years. He was invested with tribunicial power for life, and with the right of holding all the magistratical comitia except those for the election of the plebeian tribunes. He did not, however, return to Rome after the battle of Pharsalia, but went to Egypt, then in a distracted condition on account of the disputes regarding the succession. Out of love for Cleopatra (who subsequently bore him a son), he entered upon the 'Alexandrine War,' in which he was successful, and which he brought to a close in March 47 B.C. He next overthrew a son of Mithridates, near Zela, in Pontus, August 2 of the same year, and arrived in Rome in September. He was once more appointed dictator, and the property of Pompey was confiscated and sold. Before the close of the year, he had set out for Africa, where his campaign against the Pompeian generals, Scipio and Cato, was crowned with victory at the battle of Thapsus, 6th April, 46 B.C. Cato committed suicides at Utica, and with such irresistible celerity was the work of subjugation carried on, that by the end of the summer, C. was again in Rome. Now occurred that display of noble and wise generosity which proves C. to have been possessed of a great magnanimous nature. He was not a man that could stoop to the vulgar atrocities of Marius or Sulla, and so he majestically declared that henceforth he had no enemies, and that he would make no difference between Pompeians and Cæsarians. His victories in Gaul, Egypt, Pontus, and Africa, were celebrated by four great triumphs, during which the whole Roman populace was feasted and feted by the magnificent liberality of the dictator.

He now proceeded to check, by wholesome enactments, as far as in him lay, the social evils which had long flourished in the city. During the year 46 B.C., also, he conferred a benefit on Rome and on the world by the reformation of the calendar, which had been greatly abused by the pontifical college for political purposes. After quelling an insurrection which now broke out in Spain, where Pompey's sons, Cneius and Sextus, had collected an army, he received the title of 'Father of his Country,' and also of *imperator*, was made dictator and *præfectus morum* for life, consul for 10 years; his person was declared sacred, and even divine; he obtained a body-guard of knights and senators; his statue was placed in the temples; his portrait was struck on coins; the month Quintilis was called Julius in his honour; and on all public occasions he was permitted to wear the triumphal robe. He now proposed to make a digest of the whole Roman law for public use, to found libraries for the same purpose, to drain the Pontine Marshes, to enlarge the harbour of Ostia, to dig a canal through the Isthmus of Corinth, and to quell the inroads of the barbarians on the eastern frontiers; but in the midst of these vast designs he was cut off by assassination on the Ides (15th) of March, 44 B.C. The details of this crime—the greatest disaster that could have befallen the Roman world, as subsequent events shewed—are too familiar to require narration. It is sufficient to say that, of the sixty aristocrats who were in the conspiracy, many had partaken of C.'s generosity, and all of his clemency. A few, like Brutus, out of a weak and formal conscientiousness, based on theory rather than insight, were probably offended by C.'s desire

to change the form of government into a hereditary monarchy; but the most, like Cassius, were inspired by a spleenful hatred of the dictator, and the base ambition of regaining power at all hazards.

C., who was 56 years of age when he was murdered, was of a noble and kingly presence, tall of stature, and possessing a countenance, which, though pale and thin with thought, was always animated by the light of his black eyes. He was bald-headed (at least in the latter part of his life), wore no beard, and though of a rather delicate constitution naturally, he ultimately attained to the most vigorous health. His besetting sin was sensuality; but without meaning to detract from the criminality of his conduct in this respect, it may be said that it was as much the sin of the times in which he lived as his own, and that the superlative grandeur of his position gave a prominence to his licentiousness which a more humble lot would have escaped. His intellect was marvellously versatile. In everything he excelled. He was not only the first general and statesman of his age, but he was—excepting Cicero—its greatest orator. As a historian, he has never been surpassed and rarely equalled in simplicity and vigour of style, and in the truthfulness with which he narrates events of which he was an eye-witness. He was, in addition, a mathematician, philologist, jurist, and architect, and always took great pleasure in literary society. Most of his writings have been lost, though their titles are preserved; but we still possess his invaluable *Commentarii* (generally known as 'Cæsar's Commentaries on the Gallic and Civil Wars'). The *editio princeps* was printed at Rome 1449. C.'s life was formally written in ancient times by Suetonius and Plutarch, while notices of him are found in Dion Cassius, Appian, Velleius Paterculus, and Cicero.

CÆSARE'A (*Turris Stratonis*), called by the natives 'Kaisari'yeh.' This once proud and splendid seaport, perhaps one of Herod's most magnificent works—a Grecian town with its temples, amphitheatre, baths, &c., imported into Syria—was situated on the coast of Syria, 95 miles south of Beyrout, and 37 miles north of Jaffa.

In 65 A. D., Gessius Florus, the worst of all the petty tyrants that had afflicted Judæa, was appointed governor of Cæsarea. About that time, a terrible revolution, which commenced at C., broke out all over Judæa. It arose from a dispute between the Syrian and Jewish citizens of C. as to which of them the city really belonged to; and some idea may be formed of the extent of the insurrection from the fact, that above 20,000 Jews were massacred in C. in the space of one hour; 13,000 in one night at Scythopolis; 50,000 at Alexandria; 8000 at Joppa; and 10,000 at Damascus.

C. was occupied by the Crusaders; after them, it seems to have gradually decayed into nothingness. It is now (1860) a heap of half-buried ruins, with a few miserable stone-houses inhabited by fishermen.

CÆSARE'A PHILIPPI (*Panium*). This town, mentioned in Matt. xvi. 13, was situated about 20 miles north of the Sea of Galilee. It was distinguished from the Cæsarea on the coast of Syria by the appendage of 'Philippi,' given to it in honour of Philip the Tetrarch, who repaired the city. It is now a heap of ruins, overgrown with bushes and grass.

CÆSAREAN OPERATION (*cædo—cæsus*) has, from very ancient times, been the popular name for *Hysterotomy* (*hystera*, uterus; *tome*, section). Pliny distinctly alludes to it in his *Natural History* (lib. vii. cap. ix.), saying that Cæsar was so called from being taken by excision out of the womb of his mother, and that such persons were called *Cæsones*

(Cæsar a cæso matris utero dictus; quæ de causâ *Cæsones* appellati). In his case, the mother must have survived the operation, as Aurelia was alive when her son invaded Britain.

The pages of a popular work scarcely allow of the details of such a proceeding, but we may state that the first incision is made exactly in the middle line of the body, to the length of 6 or 7 inches. When the uterus is exposed, it must be carefully opened, the child lifted out, and then the after-birth. The uterus now contracts, and sinks down into the pelvis, the wound is closed, and opium is given to the patient to allay pain and nervous irritability.

In Great Britain, the C. O. has been rarely performed, most likely from the skill of the accoucheurs rendering such a proceeding unnecessary; but still several cases are on record where not only the child but the mother was saved. Some women, indeed, seem to have accepted it as their usual method of delivery, having several children, each requiring to be removed through an abdominal incision; one woman submitted to it seven times. It has also been successfully performed in most unfavourable circumstances. In the year 1500, a sow-gelder operated successfully on his own wife; an illiterate Irish midwife, Mary Donally, operated with a razor on a poor farmer's wife in January 1738, and removed a dead child; her patient completely recovered, so as to be able to walk a mile on foot on the 27th day after the operation. Nay, a negro woman in Jamaica cut herself open with a butcher's knife, removed her infant, and recovered. Practitioners are not quite decided as to the circumstances which justify the performance of this severe operation on the living female, but all agree on the propriety of at once removing by it the child of a recently dead woman. Numa Pompilius decreed that every pregnant woman who died should be opened; and the senate of Venice, in 1608, decreed that practitioners should perform, under heavy penalties, the C. O. on pregnant women supposed to be dead. In 1749, the king of Sicily decreed the punishment of death to medical men who omitted to perform it on women dying when advanced in pregnancy. Of course, to be of any use, it must be performed immediately, in the method briefly described above.

CAFFA. See KAFFA.

CAFFÈINE, or THEÏNE (C₁₀H₈O₂N₄.2HO), is the alkaloid or active principle of Coffee (q. v.) and Tea (q. v.). When isolated, it forms beautiful white crystals, with a silky lustre, which are soluble in water, alcohol, and ether. It is present in coffee to the extent of about 1 per cent., and in ordinary or Chinese tea, from 2½ to 6 per cent., and is also found in Paraguay and Guiana teas. It may be extracted from coffee or tea by making a decoction in hot water, and adding acetate of lead, which causes a precipitate of cafeeotannate of lead. When the latter is acted on by sulphuretted hydrogen, the lead is separated, and the C. left in solution. On evaporation of the liquid, and recrystallisation from alcohol, the C. separates in crystals.

CAFFER BREAD, a name given to several species of *Encephalartos*, trees of the natural order *Cycadaceæ* (q. v.), which, like many others of that order, have much starch in their stems, and afford food to the natives of South Africa. They are also called Bread-trees.

CAFFERS. See KAFFIRS.

CAFFRA'RIA. See KAFFRARIA.

CAFFRISTA'N. See KAFFIRISTAN.

CAGAYA'N SOOLOO', an island of the Asiatic Archipelago, in lat. 6° 58' N., and long. 118° 28' E. It is about 20 miles in circumference, well wooded

and elevated.—Cagayan is also the name of a province on the island of Luzon, one of the Philippines.

CAGLIARI, the capital of the island of Sardinia, situated on the side of a hill, on the north-east shore of a spacious bay, and on the south coast of the island, in lat. 39° 13' N., long. 9° 8' E. It has a spacious and safe harbour, defended by several forts, and is the emporium of all the trade of the island. The town contains many public buildings and churches, some of which are said to be very splendid; but its streets, for the most part, are very narrow, steep, and dirty. C. has a population of about 31,000. It has also a dock-yard, and a good road has lately been constructed from C. to Sassari, the second city in the island, and to some of the more considerable places. Steamers ply very frequently between C. and Genoa; and it is now united to the continent of Europe by a line of electric telegraph.

CAGLIARI, **PAOLO**, best known as *Paolo Veronese*, an Italian painter of great eminence, was born at Verona in 1532. He first studied under his uncle, Antonio Badile, a respectable artist, and afterwards settled in Venice, where he rapidly acquired both wealth and reputation. He had for contemporaries both Titian and Tintoretto, and was held in equal admiration with these famous painters. The church of San Sebastiano, in Venice, contains many of his productions, which are reckoned the most important of his earlier period—i. e., the period before he visited Rome, when he first became acquainted with the master-pieces of Raphael and Michael Angelo. The influence of the Roman school on his style was so happy, that, on his return, he received the honour of knighthood from the Doge. He died 19th April 1588. C. is remarkable for the fertility of his imagination. His design is generally noble, his composition rich, and his execution truthful. In the invention of details, especially, he is inexhaustible, and often overloads his pictures with ornament. One peculiarity of his works is the frequent introduction of splendid architectural backgrounds, which, however, were generally painted by his brother Benedetto. The most celebrated of his productions is the 'Marriage Feast at Cana of Galilee,' now in the Louvre at Paris. It is 20 feet high, and 30 in length, and contains 130 figures. Besides these may be mentioned 'The Calling of St Andrew to the Apostleship,' 'The Feast of Simon,' and the 'Presentation of the Family of Darius to Alexander.'

CAGLIOSTRO, **COUNT ALESSANDRO DI**, a notorious impostor, who, in the latter part of the 18th c., travelled through Europe, and whose adventures afford considerable insight into the social characteristics of his times. He was born at Palermo, of poor parentage, June 2, 1743, and his true name was **GIUSEPPE BALSAMO**. Carlyle's picture of him when a boy—'brass-faced, vociferous, voracious'—is probably accurate, and already prophesies the bold and boisterous quack. When 13 years old, he ran away from the seminary of St Koch, and was afterwards sent to a monastery at Cartagiore. Here he became assistant to the apothecary of the monastery, and picked up that scanty knowledge of chemistry and medicine, which was afterwards found quite sufficient to impose upon so many respectable individuals. His conduct in the monastery was in keeping with his character, but finding it too contracted a sphere for the development of his ambitious genius, he left it, or was ejected, and for a time led 'the loosest life' in Palermo. When 26 years old, he found it highly advisable to leave his native place. In company with a certain sage named Althotas, C. is vaguely represented as travelling

first in some parts of Greece, Egypt, and Asia. At Rome, 'his swart, squat figure first becomes authentically visible in the Corso and Campo Vaccino. He lodges at the sign of the Sun in the Rotunda, and sells etchings there, very hard up at this time. In Venice, 'the bull-necked forger,' contrived to marry a very pretty woman named Lorenza Feliciaua, who became a skilful accomplice in his schemes, and captivated many admirers, while C. picked their pockets. C. now made the tour of Italy with great success as a physician, philosopher, alchemist, free-mason, and necromancer! Next, he extended his victorious career through some parts of Germany, and especially carried on a lively business in his 'elixir of immortal youth,' which became very popular among the ladies. By virtue of this fine medicine, the count assured his patients that he had already attained his 150th year, while his young and charming wife often talked affectionately of her son as 'a commander in the Dutch navy.' Through Courland, the count and his accomplices advanced triumphantly to the court of St Petersburg, where he seems to have first made a failure; for the Empress Catharine, aided by her Scotch physician, Rogerson, a keen-witted native of Annandale, who sceptically examined his famous 'Spagirc food,' and pronounced it 'unfit for a dog,' penetrated his real character, and made him the subject of a comedy. C. soon found it convenient to vanish. We next find him at Warsaw, discoursing on his pet Egyptian masonry, medical philosophy, and the ignorance of doctors, but he has the misfortune to be unmasked by a certain Count M. This, however, had little effect on the stupid credulity of C.'s dupes—belonging, it must be remembered, to the upper classes, who in that age, according to Carlyle, were at once sensual, infidel, and superstitious—so that they persisted for a time in 'distending his pockets with ducats and diamonds,' which, however, his lavish dissipation soon scattered to the winds—for this prophet of a new physical and moral regeneration, and inventor of an 'invaluable pentagon for abolishing original sin,' was a desperate gambler. In 1780, he went to Strasburg; and soon afterwards we find him in Paris, still founding lodges of 'Egyptian free-masons,' holding nocturnal meetings for calling 'spirits from the vasty deep,' &c., and scandalously simulating the character and deeds of a philanthropist. From Paris he came over to England, where he was cordially received by the followers of Swedenborg. On his return to Paris (1785), he became distinguished at court, was intimate with the weak and credulous Cardinal Rohan, and played a prominent part in the affair of the Diamond Necklace (q. v.). This lodged him in the Bastille; but he cleared himself by a statement which gained credit, and, after being liberated, carried on his adventures once more in England, but feebly, the sunshine of success now obviously growing dim: in short, the count, in gloom and foreboding, disappeared from the island. But the market in Germany, too, was closed, a general distrust having been excited by the revelations of one of the count's dupes. Elsewhere, also, these began to fail him. 'At Aix, in Savoy, there are baths, but no gudgeons in them;' at Turin, he is ordered off by the king; a similar fate befalls him at Roveredo; at Trent, we catch a glimpse of him, 'painting a new hieroglyphic screen,' which, however, attracts no more the gaping crowd; lower still, 'he pawns diamond buckles;' finally, his wayworn wife—in whom, perhaps, because of her womanhood, the enormous lie and quackery first breaks up—'longs to be in Rome by her mother's hearth, by her mother's grave, where so much as the shadow of refuge awaits her.' In

May 1789, he entered the city; on the 29th December, the Holy Inquisition detected him founding 'some feeble ghost of an Egyptian lodge.' He was imprisoned, and condemned to death for freemasonry. His sentence was commuted to imprisonment for life in the fortress San Leon, where, in spite of his 'elixir of immortal youth,' he died, 1795, aged 52 years. His wife ended her days in a convent. His *Mémoires Authentiques*, posthumously circulated in Paris, were not authentic.—See Carlyle's *Miscellaneous Essays*, art. Count Cagliostro.

CAGNOLA, LUIGI MARCHESE, a distinguished Italian architect, was born at Milan in 1759—died 1833. Belonging to an ancient and wealthy family, he could afford to follow the bent of his own inclination, and devoted himself earnestly to the study of architecture. His master-works are two triumphal arches. The first is the famous *Arco della Pace*, in Milan, commenced in 1807, but not finished until 1838. It is constructed of white marble, and, with the exception of the *Arc de l'Étoile*, in Paris, is both the largest and noblest structure of the kind in Europe, reaching a height of 78 feet. On the top of the arch is a bronze figure of Peace, in a car drawn by six horses, while the sides are richly adorned with innumerable bas-reliefs. The second forming the *Porta di Marengo*, or *Porta Ticinense*, is also a work of great beauty, and is much admired. Besides these may be mentioned the *Campanile* (Bell-tower) at Ugnano, in the Bergamese.

CAGOTS is the name given to a tribe of men, of manners and customs akin to those of the gipsies, who are found scattered through various parts of Bearn and Gascony, in France. They are usually thought to be the descendants of the Visigoths, who remained in France after their defeat by Clovis, in the 5th century. Until the French Revolution of 1790, they received even worse treatment than that which generally falls to the lot of the remnants of conquered races. They were forced to wear a peculiar dress, were forbidden to practise all but the most menial trades, and were obliged to live isolated, either in separate villages or in separate quarters of the towns. So complete was their estrangement from the other inhabitants, that they were forced to enter the churches by doors specially set apart for them. Since the Revolution, they have been placed, as regards the law, on an equal footing with other citizens, but socially they are still regarded as a degraded race. Their language has been, so far back as is known, a corrupt dialect of that spoken in the surrounding country; but their blue eyes, fair hair, and fair complexion, mark them out as ethnologically distinct, and speak of a Teutonic origin. From a great liability to the diseases afflicting cretins, probably caused by their exposed manner of life and insufficient nourishment, they were at one time erroneously thought to belong to that unfortunate class. Tribes, whose history and present condition greatly resemble those of the C., are to be found in Brittany, where they receive the name of 'Caqueux;' and in Poitou, Maine, and Anjou, where they receive the name of 'Colliberts.' See Michel's *Histoire des Races Maudites de la France et de l'Espagne* (History of Outcast Races in France and Spain), Par. 1847.

CAGSANA, a town near the southern extremity of the island of Luzon, Philippines, with a population of 12,755.

CAHIR, a town in the county of Tipperary, Ireland, on the Suir, beautifully situated at the east end of a valley between the Galtees and Knockmele-down Mountains, 8 miles north-west of Clonmel. In the town is the seat of the Earl of Glengall, with a park which extends along the river for two

miles below the town. Cahir Castle, an ancient irregular Norman structure of considerable extent, is situated on a rock on the left bank of the Suir. It was taken by the Earl of Essex in 1599, and by Cromwell in 1650. It has been lately restored. C. has extensive flour-mills and a population of 3719.

CAHORS (anciently, *Divona*), a town in the department of Lot, France, is situated on a small rocky peninsula, formed by a bend of the river Lot—here crossed by three bridges—about 60 miles north of Toulouse. The streets of C. are steep and narrow, and present many specimens of antique architecture. It has a fine cathedral, and several Roman remains, including those of a magnificent aqueduct. There is an obelisk to Fénélon, who was a student at the university here. The town was taken and pillaged by Henri of Navarre in 1580. It has manufactures of cotton-yarn, woollens, leather, paper, glass, &c.; the district produces wine in considerable quantities. Population, exclusive of government officials, about 10,000.

CAICOS, or CAYOS, or KEYS, a term applied to numberless rocky islets of the West Indies, and that generally with a reference to some more considerable island in the neighbourhood. Thus, to take the Bahamas as an instance, there are the Keys of Providence, of Eleuthera, of Abaco, &c. But more specifically the name is often appropriated to the more southerly members of the group just mentioned—North, West, East, Grand, and other Keys together covering about 450 square miles, and containing about 3000 inhabitants. They lie between 21° and 22° N. lat., having been transferred, with a local president, from the government of Bahama to that of Jamaica. The revenue is about £8000. In 1852, the imports were valued at £29,867, and the exports (consisting chiefly of salt) at £24,826.

CAIFA, or HAIFA, a seaport on the coast of Syria, situated exactly opposite Acre, upon a spur of Mount Carmel, and on the south side of a wide semicircular bay, four miles across. It is the ancient Hefa, or Sycaminopolis. It covers but a small space of ground, and contains no edifice of any note except a few minarets. The houses are built of rough unhewn sandstone, plastered over with lime—the roofs flat. Pop. about 2000—Moslems, Christians, and Jews. C., having a better anchorage than Acre, is fast eclipsing that city as a port, and within the last few years almost all the trade of Acre has been transferred to it. Consular agents from England, France, &c., have lately been established at C.; and among other late improvements are a coffee-house and billiard-room, things rare in Syria. Several cargoes of barley, wheat, and sesame seed are yearly shipped at C., and exported to Great Britain and France. C. is surrounded by beautiful gardens of palm, olive, orange, citron, fig, mulberry, and pomegranate trees.

CAILLIÉ, RENÉ or AUGUSTE, a French traveller, noted for his journey to Timbuktu, was born 19th September 1799, at Mauzé, in the department of Deux-Sèvres. Having gone to Senegal, and engaged in trading with the natives, he learned, about 1826, that the Geographical Society of Paris had offered a premium of 10,000 francs to the first traveller who should reach Timbuktu. Provided with a stock of goods for barter, C. started from Sierra Leone, March 22, 1827, and after some delay caused by illness, he reached the mysterious city in April 1828, where he remained 14 days. On leaving Timbuktu, he accompanied a caravan across the Sahara Desert, reaching the coast at Tangier. After hearing and examining his statements, the Society awarded to him the offered prize, with a pension of

1000 francs, and the order of the Legion of Honour. His notes of travel, arranged by M. Jomard, were published under the title *Journal d'un Voyage à Tombouktou et à Jenné dans l'Afrique Centrale*, &c. (3 vols., Par. 1830). In England, doubts were raised as to the veracity of C., but without just grounds. C. died at his estate, in the neighbourhood of Paris, May 25, 1838.

CAIN, the first-born of Adam and Eve. His history, as recorded in the book of Genesis, is mysterious and inexplicable, and the traditions which a later superstition has gathered round it, have thrown no light whatever on its dark perplexity. As the first murderer, his memory has always been profoundly execrated by the Christian Church; yet such is the perversity of human nature, that one sect—if not more—of the pseudo-Gnostics found his actions and character so much to their liking, that they called themselves *Cainites* (130 A. D.), and invented an explanation of his alleged crime, which, like most of the Gnostic heresies in the early church, sprang out of the deep-rooted fundamental error of the 'two principles.' The Cainites believed that C. was the offspring of the intercourse of a superior Power with Eve, and Abel of an inferior Power; that their characters corresponded to their paternal parentage, and that the slaying of Abel only symbolised the victory of the superior over the inferior Power. The subsequent punishments of C. were regarded as the persecutions of Abel's father—i. e., the Jewish God. For the same reason, they highly honoured all the reprobates of the Old Testament—such as the people of Sodom, Esau, Korah, Dathan, and Abiram—whom they looked upon as the victims of the hatred of Jehovah. It is unfortunate that we possess only distorted and fragmentary accounts of this, as of all the other heretical sects. The Cainites are also said to have denied the dogma of the resurrection of the body, to have rejected the New Testament, and accepted a gospel of Judas, the betrayer, whom they also revered for the singular reason that his crime, by procuring the death of Christ, secured the salvation of men.

CAINOZOIC (Gr. 'recent life'), a geological term, synonymous with Tertiary, introduced with other words by Mr Phillips, to avoid the confusion which attended the use of the terms primary, secondary, and tertiary, owing to the various meanings attached to them by geologists.

ÇA IRA (French for 'It will go on!'), the well-known refrain of the song beginning with—

'Ah, ça ira, ça ira, ça ira!
Les aristocrates à la lanterne!'

which must always be remembered as associated with the most terrible scenes of the French Revolution. Like the *Marseillaise*, the *Carmagnole*, and the *Chant du Départ*, it became a French national song, and was styled the *Carillon National*. The melody, taken from another song, is said to have been a favourite air with the unhappy Queen Marie Antoinette.

CAIRD, REV. JOHN, a minister of the Established Church of Scotland, and one of the most eloquent living preachers in Great Britain, was born at Greenock in 1820. He studied at the University of Glasgow, and in 1845 was ordained to the pastorate of the church of Newton-upon-Ayr, whence in 1847 he was translated to Lady Yester's, Edinburgh. Here his popularity was extraordinary, but the demands made on his physical energies were so great, that he found it necessary to retire to the country, and accepted, in 1849, the country charge of Errol, in Perthshire. A sermon which he preached before the Queen in 1855, in the church of Crathie,

and which was published, by royal command, under the title of *The Religion of Common Life*, was universally admired throughout Great Britain; translated on the continent under the auspices of Chevalier Bunsen, who wrote a preface to it, and suddenly carried the fame of the author into all parts of the Protestant world. In 1857 Mr C. accepted a call to Glasgow, where he still labours. In 1858 he published a volume of sermons, marked by great chasteness and beauty of language, strength and delicacy of thought, and above all by spirituality of tone and breadth of earnest sympathy with men.

CAIRN, or CARN, a Celtic word signifying a protuberance, a heap, a pile. In that sense, it appears in the names of hills and other natural objects in Scotland, Ireland, Wales, Cornwall, and Brittany. It is also applied to artificial heaps of unhewn stones, which, among archaeologists, have come to be generally known as 'cairns.'

There are several kinds of cairns. The simplest and most common form seems to be a conical pile of stones of no great size. Next is what may be called the fenced or ringed C.—a heap of stones girdled round by large unhewn stones set upright in the ground. Some cairns have two, and a very few have three such concentric girdles; in some instances, there are concentric rows of upright stones within the cairn. Many cairns are found in the neighbourhood of the circles of unhewn stone pillars which antiquaries used to style 'Druidical.' In a few instances, cairns are found at the end of an avenue of standing stones. Some cairns are fenced round by a narrow ditch and a small earthen rampart. A very few cairns have unhewn flat stones on their tops; a still smaller number are surmounted by an unhewn stone pillar. A few are oblong in shape.

Cairns were erected, doubtless, for several purposes. It appears from record that they were often raised to distinguish the marches or boundaries of lands. One C. near Balmoral, on the Highland Dee, is said to have been erected as a mustering-place for the men of Strathdee, who took its name, *Cairn-na-cuimhne*, or 'C. of Remembrance,' for their slogan or war-cry. In later times, places where great crimes had been committed were marked by cairns; thus, 'Mushet's C.,' in the Queen's Park at Edinburgh, shews the spot where a wife was murdered by her husband, under circumstances of peculiar atrocity, in 1720. But that the great purpose of the C. was sepulchral, is shewn by the human remains found in so many of them. '*Disjectis et erutis, ossa inveniuntur, et quibusdam honor nominis adhuc manet,*' says Robert Gordon of Straloch, writing of Scotch cairns in 1654. 'For the cairns or heaps of stones in several parts of Ireland,' wrote Thady O'Roddy in 1617, 'some of them were heaped as monuments of battles, some made in memory of some eminent persons buried in such a place.' A Highland suppliant would have said to his benefactor: '*Curri mi cloch er do charne,* 'I will add a stone to your cairn.' The bones found in cairns are generally calcined or half-burned, and enclosed either in what are called *cists*—small rude coffins of unhewn stones—or in urns of earthenware, which, again, are in many cases protected by stone cists. Along with the bones are often found flint arrow-heads, flint axe-heads, stone hammers, stone rings, glass beads, implements of bone, bones of horses and oxen, spear-heads, and other weapons of bronze. In some instances, human bones are found unburned, enclosed in stone cists about three feet long, or, more rarely, of the full size of a man. In one case, as many as seventeen stone cists were found in one cairn.

CAIRNGORM STONE—CAIRO.

Many cairns are of considerable size. Each of three cairns at Memis, near Fraserburgh, in Aberdeenshire, was about 300 feet in circumference, and about 40 feet high. A C. in the parish of Minnigaff, in Galloway, was 891 feet in circumference. Several of the larger cairns are what is called 'chambered'—that is, have internal galleries or cells. Of three large ringed cairns at Clava, on the banks of the Nairn river, near the battle-field of Culloden, one was found to contain a gallery, about 2 feet wide, leading from the south side of the C. to a circular chamber in the centre, about 15 feet in diameter, built of unhewn and uncemented stones, each course overlapping the other so as to meet at the top in that sort of rude dome which has received the name of the 'beehive house' (q. v.). The Boss C., on the moor of Dranandow, in the parish of Minnigaff, had two galleries crossing each other—each 80 feet long, 4 feet wide, and 3 feet high.

But of all the 'chambered' cairns, the most remarkable is that at New Grange, on the banks of the Boyne, near Drogheda, in Ireland. It is 400 paces in circumference, and about 80 feet high, and is supposed to contain 180,000 tons of stones. In 1699, it was described by Edward Lhwyd, the Welsh antiquary, as 'a mount or barrow, of very considerable height, encompassed with vast stones, pitched on end, round the bottom of it, and having another, lesser, standing on the top.' This last pillar has disappeared; of the outer ring of pillars, ten still remain, placed at about ten yards one from another. 'The cairn,' says Mr Wakeman in his *Archæologia Hibernica* (Dublin, 1848), 'in its present ruinous condition, presents the appearance of a grassy hill partially wooded; but, upon examination, the coating of earth is found to be altogether superficial, and in several places the stones, of which the hill is entirely composed, are laid bare. The opening [which is nearly square, and lined by large flags] was accidentally discovered about the year 1699. The gallery, of which it is the external entrance, communicates with a [dome-roofed] chamber or cave nearly in the centre of the mound. This gallery, which measures in length about 50 feet, is, at its entrance, 4 feet high; in breadth about 3 feet. Towards the interior, its size gradually increases; and its height, where it forms the chamber, is 18 feet. The chamber is cruciform, the head and arms of the cross being formed by three recesses—each containing a basin of granite. The sides of these recesses are composed of immense blocks of stone, several of which bear a great variety of carving, supposed by some to be symbolical. The majority of these carvings must have been executed before the stones had been placed in their present positions. The length of the passage and chamber from north to south is 75 feet, and the breadth of the chamber from east to west 20 feet. Of the urns or basins in the recesses, that to the east is the most remarkable. It is formed of a block of granite, and appears to have been set upon, or rather within, another of somewhat larger dimensions.' The Irish antiquaries believe that the chambered C. of New Grange—'the Cave of Achadh Aldai,' as it was called, from Aldai, the ancestor of the Tuatha De Danaan kings—was opened and rifled by the Norsemen in 862. About a mile from it, on either side, are other two cairns of nearly equal size, named Knowth and Dowth. The latter was opened in 1847, and found to contain a gallery, a cruciform chamber, a basin or sarcophagus, and carved stones, all of the same type as those of New Grange. Engravings of the sculptures, in both cairns, are given in Mr W. R. Wilde's *Boyne and Blackwater*, pp. 192—207 (Dublin, 1850), and some of them are obviously of the same

character with sculptures found in Scandinavia; at Locmariaker, and at Gavr Innis, in the Morbihan, in Brittany; in one of the cells of a tumulus opened in 1853 at Pickaquo, near Kirkwall, in Orkney; among the ruins of an ancient fort at the Laws, near Dundee; at the ancient forts at Rowtin Lynn, and Old Bewick, in Northumberland; and on one of the standing stones near Penrith in Cumberland, called 'Long Meg and her Daughters.'

Cairns are most frequent in stony countries. Where, as in many parts of England, stones are scarce, the barrow or earthen mound came in place of the C., from which it differs only in the materials of which it is made. So also in Scandinavia. Cairns, or *dysser*, as they are there called, are rare in Denmark, but of more common occurrence in Sweden and Norway.

CAIRNGO'RM STONE, or simply CAIRNGORM, a name often given by jewellers, and particularly in Scotland, to brown or yellow quartz or rock-crystal, because found at Cairngorm, in Aberdeenshire. The same mineral is found in many other localities, as at Olivet near Orleans, in Brazil, and in Siberia. In Cairngorm and the neighbouring district of Mar, it occurs both in the granite rock and in the alluvial soil. It differs from common colourless quartz or rock-crystal only in the presence of a very little oxide of iron or manganese, to which it owes its colour. It is much used as an ornamental stone. The yellow variety is not unfrequently called topaz, although quite different from the true topaz, which it resembles chiefly in colour, having neither its hardness nor its brilliancy. The topaz is, however, sometimes found along with it in the granite and gneiss districts of Mar and Cairngorm. The brown variety is sometimes called SMOKY QUARTZ, and when of a good and uniform colour is by some preferred to the yellow.

CAIRO (Arabic, *Musr el Kaherah*, 'the victorious capital'), the capital of modern Egypt, is situated in lat. 30° 2' N., and long. 31° 16' E., in a sandy plain betwixt the right bank of the Nile and the ridge of Mokattam, and near the point of the delta of the Nile. From the foundation of the city in 969, the Fatimite califs of Africa, who brought the bones of their ancestors with them from Kairon, reigned for ten generations over the land of Egypt. The calif Hakem, who built a mosque near Bab-el-Nassr, and who is the supposed founder of the Druse religion, was the third in this succession. In the year 1171, Saladin usurped the throne from the last of the Fatimites. His descendant, Moosa-el-Ashref, was deposed in his turn in 1250; from that time till the year 1517, when the city was stormed and taken by Sultan Selim, C. was governed by a succession of Mameluke kings.

The city of C. occupies about three square miles, and is surrounded by a low wall. Its streets are narrow, dark, crooked, and unpaved, and in some parts arched over. The bazaars, although dark and gloomy, are well and richly supplied. The houses, which are generally two or three stories high, are all built of variegated brick, with interlinings of wood, and have flat roofs. The city is divided into different quarters, one quarter being appropriated to the Turks, one to the Christians, one to the Jews, &c.; so that every religious sect has its own quarter, which is separated from the adjoining one by strong gates at the end of the streets; these are closed at night, and guarded by a porter, who opens the gate when any one wants to pass.

The most remarkable buildings in the city of C. are its minarets and mosques. The minarets are

the most beautiful of any in the Levant, of a prodigious height, and built of alternate layers of red and white stone. The most ancient of all the minarets is that attached to the great mosque of Sultan Tayloou. This mosque was built in the year of the Hegira 265 (879 A. D.), before the foundation of the city, and consists of an immense cloister or arcade built on pointed arches, being the earliest extant in that form. Another magnificent mosque is that of the Sultan Hassan, situated in the place of the Roumayli, near the citadel, and which was finished about the year 1362 A. D. It has two very elegant and high minarets, and the mosque, in consequence of its size, and the thickness of its walls, was frequently seized and made use of as a fortress by the insurgents in the numerous rebellious and insurrections which were always taking place at C. under the rule of the Mameluke kings. Stains of blood are still to be traced on the marble walls of the courtyard.¹

The population of C. consists of the ruling class, who are all Turks; Arabs, the former conquerors of the land, who form the bulk of the population, all the petty tradesmen and cultivators of the soil being of Arab origin; Copts, who are descended from the original lords of the land, the ancient Egyptians; Jews, Armenians, Syrians, Africans, and Europeans. The population may be estimated at 250,000 inhabitants, of which 200,000 are Mussulmans, 10,000 Copts, 4000 Jews, and the rest Syrians, Africans, and strangers.

Of objects worthy of note in the environs of C., there may be mentioned the tombs of the califs, situated about a mile beyond the walls, which are magnificent and imposing buildings, forming beautiful specimens of Arabian architecture. The mausoleum of Sultan Bergook is a triumph of Saracenic architecture. The public gardens, which consist of groves of orange, citron, palms, and vines, are also very beautiful.

C. is the seat of learning for the East, and is celebrated for the eminence of its professors, especially those of Mohammedan theology and jurisprudence. There is a university or college attached to the mosque of Ezher, and a considerable Oriental library. In this university, grammar, arithmetic, algebra, rhetoric, &c., are taught, and lectures delivered on logic, theology, the exposition of the Koran, moral, criminal, and civil law, &c. The number of students who congregate here from all parts of the Mohammedan world is about 2000, and the instruction is given gratis, the professors subsisting on private instruction and on presents from the wealthy. Besides this university, there are other schools where grammar, writing, and arithmetic are taught, and others devoted to arts and sciences, and engineering. At Abou Zabel, there is also a school of anatomy, medicine, and surgery. The language spoken at C. is Arabic, which, though not the purest, is superior in pronunciation to that spoken in Syria. C. is the official residence of the viceroy of Egypt, and the residence of a consul-general from Great Britain, France, &c. A railway now connects C. with its seaport Alexandria.

CAISSON, in military matters, is a name sometimes given to a tumbril or ammunition wagon. It is more frequently applied, however, to a large wooden chest or frame, loaded with powder, shells, or both, and buried several feet deep in the ground under some fortification; this destructive combination is to be blown up if there be danger of the enemy approaching and taking possession of that particular part of the defence-work. The French give the name of *caisson pour les vivres* to a large chest, carried with the army, and capable of containing 800 rations.

CAISSON, in relation to shipping, is an apparatus for lifting a vessel out of the water for repairs or inspection. It is usually a hollow structure, sunk by letting water into it. There is an air-chamber inside, which allows it to sink only to a certain depth. In that state it is hauled under the ship's bottom, the traps or openings are closed, the water is pumped out, and the caisson rises with the ship upon it.

In another arrangement, a platform is sunk to a certain depth in the water, and is suspended by iron screws from a strong wooden framework; the ship is floated upon the platform, steadied by shores, and lifted high and dry by means of levers, wheels, pinions, and screws.

CAITHNESS, a maritime county, the most northerly on the mainland of Scotland. It is triangular in shape; length from north to south, 40 miles; greatest breadth, 30 miles; area, 616 square miles. Except in the west and south, where the mountain-range (composed of granite and gneiss) dividing C. from Sutherland attains, in its highest point, a height of more than 2300 feet, the general aspect of C. is level and bare, being in great part moorland and destitute of trees, while the sea-coast is bold and rocky, with many bays, inlets, promontories, and caves. On the north coast are Dunnet Head and Duncansby Head; and on the west side of the last-named head is a spot of green turf, called John o' Groat's House, where John de Groat or Groat of Warse settled with his brothers in James IV.'s time, and built a house. There are no navigable rivers in C., and no lakes of importance. The climate is damp and chilly, but snow rarely lies on the plains above a day or two at a time. Thunder is rare, but auroræ are seen almost nightly. In 1857 about an eighth of the surface was in crop, the chief crops being oats, bear, turnips, and potatoes. The parts of the surface under tillage (on the slopes and level tracts of the high plains, and along the streams) are generally a deep fertile loam on a strong till clay. In the north-east, the soil is sandy. The crops are 20 days later in ripening than in the Lothians. The occupants of many of the small farms divide their time between farming and fishing. There are herring, ling, cod, salmon, and lobster fisheries. The herring-fishery in July and August employs about 2000 boats and 12,000 persons, 300 of the boats congregating here from other parts of the Scotch coasts. Wick is the chief seat of the British herring-fishery. 150,000 to 200,000 barrels of cured fish are exported yearly. The other exports are cattle, oats, and wool. C. contains quarries of flagstone, freestone, and slate. The chief towns are Wick and Thurso. In 1851, the population was 38,709; there were 115 schools, with 6365 scholars; and 31 churches (14 Established and 17 Free). The county returns one member to parliament, and Wick unites with Kirkwall, Dornoch, Dingwall, Tain, and Cromarty, in returning another. In early times, C. is supposed to have been inhabited by Celts; these became afterwards mixed with Gothic colonies of Danes and Norwegians, who long kept up a trade with the Baltic. C., in the middle ages, was subject to the kings of Norway. David II. adopted the weights and measures of C. for all Scotland. The Scandinavian origin or mixture of the people of C. is shewn by their tall forms and soft fair features, and their speaking English instead of Gaelic. C. has remains of what are called Picts' houses, sepulchral circles, Danish round towers and forts on the sea-cliffs.

CAITHNESS FLAGSTONES are dark-coloured bituminous schists, slightly micaceous and calcareous,

valuable on account of their great toughness and durability for pavements, cisterns, and various other purposes, and accordingly are largely exported. They belong to the Old Red Sandstone, and contain abundant remains of fossil fishes.

CAIUS, DR JOHN, the person from whom Caius College, Cambridge, takes its name, was born at Norwich in 1510. His real name was Kaye or Key, which he Latinised into Caius. He was educated at Gonville Hall, university of Cambridge; and at the age of 20, turned into English Chrysostom's *Method of Praying to God*, which was followed by a translation of Erasmus *On True Theology*. He next went abroad, and resided in Italy for several years, studying medicine. On his return to England, he practised with success at Cambridge, Shrewsbury, and Norwich. Henry VIII. appointed him anatomical lecturer to the Company of Surgeons in London. In 1547, he was elected a fellow of the College of Physicians, of which he was subsequently made president. He also became physician to Edward VI., Queen Mary, and Queen Elizabeth. In 1557, he obtained permission to elevate Gonville Hall into a college, which took the name of Caius College, and of which he became master. This office he held till his death, in July 1573. His principal work is, *A Boke or Counsell against the Disease commonly called the Sweate or Sweatyng Sicknesse*. Anno Do. 1552. C., however, wrote a great number of works on a variety of subjects, critical, antiquarian, and scientific.

CAIUS COLLEGE. See GONVILLE AND CAIUS COLLEGE.

CA'JEPUT (*Melaleuca Cajeputi* or *M. minor*), a tree of the natural order *Myrtaceæ*, sub-order *Leptospermeæ*, from the leaves of which the pungent, aromatic, volatile oil, called *Oil of Cajeput*, is obtained by distillation. The C. tree is common on the mountains of the Moluccas. It is rather a small tree, with a crooked trunk, thick spongy bark, white wood (whence the name C., properly *kayuputi*, signifying white wood), elliptical-lanceolate alternate leaves, and terminal spikes of white flowers. The greater number of the species are natives of Australia, some of them very beautiful shrubs and frequent ornaments of British hot-houses. Much of the oil of C. of commerce is prepared in the island of Banda. It is said that two sackfuls of leaves yield scarcely three drachms of the oil, which is green, transparent, limpid, with a strong penetrating odour, and agreeable only when much diffused.

CALABA TREE. See CALOPHYLLUM.

CALABA'R, the name of a coast district of Upper Guinea, Africa, the limits of which are not clearly defined; but it is usually understood to extend between the river Benin and New Calabar, called by the Portuguese Rio del Rey, and as far north as the Kong Mountains. The surface is low and flat, and the climate unhealthy. Yams, which are the principal food of the inhabitants, are raised in plenty, and also the sugar-cane, and palms, from which palm-oil is obtained in large quantities. The inhabitants are polygamists, and make human sacrifices to good and evil spirits. It has long been a scene of missionary labour, but the converts to Christianity are still few.

CALABAR (OLD), a river of this district, enters the Bight of Biafra, about 52 miles west-north-west of Fernando Po, by an estuary about 9 miles in breadth. It is navigable by steamers for about 200 miles above its mouth, and abounds in crocodiles. The chief towns on its banks are—Duke Town, situated on its estuary; Creek Town, further up, both seats of British missions; Acooco Coono, and Omun.—**CALABAR (NEW)**, a branch of the Niger,

falling into the Bight of Biafra, in lat. 4° 30' N., and long. 7° 7' E. It has a bar across its mouth, which prevents the entrance of vessels drawing more than 12 feet; but some miles up it has an average depth of 30 feet.

CALABASH TREE (*Crescentia Cujete*), a tree found in the West Indies and in the tropical parts of America, of the natural order *Bignoniaceæ*



Calabash Tree.

(q. v.), suborder *Crescentiaceæ*. In height and size it resembles an apple-tree, and has wedge-shaped leaves, large whitish fleshy flowers scattered over the trunk and older branches, and a gourd-like fruit, sometimes a foot in diameter. The wood of the tree is tough and flexible, and is well adapted for coach-making. But the most useful part is the hard shell of the fruit, which, under the name of *calabash*, is much used in place of

bottles for holding liquids, and for goblets, cups, water-cans, &c. These shells may even be used as kettles for boiling liquids, and they will bear this several times without being destroyed. They are sometimes highly polished, carved with figures, tinged with various colours, and converted into ornamental vessels. The rinds of gourds are sometimes also used for holding liquids, and called calabashes.

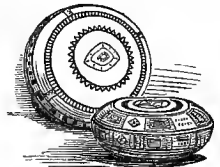

Carved Calabashes.

CALAB'RIA, a district of the kingdom of Naples, forming the whole of the peninsula of Italy, south of the province of Basilicata. Its greatest length, from the southern border of Basilicata to Cape Spartivento, is about 160 miles. In its northern part it has a breadth in some places of more than 60 miles, which suddenly contracts, between the Gulfs of Sant' Eufemia and Squillace, to not more than 16. Its entire area is nearly 7000 square miles, and its population, in 1856, amounted to 1,187,782. It is traversed throughout its entire length by the Apennine Mountains (q. v.), whose summits in the region in the north of C., known as La Sila, and the Aspromonte, in the south, are crowned with pines, while forests of oak and beech cover their sides. The valleys between the various hills afford rich pasture, especially in the north, to which, in spring-time, whole colonies migrate with their flocks and herds. There is no river of any importance in C.; but the valleys and plains, watered by such

CALADIUM—CALAMARY.

streams as there are, are very fertile, yielding wheat, rice, cotton, liquorice, saffron, the sugarcane, &c., and also the vine, orange, lemon, olive, fig, and mulberry, in luxuriance. Iron, alabaster, marble, gypsum, and antimony, are among its minerals. The fisheries of its coasts, particularly the tunny and anchovy fisheries, are important, and afford employment to a large number of the population. Manufactures are in a backward state. Silk is the staple article. The district is very subject to earthquakes. For purposes of administration, C. is divided into the provinces of C. Citra, which has a population of 456,018—capital, Cosenza; C. Ultra II., with a population of 393,584—capital, Catanzaro; and C. Ultra I., with a population of 338,180—capital, Reggio.

In ancient times, the name C. was given only to the south-east peninsula, nearly corresponding to the modern province of Terra di Otranto, no portion of which is included in modern C., which answers to the ancient *Bruttium*. The name C., as applied to the district now known by that name, appears to have originated with the Byzantines sometime prior to the conquest of the country by the Normans. A colony of the Vaudois or Waldensians of Piedmont was founded in C. in 1340, and for some time enjoyed great prosperity, but was extirpated in 1560—1561. The destruction of this colony is one of the blackest passages of the history of religion in Italy.

The Calabrians are a proud, fiery, and revengeful race. They were long celebrated as among the fiercest of banditti; but the crimes which in former times made them infamous are no longer frequent. They strenuously resisted the power of France during the Napoleonic campaigns, and were not finally subdued until 1810.

CALADIUM. See Cocco.

CALAHORRA, a town of Spain in the province of Logroño, 24 miles south-east of the city of that name, is situated on the small river Cidacos, about 2 miles from its confluence with the Ebro. C. occupies the site of the ancient *Calagurris*, celebrated in classic history for the obstinate but unsuccessful resistance it offered (78 B. C.) to Afranius, Pompey's legate, when the citizens slaughtered their wives and children for food rather than surrender. C. was the birthplace of Quintilian the rhetorician. It has an old cathedral, and a trade in the agricultural produce of the rich district in which it is situated. Pop. about 6000.

CALAIS, a seaport town of France, in the department of Pas-de-Calais, on the Straits of Dover, near its narrowest part, the distance from the town of Dover not being more than 26 miles. The latitude of the new light-house—190 feet in height—is 50° 57' 45" N., long. 1° 51' 18" E. C. is a fortress of the first class. On the south and east, low marshy grounds, which those in the city have the means of submerging, stretch up almost to the walls, which on the north and west are washed by the sea. The town, adjacent country, and port, are commanded by the citadel, which is situated at the west end of the town, while numerous forts, by their cross-fire, defend the weakest points. The harbour, which is nearly dry at low tide, and which has rarely more than from 15 feet to 18 feet of water in it, is formed by two moles, which project about three-quarters of a mile into the sea. Being one of the chief ports of debarkation for travellers from England to France, it has daily steam communication with Dover—with which it is also connected by submarine telegraph—and with London and Ramsgate several times a week. The city, which is entered from the sea by a drawbridge and gate, erected in 1685 by Cardinal Richelieu, is square in form; its streets

are, for the most part, broad and well paved; and its ramparts form pleasant promenades. But it is on the whole a dull place, though its proximity to England has made it the residence of a large number of English people. It has few objects of interest, the most noticeable being the cathedral, with a fine picture of the 'Assumption' by Vandeyck. The manufactures of C., consisting of bobbin-net (tulle), hosiery, &c., are rapidly extending; it has also distilleries, salt refineries, ship-building yards, fisheries, &c. Its exports consist of eggs—nearly 60 millions of which are yearly sent to England—corn, wine, brandy, &c. Its trade with several French towns of importance is facilitated by canal. Pop., exclusive of garrison, 10,860.

In the 9th c., C. was but a small fishing-village. In the following c., it was much improved by Baldwin IV., Count of Flanders, and still further enlarged and greatly strengthened by Philippe of France, Count of Boulogne. After a long siege and heroic defence, it was captured by Edward III. of England, whose hard terms, and the noble self-devotion they called forth on the part of six of the citizens of C., who, however, were saved by Queen Philippa's intercession, form one of the most interesting and best known passages of history. The English retained it until 1558, when it was captured by the French, under the Duke of Guise, since which time (with the exception of two years, 1596—1598, when it was in the possession of the Spaniards) it has remained in their hands. During the time it belonged to England, it was visited by several of the English monarchs. Afterwards, in 1659, Charles II. of England resided some time here; and about a quarter of a century later, James II. arrived here with French troops for the invasion of England, which the destruction of the French fleet prevented him from accomplishing. Louis XVIII. landed here in 1814, after his exile.

CALAMANDER WOOD, a cabinet-wood of the greatest value, resembling rose-wood, but much surpassing it in beauty and durability. The tree which produces it is *Diospyros hirsuta* (see DIOSPYROS), a species of the same genus which produces ebony; it has oblong obtuse leaves, which are downy beneath, and flowers without stalks and crowded; and is a native of the south-east of India, and of Ceylon, particularly of the forests at the base of Adam's Peak. But this tree 'has been so prodigally felled, first by the Dutch and afterwards by the English, without any precautions for planting or production, that it has at last become exceedingly rare,' so that wood of considerable size is scarcely to be procured at any price. It yields veneers of unusual beauty, 'dark wavings and blotches, almost black, being gracefully disposed over a delicate fawn-coloured ground.' Its density is very great, a cubic foot weighing nearly 60 lbs., and it takes an exquisite polish. The name C. W. is supposed to be a corruption of Coromandel wood.

CALAMARY, SQUID, or SLEEVE-FISH (*Loligo*), a genus of cephalopodous mollusks of the order *Dibranchiata*, and family *Tentaculida*. The body is of an elongated form, firm, fleshy, tapering, and flanked towards its posterior extremity by two triangular fins. The body contains a *gladius*, or internal shell, which is horny and flexible, narrow and pen-shaped, with the shaft produced in front. The mouth is furnished with eight arms. Calamaries have the power of diffusing a dark-coloured fluid around them in the water like the cuttle-fish. The different species are distributed over all parts of the world. Several are found in the British seas. In some seas, however, they abound much more, and form a principal part of the food of some of

CALAMIANES—CALAMY.

the larger fishes and of whales. The Common C. or Squid (*L. vulgaris*) is of a bluish colour, speckled with purple. It grows to nearly a foot and a half

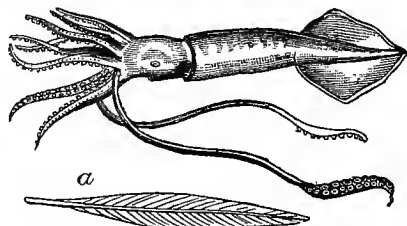

Common Calamary (*Loligo Vulgaris*):
a, gladius.

in length, without reckoning the head and arms, which add to the length about half a foot more. See CEPHALOPODA.

CALAMIA NÉS, a group of islands in the Eastern Archipelago, in lat. about 11° 25'—12° 20' N., and long. 120° E. Calamianes, the name of the largest of the group, is about 35 miles long and 15 miles broad, elevated and fertile, with abundance of animals, such as deer and hogs. It has a Spanish settlement.

CALAMINE, an ore consisting essentially of carbonate of zinc. The name is said to be derived from the Greek and Latin *calamus*, a reed, because when fused it adheres to the base of the furnace in a reed-like form. Its primary form is a rhomboid, and it occurs in small obtuse-edged crystals, also compact and massive. It is white, yellowish-white, brown, green, or gray; is sometimes opaque, sometimes translucent; is brittle, and has an uneven conchoidal fracture. It occurs in beds and veins in rocks of various kinds, but most commonly in limestone. Mendip, Matlock, Alston Moor, Lead-hills, and Wanlockhead are British localities. C. is an important ore of zinc. In the duchy of Limburg, in the Netherlands, about 1,500,000 lbs. of it are annually extracted from the mines.

CALAMINT (*Calamintha*), a genus of plants of the natural order *Labiatae*, nearly allied to BALM (q. v.) (*Melissa*). The Common C. (*C. officinalis*, formerly *Melissa Calamintha*) is not unfrequent in England. It has whorls of flowers (*verticillasters*), on forked many-flowered stalks, and serrated leaves, with an agreeable aromatic odour, not unlike that of some kinds of mint. It is used by the country people to make herb-tea, and as a pectoral medicine. —The Lesser C. (*C. Nepeta*), also an English species, is used in the same way.

CALAMITE, a genus of fossil plants whose true position has not been satisfactorily ascertained. They appear first in the Devonian rocks, and rise through the intermediate formations to the Oolitic series, where they are represented by a single species. They reach their culminating point in the Coal-measures, where 39 species have been determined. The tall straight stems rose from a swampy clay soil in profusion in the forests of sigillaria, and formed a striking and characteristic feature in the coal flora, though they supplied little material for the structure of coal. They are hollow-jointed cylinders, with longitudinal furrows, giving the fossil the appearance of *Equiseta*; from this resemblance,



Fragment of Calamite
(*C. cannaeformis*).

botanists have generally considered them as huge 'horsetails.' Hooker has been unable to detect any traces of structure, in carefully prepared specimens, or the presence of those siliceous stomata which characterise *Equiseta*, and which would have been preserved in the fossil state, and Fleming has shewn that the furrows are markings on the interior cavity. While, therefore, it is certain that they are not 'horsetails,' the absence of fructification makes every attempt to give them their position but guess-work. Hooker supposes them nearly allied to Ferns, or Club-mosses; Brongniart ranks them among Gymnospermous Dicotyledons. The upper part of the stem, and the foliage, if any, have not been noticed. The root termination was conical, the joints decreasing downwards in size and length. From the scars on the upper portion of each joint, there proceeded filaments, which were supposed to be leaves, but are really roots. These are shewn in the species figured — a species common in the English coal-field.

CALAMUS, the reed pen which the ancients used in writing, was made of the stem of a reed growing in marshy places, probably *Arundo Donax* (see REED), of which the best were obtained from Egypt. The stem was first softened, then dried, and cut and split with a knife (*scalprum librarium*), as quill pens are made. To this day, the Orientals generally write with a reed, which the Arabs also call *Kalm*.

CALAMUS, a genus of palms. See RATTAN and DRAGON'S BLOOD.

CALAMUS, a name sometimes given to the Sweet Flag (*Acorus Calamus*). See ACORUS. See also next article.

CALAMUS AROMATICUS, the name given by the ancients to a plant to which they ascribed important medicinal virtues. It is by no means ascertained what the plant is: the most probable opinion appears to be that of Dr Royle, who supposes it to be one of the sweet-scented grasses which yield the grass-oil (q. v.) of India, to which he has given the name of *Andropogon calamus aromaticus*. See LEMON-GRASS. The C. A. of the Greeks and Romans came from the East. The *Sweet Calamus* and *Sweet Cane* mentioned in Scripture (Exod. xxx. 23, and Jer. vi. 20) are probably the same with the *calamus aromaticus*.

CALAMY, EDMUND, an eminent English divine, was born in London, 1600 A. D.; studied at Pembroke Hall, Cambridge, where he attached himself to the Calvinistic party; and afterwards became domestic chaplain to the Bishop of Ely. In 1626, he was appointed lecturer at Bury St Edmunds, but resigned his office when the order to read the *Book of Sports* began to be enforced. In 1639, he was chosen minister of St Mary's, Aldermanbury, London. He now entered warmly into the controversies of the time, and became noted as a leading man on the side of the Presbyterians. He had a principal share in the composition of *Smectymnus*, a work intended as a reply to Bishop Hall's *Divine Right of Episcopacy*, and one of the most able and popular polemics of the day. Like the mass of the Presbyterian clergy, he was monarchical and not republican in his political opinions. He disapproved, therefore, of the execution of Charles, and the protectorate of Cromwell, and did not hesitate to avow his attachment to the royal cause. He was one of the deputies appointed to meet Charles II. in Holland, and congratulate him on his restoration. His services were recognised by the offer of a bishopric, which he refused from conscientious scruples. The increasing tyranny and intolerance of the High Church party compelled him to give up even his royal

chaplancy. He died October 29, 1666.—Two of his sons were educated for a religious profession: the one, Dr BENJAMIN C., became a High Churchman, and wrote *A Discourse against a Scrupulous Conscience*; the other, EDMUND C., was ejected for nonconformity, and had a son, also named Edmund, who acquired some reputation as the biographer of the ejected clergy.

CALA'NDO, in Music, an Italian expression, meaning diminishing by degrees from forte to piano; it differs from decrescendo or diminuendo, as the tempo, at the same time, is slightly retarded, but not so much as in ritardando. The proper performance of the C. is purely a matter of good taste and feeling, depending on the performer.

CALA'NDRA. See CORN WEEVIL.

CALANDRO'NÉ, a wind-instrument used by the Italian peasants, on which they play simple melodies, and also sometimes accompany their national songs. It has the holes of the common flute, but the intonation is produced as in the common pipe.

CALAS, JEAN, a Frenchman, remembered as the unhappy victim of fanaticism and the shocking mal-administration of justice, was born at Lacapardè, in Languedoc, March 19, 1698. He lived as a tradesman in Toulouse, where he had a very good reputation. One evening after supper (October 13, 1761), the eldest son of the C. family, Marc Antoine, a youth addicted to gambling, and subject to fits of deep melancholy, was found hanged in the warehouse. There was not a shadow of a reason for doubting that the unhappy young man had committed suicide; but popular rumour accused the father, or other members of the C. family, of murdering the eldest son, 'because he had contemplated conversion to Catholicism.' It was also asserted that a young man named Lavaysse, who was in the house on the fatal evening, had been despatched 'by the Protestants of Guyenne to perpetrate the murder.' The clergy exerted all their influence to confirm the populace in their delusion. At Toulouse, the White Penitents celebrated with great solemnity the funeral of the young man, and the Dominican monks erected a scaffold and placed upon it a skeleton, holding in one hand a wreath of palms, and in the other an abjuration of Protestantism. The family of C. was, in consequence of the popular excitement, brought to trial for the murder, and several deluded and (most probably) some bribed witnesses appeared against them. A Catholic servant-maid, and the young man Lavaysse, were also implicated in the accusation. C., in his defence, insisted on his uniform kindness to all his children; reminded the court that he had not only allowed another of his sons to become a Catholic, but had also paid an annual sum for his maintenance since his conversion. He also argued from his own infirmity that he could not have prevailed over a strong young man, and referred to the well-known melancholy moods of the deceased as likely to lead to suicide; and, lastly, he pointed out the improbability that the Catholic servant-maid would assist in such a murder. But all his arguments proved unavailing, and the parliament of Toulouse sentenced the wretched man—by a majority of 8 votes against 5—to torture and death on the wheel! With great firmness and protestations of his innocence to the last, the old man died on the wheel, March 9, 1762. His property was confiscated. His youngest son was banished for life from France, but was captured by the monks, and compelled to abjure Protestantism. The daughters were sent to a convent. The young man Lavaysse was acquitted, and the widow of C. escaped into Switzerland, where she was so

fortunate as to excite the benevolent interest of Voltaire, who brought the whole affair before the public, and, in his book *Sur le Tolérance*, proved that C. had fallen a victim to religious hatred and popular fanaticism. A revision of the trial followed, and, after full investigation, the parliament at Paris declared (March 9, 1765) C. and all his family innocent. Louis XV. gave to the bereaved family the sum of 30,000 livres; but, strange to say, neither the parliament of Toulouse nor the fanatical monks were ever brought to account for this horrible judicial murder!

CALASA'YA BARK. See CINCHONA.

CALASIA'O, a town of the island of Luzon (Philippines), with a population of 18,000, who are engaged in the manufacture of straw-hats, cigar-cases, &c.

CALASPA'RRA, a town of Spain, in the province of Murcia, 40 miles north-west of the city of that name. The inhabitants, numbering 5275, are chiefly engaged in agricultural pursuits.

CALATABELLO'TA, a town of Sicily, in the province of Girgenti, and 27 miles north-west of the city of that name. In the immediate vicinity is the site of the ancient *Triocala*, the chief fortress of the insurgents in the second Servile war, 103—100 B. C. Pop. about 5000.

CALATAFI'MI, a town of Sicily, in the province of Trapani, situated 8 miles south-west of Alcamo, in a very fertile district. It is ill-built, and has a ruinous old castle. Here, in 1860, the troops of Garibaldi defeated the Neapolitan soldiers. Pop. 8376.

CALATAGIRO'NE, or **CALTAGIRO'NE**, a city of Sicily, in the province of Catania, about 34 miles south-west of the city of that name. It is well built, with clean wide streets, and has the reputation of great wealth. It has manufactures of cotton fabrics and pottery. Pop. 22,000.

CALATAÑAZO'R, a town of Aragon, Spain, about 10 miles south-west of Seria. It is celebrated for a great victory over the Christians obtained by Al-Mansur in 1001. Pop. 1500.

CALATAYU'D, a city of Aragon, Spain, situated on the Jalon, near its junction with the Jiloca, about 48 miles south-west of Saragossa. It is built at the base of two rocky ridges, and out of the ruins of ancient *Biblis*, which lay about 2 miles to the east. The city is divided into a new and old portion, the former of which is composed of mean old buildings. The latter has some good streets and handsome squares. C. has a noble old castle, and among its other most noteworthy public edifices are the two collegiate churches and the Dominican convent. In the neighbourhood are some curious stalactical caves. It has manufactures of linen and hempen fabrics, woollens, paper, leather, &c., and a trade in agricultural produce. Pop. 7125.

CALATRA'VA, an order of knighthood in Spain, instituted at Calatrava (q. v.). The statutes of the order, framed by the chapter-general of the Cistercian monks, were sanctioned by the Bishop of Toledo in 1164, and afterwards by the pope. At subsequent periods, many privileges were added. After the death of the king, their patron, some of the knights were no longer willing to obey the abbot, and they consequently separated themselves from the monks, and elected a grand-master, Don Garcias de Redon. At a later period, they again united themselves to the Cistercians, after they had gained rich possessions from the Moors both in Spain and Portugal. When Castile had fallen into anarchy, and the other kingdoms were

exhausting themselves by internal feuds, the war against the unbelievers was almost entirely carried on by the knights of Calatrava. Their almost uniform success, however, gave rise to rashness; the knights were defeated by Emir Jacob ben Yuseff, nearly all of them perished, and Calatrava was occupied by the Moors. After this disaster, the knights transferred their seat to the Castle of Salvatierra, by the name of which they passed for a long time afterwards. A truce of 12 years having been concluded, during which the order revived, the knights were able, at the battle of Las Navas de Tolosa, in 1212, again to turn the tide in favour of the Christians. They then returned to Calatrava. Notwithstanding their splendid achievements, the knights of C. never possessed the vast wealth of their brethren of St James of Compostella (q. v.), a fact which is probably to be accounted for by their having ceded a part of their conquests to the orders of Alcantara and Aviz. But their grand-masters, who were chosen from the highest families in Spain, were very powerful, and exercised a vast influence on public affairs. They did not, however, escape the jealousy of the crown. Two of them were accused of treason, and died on the scaffold; and on the death of the 13th grand-master, in 1489, the administration of the order was transferred to the king by a bull of Pope Innocent VIII. By way of compensation for the loss of their independence, the knights were permitted to marry once, though they were still bound to make vows of poverty, obedience, and conjugal chastity; and latterly to profess belief in the immaculate conception. Their original costume consisted of a coat of white mail, with a white scapulary, a black cap, and a pilgrim's hood; but this dress the Anti-pope Benedict XIII., in 1397, granted them permission to exchange for a civil apparel. Their present costume

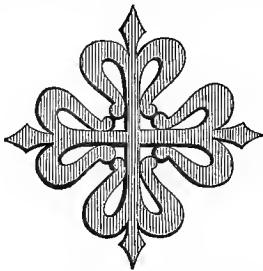

Red Cross of Knights of Calatrava.

is a white mantle, with a red cross cut out in the form of lilies upon the left breast; while the cross of the order has the same symbol on a silver ground. Two convents for nuns were attached to the order, and were at one time richly endowed. The nuns were called 'female commanders,' and wore the dress of Cistercian nuns, with the cross of the order on the left side of the capoch, fastened to the scapulary.

CALATRAVA LA VIEGA, a ruined city of Spain, situated on the Guadiana, about 12 miles north-east of Ciudad Real. In the middle ages it was a strongly fortified place, but nothing now remains but a single tower. Its defence against the Moors, undertaken by Raymond, abbot of Fitero, and Diego Velasquez in 1158, after it had been abandoned by the Templars, is famous on account of its having originated the Order of the Knights of Calatrava, long one of the most honourable in Spain. The town was called C. la Viega, or Old Calatrava, in order to distinguish it from the

convent of the knights of the Order of Calatrava, erected in the neighbourhood in 1214, and which was called Calatrava la Nueva.

CALBU'RGA, a town of the Nizam's dominions in Hindustan, about 110 miles to the West of Hyderabad. It stands on a tributary of the Beemah, which is itself a tributary of the Kistna or Krishna. It has been successively the capital of Hindu and Mohammedan sovereignties.

CALCAIRE GROSSIER (Fr. 'coarse limestone'), the French representative of the Bracklesham Eocene beds. It consists of compact limestones with seams of chert, and intercalated marls and frestones. The fossils are fresh water and marine mollusca; so abundant are they that in one spot near Grignon no less than 400 distinct species have been procured. Associated with the fresh-water remains are the bones of reptiles and mammalia.

CALCAIRE SILICEUX (Fr. 'siliceous limestone') is the French representative of the Bembridge Eocene strata. These compact siliceous limestones extend over a wide area in the Paris basin. The few fossils they contain are fresh water and land shells.

CALCAREOUS, in Chemistry, is a term applied to substances containing much lime (Lat. *calca*). Thus, *C. waters* are those which hold in solution much carbonate and sulphate of lime, and which are generally known as hard waters, and form a deposit in kettles and other vessels when heated therein.—*C. rocks* are those in which lime forms the prevailing element. They may be chemically formed, as in the case of tufas, where a saturated solution of carbonate of lime in water is deposited from evaporation or other causes; but they are generally aqueous rocks, the materials of which are supplied by animal remains. Thus, many rocks, like the mountain-limestone, are composed of shells, corals, and encrinites; while others, like chalk, consist of foraminifera and fragments of other minute testacea. A crystalline structure, varying in degree from the partially crystallised carboniferous limestones to the saccharine statuary marble, is produced in calcareous rocks by metamorphic action. Oolite is a variety of limestone composed of small egg-like grains resembling the roe of fish. The existence of lime in rocks can always be detected by the application of dilute nitric or muriatic acid, when it effervesces from the liberation of the carbonic acid. Pure lime is obtained from calcareous rocks by calcining them—i. e., by driving off the carbonic acid and other volatile matter by heat.—*C. soils* are produced from the disintegration of calcareous rocks. When the rocks are perfectly pure, they generally yield barren soils, as in many chalk and limestone districts of Britain; but when the lime is mixed with clay, so as to form marl, and has a little vegetable matter added, it forms an excellent though rather light soil. Calcareous soils are difficult of drainage, owing to the property that soft lime has of retaining water, although it easily yields it up by evaporation. Such soils are consequently soon dry at the surface after rain, but yet rarely suffer severely from drought.

CALCAREOUS SPAR, or CALC-SPAR, the name usually given by mineralogists to carbonate of lime, rhombohedral in its crystallisation. It differs from arragonite only in crystallisation. See ARRAGONITE. C. S. occurs in all geological formations, and is one of the most abundant of all minerals. It often completely fills cavities in rocks; and although it has been prevented by want of space from assuming a crystalline form, is readily divided by the knife and hammer into rhomboids,

CALCAREOUS TUFA—CALC-SINTER.

the primary form of its crystals being a rhomboid, of which the greatest angles are $105^{\circ} 5'$. Its secondary forms are more numerous than those of any

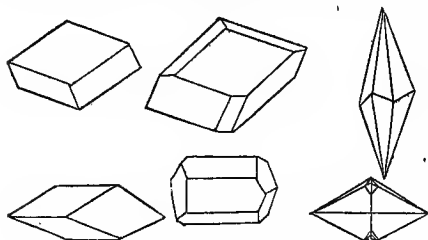

Calcareous Spar.—Various Forms of Crystals.

other mineral. More than seven hundred have been observed. One of the most common, a rather elongated pyramid, is sometimes called *Dog-tooth Spar*. C. S. is colourless and transparent, except in consequence of impurities which may be present in it; and when perfectly transparent, it exhibits in a high degree the property of double refraction of light, which was first discovered in it by Bartholinus. The presence of foreign substances frequently renders C. S. gray, blue, green, yellow, red, brown, or even black.

The name *Iceland Spar* has often been given to C. S., at least to the finest colourless and transparent variety, because it is found in Iceland, massive in trap-rock. *Slate Spar* is a lamellar variety, often with a shining, pearly lustre, and a greasy feel, of which Wicklow in Ireland, and Glen Tilt in Scotland are localities.

CALCAREOUS TUFA, CALC-TUFF, or TUFACEOUS LIMESTONE, a mineral which in its chemical composition is nearly identical with limestone and marble; but is distinguished by its spongy and cellular structure. It is generally rather soft, brittle, and friable, but sometimes it is sufficiently hard to be used as a building stone. The *travertino*, used for building at Rome, is a hard calcareous tufa. The colour of C. T. is generally yellowish-gray, sometimes yellow or yellowish-brown. It occurs massive, or assumes many uncrystalline forms, as tubular, botryoidal (like clusters of grapes), cellular, &c. Sometimes it incrusts animal and vegetable remains. It is frequent in the neighbourhood of calcareous springs. It is sometimes used as a filtering-stone.

CALCEDONY. See **CHALCEDONY**.

CALCEOLARIA (Lat. *calceolus*, a little shoe), a genus of plants of the natural order *Scrophulariaceæ* (q. v.), of which there are numerous species, natives of South America, chiefly of that part of the Andes which is more than 9600 feet above the sea, a few of them reaching almost to the utmost limits of vegetation; although some are found in lower and warmer situations, and some in the southern extremity of the American continent. They abound so much in some parts of Chili and Peru, as to give a peculiar aspect to the landscape. The calyx in this genus is 4-partite; the corolla, 2-lipped; the lower lip remarkably inflated, so as to form a bag; and the shape of the whole in some species considerably resembling that of a slipper. There are only two fertile stamens, and the capsule is semi-bivalvular with bifid valves. Some of the species are shrubby, some herbaceous, almost all the herbaceous species being perennial. Many of them have corymbs of numerous showy flowers. Yellow is the colour which chiefly prevails in the flowers of the original species, and next to it purple; but the art of the gardener has succeeded in producing

varieties and hybrids which exhibit many other rich and delicate tints. Calceolarias have been florists' flowers since about 1830, the curious appearance of the flowers combining with their beauty to render them attractive, and in no genus is the production of hybrids more easily or frequently effected. They are easily propagated by cuttings. Few plants require more liberal supplies of water. They are generally treated in Britain as half-hardy or as greenhouse plants.—Some of the species are used in South America for dyeing. The roots of *C. arachnoidea*, a parent of many of the hybrids in our gardens, are largely employed in Chili, under the name of *Relbum*, for dyeing woollen cloths crimson.

CALCINATION, or CALCINING (see **CALX**), is the process of heating or roasting in furnaces or in heaps the various metallic ores. It is resorted to as the first stage in the extraction of the majority of the common metals from their ores, and is essentially a process of oxidation.

CALCIUM is the metal present in chalk, stucco, and other compounds of lime. It may be obtained by passing a powerful current of voltaic electricity through fused chloride of C. (CaCl), when the metal separates in minute globules. It is a yellowish-white metal, can be rolled into sheets, and hammered into leaves, and is intermediate between lead and gold in hardness. It is represented by the symbol Ca, has the atomic weight or equivalent 20, and has the density 1.578, or nearly half as heavy again as water. At ordinary temperatures, it slowly tarnishes by oxidation; and when placed in contact with water, it rapidly decomposes the water (HO), forming lime (CaO), whilst hydrogen escapes. To be retained bright, C. must be kept under the surface of naphtha. At a red heat, it melts and burns with a dazzling white light, accompanied by scintillations. See **LIME**.

CALCOTT, SIR AUGUSTUS WALL, R.A., a distinguished English landscape painter, was born at Kensington, London, in 1779. In 1803, he devoted himself to landscape painting; in 1810, was made a member of the Royal Academy; was knighted in 1837; and in 1844, made conservator of royal pictures. His landscapes are remarkable for their beauty, clear definition of objects, good drawing, and truthful natural colouring. He has been called the English Claude, a designation to which he is not altogether unentitled. He died November 1844.

CALCOTT, JOHN WALL, a distinguished musical composer, elder brother of the above, was born at Kensington, 1766. Too nervous to be a surgeon, for which he was intended, he devoted his attention to music, and in 1785 won three of the four gold medals annually given by the Catch Club, the admired *O Sovereign of the willing Soul* being one of the successful pieces. During the next ten years, he obtained twenty of the medals given by the same society. In 1785, he was made Bachelor, and five years afterwards, Doctor of music at Oxford. In 1805, he published his *Musical Grammar*; in the following year his mind gave way under the continuous strain to which it had been subject. He recovered again, but only for three years, when he relapsed, and continued insane until his death in May 1821. He was one of the most eminent composers belonging to the British school of music, and especially celebrated for his glee compositions. His choicest productions were published in two volumes by his son-in-law, Mr Horsley, in 1824.

CALC-SINTER, a mineral, chemically identical with the purest marble and calcareous spar, but peculiarly characterised by its fibrous structure. It

is formed from water holding carbonate of lime in solution, and occurs generally incrusting the roofs, walls, and floors of caves, particularly those in limestone rocks; often assuming curious and even fantastic forms. Macalister's Cave, in the Isle of Skye, and the limestone caves of Derbyshire, are the most celebrated British localities. But the stalactitic cave of Antiparos, in the Grecian Archipelago, is a far more famous locality for this mineral, which is often called *Calcareous Alabaster*, and used for the same purposes with the true alabaster (q. v.), to which it is in some respects preferable, particularly as not being liable to injury from exposure to the air. Volterra, in Tuscany, is another very famous locality for Calc-sinter.

CALCULATING MACHINE. The most remarkable application hitherto made of machinery, is perhaps that through which it has been used to relieve the scientific inquirer to a very great extent of the fatigue of manipulating figures, which consumes so much of his time and energies. Various machines have been constructed for this purpose, differing in the extent of their faculties—to use words more suitable to thinking beings than to engines—and somewhat in the principles of their construction. By the *Arithmometer*, for instance, a machine invented by M. Thomas of Colmar, all ordinary arithmetical operations are executed without fatigue to the operator; and by a machine contrived by M. M. Scheutz, which rests on the principle of *Differences* (q. v.), on the turning of a wheel, the successive terms of any series whose law may be confided to it, are produced—the machine at the same time *printing* a large proportion of its results, and thus providing for the accuracy of its tables. It is a fact of which the nation should be proud, that our countryman, Mr Babbage, is universally acknowledged as the instigating and guiding genius in the progress of these remarkable inventions. Among his inventions are a *Difference Engine*, of very comprehensive powers, indeed capable of managing series so complex that the differences of its terms do not reach zero until we ascend to the seventh order (*vide art. DIFFERENCES, CALCULUS OF*). An immense range of nautical and astronomical tables lie within the limits just defined; and the machine further tabulates approximately any series whatever that can be treated by the *Method of Differences*. While engaged in constructing the *Difference Machine*, Mr Babbage, probably through his increased experience of the capabilities of machinery, was led to form a new conception—that, namely, of the *Analytical Machine*. This has not yet been fully realised; but there is no doubt but that, with proper encouragement, Mr Babbage would successfully construct it. He has actually succeeded so far as to devise the means of making his machine perform all the elementary operations of addition, subtraction, multiplication, and division; and it is clear that all changes that can be produced on quantity are merely combinations of these. If, then, he could but make his machine perform these operations at command, and according to any special order, it could clearly develop any function whatever whose law is ascertained and fixed. A solution of this difficulty was suggested by the Jacquard Loom (q. v.), in which the *cards* oblige a machine capable of working *any* pattern to work out one particular pattern; and Mr Babbage having succeeded so far as to form a machine capable of executing any development, expects, by means of *cards of operations*, to compel his C. M. to work according to one fixed law, and no other. The withdrawal of the government aid, given to him for a series of years, has, however, much to the public regret and loss, prevented, let us hope

only for a time, the realisation of his views. An instructive paper on the details of the *Difference Machine* will be found in the *Edinburgh Review*, July 1834; and both machines will be found described in a memoir by M. Menabrea of Turin, translated by Lady Lovelace in the third volume of Taylor's *Scientific Memoirs*.

CALCULUS, or **STONE** (in Medicine), a hard concretion formed within the animal body, in consequence of the deposition in the solid form of matters which usually remain in solution. See **CONCRETION**. The concretions most commonly termed calculi are those formed in the kidneys or bladder (*Urinary C.*); and those formed in the gall-bladder or biliary ducts (*Biliary C.*). Both of these give rise to very painful symptoms, and may even threaten life.

Biliary C., or *Gall-stone*, may generally be presumed to exist when excessively severe pain suddenly arises in the right side beneath the border of the ribs, and when in a few hours jaundice comes on, shewing that some obstruction has existed to the outward flow of the bile. But the absolute proof that these symptoms depend on C. is often wanting. The pain is fortunately transitory, but is more severe while it lasts than almost any other known form of suffering, unless it be that of a C. in the kidney and ureter. It may be relieved by large doses of opium, but the remedy requires to be cautiously given, as even in medical hands fatal accidents have occurred. Gall-stones, when impacted in the ducts, sometimes have proved fatal; but much more frequently they find their way, sooner or later, into the intestines. They are almost invariably composed of cholesterine (q. v.), with colouring matter and mucus, arranged in layers in a semi-crystalline disposition.

Urinary C. is a disease of all ages, but most common in advanced life and in the male sex. It is also very frequent in gouty persons, or among those who pursue sedentary occupations, and live freely. It is rare among those who live much in the open air, or who take much violent exercise, and use little animal food and wine. Among sailors, it is peculiarly rare. In certain parts of the country, the disease is said to be frequent, as in Norfolk, and perhaps along the east coast of Scotland. In India, too, where some of the predisposing circumstances mentioned above can hardly be said to prevail, stone is by no means uncommon. It would appear, therefore, that the predisposing causes of C. are still very imperfectly understood. In its early stages, the disease usually presents itself in the form of *Gravel*, shewn by the passage of numerous very small portions of gritty concretions, which may be observed in the urine as a deposit like sand, or like small grains of Cayenne pepper. When such deposits occur frequently, especially if they are present at the time of passing the urine, and not merely after it has cooled, there is reason to apprehend the formation of calculus. If, in these circumstances, there are pains of a dull character in the loins, with occasional twinges of sharper suffering, no time should be lost in seeking medical advice. If a fit of very severe pain should occur in a person for some time affected with gravel, if the urine be bloody, if agonising twinges, commencing in the loins, sting downwards into the thigh or the groin, it is probable that a stone has already formed in the kidney, and is being displaced towards the bladder. C. in the bladder is at first attended with little suffering, as compared with that caused by the stone in its passage downwards from the kidney; but unless removed or evacuated, the C. is sure to enlarge, and it then becomes the cause of one of the most painful diseases that afflict humanity. The existence of a stone in the bladder,

however, should never be taken for granted without a surgical examination, as all the symptoms are deceptive in certain cases. The most striking, and perhaps the most trustworthy evidence of stone in the bladder, apart from the use of the sound (see LITHOTOMY), is smarting and burning pain experienced after the bladder has been emptied, together with occasional temporary stoppage in the flow of urine. The correct appreciation of all the symptoms, however, demands considerable familiarity with such cases.

The discovery of the tendency to urinary C. at an early period of its growth, has been greatly aided by the use of the microscope and of chemical tests. Generally speaking, it may be said that whenever the urine, after standing for a few hours, can be observed to contain more sediment than a very slight cloudiness towards the bottom of the vessel, there is room for careful inquiry into the existence of some derangement of the health. But all sediments are not equally apt to determine C., nor is the treatment of the different kinds of sediment at all similar; care should therefore be taken to determine, from time to time, whether the character of the sediment may have undergone a change, so that the treatment may be adapted accordingly.

The chief varieties of urinary C. are—1. Uric acid (red sand); 2. Urates of ammonia, soda, lime, &c. (brick-dust sediment); 3. Phosphates of ammonia and magnesia, lime, &c.; 4. Oxalate of lime; 5. Carbonate of lime (chiefly in domestic animals); 6. Cystine; 7. Xanthic oxide (a very rare form, discovered by Dr Marcet). Calculi are frequently found to be composed of numerous successive layers, having a perfectly distinct chemical composition. Urates and phosphates in particular frequently succeed each other, and form what is called an alternating calculus.

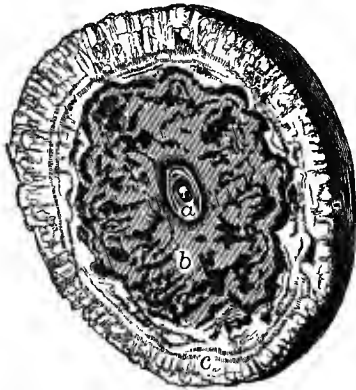

Alternating Calculus—from Dr Marcet's Essay on Calculus :

a, uric acid nucleus; b, oxalate of lime; c, phosphates of lime, and of magnesia and ammonia.

When C. has once fairly formed in the urinary passages, it seems probable that no absolute cure exists except the removal of it, if possible, from the body (see LITHOTOMY and LITHOTRITY); but in the stage of gravel, and still more in the earlier stages detected by careful examination of the urine, much may be done to check the tendency to this distressing and dangerous malady. The chief remedies consist in careful regulation of the diet and mode of living, together with the use of solvents adapted to the particular form of deposit found to be habitually present. See URINE.

CALCULUS, THE INFINITESIMAL, otherwise sometimes called the Transcendental Analysis, is a branch of mathematical science which commands, by one general method, the most difficult problems in geometry and physics. The merit of the invention of this powerful mathematical instrument has been claimed for Leibnitz, but is undoubtedly due with equal justice to Newton, who laid the foundations for it in that celebrated section of his *Principia* in which he demonstrates the chief theorems regarding the ultimate values or limits of the ratios of variable quantities. The view of one class of writers is, that these distinguished men invented the C. simultaneously and independently; and it is the fact that Leibnitz's system is unfolded from premises differing somewhat from those of Newton. See FLUXIONS. Another class of writers hold that Newton is the real inventor, and that to Leibnitz no more can be conceded than that he was the first who, using the suggestions of Newton's genius, gave a systematic statement to the principle of the transcendental analysis, and invented its appropriate symbolic language. He had the doctrine of limits before him when he wrote, and did little more than unfold more fully the logic of the processes therein suggested, and exhibit them in algebraical forms.

The Infinitesimal C., both in its pure and applied forms, whether of geometry or mechanics, is a branch of the science of number; its symbols are of the same kind, are operated on according to the same laws, and lead to analogous results. It differs from the other branches of the science of number, such as arithmetic and algebra, in regarding number as continuous—i. e., as being capable of gradual growth and of infinitesimal increase, whereas they deal with finite and discontinuous numbers. It differs from ordinary algebra in another respect. In the latter, the values of unknown quantities, and their relations with each other, are detected by aid of equations established between these quantities *directly*; in the C., on the other hand, the equations between the quantities are not directly established, but are obtained by means of other equations primarily established, not between them, but certain derivatives from them, or elements of them. This artifice is most fertile, for it can be shewn that in the great majority of cases the relations of quantities concerned in any problem may more easily be inferred from equations between these their derivatives or elements than between themselves.

It will be seen that the C. created a new notion of number—as continuous or growing. It is now necessary, in order to a proper conception of it, that a precise idea should be formed of a *differential*. The simplest idea of a differential is unquestionably that got by considering number as made up of infinitesimal elements, and a differential or 'infinitesimal' as being the value of the difference between a number at one stage of its growth and at another *very* near it. Every finite number being—in the view of the C. as first conceived by Leibnitz—composed of an infinite number of these infinitesimal elements, certain axioms at once present themselves regarding infinitesimals; as, for instance, 'that a finite number of them has no value at all when added to a finite quantity.' Many other such axioms readily follow, from which, on this view, the whole theory of the infinitesimal C. may be constructed. But there are logical objections to this mode of forming the theory of the transcendental analysis, and of three views that have been propounded, that now universally accepted as the most logical, and as being capable of the easiest application, is that founded on the method of limits, already referred to as the invention of Newton. The

meaning of a differential on this view will now be explained.

It is clear that the C. can be applied only where numbers may have the continuous character—i. e., where they are or may be conceived as being variable. If two unknown quantities are connected by a single equation only, we clearly have the condition satisfied, as where y and x are connected by the equation

$$(1) \quad y = F(x),$$

where F is a sign denoting some function of x , as $\tan. x$, $\cos. x$, x^2 , &c. This equality may be satisfied by innumerable values of y and x . One question which the C. solves is, how does y vary when x varies? To solve it, and, at the same time, shew how the doctrine of limits affects the definition of a differential, suppose x , y , and $x + Dx$, $y + Dy$, to be two pairs of values of the variables which satisfy the above equation; then

$$(2) \quad y = F(x), \quad \text{and} \quad (3) \quad y + Dy = F(x + Dx).$$

From (2) and (3) we have, by subtraction,

$$(4) \quad Dy = F(x + Dx) - F(x);$$

whence we have the ratio

$$\frac{Dy}{Dx} = \frac{F(x + Dx) - F(x)}{Dx}$$

This ratio will generally change in value as Dx and Dy diminish, till, as they both vanish, which they must do simultaneously, it assumes the form $\frac{0}{0}$.

Taking this form, it ceases to have a determinate actual value, and it is necessary to resort to the method of limits, to ascertain the value to which it was approaching, as Dx and Dy approached zero. Let, then, dx and dy be any quantities whose ratio is equal to the limiting ratio of the increments Dx , Dy , so that

$$\frac{dy}{dx} = \lim \frac{Dy}{Dx}$$

as Dx and Dy approach zero. Then dx and dy are the differentials of x and y . It may be observed that where x and y are connected as above, they cannot vary independently of one another. In the case assumed, x has been taken as what is called the independent variable, the question being, how does y vary when x varies. If y were made the independent variable, it would be necessary to solve the equation $y = F(x)$, if possible, so as to express x in terms of y . The result would be an equation $x = \phi(y)$. This

being obtained, we should find $\frac{dx}{dy} = \lim \frac{Dx}{Dy}$ as before. It will be seen that on this view differentials are defined merely by their ratio to one another. Their actual magnitude is perfectly arbitrary. This, however, does not render an equation involving differentials indeterminate, since their relative magnitude is definite, and since, from the nature of the definition, a differential cannot appear on one side of an equation without another connected with it appearing on the other.

The idea of a differential being once comprehended, the reader will be able to understand, in a general way, the main divisions of the C., which we shall now briefly delineate. So much is clear from what has been stated, that there must be two main divisions—one by which, the primary quantities being known, we may determine their differentials; and another by which, knowing the differentials, we may detect the primary quantities. These divisions constitute the Differential C. and Integral C. respectively.

1. THE DIFFERENTIAL CALCULUS.—Recurring to the formula already given we know

$$\frac{dy}{dx} = \lim \frac{Dy}{Dx} = \lim \frac{F(x + Dx) - F(x)}{Dx}$$

It is clear that, in the general case, $\frac{F(x + Dx) - F(x)}{Dx}$

at the limit will still be some function of x . Calling it $F'(x)$, we have generally $\frac{dy}{dx} = F'(x)$. $F'(x)$ is called the first differential coefficient of y or $F(x)$. Being a function of x , it may be again differentiated. The result is written

$$\frac{d^2y}{dx^2} = F''(x),$$

$F''(x)$ being the second differential coefficient of y or $F(x)$; and again $F'''(x)$ may be a function of x , and so capable of differentiation. Now, it is the object of the differential C. to shew how to obtain the various differentials of those few simple functions of quantity which are recognised in analysis, whether they are presented singly or in any form of combination. Such functions are the sum, difference, product, and quotient of variables, and their powers and roots; exponentials, logarithms; and direct and inverse circular functions. The C. so far is complete as we can differentiate any of those functions or any combination of them—whether the functions be explicit or implicit; and with equal ease we may differentiate them a second or any number of times. This C. is capable of many interesting applications as to problems of maxima and minima, the tracing of curves, &c., which cannot here be particularly noticed.

2. THE INTEGRAL CALCULUS deals with the inverse of the former problem. The former was: Given $F'(x)$, to find $F''(x)$, $F'''(x)$, and so on. The present is in the simplest case—viz., that of an explicit function: Given $\frac{dy}{dx} = F'(x)$, to find $F(x)$. The methods of the Integral C., instead of being general, are little better than artifices suited to particular cases; no popular view can be given of these. In many cases, integration is quite impossible. The explanation of *integration by parts*, by *approximation*, *definite integrals*, and *singular solutions*, is far beyond the scope of the present work. The reader is referred to any of the numerous text-books on the subject. The Integral C. has applications in almost every branch of mathematical and physical science. It is specially of use in determining the lengths of curved lines, the areas of curved surfaces, and the solid contents of regular solids of whatever form. The whole of the lunar and planetary theories may be described as an application of the integral C., especially of that branch of it which deals with the integration of differential equations. It is applied, too, in hydrostatics and hydrodynamics, and in the sciences of light, sound, and heat. In short, it is an instrument without which most of the leading triumphs in physical science could never have been achieved.

CALCULUS OF VARIATIONS.—The foundation of this C. is a method of differentiation, but of quite a peculiar kind. As above explained, the object of the differential C. is to determine the form which a function, such as $F(x)$, will assume if x receive an indefinitely small increment, such as Dx . In the C. of variations, the object is to ascertain and lay down the laws of the changes supervening on a slight alteration of the form of the function, or should $F(x)$ become F^1x . This C. commands with ease a class of problems called problems of isoperimeters, which were formerly insoluble. It has also power over mechanical problems, and many departments of high physics cannot be touched without its aid. Mr Airy and Professor Jellet have both

CALCUTTA.

written works on the subject, which may be consulted.

CALCULUS OF FINITE DIFFERENCES, CALCULUS OF FUNCTIONS, and CALCULUS OF OPERATIONS.—For brief notices of these growths from the original Transcendental Analysis, see **DIFFERENCES, FUNCTIONS, and OPERATIONS.**

CALCUTTA, the capital of the presidency of Bengal and of all British India, and the chief commercial city of Asia, is situated on the left or east bank of the Hoogly, one of the principal arms of the Ganges, nearly a hundred miles from the sea, in lat. 22° 35' N., long. 88° 30' E. The river adjacent to the city varies in breadth from rather more than a quarter to about three-quarters of a mile. Ships of 1400 or 1500 tons can ascend to C., where there is anchorage in six or seven fathoms of water; for greater security, however, against the violent gales which not unfrequently occur, the vessels are often made fast by strong moorings along the river's bank. The city stands on a level tract of land, and extends from north to south nearly five miles; its greatest breadth from east to west is about two miles. Pop. estimated at from 600,000 to 700,000, of whom the Europeans and those of European extraction, including half-castes, may amount to about 15,000. The remainder, though consisting chiefly of natives of India, includes persons from almost every part of Asia, from the neighbouring islands, and from Eastern Africa.

The southern portion of C., called Chowringhee, comprises the principal European residences, many of which are fine, and even splendid edifices, so that the town, viewed from that side, may merit the appellation, which it has frequently received, of the 'City of Palaces.'

Towards the south-western extremity of the city, there is a large open space, popularly known as the Maidan (pronounced 'my-dân'), or 'Plain,' nearly two miles long, and varying in breadth from about three-fourths of a mile at its northern, to a mile and a half at its southern margin. The northern portion of this plain is called the Esplanade. The Maidan is bounded on the west by the Hoogly, and on the east by the Chowringhee Road. It is intersected by various streets or roads, which, with the Strand (along the river), constitute the fashionable 'drives' for the wealthy Europeans of Calcutta. Near the river, and about equally distant from the north and south extremities of the Maidan, stands Fort William, the most important fortress of India. It occupies, with its outworks, a space of more than half a mile in diameter, mounting upwards of 600 cannon. It will conveniently hold, it is said, for purposes of defence, 15,000 men.

Among the principal edifices of C., the most conspicuous is the Government House, or residence of the governor-general, a magnificent palace, built by the Marquis of Wellesley (q. v.), and situated on the northern border of the Esplanade, about one-third of a mile from the river. It has four wings, and the central building is surmounted by a splendid dome. The houses of Esplanade Row, in a line with the Government House, and facing the Maidan, are among the finest in Calcutta. Of the various monuments with which the city is adorned, the most worthy of notice are, perhaps, the statue of the Marquis of Wellesley, and Sir David Ochterlony's monument, a lofty tower standing near the north-eastern extremity of the Maidan. The summit of this tower commands an extensive and magnificent view of the city and its environs.

C. is the residence of an English bishop, who is metropolitan of all India. The city contains religious edifices of almost every class, comprising,

besides Christian churches of various denominations, Hindu temples, Mohammedan mosques, and a Chinese temple.

C. is the seat of numerous educational institutions, both secular and religious. Among the former are, the college of Fort William, originally designed especially for the Company's civil service; the Sanscrit college; the Madrassa or Mohammedan college; and the Hindu college; all under the control of the government. The principal institutions affording religious instruction are Bishop's College, intended chiefly for the education of missionaries, teachers, &c.; and the institutions of the Established and Free Churches of Scotland, which are conducted with great ability, and have been eminently successful.

Of the literary and scientific institutions of C., the most important is the Asiatic Society, which possesses an extensive and valuable museum, and an excellent library, exceedingly rich in Oriental works and rare manuscripts. The museum contains specimens illustrating almost every department of the antiquities as well as the natural history of India. There is also a large and well-selected public library, which is not only free to all visitors, but those wishing to take out books are accommodated on the most liberal terms.

Among other objects of interest, the Mint, situated in Clive Street, deserves particular mention. The machinery for coining, and the general arrangements, are of the most perfect kind. It is stated that in this establishment 500,000 coins can be struck off in twenty-four hours.

C. is supplied with excellent water, brought from the numerous tanks throughout the city by water-bearers or *bahisties* (familiarly called *beesties* by the English), who carry it in large leathern bags. The tanks, which are walled with mason-work, exceed 1000 in number. They are, for two reasons, a necessary of life to the city. Boring has uniformly failed, though carried, on one occasion, to the depth of about 500 feet; and the river is, in general, so brackish, as to be unfit for domestic use. The reservoirs rely altogether on the wet season, being either fed directly from the heavens, or else supplied from the Hoogly, when it is sufficiently freshened by the periodical rains. It is only for such rough purposes as the watering of the streets, that the stream itself is rendered immediately available.

Among the principal objects of interest in the vicinity of the city is the Botanic Garden, situated on the opposite side of the river, about three miles below Calcutta. It contains an extensive and varied collection of tropical plants from both hemispheres, among which the great banyan-tree, covering more than two acres of ground, attracts the notice and wonder of all beholders. Garden Reach, a beautiful suburb of C., extends a considerable distance along the left bank of the Hoogly, opposite the Botanic Garden, from which it derives its name. It consists chiefly of the palatial residences of wealthy merchants doing business in the city. In C. all the necessaries, and nearly all the luxuries of life, whether produced in the neighbouring districts, or imported from the most distant countries, may be obtained at very moderate prices. Living at hotels is indeed cheaper here than in most of the cities of Europe or America.

C. was founded by Mr Charnock, agent of the East India Company, near the close of the 17th c., on or near the site of a small village called Kalikutta, the 'village of the goddess Kali,' whence the present name of the city. (The temple of Kali, immediately south of C., is still frequented at the period of the annual worship, or *puya*, by vast multitudes of devotees.) In 1756, the place was

taken, and nearly destroyed, by Suraja Dowlah, Nabob of Bengal, on which occasion 123 English prisoners were suffocated in the 'Black Hole' (q. v.). In the following year (1757), Colonel, afterwards Lord, Clive, gained the important victory of Plassey, which may be said to have established the British dominion in India. Soon after, the present Fort William was built, and from that date the city has been constantly and rapidly increasing in wealth and population until it has become the metropolis of a mighty empire.

C., in fact, is the key, military and mercantile, of the spacious and populous basins both of the Ganges and of the Brahmaputra. Along each of its subject valleys C. has established steam-navigation, thus bringing Assam and Allahabad within comparatively easy reach of itself and of one another, while it is, twice a month, connected with England by voyages of five weeks. C., at the same time, communicates by railway with the north-west, as it soon will do with Bombay and Madras, being already linked by the electrical wire with all the three. But the city's tenure of its river is believed to be precarious—to be, in fact, steadily weakening. Through the same influences which have created, and are still extending, the delta of Bengal, the Hoogly is known to be silting up from the bottom. Even as to this, however, C. is not without a remedy. The Mutwal or Roymatla, the fourth channel of any magnitude to the eastward of the Hoogly, which is itself the most westerly, has never less water in it than three fathoms, so that a ship of considerable burden can ascend to Taida, a village apparently as near to C. as Diamond Harbour, its ordinary port at present. With this available stream, C., as has been suggested, may, in case of necessity, be joined by a railway, or by a canal of adequate dimensions.

Politically, the alarming crisis of 1857 has had its effect on Calcutta. The insurrection, it is true, did not actually break forth here, being probably kept down by that self-relying attitude of the citizens which it had provoked; but the transfer of authority, which the insurrection may be said to have occasioned, has virtually placed under C. the eastern dominions of the crown as well as those of the Company; so that, after the lapse of little more than 100 years, the Black Hole of 1756 is now the centre of a viceroyalty, which, from Cashmere to Singapore, and from Hong Kong to Aden, includes three times the population of Russia, and embraces about as many degrees of latitude and of longitude as the whole of Europe.

In 1852, C. was erected into a sort of municipality, the proprietors paying assessments and electing commissioners for cleansing, improving, and embellishing the city. About the same time, the Oriental Gas Company of London, organised for India in general, selected its metropolis as the first scene of its operations.

During a series of 6 years, the annual fall of rain was found to average 64 inches. The mean temperature is 66° F. in January, 69° in February, 80° in March, 85° in April and May, 83° in June, 81° in July, 82° in August and September, 79° in October, 74° in November, and 66° in December.

The maritime commerce of C., as compared with that of the other seats of presidency, stands as follows in the official returns for 1857:

Tonnage of vessels entered and cleared,	Bengal. Bombay. Madras.		
	Tons, 1,606,583	1,501,068	1,441,629
Exports,	£13,443,967	£10,740,004	£2,407,906
Imports,	14,172,486	11,895,060	2,540,739

CALDAS, or CALDE/TAS (Lat. *Calidus*, hot),

the Spanish for warm springs (*aguas*, waters, being understood), which are very abundant in the Peninsula, where a great number of places have received their names from the presence of these mineral waters; such as C. de Malavella, C. de Estrac, and C. de Mombuy, in Catalonia; C. de Reyes, C. de Cuntis, and C. de Tuy, in Galicia; C. de Taipas, C. de Faveios, C. de Rainhas, and C. de Renduse, in Portugal. The name has also passed into the topography of the New World. There is a C. in Brazil, which is noted for its hot sulphur springs.

CALDER, a river in the West Riding of Yorkshire. It rises in a marsh on the borders of Lancashire, near Burnley, runs tortuously east in the deep valley of Todmorden, past Halifax, Dewsbury, and Wakefield. It then runs north-east, and after a total course of 40 miles, it joins the Aire near Poutefract, that river falling into the Ouse. The C. is important as forming a considerable portion of the canal route through Yorkshire and Lancashire, between the east and west coasts of England.

CALDERON (DON PEDRO) DE LA BARCA HENAO Y RIANO, was born in Madrid, in the year 1601, and received his early education in the Jesuits' College at Madrid. Afterwards, at Salamanca, he studied chiefly history, philosophy, and law. His poetical genius was precocious. Before he was 14 years old, he had written a drama, *El Carro del Cielo* (The Celestial Chariot). In early life he gained, by his poetry, and also by his fertile invention of decorations, &c., for festive occasions, the patronage of several distinguished persons, and, on leaving Salamanca, 1619, was well received by the courtiers at Madrid. Love of military adventure induced him to enter the army, 1625; and, after serving with distinction in Milan and the Netherlands, he was recalled to the court of Philip IV., a prince fond of theatrical amusements, by whom he was employed to superintend various court-amusements, and especially to invent dramas for the Royal Theatre. In the following year C. was made knight of the order of San Jago, and took part in the campaign in Catalonia. Peace brought him back to poetry. The king gave him a pension, contrived to let him cultivate uninterruptedly his fertile dramatic genius, and spared no cost in securing for his plays a splendid initiation on the stage. In 1651, C. received from the head of the order of San Jago permission to enter the church, and, in 1653, was appointed to the chaplaincy of the arch-episcopal church of Toledo; but as this post removed him too far from the court, he was appointed chaplain in the Royal Chapel at Madrid, 1663, and received, with other favours, a pension charged on the revenue of Sicily. In the same year he was appointed a priest in the brotherhood of San Pedro, and, shortly before his death, was elected by his brethren as their *caplan mayor*. He died May 25, 1681, leaving his considerable property to the fraternity of San Pedro, by whom a splendid monument to his memory was raised in the church of San Salvador at Madrid. Fame and pecuniary prosperity had accompanied his career. The chief cities of Spain—such as Toledo, Seville, and Granada—had paid him, from time to time, large sums of money for writing their *Autos Sacramentales*, or *Corpus Christi* pieces. In these compositions, C. excelled all his predecessors, and esteemed them more highly than all his other works, though in many respects the latter display the author's genius quite as remarkably.

Spain numbers C. among its greatest poets, and criticism must allow that many of the defects in his works are to be ascribed to circumstances, and the times in which he lived, rather than to the native

tendencies of his genius. He is characterised by brilliancy of fancy, elegance of versification, and a richness of detail, which from its very abundance often becomes tedious. His collected dramatic works—including many pieces of intrigue, heroic comedies, and historical plays, of which some deserve the title of tragedy—amount to 128. Among his romantic tragedies, the *Constant Prince* (*El Principe Constante*) holds the first rank. Besides these, he wrote 95 *Autos Sacramentales*; 200 *Loas* (preludes); and 100 *Saymetes* (divertissements). His last play, *Hado y Divisa*, was written in his 80th year. His shorter poems have perished; but his dramas have held their place on the stage better than those of Lope de Vega himself. The most complete edition of his dramas appeared at Madrid (9 vols., 1683—1689); another was published by Apuntes (10 vols., Madrid, 1760—1763). Goethe and Schlegel have made him popular in Germany, but in Britain he is not well known, and in France not cared for.

CALDERON, DON SERAPHIN, a living Spanish poet, was born at Malaga about the commencement of the century, studied law at the university of Granada, and in 1822 became professor of poetry and rhetoric there. A volume of poems which he published shortly after procured for him some distinction. Subsequently, he became an advocate in his native city, but still continued faithful to the muses. In 1830, he went to Madrid, where he published anonymously his *Poetas del Solitario* (1833). He also wrote several articles on Andalusian manners for the *Cartas Españolas*, the only literary journal at that period in Spain. In 1836 he was appointed civil governor of Logroño, but an accident obliged him to return to Madrid, where he devoted himself to collecting MSS. of the old national literature, to be the basis of a great critical edition of the *Cancioneros* and *Romanceros*. C. has likewise written a fine novel, entitled *Cristianos y Moriscos*, in the spirit and style of Cervantes, which was published in the *Collecion de Novelas Originales Españolas*. To the literature of the Spanish Moors he has paid great attention. His latest work is a series of lively sketches of Andalusian life, *Escenas Andaluzas* (1847).

CALDERWOOD, DAVID, an eminent Scottish divine and ecclesiastical historian, descended of a good family, was born in 1575, and about 1604 was settled as Presbyterian minister of Crailing, Roxburghshire. Opposed to the designs of James VI. for the establishment of Episcopacy in Scotland, on that monarch's visit to his native country in 1617, he and other ministers signed a protest against a bill, then before the Scots parliament, for granting the power of framing new laws for the church to an ecclesiastical council appointed by the king, and in consequence he was summoned before the High Commission of St Andrews. Refusing to submit, he was committed to prison for contumacy, and then banished the kingdom. He retired to Holland, and in 1623 published there his celebrated controversial work, entitled *Altare Damascenum*. &c. in which he rigorously examined the origin and authority of Episcopacy. In 1622, a pretended recantation of his protest was published at London by a venal writer, Patrick Scott. While on the continent. C. was known by the quaint appellation of Edwardus Didoclavius, being an anagram on his name Latinised. After King James's death in 1625, he returned to Scotland, and for some years was engaged collecting all the memorials relating to the ecclesiastical affairs of Scotland, from the beginning of the Reformation there to the death of James VI. In 1638, he became minister of Pencaitland, near Edinburgh; and in 1643 was appointed one of the

committee for drawing up the *Directory for Public Worship in Scotland*. He died at Jedburgh in 1651. From the original MS. of his *History of the Kirk of Scotland*, preserved in the British Museum, an edition was printed for the Wodrow Society, in 8 vols., 8vo (Edin. 1842—1845), edited by the Rev. Thomas Thomson.

CALDIERO (ancient *Caldarium*), a decayed town of North Italy, about nine miles east of Verona. Its thermal springs were in repute as early as the 1st c. of the Christian era, and continued to enjoy popularity until the commencement of the 16th c., after which they gradually became neglected, and are now little visited. The Austrians repulsed the French here in 1796.

CALEDONIA, a kind of poetical name applied to Scotland; being a resumption of that given by the Romans to the country north of the Wall of Antoninus, which ran between the Firths of Forth and Clyde. Among the chief tribes of this region were the Caledonii, whence the whole country has been called Caledonia. Tacitus speaks of the Caledonians as having red hair, large limbs; being naked and barefooted; living in tents without cities; supporting themselves by pasturing cattle, by the chase, and by certain ferries; addicted to predatory warfare; and fighting in chariots with shields, short spears, and daggers. They are supposed to have been of Gaelic or Celtic origin, and to have painted their bodies, whence the name Picti or Picts, by which, according to many writers, they were afterwards known. Agricola was the first Roman general to come in contact with the Caledonians. In 84 A.D. he defeated them, now united to repel a common enemy, under their chief Galgacus, at the Mons Grampius, the site of which has not been satisfactorily determined. The Romans overran the north-east of Scotland as far as the Moray Firth, and formed many encampments (of which remains still exist), but they never reduced the country to a Roman province. Roman coins and military relics have been found in connection with these camps. The name of Caledonii disappears about the beginning of the 4th c., when the inhabitants of Scotland begin to be spoken of as Scots (q. v.) and Picts (q. v.).

CALEDONIA, NEW. See NEW CALEDONIA.

CALEDONIAN CANAL, a chain of natural lakes united by artificial canals, running across the north of Scotland in a straight line from north-east to south-west, from the North Sea to the Atlantic, through Glenmore, or the Great Glen of Albiu, in Inverness-shire, and touching Argyleshire at the south end. The sea and freshwater lochs in this line are Beauly, Ness, Oich, Lochy, Eil, and Linnhe. The canal was formed to avoid the dangerous and tedious navigation of ships, especially coasting vessels, round by the Pentland Firth, Cape Wrath, and the Hebrides; the distance between Kinnaird's Head and the Sound of Mull by this route being 500 miles, but by the canal only 250, with an average saving of 9½ days for sailing vessels. The C. C. begins in the Beauly Firth, near Inverness, whence a cut of 7 miles joins Loch Ness, which is 24 by 1½ mile. A cut of 6 miles joins Loch Ness and Loch Oich, which is 3½ by ¼ mile. Another cut of 2 miles joins Loch Oich and Loch Lochy, which is 10 by 1 mile; and a fourth cut of 8 miles joins Loch Eil at the village of Corpach, 2 miles north of Fort William. This ship-communication is 60½ miles long, 37½ miles being through natural lochs or lakes, and 23 miles by artificial cuts. Each cut is 120 feet broad at surface, and 50 at bottom, and 17 deep. The highest part is Loch Oich, which is 94 feet above

the sea. There are in all 28 locks, each 170 to 180 feet long and 40 wide, with a rise or lift of water of 8 feet. Eight of the locks, called Neptune's Staircase, occur in succession near the west end of the canal. Some large mountain streams between Lochs Eil and Lochy are conducted in huge culverts under the canal; and by a new cut, the Lochy water is turned into the Spean. The practicability of this great work was first shewn by a survey under government in 1773 by the celebrated James Watt; but it was not till 1803 that it was begun under Mr Telford. The whole line was opened for ships in 1823. After three years of repair, it was re-opened in 1847. Ships of 500 to 600 tons, fully laden, can pass through the canal. The canal and tonnage rates for sailing vessels are each a farthing per mile per ton, and a half of this for vessels under 125 tons. Steamers pay 2s. a ton. Of £1,368,203 expended on this canal, from 1803 to 1856, £1,242,387 were voted by parliament, and £90,748 were from canal dues. Heavy gales and rains in December 1848 and January 1849 did much damage to the canal, which was repaired by a government grant of £10,000. During the year ending 1st May 1859, 1432 vessels passed through the C. C.; and the income from tonnage-rates was £5080, and expenditure, £6951. There is a regular steam-communication along the canal between Glasgow and Inverness. There is romantic and wild mountain scenery on both sides of the canal, besides many other objects of interest to the tourist, such as Fort William, Ben Nevis, Inverlochy Castle, Tor Castle, the ancient seat of Cameron of Lochiel, Glen Spean, Glen Roy, with its Parallel Roads, Fort Augustus, the Fall of Foyers, and Inverness.

CALEMBOURG, or CALEMBOUR, the French name for a pun (q. v.).

CALENDAR (from CALENDIS, q. v.), the mode of adjusting the months and other divisions of the civil year to the natural or solar year. The necessity of some division and measurement of time must have been early felt. The phases or changes of the moon supplied a natural and very obvious mode of dividing and reckoning time, and hence the division into months (q. v.—see also WEEK) of 29 or 30 days was, perhaps, the earliest and most universal. But it would soon be observed that, for many purposes, the changes of the seasons were more serviceable as marks of division; and thus arose the division into years (q. v.), determined by the motions of the sun. It was soon, however, discovered that the year, or larger division, did not contain an exact number of the smaller divisions or months, and that an accommodation was necessary; and various not very dissimilar expedients were employed for correcting the error that arose. The ancient Egyptians had a year determined by the changes of the seasons, without reference to the changes of the moon, and containing 365 days, divided into twelve months of 30 days each, with five supplementary days at the end of the year. The Jewish year consisted, in the earliest periods, as it still does, of twelve lunar months, a thirteenth being from time to time introduced, to accommodate it to the sun and seasons; this was also the case with the ancient Syrians, Macedonians, &c. The Jewish months have alternately 29 and 30 days; and in a cycle of 19 years there are seven years having the intercalary month, some of these years having also one, and some two days more than others have, so that the length of the year varies from 353 to 385 days.—The Greeks, in the most ancient periods, reckoned according to real lunar months, twelve making a year; and about 594 B.C., Solon introduced in

Athens the mode of reckoning alternately 30 and 29 days to the month, accommodating this civil year of 354 days to the solar year, by occasional introduction of an intercalary month. A change was afterwards made, by which three times in eight years a month of 30 days was intercalated, making the average length of the year $365\frac{1}{4}$ days. See METONIC CYCLE.

The Romans are said to have had originally a year of 10 months; but in the times of their kings, they adopted a lunar year of 355 days, divided into 12 months, with an occasional intercalary month. Through the ignorance of the priests, who had the charge of this matter, the utmost confusion gradually arose, which Julius Cæsar remedied, 46 B.C., by the introduction of the JULIAN CALENDAR, according to which the year has ordinarily 365 days, and every fourth year is a leap-year of 366 days—the length of the year being thus assumed as $365\frac{1}{4}$ days, while it is in reality 365 days, 5 hours, 48 minutes, and 50 seconds; or 11 minutes, 10 seconds less. Cæsar gave to the months the number of days which they still have.

So comparatively perfect was the Julian style of reckoning time, that it prevailed generally among Christian nations, and remained undisturbed till the renewed accumulation of the remaining error of eleven minutes or so had amounted, in 1582 years after the birth of Christ, to ten complete days; the vernal equinox falling on the 11th instead of the 21st of March, as it did at the time of the Council of Nice, 325 years after the birth of Christ. This shifting of days had caused great disturbances, by unfixing the times of the celebration of Easter, and hence of all the other movable feasts. And accordingly, Pope Gregory XIII., after deep study and calculation, ordained that ten days should be deducted from the year 1582, by calling what, according to the old calendar, would have been reckoned the 5th of October, the 15th of October 1582; and in order that the displacement might not recur, it was further ordained that every hundredth year (1800, 1900, 2100, &c.) should not be counted a leap-year, excepting every fourth hundredth, beginning with 2000. In this way the difference between the civil and the natural year will not amount to a day in 5000 years. In Spain, Portugal, and part of Italy, the pope was exactly obeyed. In France, the change took place in the same year, by calling the 10th the 20th of December. In the Low Countries, the change was from the 15th December to the 25th; but it was resisted by the Protestant part of the community till the year 1700. The Catholic nations, in general, adopted the *style* ordained by their sovereign pontiff; but the Protestants were then too much inflamed against Catholicism in all its relations, to receive even a purely scientific improvement from such hands. The Lutherans of Germany, Switzerland, and, as already mentioned, of the Low Countries, at length gave way in 1700, when it had become necessary to omit *eleven* instead of ten days. A bill to this effect had been brought before the parliament of England in 1585, but does not appear to have gone beyond a second reading in the House of Lords. It was not till 1751, and after great inconvenience had been experienced for nearly two centuries, from the difference of the reckoning, that an act was passed (24 Geo. II., 1751) for equalising the style in Great Britain and Ireland with that used in other countries of Europe. It was then enacted that eleven days should be omitted after the 2d of September 1752, so that the ensuing day should be the 14th. A similar change was about the same time made in Sweden and Tuscany; and Russia is now the only country which adheres to the *old style*; an adherence which renders it

necessary, when a letter is thence addressed to a person in another country, that the date should be given thus:—April $\frac{1}{13}$ or $\frac{June\ 27}{July\ 9}$; for it will be observed, the year 1800, not being considered by us as a leap-year, has, interjected another (or twelfth) day between old and new style.

The C. of the French Republic remains to be noticed, which was adopted in consequence of a decree of the National Convention in 1793. The midnight preceding the autumnal equinox of 1792 was fixed upon as the new epoch, from which the years were to be reckoned as the Year One, the Year Two, &c. The year was divided into 12 months, each of 30 days, to which new names were given, as *Vendémiaire* (vintage month), *Brumaire* (foggy month), &c.; and instead of weeks, each month was divided into periods of 10 days, called *Primidi*, *Duodi*, *Tridi*, &c. Five *complementary* days were added at the end of each year, which were the *Fête du Génie*, *Fête du Travail*, &c. By Napoleon's command, this new system was abolished, and the use of the Gregorian C. resumed on January 1, 1806.

CALENDAR OF PRISONERS, in the practice of the criminal law in England, is the technical name given to the list of all prisoners' names in the custody of the sheriff of each county, prepared for the assizes. When the business is over, and the trials concluded, the clerk of assize makes out in writing four lists of all the prisoners, with separate columns, containing their crimes, verdicts, and sentences, leaving a blank column, in which, if the judge has reason to vary the course of the law, he writes opposite the names of the capital convicts—to be *reprieved*, *respited*, *transported*, &c. These four calendars, being first carefully compared together by the judge and the clerk of assize, are signed by them, and one is given to the sheriff, one to the jailer, and the judge and the clerk of assize respectively keep another. If the sheriff receives afterwards no special order from the judge, he executes the judgment of the law in the usual manner, agreeably to the directions of his calendar. In every county, this important subject is settled with great deliberation by the judge and the clerk of assize, before the judge leaves the assize-town; but probably in different counties, with some slight variation, as in Lancashire, no calendar is left with the jailer, but one is sent to the home secretary.

CALENDERING is the term applied to the process of finishing by pressure the surface of linen or cotton goods. It is usually done by passing the fabric between cylinders pressed together with great force; hence the origin of the term, which is a corruption of *cylindering*.

The familiar domestic processes of starching and ironing afford the simplest illustrations of the object and result of calendering. The domestic mangle effects the same object as the flat iron, and is a near approach in construction to the C. engines of the manufacturer, no traversing-box of stones being used in the new patent mangles. See MANGLE.

The cylindrical C. machine is said to have been introduced into this country by the Huguenots, driven here by persecution. The cylinders were originally of wood, but the liability to warping is a strong objection to these. Hollow iron and copper cylinders are used where heat as well as pressure is required, the cylinders being heated by steam passed through the inside, or by red-hot rollers or heaters. Iron against iron does not, however, produce the desired effect; it is necessary that one of the cylinders, at least, shall be of a material combining considerable hardness with a slight degree of elasticity; for this purpose, paper cylinders are used. They are made by cutting a number of circular disks of

thick pasteboard, each with a square hole in the centre; these disks are threaded side by side on an iron axis, and, thus united, form a cylinder. Circular cast-iron plates, rather smaller than the card disks, are placed at each end of the axis, and the whole is compressed with enormous force, until the paper cylinder becomes so excessively hard that, in the subsequent process of turning in the lathe, which it has to undergo to make it perfectly true and smooth, the tools are so rapidly blunted that two men are constantly employed in sharpening them. These paper cylinders usually work against a heated iron or copper roller.

Before the final rolling in the C. machine, the fabric is first lightly smoothed by passing over warm cylinders. Cotton goods are starched with a starch prepared from flour, and the starch is sometimes thickened with plaster of Paris, porcelain clay, or a mixture of these, to give a fictitious appearance of stoutness, which of course vanishes when the article is washed. For ordinary C., the fabric is then simply passed between plain cylinders, which produces the desired effect by flattening the otherwise round threads. When, by means of a hot cylinder, with a pattern raised upon it, the amount of this flattening is unequal on different parts of the cloth, the beautiful effect known as 'watering' is the result. *Glazing* is produced by combined rubbing and pressure; the rollers being made to move with different velocities, so that one side of the fabric is rubbed as well as pressed by the roller whose surface moves with the greater rapidity. A copper roller is preferred for glazing, and is made so hot that if the machine stops it burns the goods. For glazing on a small scale, and for made-up articles with seams, a polished flint, attached to a lever, and pressed down by a spring, is rubbed over the surface of the fabric, which is laid upon a smooth wooden table or horse. This is the old method of glazing, generally used before the invention of the rubbing cylinders.

CALENDS. The Romans made a threefold division of the month into *Calends*, *Nones*, and *Ides*. The C. always fell upon the 1st of the month; the Nones in March, May, July, and October, on the 7th; and the Ides on the 15th; and in the remaining months, the Nones on the 5th, and the Ides on the 13th. The C. were so named because it was an old custom of the College of Priests on the first of the month to *call* (or assemble) the people together to inform them of the festivals and sacred days to be observed during the month; the Nones received their name from being the *ninth* day before the Ides, reckoning inclusively; and the Ides from an obsolete verb, signifying to divide, because they nearly halved the month. This threefold division also determined the reckoning of the days, which were not distinguished by the ordinal numbers first, second, third, &c., but as follows: Those between the C. and the Nones were termed *the days before the Nones*; those between the Nones and the Ides, *the days before the Ides*; and the remainder, *the days before the C.* of the next month. Thus, the Ides of January, happening on the 13th of that month, the next day would not be termed by a Latin writer the 14th, but the 19th before the C. of February, reckoning inclusively, i. e., reckoning both the 14th of January and the 1st of February, and so on to the last, which was termed *pridie Calendas*.

Ad Calendas Græcas, a Roman proverbial saying, practically equivalent to 'never.' The Roman C. were often appointed as days for payment of rent, interest, &c.; but as the Greeks had no C., a postponement of payment *ad Calendas Græcas*, simply meant a refusal to pay altogether. It is said that the Emperor Augustus frequently used the phrase, which afterwards became a proverb.

CA'LENTURE, a Spanish term (*caletura*) applied to a species of temporary delirium or fever occurring on board ship in hot climates, and probably due to the effect of exposure to the direct rays of the sun. The descriptions of the disease seem rather fanciful and contradictory, and the term is nearly obsolete. See *Dictionnaire des Sciences Médicales*.

CALHOUN, JOHN CALDWELL, an eminent American statesman, descended from an Irish family who founded the Calhouns' Settlement in South Carolina, was born at Abbeville, South Carolina, March 18, 1782. Having gained distinction at the bar, he was sent to congress in 1811, where he soon made himself the leader of the war-party against England. Author of the tariff of 1816, so favourable to his native state, he in 1817 was named minister of war by President Monroe, and reduced the confused state of affairs in his department to order, and made a great reduction in the expenditure of the army without sacrificing its efficiency.

This early part of C.'s career was marked by broad and patriotic views, to which his subsequent preference of southern interests presented an unfavourable contrast. The tariff of 1828 not being very favourable to the Southern States, C. still adhered to the government, hoping that the president, Jackson, would veto the measure; but as this hope was disappointed, C. went to South Carolina, and there (1829) carried in the legislature the notorious resolution, 'that any state in the Union might annul an act of the Federal government.' To this decision, Virginia, Georgia, and Alabama gave in their adhesion, and threatened a dissolution of the Union. President Jackson promptly used energetic measures to make this resolution of no effect. C. lost popularity, and despairing of reaching the presidency, resigned his vice-presidency; but soon afterwards was elected into the senate. In 1838, he delivered his famous speech on slavery, and continued to agitate on behalf of the slave-holding interest and for a dissolution of the Union, both with voice and pen, until his death, which took place at Washington, March 31, 1850. In his private character, C. was blameless; but, as a statesman, he cast a firebrand into the States, which is not yet extinguished, nor does it seem likely to be, until slavery is abolished, or the union of North and South dissolved. During many years, he had been employed in writing his work on *The Philosophy of Government*, in which he vindicates the doctrine of state sovereignty, and which, along with other works, was posthumously published.

CALIA'NO, a small town of the Austrian Tyrol, situated on the left bank of the Adige, about 9 miles south of Trent. It figures in history as the place where the Austrian archduke, Sigismund, won a signal victory over the Venetians in 1487. Being a place of considerable military importance, it was also contested in the campaigns of 1797 and 1809.

CA'LIBRE, or **CA'LIBER**, is a technical name for the diameter of the bore of a firearm, whether a piece of ordnance or a small-arm. The ordnance from which solid shot are projected are usually denoted by the weight of each shot, as 24-pounder, 68-pounder, &c.; but mortars, and such guns as project shell or hollow shot, are more usually denoted by the C., such as 13-inch mortar, 10-inch shell-gun, &c. The C. of the chief kinds of firearm will be noticed under the proper headings; but it may here be observed, generally, that the C. of English ordnance has been greatly increased within the last thirty years, partly by boring up old guns, and partly by casting new.

CALICO-PRINTING is that department of the art of dyeing which takes cognizance of the production of a coloured pattern on cloth. It appears to have been first practised at *Calicut* in India—hence the term *calico*; and the *pallampoons*, or large cotton chintz counterpanes, which have been manufactured in the East Indies for centuries, are evidence of the successful practice of the art in that country. From the East Indies, the art spread to Asia Minor and the Levant, thence to Augsburg in Bavaria; from whence, at the beginning of the 18th c., it spread to Alsace in France, to Switzerland, and ultimately to England and Scotland. The term is strictly applicable to the production of coloured patterns on cotton cloth or calico; but as now employed, it includes all the processes followed in the formation of a coloured pattern on cotton, linen, worsted, and silk goods, as also mixtures of two or more of these, such as the fabric called *de laine*, which is composed of cotton and worsted.

The first operation connected with the printing of cloth is the removal of the surface-hairs or minute threads which communicate a fibrous down or nap to the surface of the cloth, and if allowed to remain, would interfere with the uniform application of the colours. The surface down is got rid of by the process of singeing, during which the cloth is drawn over a red-hot iron or copper bar or plate, or through a series of gas jets. The apparatus generally used for *hot-plate singeing* consists of a furnace surmounted by a metal plate, which is sometimes ridged on the surface. The cloth having previously been joined at the ends, to make a long length, and been placed on a winch-roller, is first brought in contact with roller brushes, which raise the nap on the cloth, then passes over the white-hot metal cylindrical bar, and is wound on to a second winch-roller. The process is repeated twice on the face of the cloth, being the surface to be printed on, and once on the back. *Gas-singeing* is accomplished by drawing the cloth through brushes, and then over a horizontal pipe, perforated with rows of small holes, or slit from end to end, so that the gas issuing therefrom burns as a narrow sheet of flame. The cloth is not only allowed to come in contact with the burning gas, but the flame is transmitted through the cloth, and a suction-apparatus is often placed immediately above, so as to draw the flame through more effectually. When well singed, the cloth undergoes the process of bleaching (q. v.), and is thereafter calendered. See **CALENDERING**.

There are several modes of applying the colours to cloth, and these are respectively named—1. The Madder style; 2. The Padding style; 3. Topical style; 4. Resist or Reserve style; 5. Discharge style; and 6. China blue or pottery style. These various processes are at one in being intended to fix upon the cloth the different colours; but they differ from each other more or less in the several steps through which the cloth is passed, though occasionally there is little or no line of separation; and at times, the cloth is treated by one method, and subsequently by another style.

The *madder style* is that in which a certain fixing agent or mordant is printed on the cloth, which is then introduced into the colouring matter in a dye-vat, when the mordant, having an attraction alike for the fibre of the cloth and for the colouring matter, acts the part of glue or paste, and cements the colour to the cloth. Originally, madder was the only colouring substance employed in this style; but now-a-days, by far the greater number of dye-stuffs, vegetable and animal, including cochineal, logwood, &c., are attached to cloth in this manner. The fixing agents or mordants generally

employed are different strengths of *red liquor* (acetate of alumina), *iron liquor* (acetate of iron), and mixtures of these. These are thickened with wheat-starch, potato-flour, roasted starch or dextrine, and gum-arabic, so that the mordant may not run when it is placed on the cloth by the pattern-block or by the printing-machine. After the mordant has been imprinted on the cloth, the latter is hung in a warm airy room, where it can easily dry, but where it is at the same time surrounded by a moist atmosphere. The result is, that the mordant is decomposed, the acetic acid is evolved, and the alumina or iron is left attached to the fibre of the cloth in the state of an insoluble sub-salt, which cannot be dissolved by water. As some of the mordant is still left in its original soluble condition, it is necessary to wash the cloth free from this, else, during the dyeing operation, the soluble part of the mordant would run on to those parts of the cloth not intended to be coloured, and thus produce a blotted appearance. To obviate this, the cloth, having undergone the process of *drying and ageing*, is then introduced into a vat containing water, through which is diffused some cow-dung, dung substitute—a preparation of bone ash, sulphuric acid, carbonate of soda, and glue—or bran. The result of this process of *dunging* is the removal of the soluble part of the mordant, as also the starch or thickening agent, leaving the decomposed or insoluble mordant adhering to the fibre. The terms *dung-fixing*, *substitute-fixing*, and *bran-fixing*, have reference to the employment of one or other of these agents at this stage of the operation. When the cloth has been well washed from the dunging, it is introduced into the vat or dye beck containing the colouring matter. The whole is heated by steam-pipes, and the cloth being placed on a sparred reel kept in motion, is repeatedly wound out of the vat, and returned thereto. The result is, that wherever the mordant adhered to the cloth, the colouring matter is attached thereto, and little or no trace of colour adheres to the unmordanted parts. The last operation is the *clearing* or *brightening*, during which the coloured cloth is introduced into warm baths of water containing soda, soap, or, for the more delicate tints, bran, and is thereafter acted on by weak acid solutions. The object is to clear the colours, and at the same time to confer upon them the property of resisting the fading action of the air and sun for a much longer time. The different shades of colour which can be obtained from the same madder beck or vat, with different mordants, are very numerous, and include reds, lilacs, purples, chocolates, and blacks. Thus, when a weak solution of red liquor (acetate of alumina) is employed as the mordant, a light red tint is procured; with a stronger aluminous mordant, a deep red is formed on the cloth; with a more or less dilute solution of iron liquor (acetate of iron), the cloth is coloured lilac, violet, or purple; with a strong solution of iron liquor, black is obtained. Indeed, the same piece of cloth stamped in different places with the various strengths of aluminous and iron mordants, and mixtures of these, and immersed in the madder-bath, will be obtained dyed with all the shades mentioned; and in this manner, many of the beautiful variegated coloured dresses and handkerchiefs are prepared for market.

The *padding style* in C. is intended mainly for the impregnation of cloth, in whole or in part, with mineral colouring substances. When the cloth is to be entirely coloured, it is immersed wholly in a vat containing the mordant. When the colour is to appear as a pattern on the fabric, the mordant is applied by a pattern block, or by the printing-machine. In either case, the cloth is thereafter

thoroughly dried, and washed in various solutions, and then introduced into a vat containing the substance to form the colour. Thus, if a piece of cloth is to be entirely impregnated with *chrome yellow*, it is first treated or *padding* in a solution of 8 parts of bichromate of potash ($\text{K}_2\text{O}, 2\text{Cr}_2\text{O}_3$) to a gallon of water dried, and then placed in a vat containing a solution of 6 or 8 ounces of acetate or nitrate of lead (PbO_2 , or PbONO_2) to the gallon of water. The result is that the chromate of lead (PbOCrO_4) is formed in the tissue of the cloth; and when the latter is washed and dried, the yellow colour still adheres to the cloth firm and fast. To print a yellow pattern on cloth, 7 to 9 ounces of acetate of lead, and the same quantity of nitrate of lead, are dissolved in a gallon of water, thickened with starch, and placed upon the cloth according to pattern. After drying, the cloth is first immersed in water containing a little carbonate of soda, and ultimately in a solution of bichromate of potash, when the pattern becomes fixed in bright yellow, insoluble in water. To produce *Prussian blue* on cloth, it is treated with acetate and sulphate of iron, dried, washed with warm chalk-water, and immersed in a very weak solution of yellow prussiate of potash. A pattern in Prussian blue is produced by printing a pattern in the cloth with the iron solutions thickened with gum, and thereafter proceeding as above. Chrome green is produced in a similar way, by using sulphate and acetate of copper, thickened with glue, and thereafter arsenious acid with potash; and so also other colours, such as iron buff or chamois, manganese bronze, &c.

The *topical style* in C. is the process whereby certain colouring matters which are insoluble in water, and cannot therefore be applied to cloth by the modes suggested under the madder and padding styles, are treated at once with the mordant, and the mixture by one operation transferred by block, or otherwise, directly on the surface or top of the cloth, and hence the term *topical*. Indigo, safflower, and annatto are instances of such insoluble colouring substances; and when these and other dye-stuffs, such as logwood and Brazil wood, are treated with water, thickened with starch and nitro-muriate of tin (known as *spirite*) added, with occasionally a little of other salts, such as nitrate of copper, the result is the formation of *spirit-colours*, which can be printed on the surface of cloth, and possess a certain degree of fixity. The permanency of these *spirit-colours*, however, is very much increased, and the general appearance improved, by afterwards subjecting the goods to the action of steam in a wooden chest or box, when the term *steam-colours* is applied.

The *resist style* in C. is that in which certain materials are placed on the surface of cloth, to protect it from the adherence of the mordants, and, consequently, to keep that part of the cloth from being attacked by the colouring matter. These materials are termed *resists*, *reserves*, or *resist-pastes*, and they are divisible into mechanical and chemical. The *mechanical resists* are such substances as fats, resins, oils, wax, and pipe-clay. A common resist for silk and woollen goods is a mixture of $2\frac{1}{2}$ of resin and 1 of suet; and it is principally in the colour-printing of silk and woollen dresses and handkerchiefs that mechanical resists are employed, though they are occasionally used for the printing of cottons. The chemical resists may act on the mordant or on the colour. Thus, if it be desirable to remove the mordant, and thus leave certain parts of the cloth unable to attach colour, the printing of a pattern with some acid substance on the cloth will form with the mordant a soluble salt, which can be readily removed by

washing, whilst the parts which have not been so acted on by acid are not dissolved away by the washing, and still retain the full power in the colours to cause the adhesion of the colour. For this purpose, where an iron or aluminous mordant has been employed, it is customary to print thereon in the requisite pattern, lemon-juice or lime-juice (containing citric acid), tartaric or oxalic acid, and bisulphate of potassa, or a mixture of two or more of these, thickened with pipe-clay, China-clay, gum-arabic, dextrine (British gum), gum-Senegal, or a mixture of these; occasionally, chloride of tin is employed. Sulphate of zinc, sulphate and acetate of copper, and the chloride of mercury, are used to resist the adherence of indigo blue.

The *discharge style* in C. comprehends the employment of similar materials to those used in the resist style, but *after* the cloth has been coloured or dyed, and for the purpose of discharging the colour, or bleaching the cloth at certain parts, according to pattern. The dischargers for organic colouring matters are chlorine and chromic acid. The chlorine is employed in the form of bleaching-powder (q. v.), and the cloth already dyed is printed with a solution of tartaric acid (or other acid), thickened with pipe-clay and gum, then dried, and passed through a solution of bleaching-powder, when the decoloration occurs, as already explained under BLEACHING. The chlorine is also applied by placing a number of folds of coloured cloth between perforated pattern-plates, and subjecting the whole to great pressure; a solution of chlorine (obtained by adding an acid to a weak solution of bleaching-powder) is allowed to percolate down through the perforations of the plates, and the cloth immediately underneath, so that only those spots are bleached, while the rest of the cloth is so highly compressed as to keep the liquid from coming in contact therewith. The well-known Turkey-red handkerchiefs are *patterned* in this way. The chromic acid is generally employed in discharging indigo colour. The cloth, already entirely blue, is soaked or padded in bichromate of potash, and then an acid discharger printed thereon; and wherever the acid discharger (tartaric, oxalic, citric, or hydrochloric acid) comes in contact with the blue cloth containing the bichromate of potash, chromic acid is liberated, and destroys the colour. Instead of acting upon the coloured cloth, the discharger may be employed to carry off the mordant. Thus, cloth treated wholly with a mordant, and thereafter printed with a pattern in acid, has the mordant removed at those parts where the pattern block has placed the acid. Mineral colours can also be discharged in a similar way.

The *China blue* or *pottery style* in C. is a modification of the topical style, where indigo is deposited on cloth in the insoluble state, and is thereafter manipulated with, so as to impregnate the cloth with the indigo more or less strongly, and thus produce different shades of blue.

The above descriptions of the various operations in C. have special reference to cotton cloth; and though many steps of the manipulative processes apply equally well to linen, silk, worsted, and de laines (worsted and cotton), yet considerable modifications in mode of treatment and material employed are required in the successful colour-printing of all texture containing animal fibre, such as silk and wool. Where the printing of such fabrics differs essentially from the processes already indicated, special reference will be made under SILK and WOOL. The different colouring matters employed in C. being identical with those used in dyeing, will be considered under the general popular title DYE-STUFFS; and the mode of compounding these

into the various colours and shades, will be more appropriately introduced under DYEING.

CALICUT, a seaport of the district of Malabar, which, though on the west side of the peninsula of Hindustan, yet forms part of the presidency of Madras. In lat. 11° 15' N., and long. 75° 50' E., it is distant from Goa and Bombay respectively 300 and 566 miles. It was the first spot in India visited by Vasco de Gama, being then the chief emporium on the coast, with stately dwellings and magnificent pagodas. So populous and powerful was it, that it twice repulsed the Portuguese, slaying their commander in 1509, and expelling Albuquerque himself, after a momentary success on his part, in 1510. It stands near the mouth of a small river of the same name, appearing to have possessed at one time a tolerably good haven. Gradually, however, this harbour has been filled up with sand; and now its anchorage is merely an open roadstead, at a distance, at least for large vessels, of two or three miles from land. Independently of this physical disadvantage, the ravages of war and the competition of superior localities contributed to the decay of Calicut. Accordingly, in 1792, when it fell into the hands of the English, the city was little better than a ruin. Since then, it has made considerable progress, and has been estimated to contain about 20,000 inhabitants. From C., *calico* is understood to have derived its name, just as *cambric* from Cambrai, in the north-east of France.

CALIF (Turk., a successor), the title of Mohammed's successors in temporal and spiritual power, from which the historians of the middle ages designated the Arab empire founded by these princes, the CALIFATE. This empire, for two or three centuries, exceeded even the Roman empire in extent. As Mohammed died without leaving any sons, a contest arose concerning the inheritance of his power, which terminated (632 A. D.) in the triumph of Abubekr (q. v.), one of his fathers-in-law, over Ali, his nephew and son-in-law. Abubekr now assumed the title of Califet-Resul-Allah—i. e., Representative or Deputy of the Prophet of God. He sent forth his armies for the extension of Mohammedanism, and after several victories over the forces of the Byzantine empire, conquered Syria. He was succeeded in 634 by Omar, another father-in-law of Mohammed, by whom Egypt and Jerusalem were annexed to the califate. He assumed the title of Emir-al-Mumenin—i. e., Prince of the Faithful—a title which all subsequent califs retained. Othman, a son-in-law of the Prophet, was the third C., and was elected by six persons appointed by Omar before his death. During his reign (644—656 A. D.), the Arabian empire grew with extraordinary rapidity, being extended into Persia, and westward along the north coast of Africa as far as Ceuta. The Byzantine emperors recovered Egypt; but it was wrested from them again at a prodigious expense of blood. The people of Medina elected Ali-ben-Abi-Taleb as C. upon the death of Othman. The Shiites regard him as the first true Imam or high-priest, and honour him and his son Hassan almost equally with Mohammed himself. Contests against rivals prevented him from doing much for the extension of the califate. Moawijah, the governor of Damascus, having made himself really independent during Ali's life, and having extended his power over Syria, Egypt, and part of Arabia, became C. in 661, and founded the dynasty of the Ommiades, making the califate hereditary. He removed the seat of the califate to Damascus. His armies ravaged Asia Minor, and laid siege to Constantinople, but could not take it. He made important conquests, however, in Central Asia. The califate did not remain long in the

family of Moawijah, and it frequently happened that in one or other of the subject countries a governor raised himself to a temporary independence; and rival califs frequently contended for power. Abdalmelek (685—705 A. D.) united all the Moslems under his dominion. Under his son, Walid I., the califate reached its zenith of prosperity, the Arabs conquering Turkestan in 707, Galatia in 710, and Spain in 711. Under Hesham, the progress of the Arabs in the west was arrested by Charles Martel at Tours (732 A. D.) and at Narbonne (736 A. D.). The dynasty of the Omniades in Asia terminated with Merwan II. in 752, giving place to that of the Abbasides. But a branch of the Omniades founded an independent califate at Cordova, and another founded one in Arabia, which subsisted till the 16th century. Abul-Abbas (750—754 A. D.), the first Abbaside C., signalled himself by his cruelty and the torrents of human blood which he shed. His successor, Abu-Jafar, called Al-Mansur, a patron of the arts, but a persecutor of Christians, founded Bagdad (q. v.), and removed the seat of the califate thither. From the beginning of the 9th c., the Arab empire, which had suffered much from corruption and internal disorganisation under the last califs of the Omniade dynasty, and had never completely recovered, shewed increasing signs of decay. Even under the C. Harun-al-Raschid, whose praises the eastern poets were accustomed so much to celebrate, independent kingdoms were established (800 A. D.) by the Aglabides in Tunis, and the Edrisides in Fez. In 821, Taher, the governor of Khorassan, made himself independent, and established a dynasty there, and other governors of provinces followed his example. But under the C. Al-Mamun, the Arabians conquered Sicily and Sardinia, the former of which they held till it was taken from them in 1035 by the Normans; and the latter, till it was conquered by the Pisans in 1051. The C. Motassem (833—842 A. D.) was the first to employ Turkish soldiers; but the practice was followed by his successors; and the Turkish body-guard soon became a formidable power in the califate, and about the middle of the 9th c. assumed the right of deciding the succession to the throne. Many of the califs, meanwhile, were base voluptuaries, and of the others, some were of little capacity, and their power rapidly declined. Ere the middle of the 10th c., the califs themselves exercised a mere nominal sovereignty, whilst the emirs, like the mayors of the palace towards the close of the Merovingian dynasty among the Franks, possessed all real power. The princes of the Fatimide dynasty, which succeeded that of the Aglabides in Tunis, having made themselves masters of Egypt in 970, assumed the title of C., so that there were now three califates—at Bagdad, at Cairo, and at Cordova. In the 11th c., the califs of Bagdad were still acknowledged as the spiritual chiefs of all the Moslems; but their temporal power scarcely extended beyond the walls of Bagdad. Bagdad itself became the prey of a Mongol horde in 1258, and the representative of the califs fled to Egypt, where, under the protection of the Mamelukes, who had made themselves masters of that country in 1250, he retained his title and spiritual power, which he transmitted to his successors, who continued to reside there till the Turks conquered Egypt in 1517, when the last of them was carried to Constantinople; and since that time the Turkish sultans have assumed the title of C., and claimed to be regarded as the spiritual chiefs of all the Moslems, a claim to which little respect has ever been paid except within the limits of their own empire.

CALIFORNIA. This name was at first applied to a peninsula on the west side of Mexico, but was

gradually extended to an indefinite portion of the adjoining continent, as far north as the parallel of 42°. The original C., however, and its augmentation were distinguished from each other as Old and New, Lower and Upper. In 1848, partly by conquest and partly by purchase, continental C., down to the parallel of 32° 28', was ceded to the United States. After existing as a territory for two years, it was, in 1850, subdivided—the portion to the west of the Sierra Nevada and the Colorado becoming the state of C., and a portion to the east, the Utah of the Mormons. Between the two Californias of the present day, the American one and the Mexican one, there is nothing in common but the name.—1. *Mexican C.* is the peninsula above mentioned, which, though considerably longer than Great Britain, is yet so narrow as to be very little larger than Scotland. From end to end, it is one ridge of mountains, which here and there rise to about 5000 feet above the sea. A few favoured spots yield fruits and grains in abundance; but, generally speaking, the productions are unimportant, for even trees, and those of no great size, are found only towards the southern extremity of the country. The population certainly does not exceed 10,000—the oldest and most considerable town, Loretto, on the east side, containing barely 1000 inhabitants. On the west side is the magnificent harbour, peculiarly valuable on a coast so destitute of shelter, formed by the Bay of Magdalena and the island of Santa Margarita.—2. *American C.*, vaguely claimed, under the name of New Albion, by Drake for England in 1579, lay unoccupied till 1767, when it was invaded by Franciscan friars, the successors in Mexico of the newly expelled Jesuits. These zealous apostles, backed, when necessary, by armed coadjutors, planted various missions, bringing under their influence, such as it was, the great mass of the aborigines. Under such circumstances, the new province became pre-eminent, even in Spanish America, for everything that could paralyse the progress of a community. Anglo-Saxon speculators engrossed most of the trade; American trappers walked through the land as if it had been their own; the Muscovites established, in the north, a town under the ominous title of *Ross or Russia*; and a Swiss adventurer of the name of Sutter, who had carved out for himself a *New Helvetia*, virtually set the government at defiance. But the discovery of gold in Sutter's mill-race during 1847, and the political transfer of 1848, taken together, changed, as if by a miracle, the aspect of affairs. The matchless harbour of San Francisco became the grand mart on the Pacific, presenting a centre of attraction to the restless and energetic of every race and every clime. Between 1850 and 1852, the population increased from 92,597 to 264,435; and in 1855 the population was 327,000. In 1852, gold was exported according to the official returns, to the amount of fully 45 millions of dollars, or more than 9 millions of pounds sterling. Nor did this materially exceed the average value, for, between April 1849 and December 1856, the entire quantity was 322 millions of dollars, being equivalent to at least 40½ millions a year. Platina, too, and copper are known to exist; and more recently, silver has been said to be found as plentifully as gold. In 1857, the revenue, wholly the fruits of direct taxation, yielded 1,152,234 dollars; 922,644 dollars, four-fifths of the whole, were paid by property, personal as well as real, at the rate of $\frac{1}{10}$ per cent. on the absolute valuation, or, at the lowest estimate, of 7 per cent. on the annual proceeds—being, in other words, an income-tax of 1s. 5d. in the pound. In the same year, the public debt stood at 12,163,090 dollars—the state owing 4,128,927; the counties, 2,365,260; and

the cities, 5,668,903. Notwithstanding the immediate incidence of the burden and the uncontrolled universality of the suffrage, the people, in September 1857, declared for payment, as against repudiation, by 57,661 votes to 16,970.

The country is mountainous, fitter, in general, for pasture than for cultivation. It is cut into coast and interior by a subordinate range from Oregon, which forks into the Sierra Nevada towards the south. The interior, again, is subdivided into the valleys of the Sacramento and the San Joaquin—two navigable rivers respectively from the north-east and the south-east, which enter, as one stream, the noble haven of San Francisco. Of those two valleys, the former is the more important, both as being the chief seat of the 'diggings,' and as leading through the Rocky Mountains by the comparatively level route of Fremont's Pass. Thus does the north section of C., with its rare combination of inland and maritime facilities, promise to contend successfully with the Isthmus of Darien and Central America as a route for connecting the Atlantic with the Pacific. C., with a lovely and salubrious climate, produces fruits and grains freely, under advantageous circumstances of soil and situation. In the growth of timber, however, it appears to be almost unrivalled. Fremont measured one tree that was 21 feet in diameter, or 66 in circumference; and, according to a recent statement, another has been seen, which, with a length of 150 yards, is nearly 120 feet in girth. Besides the capital, the state contains the cities of Sacramento, Marysville, and Stockton; and the towns of Placerville, San Jose, Vallejo, Sonora, Shasta, Sonoma, Monterey with a pretty well-sheltered anchorage, and San Diego with the best port in the state next to that of San Francisco.

CALIFORNIA, GULF OF, an arm of the Pacific Ocean, which divides the peninsula above described from the rest of Mexico. It was originally known as the Sea of Cortez, having been discovered under his auspices, and explored by himself; and it has, from its shape, been occasionally designated the Adriatic of the New World. It is 700 miles in length, and varies in width from 40 to 100 miles. At its northern extremity, it almost touches the territory of the United States, receiving therefrom the united streams of the Gila and the Colorado. The gulf contains many islands, particularly towards its head, and has long had a pearl-fishery. At the east side of its entrance stands Mazatlan, on a river of the same name, now the most frequented port of the neighbouring regions.

CALIGULA, CAIUS CÆSAR AUGUSTUS GERMANICUS, Roman emperor (37—41 A. D.), the youngest son of Germanicus (nephew of Tiberius) by Agrippina, was born, 31st August, 12 A. D., at Antium, and was educated in the camp, where the soldiers gave him the by-name C., from the half-boots (*caligæ*) which he wore. On the death of his brother Drusus, he was made augur in his stead; and on the death of Tiberius (37 A. D.), who, it was suspected, had received foul-play at his hands, it was found that he had been appointed co-heir along with the grandson of Tiberius, but the senate and the people allowed C. supreme and sole authority. In the beginning of his reign, he appeared hardly likely to fulfil the threat of Tiberius, who had talked of educating C. 'for the destruction of the Roman people.' He was, to appearance, lavishly generous and merciful, pardoning even those who had been the instruments of cruelty against his own family. But this ostentatious magnanimity was itself a disease, an unwholesome affectation, founded on no principle, or even humanity of heart, and co-existed with the most savage voluptuousness and

lust. Consequently, when illness, the result of his vicious life, had weakened his faculties, the lower qualities of his nature obtained the complete mastery. In addition to the senseless prodigality with which he commenced his career—expending in one year the enormous wealth left by Tiberius (720 millions of sesterces)—he began to manifest the most barbarous propensities. He banished or murdered his relatives, excepting his uncle Claudius and sister Drusilla (with whom he carried on incestuous intercourse); filled Rome with executions, confiscating the estates of his victims; amused himself, while dining, by having victims tortured and slain in his presence; and uttered the wish 'that all the Roman people had but one neck, so that he might decapitate Rome at a blow!' To vie with Xerxes, he made a bridge of ships over the bay between Baïæ and Puteoli (a distance of three Roman miles and six hundred paces), and celebrated the exploit by a costly banquet on the middle of the bridge, and by collecting on it great numbers of people, and causing them to be drowned. His favourite horse was stabled in a palace, fed at a marble manger with gilded oats, was made a member of the college of priests, and afterwards raised to the consulship. As a climax to all his absurdities, he declared himself a god, and had temples erected, and sacrifices offered to himself. To gratify his monstrous desires, he shrunk from no infamy; he robbed, plundered, and taxed his subjects to a degree which seems almost incredible, and when even these means proved insufficient, he established a brothel in his own palace, and sent out his slaves to solicit the public patronage for it. At length a conspiracy was formed against him, and he was assassinated 41 A. D.

CALIPPIC CYCLE. See PERIOD.

CALITRI, a town of Naples, in the province of Principato Ultra, near the Ofanto, and about 7 miles east-north-east of Conza. It has a population of 5219, who are chiefly engaged in agricultural pursuits. Sheep are reared to a considerable extent in the vicinity.

CALIVER was a matchlock or firearm about midway in size and character between an arquebus and a musket; it was small enough to be fired without a rest or support.

CALIXTINES, a Bohemian religious sect, so named from the Latin *calix*, a cup, because they contended for giving the cup, as well as the consecrated wafer, to the laity. Their confession of faith (1421) contained the following articles: 1. That the word of God ought to be freely and regularly preached by the priests of the Lord throughout Bohemia; 2. That the eucharist in both kinds ought to be administered to all burdened with 'no mortal sins,' according to the language and command of the Saviour; 3. That the clergy should separate themselves from secular affairs; 4. That all 'mortal sins,' and especially public ones, such as debauchery and simony, and any other disorders contrary to the law of God, should be prevented or punished by those who were the lawful authorities in such matters. In other main points they were moderate followers of John Huss, and were opposed to the more extreme sect of Taborites (q. v.). Their peculiar articles of faith were conceded by order of the council at Basel (1433); and having prevailed over the Taborites in the conflict which took place at Boehmischbrod 30th May 1434, they became the dominant party in Bohemia, and exercised considerable influence over political affairs. Gradually, however, the C. lapsed from the severity of their four articles, while the schism of the energetic Taborites, and later of the Bohemian Brethren (q. v.), rendered them completely

powerless. At the beginning of the 16th c., they had ceased to possess any importance, and only served to prepare the way for Protestantism.

CALIXTUS, GEORG (properly, *Callisen*), an eminent theologian of the Lutheran Church, was born 15th December 1586, at Melley, in Holstein; studied at Flensburg and Helmstedt; and, in 1605, became professor of philosophy in the latter of these cities. Two years after, he betook himself to theology, and attracted great attention by the breadth and originality of his views. After travelling for some time in Germany, Holland, England, and France, where he made the acquaintance of the most learned men of his time, he returned to Helmstedt in 1613, and was appointed professor of theology. His genius, the depth of his knowledge, and his large experience of the world and of men, which he had acquired in his travels, developed in him a spirit of great tolerance towards all who held their religious opinions honestly, whatever these might be. Although his dissertations on the Holy Scripture, transubstantiation, communion in one kind, &c., are acknowledged by learned Catholics to be about the most solid and admirable which have been composed by Protestants against the distinctive doctrines of Catholicism, he was, on account of some statements in his work, entitled *De Præcipuis Religionis Christianæ Capitibus* (Helmstedt, 1613), which seemed favourable to Catholic dogmas, and of others in his *Epitome Theologiæ Moralæ* (Helmstedt, 1634), *De Tolerantia Reformatorum*, &c. (Helmstedt, 1658), declared guilty of abominable heresy by the adherents of the letter of the Concordienformel—i. e., the Lutherans, men who now possessed nothing of the great reformer but his animosity. C. seems to have felt, what many devout hearts still feel, that the polemical harshness of Lutheranism is a serious obstacle in the way of a great Catholic Christianity, and that Protestantism must assume another form still before it can hope to become the religion of Europe. Under this conviction, C. endeavoured to shew that the oldest and most fundamental articles of the Christian faith—viz., the facts embodied in the 'Apostles' Creed'—were common to all Christian sects (see art. *SYNCRETISM*). In subsequent dissertations, having stated that the doctrine of the Trinity was less distinctly taught in the Old than in the New Testament, and that good works were necessary to salvation; and finally, at the religious conference of Thorn, in 1649, whither he was sent as a mediator by the Elector of Brandenburg, having been on more intimate terms with the Calvinistic than the Lutheran theologians, C. was accused of apostasy. Fortunately, however, he had powerful friends, who stood firmly by him, and through their help he was enabled to retain his professorial chair to the end of his life. He died 19th March 1656.

CALL, a term often used in reference to various theological and ecclesiastical subjects.—1. The command or invitation to believe in Jesus Christ, is designated the *call of God*, or the *gospel call*. Calvinistic theologians make a distinction between a *general call* and a *special or effectual call*. The former is addressed, they say, to all to whom the word of God comes; but it is insufficient of itself to induce any man to the act of faith, and requires, in order to its efficacy, that it be accompanied by the special and irresistible grace of the Holy Spirit. They are careful, however, to state that the general or 'outward' calling by the word always precedes and accompanies the special and effectual calling by the Spirit. The notion of an inward call by the Spirit of God in the soul, unconnected with 'outward calling by the word, belongs not

to Calvinistic, but to mystic theology.—2. A call to office in the church, and particularly to the ministry of the gospel, is regarded by Christians generally as proceeding from God; and the Church of England requires of candidates for ordination an express profession that they trust they are so moved of the Holy Ghost.—3. A call by the people who are to be under the pastoral care of a minister has been generally regarded in the Christian church as necessary to the establishment of the pastoral relation. But there have been great differences of opinion as to what constitutes a sufficient call, and great differences of practice with regard to it. Some of the principal ecclesiastical dissensions in Scotland have had their origin in this question. The election of a pastor by the *Christian people* of his *parish* or *congregation*, has been contended for by many as the true call, or the best kind of it; others, approving of patronage with certain limitations, have contended no less earnestly for the right of the people to be consulted, so that without their concurring by a call, the patron's presentee should not be held entitled to be inducted into the pastoral office; and according to the practice of the Church of Scotland, this concurrence has been always at least formally sought. Questions concerning the call and its proper value were supposed to have been determined by an act (usually called the Earl of Aberdeen's Act), passed when the *Disruption* of the Church of Scotland took place in 1843, but have begun again to be agitated within the Established Church. See CHURCH OF SCOTLAND, FREE CHURCH OF SCOTLAND, and PATRONAGE.

CALL, a stipulated sum to be paid towards a share in a joint-stock undertaking. For example, in a £10 share, there are usually at least four calls of £2, 10s. each, the calls being made at intervals of not less than three months.

CALL, a military musical term meaning a signal on the trumpet.

CALL is a metal whistle used by the boatswain and his mate on shipboard. Various strains or kinds of sound produced denote signals or orders for hoisting, heaving, lowering, veering, belaying, letting-go, &c. These sounds are as much attended to by seamen, as those of the drum, bugle, and trumpet are by soldiers. At one time, a gold call, with a chain, used to be the badge of an admiral.

CALL OF THE HOUSE is an imperative summons to every member of parliament of either House on some particular occasion, when the sense of the whole House is deemed necessary. In the *House of Lords*, when any urgent business is deemed to require the attendance of the lords, it has been usual to order the House to be called over; and this order has sometimes been enforced by fines and imprisonment upon absent lords. On some occasions, the Lord Chancellor has addressed letters to all the peers, desiring their attendance, as on the illness of George III., 1st November 1810. The most important occasion on which the House was called over, in modern times, was in 1820, for the trial of Queen Caroline.

When the *House of Commons* is ordered to be called over, it is usual to name a day which will enable the members to attend from all parts of the country. The interval between the order and the call has varied from one day to six weeks. If it be really intended to enforce the call, not less than a week or ten days should intervene between the order and the day named for the call. The order for the House to be called over is always accompanied by a resolution, 'that such members as shall not then attend, be sent for, in custody of the serjeant-at-arms.' And it was formerly the custom to desire

CALL TO THE BAR—CALLIPERS.

the Speaker to write to all the sheriffs to summon the members to attend. On the day appointed for the call, the order of the day is read and proceeded with, postponed, or discharged, at the pleasure of the House. If proceeded with, the names are called over, according to the counties, which are arranged alphabetically. The members of a county are called first, and then the members for every city or borough within that county. The counties in England and Wales are called first, and those of Scotland and Ireland in their order. This point is mentioned, because it makes a material difference in the time at which a member is required to be in his place.—See *May's Proceedings in Parliament, on Attendance of Members*.

CALL TO THE BAR is the formal expression by which the admission of law-students to the rights and privileges of the degree of barrister in England and Ireland is publicly announced. In Scotland the corresponding expression is *Passing Advocate*. See **BARRISTER**, **INNS OF COURT**, and **ADVOCATES**, **FACULTY OF**.

CALLANDER, a village in Perthshire, on the left bank of the Teith, 16 miles north-west of Stirling, and to which there is a branch of the Scottish Central Railway. It lies in a beautiful and romantic situation, surrounded by high mountains and Highland lakes. Hence it is much frequented by tourists, who make this place a centre to visit Benledi, the Trosachs, the Bracklin Falls, and Lochs Lubnaig, Vennachar, Achray, and Katrine. There is a large and commodious hotel, well provided with carriages and horses. Pop. 1716.

CALLA'O, the port of Lima, the capital of Peru, connected with that city by a railway of 6 miles in length. It stands in lat. 12° S., and long. 77° 13' W. The harbour has a commodious quay with a fine pier. The roadstead is large, free from rocks, and safe, being sheltered by the island of San Lorenzo. The exports are specie, copper, cotton, bark, and hides. C. contains about 20,000 inhabitants. It is only about 110 years old, the original city having, in 1746, been submerged and destroyed by an earthquake.

CALLICHTHYS (Gr. *kalos*, beautiful, *ichthys*, a fish), a genus of fishes of the family *Siluridae* (q. v.), having the body almost entirely covered by four rows of large, hard, narrow, scaly plates, two rows on each side. The head is also protected by a sort of helmet. The mouth is small, the teeth very small; two long barbules hang from each angle of the mouth. The species of this genus are natives of warm climates, particularly of South America. They are interesting because, when the streams or pools which they inhabit dry up, they make their way across the land to some other piece of water, even although at a considerable distance. They also sometimes bury themselves in the mud of wet meadows, out of which they are digged. They have no special organs for carrying a supply of water with them, like the climbing perch, but are supposed to retain a little between the plates of their body. A still more interesting part of the natural history of these fishes is their making regular nests, generally of leaves, in which they deposit their eggs, near the margin of the water, at the beginning of the rainy season, the male and female uniting in watching them until they are hatched. These habits are shared by the species of the allied genus *Doras*, in which the lateral plates are broader, keeled, and each ending in a spine.

CALLIGONUM, a genus of plants of the natural order *Polygonaceæ* (q. v.), having a quadrangular fruit (*achenium*, q. v.), winged at the angles. The

best known species is *C. Pallasia*, a succulent shrub found on the sandy steppes near the Caspian Sea, and in the lower part of the basin of the Volga, where its acid fruit and its also acid shoots often serve to allay the thirst of the Kalmucks and of weary travellers. Its root strikes deep into the sand, is swollen at its upper part, and when cut there, gives out a nutritious gum resembling tragacanth (q. v.), which is also obtained by pounding and boiling it, and on which the Kalmucks feed in times of scarcity.

CALLIMACHUS, an eminent poet, grammarian, and critic of the Alexandrian period, flourished about the middle of the 3d c. B. C. He was of a distinguished family at Cyrene, in Libya; taught grammar and belles-lettres in Alexandria; was a favourite of Ptolemy Philadelphus, and his successor, Ptolemy Euergetes; and was made principal librarian of the Alexandrian Library. He wrote many works on the most various subjects (Suidas mentions 800), but only fragments are extant; nor have we many of his poems; but the poems which we have, bear the marks of an age when the artificial had obtained a preference over the natural.

CALLING THE DIET is the Scotch term for *Arraignment* (q. v.), although the forms are different. In Scotland, excepting in cases of high treason, there is no grand jury, but the procedure is briefly as follows: Before a prisoner can be tried, a written or printed copy of the indictment preferred against him must have been served fifteen days before the trial, with a copy of the list of witnesses to be examined against him, and also of the jury panel. When, therefore, he is placed at the bar of the court, and called on to plead, he is presumed to know the nature of the charge made against him. But if it be desired by him, or by his counsel, the clerk in the first instance reads the indictment aloud in open court—the same being a well-prepared syllogistic statement of the facts, which the prosecutor is prepared to prove. He is then called upon to state his objections to the relevancy, and to have such relevancy disposed of by the court, before being called on to plead to the fact. If the judgment of the court is in favour of the objection, the prosecution for the time fails, and the prisoner is sent back to jail, to abide another indictment, unless the prosecutor chooses to abandon the case against him altogether. See **INDICTMENT**, **VERDICT**, **DEFENCE**.

CALLINGER, one of the hill-forts of Bundelcund (q. v.), elevated about 700 feet above the adjacent plain, and separated from a neighbouring range of mountains by a ravine of 1200 yards in width. It is in lat. 25° N., and long. 80° 32' E., being 112 miles to the south-west of Allahabad. From its position and size, C. must at one time have been a place of great strength. It was stormed by the British in 1812. At the south-east base of the rock stands a town of the same name, which, though it is now much decayed, yet bears testimony to its ancient extent and grandeur. The locality is famous for its excavated temples of Siva.

CALLIONYMUS. See **DRAGONET**.

CALLIOPE (i. e., the sweet-voiced) was, according to the ancients, the first of the Muses (q. v.), and presided over epic poetry, or over poetry in general. She was said to be the mother of Orpheus, of the Sirens, &c. She was usually represented with a style and wax tablets.

CALLIPERS, a kind of compasses with curved legs, used by turners and other workmen for measuring the diameters of cylindrical, spherical, and other curved work. The C. are laid over the work, and opened or closed until both points just touch the

psriphery; then the C. are laid upon a rule, and the extent of their opening measured, or the size is compared with a pattern.

CALLISTHENES, of Olynthus, was the son of Hero, a cousin of Aristotle. C. was born about 360 B.C.; he was educated by Aristotle along with Alexander the Great. He devoted himself to the study of natural and political history, and accompanied Alexander the Great in his expedition to India. He incurred the displeasure of the courtiers and royal favourites, and of Alexander himself, who was displeased by his remonstrating against his intended assumption of divine honours, and in general by his bold, indiscreet, outspeaking ways; and he was put to death on a pretended charge of treason, 328 B.C. Only a few fragments of his historic works remain, and these are not valuable. The *History of Alexander* ascribed to him, of which there are several MSS. in the Paris Library, is evidently a production of the 7th c., and rather a romance than a history.

CALLITHRIX. See SAGOUIN.

CALLITRIS. See SANDARACH.

CALLO'SITIES. See CORNS.

CALLOT, JACQUES, one of the most eminent artists of his time, was born at Nancy, 1592. Proceeding to Rome, he commenced drawing and engraving under Thomassin in his eighteenth year. He next went to Florence, where, by numerous spirited etchings, he gained great fame, and engraved for Cosmo II., Grand Duke of Tuscany, a series of plates of court-festivals, &c. When his patron died (1621), C. returned to his native place, and increased his reputation by a copious series of etchings, including six plates of the siege of Breda. By order of Louis XIII., who invited C. to Paris, etchings of the sieges of Rochelle and the Ile Rhé were executed; but C. refused to commemorate by art the capture of his native town, and declining the pension offered by the king, returned to Nancy, where he died, 1635. His activity as an artist was marvellous. Of his engravings, 1800 are still preserved at Dresden. As helps to a vivid conception of the manners, conditions of life, events, &c., in the 17th c., they are invaluable. C.'s 'Misères de la Guerre,' a series of 18 plates, are especially celebrated.

CALLU'NA. See HEATH.

CALLUS. This term was employed in old surgical works, and is still used popularly, to indicate the exuded material by which fractures of bones are consolidated together. If the broken ends are accurately adjusted to each other, there is no projection of C., but merely a slight deposition of it between the two surfaces; if, however, the adjustment is not accurate, the C. is effused in such quantity as to fill up any interspaces that may exist, and as often to form a considerable hard swelling round the seat of the fracture; any excess is, however, usually absorbed during the last stage of the repair of a fracture. When the broken ends are allowed to move upon each other—which, of course, should be always prevented, if possible—a ferule of new bone, encircling both fragments for some little distance, so as to splice them together, till they are united by a permanent C., is formed; this is termed a *provisional callus*.

CALMET, AUGUSTINE, an exegetical and historical writer, and learned Benedictine, was born at Mesnil-la-Horgue, near Commercy, February 26, 1672, and, in 1689, entered the order of Benedictines. In 1698, he was appointed teacher of philosophy and theology in the Abbey Moyen-Moutier; in 1704, sub-prior of a convent of learned monks at

Münster, in Alsace; and in 1706 he went to Paris, to superintend the publication of his *Commentary on the Bible*. He was afterwards appointed prior at Lay (1715), Abbot of St Leopold (1718), Abbot of Senones in Lorraine (1728), and died at Paris, October 25, 1757. His exegetical writings have been commended and studied with advantage by both Roman Catholics and Protestants. The *Commentary on the Bible* (23 vols., Paris, 1707—1716), though marked by the author's deficient knowledge of the oriental languages, contains valuable researches in biblical antiquities. C.'s *Historical and Critical Dictionary of the Bible* (4 vols., Paris, 1722—1728) was translated into English, German, and other languages, and has passed through many editions. His other works—a *History of the Bible*, and of the *Jews* (1718), and a *Universal History* (1735—1771)—are mere compilations; but his *History of Lorraine* is founded on original researches. Solid criticism and vigorous intellect are wanting in all his works.

CALMS, or **CALM LATITUDES**, are those parts of the ocean, near the equator, which are subject to total absence of wind for long periods together. The part of the ocean where C. are most looked for, is between the region of the trade-winds and that of the variable winds. See WINDS. It is almost as much dreaded by seamen as a region of storms, for the ship is unnavigable; and during a calm of many weeks, food and water may be nearly exhausted, at a point too far from land for boats to reach it. Where a calm occurs unexpectedly, it is likely to be followed by violent storms.

CALMUCKS. See KALMUCKS.

CALNE, a parliamentary borough and ancient town of Wiltshire, on the river Marden, 31 miles north-north-west of Salisbury. It lies in one of the many valleys in the chalk escarpment of this part of England, with the plateau of the Marlborough Downs and Salisbury Plain on the east and south. It consists of several streets, and the houses, which of late have been greatly improved, are chiefly built of stone. The manufacture of woollens, formerly carried on, has become quite extinct; but there is a flax factory at which a considerable number of persons, male and female, are employed. There is also a weekly corn-market. Population of the town in 1851, 5117. The parliamentary borough, formerly returning two members to parliament, but now only one, includes part of Blackland and Calstone. Many Roman remains have been found here. The West-Saxon kings had a palace at Calne, but no traces of it now remain. At a synod held here by St Dunstan in 977, relative to the celibacy of the clergy, the floor of the room in which the synod sat gave way, precipitating all to the ground but St Dunstan, who presided. On an almost perpendicular declivity 3 miles east of C. is the figure of a *horse*, 157 feet long, in a spirited attitude. It was cut out in white chalky ground in 1780 by Dr Allsopp, and is visible 50 miles off. Dr Priestley resided at C. 1770—1780.

CALO'EE. See BOEHMERIA.

CALOMARDE, DON FRANCISCO TADEO, COUNT, a Spanish statesman, was born in 1775 at Villel, in Aragon. He studied at Saragossa, where he passed as an advocate. After the expulsion of the French, and the return of Ferdinand VII. in 1814, C. was among the first to hurry to Aragon, and do homage to him as an absolute monarch. As a reward of his obsequious celerity, he obtained the highest office in the *Secretaria General de Indias*, but lost it on account of accepting a bribe. On the restoration of the constitution in 1820, he unsuccessfully courted the favour of the Liberals; but when the French army in 1823 enabled the king once

more to rule despotically, C. was appointed secretary of the *Cámara del Real Patronato*, one of the most influential offices in the kingdom. Not long after, the king made him Minister of Justice. While he held this function, he persecuted the Liberals with cold-blooded savageness, recalled the Jesuits, reopened the monasteries, and closed the universities. He also secretly favoured the party of Don Carlos; but, on the other hand, by treating any unseasonable outbreak with a strictness bordering on cruelty, he preserved himself from the suspicion of being implicated in their schemes. In 1833, when Ferdinand was supposed to be on his death-bed, he was prevailed on by C. to reintroduce the Salic Law, by which Christina was excluded from the throne, and Don Carlos, the favourite of the Absolutists, appointed his successor. This excited the hatred of the nation; and Ferdinand recovering, abolished the law. To avoid imprisonment, C. fled to France. He died at Toulouse in 1842.

CALOMEL is the popular name given to one of the compounds of mercury (Hg) and chlorine (Cl), and known to scientific chemists as the subchloride of mercury (Hg₂Cl). It is prepared by taking two equal portions of mercury, dissolving one portion in hot concentrated sulphuric acid (SO₃), which forms sulphate of mercury (HgOSO₃), thereafter adding the second part of the metal, and triturating the whole in a mortar till the metal becomes incorporated with the sulphate of mercury. This mixture is then added to one-half its weight of common salt (NaCl), and heated in a retort, when C. sublimes, and condenses in the cool part of the receiver, as a fine white powder. A minute portion of corrosive sublimate which accompanies it, is removed by washing with water. C. is very dense. It is not soluble in water, and sparingly so in acids. It turns black on the addition of lime-water, potash, soda, or ammonia; and when heated in an iron spoon, or on a knife, it does not char, but rises in vapour, sublimes unaltered, and readily condenses again on any cool surface held near it. Although C. has been more used in British practice than any other preparation of mercury, it is not known to have been employed before the 17th century. Its medicinal virtues will be treated of with the other mercurials. See MERCURY.

CALONNE, CHARLES ALEXANDRE DE, Contrôler General of Finance in France under Louis XVI., was born, January 20, 1734, at Douay. Possessing superior abilities, he studied law, and having filled successively various offices, was made, in 1783, Contrôler General of the Treasury. In this capacity he soon gained favour among the courtiers, who had complained of the parsimony of Turgot and Necker. C., though he found French finance in a deplorable state, was determined not to seem poor, gave brilliant entertainments, paid off the debts of his patron the Count of Artois, supplied the queen with sufficient pocket-money, granted pensions and gratuities to his supporters and favourites, paid off arrears, and purchased the residences of St Cloud and Rambouillet! His means of raising money were perfectly simple—he borrowed, anticipated, issued chancery-edicts, and prolonged and augmented extraordinary taxations in a style never known before. The parliament resisted these measures, but C., backed by royal authority, carried them into execution. The crisis necessarily arrived; and in 1786, when the people could bear the extraordinary taxation no longer, C. advised the king to convoke the Assembly of the Notables, and proposed to abolish the privileges (exemption from taxes) of the noble and wealthy, to take the duty off salt, to abolish *socage* (feudal or compulsory service to the lord of the manor), and

to distribute the burden of taxation more equally. The people and the aristocracy demanded a convocation of the States General, instead of the Assembly of the Notables; but C. boldly proceeded with his plan, opened the Assembly of the Notables, February 2, 1787, and in a pleasant and florid oration, described the general prosperity of French industry and commerce, and brought his speech to a climax by confessing that the annual deficit of the treasury had risen to 115 millions of francs, and that during the time from 1776 to 1786, the government had borrowed no less a sum than about 1250 millions! The Notables, instead of proceeding with C.'s plan of reorganisation, demanded from him a statement of accounts. Not being able to give this satisfactorily, he was stripped of his dignities, and banished to Lorraine. After this, C. resided chiefly in England, until in 1802 he obtained from Bonaparte permission to return to France, where he died, in very embarrassed circumstances, October 30, 1802.

CALOPHYLLUM (Gr. beautiful leaf), a genus of trees of the natural order *Guttifere* (q. v.), natives of warm climates. Some of the species yield valuable timber, as *C. angustifolium*, the **PINEY TREE**, which grows at Penang, and in the islands to the eastward of the bay of Bengal, and furnishes the beautiful straight spars called *Peon*. The resinous products of some species are valuable, and among them are some of the substances known by the name of **TACAMAHACA** (q. v.). *C. Inophyllum*, which yields true East Indian Tacamahaca, is a very large and beautiful umbrageous tree, often planted for its shade and the fragrance of its flowers, which are white and in loose axillary racemes. It is one of the most valuable timber-trees of the South Sea islands. The timber resembles mahogany, being of equally close texture, although of lighter colour, and very durable. The leaves are oblong and obtuse; the fruit—which in all this genus is a globose drupe or stone fruit—is about the size of a walnut; and a fixed oil is expressed from its kernel, which is used for lamps, &c. A similar oil is expressed from the seed of *C. Calaba*, the **CALABA TREE** of the West Indies, which also has white sweet-scented flowers, and of which the timber is used for various purposes, particularly for staves and cask-headings.

CALORIC, a term for Heat (q. v.).

CALORIC ENGINE. This is a new name given by Captain Ericsson to his latest and most improved *air-engine*. There seems no reason for this change of name, unless it were meant to distinguish it from the previously well-known, though hitherto unsuccessful air-engines of the Messrs Stirling, with which it is nevertheless identical in principle, although somewhat modified in form.

Air-engines, in their principal working-parts, are very similar to the ordinary steam-engine, the power, which is derived from air expanded by heat, being communicated to a piston working in a cylinder, and thence by piston-rod and connecting-rod to the crank and main shaft. In the earlier air-engines by Sir George Cayley and others, the air had its temperature raised to 500° or 600° by passing it through a heated chamber; and after having *once* acted on the piston, it was allowed to escape into the atmosphere, carrying along with it a large portion of its heat, which was thus wasted.

The distinctive principle of the Messrs Stirling's air-engine, as of the later C. E., consists in saving the greater part of this waste heat, and using it again and again in the working of the engine, so as greatly to economise the expenditure of fuel. This frequent use of the same heat is effected by means of an 'economising process' or 'regenerator,'

CALORIMETER—CALOTYPE PROCESS.

consisting of a chamber or chambers filled with metallic sieves of wire-gauze, or minutely divided metallic passages, through which the hot air is made to pass *outwards* from the cylinder, after having performed its work on the working-piston of the engine, leaving a great part of its heat in the sieves or narrow passages, to be given out by them again to the returning air, which is made to pass *inwards* through the same sieves or narrow passages, and by a slight accession of new heat from the furnace, to produce another effective stroke of the piston. By repeating this process at each stroke of the engine, it is evident that a large portion of the heat that would otherwise go to waste will be used many times over, and thus a smaller amount of new heat will require to be supplied from the heating furnace of the engine, and a corresponding saving of fuel be effected. The most ready and simple illustration of the action of the economiser is to be found in Jeffrey's Respirator, which is almost a fac-simile of one of the forms of economiser previously adopted in Stirling's engines.

This method of extracting the heat from air, and recommunicating it to the same, or a similar quantity of air, was first discovered by the Rev. Dr Stirling, now of Galston, Ayrshire, who obtained a patent for it in 1816. After testing it in various working models, an engine was built and applied to the pumping of water from a quarry in Ayrshire so early as 1818; but, from the slight construction of the heating vessel, which was of boiler-plate, and the want of experience and care in the engine-keeper, the part exposed to the heat of the furnace became overheated, and soon gave way, and the invention was for a time abandoned.

In working with air at the ordinary pressure of the atmosphere, the engine was found to require to be of large dimensions, as compared to a steam-engine of the same power; and in order to obviate this objection, it occurred to Mr James Stirling, C.E. (now of Edinburgh), brother of the inventor, that by using air of a higher density, mechanically compressed, the power might be much increased without materially increasing the size of the engine. This became the subject of a second patent by the two brothers jointly in 1827; but various defects in this engine, which had not been anticipated, led to its abandonment a second time. One of these defects arose from the accumulation of the heat—not fully extracted by the sieves or small passages—in the cool part of the regenerator, of which the external surface was not sufficiently large to throw off the unrecovered heat when the engine was working with highly compressed air. In order to meet this defect, a powerful tubular refrigerator, cooled with water, was designed, which, along with several other improvements, were, after being tested in a small engine of 2 horse-power, finally secured by patent by the Messrs Stirling in 1840. Two of these improved engines were constructed, one with a cylinder 12 inches in diameter, and 2 feet stroke, which worked to 20 horse-power; and another with a cylinder 16 inches in diameter, and 4 feet stroke, which was tested to fully 40 horse-power. This latter engine did all the work of the Dundee Foundry Company regularly, with a saving of about 75 per cent. of the fuel used by the steam-engine, for upwards of three years, during which period they employed no other motor. At the end of this period, it was laid aside, owing to the failure of one of the heating vessels, the renewal of which would have led to considerable expense and loss of time.

Captain Ericsson, in his late bold attempt to introduce his C. E. in the splendid ship which bore his name, seems to have experienced the

same difficulties and disappointments, and to have tried nearly the same remedies as the Messrs Stirling. The first working cylinders of the *Ericsson* were 168 inches, or 14 feet in diameter, with a stroke of 8 feet, and worked with air at the pressure of the atmosphere. This power being found inadequate for the requirements of the ship, he attempted to employ highly compressed air, and reduced the size of the working cylinders to 72 inches, or 6 feet in diameter, with a stroke of 8 feet, but still without the favourable result which he expected. But although he has been disappointed in the great results anticipated for the *Ericsson*, air-engines on a small scale are being extensively introduced in the United States for driving printing-presses and the like; and it is to be hoped that, with a larger experience in the use of these engines, some beneficial result may yet be obtained on a greater scale from the use of the economising principle, of the efficacy of which there can be no doubt.

For full accounts of these engines, see Minutes of Proceedings, Inst. Civ. Eng., London, June 1845, and May 1853; and *Appleton's Mechanics Magazine*, New York, October 1851, and March and September 1853.

CALORIMETER, a measurer of the degree of heat (q. v.).

CALOTROPIS. See MUDAR.

CALOTTISTES (*Le Régiment de la Calotte*), a society of witty and satirical men, in the time of Louis XIV., who were headed by two officers in the king's body-guard, named Torsac and Aimon. Their name was taken from the word *calotte* (a 'small cap,' worn by monks over the tonsure), and their amusement consisted in sending to any public character who had exposed himself to ridicule, a 'patent,' authorising him to wear the *calotte*, as a covering for the weak part of his head. The armorial bearings of the *Régiment de la Calotte* consisted of various symbols of folly, with the motto, '*C'est régner que de savoir rire.*' When Torsac, its first 'generalissimo' died, the society—which occupied a position of satirical hostility to the French Academy—drew up a burlesque funeral oration, manufactured out of the pompously eulogistic phrases that the academicians were in the habit of using. As the society became audacious, and did not spare even royalty itself, it was dissolved by the minister Fleury. The *Mémoires pour servir à l'Histoire de la Calotte* (Basel, 1725) is an amusing little book. During the Restoration, the title *Régime de la Calotte* was applied to the priestly administration of affairs.

CALOTYPE PROCESS (Gr. *kalos*, beautiful, *typos*, impression), a title comprehending a variety of methods for the production of negative photographs on paper; and so named by the inventor, Mr Henry Fox Talbot, who exhibited the result of his experiments in the year 1840. The principle involved in the C. P. depends on the susceptibility to the action of daylight of a surface chemically prepared, and the *practice* consists in the preparation, and exposure in the camera, of a sheet of paper, having on one surface an even and finely divided layer of iodide of silver, nitrate of silver, and an organic acid; the image obtained on this surface being subsequently developed with gallo-nitrate of silver. It will be unnecessary here to describe the various modifications which have been introduced with the object of imparting a high degree of sensibility to the paper; one process—the best—will suffice to describe the manipulation.

Good English paper, sized with gelatine, should be chosen, the foreign starch-sized papers being unsuitable, on account of the solutions sinking in too deeply, and thus impairing that sharpness of

outline which should be possessed by a good negative. The paper is then floated on one side, and for a moment only, on a solution of iodide of silver in iodide of potassium; prepared by adding freshly precipitated iodide of silver to a *strong* solution of iodide of potassium. It is then dried, and plunged into a dish containing distilled water, which, by removing the soluble iodide of potassium, precipitates the iodide of silver in an even and finely divided condition over the whole surface of the paper, which in this state will keep good for twelve months. It is now ready to receive the *sensitive coating*; this operation, which is called *exciting* the paper, is performed in the following manner: Two solutions are prepared—one, a saturated solution of gallic acid in cold distilled water, called solution A; the other, a solution of 50 grains of nitrate of silver in one ounce of distilled water, to which one dram of glacial acetic acid has been added; this is called solution B. The iodised paper obtained as above is now laid on a board having a piece of clean blotting-paper on it a little larger than the paper to be excited, and the following solution brushed over it with a clean Buckle's brush—distilled water, 1 oz.; solution A, 15 drops; solution B, 15 drops. This mixture, prepared in a chemically clean glass vessel, should be freely applied, and the excess absorbed by clean blotting-paper. The paper is now ready for exposure in the camera, and may be at once placed in the dark slide; or a stock may be thus sensitised, and preserved between folds of blotting-paper until required for use. The *time of exposure*—varying from three minutes to a quarter of an hour—is determined by the diameter and focal length of the lens employed, the aperture of the diaphragm or stop, and the amount of light prevailing at the time. The *development of the latent image*, an operation which, like the preceding, is of course conducted in a room illuminated only by yellow light, is accomplished by applying freely and uniformly over the whole surface solution A; and when the image begins to appear, applying a second quantity, to which a few drops of solution B have been previously added, to increase the intensity. The whole operation of development occupies about a quarter of an hour; and when the details are fully out, the picture should be washed with water, and *fixed*, by immersion in a solution of 1 part of hyposulphite of soda to 4 parts of water; it is then again freely washed in frequent changes of water during several hours; it is lastly *dried* and *waxed*; when it may be regarded as a finished negative, from which positive prints may be obtained, having the lights and shadows as in nature. See POSITIVE PRINTING.

CALOYERS, a general name for the monks of the Greek Church. The name is a corruption of two Greek words, *kalos* and *gerōn*, and signifies 'good old men.' The C. follow the order of St Basil, and are divided into three ranks; the novices, called *Archari*, the ordinary professed, called *Microchemi*; and the more perfect, called *Megalochemi*. It is always from among them that bishops and patriarchs are chosen, because they are generally members of the most distinguished families of the upper and middle classes. The C. also furnish the only learned theologians in Greece at the present day. Their monasteries are very numerous. The most celebrated in Asia is that of Mount Sinai, founded by the Emperor Justinian, and endowed with a revenue of 60,000 crowns. In Europe, Mount Athos alone has twenty, the inmates of which have so great a reputation for sanctity, that even the Turks seek an interest in their prayers. The C. are obliged to labour for the benefit of their monastery as long as they continue in it. Their religious services occupy an unnaturally large portion of their time, beginning

at midnight, and continuing at intervals until sunset. They observe four Lents: the first, of eight weeks, in commemoration of the resurrection of our Lord; the second, of three weeks, in honour of the holy apostles; the third, of fourteen days, in commemoration of the Assumption of the Virgin; and the fourth in commemoration of the Advent.—There are also female C. or Greek nuns, who likewise follow the rule of St Basil.

CALPEE, a city of Bundelcund, on the right bank of the Jumna, in lat. 26° 7' N., and long. 79° 48' E. In 1848 it had a population of 18,714. It is an entrepôt for the cotton of the neighbouring district. It has manufactures of paper, and is celebrated for the beauty of its refined sugar. It became British by capture and cession, respectively, in 1803 and 1806. It is 46 miles to the southwest of Cawnpore, and is closely linked with it in the history of the insurrection of 1857—1858, as the head-quarters of the Gwalior Contingent.

CALPENTY'N, a long and narrow peninsula on the west side of Ceylon, in lat. 8° 14' N., and long. 79° 53' E. The neck is so low as to be overflowed during the north-east monsoon, so that it is transformed into an island.

CALPU'RNIUS. The Calpurnia gens was, by its own account, one of the oldest plebeian clans in Rome; but it does not figure in history till the time of the first Punic war. The family names, in the time of the Republic, were Bestia, Bibulus, Flamma, and Piso.—**MARCUS CALPURNIUS BIBULUS** is known as the hostile but incapable colleague of Cæsar (q. v.) in the consulate. He was put up by the aristocratic party, who spent vast sums to carry the election. He finally joined the Pompeian party, had command of the fleet intended to prevent Cæsar's passage to Greece, and died 48 B. C., before the battle of Dyrrhachium. Among the Roman women of this family, two are celebrated—**CALPURNIA**, the daughter of Calpurnius Piso (consul 58 B. C.), and the last wife of Cæsar, who seems, from the scanty notices of her we possess, to have been a quiet domestic woman, full of love and solicitude for her great husband; and **CALPURNIA**, the daughter of L. Calpurnius Bestia, wife of P. Antistius, who killed herself when her husband was murdered by order of the younger Marius, 82 B. C.

CALTANISSETTA, a fortified town of Sicily, situated on a fertile plain near the Salso, about 28 miles north-east of Girgenti. It has mineral springs and extensive sulphur-works. Pop. 16,563.

CAL'THA. See MARSH MARI GOLD.

CALTO'NICA, a town of Sicily, about 15 miles north-west of Girgenti. It has pretty extensive sulphur-works and salt-works. Pop. 7000.

CAL'TROP, **CAL'THROP**, or **CAL'THORE**, in military warfare, is a four-pronged piece of iron, each prong about four inches in length. When it is wished to check the approach of the enemy's cavalry over a plain, or of his besiegers in the ditch of a fortification, caltrops are sometimes thrown down; from their shape, one prong is sure to stand upright, and may work terrible mischief to the enemy's horses or men.

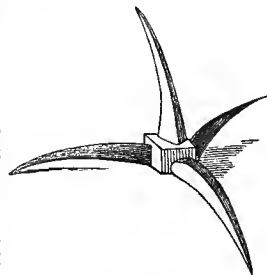

Caltrop.

CALUIRE—CALVELLO.

CALUIRE, a town of France, in the department of the Rhone, situated on the left bank of the Saone, about three miles north-north-east of Lyon. It has three annual fairs. Pop. 5500.

CALUMBA, or **COLOMBO**, very extensively used in medicine, is the root of *Cocculus palmatus*, a herbaceous plant of the natural order *Menispermaceæ* (q. v.). It is said to derive its name from Colombo in Ceylon, although the *C.* now chiefly in use is the produce of Mozambique. The flowers in this genus have 12 sepals and petals in all, similar in appearance, and disposed in four rows. The male and female flowers are on separate plants. *C. palmatus* has nearly circular leaves with 5—7 lobes, on long hairy foot-stalks, and solitary axillary racemes of small green flowers, the racemes of the male plants branching. The fruit is a drupe, or 1-seeded herry-like fruit, about the size of a hazel-nut, densely clothed with long hairs. The stem is annual and twining; the root perennial, consisting of clustered spindle-shaped fleshy tubers, with a brown warty epidermis, and internally deep yellow. The plant is not cultivated; the root is collected where it grows wild in dense forests. It is dug up in March, cut into slices, or short cylindrical pieces, and dried in the shade. In this state it appears in commerce, having a greenish-yellow tint, a very bitter taste, and a faint aromatic odour. Its bitterness is ascribed to a somewhat narcotic principle called Calumbine, and to *Berberine*, an alkaloid originally discovered in the Barberry (q. v.), which is also present in it. *C.* is regarded as one of the most useful stomachics and tonics. It is demulcent, not at all stimulant, and capable of being employed in cases in which almost every other tonic would be rejected by the stomach. It is sometimes given to allay vomiting. It has been found very useful in diarrhoea and dysentery. It is administered in the form of powder, infusion, or tincture. Similar properties seem to reside in the roots of the species of *Cocculus* generally.—The very poisonous seed known by the name of **COCCULUS INDICUS** (q. v.), belongs to a plant of a different but allied genus.—The root of *Frasera Walteri* is sometimes fraudulently substituted for *C.*, and has been called American Calumba Root. It does not agree with *C.* in its properties, but, besides its very different appearance, it may be distinguished by its undergoing no such change of colour when touched with tincture of iodine, as in true *C.* Root is produced by the presence of starch. See **FRASERA**.

CALUMET, the 'peace-pipe' of the North American Indians, is a tobacco-pipe having a stem of reed about two feet and a half long, decorated with locks of women's hair and feathers, and a large bowl of polished marble. It plays an important part in the conclusion of treaties, of which, indeed, it may be described as the ratifier. After a treaty



Calumet, or Pipe of Peace.

has been signed, the Indians fill the *C.* with the best tobacco, and present it to the representatives of the party with whom they have been entering into alliance, themselves smoking out of it afterwards. The presentation of it to strangers is a mark of hospitality, and to refuse it would be considered an act of hostility.

CALUMNY. An ancient regulation of the

Scotch law obliged litigants to give their *oath of C.*—that is, they swore, either by themselves or by their counsel, that the facts alleged by them were true, although in practice this oath was not usually put unless one of the parties required it of his adversary. In the modern practice, however, of the Court of Session, this oath is confined to actions for divorce, and other consistorial cases—the object being to guard against collusion between the husband and wife. See **DIVORCE**.

CALUMNY, LAW AS TO. See **LIBEL**.

CALUSO, a town of Piedmont, about 11 miles south of Ivrea, and connected with Turin by railway. Pop. 5548.

CALVADOS, a maritime department in the north-west of France, bounded N. by the English Channel, and E., W., and S. by the departments of Eure, Manche, and Orne. It is formed out of a part of the old province of Normandy. The principal rivers are the Touques, Orne, Dives, Seulle, Dromme, and Vire. The coast, which has few bays or inlets, is partly formed by bold ridges, and partly by sand-downs, cliffs, and reefs. The reef extending between the mouths of the Orne and the Vire, called Calvados, after one of the vessels in the Spanish Armada shipwrecked here, and from which the department takes its name, is very dangerous to navigation. The soil of the department is generally fertile, especially in the valleys, supplying rich pasturage for horned cattle, sheep, horses, and swine, which constitute the principal wealth of Calvados. The climate is healthy, though changeable. Iron, marble, slate, and coal are found. There are various manufactures, and the coast-fisheries are of some importance. *C.* has an area of 2130 square miles, with a population in 1856 of 478,397, and is divided into six arrondissements. Caen is the capital.

CALVAERT, **DIONYS**, called also **DIONISIO FLAMMINGO**, a distinguished painter, especially in landscape, was born at Antwerp in 1555. He settled early at Bologna, where he opened a school, and had among his students the celebrated Domenichino, Guido, and Albani, who were afterwards, however, pupils of the Caracci. Many excellent pictures by him are still preserved at Bologna. He died in 1619.

CALVARY, MOUNT, the scene of our Saviour's crucifixion, is an eminence which lay at the north-west, and just on the outside, of the ancient city of Jerusalem. Calvary, or Calvaria, is a translation into Latin of the Hebrew word Golgotha, signifying a 'skull,' either because the mount was a place of public execution, or because it was shaped like a human skull.

CALVARY, in Roman Catholic countries, is a representation of the various scenes of the passion and crucifixion of our Lord, either in a chapel, or external to the church, as at St Jacques at Antwerp. It consists of three crosses with the figures of Christ and the thieves, usually as large as life, surrounded by a number of figures, representing the various personages who took part in the crucifixion. At Aix-la-Chapelle, the *C.* is a church on the top of a hill, surrounded by twelve sculptured stones, each marking an event which took place on the journey of the Saviour to Mount Calvary. The approach to the *C.* is called the *Via Dolorosa*, each of the stones marking what is called a station, at which the pious say a prayer in passing.

CALVELLO, a town in the province of Basilicata, Naples, pleasantly situated on a hill-slope about 13 miles south of Potenza. It has two convents. Pop. 6550.

CALVENTURA ISLANDS, off the coast of Arracan, in the Bay of Bengal, their centre being in lat. 16° 53' N., and long. 94° 20' E. The group consists of two divisions—one to the south-east, which is composed of two lofty and well-wooded islets; and another to the north-west, which presents seven bare rocks, chiefly of fantastic shapes.

CALVI, a seaport on the island of Corsica, situated on a peninsula in the Gulf of Calvi, about 38 miles west-south-west of Bastia, lat. 42° 35' N., long. 8° 43' E. It is strongly fortified, and has a good port, with a high light at its entrance, and a considerable export trade. C. was captured by the English in 1794, after a siege of 51 days. Pop. 1746.

CALVILLE, a kind of apple, of which there are numerous sub-varieties. The calvilles diminish in thickness from the middle towards the calyx, where they form a point; they have regular ribs, and a large open seed-chamber; also a pleasant smell, and are unctuous to the touch. They are never altogether streaked; they have a fine loose flesh, with a flavour somewhat resembling that of the raspberry or strawberry. The White Winter C. is in high repute both as a culinary and dessert apple; it is very extensively cultivated on the continent of Europe.

CALVIN, JOHN, one of the most eminent of the reformers of the 16th c., was born at Noyon, in Picardy, on the 10th of July 1509. His father, Gerard Cauvin or Calvin, was procureur-fiscal of the district of Noyon, and secretary of the diocese. He was one of six children—four sons and two daughters. All the three sons who survived were bred ecclesiastics; and the reformer himself, while still only 12 years of age, was appointed to a chaplaincy in the cathedral church of Noyon. This he held as a means of support during the period of his education, and even for some short time after he had entered on his reforming career. C. was educated in circumstances of ease, and even affluence. The noble family of Mommor, in the neighbourhood, invited him to share in the studies of their children; he was in some measure adopted by them; and when the family went to Paris, in his 14th year, he accompanied them, and participated in the benefits of the higher instruction which was there attainable. He was entered as a pupil in the Collège de la Marche, under the regency of Mathurin Cordier, better remembered, perhaps, by his Latin name of Corderius. It was under this distinguished master that C. laid the foundation of his own wonderful mastery of the Latin language. During this early period, he was distinguished by the great activity of his mental powers, and the grave severity of his manners. His companions, it is said, surnamed him the 'Accusative.'

For awhile, his attention was directed to the study of law. His remarkable talents seemed to promise great success in this branch of study, and his father sent him, with the view of prosecuting it, to the university of Orleans, then adorned by Pierre de l'Etoile, one of the most famous jurists of his day, and afterwards president of the Parliament of Paris. At Orleans, he continued the same life of rigorous temperance and earnest studiousness for which he was already noted. Beza says, that, after supping moderately, he would spend half the night in study, and devote the morning to meditation on what he had acquired. His undue habits of study seem to have laid thus early the foundation of the ill-health which marked his later years. It was while a law-student in Orleans that he became acquainted with the Scriptures, and received his first impulse to the theological studies which have made his name so

distinguished. A relative of his own, Pierre Robert Olivetan, was there engaged in a translation of the Scriptures; and this had the effect of drawing C.'s attention, and awakening within him the religious instinct which was soon to prove the master-principle of his life. We cannot say as yet that his traditional opinions were unfix'd, or that he had embraced with any decision the Protestant opinions that were spreading everywhere; but the seeds of the new faith were now beyond doubt sown in his heart, and from this time, although he still continued for awhile longer to pursue his legal studies, his main interests appear to have been religious and theological. From Orleans he went to Bourges, where he acquired the knowledge of Greek, under the tuition of a learned German, Melchior Wolmar, to the influence of whose spiritual instructions he was also greatly indebted. He began here to preach the reformed doctrines, and passed over into the ranks of Protestantism, under the slow but sure growth of his new convictions, rather than under the agitation of any violent feeling. Here, as everywhere, his life presents a marked contrast to that of Luther.

He proceeded to Paris in 1533, which at this date had become a centre of the 'new learning,' under the teaching of Lefevre and Farel, and the influence of the queen of Navarre, sister of Francis I. The Sorbonne itself had not escaped the infection. There was a growing religious excitement in the university, in the court, and even among the bishops. This, however, was not to last. The king was soon stirred up to take active measures to quell this rising spirit; and the result was that C. and others were obliged to flee for their lives. The story is that C. narrowly escaped, having descended from his window by means of his sheets, and fled, under the guise of a vine-dresser, a friend of his, in whose clothes he concealed himself. After this he repaired for a short time to his native place, resigned the preferment he held in the Roman Catholic church, and for a year or two led a wandering life, sheltered in various places. We find him at Saintonge; at Nerac, the residence of the queen of Navarre; at Angoulême, with his friend Louis Tillet; then for a brief while at Paris again, strangely enough expecting a meeting with Servetus, who had expressed a desire to see and confer with him. Persecution against the Protestants at this time raged so hotly, that C. was no longer safe in France; and he betook himself to Basel, where he is supposed to have prepared the first edition of the *Institutes of the Christian Religion*, and whence he certainly issued, in the year 1535, the famous preface addressed to Francis I. The concentrated vigour of this address, its intensity of feeling, rising into indignant remonstrance, and at times a pathetic and powerful eloquence, make it one of the most memorable documents in connection with the Reformation. It is throughout a noble defence of the righteous character of the reformed doctrines, and their support alike in Scripture and in history. The energetic decisiveness and moral zeal of the future teacher and legislator of Geneva, speak in every page of it. After completing this great service to the cause of Protestantism, he made a short visit to Italy, to Renée, the Duchess of Ferrara. Finally, he revisited his native town; sold the paternal estate, which had devolved to him on the death of his eldest brother; and bidding it adieu, set out in company with his younger brother and sister on his way to Strasburg. The direct road being rendered dangerous by the armies of Charles V., which had penetrated into France, he sought a circuitous route through Savoy and Geneva.

The result of this journey was memorable for the cause of the Reformation. Arrived in Geneva, he

met there his friend, Louis Tillst, who communicated the fact of his arrival to Farel, then in the very midst of his struggle to promote the Reformation in the city and neighbourhood. Farel hastened to see him, and urge upon him the duty of remaining where he was, and undertaking his share of the work of God, under the burden of which he was like to fail. C. did not at first respond to the call. He was given, he himself says, to his 'own intense thoughts and private studies.' He wished to devote himself to the service of the reformed churches generally, rather than to the care of any particular church. A life of intellectual and theological labour was that which at that time was most congenial to him. By some strange insight, however, Farel penetrated to the higher fitness of the young stranger who stood before him, and he ventured, in the spirit of that daring enthusiasm which characterised him, to lay the curse of God upon him and his studies if he refused his aid to the church of Geneva in her time of need. This seemed to C. a divine menace. 'It was,' he said, 'as if God had seized me by his awful hand from heaven.' He abandoned his intention of pursuing his journey, and joined eagerly with Farel in the work of reformation.

Such was the beginning of C.'s great career in Geneva. Having entered upon his task, he soon infused an energy into it which crowned the struggling efforts of Farel with success. The hierarchical authority was already overturned before his arrival; the citizens had asserted their independence against the Duke of Savoy, whose alliance with the corrupt episcopate, which was the direct governing influence in the place, had called forth the patriotic as well as the religious feelings of the people. The magistrates and people eagerly joined with the reformers in the first heat of their freedom and zeal. A Protestant Confession of Faith was drawn out, approved of by the Council of Two Hundred, the largest governing board of the city, and then proclaimed in the cathedral church of St Peter's as binding upon the whole body of the citizens. Great and marvellous changes were wrought in a short time upon the manners of the people; where licence and frivolity had reigned, a strict moral severity began to characterise the whole aspect of society. The strain, however, was too sudden and too extreme. A spirit of rebellion to the rule of the reformers broke forth; they refused to yield to the wishes of a party animated by a more easy and liberal spirit than themselves, and known in the history of Geneva under the nickname of Libertines; and the consequence was, that they were both expelled from the city after less than two years' residence.

C. retreated to Strasburg, where he had meant to go when arrested in his course at Geneva. Here he settled, and devoted himself to theological study, and especially to his critical labours on the New Testament. Here, also, in October 1539, he married the widow of a converted Anabaptist. The marriage appears to have proved a happy one, although not of long duration.

The Genevans found, after a short time, that they could not well get on without Calvin. His rule might be rigid; but an authority, even such as his, which might gall from its severity, was better than no settled authority at all; and the Libertine party seem to have been unable to construct any efficient and beneficent form of government. Accordingly, they invited C. to return; and after some delay on his part, in order to test the spirit in which they were acting, he acceded to their invitation, and in the autumn of 1541, after three years' absence, once more made his entry into Geneva.

Now, at length, he succeeded in establishing his

plan of church-government, in all its forms and details. By his College of Pastors and Doctors, and his Consistorial Court of Discipline, he founded a theocracy, with himself at the head of it, which aimed virtually to direct all the affairs of the city, and to control and modify both the social and individual life of the citizens. Not without a struggle, it may be supposed, did he succeed in his great autocratic scheme. The Libertines, although dishonoured by their ineffectual attempts to maintain order in the city, and uphold its rights and dignity, still remained a strong party, which was even augmented, after C.'s return, by men such as Amy Perrin, who had strongly concurred in the invitation to C., but who were afterwards alienated from him by the high and arbitrary hand with which he pursued his designs, as well as by their own schemes of ambition. The struggle with this party lasted with various fortune for no less a period than fifteen years, and was only terminated in 1555, after a somewhat ridiculous *émeute* in the streets. Amy Perrin and others, driven from the city, were executed in effigy; and the reformer's authority from this date confirmed into an absolute supremacy.

During the period of this long struggle with the Libertines, C. had many other disputes, in which he conducted himself with no less heartiness and zeal. The most remarkable of these were his controversies with Sebastian Castellio, Jeroms Bolsec, and above all, Michael Servetus.

C. had become acquainted with Castellio at Strasburg. They entertained at first a warm friendship for each other, and C. shewed great zeal in assisting Castellio, whose poverty and learning had attracted his sympathy. When he returned to Geneva, he invited Castellio to join him there, and procured for him the title of Regent or Tutor in the gymnasium of the city. There was little similarity, however, in the characters of the two men, and the diversity of their tastes and views soon became apparent. The learning of Castellio was intensely humanitic; a classical spirit and a somewhat arbitrary opinionativeness moulded all his studies; and as soon as he began to apply himself to theology, he came into conflict with Calvin. In a letter to Farel in 1542, we find C. speaking of the freaks of 'our friend Sebastian, which may both raise your bile and your laughter at the same time.' These freaks relate to Castellio's notions of Scriptural translation, and his refusal of C.'s offer to revise the version which he had made of certain parts of Scripture. Then, two years later, when Castellio desired to enter into the ministry, C. dissuaded the council from accepting him, on account of some peculiar opinions which he held. These were certain rationalistic views as to the authenticity and character of the Song of Solomon, the descent of Christ into hell, and also about election. After this, Castellio left Geneva for awhile, but soon returning, he attacked the views of C. openly. After a violent scene in church, which is painted in C.'s letters very strongly, he was forced to leave the city. The two old friends, now declared enemies, did not spare each other henceforth. The fate of Servetus drew forth an anonymous publication, attacking with keen logic and covert and ingenious sarcasm the Genevan doctrines. This publication was attributed by both C. and Beza to Castellio, and they replied to him in no measured terms, stigmatising him as a 'deceiver and vessel of Satan.' One fact really disgraceful to C. in the controversy deserves not to be passed over. Sunk in great poverty, Castellio was obliged, in his old age, to gather sticks on the banks of the Rhine at Basel, as a means of support. C. did not hesitate to accuse

him of stealing the sticks. Such polemical truculence may well make us turn away in disgust and indignation.

The controversy with Bolsec belongs to a later period. Jerome Bolsec was originally a Carmelite monk, but he had thrown aside the habit, and betaken himself to the practice of medicine in Geneva. He was led to attack C.'s doctrine of predestination. As soon as C. heard of this, he led him to understand that he was not at liberty to question the Genevan doctrine. He and the other clergy dealt with him; but after repeated disputations Bolsec was found incorrigible, and was sentenced to banishment from the city. Cast out of the theocratic community, he ultimately rejoined the Roman Catholic Church, and revenged himself in a somewhat mean way against C. by writing his life in a spirit of detraction and slander.

Of all these contests, however, the most memorable is that with Servetus. A melancholy interest encircles the name of this great heretic, which the criminal tragedy of his death keeps always fresh and vivid in the minds of all who hate intolerance, and who love truth rather than dogmatism. The character of Servetus himself has little to do with this interest. He seems to have been more of a vain, restless, and enthusiastic dreamer, than of a calm and patient inquirer. In his very dreams, however, and the vague audacities of his speculation, there is a kind of simplicity and unconscious earnestness that wins sympathy. He had entered into various connections with C., even from the time of his early residence in Paris; particularly, he had sent him various documents containing the views, fully developed in his work subsequently published under the title of *Restitutio Christianismi*. C. never concealed his abhorrence of these views; and in a letter to Farel as early as 1546, he threatens that if Servetus should come to Geneva, he would do what he could to bring him to condign punishment: *Nam si venerit, modo valeat mea auctoritas, vivum exire nunquam patiar*. The history of his seizure and condemnation at Vienne by the Catholic authorities, and especially of C.'s share in the correspondence which led to his seizure, is very complicated and obscure. It has been maintained that C. was the instigator, through a creature of his own of the name of Trie, of the whole transaction; it is certain that he forwarded to the authorities, through Trie, private documents which Servetus had intrusted to him, with a view to the heretic's identification, and as materials for his condemnation. Servetus was sentenced to be burned, but effected his escape, and, after several months' wandering, he was found at Geneva. It was his intention to proceed to Italy, where he hoped his opinions might meet with some degree of toleration, and he arrived at Geneva on his way. This is the explanation of an event otherwise unaccountable. Having ventured to church, according to the common account, he was recognised, apprehended, and conveyed to prison by C.'s order, just as he was about to leave the city. The particulars of his trial are full of interest, but too lengthened to be detailed here. It lasted, with various interruptions, for two months. He attacked C. with the most foul epithets, and C. retorted with a virulence and foulness quite equal to his own. At length, on the 26th of October 1553, sentence was passed upon Servetus, condemning him to death by fire. C. used his influence to have the mode of death alleviated, but without success. On the very next morning, the sentence was put into execution. On an extended eminence at some distance from the city, Servetus was fastened to a stake surrounded by heaps of oak-wood and leaves,

with his condemned book and the MS. he had sent to C. attached to his girdle; and, amid his agonising cries, the fire was kindled, and the wretched man expiated his heresy amidst the flames. Whatever apologies may be urged for this memorable crime, it must remain a mournful and scandalous blot on the history of the Reformation. The disgrace of it has particularly attached to C., and with some justice, from the special and unhappy relation which he bore to the whole transaction; but most of the Reformers are no less implicated in it. The wise Bullinger defended it, and even the gentle Melancthon could only see cause for gratitude in the hideous tragedy.

After the execution of Servetus, and the expulsion of the Libertines, two years later, C.'s power in Geneva was firmly established, and he used it vigorously and beneficently for the defence of Protestantism throughout Europe. By the mediation of Beza, he made his influence felt in France in the great struggle that was there going on between the hierarchical party, with the Guises at its head, and the Protestants, led by Condé and Coligny. In 1561, his energies began to fail. He had been long suffering from bad health, but his strength of will and buoyancy of intellect sustained him amid all his bodily weakness. In the year now mentioned, his bad health greatly increased, and although he survived for more than two years, he never regained any vigour. He died on the 27th of May 1564.

Very different estimates, it may be imagined, have been formed of C.'s character, according to the point of view from which it is contemplated. None, however, can dispute his intellectual greatness, or the powerful services which he rendered to the cause of Protestantism. Stern in spirit, and unyielding in will, he is never selfish or petty in his motives. Nowhere amiable, he is everywhere strong. Arbitrary and cruel when it suits him, he is yet heroic in his aims, and beneficent in the scope of his ambition. Earnest from the first, looking upon life as a serious reality, his moral purpose is always clear and definite—to live a life of duty, to shape circumstances to such divine ends as he apprehended, and, in whatever sphere he might be placed, to work out the glory of God.

He rendered a double service to Protestantism, which, apart from anything else, would have made his name illustrious: he *systematised* its doctrine, and he *organised* its ecclesiastical discipline. He was at once the great theologian of the Reformation, and the founder of a new church polity, which did more than all other influences together to consolidate the scattered forces of the Reformation, and give them an enduring strength. As a religious teacher, as a social legislator, and as a writer, especially of the French language, then in process of formation, his fame is second to none in his age, and must always conspicuously adorn the history of civilisation. Among C.'s most important works are: *Christiana Religiois Institutio* (Basel, 1536); *De Necessitate Reformandæ Ecclesie* (1544); *Commentaires sur la Concordance ou Harmonie des Evangélistes* (Gen. 1561); *In Novum Testamentum Commentarii* (edited by Tholuck, in 7 vols., Halle, 1833—1834); *In Libros Psalmorum Commentarii* (edited by Tholuck, 1836); *In Librum Geneseos Commentarii* (edited by Hengstenberg, 1838). A collection of C.'s Letters, compiled from the original MSS., and edited with historical notes by Dr Jules Bonnet, were translated into English by D. Constable, 2 vols., 1855—1857. The best edition of C.'s whole works is that of Amsterdam, 1671, in 9 vols. fol. By the 'Calvin Translation Society,' in Edinburgh, his works have been collected, translated into English, and issued

in 51 vols. 8vo, 1843—1855, a series of books procurable at a moderate price.

CALVINISM is the system of religious doctrine associated with the name of Calvin, and supposed to distinguish the churches more particularly called the Reformed, in contradistinction to the Lutheran and Anglican churches. Calvin's doctrinal views are laid down at length in his *Institutio Christianæ Religionis*, first published in 1536. It was not till many years later, however, that the name of C. came to be attached to a certain set of doctrinal opinions, and not till the rise of Arminius (q. v.) and the synod of Dort (q. v.) in 1618, that these opinions may be said to have been polemically marked off from others with which they are generally contrasted, and to which they are recognised as standing in opposition.

The difference of thought expressed in the Arminian and Calvinistic systems is as old as the history of Christian doctrine. In almost every point, Augustine may be said to have anticipated Calvin; while Pelagius and the eastern divines, such as Chrysostom, represented a type of opinion upon the whole consonant to that which in more modern times has been opposed to Calvinism. In the Roman Catholic Church, since the Reformation, the same opposition of thought has presented itself in the famous contest of Jansenism and Jesuitism.

The main point of distinction in the two systems or modes of Christian opinion, is as to the operation of divine grace in the salvation of sinners. In the one system, this operation is considered as predetermined and absolute; in the other, as merely prescient, and in some sense conditioned. *Predestination* and *Irresistible Grace* are the great key-notes of C.—its two main points. Others were added in opposition to Arminianism—viz., *Original Sin*, *Particular Redemption*, and the *Perseverance of the Saints*; but the first of these is not peculiarly Calvinistic, and the last two are merely corollaries from the doctrines of Predestination and Grace. Predestination is, in fact, the one distinguishing doctrine of the system, as it was of Augustinianism, of which C. was merely the revival. The divine will, apprehended as decretive and predestinating, is necessarily *irresistible* in its efficacy, *select* in its objects, and *persevering* in its results. The characteristic of C., therefore, is that it is a speculative Christian system, springing from a single great principle, carried out rigorously into all its logical consequences.

The Church of England, in its earlier history, was Calvinistic in its creed, although mediæval and Catholic in its ritual. Puritanism was nothing else than a movement to reduce it altogether to a Calvinistic model. In the re-action which followed this movement, the Church of England, whilst retaining its original articles, nearly parted with its Calvinistic faith; and throughout the 18th c., its chief divines are conspicuously Arminian or latitudinarian. But with the revival of the evangelical party in the end of the century, C. revived; and it still maintains, if not an absolute sway, yet a powerful influence over many minds in the Anglican establishment, while it is the professed creed of a great proportion of the dissenters.

The Church of Scotland, along with the other Presbyterian churches in this country, and the large and numerous increasing bodies of Presbyterians in America, all hold to the Westminster Confession of Faith, the most elaborate and formal expression of Calvinistic doctrine that exists. But while holding to the same Calvinistic standard, these churches shew many varieties of actual opinion; and in the history of Presbyterianism, C. has shewn a tendency in its logical development to pass into

Rationalism or Unitarianism. This is conspicuously the case in the church of Geneva itself, and some of the old Puritan churches of America. It still remains, however, as opposed to Arminian, Socinian, or any cognate forms of the same type of doctrine, the most living and powerful among the creeds of the Reformation.

CALX is the Latin term for quicklime. As quicklime is produced by burning limestone, the alchemists applied the term C. to the product obtained by burning any ore or other mineral substance; and *calcination* (q. v.) to the process.

CALYCA'NTHUS (Gr. calyx-flower), a genus of plants of the natural order *Calycanthaceæ*, an order allied to *Rosaceæ*, and of which only a few species are known, natives of North America and Japan—shrubs, with square stems, which are of remarkable structure, having around the central woody axis four smaller imperfect ones. An aromatic fragrance characterises this order. In the genus C., the bark and leaves possess it as well as the flowers. The bark of *C. floridus*, a native of Carolina, has been used as a spice and carminative, and has acquired the name of Carolina Allspice, or American Allspice. The flowers are of a chocolate colour.

CALYDONIAN BOAR. Once upon a time, according to a Greek myth, a certain Ceneus, king of Calydon, the ancient capital of Ætolia, omitted a sacrifice to Diana, whereupon the goddess, in her rage, sent into his fields a frightful boar, which committed great devastation. No one had the courage to hunt it except Meleager, the son of Ceneus, who, calling to his help the bravest heroes of Greece—Theseus, Jason, Nestor, and others—pursued and slew the monster. Later writers, however, affirm that he found it impossible to destroy the animal, until Atalanta, his mistress, aided him by piercing it with an arrow.

CALY'MENE, a genus of the fossil order Trilobites (q. v.). It differed from the other genera of the order in the individuals having the power of rolling themselves into a ball, so that they are often found

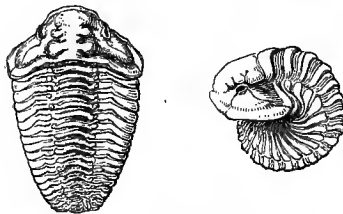

Calymene Blumenbachii.

coiled up like an oniscus, i. e., hog-louse—*vulgo*, a slater. The genus is characteristic of the Silurian formation. The species we figure has been long known as the 'Dudley Locust.' It is remarkable as a very long-subsisting species, passing from the Caradoc beds to the Ludlow rocks. Twenty species have been described.

CALYPSO, in Grecian legend, was, according to Homer, the daughter of Atlas, and inhabited the solitary wooded isle of Ogygia, far apart from all gods and men. Ulysses being thrown upon her island by shipwreck, she treated him kindly, and promised him immortality if he would marry her. He was fascinated by her charms, but unwilling to desert his wife and his native land; she detained him; however, seven years, and bore him two sons. On his departure, she died of grief.

CALYPTRÆA (Gr. *kalyptra*, a head-dress), a

genus of gasteropodous mollusks, of the order *Pectinibranchiata*, the type of a family, *Calyptreidae*, formerly included in the genus *Patella*, or Limpet, when the mere form of the shell was more regarded in classification than the structure of the animal, and still known as Chambered Limpets, Cup-and-Saucer Limpets, Bonnet Limpets, and Slipper Limpets. The shell is limpet-shaped, but the apex is more or less spiral, and has a calcareous process from its inner surface for the attachment of a principal muscle. The *Calyptreidae* differ much in shape, some being very flat, and others very conical; some elongated and slipper-like. The species are generally natives of the shores of warm climates. Only two are British.—*Calyptreidae* are common in the older fossiliferous rocks.

CALYX (a term originally Greek), in Botany, the outermost of the circles of modified leaves which surround the parts of fructification, and along with them constitute the flower. Within the C. there is generally at least a second circle of leaves, called the corolla (see COROLLA and FLOWER); but this is sometimes wanting, and the C. is the only envelope of the parts of fructification. The leaves of which

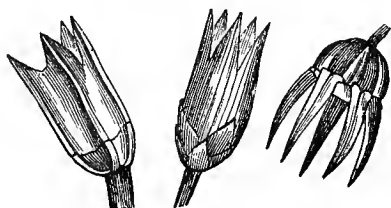

Calyx of Thorn Apple, Pink, and Campanula.

the C. is composed are called *sepals*, when quite separate from each other; but they often grow together into a tube at the base, and the C. is then said to be *monosepalous* or *gamosepalous* (*monos*, one; *gamos*, union). The sepals are generally simple and without stalks; they are generally green, and differ much less widely from ordinary leaves than the petals or leaves of the corolla; sometimes, however, they are *petaloid*, and brightly coloured, as in *Fuchsia*. The C. and corolla of many endogenous plants resemble one another almost completely, and the common term *perianth* (q. v.) is then very generally employed. In some plants, the C. passes insensibly into the corolla, and it is not easy to distinguish the innermost sepals from the outermost petals. The C. is in such cases often composed of more circles of leaves than one. The C. occasionally falls off when flowering is over (*deciduous*), as in *Ranunculus*; sometimes even when it commences (*caducous*), as in the poppy; generally it remains till the fruit is ripe (*persistent*), and is then much enlarged and more brightly coloured, as in *Physalis*. It often becomes fleshy, and forms the seeming fruit, as in the rose.—The glumes (q. v.) of grasses, &c., used to be regarded as a C., to which, however, they have no proper analogy.

CAM, or GRANTA, a river of England, which, rising in Essex, flows north-east through Cambridge-shire, and after a course of about 40 miles, joins the Ouse 3½ miles above Ely. It gives its name to the town of Cambridge, which stands upon it, and below which it is navigable, and is classic on account of the boat-races on it by Cambridge students.

CAMA'DOLITES, a religious order founded in the vale of Camaldoli, near Arezzo, in the Apennines, in 1018, by St Romuald, a Benedictine monk, and a

member of the noble family of the Dukes of Ravenna. From Italy it spread into France, Germany, and Poland. The brethren, who wear a white garment, are, and have always been, characterised for the excessive rigidity of their monastic rule; but except to shew to what lengths in a cruel mortification of natural life man can proceed, they have been practically useless in the world. The order is now almost extinct.

CAMARGUE. See BOUCHES DU RHONE.

CAMARILLA, a Spanish word, diminutive of *camara*, literally signifies a little chamber. As *camara* is used to designate, *par excellence*, the chamber of the king of Spain, the royal chamber, so C. is also used to designate his private chamber or cabinet, the place where he receives his most intimate friends, courtiers, sycophants, and all the moral refuse that naturally gathers round a weak throne. Hence, in the political language of modern Europe, it has come to signify the influence exercised on the state by secret and uncredited councillors, in opposition to the opinions of the legitimate ministry, an influence which in Spain particularly is most pernicious. The word first obtained this meaning in the time of Ferdinand VII., who was excessively addicted to the unkingly habit of listening to the insinuations of the companions of his pleasures.

CAMAYEU and MONOCHROME are terms by which painting in one colour is designated. The ancients painted thus both in gray (*en grisaille*) and in red. Pictures of several tints, but where the natural colours of the objects are not copied, are said to be *en camayeu*. As one colour generally prevails, we speak of blue, red, yellow, green *camayeu*. Polidori Caravaggio, for example, so overlaid his other colours with brown, that his works give the impression of monochrome paintings. Drawings in Indian ink, red and black chalk, pencil, &c., as well as engravings, may be said to be *en camayeu*.

CAMBACÈRES, JEAN JACQUES RÉGIS, Duke of Parma, and High Chancellor of the French Empire, under Napoleon, was born at Montpellier, October 18, 1753. In 1791, he was appointed president of the criminal court in his native place. Afterwards, as member of the National Convention, he took a prominent part in sketching the new code of laws, and distinguished himself by his moderation. He denied the right of the Convention to condemn the king, and, when this was done, argued in favour of a reprieve. After the revolution of the 9th Thermidor (July 27, 1794), C. was elected president of the Convention, and, as head of the Committee of Public Safety, was active in procuring peace with Prussia and Spain. His enemies having succeeded in expelling him from office, he engaged himself in legal studies, and laid before the council of Five Hundred the sketch of a civil code which afterwards formed the basis of the *Code Napoleon*. In 1796, C. was for a short time made president of this council. After the changes made in the Directory, he was made Minister of Justice, assisted in the revolution of the 18th Brumaire (November 9, 1799), was made Second Consul, and faithfully attached himself to the interest of Napoleon, by whom he was raised to the office of High Chancellor of the Empire, and in 1808 was made Duke of Parma. He endeavoured to dissuade Napoleon from the projected invasion of Russia, but in this instance his advice was vainly given. In 1813, when Napoleon took the field against the allies, C. was left as president of the regency, and in this capacity accompanied the empress to Blois, 1814. From this place he sent to Paris his vote for the abdication of Napoleon. During the Hundred Days,

against his own will, he was made Minister of Justice, and President of the Chamber of Peers. After the second restoration, C. lived privately in Paris for some time; but in 1816, was exiled for having taken part in the execution of Louis XVI. In 1818, his civil and political rights were restored, and he returned to Paris, where he lived retired to the time of his death, March 5, 1824. Among the men of the Revolution, C. was one of the few whose activity was peaceable and truly progressive. His services in the establishment of law were great. His nature was mild and candid, and his intellect very acute.

CAMBAY', a city, district, and gulf at the north-west extremity of the peninsula of Hindustan.—1. C., the city, stands at the head of its gulf, and on the right bank of the Myhee, in lat. 22° 18' N., and long. 72° 39' E., being 76 miles to the north-north-west of Surat. It contains about 10,000 inhabitants, having been at one time much more populous—ruinous palaces, mosques, and tombs, and an excavated temple of considerable pretensions, attest its former magnificence and extent. The main cause of its decay has been the gradual obstruction of its seaward navigation. It still exports grain, cotton, and ivory, besides its renowned manufactures in bloodstone and carnelian.—2. C., the district, contains an area of 500 square miles, stretching in N. lat. from 22° 9' to 22° 41', and in E. long. from 72° 20' to 73° 5'. It is attached to the presidency of Bombay, though under the immediate government of a nabab of its own.—3. C., the gulf, extends in N. lat. between 21° and 22° 10', and in E. long. between 71° 50' and 72° 40', measuring 80 miles in length, and averaging 25 in breadth. In proportion to its size, it receives a vast quantity of fresh water—on the west, the Gooma, Oolowtee, Gelya, and Setroonjee; on the north, the Saburmuttee and Myhee; and on the east, the Nerbudda and the Taptee. The inundations of so many rivers, and the ebb and flow of tides, which fall and rise 30 feet, conspire not only to elevate the bottom, but also to generate movable quicksands.

CAMBER, in Ship-building, implies a slight arching or convexity upwards. A 'cambered' ship is one in which the floor is higher in midships than at the stem and stern.—The name 'camber' is also given to a small dock in a dockyard, for containing boats, and for loading and unloading timber.

CAMBERWELL, once a rural village, now a suburb of London, on the south side of the Thames.

CAMBERWELL BEAUTY (*Vanessa Antiope*), one of the largest and most beautiful British butterflies, rare in Britain, although it has been found in many parts of the country, but common in the central and southern parts of Europe. The wings are of a deep brown colour, with a band of black around the brown, and an outer band or margin of pale yellow, the black band containing a row of large blue spots, the yellow margin dappled with black specks, all the colours rich and velvety. The margin of the

wings exhibits tooth-like angularities. The antennæ are terminated by a knob. The caterpillar feeds on the willow. It is black, with white dots and a row of large red spots down the back, and is rough with soft spines.—When Camberwell was more rural than now, and abounded in willows, this butterfly was sometimes taken there.

CAM'BIO, CAM'BIST. The former of these two words is the Italian for *exchange*; the latter, for a *money-changer*. *Cambist* is also used figuratively as the title of a book in which the moneys, weights, measures, &c., of various nations are given in the equivalents of some particular one. For instance, Kelly's *Universal Cambist* gives these in English, and the *Cambista Maltesa* in Italian.

CAMBIUM (Lat. *cambio*, to change), in Botany, a layer of mucilaginous viscid matter, particularly abundant in spring, interposed between the woody layers and the bark of trees and other stems. Delicate cells (*Cambium cells*) are formed in it, which certainly fulfil important functions in the formation of new wood, although, notwithstanding much investigation by some of the greatest vegetable physiologists of our time, the nature of these functions is still very imperfectly ascertained. The medullary rays are connected with the C. cells, and these cells gradually elongate into the shape which belongs to those of woody tissue. The C. layer is found only in exogenous stems.

CAMBO'DIA, or CAMBO'JA (native name, *Kan-pou-chi*), an extensive country of the Indo-Chinese Peninsula, formerly independent, but now (excepting the province of Batabang, which belongs to Siam) forming a part of the Empire of Anam, to which it was united in 1809. It extends from 8° 47' to 15° N. lat., along the basin of Ma-kiang or Camboja River; and is bounded on the N. by the Laos country, on the E. by Cochín-China, on the S. by the Gulf of Siam and the China Sea, and on the W. by Siam. See COCHIN-CHINA.

CAMBO'GE. See GAMBOGE.

CAMBORNE, a town of Cornwall, 11 miles north-west of Falmouth. It is surrounded by very productive copper, tin, and lead mines. C. church has a stone inscription of the 10th century. Pop. 6547.

CAMBRAI, a city of France, in the department of the Nord, about 32 miles south-south-east of Lille. It is situated on the right bank of the Scheldt, is strongly fortified and well built, with tolerably wide, but irregular streets, and many picturesque old houses. The cathedral, archiepiscopal palace, town-house, and theatre are among the principal public buildings. The city was greatly injured in 1793, when the revolutionists, among other vandalisms, razed the fine cathedral. They also disinterred the remains of Fénelon, who was archbishop here, and melted his lead coffin into bullets. A monument, however, by David the sculptor was erected (1825) in the new cathedral, in memory of the immortal author of *Télémaque*. The manufactures of the city are important, consisting of cambric—so called from its manufacture here—linen-thread, lace, cotton-yarn, beet-root sugar, soap, starch, leather, &c. It has also a trade in agricultural produce. Pop., exclusive of garrison and government officials, 18,000.

C. was known to the Romans under the name of *Camaracum*, and it was then one of the chief cities of the Nervii. It was fortified by Charlemagne, and was long governed by its own bishops, to whom Charles the Bald ceded it. The celebrated league against the republic of Venice, which comprised the pope, the emperor of Germany, and the kings of France and Spain, was entered into here in 1508,



Camberwell Beauty:

a, larva or caterpillar; b, pupa;
c, perfect insect.

the colours rich and velvety.

and takes its name from the city. Here also were concluded treaties between the French king and the German emperor in 1529, and in 1724—1725 between Charles VI. and Philip V. of Spain. During 1815—1818 it was the head-quarters of the British army of occupation.

CAMBRIA, the ancient name of Wales, the *Britannia Secunda* of the Romans. The name is derived from that of *Cimbri* or *Cymri*, by which the Welsh have always called themselves. See **BRETTIS AND SCOTS**.

CAMBRIAN ROCKS, the name given by Professor Sedgwick to the oldest known fossiliferous rocks, on account of their extensive development in North Wales. Their true limits have been the subject of considerable controversy. When Sedgwick first described them, they were considered inferior to the Silurian measures. Subsequent examination has shewn that they are the equivalents of rocks previously described by Murchison as Lower Silurian; and accordingly, geologists generally, following the classification of the government geological surveyors, confine the term to an extensive series of gritstones, sandstones, and slates, which underlie the Silurian *Lingula* beds. In Anglesea, these rocks have been metamorphosed in one place into chlorite and mica schists; in another, into gneiss, and all traces of organisms have been destroyed. In North Wales they are less altered, but have as yet proved unfossiliferous. In the Longmynd (Salop), there is an apparent thickness of 26,000 feet, which may be, however, owing to folds in the beds. A few fossils have been noticed here, consisting of a fucoid plant or two, the tracks of annelids, and the fragments of a supposed trilobite, called *Palæopyge Ramsayi*. In Ireland, similar rocks occur, containing two species of a small branched zoophyte, named *Oldhamia*, and numerous tracks and burrows of sea-worms.

CAMBRIC, a general term applied to the finest and thinnest of linen fabrics. It is said to be derived from *Cambral*, where such goods were first made. Some of the finest cambrics of the present day are produced in Switzerland. Scotch C. is really a muslin, being made of cotton with the fibre twisted very hard, to imitate real or linen cambric.

CAMBRIDGE, the chief town of the county so named, lies 48 miles north-north-east of London. It takes its name from the river *Cam*, which was anciently called the *Granta*. By the Saxons, C. appears to have been known as **GRANTABRYCGE**, which is found with many slight variations of spelling, and probably became abbreviated into **CANTBRIDGE**. It is also supposed that C., and not the adjacent village of *Grantchester*, was the **GRANTACEASTER** of the Saxons. There are, however, traces of a camp at *Grantchester*. In 870, the Danes ravaged the country hereabouts, and are said to have destroyed the town. King John, in the second year of his reign (1200 A. D.), granted a charter to the town, permitting it to have a guild of merchants, and in 1207, confirmed the burgesses in their privileges in perpetuity. In 1225, they paid a fine of 50 marks for having their liberties; and in 1227, Henry III. confirmed their charters. The town has sent two members to parliament from the earliest period. The university sends two members of its own. The population, in 1841, including the members then living in college, was 24,453, and in 1851 it was 27,815. There are 14 parishes, and as many churches, none of which are remarkable for their beauty. The most curious is that of the Holy Sepulchre, which is one of the few in England that have a round tower. The town is not generally pretty or picturesque, but the gardens at the

backs of the colleges, by the *Cam*, are extremely beautiful in the summer months. Its architectural features depend chiefly on the college and university buildings.

CAMBRIDGE, UNIVERSITY OF, one of the two ancient institutions of the kind existing in England. Overlooking several fabulous accounts of its origin, its true history may be said to begin at the opening of the 12th century. It was in 1110 that *Joffrid*, Abbot of *Croyland*, sent over to his manor of *Cottenham*, near Cambridge, *Gislebert*, his fellow-monk and professor in divinity, with three other learned monks. These came over to Cambridge, and in a hired barn taught their sciences, and in a short space of time drew together so great a number of scholars, that in the second year of their coming no single building was able to contain them. Perhaps even this statement is doubtful. At any rate, when *Alfred* of *Beverley* was student here—viz., 1129 A. D.—there were as yet no public halls or hostels, but each one lived in his own hired lodging.

The first regular society of students was that of *Peterhouse*, founded in 1257. About this time, students began to live together in hostels, under the rule of a principal, at their own charges. These hostels were named after the saints to whom they were dedicated, the churches which they adjoined, or the persons who formerly built or possessed them. In the year 1280, there were as many as 34, and some of them contained from 20 to 40 masters of arts, and a proportionate number of younger students; but all these hostels decayed by degrees when endowed colleges began to appear. *Trinity* hostel survived all the rest, and continued to 1540. The hostels were the beginning of what may be called the *college system*, which distinguishes the sister-universities of Oxford and Cambridge from those of Edinburgh, London, and the continent. See **UNIVERSITIES**.

It was between the latter part of the 13th and the close of the 16th century that all these royal and religious foundations were endowed which now constitute the university. *Hugh de Balsam* has the honour of being the first benefactor in this way. *Michael House* was founded by *Hervey de Stanton* in 1324, and *King's Hall* by *Edward III.* in 1332, both of which were absorbed into *Trinity College* by *Henry VIII.* in 1546. *Clare Hall*, as it used to be called, one of the earliest, and now one of the prettiest colleges in Cambridge, was founded by the *Countess of Clare* in 1326. *Henry VI.* has left himself an imperishable monument in the splendid foundation of *King's College*; and his queen, *Margaret*, commenced the foundation of *Queens' College*, which was added to by *Elizabeth Widville*, queen of *Edward IV.* *Lady Margaret*, *Countess of Richmond* and *Derby*, mother of *Henry VII.* founded *Christ's College* and *St John's* at the beginning of the 16th c., and also the *Divinity Professorship* named after her. *Henry VIII.* appropriated part of the spoils of the monasteries to the foundation of *Trinity College*, and *Queen Mary* augmented the endowment. The five *Regius Professorships* were endowed by *Henry VIII.* Cambridge was frequently visited by the plague, and university proceedings were suspended by it in 1642 and 1666. In 1643, *Cromwell* took possession of the town, and the most eminent loyalists were expelled from the university. Almost all the colleges had sent their plate to the king at *Nottingham*. As might be expected, little was done for the university in this troubled century; indeed no new colleges were added until the founding of *Downing College* in 1800.

The predominance of the religious element in the college-discipline is to be attributed as much to the circumstances and manners of the times in which

the colleges were founded, as to the piety of the founders themselves. There had been, from very early times, 'Religious Houses,' and these were in many cases united with the new collegiate foundations. There were, for example, the Dominicans, or Preaching Friars, whose house is now turned into Emmanuel College. The friars who lived in these convents were capable of degrees, and kept their 'acts,' or exercises for degrees, as other university men. There were, however, frequent quarrels between them and the other students. To the same cause is to be traced the condition of celibacy, upon which, with scarcely any exception, the fellowships are tenable; the masters of colleges, however, may all marry. There is a disposition amongst some members of the university to procure a relaxation of this rule. With the exceptions of Trinity Hall and Downing College, some members of King's, and a few at other colleges, the fellows are obliged to take holy orders within a limited period, or to vacate their fellowships.

The present university statutes were confirmed by Queen Victoria, by order in council, July 31, 1858. The governing body is the senate, and the building where they meet is called the senate-house. All university laws are approved by an elected body called the council, before they are submitted to the senate. The executive powers are intrusted to a chancellor, high-steward, vice-chancellor, commissary, and assessor. The public orator is the voice of the senate upon public occasions. The proctors superintend the discipline and morals of all persons in *statu pupillari*; they are present at all congregations of the senate, read the 'graces,' and take the votes. The registry is responsible for the graces being offered in due form, and has charge of the university records. There are three terms in this university—the Michaelmas or October term, the Lent term, and the Easter term. To take an ordinary B.A. degree, a student must reside nine terms. The M.A. degree follows three years after. Dissenters are not excluded by the terms of the new statutes from taking degrees, except in divinity.

With respect to the admission of students, their university course, expenses, and proceedings in degrees, the following information may be useful: There are four classes of students—viz., *Fellow Commoners* and *Noblemen*, *Pensioners*, *Sizars*, and the more distinguished students who are elected *Scholars* on the foundation of their college. The first class are so called from their dining at the Fellows' table; they wear silk or embroidered gowns, and pay heavier fees. The Pensioners are the great body of students who are not on the foundation, and who pay for their own commons, viz., dinners in hall, &c., and for their chambers. The Sizars are the poorer students, who are admitted at lower charges than the pensioners, but wear the same dress, and are no longer subject to the performance of menial offices as they once were. Some of the colleges, especially St John's and Trinity, have very liberal endowments for the sizars, and very considerable pecuniary assistance is given to the more deserving of them, so that no youth of real ability, industry, and good character, need be deprived by poverty of the advantages of a university education. All students coming to the university are entered in one of these three classes. The Scholars are elected, by examination, from the pensioners and sizars; they are on the foundation of the college, have rooms and commons free, and other emoluments. The fellows are subsequently elected from the scholars, though there are exceptions to this rule. At Cambridge, the fellowships are generally confined to members of the college, and are not, as at Oxford, open to

the competition of the whole university. The usual age of admission is from 17 to 20. Before a student can be admitted, he must obtain a certificate from some master of arts of the university of being sufficiently instructed in Latin, Greek, and Mathematics; this certificate must be sent to the tutor of the college, with the caution-money, which in the case of a pensioner amounts to £15. At some colleges there is an examination previous to matriculation in addition to the above.

Residence is commenced in the October Term. It is usual, particularly at the larger colleges, to have the name entered on the college boards for a term or two previous; but this is not necessary now, as it used to be, in order to *keep* such terms with a view to the degree. When the undergraduate comes into residence, he is called a 'Freshman;' in his second year, a 'Junior Soph;' in his third year, a 'Senior Soph.' The ordinary B.A., or Bachelor of Arts degree, may be taken in the ninth term of residence—viz., in the third June after coming up. The subjects of examination are partly fixed, partly variable. They are the Acts of the Apostles in Greek, one Greek and one Latin classic, *The History of the English Reformation*; *Euclid*, Books i., ii., iii., iv., and Propositions 1–6 of Book vi.; together with certain parts of Algebra, Mechanics, and Hydrostatics. The candidates for examination for degree are called Questionists.

Candidates for mathematical 'honours' do not go up till the end of their tenth term—i. e., the Christmas three years after coming up. The examination embraces the whole range of pure mathematics, and mathematics as applied to natural philosophy. The successful candidates are arranged in a *Tripes*—i. e., in three classes, called respectively Wranglers, Senior Optimes, and Junior Optimes; the first mathematician of the year is called the Senior Wrangler. The Smith's Prize Examination for the best mathematician sometimes reverses the decision of the *tripos*.

The examination for classical 'honours' is one term later still, and the candidates are arranged in a *tripos*, and distinguished as First, Second, and Third Class. Very accurate scholarship is required to obtain a good place in this *tripos*. The examinations for degree are called 'Great Go.' The previous examination, which comes in the second year of residence, is called 'Little Go.' Students who intend to graduate in classical honours, are required to take mathematical honours in Little Go. The previous examination is one Greek and one Latin author, one of the Gospels in Greek, Paley's *Evidences of Christianity*, and Elementary Mathematics. There are lectures in the colleges and examinations every year, which the students are obliged to attend, and which prepare them for the university examinations. Questionists, who are not candidates for honours, must produce certificates of having attended and passed an examination in one course of lectures from one of the following university professors: Regius Professor of Laws, Regius Professor of Physic, Professor of Moral Philosophy, Professor of Chemistry, Professor of Anatomy, Professor of Modern History, Professor of Botany, Professor of Geology, Jacksonian Professor of Natural Philosophy, Downing Professor of the Laws of England, Downing Professor of Medicine, Professor of Mineralogy, Professor of Political Economy. Besides these, the university has Regius Professors of Greek, Hebrew, and Divinity. There are also a Lady Margaret and a Norrisian Professor of Divinity, two Arabic Professors, the Lucasian Professor of Mathematics, and the Lowndes's Professor of Astronomy. The university is about to confer degrees in Natural and Moral Science, without requiring further

proficiency in the normal studies of the place, classics and mathematics, than is ascertained by passing the Little Go. The fees for the different degrees will all be found in the *Cambridge Calendar*. There are different fees at the different colleges in addition to the university fees. It will be sufficient to state, that for the B.A. and M.A. degrees, the fees amount to about £12 and £25 respectively.

The great prizes at the university are the *Fellowships*, of which there are not less than 430 tenable for life, though in most cases subject to the condition of taking holy orders within a limited period. Their value varies from £100 to £300 per annum, and the Senior Fellowships are often £500 or more. There are also stipends attached to all the college offices—e. g., those of Dean, Bursar, Steward, &c. The office of Tutor is one of great honour and emolument. The Chancellor gives annually two gold medals to the two commencing bachelors, who, having taken a senior optime's degree in mathematics, shew themselves the greatest proficient in classical learning. The Members of Parliament for the university give annually four prizes for the best dissertations in Latin prose. There are numerous other university distinctions, both scholarships and of other kinds, for an accurate account of which the *Cambridge Calendar* should be consulted.

In November 1859, the resident members of the university amounted to 1652; and of these only one-half lived in college; the matriculations in that year were 398.

The following is a list of the colleges in the order of their antiquity. A particular notice of each college will be found in its alphabetical place.

Name.	Founded.	Residents in 1859.
St Peter's College, or Peter-house,	1257	41
Clare College,	1326	51
Pembroke College,	1347	35
Gonville and Caius College,	1348	142
Trinity Hall,	1350	81
Corpus Christi, or Benedict College,	1351	67
King's College,	1441	29
Queens' College,	1448	40
St Catharine's College or Hall,	1473	37
Jesus College,	1496	43
Christ's College,	1505	115
St John's College,	1511	248
Magdalene College,	1519	42
Trinity College,	1546	525
Emmanuel College,	1584	108
Sidney Sussex College,	1598	35
Downing College,	1800	8

To these may be added a Hostel, opened in 1859 by an eminent surgeon, Dr Humphry, for the reception of medical students.

Few of the colleges present an imposing façade to the streets—King's is, perhaps, the only one of which this may be said—but the quiet and picturesque beauty of the courts in the interiors is very pleasing. Dr Whewell, the Master of Trinity College, has lately built a new hostel in connection with Trinity, which is considered to be in very good taste. Amongst the other public buildings of Cambridge are to be mentioned the Senate-house, where university examinations are held, degrees conferred, and all public business of the university conducted. The Fitzwilliam Museum is the finest of the modern additions to the university. Viscount Fitzwilliam bequeathed, in 1816, £100,000 South-sea Annuities, the interest of which was to build and support a museum. He left also a very valuable collection of hooks, paintings, &c., as a nucleus for future contributions. G. Basevi was the architect. The University Library is a fine mass of buildings of different periods, and contains at present more than 170,000 volumes. The Geological Museum contains the original collection of Dr Woodward, which, out of respect to the founder, has been kept in its original

state, unmixed with more recent and vastly more numerous and interesting acquisitions. The university is indebted for many of these geological treasures to Professor Sedgwick. The Mineralogical Room contains the valuable collections of the late Sir A. Hume, Charles Brooke, and Henry Warburton. The Pitt Press is a Gothic structure built in honour of Mr Pitt, who was educated at Cambridge. It contains the university printing-offices, which are very extensive, and well conducted. There is also a good Anatomical Museum.

There is a very good hospital, founded under the will of Dr Addebrooke in 1753. The Observatory contains some very fine instruments, amongst which is to be noted a large equatorial telescope, presented by the Duke of Northumberland in 1835. The object-glass is 12 inches in diameter, and 20 feet focal length.

For the most recent information about the university studies, &c., the *Cambridge Calendar* for the current year should be consulted; for the history, biography, and antiquity, see Fuller's *History of Cambridge*; Dyer; Caius; Le Keux' *Memorials*; Cooper's *Annals*; Cooper's *Athenæ Cantabrigienses*; *Graduati Cantabrigienses*.

CAMBRIDGE, a town of the state of Massachusetts, on the Charles River, 3 miles to the north-west of Boston (q. v.). Here, in 1638, within eighteen years after the landing of the Pilgrim Fathers, was founded Harvard University by the Rev. John Harvard, who bequeathed it a legacy of about £780, and which has gradually been endowed to the amount of 1,000,000 dollars, so that its vested income must be at least 60,000 dollars or £12,000. The oldest, it is also generally considered the best, institution of the kind in America. In addition to the collegiate department proper, the university includes a theological school, a law school, a medical college, and a department for such as wish to prepare themselves for business avocations without going through a classical course. In 1852 the alumni amounted to 6342. The town of C. is rapidly advancing in population, the census in 1830, 1840, and 1850 respectively having been 6072, 8409, and 15,215.

CAMBRIDGESHIRE, an inland county of England, in lat. 52° 1'—52° 45' N., long. 0° 31' E., and 0° 16' W. Its greatest length, from north to south, is about 50 miles, and its breadth 30 miles, with an area of 857 square miles. Pop. 185,405. About three-fourths of the county consists of arable land, meadow, and pasture, the rest being fens. The surface of C., except in the south, which is somewhat elevated and on the chalk formations, is marshy and flat, thinly wooded, and with villages and churches here and there on slight elevations, called 'eys' or islands. The upper greensand, which in some places near Cambridge comes to the surface, yields in rich abundance the curious fossils miscalled coprolites (q. v.), which are of great value as an artificial manure. Their value is in some places equal to that of the land itself. The northern part of C. forms part of the Bedford Level. The chief rivers are the Ouse, which crosses the middle of the county from west to east, with its tributary the Cam; the Nene, which borders the county on the north; and the Lark. These are all navigable to a certain extent. C. is an agricultural county. In the higher parts, the land produces fine crops of beans and wheat. Many cattle and sheep are now supported on the thin chalky soils. The black spongy soil of the fens consists of mud mixed with decayed vegetable matter, and when drained and burned, produces, in dry years, heavy crops of cole-seed, wheat, oats, barley, hay, potatoes, hemp, and flax. Horses, cattle,

sheep, and pigeons are also reared in the fens. The unreclaimed fens yield peat, osiers, reeds, and sedges for thatching, and lighting fires. The Isle of Ely, part of the fen-tract, and within the Bedford Level, is famed for garden vegetables; and the meadows of the Cam yield fine butter and cream-cheese. The chief towns of C. are Cambridge, the county town; Ely, Wisbeach, March, Thorney, Linton, Soham, Newmarket, and Royston. In 1851 there were in C. 586 day-schools, with 24,329 scholars; churches, 404 (176 Church of England, 101 Wesleyan Methodist). C. returns 3 members to parliament. This county was anciently the seat of a powerful tribe—the Iconi. It was crossed by several British and Roman roads, in some parts now covered by several feet of peat-soil. Remains of Roman camps, sea-bankments, and villas, occur, and Roman antiquities, as coins and urns, have been found. There are some ancient—supposed pre-Roman—ditches miles in length. One of these, the Devil's Ditch, with an elevated vallum, having a slope of 52 feet on one side and 26 feet on the other, is about 100 feet broad. In the 9th and 10th centuries, C. was the scene of severe contests between the Danes and Saxons. The Isle of Ely and its monks withstood William the Conqueror for 8 years. C., and especially the Isle of Ely, suffered much in the civil wars of Stephen, John, Henry III., and Charles I. There formerly existed 36 religious houses in Cambridgeshire. Since Charles I.'s time, much has been done to reclaim the flooded fen-lands by embanking rivers, cutting new channels for them, and pumping water. Ague formerly prevailed in the fens, but drainage has much diminished its frequency.

CAMBYSES, second king of the Medes and Persians, was the son of Cyrus and Cassandane, and succeeded his father in the monarchy, 529 B.C. C. is the Greek form of his name, the ancient Persian name is Kabujiya. In 525 B.C., C. invaded Egypt, defeated Psammenitus, the king of Egypt, at Pelusium, and in six months made himself master of the whole country. He meditated further conquests, but was not permitted to carry his designs into effect; the Tyrians, upon whom his maritime power depended, refused to serve him against the Carthaginians; an army which he sent to take possession of the temple of Jupiter Ammon, perished in the desert; and one which he led in person against the Ethiopians, was compelled to return from want of provisions. C. now addicted himself to excessive intoxication, and perpetrated horrid cruelties in Egypt; the accounts of which, however, depending upon his enemies the Egyptian priests, are doubtless exaggerated. It is probable, however, that his tendency to epileptic fits, along with the arbitrary disposition induced by success and power, caused him to indulge in violent and capricious acts of tyranny. The Egyptians believed him to be mad. A pretender to the Persian throne having appeared, C. marched against him, but died on the way in Syria, 521 B.C.

CAMDEN, CHARLES PRATT, EARL OF, a younger son of Sir John Pratt, Chief Justice of the Court of King's Bench in the reign of George I., was born in 1714. Educated at Eton and Cambridge, he studied for the law, and was called to the bar in 1738. Not until 1752, however, when he defended a bookseller successfully against a government prosecution for libel on the House of Commons, did C.'s prospects appear very promising; from this time his success was certain. In 1757, he was appointed Attorney-general, and four years afterwards, accepted a seat on the bench in the Court of Common Pleas. Judge in the trial of Wilkes, he declared his opinion emphatically that the action of

government in this case, by general warrants, was altogether illegal—an opinion which, chiming in with public sentiment at the time, made him the most popular of judges. In 1765, he was created Baron C. of Camden Place, Kent, by the Rockingham administration; to whose American policy, and to their treatment of Wilkes, notwithstanding, he offered constant opposition. The following year, when he was made Lord Chancellor, he did not abandon his principles; and four years after—the Duke of Grafton being then prime minister—he supported an amendment made by Chatham on the government address, and resigned his place. His judicial career ended here; henceforth, he was entirely a political character, and for more than 20 years took an active part against the ill-advised American policy pursued by Lord North, and in discussions on the law of libel, in which he maintained the popular view. As a judge, he is held in high estimation, though his manner was somewhat undignified. He filled the office of President of the Council in the Rockingham administration in 1782, and also from the following year until his death, under Pitt. He died April 1794.

CAMDEN, WILLIAM, one of the most distinguished scholars and historians, and the most laborious and painstaking antiquary of the 16th c., was born in London, where his father was a paper-stainer, in May 1551. His education, commenced at Christ's Hospital, was completed at St Paul's School, and at Oxford. In 1575, he was appointed second master of Westminster School; and it was while discharging the duties of this office that he undertook the work which has made his name famous, his *Britannia*, giving an account of the British Isles from the earliest ages, which, written in elegant Latin, was first published in 1586. It at once brought him into communication with the learned men of his time. Before 1607, the work had passed through six editions, being greatly enlarged and improved by the indefatigable industry of the author. The book, at first but a comparatively small single volume, has received much additional matter from other writers. The best known edition of C.'s *Britannia*, is that of Edmund Gibson, in English, 2 vols. fol. Of this great work of C., Bishop Nicolson said it was 'the common sun whereat our modern writers have all lighted their little torches.' In 1593, C. was appointed head-master of Westminster School; and four years later, he was made Clarencieux King-at-arms, an appointment which gave him more time for the pursuit of his favourite studies. His other most important works are—*Annals of the Reign of Elizabeth*; *A Collection of Ancient English Historians*; *An Account of the Monuments and Inscriptions in Westminster Abbey*; and *A Narrative of the Gunpowder Plot*. He died in 1623, at the age of 72, and was buried in Westminster Abbey. Before his death, he endowed a professorship of history at Oxford. The 'Camden Society,' for the publication of early historical and literary remains, is so named in his honour.

CAMEL (*Camelus*), a genus of quadrupeds of the order *Ruminantia*, of which only two species exist, both of great use to mankind. This genus is the type of the family *Camelidae*, to which there belongs only one other genus, *Auchenia* (q. v.), including the llama, alpaca, &c. The whole number of species of *Camelidae* is, therefore, very small, and they seem to belong originally to limited regions, both in the Old World and in the New. To the peculiarities of those regions, they exhibit a wonderful completeness of adaptation. The family is regarded as forming a sort of link between the orders *Ruminantia* and

CAMEL.

Pachydermata. The dentition differs from that of all other ruminating animals, particularly in the presence of incisors or cutting teeth in the upper jaw; camels having also canine teeth in both jaws, and the llama and its congeners in the lower jaw of both sexes; and differences equally important appear in the feet, which have not the cloven hoof common to all the rest of the order—two short toes with separate hoofs adapted to one another—but two elongated toes, each tipped with a small nail-like hoof, the feet resting not upon the hoofs, but upon elastic pads or cushions under the toes.—In the camels, the toes are united by a common sole, thus resting upon one extended pad, instead of having each a separate one, as in the genus *Auchenia*; the broader expanse of the foot enabling the animals of the one genus more easily to traverse the loose sand of the desert, whilst the separation of the toes in the other is suited to the uneven surface of rocky heights. The camels are also distinguished by the females having four teats, whilst those of the other genus have only two; and by a hump or humps upon the back, of which the llama and its congeners exhibit no trace. The long neck, small head, prominent eyes, and tumid and cleft upper lip, with considerable prehensile power, are common to both genera; but with much similarity of form, as well as of particular characters, the *Camelidae* of the Andes exhibit a gracefulness of outline which strongly contrasts with the gaunt angularity of those of the eastern deserts. Camels are indeed animals of uncouth appearance. Of the two species, that known as the Arabian C. (*C. Dromedarius*) has only one hump on the back, whilst the Bactrian C.

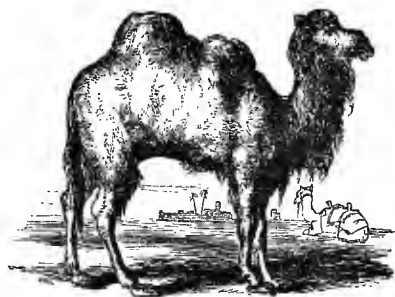

Bactrian Camel.

(*C. Bactrianus*) has two. Some confusion has arisen from the occasional employment of the name Dromedary as a designation of the former species, it being, however, more properly limited to a particular variety of that species, more slender and graceful than the ordinary variety, and of much greater fleetness. Buffon's notion, that the hump is a badge of servitude, and the consequence of harsh treatment throughout many generations, is singularly at variance with what we know of its uses. The hump on the C.'s back is a wonderful provision of nature, to adapt the animal to the endurance of long abstinence from food, or subsistence on very scanty supplies, to which it is often subjected in the desert, and without a capacity for which it would be comparatively of little value to man; and the wide deserts across which he journeys and transports his merchandise by its aid, would be altogether unpassable. The hump is, in fact, a store of fat, from which the animal draws as the wants of its system require; and the Arab is very careful to see that the hump is in good condition before the commencement of a journey. After it has been much exhausted, three

or four months of repose and abundant food are necessary to restore it. The backbone of the C. is as straight as that of other quadrupeds.—Another very interesting adaptation to the desert is to be noticed in the thick sole which protects the feet of the C.

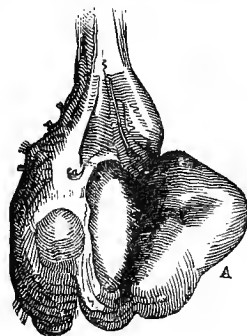

Inside of a Camel's Foot :

A, is the cushion on which the animal treads, shewn as lifted out of its bed.

from the burning sand, and in callosities of similar use on the chest and on the joints of the legs, upon which the C. rests when it lies down to repose, or kneels, as it does for various purposes, and is taught to do that it may be loaded, or that its rider may mount upon its back.—The wedge-shaped cutting-teeth of the lower jaw are also particularly fitted for browsing on shrubby plants, such as the desert produces—the camel's thorn, tamarisk, &c., which form a large part of the food of the C.; the eyes are furnished with long eyelashes, to protect them from the glare and from the drifting sand; whilst the exclusion of the sand from the nostrils is also provided for by a power of closing their oblique openings at will. But most interesting of all is the provision made for the C.'s endurance of long drought, by the lining of the inside of the second stomach, or honey-comb bag, and of a portion of the first stomach or paunch, with great masses of cells, in which water is stored up and long retained. This store of water is well known to the Arabs, who, when sore pressed by thirst, sometimes avail themselves of it by killing some of the camels of the caravan.—The first stomach of the *Camelidae* is divided into two compartments by a muscular band—one of the points of difference between them and the other ruminants. Muscular bands, proceeding from this principal one, and intersected by other muscular bands, nearly at right angles, form the cells for containing water. It may be added here, that the senses both of sight and smell are extremely acute in the C., and that it is capable of discerning water at a great distance.

The Arabian C. carries twice the load of a mule. The Bactrian C. is sometimes loaded with 1000 or even 1500 lbs. weight, although not generally with so much. The East India Company had at one time a corps of camels, each mounted by two men, armed with musketoons. The use of the C. for the conveyance both of travellers and merchandise has won it the name of the *ship of the desert*. A caravan sometimes contains 1000, sometimes even 4000 or 5000 camels. The supply of food carried with the caravan for the use of the camels is very scanty: a few beans, dates, carob-pods, or the like, are all that they receive after a long day's march, when there is no herbage on which they may browse. The pace of the loaded C. is steady and uniform, but slow: it proceeds, however, from day to day, accomplishing

journeys of hundreds of miles at a rate of about 2½ miles per hour. Some of the slight dromedaries, however, can carry a rider more than 100 miles in a day. The motion of the C. is peculiar, jolting the rider in a manner extremely disagreeable to those who are unaccustomed to it; both the feet on the same side being successively raised, so that one side is thrown forward, and then the other.

The C. produces only one young one at a time, or rarely two. It lives 30 or 40 years.

The patience of the C. has been celebrated by some authors; and the cries by which it expresses its sense of injury when a heavy load is placed upon its back have been pathetically described. With all its general submissiveness, however, the C. is resentful of injury, and during the rutting season it becomes particularly vicious.

The flesh and the milk of the C. are much valued by the Arabs as articles of food. The dung is used for fuel, and it was from the soot of this dung that the sal-ammoniac, formerly imported from Egypt, was obtained by sublimation, whilst the sources from which that substance is now procured were unknown. The hair is used for the manufacture of cloth, some kinds of which are coarse, and others comparatively soft and fine. C.'s hair is also imported into Europe for the manufacture of the pencils or small brushes used by painters.

The C. can now scarcely be said to exist anywhere in a wild state.

A fossil species of C. (*C. Sivalensis*), larger than either of the existing species, has been discovered in the tertiary deposits of the Sewalik Hills, in Hindustan.

CAMELFORD, a village in the north-west of Cornwall, near the source of the Camel (crooked brook), 14 miles west of Launceston. It lies in a high and hilly tract near the moors. Pop. 705. C. is said to have been the scene of a battle, in 542, between King Arthur and Mordred, his nephew, when both were slain. The West Saxons, under Egbert, had a battle with the Britons here in 823. The ruins of King Arthur's Castle, Tintagel, stands on the high rocky coast, 4 miles north-west of Camelford. Two miles north of C. are the celebrated slate-quarries of Delabole, employing 1000 men. Macpherson, the author or translator of Ossian, was member of parliament for C. in 1791, but the Reform Act of 1832 disfranchised the borough.

CAMELLIA, a genus of plants of the natural order *Ternstroemiaceae* (q. v.), natives of China, Japan, and the north of India—some of which are now among the most common and admired greenhouse shrubs in Britain and other countries too cold for their cultivation in the open air, receiving the same sort of attention which is bestowed on other florists' flowers, and with the same result, of an endless multiplication of beautiful hybrids and varieties. The best known and most esteemed is *C. Japonica*. Its leaves are ovate-elliptical, almost acuminate and serrate, shining; the flowers without stalks, mostly solitary, large, and rose-like. It is a native of Japan; and there and in China it has been carefully cultivated from time immemorial. In its wild state, it has red flowers; and the red single C. is much used by gardeners as a stock on which to graft the fine varieties, the flowers of which are generally double, and in many cases most completely so. Many of them are of Chinese or Japanese origin; many have been raised by cultivators in Britain, continental Europe, and America. Their colours are very various; and the varieties also differ much in the form and position of the petals. It adds to the value of the C. that its flowering time is in autumn, winter, and spring. By those

who can afford the expense, entire houses are often devoted to the culture of camellias. Some cultivators are careful to protect them from direct sunshine, others recommend an opposite treatment in this particular; it is agreed by all that free access of air is of great importance, and that water must be given very liberally, yet with such caution that the soil may never remain soaked after the immediate wants of the plant are supplied. The cultivation of camellias in the windows of houses is often attended with disappointment, from the buds dropping off when almost ready to expand, which is generally owing either to a neglect or an excess of watering; an apparently slight mistake, either of the one kind or of the other, being very speedily productive of this evil. Too much heat at this time is also apt to cause the flower-buds to fall off. The C. flowers well, when the temperature is kept not very much above the freezing-point, but frost it cannot bear. In the south of England, some of the varieties are occasionally trained to walls in the open air, receiving a little protection in winter. The proper soil for camellias is a loose black mould; a little sand and a little peat are often advantageously mixed with loam to form it. Camellias are often propagated by cuttings, often by layers; but the finest varieties very generally by grafting or by inarching. The single C. is also propagated by seed, and in this way the best stocks for grafting are procured.—Of the other species of C., the most hardy, and one of the most beautiful, is *C. reticulata*, from which not a few of the varieties now in cultivation are partly derived.—*C. oleifera* is extensively cultivated in China—not, however, in the more northerly parts—for its seeds, from which an oil is expressed after boiling, very similar to olive oil, and much in use as an article of food and otherwise in the domestic economy of the Chinese. The seeds of almost all the species, however, yield this oil.—*C. Sasanqua* bears the name of **SASANQUA TEA**. It is cultivated in China for the sake of its flowers, which are said to be used for flavouring certain kinds of tea.

CAMELOPARDA'LIS. See **GIRAFFE**.

CAMEL'S THORN (*Alhagi*), a genus of plants of the natural order *Leguminosae* (q. v.), sub-order *Papilionaceae*, containing a number of herbaceous or half-shrubby species, natives chiefly of the deserts of the east, having simple leaves, minute stipules, racemes of red flowers, and jointed pods with one seed in each joint. These plants are of great importance on account of the food which they afford for camels, where other vegetation is far from being abundant; and camels are particularly fond of them. *A. camelorum*, a herbaceous species, yields a kind of Manna (q. v.), which appears in the form of drops, as of honey, on the leaves, and gradually hardens. A similar exudation is yielded by *A. Nipalensis*, another herbaceous species; but it is not certain that the manna of Persia and Bokhara is produced, as has been alleged, by *A. Mausorum*, a shrubby species two or three feet in height, which certainly does not yield it in India or Egypt; the supposition that this exudation results from some peculiarity in the climate of Persia and Bokhara, being perhaps less probable than that of a mistake concerning species not very dissimilar.

CAMEO (Ital. *camei*). Gems cut in relief are called cameos, in opposition to those that are hollowed out so as to yield a raised impression, which are called *Intaglios*. The term C., however, is applied more especially to those diminutive pieces of sculpture which are prepared from precious stones having two strata or layers of different colours, the undermost of which is left to form the

background, the object to be represented being cut in the upper one. The stone generally used for this purpose by the ancients was the variegated onyx.

The art of C.-cutting is of great antiquity. It is believed to have been of Asiatic origin, and, to have been practised by the Babylonians, from whom the Phœnicians carried it into Egypt. From the Egyptians, it was transmitted to the Greeks, who brought it to great perfection; and latterly it was practised very extensively, and more successfully than perhaps any other art, in Rome. To what extent the gems, commonly called Etruscan, are in reality early Greek, is a subject of dispute amongst the learned. It was not till a comparatively late period—the age following Praxiteles—that C.-cutting became popular in Greece; and it was in the courts of the successors of Alexander that it was chiefly patronised. At this period, cameos were very extensively used, not only as personal ornaments, but in cups, vases, candelabra, and other objects of domestic luxury. *Pateræ* and other vessels were frequently worked out of a single stone, upon which were exhibited a whole series of figures of the most exquisite workmanship. Many of the antique cameos which have been preserved are wonderfully beautiful both in design and execution. The finest specimen in existence is said to be the Gonzaga C., formerly at Malmaison, now at St Petersburg. It represents the head of a prince and his wife, probably Ptolemy I. and Eurydice. Winkelman mentions a C. representing *Persens* and *Andromeda*, in such high relief, that almost the whole contour of the figures, which are of the most delicate white, is detached from the ground. It belonged to the painter Mengs, and at his death was purchased by the Empress Catharine of Russia. The only other gem which Winkelman is disposed to rank with that just mentioned, is 'the Judgment of Paris' in the cabinet of the Prince Piombino at Rome. Of cameos of the Roman time, many fine specimens are to be found in the continental museums. The most celebrated C. in England is the 'Cupid and Psyche,' in the Marlborough Collection, by Tryphon, who is supposed to have lived in Macedonia under the immediate successors of Alexander. The stones on which many of these cameos are cut are of surprising, and, in modern times, unequalled size and perfection. They are supposed to have been procured by the ancients through their oriental and African commerce. Cameos do not seem to have been made in medieval times; but the art revived in Italy, under the auspices of the Medici; and the production of cameos, both in *pietra dura* and in shell, has there become a branch of art-manufacture of considerable importance. Impressions from antique cameos in glass, sulphur, porcelain, and other materials, are produced in many places; and for artistic purposes, possess all the value of the originals.

Glass Cameos.—The manufacture of cameos from artificial substances was not unknown to the ancients. One of the most beautiful specimens of an imitation of C. in glass is the famous *Barberini* or *Portland Vase*, now in the British Museum. The ground is blue, the figures, which are in low relief, being of a delicate, half-transparent white. See **PORTLAND VASE**. Many fragments of the same kind of manufacture exist in other cabinets, but that which we are fortunate enough to possess is believed to be the only perfect example.

Shell Cameos.—The art of imitating cameos in shell, which has now attained to such perfection as to rival the debauch and finish even of antique workmanship, and which is a process quite as artificial as their production from gems, is of modern invention. The shells, like the stones,

chosen for this purpose, are such as possess layers of different colours. The most useful are the *Bull's Mouth*, the under layer of which is red, resembling the sardonyx; the *Black Helmet*, which has a dark onyx ground; and the *Queen's Conch*, of which the ground is of a pinkish hue. These shells have three strata, the undermost of which forms the ground, the figure being sculptured in the second, and the third serving to mark the hair, wreaths, armour, and other more prominent objects. The portion of shell having been prepared of the requisite size, form, and thickness by various mechanical means, it is fixed by some adhesive substance—usually rosin—to a small block of wood, of such form and thickness as to be conveniently grasped by the artist in his left hand. The outline of the object or objects to be represented is then sketched with a pencil, and, in the case of portraits, is usually copied from a previous pencil-sketch on paper. The pencil-marking on the shell is then followed with a scratch-point, and the surrounding white substance is removed by means of files and graters. This latter process, which is more mechanical than the rest, is usually performed by an assistant. The artist then proceeds slowly and carefully to work out his subject by the use of smaller tools; those used at last for deepening the finer lines being scarcely larger than ordinary darning-needles. The manufacture of shell-cameos in Rome commenced about 1805, and is said to have been of Sicilian origin. The art was at first confined to Italy; but during the last 20 years, it has been carried on in Paris to a greater extent than even in Rome, though not with equal success. A large proportion of the whole cameos manufactured in France are imported into England, and many of them are mounted as brooches, and exported to the United States and the British colonies. *Saolini* and *Giovanni Dies* have long been celebrated as artists in shell-cameo in Rome, whilst *Girometti* has enjoyed a similar reputation for his works in *pietra dura*.

CA'MERA LU'CIDA, an optical instrument constructed of various forms, and for various purposes. Dr Wollaston's C. L., intended to facilitate the perspective delineation of objects, consists of a small quadrilateral prism of glass, of which AB in the annexed figure is the perpendicular section, held in

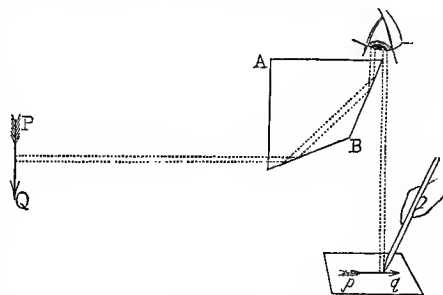

Camera Lucida.

a brass frame, which is attached to an upright rod, having at its lower end a screw-clamp, to fix it to the edge of a table. The prism being at the height of about a foot from the table, has its upper face horizontal. Two of its faces, as in the figure, are at a right angle at A; the contiguous faces make respectively with them angles of $67\frac{1}{2}^\circ$; so that the remaining obtuse angle at B contains 135° . Rays coming from an object PQ, and falling nearly perpendicularly on the first surface, enter the prism,

CAMERA LUCIDA—CAMERA OBSCURA.

and undergo total reflection at the contiguous surface (see *DIOPTRICS*); they then fall at the same angle on the next surface, and are totally reflected again; finally, they emerge nearly perpendicularly to the remaining surface. An eye, as in the figure, then receives the emergent pencil through one part of the pupil, so that an image, *pg*, of the object is seen projected upon a sheet of paper upon the table. The rays from the drawing-pencil passing the edge of the prism, enter the other part of the pupil; and the pencil and image being seen together upon the paper, a sketch of the latter can be taken. There is, however, a practical difficulty—the image and the drawing-pencil are at distances sensibly different from the eye, and so cannot be seen together distinctly at the same time. To obviate this, a plate of metal, with a small aperture as an eye-hole, is placed at the edge under the eye, so that the rays through the prism, and those from the drawing-pencil, which both pass through the eye-hole, form only very small pencils. By this, the difficulty is greatly diminished. It is still, however, difficult to use the instrument satisfactorily; and though many acquire great readiness in its use, others have never been able to attain the same facility. The instrument is remarkable for its small bulk and portability. A good one will pack in a box 8 inches by 2, and half an inch deep. Besides this form of the *C. L.*, which is the most common, there are others. Its simplest form is merely a piece of smooth glass fixed at an angle of 45° to the horizon. An image from a horizontal object falling on this glass will be perfectly reflected, and that in the vertical, so that the eye looking vertically down will see the image, and, owing to the transparency of the glass, the artist will be able to trace it out upon paper below. In this case, however (see *CATOPTRICS*), the image will be inverted.

CAMERA OBSCURA (literally, a dark chamber), an instrument invented by Baptista Porta in the 16th century. It is known in its simplest form as a familiar toy, consisting of a rectangular box, furnished at one end with a lens whose focal length is equal to the length and depth of the box; at the opposite end of which a plane reflector is placed at an angle of 45° , which throws the image of any objects to which the lens may be directed on a piece of ground-glass on the top of the box in a non-inverted position, so that they may be viewed or sketched from as in nature.

The *C. O.* being now an indispensable article in the practice of photography, has received a number of recent improvements, which make it rank as a scientific instrument. The principle, however, involved in the simplest and most refined forms is the same, and may be illustrated and made intelligible by the following experiment: Let a small hole be bored in a window-shutter, and the room be darkened. If, now, the beam of light entering the room by this hole be intercepted by a sheet of white paper, held at a small distance from the hole, an inverted image of objects without will be seen upon the paper. By placing a small convex lens over the hole, this image is rendered much more distinct, or *sharp*, in photographic language. Moreover, it will be found that, at a certain distance from the hole, the image attains a maximum degree of sharpness; and that if the paper be removed from this point to any position either nearer to the hole or further from it, the image becomes indistinct and confused. At the point of greatest distinctness, the image is said to be *focused*. Such being the principle of the camera, it is evident that in practice the instrument may assume many forms, provided always that it consists of a darkened box or chamber having a hole at one end for the insertion of a lens, or combination

of lenses, and at the other a screen, generally made of ground-glass, on which to receive the image. Fig. 1 will at once give an idea of a very common and

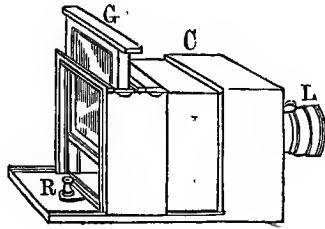

Fig. 1.

simple form of camera. *C* is the body of the instrument, made of any opaque substance; *L*, the tube or tubes, generally formed of brass, and containing one or more lenses; *G*, the obscured or ground-glass, upon which the image is thrown for the purpose of adjusting the focus; *R*, the rack behind, by means of which, and the double sides of the camera, the body of the instrument may be lengthened or shortened till the image on the ground-screen is accurately focused. This rack is most frequently placed upon the tubes carrying the lenses. The interior of the whole apparatus is blackened, to prevent reflection of the rays falling on their sides, and to impart greater distinctness to the picture. *S*, in fig. 2,

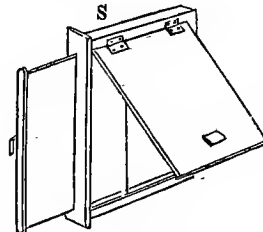

Fig. 2.

represents the *camera-slide*: This is a thin dark box, and is used for conveying a sensitive plate from the operating-room to the camera, and back again after exposure. It consists of a rectangular frame, made to fit exactly into the back of the camera when the focusing-screen is removed. At the back is a hinged door, by means of which the plate is introduced into the slide; and in front is a shutter, which is pulled up when the plate is to be exposed, and shut down after the time requisite for the action of the light upon the plate has expired. It must be constructed so that, when substituted for the focusing-screen *G* (fig. 1), the surface of the prepared plate, which is intended to receive the image, shall correspond exactly in distance from the lens with the ground-surface of the focusing-screen. The plate rests upon projections of silver wire in the corners of the slide; and the same slide may be used for plates of different sizes, by introducing into it thin frames of suitable dimensions also furnished with silver-wire corners.

Photographic cameras are generally required for one of three purposes—*viz.*, portraits, landscapes, or copying; and for each of these it is necessary to make suitable modifications in the construction of the instrument. A camera has, however, been recently contrived which combines within itself the conditions necessary for all contingencies. It is

CAMERARIUS—CAMERONIAN REGIMENT.

called Martin's Universal Portrait, Landscape, and Copying Camera, and consists, primarily, of a base-board, 30 inches long and 11 inches wide, divided into three pieces, and hinged together by means of broad brass hinges, so as to diffuse the bearing as much as possible, and bolted together when in use by sliding panels of mahogany, extending across the entire width of the base-board. This base-board being grooved on its outer edges, allows the sliding portions of the camera to be moved from one end to the other, so as to alter the relation between object, lens, and image *ad infinitum*.

What may be regarded as the body of the camera, is of the same construction as an ordinary expanding camera (fig. 1), except that it is furnished with additional apertures for camera slides, and the front (C) and the back are united by means of an accordion or bellows body of suitable length to extend from one end of the base-board to the other.

CAMERARIUS, JOACHIM—originally, *Liebbard*, which name he changed into C., because his forefathers had been *Kämmerer* (chamberlains) at the court of the Bishop of Bamberg—was born at Bamberg, April 12, 1500, and died at Leipsic, after a life devoted to literature, April 17, 1574. He was by nature earnest and taciturn; but the extent of his knowledge, his sobriety of opinion, strength of character, and, when he pleased, overpowering eloquence, won for him the esteem of all his contemporaries. His works, of which several still remain valuable, include an excellent biography of Melancthon, and a collection of letters by this reformer; also annotations on Cicero's *Questiones Tusculanæ* (1525), *Elements of Rhetoric, Commentarii Linguae Græcæ et Latinae* (1551), and *Epistolæ Familiæres* (1583—1595), giving interesting notices of his times.—His son, **JOACHIM C.** (b. 1534, d. 1598), was one of the most learned physicians and botanists of his age.

CAMERINO (ancient *Camerinum*), a town of Central Italy, capital of the delegation of the same name, situated on a hill at the foot of the Apennines, 41 miles south-west of Ancona. It has a cathedral, occupying the site of a temple to Jupiter, a university, and some manufactures of silk. Its bishopric dates from the 3d c.; and it was made an archiepiscopal see in 1787. Pop. 6000.

CAMERON, JOHN, a famous scholar and divine, was born at Glasgow about the year 1580, and educated at the university of that city, where, in his 20th year, he held an appointment as reader in Greek. In 1600, he set out to travel in France, where his ability and erudition secured for him a philosophical professorship in the university of Sedan. He afterwards acted as a Protestant clergyman at Bordeaux, and, on the death of Gomarus, was appointed to the divinity chair in the university of Saumur, an appointment he held until 1620. Returning to Britain, he was appointed professor of divinity at Glasgow; but in less than a year he returned to Saumur; thence to Montauban, where he received a divinity professorship. Here his opposition to the party who advocated a civil war made him many enemies, by one of whom he was stabbed in the street; and he died from the effects of the wound in 1625. He was considered one of the best scholars of his time; in biblical criticism, he was inclined to be perverse; where there was a difficulty, he usually chose the opposite view to that held by other divines, especially Beza. His theological opinions were of a somewhat lax character, his works being said to be the foundation of Amyraut's doctrine of universal grace.

CAMERON, RICHARD, a Scottish Presbyterian preacher in the 17th c., who suffered death for the

cause he espoused, and from whom the religious sect ordinarily called Cameronians (q.v.) has been named. C. belonged to the extreme party, who held by the perpetually binding obligations of the Solemn League and Covenant (see **COVENANTS**), which were set aside at the restoration of Charles II. Along with some others, he strenuously resisted those measures that reinstated the Episcopal Church in Scotland, and that proscribed the meetings for public worship of unauthorised religious bodies. Contrary to law, he persisted in preaching in the fields, and became obnoxious to government, to which, indeed, he finally assumed an attitude of defiance. In June 1680, he, in company with about twenty persons of equal zeal, well armed, entered the town of Sanquhar; and in the market-place they formally renounced their allegiance to Charles II., who had so grossly abused his power, and declared war against him and all his adherents. After this act, they retired to the hills between Nithsdale and Ayrshire, where they succeeded in evading capture for a month, though a price of 5000 merks had been set upon C.'s head by government, and 3000 upon the heads of the others. On the 20th July 1680, however, they were surprised by a vastly superior force in Aird's Moss, and after a brave fight, C. was killed. His hands and head were cut off, and sent to Edinburgh, where they were fixed upon the Netherbow Port. C. ranks as a martyr, and has an honourable place in the history of *Scots Worthies*.

CAMERON HIGHLANDERS, the designation given to the 79th Regiment of infantry in the British service, in consequence of the corps having been raised by Allan Cameron of Erroch in 1793. Originally, it consisted of 1000 men, but a second battalion was added in 1804. This gallant regiment, which wears the Highland garb, performed distinguished services in the peninsula and at Waterloo, and has been engaged in the chief warlike struggles of more recent times.

CAMERONIAN REGIMENT, the 26th Regiment of infantry in the British service, so called from having had its origin in a body of Cameronians (q.v.) during the Revolution of 1688 in Scotland. Taking advantage of the zeal and courage of the Hillmen or Cameronians, the Convention which sat at Edinburgh induced a number of them to assist in completing the work of the Revolution, which, as was still imagined by some, was to re-establish things according to the letter of the Covenants. A regiment of Cameronians was accordingly organised; each soldier being induced to enlist on the understanding that the special object of the corps was 'to recover and establish the work of Reformation in Scotland, in opposition to popery, prelacy, and arbitrary power, in all the branches and steps thereof, till the government in church and state be brought to that lustre and integrity which it had in the best of times.' (See *Burton's History of Scotland*, vol. i. p. 49.) Thus was formed the celebrated C. R., with the youthful Lord Angus as colonel, and William Cleland as lieutenant-colonel and actual commander. Under Cleland, not yet in his 30th year, the regiment was sent northwards to quell the insurrection, after the fall of Viscount Dundee. Surrounded by from 4000 to 5000 Highlanders, the Cameronians, only 800 strong, gallantly defended themselves during a whole day in Dunkeld, August 21, 1689. In this terrific struggle, the brave Cleland was killed. The Cameronians, whom, considering the issue of the Revolution, we must suppose to have been entrapped into military service, were afterwards employed in the foreign wars of William III., greatly to the scandal of that stern portion of the

Presbyterians who founded the Cameronian sect. As the 26th of the line, the regiment has ever done credit to its origin; being distinguished alike for gallantry in the field, and for its good and orderly conduct in garrison.

CAMERO'NIANS, the religious sect in Scotland alluded to in the notice of Richard Cameron, from whom the body has been popularly named. Its official designation, however, is that of Reformed Presbyterians. No doubt, the principles of the body are those for which Cameron contended and died; but it assumed no distinct form till after the Revolution of 1688; and it might briefly be defined as consisting of a small party of Presbyterians, who objected to the Revolution settlement in church and state, and desired to see in full force that kind of civil and ecclesiastical polity that prevailed in Scotland from 1638 to 1649. According to the Solemn League and Covenant, ratified by the parliaments of England and Scotland, and also by the Assembly of Divines at Westminster in 1643, Presbyterianism was to be maintained in the kingdoms of England, Scotland, and Ireland, and popery, prelacy, superstition, heresy, schism, &c., were to be extirpated. The Covenanters in Scotland contended, as is well known, under much suffering, for this species of Presbyterian supremacy throughout the reigns of Charles II. and James VII. (II.). As a measure of pacification at the Revolution, Presbytery was established in Scotland by act of parliament 1690; but it was of a modified kind. Substantially the church was rendered a creature of the state, more particularly as regards the calling of General Assemblies; and equally to the disgust of the extreme party whom we refer to, prelacy was not only confirmed in England and Ireland, but they saw that there was a general toleration of heresy—i. e., dissent. In sentiment, if not in form, therefore, this uncompromising party repudiated the government of William III. and his successors, and still maintained the perpetually binding obligations of the Covenants. Unquestionably, these C. acted under strong convictions, and only desired to carry out to a legitimate issue those principles which have always mingled with the theories of the Presbyterian Church of Scotland; but which, for prudential considerations, have been long practically in abeyance. In short, it is in the standards of this sect that we have to look for a true embodiment of the tenets held by the great body of English and Scotch Presbyterians of 1643. Others gave in to the Revolution settlement, and afterwards found cause to secede. The C. never gave in, and, of course, never seceded. Although thus, in point of fact, an elder sister of the existing Church of Scotland and all its Secessions, the Cameronian body, as has been said, did not assume a regular form till after the Revolution; and it was with some difficulty, amidst the general contentment of the nation, that it organised a communion with ordained ministers. The steadfastness of members, was put to a severe trial by the defection of their ministers; and for a time, the people were as sheep without a shepherd. At length, after their faith and patience had been tried for 16 years, they were joined by the Rev. John McMillan, from the Established Church, in 1706. In a short time afterwards, the communion was joined by the Rev. John McNeil, a licentiate of the Established Church. As a means of confirming the faith of members of the body, and of giving a public testimony of their principles, it was resolved to renew the Covenants; and this solemnity took place at Auchensach, near Douglas, in Lanarkshire, in 1712. The subsequent accession of the Rev. Mr Nairne, enabled the C. to constitute a presbytery at Braehead, in the parish of Carnwath, on

the 1st of August 1743, under the appellation of the Reformed Presbytery. Other preachers afterwards attached themselves to the sect, which continued to flourish obscurely in the west of Scotland and north of Ireland. For their history and tenets, we refer to the *Testimony of the Reformed Presbyterian Church* (Glasgow, John Keith, 1842). Holding strictly to the Covenants, and in theory rejecting the Revolution settlement, the political position of the C. is very peculiar, as they refuse to recognise any laws or institutions which they conceive to be inimical to those of the kingdom of Christ; from which cause they have greatly isolated themselves from general society, and refused several of the responsibilities and privileges of citizens. At the same time, it is proper to say, that if zealous and uncompromising, they are also a peaceful body of Christians, who, under the shelter of a free and tolerant government, are left unmolested to renew the Covenants as often as fancy dictates. In 1860, the sect numbered 6 presbyteries, comprising altogether 45 congregations in Scotland, one of which was in Edinburgh and 4 in Glasgow. Connected with the body, there are congregations in Ireland and North America.

CAMEROON'S, a river of Upper Guinea, Africa, which enters the Bight of Biafra from a north-east direction, in about lat. 4° N., long. 9° 40' E., by an estuary some 20 miles in breadth. Its length is not certainly known, but for 40 miles upwards its breadth averages nearly a quarter of a mile, its depth varying in the dry season from 2 to 20 feet. The left bank of the river is steep and high, the right for many miles low and swampy, and covered with mangroves. There are several populous and thriving villages on its banks, whose inhabitants carry on an extensive trade in palm-oil, and ivory, obtained in great quantity from dead elephants, which have perished in search of water in a great morass inland.—C. is also the name of a cape on one of the islands of the estuary.—C. PEAK is the name of the culminating-point in the C. Mountains, which in lat. 4° 13' N., and long. 9° 10' E., has an elevation estimated at 13,000 feet.

CAME'ITA, a town of Brazil, on the left bank of the Tocantins, which joins the estuary of the Amazon from the south. It is 85 miles to the south-west of Para or Belem. It has a fertile district attached to it, which is estimated to contain 20,000 inhabitants.

CAMILLUS, MARCUS FURIUS, a celebrated Roman patrician, who first makes his appearance as consular tribune, 403 B.C. His military career was a series of unbroken successes, according to the accounts which have come down to us; but these accounts have been shewn by Niebuhr to possess a considerable admixture of mythological or poetic fiction. In 396, C. was made dictator, during the Veientine war, in which he mined and captured the city of Veii; but the proud splendour of his subsequent triumph offended the Roman populace, who were still further displeased when C. demanded a tithe of the spoils of Veii, in order to fulfil a vow made to Apollo, on condition of victory. In 394, C. was again elected consular tribune, and besieged the Falerii, who after bravely defending themselves, were led by a magnanimous act of C. to yield unconditionally. Afterwards, C., being accused of peculation, and foreseeing certain condemnation, banished himself from Rome, 391, and lived in retirement at Ardea, until Brennus, at the head of his wild Gauls, had swept through Etruria, and captured and destroyed the whole of Rome except the Capitol. C. was now recalled, and

appointed dictator a second time. He achieved a decisive victory over the invaders, rebuilt Rome, and obtained new victories over the Volsci, and others. In 386 B.C., he was elected dictator for the third time, but refused the office. In 381 B.C., C. was victorious in the war of Rome against Præneste and other Latin towns; and in 368 B.C., he was elected to his fourth dictatorship, but abdicated during the same year. In 367 B.C., when war broke out with the Gauls, C., though 80 years old, accepted the dictatorship for the fifth time, defeated the barbarians near Alba, and made peace between patricians and plebeians. After this, he erected near the Capitol a temple to Concord, and, having retired from public life, died 365 B.C., of the plague, lamented by the whole Roman people.

CAMISARDS. See CEVENNES.

CAM'LET (from Arab. *chamal*, fine) is properly a fabric made from the hair of the Angora-goat (q. v.). The camlets made in Britain are either wholly of wool, or of wool mixed with cotton or linen, and spun hard.

CAMOENS, LUIS DE, the epic poet of Portugal, was born about 1524, at Lisbon, and studied the ancient classics at Coimbra. On his return to Lisbon, he fell in love with a lady of honour, Catharina d'Atayada. This affair was the beginning of all the poet's misfortunes. Having been banished by royal authority to Santarem, C. joined the expedition of John III. against Morocco, and lost his right eye in a naval engagement with the Moors in the Strait of Gibraltar. On his return to Lisbon, his bravery as a soldier was no more honoured than his genius as a poet. Disappointed in all his hopes, he determined to leave for ever his native land, and sailed for India, 1553. Offended by certain abuses of the Portuguese authorities in India, C. ventured to expose them in a satire, entitled *Disparates na India*, 'Follies in India,' in which he treated even the viceroy with ridicule. For this offence, the poet was banished, 1556, to Macao, where he lived several years, and was engaged in writing *Os Lusíadas*. Here C. held the unpoetical but probably lucrative post of administrator of the effects of deceased persons; and having saved, as he thought, a competency for his future life, was recalled from his banishment, 1561. Unhappily, in returning to Goa, he suffered shipwreck, and lost all his property, excepting his epic poem. After other wanderings and misfortunes, C. took ship for Lisbon, where he arrived in 1569, with no other wealth but his epic. He dedicated *The Lusíad* to the young king, Sebastian, who was very gracious; but, nevertheless, all the real patronage bestowed on C. consisted of a very small pension (about £4), and permission to remain at the court of Lisbon. Even this small pittance was taken away after the death of Sebastian, and C. was left in such poverty, that a faithful Indian servant begged in the streets of Lisbon for the support of the great epic poet of Portugal. C.'s lyric poems, written during this time of destitution, contain many pathetic lamentations. He died obscurely in the hospital at Lisbon, 1579; and sixteen years afterwards, when it was proposed to erect a splendid monument to his memory, there was some difficulty in finding his burial-place.

The Lusíad (*Os Lusíadas*, 'the Lusitanians') celebrates the chief events in the history of Portugal, and is remarkable as the only modern epic poem which is pervaded by anything like the true national and popular spirit of ancient epic poems. It is a gallery of epic pictures, in which all the

great achievements of Portuguese heroism are represented. Among the most famous passages are the tragical story of Inez de Castro, and the apparition of the giant Adamastor, who appears as the Spirit of the Storm to Vasco de Gama, when crossing the Cape. The versification of *The Lusíad* is extremely charming. Patriotic sentiments pervade the whole work. Besides his epic poem, C. wrote sonnets, odes, elegies, eclogues, epigrams, satires, epistles, and three comedies—*Os Amphitryoes* (after Plautus), *King Seleucus*, and *Filodemo*. The latest and best complete edition of his poems appeared in three volumes (Hamburg, 1834). The best edition of *The Lusíad* was published in Paris (1817), reprinted in 1819, and again, with emendations by Berdier, in 1823. *The Lusíad* has been translated into Spanish, French, Italian, English, Polish, and German.

CAMO'GLIA, a town of Northern Italy, on the Gulf of Genoa, about 13 miles east-south-east of the city of that name. Its inhabitants, amounting to 5809, are chiefly engaged in fishing.

CAM'OMILE. See CHAMOMILE.

CAM'OUFLET, in Military Pyrotechny, is a stinking composition enclosed in paper-cases. It is used in siege-works, to blow into the faces of the sappers and miners, when hostile parties come within reach of each other, and thus to distress and confuse them.

CAMP (Fr., from Lat. *campus*, a plain, or level field). The signification of this word in English is rather that which belonged to the Latin *castrum*, an encampment, or *castra*, a collection of tents, huts, and other structures, for the accommodation and protection of troops, than that which its etymology would more directly indicate. The regular system of encampment ultimately adopted by the Romans, was forced upon them by degrees. The most complete account of it is furnished to us by Polybius. A plan will be found in Dr Smith's *Dictionary of Greek and Roman Antiquities*, constructed for the purpose of illustrating his description. When a Roman army was about to encamp, a tribune and several centurions were sent on before, to select a suitable site for the purpose. As soon as the locality was determined on, they chose the spot for the prætorium or general's tent, and marked it with a white flag. Around the prætorium, as a sort of centre or heart to the whole system, the rest of the C. was laid out. It was generally placed on an elevated position, in order that the general might have the rest of the encampment under his eye, and be able to transmit his orders with greater facility. Polybius himself tells us, that the best conception which can be formed of a Roman C. of the more permanent kind is by regarding it as a military town, resembling in many respects no doubt that which has recently grown up at Aldershot (q. v.). The streets were broader than those usually to be found in towns, the wider ones measuring 100, and the narrower 50 feet; and the *forum*, as its name indicates, was a sort of public market-place. A space of 200 feet was left vacant all round between the tents and the ramparts, partly to afford space for the arrangements of the army, and for stowing away any booty that might be captured, but chiefly to protect the soldiers' huts from incendiary attempts from without. In form, the Roman C. was square, except in the case in which it was intended to embrace within its ramparts four legions, or two consular armies, when it became an oblong rectangle. The C. was surrounded by a fosse or trench (*fossa*), which was generally 9 feet deep and 12 broad. On the top of the rampart, which was of earth, there were

CAMP EQUIPAGE—CAMPAGNA DI ROMA.

stakes. The labour of constructing the rampart and the fosse was divided between the allies and the Roman legions, the former making the sides along which they were stationed, and the legions the rest. The task of superintending the construction of the C. amongst the Romans was intrusted to the tribunes; amongst the allies, to the prefects. Before the arrival of the troops, the different parts of the C. were so distinctly marked out and measured off, that they at once proceeded to their respective stations, as if they had entered a well-known city, and were marching to their quarters. The discipline of the C. was of the strictest kind. The tribunes administered an oath against theft both to freemen and slaves, and two maniples were chosen to keep the *via principalis*, which was a place of general resort, clean and in good repair. The other occupations connected with the C., too numerous to be mentioned here, were portioned out in like manner; and the superintendence of the whole was intrusted to two tribunes chosen by lot from each legion, and appointed to serve for two months. The prefects of the allies possessed a similar authority, which, however, seems to have been limited to their own troops. Every morning at daybreak, the centurions and horsemen presented themselves to the tribunes, and these, in their turn, received their orders from the consul. The watchword for the night, marked on a four-cornered piece of wood, was given out with much formality. The night was divided into four watches, each of three hours' length; and there was a curious arrangement for ascertaining that guard was kept with vigilance. The soldiers of the watch companies received from the tribune a number of small tablets, with certain marks upon them, and these tablets were collected during the night by the horsemen whose duty it was to visit the posts, from such of the guards as they found on duty. Where these inspectors found the guards asleep or absent, they called upon the bystanders to witness the fact, and then passed on to the next. In the morning, the inspectors appeared before the tribunes, and gave up the tablets they had received, when the guards whose tablets were not produced were required to account for them. A regular scale of rewards and punishments was established in the camp. In comparing the encampments of the Romans with those of his own countrymen, Polybius tells us that the Greeks trusted mainly to a judicious selection of their ground, and regarded the natural advantages which they thus secured as supplying in a great measure the place of artificial means of defence. The Greeks, consequently, had no regular form of C. and no fixed places were assigned to the different divisions of the army. When the practice of drawing up the army according to cohorts, introduced by Marius and Cæsar, was adopted, the internal arrangements of the C. experienced a corresponding change. Latterly, even the square form was abandoned, and the C. was made to suit the nature of the ground. It was always held to be of importance, however, that the C. occupied a defensible position; that it could not be overlooked; and that it had a command of water.

When stationary camps (*castra stativa*) came into more general use, we hear of several parts which are not mentioned by Polybius, for example, the infirmary (*valetudinarium*), the farriery (*veterinarium*), the forge (*fabrica*), &c.; and as a great variety of troops then came to be employed, they must, of course, have had new stations appointed to them in the camp. Many of the stationary camps ultimately became towns, and to this is ascribed the origin of most of the towns in England the names of which end in *cester* or *chester*. Amongst the most perfect

of those which retained the form of the simple encampment, is that at Ardoch in Strathearn, Perthshire, in the grass-covered mounds and ridges of which most of the divisions of the C. have been distinctly traced by antiquaries. For further information on this subject, the reader is referred to General Roy's *Military Antiquities in Great Britain*, and the *Caledonia Romana* of the late Mr Robert Stuart. In these works will be found ample accounts of some of the more remarkable Roman camps in Britain; those described by Roy being rendered intelligible by large engravings.

It is believed that, during the middle ages, the plan adopted by the Romans in their camps was more or less adhered to, seeing that the weapons employed, which mainly determined the character of the troops, were nearly the same. In Britain, before the arrival of the Romans, and also during the Saxon and Danish periods, the camps, usually circular in form, appear to have been somewhat rude in character, with the cavalry grouped round the standard in the centre, and the infantry placed near the front.

The principles of castrametation, or camp-formation, underwent much change after the invention of gunpowder, owing to the necessity for defending the C. from artillery. Modern camps, of different kinds, will be found described under ENCAMPMENT.

CAMP EQUIPAGE is a general name for all the tents, furniture, fittings, and utensils carried with an army, applicable to the domestic rather than the warlike wants of the soldier. In the days when armour was worn, the C. E. was enormously heavy and complicated. In the present day, a certain amount of C. E. is provided for a given number of troops. See ENCAMPMENT, TENT, &c.

CAMP FOLLOWERS are the sutlers and dealers in small-wares who follow an army. In India, owing to the peculiar habits and customs of the Hindus, and the large number of servants retained by English officers, the C. F. are in immense number: comprising servants, sutlers, cantiniers, hostlers, water-carriers, snake-charmers, dancers, conjurers, and women. In February 1839, when a Bengal army of 15,000 men left Shikarpoor for Afghanistan, it was accompanied by no fewer than 85,000 C. F.: the commander took with him six weeks' food for the whole 100,000. All English commanders in India find this regulation a very burdensome one. Even in European armies, however, C. F. are regarded as necessary; they are under the control of the commanding officer, and are subject to the Articles of War—not, however, in cantonments, only in the field. French armies are accompanied by women much more largely than English.

CAMPAGNA, a town of Naples, in the province of Principato Citra, is situated between high mountains, about 20 miles east of Salerno. It has a fine cathedral, several convents, and a large annual fair. Pop. 8192.

CAMPAGNA DI ROMA, an undulating, uncultivated, and unhealthy plain of Italy surrounding Rome, including the greatest part of ancient *Latium*, and now forming the papal delegation of Frosinone and a great part of the Comarca di Roma. Its length is variously stated, arising from the fact that different authorities measure it from different points. But supposing the name to apply to the district extending from Cape Lincaro, south of Civita Vecchia, to Terracina, beyond the Pontine Marshes, its length is about 90 miles; and its breadth inland, to the Alban and Sabine hills, is stated at from 27 to 40 miles. A broad strip of sandy plain skirts the Mediterranean. The ground, which never rises above 200 feet above the sea, is almost entirely

CAMPAIGN—CAMPANIA.

volcanic, and the lakes are formed by craters of extinct volcanoes. The vapours rising from this district, and especially from the Solfatarà (q.v.), produce the pestilential atmosphere styled *Aria Cattiva*. The number of inhabitants is very small, and in summer they are driven from the C. by its pestilential air, and seek shelter in Rome and other neighbouring places. In autumn, herdsmen descend from the Apennines to the C. with their herds, the pasturage in some parts being rich and abundant. This district was not always uncultivated and depopulated as we now find it, for Domitian and Hadrian built here their splendid villas. Wars and devastations, the 'black-death' (q.v.) in the 14th c., which greatly thinned the population, and inundations from the Tiber, have been the main causes of the present state of the C.; but, according to Livy, it was always an unhealthy district, even when well cultivated. Some of the popes, especially Pius VI., have endeavoured to drain the Pontine Marshes, and, during the dominion of the French in Italy, General Miollis made great improvements in drainage, timber-planting, and cultivation in the Campagna.

CAMPAIGN generally means a connected series of military operations, forming a distinct stage or step in a war. Under the old system of warfare, when armies kept the field only during the summer months, a C. was understood to include all that was done by an army from the time it took the field till it went again into winter-quarters. Now that winter is no longer allowed to arrest military operations, it is more difficult to say where one C. ends and another begins. Some writers make a C. include all the steps taken to accomplish some one immediate object.

CAMPAN, JEANNE LOUISE HENRIETTE, reader to the daughters of Louis XV., was born in Paris, October 6, 1752. She was favoured by Marie Antoinette, and gave her royal patroness numerous proofs of her fidelity. When the unfortunate queen was conveyed to the Temple, she wished to share her captivity, but was refused entrance by Petion. During the Reign of Terror, she remained concealed at Combertain. After the fall of Robespierre, she opened a boarding-school at St Germain-en-Laye, which was patronised by Josephine Beauharnais, who sent her daughter Hortense to it. In 1806, Napoleon appointed her lady-superintendent of the Institution at Ecouen for the education of the daughters of the officers of the Legion of Honour. After the Restoration, this institution was suppressed, and Madame C. retired to Mantes, where she died, May 16, 1822. She is chiefly remembered on account of her interesting works—*Mémoires sur la Vie Privée de la Reine Marie Antoinette* (4 vols., 5th ed., Par. 1824), *Journal Anecdotique* (Par. 1824), and *Correspondance Inédite avec la Reine Hortense* (2 vols., Par. 1835)—giving recollections of the court of Louis XV., of Marie Antoinette, the Revolution, and some traits from the private character of Napoleon.

CAMPANA, LA, a town of Andalusia, Spain, situated on the Madre-Viega, a tributary of the Guadalquivir, about 37 miles east-north-east of Seville. The inhabitants, numbering 5380, are engaged chiefly in agricultural pursuits, and in weaving and brick-making.

CAMPANARIO, a town of Estremadura, Spain, about 62 miles east-south-east of Badajoz. It is an ill-built place, with narrow, uncared-for streets. It has manufactures of linens and ropes, and a trade in the agricultural produce of the neighbourhood. Pop. 5400.

CAMPANELLA, TOMMA'SO, a Dominican monk celebrated for his philosophical ability, was born in

1568 at Stilo in Calabria, and studied at Naples and Cosenza. The writings of Telesius first awakened his doubts respecting that pile of artificial dogmas styled the 'scholastic philosophy.' The results of his studies were given in his *Philosophia Sensibus Demonstrata*, &c. (Naples, 1591), which contained a defence of Telesius. His superiority in disputations exposed him to the hatred and false accusations of the orthodox monks and schoolmen. He was in consequence compelled to flee from Naples to Rome, and thence to Florence, Venice, and Bologna. Afterwards, he returned to Calabria, but having involved himself in a political conspiracy, he was seized and confined in a Neapolitan dungeon for 27 years; tried five times, and tortured seven; accused of heresy; and declared the author of a book which had been published thirty years before he was born. In 1626, Pope Urban VIII. had him brought to the prison of the Inquisition at Rome, but immediately liberated him, and treated him in a very generous manner. After being again persecuted by the Spanish government, C., who had formed the friendship of the French ambassador at Rome, the Duc de Noailles, obtained a letter of introduction to Cardinal Richelieu, and secretly left for France, where he was graciously received. He died in the Dominican monastery of St Honoré, near Paris, 1639. Most of his works—*De Gentilismo non Retinendo* (Paris, 1636), *Astrologicorum Libri VII.* (Lyon, 1629), *Prodromus Philosophiæ Instaurandæ* (Frankfort, 1617), *Ecordium Metaphysicæ Novæ, De Sensu Rerum et Magia* (Frankfort, 1620)—were written during his imprisonment. His philosophical views give expression to that confused fermentation of new ideas which was characteristic of the close of the 16th and opening of the 17th c.—bold and clear opinions strangely mingled with commonplaces and with astrological dreams and fancies. It may seem strange that C. should have been patronised by the pope; but this favour was gained, not by his speculative works, but by several writings in defence of the Roman Catholic Church. His *De Monarchia Hispanica Discursus* is a work of great power and value, comprising a sketch of the political world of C.'s time, with special reference to Spain. It was translated into English during Cromwell's Protectorate.

CAMPANIA, anciently a province of Central Italy, having Capua as its capital (now known as the province Terra di Lavoro, Naples), was bounded on the S. by Lucania, E. by Samnium, N. by Latium, and W. by the Tyrrhenian Sea. It was one of the most productive plains in the world, producing in extraordinary abundance corn, wine, and oil; and both by Greek and Roman writers is celebrated for its soft and genial climate, the beauty of its landscapes, and the excellence of its harbours. It was the *regio felix* of the Romans, who built here many of their most splendid villas, &c. Through it passed the Appian Way, the greatest high-road of Italy. The promontory Misenum, Mount Vesuvius, the river Volturnus, the towns Baia, Cumæ, Linternum, Puteoli, Naples, Herculaneum, Pompeii, Nola, Salerno, Capua, &c., belonged to Campania. It was the oldest Greek settlement in Italy, having been colonised, according to the later chronologers, about 1050 B.C.; but this is in all probability too early a date. It was next conquered by the Etruscans, and several of the towns above mentioned, such as Capua and Nola, were founded by that people. The Etruscans then succumbed to the more warlike and hardy Samnites, who, in their turn, yielded to the irresistible valour of Rome (340 B.C.). Through all these vicissitudes of conquest, the substratum of the people remained as at the beginning. The mass of the Campanians

CAMPANILE—CAMPBELL,

were essentially of Oscan race, and Oscan they remained. Indeed, it is mainly from them that our knowledge of the Oscan language is derived, and one of their towns—Atella, between Capua and Naples—had the honour of introducing upon the early Roman stage a species of popular drama or comedy, which was greatly relished for its quaint and vigorous humour. See *ATELLANÆ*.

CAMPANILE (Ital. from Mid. Lat. *campana*, a bell), a name adopted from the Italian to signify a bell-tower of the larger kind, and usually applied only to such as are detached from the church. Scarcely any of the existing bell-towers of England answer to the Italian conception of the C., but it is said that there was a very fine one at Salisbury, 200 feet in height, which was destroyed by Wyatt. In Italy, they are found everywhere—at Bologna, Padua, Ravenna, Cremona, Venice. Perhaps the most remarkable are the so-called 'leaning tower' of Pisa, and the C. of Florence. The former, which is circular in form, is decorated with columns and arcades to the summit of its eight stories, and presents a very imposing appearance, reminding the traveller of the Coliseum at Rome, from which, and the now destroyed Septizonium, the idea of it is said to have been taken by the architects Bonano of Pisa, and Wilhelm of Innspruck. But though less curious, the famous C. of Giotto is perhaps even more worthy of the traveller's attention. It was erected in 1334, with the express object of surpassing, both in height and in richness of workmanship, any of the remains of antiquity. In form, it is a parallelopiped, and is of the same dimensions from bottom to top. Though it is very lofty—267 feet—it consists of only four stories, of which the tallest are the uppermost and undermost; and the windows in the upper story are rather larger than those in the two beneath, the object being to counteract the diminution to the eye occasioned by the greater distance. The effect of this arrangement has been much praised by architects; but there seems ground for scepticism as to its advantages. The style is the real Italian Gothic, which unites simplicity with great richness of ornamentation. The original design of Giotto was that a spire of 100 braccia in height should have surmounted the present structure, and on the summit may be seen the four great piers from which it was intended that it should have risen. The splendid C. of Florence, in its present condition, must thus be regarded only as a fragment. There is a fine C. at Seville, 350 feet in height, which was built by Guever the Moor in 1568. It is called La Giralda, from a brazen figure, which, though it weighs a ton and a half, turns with the wind.

CAMPANULA (Lat., a little bell), a genus of plants of the natural order *Campanulaceæ* (q. v.), distinguished by a bell-shaped corolla with five broad short segments, filaments dilated at the base, a 2—5-cleft stigma, and a top-shaped capsule with 2—5 cells, opening by lateral clefts below the calyx segments. The species are very numerous, chiefly but not exclusively abounding in the northern parts of the world, and the more elevated districts of the temperate zones. They are mostly herbaceous, some of them annual. The name **BELL-FLOWER** is common to many of them, and is often extended to all. The flowers are in general beautiful, and many of the species are therefore frequent ornaments of flower-borders. Of the native British species, the most common, and one of the most beautiful, is the **HAREBELL** (q. v.) or **BLUEBELL** (*C. rotundifolia*). The **CANTERBURY BELL** (*C. Medium*) is a very beautiful annual, which has long been so generally sown in flower-borders in Britain, that it is almost as

familiar to every one as the most common field-flowers. It is a native of the central parts of Europe.—Medicinal virtues were formerly ascribed



Harebell (*Campanula rotundifolia*).

to some species, particularly in affections of the throat, wherefore *C. Trachelium*, frequent in woods in England, has received the name of Throatwort; but they are now regarded as inert.—The roots of some are reckoned among esculents, as those of the **RAMPION** (q. v.), (*C. Rapunculus*), occasionally cultivated in Britain, and much more generally in some parts of continental Europe.

CAMPANULACEÆ, a natural order of exogenous plants, herbaceous or half shrubby, with a bitter milky juice; leaves without stipules, and generally alternate; the calyx usually 5-lobed, its tube adhering to the ovary; the corolla monopetalous, inserted into the top of the calyx, usually 5-lobed and regular; the stamens inserted into the calyx, and alternate with the lobes of the corolla; the fruit with two or more many-seeded cells, crowned with the withered calyx and corolla, and opening by division of the cells (*locucicidally*); the seeds fixed to the axis, and having fleshy albumen. About 500 species are known, natives chiefly of the temperate and colder climates of the northern hemisphere, where their blue or white flowers are among the finest ornaments of fields and woods. The roots and young leaves of some species are eatable, as is the half-fleshy fruit of *Canarina Campanula*, a native of the Canary Islands.

CAMPBELL, the family name of the Lords of Argyll. The origin of the family has not been satisfactorily ascertained. One theory makes it of Anglo-Norman origin; another traces its descent through a long line of Celtic chiefs to King Arthur. It first appears in record towards the end of the 13th c., when it held lands in Ayrshire and Argyll. The chiefs of the family having taken a prominent part in public affairs, the most distinguished are noticed under the head **ARGYLE**.

CAMPBELL, SIR COLIN, LORD CLYDE, one of the bravest soldiers and most distinguished generals of modern times, was born in Glasgow, in 1792. His father was a cabinet-maker, named John MacIver, but Colin assumed the name of Campbell, to gratify an uncle on the mother's side. He entered the army as an ensign in 1808; fought through the war in the Spanish peninsula

with distinction, and took part in the expedition to the United States in 1814. In 1842, he attained the rank of colonel, and in the same year he was present at the attack on Chusan, in China, and for his services there received honourable mention in the *Gazette*. He next served in the Punjab, commanding the left at the battle of Chillianwallah. For his conduct in this battle, Lord Gough awarded him the highest praise in his dispatch to the governor-general of India. He next commanded in the Peshawur district with uniform success against the hill-tribes. On the breaking out of the Crimean war in 1854, he was appointed to the command of the Highland Brigade, and took a prominent part at the battle of the Alma; and afterwards at Balaklava, where, with the 93d Highlanders, which he did not even form into square, he beat back the Russian cavalry, who were swooping down on the port, with its accumulation of shipping and stores. His services in this war were rewarded with promotion to the rank of major-general, and he was also created a Knight Grand Cross of the Order of the Bath, and received the Cross of the French Legion of Honour. He was appointed Inspector-general of Infantry, and in 1857, commander of the forces in India, then engaged in quelling the Indian mutiny, which by his energy and judgment was soon utterly subdued. One of the most notable characteristics of C.'s generalship, is the care he takes of the lives of his men, all his victories being won with the minimum expenditure of the blood of his soldiers. For his exploits in India, C., in 1858, was created a peer of the realm, with the title of Baron Clyde, and appointed a general, the East India Company granting him an annuity of £2000. C. arrived in Britain from India in July 1860.

CAMPBELL, GEORGE, D.D., an eminent theological writer, was born at Aberdeen in 1719. He was educated for the law, but abandoned that profession for the study of divinity. In 1746, he was ordained minister of Banchory Ternan, a parish lying some miles south-west of Aberdeen; and in 1759, he was appointed Principal of Marischal College. His first work was his famous *Treatise on Miracles*, in answer to Hume. The dispute concerning miracles has assumed a new form in the present century, and C.'s arguments would not meet all the objections which the modern school of rationalists urge; but the work in its own day was greatly admired, and characterised as 'one of the most acute and convincing treatises that has ever appeared on the subject.' It was speedily translated into French, Dutch, and German. In 1771, C. was elected Professor of Divinity in Marischal College. In 1776, he published his *Philosophy of Rhetoric*, which is still a standard work on the subject. His last work was a *Translation of the Gospels, with Preliminary Dissertations and Notes*. He died April 6, 1796. After his death appeared his *Lectures on Ecclesiastical History*.

CAMPBELL, JOHN (CAMPBELL), LORD, High Chancellor of England, son of a minister of Cupar, in the county of Fife, Scotland, was born in 1779. He was at first destined to follow his father's profession, and was sent, while still a mere boy, to the neighbouring university of St Andrews. C. himself had no inclination for a clerical life, and when he had completed his studies in the Faculty of Arts, he left for London, being then about 19 years of age. He obtained employment on the staff of the *Morning Chronicle*, where, in due time, he was intrusted with the care of the theatrical criticism and the reports in the House of Commons. He was called to the bar in 1806. His

sound sense, and unpretending activity and devotion to business, were awarded with an extensive common-law practice, and, after a time, with professional promotion. The silk-gown of a king's counsel was conferred upon him in 1827. Three years afterwards, he entered parliament, actuated, he tells us in the preface to one of his works, by a desire to obtain for England the benefits of a national registry of titles to land. The effort, at the time, was unavailing, as the landlords, whom it was destined more immediately to benefit, completely misunderstood the purport of the project. C. was promoted by the Whig party, to which he had attached himself, to the Solicitor-generalship in 1832, and to the Attorney-generalship in 1834. In the same year, he was chosen the representative in parliament for Edinburgh. He continued to represent Edinburgh down to 1841, and remained in the office of Attorney-general during that period, with the exception of the short time in 1835, when the Conservatives were in power. In 1841, he was made Chancellor of Ireland and a peer of the United Kingdom; but held the office of Chancellor for only a few months, when the Melbourne cabinet left office, necessitating C. also to resign. For the first time since boyhood, he found himself without regular daily labour, and at the mature age of 60, set to work to win the literary fame which he professes always to have secretly coveted. His first publication was a collection of his speeches at the bar and in the House of Commons. For three or four years after the publication of his speeches, C. was engaged in the preparation of the *Lives of the Chancellors*, the first series of which appeared in 1845. In 1846, he joined the Russell cabinet in the capacity of Chancellor of the Duchy of Lancaster. His ministerial duties were not sufficiently arduous to interrupt his literary labours, and he proceeded to complete the *Lives of the Chancellors*, and to publish a supplemental series of *Lives of the Chief-justices of England*. Both works have enjoyed great popularity, but leave no doubt that the author was more fitted for a practical lawyer than for a man of letters. C. returned to more congenial labours in 1850; he was then appointed to succeed Denman as Chief-justice. He held the office for nine years, at the end of which he received the highest honour that can be obtained by a member of the legal profession—the Chancellorship of England.

CAMPBELL, THOMAS, a distinguished English poet, was born in the city of Glasgow, 27th July 1777. His father was a merchant, and the poet was the youngest of ten children. He was sent to the university of his native city, and remained there six years. During his collegiate course, he received several prizes, and was particularly distinguished for his knowledge of Greek literature. On leaving the university, C. went to reside as a tutor for a year in the island of Mull. The scenery of the West Highlands made a deep impression on his mind, and to his abode in these grand and desolate regions we are indebted for many of the touches of sublimity which occur in his verses. Returning from Argyleshire, C. meditated the study of law, and repaired to Edinburgh; but he could not shake off his recollections. In his eyes, the mists were folded on the hills of Morven, the roar of Corrievekin was in his ears, and instead of prosecuting the study of jurisprudence, he wrote *The Pleasures of Hope*. The poem was published in 1799, and went through four editions in a twelve-month. After its publication, C. went to the continent; and on December 3, 1800, witnessed from a Bavarian monastery the battle of Hohenlinden, fought between the French and Austrians. In 1801, he returned to England, with *The Exile of*

Erin and Ye Mariners of England in his port-manteau; and shortly after, took up his abode in Edinburgh, where *Lochell's Warning* was composed. In 1803, C. proceeded to London, and adopted literature as a profession. He contributed articles to *The Edinburgh Encyclopedia*, and compiled *The Annals of Great Britain from the Accession of George II. to the Peace of Amiens*, in 3 vols. In 1806, through the influence of Mr Fox, C. received a pension of £200 per annum from government. In 1809, he published *Gertrude of Wyoming*, which bears the same relation to *The Pleasures of Hope* that *The Castle of Indolence* bears to *The Seasons*—a less brilliant and striking, but more mature and finished performance. In 1818, C. was again in Germany, and on his return, he published his *Specimens of the British Poets*, in 7 vols. In 1820, he delivered a course of lectures on poetry at the Surrey Institution. From this date to 1830, C. edited *The New Monthly Magazine*, and contributed thereto several poems, one of which, *The Last Man*, is in some respects the loftiest of all his performances. In 1824, he published *Theodoric and other Poems*. In 1827, he was elected Lord Rector of the university of Glasgow, and received the unusual honour of re-election the two following years. He published *The Pilgrim of Glencoe and other Poems* in 1842. His later publications did not add to his fame. He died at Boulogne in 1844, and was buried in Westminster Abbey, Macaulay, Dean Milman, and other celebrated persons bearing the pall.

C. is an established English classic. With the young, *The Pleasures of Hope* will ever be a chief favourite; while readers of maturer years will linger with delight over the silvan scenery and tender domestic scenes of *Gertrude*. It is in his lyrics, however, that C. has ascended highest into the heavens of song—*Hohenlinden*, *Ye Mariners of England*, and *The Battle of the Baltic*, cannot be paralleled in the language. Than these lyrics, nothing can be more simple and spirited. Once read, they cannot be forgotten. They will fan the patriotism of many generations.

J. Campbell

Campbell's Autograph.

CAMPBELL ISLAND, a lonely spot on the South Pacific, in lat. 52° 33' S., and long. 169° 9' E. Though it is mountainous, and measures only 36 miles round, it is yet valuable on account of its harbours. It is also scientifically interesting, being volcanic, and displaying a rich and rare flora.

CAMPBELTON, a royal borough and seaport, on the east coast, near the south end of the peninsula of Cantire, Argyleshire, and the most important town in that county, is 65 miles west-south-west of Glasgow, on a fine harbour or sea-loch, 2 miles long, and 1 mile broad. It is noted for the number—between 20 and 30—of its whisky distilleries. It unites with Ayr, Inverary, Irvine, and Oban to return one member to parliament. A sculptured granite cross stands in the principal street, and is supposed to have been brought from Iona. Pop. 6880. The chief exports are whisky, herrings, and Highland cattle and sheep. In 1858, 2912 vessels, of 238,360 tons, entered and cleared the port. C. is a favourite summer resort.

CAMPEA'CHY, a seaport on the west side of

the peninsula of Yucatan, which divides the Caribbean Sea from the Gulf of Mexico. It is in lat. 19° 50' N., and long. 90° 33' W. Though it has a shallow haven, yet it is the centre of the trade in logwood; it exports likewise cotton and wax. It is a handsome city of 15,000 inhabitants, containing churches, convents, a cemetery, a theatre, a college, and ship-building docks.

CAMPER, PETER, one of the most learned and acute physicians and anatomists of the 18th c., was born at Leyden, 11th May 1722, and studied medicine there. In 1750, he became professor of medicine at Franeker; in 1755, at Amsterdam; and in 1765, at Groningen. In 1773, he resigned his post, resided some time at Franeker, and then travelled. On being elected a member of the state council in 1787, he removed to the Hague, where he died, 7th April 1789. C. was distinguished not only for the services he rendered to anatomy, surgery, obstetrics, and medical jurisprudence, but also as a promoter of the fine arts. He was remarkably skilful in pen-and-ink drawing, painted in oil, embossed, and even acquired considerable experience as a sculptor. For his observations on the facial angle, see article **ANGLE**. His work on the connection of anatomy with the art of drawing was an important contribution to the theory of art. Another work, *Description Anatomique d'un Eléphant Mâle*, edited by his son, G. A. Camper, and published at Paris in 1802, is also worthy of notice. C.'s collected writings, with plates, appeared under the title, *Œuvres qui ont pour Objet l'Histoire Naturelle, la Physiologie et l'Anatomie comparée*, 3 vols. (Par. 1803).

CAMPERDOW'N, a village of Holland, 27 miles north-west of Amsterdam, celebrated on account of the victory obtained off its coast by Admiral Duncan over the Dutch fleet, October 11, 1797. The Dutch fleet, consisting of 11 sail of the line and other smaller vessels, under the command of the gallant Admiral de Winter, had stolen out of the Texel during a storm, with the view to join the French fleet at Brest, when they were attacked by Admiral Duncan with 16 ships of the line. After an obstinate combat, attended with great loss on both sides, the Dutch admiral was compelled to strike, leaving 8 sail of the line and some smaller vessels in the hands of the English.

CAMP'PHENE, or **CAMP'PHILENE**, is an artificial variety of camphor obtained from turpentine, by acting thereon with the dry vapour of hydrochloric acid, and keeping the whole at a low temperature by immersing the vessel in a freezing mixture. A solid substance is produced, which separates in white crystalline prisms, and has the taste and agreeable aromatic smell of common natural camphor. As prepared, it is strictly a hydrochlorate of C.; but the latter can be obtained free from hydrochloric acid, by passing the vapour of the compound substance over dry heated quicklime, when the acid is held by the lime, and pure C. passes over. It is not so similar to ordinary camphor when thus freed from the hydrochloric acid.

CAMP'HINE is the name applied to a variety of spirit of turpentine obtained from the *Pinus australis* of the Southern States of America, and rather extensively sold and used in Britain for burning in out-of-door lamps. It is very volatile, and burns very freely, giving off a pure white brilliant light; and when the vapour diffuses itself through air, and is set fire to, it forms a dangerous and violently explosive mixture.

CAMP'HOR is a solid essential oil which is found in many plants, and may be separated from many essential oils. It particularly abounds in

certain species of the natural order *Lauraceæ* (q. v.). Almost all the C. of commerce is the produce of the C. Laurel or C. tree (*Camphora officinarum*, formerly known as *Laurus Camphora*), a native of China, Japan, Formosa, and Cochin-China, and which has been introduced into Java and the West Indies. The genus *Camphora* differs from *Cinnamomum* (see CINNAMON) chiefly in having a thin instead of a leathery calyx. The C. Laurel is a tree of considerable height, much branched, with lanceolate, evergreen leaves on short stalks, and small yellowish-white flowers in axillary and terminal panicles. The fruit is in size and appearance not unlike an imperfectly ripened black currant. Every part of the tree, but especially the flower, smells strongly of camphor. The wood is light and durable, not liable to be injured by insects, and much valued for carpenter's work. In the extraction of C. from the C. Laurel, the wood of the stem and branches is chopped up into fragments, and introduced into a still with water, and heat applied, when the steam generated carries off the C. in vapour. These vapours rise, and in passing through rice-straw, with which the head of the still is filled, the C. solidifies, and is deposited round the straw in minute grains or particles, somewhat about the size of raw sugar or coarse sand. These grains of impure C. are detached, and being introduced into a large globular glass vessel in quantities of about 10 lbs., are reheated, when first the water rises in steam, and is allowed to escape at a small aperture; and thereafter, this aperture being closed, the C. sublimes and resolidifies in the interior upper part of the flask, as a semi-transparent cake, leaving all the impurities behind. The flasks are then cooled and broken by throwing cold water on them, and the C. taken out, and sent into market. The glass globes employed are called by an Italian name, *bomboloes*, the sublimation of C. having been first practised in Venice.—C. was unknown to the Greeks and Romans, and was first brought to Europe by the Arabs. It is a white tough solid, slightly lighter than water, and floats thereon. It is very sparingly soluble in water, but freely soluble in alcohol, ether, acetic acid, and the essential oils. It fuses at 347°, and boils at 399°, and when set fire to, is very inflammable, and burns with a white smoky flame. Thrown upon water, it floats, and may be set fire to, when the currents generated alike from the solution in water and the irregular burning of the pieces, cause a curious rotatory motion. It has a peculiar hot aromatic taste, and an agreeable characteristic odour.

C. is used in medicine, both internally and externally, as a temporary stimulant. It is frequently employed in gout and rheumatism. In small doses, it acts as an anodyne and antispasmodic; in very large doses, it is an irritant poison. It is generally reckoned an anaphrodisiac. Its alcoholic solution and liniments in which it is the principal ingredient, are much used for external application in sprains and bruises, chilblains, chronic rheumatism, and paralysis.—The effluvia of C. are very noxious to insects, and it is therefore much used for preserving specimens in natural history.

The BORNEO C. or SUMATRA C. of commerce, sometimes called HARD C., is the produce of *Dryobalanops aromatica*, a large tree of the natural order *Dipteraceæ* (q. v.). The C. is obtained by cutting down the tree, and splitting it into small pieces; being found in crystalline masses in natural cavities of the wood. To this substance, the Chinese ascribe extraordinary medicinal virtues, so that it is sold among them at more than fifty times the price of common camphor. It is seldom brought to Europe

as an article of commerce.—The *Dryobalanops aromatica* yields also a pale-yellowish limpid fluid, which gushes out when deep incisions are made in the tree with an axe, and which is generally called LIQUID C. or C. OIL. It is sometimes imported into Europe. It has a smell somewhat resembling that of C., but more aromatic, like oil of cajeput. It is supposed to be from this fluid that the crystalline HARD C. is deposited. See BORNEENE.

CAMPI, a family of artists, who founded at Cremona, in the middle and near the close of the 16th c., an eclectic school of painting, parallel with that founded by the family Caracci (q. v.). GIULIO C. (1500—1572) was the head of the school. He studied painting, sculpture, and architecture under Giulio Romano. He also imitated the works of Titian (at least in colouring) and Pordenone with such success that his pictures have sometimes been ascribed to both of these artists. His female heads, like those of his brothers, are remarkably beautiful.—ANTONIO C. studied, under his brother, both painting and architecture. His knowledge of the latter was very serviceable in several of his paintings; for example, that of the sacristy of St Peter. He was also a plastic artist, an engraver, and the historian of his native place.—VINCENZO C. (b. before 1532, d. 1591) seems to have followed the guidance of Antonio rather than that of Giulio, and excelled more in small figures than in large pictures. His paintings of fruits are highly valued.—BERNARDINO C. (b. 1622, d. about 1590), a kinsman of the three brothers C., was the most famous of the whole. Lanzi terms him 'the Annibale Caracci' of the school. He studied first under Giulio C., but soon excelled his master. Afterwards, he chose Giulio Romano, Titian, and Correggio as models, but chiefly followed Raphael, yet without servile imitation. Many of his works are found in Milan and Cremona. In the latter place, the cupola of the choir in the church San-Gismondo is Bernardino's master-piece. He was distinguished as a portrait-painter and engraver.

CAMPION. See LYCHNIS, and SILENE.

CAMPLI, a town in the province of Abruzzo Ultra, Naples, about 5 miles north of Teramo. It has a cathedral, an abbey, and several convents. Pop. 7125.

CAMPOBA'SSO, a fortified town of Naples, in the province of Molise, about 53 miles north-north-east of the city of Naples. It has a fine cathedral, a ruined castle, some convents, and palaces belonging to resident nobles. It has manufactures of cutlery, which enjoys a considerable reputation for excellence. Its situation, though far from inviting as regards scenery, is favourable for trade, which is facilitated by good roads. Pop. 10,400.

CAMPOBELLLO, an island of New Brunswick, situated at the mouth of the Passamaquoddy Bay, in lat. 44° 57' N., and long. 66° 55' W. It is small, being 9 miles long, and from 1 to 3 miles broad; but it is decidedly valuable, possessing some good harbours, and, at its north end, a light-house of 60 feet in height.

CAMPO DE CRIPTANA, a town of Spain, in the province of, and about 50 miles north-east of the city of Ciudad-Real. It has manufactures of coarse cloths, and some trade in corn and fruits. Pop. 5250.

CAMPO-FORMIO, a village in the province of Friuli, Northern Italy, about 7 miles south-west of the city of Udine, is celebrated for the treaty of peace here concluded, October 17, 1797, between Austria and the French Republic. After subjugating Italy (1796), the French army had crossed the

Noric Alps, and threatened Vienna. Austria, therefore, hastened to arrange preliminaries of peace. In the treaty which was concluded by Bonaparte with the Count of Coblenz, 17th October 1797, Austria ceded the Netherlands, Milan, and Mantua, and received as compensation the districts Istria, Dalmatia, and the left bank of the Adige in the Venetian states, and the capital, Venice; while France took the remaining territory of Venice, its possessions in Albania, and the Ionian Islands. In the secret articles of the treaty, Austria, in ceding the left bank of the Rhine, was to receive as compensation Salzburg and the Bavarian district on the Inn; and promises were held out to the Duke of Modena, and other Italian houses, that their concessions should be compensated at the cost of Germany.

CAMPOMANÉS, PEDRO RODRIGUEZ, COUNT OF, Spanish minister and director of the Royal Academy of History at Madrid, founded by Philip V. in 1738, was born in Asturias in 1723. His talents and learning were devoted to the advancement of his native country. By his enlightened views of state policy, as well as by his writings, which ranked him among the most eminent Spanish authors, he obtained a great reputation throughout Europe. He gave effectual assistance to Count Aranda in his difficult enterprise of driving the Jesuits out of Spain. He died February 3, 1802. C.'s chief works are—*Antigüedad Marítima de la Republica de Cartago con el Périplo de su general Hannon, traducido del Griego y ilustrado* (Madrid, 1756); *Discurso sobre el fomento de la Industria popular* (1771); *Discurso sobre la Educacion popular de los Artisanos y su fomento* (1775); *Apéndice a la Educacion popular* (1775—1777). These writings contained his opinions on politics, taxation, agriculture, manufactures, and commerce. The best known of his financial productions is *Tratado de la Regalia de Amortizacion* (Madrid, 1765).

CAMPO SANTO (Holy Field) is now the Italian designation for a cemetery or burying-ground, but more especially for an enclosed place of interment, surrounded internally by an arcade, and destined to receive the remains of persons of distinction. The most famous C. S., and that from which the others derived the name, is that of Pisa—in the neighbourhood of the Dome, and consecrated to the memory of men who had deserved well of the republic. It was founded by Archbishop Ubaldo, towards the end of the 12th century. The archbishop, having been driven out of Palestine by Saladin, brought his fifty-three vessels, which had been destined for the conquest, laden with the earth of the Holy Land. This he deposited on the spot which was thence called the Holy Field, and which, as we have said, gave its name as a generic term to the burying-grounds of Italy. The architect of the existing building was Giovanni Pisano, under whose superintendence it was completed in 1283. It contains an area of 400 feet in length, and 118 in breadth; and is surrounded by a lofty wall, on the inner side of which a wide arcade runs round the whole enclosure, giving to it the character of one magnificent cloister. At the smaller eastern side, there is a large chapel, and two chapels of smaller size on the northern side. The lofty circular arches of the arcade are filled with the richest Gothic tracery, which belongs, however, to a later date—the latter half of the 15th c.—and consequently formed no part of the original design. The walls are adorned with frescoes, which are of great interest and value, both absolutely and with reference to the history of art. The oldest of those which have been preserved adorn one side of the eastern wall:

they represent the passion of Christ, his resurrection, and other sacred subjects. These remarkable paintings are supposed to date before the middle of the 14th c., and are ascribed to Buffalmaco. But the most marvellous productions are those of Giotto (q. v.), of Simone Memmi, the friend of Petrarch, and of Andrea and Bernardo Orcagna. As a museum of classical antiquities, the C. S. is perhaps even more remarkable than in any other point of view. Altars, sarcophagi, bas-reliefs, statues, inscriptions, everything that is interesting or curious which has come into the possession of the Pisans for centuries, they have accumulated within its walls.

CAMPVERE, now called **VERE** or **VEERE**, a small fortified town of the Netherlands, in the province of Zealand, in Walcheren Island, 4 miles north-north-east of Middleburg. It has a port on the Veersche Gat, a tract of water separating Walcheren from North Beveland. The town is now in a state of deplorable decay, but it still possesses remnants of its early prosperity in its town-house of white freestone, remarkable for its elegant tower, and in its beautiful cathedral. C. has now one calico-factory. Its population has dwindled down to a few hundreds.

From a historical point of view, C. is a city of great interest. In the year 1304 it was the scene of a battle between Guy, Count of Flanders, and William, governor of Holland and Zealand, in which the first was victorious. In 1572, it was delivered from the Spanish garrison; and, a century later, it was the first to proclaim the Prince of Orange, William III., stadtholder. But C. is chiefly interesting for the trading relations subsisting between it and Scotland for nearly four centuries. Wolfaard van Borssele, Lord of Vere, Sandenburg, &c., having married Mary, the sister of James I. of Scotland, the Scotch staple was transferred from Bruges to C. in 1444. C. owed its name to the circumstance, that there originally existed, a *ferry* (Dutch, *veer*) from thence to the village of Campen, in North Beveland, a village situated on the spot where now lies the hamlet of Kamperland. The Scotch staple-right at Vere consisted in the privilege of having all goods, destined from Scotland to the Netherlands, brought to that city; and they could not be transferred to another place before they had been sold there. The numerous Scotchmen living at Vere were under the rule of a 'Conservator of the Scotch nation,' and had many privileges conceded to them, including the right to be governed by the law of Scotland. The last treaty respecting those rights was in 1741, after which time the increasing prosperity of Scotland rendered the renewal of such partial arrangements unimportant. The conservatorship, however, was held as a sinecure long after the necessity for the office had ceased, the name of Sir Alexander Ferrier appearing in the *Edinburgh Almanac* as 'Conservator at Campvere' so lately as 1847, after which time the office seems to have been abolished. The Scotch formed a separate religious community, which, from 1613 until the French Revolution, had a minister of its own, and afterwards, till 1809, was served by the minister of Vlissingen, when it ceased to exist.

CAMTOO'S, or **GAMTOO'S**, a river of the east division of the Cape Colony, of 200 miles in length. It rises in the Nieuwveld mountains, near lat. 32° S., and, flowing through the inland district of Beaufort, and the maritime one of Uitenhage, falls into that inlet of the sea which is immediately to the west of Algoa Bay. It is valuable as an aid to irrigation. For instance, Hankey, a station of the London Missionary Society on its banks, is

thoroughly watered by means of a splendid tunnel carried through solid rock at the expense of the association just mentioned.

CAMUCCINI, VINCENTO, one of the most distinguished modern historical painters in Italy, was born in Rome 1775. The school of which he became the head was founded on the theatrical antique style of the French painter David. The first important works by C. were the 'Assassination of Cæsar' and the 'Death of Virginia,' both painted for Lord Bristol at the commencement of the present century. His picture of 'Unbelieving Thomas' was copied in mosaic for St Peter's Church. For the church of San Giovanni in Piacenza he executed a 'Presentation in the Temple,' which was greatly admired. These works were followed by many scenes from Roman history; among them, the pictures of 'Horatius Cocles,' and 'Romulus and Remus' as children. C. who, as a man and an artist, was highly honoured during his career, died at Rome, September 2, 1844.

CAMUS, ARMAND GASTON, a prominent character in the French Revolution, was born in Paris, April 2, 1740. On account of his superior knowledge of ecclesiastical law, he was elected Advocate-general of the French clergy. He was a zealous and ascetic Jansenist, and possessed of extraordinary firmness of character. He hailed the movements of 1789 with joy, and was elected member of the States-general by the people of Paris. In this position, he appeared as the resolute foe of the ancient régime. He gained possession of, and published, the so-called *Red Book*, giving accounts of court expenditure, which was highly disadvantageous to the court and its ministers. After the flight of Louis XVI., C., with Montmorin, Lafayette, and Bailly, accused the king of treason and conspiracy, and insisted on the suppression of all orders and corporations based on hereditary rights. As conservator of the national archives, he rendered an important service by preserving from destruction the old documents of the abolished corporations and institutions. He was absent in Belgium during the king's trial, but sent his vote for death. In March 1793, when he was commissioned to make prisoners of Dumouriez and other generals suspected of treason, C. himself and his four colleagues were taken prisoners and delivered over to the Austrians (April 3); but, after an imprisonment of two and a half years, he was exchanged for the daughter of Louis XVI. On his return to Paris, he was made member of the Council of Five Hundred, of which he became president, January 23, 1796, but resigned 20th May 1797, and devoted his time to literature. Remaining, however, true to his principles, he voted, July 10, 1802, against Napoleon's proposed consulship during life. C. died of apoplexy, November 2, 1804.

CAMWOOD, or BARWOOD, a dyewood which yields a brilliant but not permanent red colour, and is used along with sulphate of iron to produce the red colour in English Bandana handkerchiefs. It is the wood of *Baphia nitida*, a tree of the natural order *Leguminosæ*, sub-order *Cæsalpinieæ*, a native of Angola. It is preferred to Brazil Wood (q. v.), as producing a finer and richer red.

CANA OF GALILEE, called by the natives 'Kefr Cana.' This place, celebrated in Scripture as the scene of our Lord's first miracle, when he turned water into wine, is now a small village of a few hundred inhabitants, who are principally Greek Christians or Nazarenes, situated about 13 miles west of the Sea of Galilee, and 6 miles north of Nazareth. At the entrance to the village there is a fountain of the clearest and most delicious water—the best, say the Christians of Palestine, in the

world: from it, it is supposed, the vessels for the marriage-feast were filled; and near the fountain are also lying the fragments of a Roman column. A house is still shewn as that in which the miracle was performed; and some earthen jars sunk into the floor are said to be the very jars in use on that day. A church was built over the spot, but it is now in ruins.

CA'NAAN. See PALESTINE.

CA'NADA, the most valuable province of British America, and perhaps the most important colony of the United Kingdom, is situated chiefly in the basin of the St Lawrence, including in that term both the lakes and the river. On the left side of the stream, it covers from end to end the whole depth back to the height of land which sends its northerly tribute into Hudson's Bay. But on the right side only a portion of the lower basin belongs to Canada. Beginning at the west, the boundary-line between C. and the United States runs along the mid-channel of the lakes and the river to the point where it meets the parallel of 45°; it then follows that parallel for about 150 miles, after which it bends northward nearly along the boundary of the basin, and finally eastward to the Bay of Chaleur.

The most important tributaries of the St Lawrence are all from the left, and therefore belong to Canada. The Ottawa, the St Maurice, and the Saguenay are rivers of the first magnitude, according to European analogies. The only affluents from the right worthy naming are the Richelieu, the St Francis, and the Chaudière; and even of these subordinate streams, the last two are totally Canadian, while the first, as the outlet of Lakes Champlain and George, belongs to the United States only in part. C. has been estimated to contain 350,000 square miles, being about thrice the size of the British Isles: it stretches in W. long. from about 64° to about 90°, and in N. lat. from about 42° to about 53°. It has been cut into two tolerably equal sections—West and East, or Upper and Lower. The Ottawa, which joins the St Lawrence a little above Montreal, is the dividing-line, excepting that the immediate fork has been transferred from Canada West or Upper to Canada East or Lower.

C., as far up the St Lawrence as Montreal, was visited by the French in 1534. In 1609 they founded Quebec; and after holding the country rather as a military possession than as a colonial dependency for a century and a half, they were supplanted by the English under Wolfe and Amherst in 1759—1760. In 1763, immediately after the conquest had been ratified by cession, a small portion of the recently acquired territory was organised by royal proclamation under English laws. In 1774, the new province was extended by parliamentary enactment, and that under French laws, down the Ohio to its confluence with the Mississippi, and up the latter stream to its source. Finally, C. receded to its present limits in 1783, giving up to the American republic the sites of six sovereign states—Minnesota, Wisconsin, Michigan, Ohio, Indiana, and Illinois. In 1791, it was divided, under separate legislatures, into two sections—the eastern retaining French institutions, and the western receiving those of England; and these sections, again, after political discontent had in each ripened into armed insurrection, were re-united for legislative purposes in 1840.

In 1763, the French population amounted to about 65,000, occupying the immediate banks of the Lower St Lawrence and its tributaries. Excepting within the cities of Montreal and Quebec, the immigrants of a different origin, whether from the old colonies

CANADA.

British Miles

10 20 30 40 50 60 70 80 90 100

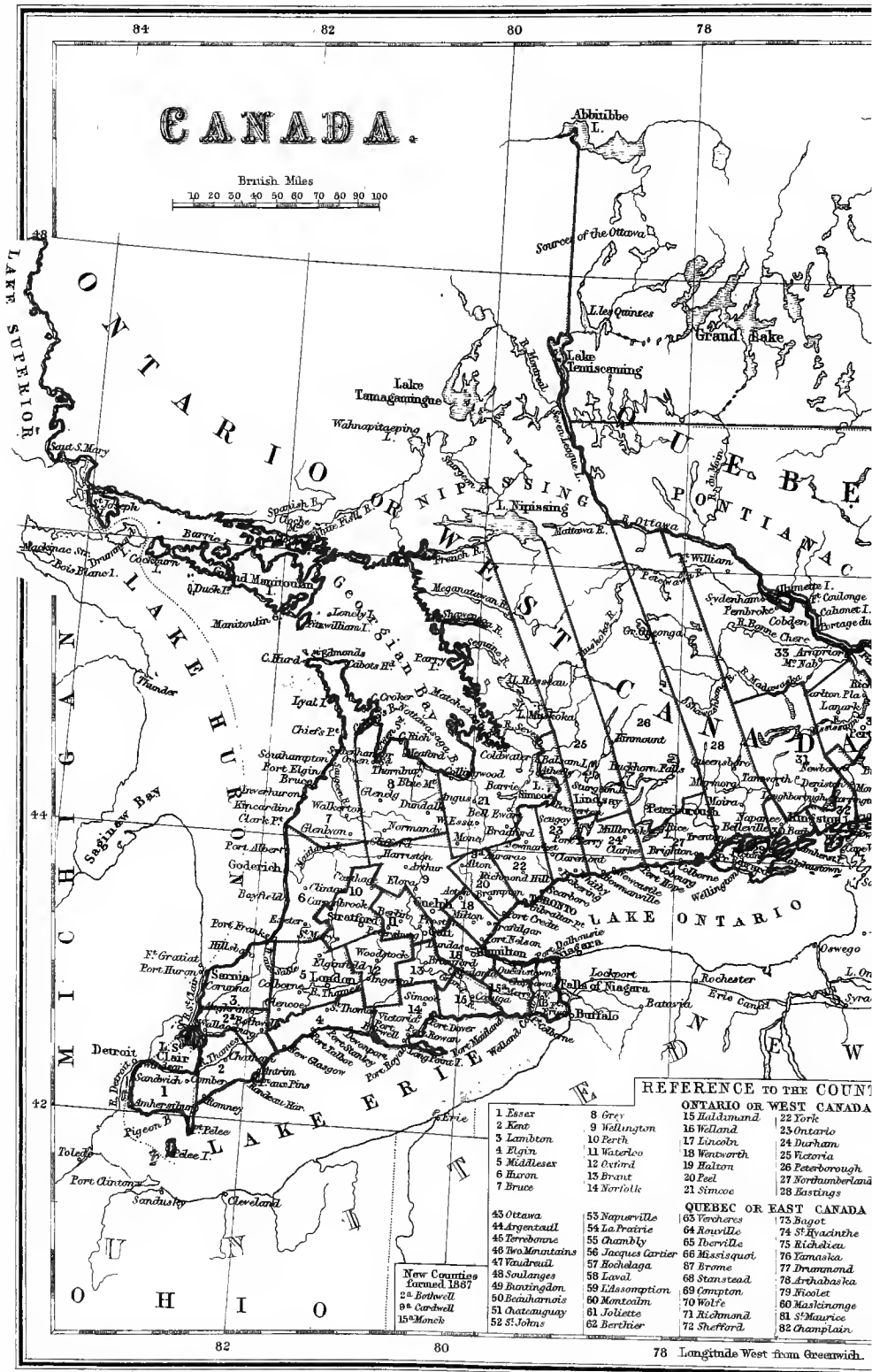

REFERENCE TO THE COUNTIES

1 Essex	8 Grey	15 Haldimand	22 York
2 Kent	9 Wellington	16 Welland	23 Ontario
3 Lambton	10 Perth	17 Lincoln	24 Durham
4 Elgin	11 Waterloo	18 Wentworth	25 Victoria
5 Middlesex	12 Oxford	19 Halton	26 Peterborough
6 Huron	13 Brant	20 Peel	27 Northumberland
7 Bruce	14 Yorkville	21 Simcoe	28 Hastings
43 Ottawa	53 Napaneeville	QUEBEC OR EAST CANADA	
44 Argenteuil	54 La Prairie	63 Verchères	73 Bagot
45 Terrebonne	55 Chambly	64 Rouville	74 St Hyacinthe
46 Two Mountains	56 Jacques Cartier	65 Dorville	75 Richelieu
47 Tadoussac	57 Hochelaga	66 Missisquoi	76 Yamaska
48 Soulanges	58 Lével	67 Bromé	77 Drummond
49 Barington	59 Edouard	68 Stanstead	78 Archaie
50 Beauharnois	60 Montcalm	69 Compton	79 Froot
51 Outaouais	61 Joliette	70 Wolfe	80 Maskinonge
52 St Johns	62 Berthier	71 Richmond	81 St Maurice
		72 Shefford	82 Champlain

New Counties formed 1867
 24 Bethwell
 24 Carleton
 15 Monck

Printed in Colour by W.H. Macdonald, Edm.

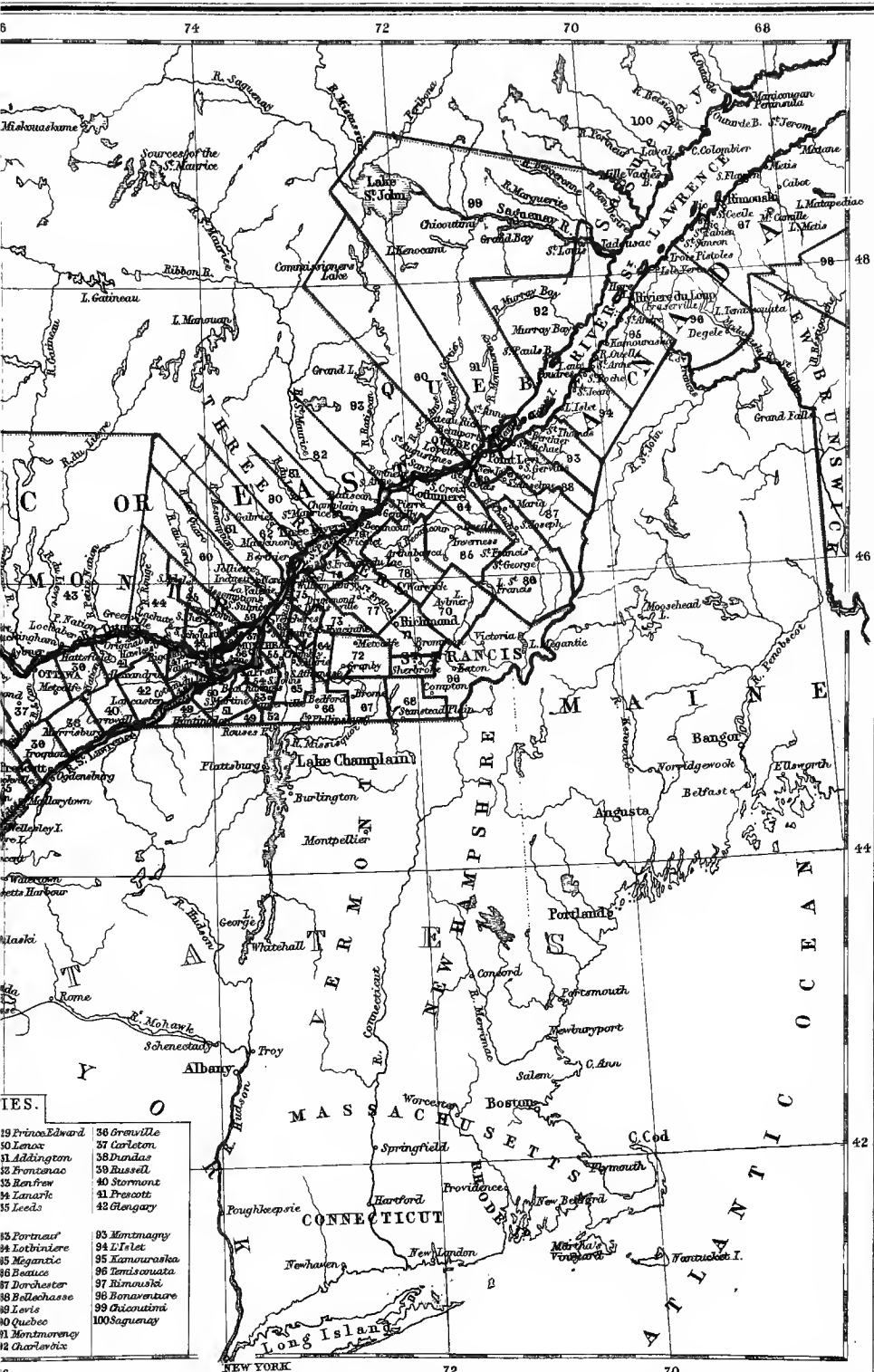

IES.

19 Prince Edward	36 Greenville
20 Lewis	37 Carleton
21 Addington	38 Dundas
22 Frontenac	39 Russell
23 Renfrew	40 Stormont
24 Lanark	41 Prescott
25 Leeds	42 Glengary
26 Portneuf	85 Montigny
27 Lotbiniere	84 L'Islet
28 Megantic	85 Kamouraska
29 Beauce	86 Bonaventure
30 Dorchester	87 Rimouski
31 Bellechasse	88 Bonaventure
32 Lewis	89 Gaspesie
33 Montmorency	90 Quebec
34 Charlevoix	91 Saguenay

CANADA.

or from the mother-country, scarcely attempted to establish themselves among the ancient settlers; thus producing a kind of reciprocal isolation, which, even down to the present day, has not been materially disturbed. Generally speaking, therefore, the two grand elements of the provincial population are locally distinguished from each other—a relative position which has happily excluded, as between them, nearly every difficulty as to education and religion. The settlers of French origin, almost entirely confined to East C., occupy the banks of the St Lawrence and of the lower courses of its tributary streams; all the rest of East C. and the whole of West C., so far as they are reclaimed at all, belong to colonists of English race. According to the census of 1851, the former numbered about 700,000; while the latter, including a small proportion neither English nor French, amounted to about 1,140,000. The population of French origin may be reckoned, according to natural increase, to amount in 1860 to 875,000; the others, taking immigration into account, to 1,710,000. The way in which the population was divided, in 1851, in respect of creed, will be seen from the following table:

	Canada East.	Canada West.
Church of England,	46,402	223,190
Church of Scotland,	4,047	57,642
Church of Rome,	746,866	167,655
Free Presbyterians,	267	65,807
Other Presbyterians,	29,221	80,799
Wesleyan Methodists,	5,799	96,640
Episcopal Methodists,	7	43,884
New Connection,	3,442	7,647
Other Methodists,	11,935	59,585
Congregationalists,	3,927	7,747
Baptists,	4,438	45,353
Lutherans,	18	12,089
Quakers,	163	7,460
Jews,	348	103
Others not Classed,	34,326	76,563
Totals,	690,261	952,004

The two divisions of the province present a striking contrast in their rates of progress. To take, for instance, the growth of towns: In Lower C., Sherbrooke, the capital of the Eastern Townships, with about 1500 inhabitants, forms almost the only addition to Quebec, Three Rivers, and Montreal—the three French foundations; in Upper C., besides five cities, to be immediately noticed, there are already six-and-thirty towns at least equal, on an average, to Sherbrooke. With respect, again, to cities, properly so called, the growth of Montreal and Quebec, remarkable enough in itself, has been owing rather to their commercial facilities with regard to the country at large than to the agricultural resources of their immediate vicinities; while Toronto, London, Kingston, and Hamilton—each nurtured chiefly by its own locality—have an aggregate population of about 100,000; the first two having quadrupled their numbers respectively within the last 20 and 10 years.

Great part of C., more especially the shores of Lake Superior, is valuable only for mineral resources, such as iron, zinc, lead, copper, silver, gold, cobalt, manganese, gypsum, marl, granite, sandstone, limestone, slate, and marbles of nearly every imaginable colour. Considerable portions, also, though heavily timbered, chiefly with pine, are yet but little adapted to settlement and cultivation. Towards the gulf of the St Lawrence, again, a considerable section derives importance mainly from the fisheries, being, with partial exceptions in Gaspé, comparatively worthless for every other object. Thus the area for the profitable production of ordinary cereals cannot materially exceed 40,000 square miles, containing, however, within this space a singularly small proportion of irreclaimable surface. This cultivable block increases regularly in width and fertility, from its

commencement on the Lower St Lawrence to the shores of Lake Huron. Below Quebec—to say nothing of the precarious nature of the crops—there may always be seen, on one or on both sides, the primeval forest. Between that city, again, and the basin of the Ottawa, a gradual improvement shews itself, even on the north side; and towards the south, there stretches away to the frontier of the United States a broad belt of generally undulating character, probably the best field in the country for the blending of pasturage and agriculture. From the basin of the Ottawa inclusive, the parallel of the south end of Lake Nipissing may be said to cut off, towards the south-west, the entire residue of the practicable soil, in the shape of a roughly defined triangle, which, as a whole, is at least equal, in the growth of grain in general and of wheat in particular, to any region of the same extent in North America.

As C. slants southwards eight or nine degrees from the mouth of the St Lawrence to that of the Detroit, which communicates between Lakes St Clair and Erie, the climate of the west must be warmer than that of the east. In addition to this cause of difference, it holds as a general law over the continent that the climate improves in advancing westward, even on the same parallel. Besides, the lakes of Upper C. appear, in a good measure, to neutralise and mitigate the extremes of a Canadian climate. While Quebec in winter ordinarily enjoys five or six months of sleighing, the corresponding season in Toronto ranges from five or six days to five or six weeks. As to summer, the difference in favour of Toronto is rather in point of duration than of intensity. As indications of the climate of C., it may be stated that the isle of Orleans, immediately below Quebec, is famous for its plums, and the island of Montreal for its apples; and from the neighbourhood of Toronto to the head of Lake Erie, grapes and peaches ripen without any aid whatever. Melons, again, of large size, come to maturity, through the settled parts of the province, in the open air; and pumpkins and squashes attain enormous size, some of them near-Toronto having weighed 300 lbs. The climate of C., though, as a whole, vastly steadier than that of the British Isles, is yet occasionally liable to such changes as among us are all but impossible. Montreal, for instance, may be said, on an average, to have an extreme cold of 24° below zero, and an extreme heat of 96° above it. Now, on short notice, a thaw may surprise the former temperature, and a frost the latter; so that there is room, in winter and summer respectively, for a comparatively sudden rise or fall of about 60°.

In the matter of communications, C. is unrivalled. The St Lawrence, with its lakes, puts it in connection at once with the most commercial sections of the United States, and with the open ocean. The navigation of this great water-system has been greatly assisted by art. Below Montreal, Lake St Peter has been deepened; and above that city, a series of cuts, skirting the rapids, admit sea-going vessels into Lake Ontario. Beyond this, the Welland Canal lifts the maritime navigation round the Falls of Niagara into Lake Erie. Without reckoning, therefore, the American works between Huron and Superior, the Canadian settlement at the foot of Sault Ste Marie, now a free port, is virtually, as it were, washed by the tides of the Atlantic. The government has subsidised a line of steam-ships, running weekly to England from the St Lawrence in summer, and from Portland, in the state of Maine, during winter. In addition to the navigation of the main artery, there are numerous canals and navigable streams and lakes throughout the province. The chief canal is the

Canada, connecting the river Ottawa with Lake Ontario.

Over and above all these facilities in the way of navigation, C. is not deficient in roads of every description. To say nothing of the snow and ice, with which, at least in the north and east of the country, the winter paves the length and breadth of land and water alike, or of the macadamised thoroughfares in the older localities, the government has recently laid out, in the newer and remoter townships, two great systems of highways, seven lines for the upper province, and five for the lower, subsidising, as it were, the same by free grants of 100 acres to each holder on both sides of every route, under condition of residence and cultivation. As to railways, C. has more miles in proportion to population than any country in the world. Exclusive of the Grand Trunk Railway, there are fourteen of these works of the aggregate length of 1006 miles, of which the Great Western from Niagara Falls to Detroit, including its branches to Guelph and Toronto, forms upwards of a third. The Grand Trunk, which extends from Detroit to below Quebec, with an extension to Portland, in the United States, in order to secure an ocean port in winter, has a length (exclusive of that extension) of 870 miles. The Victoria Bridge (q. v.), by which this railway crosses the St Lawrence at Montreal, is one of the wonders of the world.

In the face of the severe competition of energetic rivals, who were sooner in the field, C. now presents the shortest and cheapest and speediest route, whether for goods or for passengers, between Europe and the north-western states of the American Union. Hitherto, whatever may have occasioned the shortcoming, the incidental outlay has been very far from repaying itself. But, in the hope of ultimate success, the legislature has hesitated at no sacrifice. On the St Lawrence canals, which cost fully £1,500,000, it has entirely remitted, on behalf of provincial interests, all tolls and dues; and to the Grand Trunk Railway it has handed a virtual donation of more than £3,000,000. At the rate of even 5 per cent. a year, the two sunk capitals are equivalent to an annual payment in perpetuity of £225,000.

In 1858, the exports and imports of C., estimated in dollars of about 4s. 1d. sterling each, amounted respectively to 22,029,565 and 29,073,527. Among the various countries with which the colonial trade is carried on, the United States and Great Britain absorb between them at least 95 per cent. of the whole, the former alone considerably exceeding, in both branches, all the others taken together.

	Exports.	Imports.	Total.
Great Britain, . . .	8,898,611	12,295,487	21,194,098
N. American Colonies, .	960,428	415,375	1,375,803
United States, . . .	11,930,094	15,635,582	27,565,676
Other foreign countries,	240,432	732,083	972,515

Further, as between Great Britain and the United States, nearly every head of the exports establishes the same relative position. Thus:

	Great Britain.	United States.	Excess.
Produce of mines, . . .	112,040	202,793	90,743 U. S.
" fisheries, . . .	119,075	153,485	39,410 U. S.
" forest, . . .	6,089,060	3,318,174	2,770,886 G. B.
Animals and their products, .	132,470	2,232,368	2,099,898 U. S.
Agricultural products, . . .	1,627,885	5,744,959	4,117,074 U. S.
Manufactures, . . .	64,791	175,083	110,292 U. S.
Other articles, including } ships for sale, . . .	753,290	98,242	655,048 G. B.

The year 1858, partly from a failure of crops, and partly from an augmentation of duties, fell far short of 1857, and still more so of 1856. The year 1859, so far as its returns are accessible, exhibited an improvement as compared with 1853.

In 1858, the ordinary revenue from all sources reached 4,928,975 dollars, or about £1,000,000 sterling. The public debt was not less than £13,000,000 sterling.

The larger half of the provincial trade—namely, that with the neighbouring republic—is the result chiefly of a Reciprocity Treaty between C. and the United States. To say nothing of the mutual advantages of such intercourse to the parties interested, the compact in question places in a new light the commercial relation between the mother-country and the colonies. Within less than 100 years, Great Britain selfishly and heavily fettered even the internal economy of its American dependencies, issuing penal prohibitions against the making of hats and the working in iron—against everything, in a word, that threatened a practical abridgment of imperial monopoly; and now C., besides enjoying absolute immunity within its own borders from such extraneous interference, is permitted to negotiate with the nations, as freely as they negotiate with one another, on the subject of commerce and manufactures. In this respect, the colony of C. may challenge comparison with the neighbouring sovereign states.

Even politically, C. is virtually its own master as to its domestic concerns. Responsible government, as recommended by Lord Durham in 1838—1839, necessarily led to this result. In addition to the rule of a common sovereign, the single tie that still binds the colony to the mother-country is that of protection, military and diplomatic. In other words, the subordination of C. to the empire, so far from being a badge of subjection or an instrument of oppression, is a guarantee at once of external independence and internal tranquillity. The provincial constitution rests on the broadest basis. The elective franchise is nearly universal. Every man who pays 30 dollars of house-rent in city or town, or 20 in a rural district, is entitled to vote. Neither creed nor colour is any disqualification; while, by a residence of three years, a foreigner may acquire the right of suffrage.

The provincial parliament consists of two houses—the Council and the Assembly; while the authority of the crown is represented by a governor, who is at the same time Governor-general of the other North American colonies. The Council, at present in a state of transition between royal nomination and popular election, has 54 members in all—30 nominated and 24 elected equally between the two sections of the colony. The Assembly, again, contains 130 representatives—65 for Upper C. and 65 for Lower Canada. Lower C. returns 8 for four cities and towns, and 57 for as many counties; while Upper C., with 9 for eight cities and towns, apportioning 56 between twenty-five counties and the thirty-one ridings of fifteen more. The parliament is elected for four years. Before the union, the separate places of meeting were Quebec and Toronto. Since then, the united parliament has been successively held in Kingston, Montreal, and Toronto; and at present (1860), it provisionally sits at Quebec, till Ottawa, lately chosen as the capital, where the Prince of Wales has just laid the foundation-stone of the requisite buildings, may be ready to receive it.

Detailed statistics with respect to so extensive a country, the intending emigrant must not expect to find in so brief a summary as this; suffice it to say, that, whatever may be his means and views, he will meet in C. all the main elements of comfort and prosperity—the civilisation of Europe with the cheaper land and higher wages of America. Besides the free grants already mentioned along the newly opened highways, he may at reasonable rates, and

under easy terms of payment, select, from many millions of acres, such allotments as may suit his resources, purchasing not only from the government, but also from either of the great companies—the British American for the lower province, and the Canada for the upper. If he has carried with him capital, or has acquired it on the spot by his skill or labour, he will always be able to secure a ready-made homestead for less than it would cost him to erect it. If he has substance to spare beyond the immediate demands of his own location, he may invest it in duly registered mortgages at 8 per cent., or else buy blocks of about 50,000 acres each, at prices varying from 9d. sterling to 2s. an acre, and that on not very onerous conditions of survey and settlement. Places of worship abound in all but the youngest and wildest localities. The Church of England, besides 2 bishops in each province, numbers 315 clergymen. The Church of Rome, with 8 bishops in all, has about 540 priests. Among Presbyterians and Methodists respectively, of all known denominations, there are 325 and 743 ministers. Other sects, dividing among them 359 preachers of the gospel, make up a total of 2294 pastors; or, on an average, one pastor to little more than a thousand of the population. In the eye of the law, all denominations are equal, for the tithe payable in Lower C. by the flocks of the Church of Rome is not a real burden on the property, as such, but merely a personal liability on the part of the occupier, as a Catholic. In facilities for education, too, C. presents great advantages to the intending emigrant. In the upper province—there were, in 1858, 12 universities and colleges, and 4242 schools—121 grammar, 255 private, and 3866 common; while the pupils attained the aggregate of 306,626. In the lower province, again, during the same year, there were, besides 2 universities and colleges, 2985 schools—10 superior, 170 secondary, 3 normal, 2 special, and 2800 primary; while the pupils numbered 156,872. It thus appears that Lower C. mustered a far smaller attendance than Upper C., whether in proportion to seminaries or to population. While the populations must have been about 3 to 4, the attendance was a fraction more than 1 to 2; and the respective averages to each seminary were about 52 and 72.

Every year some new movement marks the progress of affairs in C., where, but for political contentions, and the occasional but angry brawls of the British and French races, we should have to report a state of unalloyed peace and prosperity. It is proper to say, however, that the Canadians as a body are warmly attached to Britain; their loyalty to the crown having been warmly demonstrated during the visit of the Prince of Wales in 1860.

CANADA BALSAM is a kind of turpentine (q. v.) obtained from the Balm of Gilead Fir (*Abies* or *Picea balsamea*), a native of Canada and the northern parts of the United States. See FIR. It exists in the tree in vesicles between the bark and the wood, and is obtained by making incisions, and attaching bottles for it to flow into. It is a transparent liquid, almost colourless, and with an agreeable odour and acrid taste. It pours readily out of a vessel or bottle, and shortly dries up, and becomes solid. When fresh, it is of the consistence of thin honey, but becomes viscid, and at last solid by age. It consists mainly of a resin dissolved in an essential oil, and its composition is as follows:

Essential Oil,	18·6
Resin, soluble in Alcohol,	40·0
Resin, sparingly soluble,	33·4
Elastic Resin,	4·0
Bitter Extractive and Salts,	4·0
	100·0

It is the finest kind of turpentine obtained from any of the *Coniferae*, and is much employed for medicinal purposes, particularly as a stimulant for the cure of mucous discharges, and as a detergent application to ulcers. It is also used for a variety of purposes in the arts—as an ingredient in varnishes, in mounting objects for the microscope, in photography (q. v.), and by opticians as a cement, particularly for connecting the parts of achromatic lenses to the exclusion of moisture and dust. Its value for optical purposes is very great, and depends not only on its perfect transparency, but on its possessing a refractive power nearly equal to that of glass.

CANADA GOOSE. See GOOSE.

CANAL, an artificial channel for water, formed for purposes of drainage, irrigation, or navigation, but now usually employed to designate only such cuts as are intended for the passage of vessels.*

Canals date from a period long anterior to the Christian era, and were employed as a means of irrigation and communication by Assyrians, Egyptians, and Hindus; also by the Chinese, whose works of this kind are said to be unrivalled in extent; one of them, the Imperial C., having a length of about 1000 miles. For the most part, however, these early canals were of one uniform level, and hence exhibit no great skill or ingenuity; and the moderns were content to follow the rudimentary efforts of the ancients in this way until the 15th c., when the invention of the Lock (q. v.)—shewing how canals might be generally and advantageously used for inland navigation, in countries whose surface was irregular—gave a great impulse to this branch of engineering. The Italians and Dutch, for both of which nations the invention of the lock has been claimed, were the first to develop this kind of engineering in Europe. In France, the first C., that of De Briare, to form a communication between the Loire and the Seine, was opened in 1642. In 1681 was completed the greatest undertaking of the kind on the continent, the C. of Languedoc, or the C. du Midi, to connect the Atlantic with the Mediterranean. The length of this C. is 148 miles, it has more than 100 locks, and about 50 aqueducts, and in its highest part it is no less than 600 feet above the sea. It is navigable for vessels of upwards of 100 tons. It was not until nearly a century later that C. navigation assumed importance in England, through the sagacity, energy, and liberality of the Duke of Bridgewater (q. v.), and his celebrated engineer, James Brindley (q. v.). The success of these works stimulated other public persons to engage in similar undertakings. Speculation in C. shares became a mania similar to that which overtook the people in connection with railways at a more recent period, and a crash ensued on the prospect of war in 1792. It would be an endless task to pursue the history of canal development in Britain, which speedily became intersected with these watery highways to an extent unequalled in any European country save Holland. In the space

* In the fen-districts of the east coast of England, however, the large channels required for drainage are made subservient to purposes of inland navigation by sluices at the mouth—one to keep out the tide at high water, and another acting in the opposite direction, to retain water of depth sufficient in the channel to float such boats as make use of it. These combinations of drain and canal are commonly called *navigations*; hence the workmen employed in their construction were called *navigators*, which, contracted into *navvy*, is now applied indiscriminately to persons engaged in any kind of earth-works.

remaining at our disposal, we shall briefly consider the several kinds of canal.

Canals may be divided into three general heads—viz., 1. Canals proper, i. e., entirely artificial channels, having no water running through them beyond what is necessary for their own purpose; 2. Tidal, i. e., affected by the rise and fall of the tides; and 3. Rivers rendered navigable by weirs built across them to increase their depth, and having a lock at one end for the ascent or descent of vessels; and occasionally, when there is much fall, or any formidable obstruction in the river, by lateral cuts, with locks for part of their course.

Another division may be made (1) of ship-canals for the transit of sea-going vessels generally, from sea to sea; these are necessarily of large dimensions, and must be crossed by swing or draw bridges; and (2) of canals for the passage of mere boats or barges, generally without masts, so that they may be crossed by stone or other solid bridges. The largest ship C. in Europe is the Great North Holland C., completed in 1825, which has a breadth of 125 feet at the water-surface, and of 31 feet at the bottom, with a depth of 20 feet. It extends from Amsterdam to the Helder, a distance of 51 miles; it thus enables ships of as much as 1400 tons burden to avoid the shoals of the Zuyder Zee. The surface of the water in this C. is below the high-water level of the German Ocean, from which it is protected by embankments faced with wicker-work. The locks on this C. are 297 feet long, 51 feet broad, and 20 feet deep. There is a similar C. from near Rotterdam to Helvoetsluis, to avoid the shallows of the Brill at the mouth of the Maas. Another great ship C. is the Caledonian C. (q. v.). The Forth and Clyde C. is also one on a smaller scale for the passage of sea-going vessels. Its length is 35 miles; its medium width is 56 feet at the surface, and 27 feet at the bottom, and its depth 9 feet. It has 39 locks, each 75 feet long, and 20 feet wide, and a rise of 155 feet. In constructing ship-canals, it is important to secure a sheltered entrance, one not likely to become silted up, and of sufficient depth to admit vessels at all times of the tide; and towing-paths on both sides are desirable.

Among the principal canals in England for the passage of barges, some of which run to very great elevation, are the—

	Length.	Rise.
	Miles.	Feet.
Grand Junction,	128	
Leeds and Liverpool,	128	433
Trent and Mersey,	93	326
Kennet and Avon,	57	402

The C. of the Loire is one of those aiding the navigation of a river, it has a width on the water-line of 33 feet, and a depth of 5½ feet, the locks being 17 feet broad, and 100 feet long. The river Lea and the Mersey and Irwell Navigations in England, and the Welland C. in Canada, formed to connect Lake Erie with Lake Ontario, and avoid the Falls of Niagara, are also among the most noteworthy works of this class; the river Thames, above the first lock at Twickenham, partakes also of the nature of a canal.

Many canals pass through long tunnels, some very low and without towing-paths, in which case the mode of propulsion is by the boatmen lying on their backs and pushing with their feet against the roof of the tunnel.

The great expenditure of water and time in 'locking' have led to the trial of various other plans for overcoming differences in level. On the Great Western C., boats are raised and lowered by means of machinery, called a perpendicular lift.

On the Morris C. (United States), boats are conveyed on a carriage up a railway inclined plane, from one reach to another; on the Chard C., Somersetshire, and on the Monkland C. near Glasgow, they are taken afloat in a caisson, or water-tight vessel, up or down an inclined plane—in the latter case, empty boats of 60 tons burden are raised or lowered 96 feet.

Other matters engineers have to consider are an ample supply of water, by means of feeders and reservoirs, to the summit-level; stop-gates at convenient distances, to shut off the water in case of damage to any part of the C.; means of drainage when repairs are necessary; and provision against leakage through the banks, by puddling or otherwise. The floor-line or bottom of a C. is usually made twice the width of the largest boat likely to enter the C., with an addition of 6 or 8 inches for play at each side, and the depth 12 or 18 inches more than the draught of the boat.

The introduction of railways has materially interfered with C. traffic, and some canals have been altogether abandoned. Many, however, still continue to prosper, as, for instance, the Grand Junction, which in 1840 conveyed 924,259 tons, and in 1856, 1,187,201 tons, shewing an increase of 262,942 tons; Lea Navigation, which increased from 214,927 tons in 1851 to 269,044 in 1856; and the Trent and Mersey, which rose from 1,284,222 in 1855 to 1,558,027 in 1857. There are in Great Britain 2172 miles of C. proper, which have been established at a cost of £28,400,000; and 1315 miles of improved river-navigation, formed at a cost of £6,270,000. In France, in the same year, there were 1974 miles of C., the cost of which had been about £12,250,000; and in the United States, 2000 miles, costing £9,200,000.

Laws regarding Canals.—The traffic, and generally the rights, duties, and liabilities of canal companies are regulated by two acts of parliament, the 8 and 9 Vict. c. 42, and the 17 and 18 Vict. c. 31, called 'The Railway and Canal Traffic Act, 1854.' The word *canal* is declared to include any navigation whereon tolls are levied by authority of parliament, and also the wharves and landing-places used by such canal or navigation; and *traffic* is defined as including not only passengers and their luggage, but also goods, animals, trucks, boats, and vehicles of every description. All tolls and charges in respect of the traffic are to be charged equally to all persons. It is declared to be the duty of canal companies to make arrangements for the receiving and forwarding of traffic without unreasonable delay, and without partiality; and facilities are given for a remedy to parties complaining of want of attention in these respects.

According to section 7 of the 17 and 18 Vict. c. 31, companies are liable for neglect or default in the carriage of animals or goods, although they may have given notice to the contrary. Where the effect of such neglect or default occasions the loss of or injury to animals, the act provides that no greater damages shall be recovered than as follows: for any horse, £50; for any neat cattle, per head, £15; for any sheep or pigs, per head, £2, unless at the time of delivery for transit, the animals were declared to have been of higher value. No special contract between the company and parties employing the canal shall be binding on the latter unless signed by them. The act saves the rights, privileges, and liabilities of companies under the Carriers' Act, the 11 Geo. IV. and 1 Will. IV. c. 68.

Injury to canals, with intent to obstruct the navigation, is punishable with penal servitude for not more than seven, or less than three years; or imprisonment for two years, with the addition of

ard labour, solitary confinement, and whipping, at the discretion of the court. See CARRIERS.

CANALETTO, or **CANALÉ**, the name of two Venetian painters, who have acquired a reputation for their landscapes and views of towns. The elder, **ANTONIO C.**, born 1697, was the son and pupil of a theatrical decorator in Venice. He studied at home. He painted a numerous series of excellent views in Venice, among which that of the great canal are especially admirable for their fresh colouring, faithfulness, and the invention displayed in accessory objects. He came to England by the advice of Amiconai. He died in 1768, after having acquired both wealth and fame by his representations of English scenes, several of which are in Buckingham House, and are highly admired.

BERNARDO BELLOTTO, surnamed **CANALETTO**, nephew and pupil of Antonio, was born at Venice, 1724, and attained high excellence as a painter, and also as an engraver on copper. He practised his art in his native place, and afterwards in Rome, Verona, Brescia, Milan, and Dresden. Correct perspective, powerful effects of light and shade, and beautiful sky-tints, are the most prominent characteristics of his works. C. visited England, where, among several other excellent works, he painted a masterly interior view of King's College Chapel, Cambridge. He died at Warsaw, 1780.

CANAMINA, a town of Dahomey, Africa, about 2 miles south of the capital, Abomey. It is situated in the midst of a cultivated plain, and has a house for the accommodation of white men, set apart by the king. Pop. 10,000.

CANANORE, a seaport and military station of the district of Malabar, in the presidency of Madras. It is in lat. $11^{\circ} 52' N.$, and long. $75^{\circ} 26' E.$, being about 50 miles to the north of Calicut. The town stands at the head of a bay, which, opening from the south, forms its harbour, while the fort and Antonments occupy the bluff headland, which betters the inlet on the side of the Arabian Sea. Besides pepper, grain, and timber, the neighbourhood produces immense quantities of cocoa-nuts, which are largely exported to the northward, where they are said to be scarce. C. has been a British possession since 1791, having in that year been taken from Tippoo Sultan by General Abercromby.

CANARA, the most northerly part of the presidency of Madras, on the west coast of the peninsula of Hindustan, separating the district of Malabar from Portuguese Goa. It stretches in N. lat. from $2^{\circ} 11'$ to $15^{\circ} 30'$, and in E. long. from $74^{\circ} 9'$ to $5^{\circ} 44'$, containing 7720 square miles, and numbering, in 1852, 1,056,333 inhabitants. The territory is divided into north and south, the most noteworthy towns being Mangalore in the latter half, and Coomta, a place for the shipping of cotton, in the former. In consequence of the death of Tippoo Sultan, C. came into the possession of the East India Company in 1799.

CANARAC, a town on the Orissa coast, at the north-west angle of the Bay of Bengal, in lat. $9^{\circ} 54' N.$, and long. $86^{\circ} 10' E.$, being 235 miles to the south-west of Calcutta. It is remarkable chiefly for the remains in its vicinity of a colossal pagoda. The entire area, a square of about 13 acres, is said to have been surrounded by walls 150 cubits high and 19 broad; and the principal materials appear to have been red granite and black basalt, some of the blocks measuring 15 or 16 feet in length, by 6 or 8 in width, and 2 or 3 in thickness. Most of the sculptured embellishments have been removed, and the temple of Juggernaut, which is in the same district of Pooree as C. itself.

CANARIES, or **CANARY ISLANDS**, a group

of islands belonging to Spain in the Atlantic Ocean, off the north-west coast of Africa, in lat. $27^{\circ} 40' - 29^{\circ} 25' N.$, and long. $13^{\circ} 25' - 18^{\circ} 16' W.$ The group consists of seven large and several small islets, having altogether an area of about 3800 square miles, and a population of about 230,000. The principal islands proceeding from east to west, are Lanzarote, Fuerteventura, Gran Canaria, Tenerife, Gomera, Palma, and Hierro or Ferro. The coasts are steep and rocky, and the surface is diversified with lofty mountains (the greatest elevation being attained in the *Pico de Teyde*, in the island of Tenerife, which has a height of 12,132 feet), narrow gorges, and fertile valleys. All the islands are of volcanic origin. On the summits of the highest elevations, depressions, like those left by fallen cones of volcanoes, are almost everywhere found; and the steep declivities are marked by deep fissures, of which, usually, only one penetrates the depressed summit, and exposes to view the several strata of the volcanic rock. There are numerous torrents, but no rivers, and fresh water is very scarce in the southern parts of the islands, and especially in Hierro.

The researches of Humboldt and Von Buch led to the division of the botanical geography of Tenerife into five distinct regions. The first, or region of African forms of vegetation, extends to about 1300 feet above the sea, and is marked by the growth of the date palm, sugar-cane, dragon's-blood tree, &c. The second region extends to the height of 2800 feet, and produces vines, corn, maize, olives, chestnuts, &c., in luxuriance. This zone represents the vegetation of Southern Europe. In the third region, rising 1200 feet or so higher, we have laurels and evergreens. In the fourth, extending to above 6000 feet, we find vegetation nipped by cold and excessive dryness, snow falling several months of the year, and only the *Pinus Canariensis* and other coniferæ flourishing. The fifth region attains an elevation of nearly 11,000 feet. Here are found a kind of *Spartium* (Broom) peculiar to this zone, with cedrine junipers, and one Alpine plant, *Arabis alpina*. The barren mountain-peaks are just below the limit of perpetual snow, although in a cavern at the height of 11,000 feet above the sea, snow is said to be preserved throughout the year. All the rest of the islands are similar in character, with the exception of Fuerteventura and Lanzarote, which are less elevated, more abundantly wooded, and more luxuriant in vegetation generally.

Minerals are few, and of little importance. Near the sea, the general temperature ranges from $60^{\circ} - 66^{\circ} F.$, in the coldest month, January, to $78^{\circ} - 87^{\circ} F.$, in the warmest month, October. The rainy season lasts from November to February; from April to October, the weather is uniformly fine. The islands, however, suffer much from the east and south-east winds, which, blowing over the hot deserts of Africa, burn up vegetation, and generate disease. The annual produce of the islands is estimated at 170,000 quarters of grain, 54,000 pipes of wine, 300,000 quintals of barilla, and 500,000 barrels of potatoes, besides oil and fruits of all kinds. The chief foreign trade is with the United States, England, and Hamburg; and an active trade between the islands themselves is carried on. Manufacturing industry is little developed. A captain-general rules over the whole, with a governor for each of the islands under him.

TENERIFE, the largest island of the group, has an area of 877 miles, with a population of 85,000. In the north-west of this island, which is the principal seat of the vine-culture, is situated the famous *Pico de Teyde*, or Peak of Tenerife (q. v.). The chief

town and port is Santa-Cruz de Santiago (q. v.), on the north-east coast.

GRAN CANARIA, which is next in importance, has an area of 758 square miles, with a population of 68,000. Its culminating peak is El Cumbre, with a height of 6648 feet. The capital, Las Palmas (q. v.), on the east coast, is the largest town of the archipelago.

PALMA has an area of 718 square miles, and a population of 33,000. Its highest peak, Pico de los Muchachos, has an elevation of more than 7600 feet. Capital, Santa-Cruz des las Palmas (q. v.), on the east coast.

The area and population of the other islands are as follows: LANZAROTE is 323 square miles, pop. 17,400; FUERTEVENTURA, 326 square miles, pop. 13,800; GOMERA, 169 square miles, pop. 11,700; HIERRO, 82 square miles, pop. 4400. The chief towns of these islands are small.

The C. are supposed to have been the Fortunate Islands of the ancients. The Carthaginians are said to have visited them, and Juba II., king of the two Mauritaniae, wrote an account of them that has been transmitted to us by Pliny. In modern times, the first account of them was furnished in the first half of the 14th c., by the crew of a vessel that had been driven among them by stress of weather. A Spanish gentleman obtained a grant of them from the pope; but when an attempt at settlement was made, the Spaniards were driven off by the natives. In the beginning of the 15th c., the Spaniards succeeded in obtaining a footing in the islands; but a difference having arisen with Portugal concerning them, it was not until 1493 that the authority of Spain was finally established. Since that time, they have remained attached to the Spanish crown. The Guanches, who were the aborigines of the islands, have long ceased to exist as a separate people, the population being now quite Spanish. They were a brave and intelligent race.

CANARIUM, a genus of trees of the natural order *Amyridaceae*, natives of the south-eastern parts of Asia, the Malayan Archipelago, &c. The fruit is a drupe. The kernel of the fruit of *C. commune* is eaten both raw and roasted; and in Amboyna, bread is made of it, which is generally in the form of rolls about a yard long and an inch thick. An oil is expressed from it, which is used both for the table and for lamps. The tree is about 50 feet high. *C. sylvestre* also produces eatable kernels. *C. commune* is supposed to be one of the trees which yield ELEMI (q. v.), and *C. microcarpum* yields an oil very like copaiva, known in ship-building yards as DAMAR (q. v.).

CANARY, or CANARY BIRD, a beautiful little bird, very common as a cage-bird, and much esteemed for its musical powers. It is one of the numerous family of finches (*Fringillidae*), and is *Fringilla Canaria* of Linnæus. Some modern ornithologists place it in the genus *Carduelis*, others in *Linota*; it is indeed intermediate between these genera, the goldfinches and the linnets. Some make it the type of a genus or sub-genus, *Canaria*. It is found in Madeira, the Canary Isles, and the Cape Verd Isles; frequents the neighbourhood of human habitations; builds its nest of moss, feathers, hair, &c., in thick, bushy, high shrubs or trees; and produces four, five, or even six broods in a season. In its wild state, its plumage is greenish, or greenish-yellow, sometimes tinged with brown, and exhibits less variety and beauty than in domestication. It was brought to Europe in the beginning of the 16th century. It breeds readily in confinement, and seems thoroughly

reconciled to its cage-life; but although canaries of long domesticated races sometimes excel in imitative powers and acquired strains, yet they are

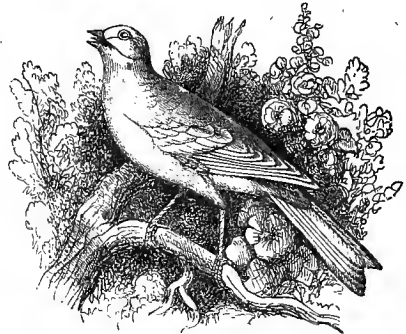

Canary.

surpassed in loudness and clearness of note by some of the wild birds, which, when caught and imported, are occasionally sold for extraordinary prices. Even in confinement, the C. often breeds four or five times a year, laying from four to six eggs each time. The eggs are pale blue. The male assists the female in building the nest and in feeding the young. Besides seeds of various kinds, which are their principal food, canaries are very fond of bland green leaves, such as those of chickweed, a supply of which is very necessary for their health; and one of their favourite luxuries is sugar. The C. not unfrequently lives 15 or 16 years. It can be taught various notes and airs, and some even learn to articulate words. The rearing and training of canaries afford occupation to no small number of persons, particularly in the Tyrol. The C. hybridises readily with some other species of finch, producing 'mules,' some kinds of which are valued as song-birds.—There are several species very closely allied to the C., one of which, a beautiful little bird, entirely yellow, with an orange crown, a native of Brazil, is sometimes sold in Britain as a song-bird, but its musical powers are very inferior to those of the common species.

CANARY GRASS (*Phalaris Canariensis*), a grass of which the seed is much used, under the name of *canary-seed*, as food for cage-birds, and which is, on that account, cultivated to some extent in the south of Europe, and in certain districts of Germany and England. It is a native of the Canary Islands, naturalised in the south of Europe, and in many places in Britain. The chief seats of its cultivation in England are the counties of Kent and Essex. The seed is sown early, generally in February, yet the crop is not reaped till after the ordinary grain harvest, for which reason the cultivation of C. G. is seldom attempted in the northern parts of Britain.—This grass attains a height of two or three feet, and has a crowded, egg-shaped, spike-like panicle, from an inch to almost two inches long; the spikelets are one-flowered, very much laterally compressed, a rudimentary scale-like floret on each side of the perfect floret; the *glumes* winged on the keel, and with two strips of darker green on each side; the *paleæ* awnless, shining, and at last firmly enclosing the seed. A fine flour is prepared from canary-seed, which is employed as dressing in fine cotton-weaving, and for the finishing of silken stuffs. The groats and flour of this small kind of grain are also used in the Canary Islands, in Barbary, and in Italy, as food, the

CANARY PLANT—CANCER.

flour being made into bread, which is very nutritious and pleasant.—Other closely allied species of *Phalaris* produce a similar grain, but are inferior

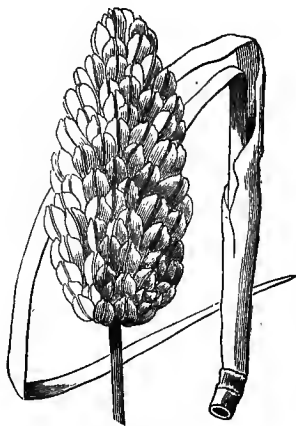

Canary Grass.

in productiveness and quality.—A grass, now generally referred to this genus, and sometimes called REED C. G. (*Phalaris arundinacea*), is very common on the banks of lakes and rivers, and in other wet places in Britain, and throughout Southern and Central Europe. It differs very much in appearance from C. G., having a large spreading panicle, generally of a reddish colour; and the glumes are not winged at the keel. It is a somewhat reed-like grass, 4—6 feet high, with creeping roots, which help to, secure river-banks; and yields a great bulk of hay, but has been very generally despised as a coarse grass, fit only for littering cattle. The justice of this opinion has, however, been called in question, and the grass proclaimed to be very nutritious, and sufficiently acceptable both to horses and oxen when cut early. It may be mown twice a year. A variety with curiously striped leaves is well known in gardens, as *Ribbon Grass*, *Gardeners' Garters*, or *Ladies' Traces*.

CANARY PLANT. See TROPÆOLUM.

CANARY WINE, also known as TENERIFE, is the produce of the Canary Islands, and resembles Madeira; but the name is properly applied only to the Bidogne wine, which must be distinguished from the Malvoisie of the Canaries. The former is made from grapes gathered before they have ripened, and, when new, is crude and unpleasant; but in the course of two or three years, increasing in mildness as in age, becomes so much like Madeira, that it is often sold for it. Like Madeira, it is greatly improved by a voyage to the tropics. It is produced chiefly on the island of Tenerife, and the trade in the wine is mostly carried on at the chief port of this island. The Canary of the island of Palma is inferior to Tenerife, but may be consumed sooner, and has a pleasant flavour.

CANA'STER, the name given to a rush-basket in which tobacco is placed in Spanish America; hence is said to be derived the name canaster, now applied to tobacco of a certain kind.

CANCELLA'RIA, a genus of mollusks—class *Gasteropoda* (q. v.), order *Pectinibranchiata*—with univalve shells, sometimes regarded as belonging to the family *Volutida*, or *Volute Shells* (q. v.), but now generally placed among *Buccinida*, or *Whelks* (q. v.). The spire is prominent, the last whorl

ventricose, the surface reticulated, the mouth large, the columella plaited. All the recent species are natives of tropical or subtropical seas, and are found chiefly on sandy bottoms, at the depth of a few fathoms. The fossil species, amounting to nineteen, occur in the newer strata from the chalk upwards.

CANCELLING OF DEEDS AND WILLS.

The word cancel comes from the Lat. *cancelli* (lattice-work), and a deed was formerly said to be cancelled when lines were drawn over it in the form of lattice-work. The word cancel is now used to signify any sort of obliteration.

The Court of Chancery in England gives relief against the effect of improper cancellation; on the other hand, it may order a deed which has been improperly obtained to be delivered up in order to be cancelled. The effect of the cancellation is to make the deed void. If a deed is given up to be cancelled, and the cancellation does not take place, it remains in force at law. But if an obligee deliver up an obligation to be cancelled, and the obligor do not afterwards cancel it, and the obligee happen to get it again into his hands, and sue the obligor on it, the latter cannot plead its voidance, for the deed still remains in force at law—although here, too, equity would relieve, and decree according to the original cancellation. Where a deed is cancelled by consent of the parties to it, it is thereby destroyed as to their interest under it, but third parties may still produce it in evidence. As to a will, its cancellation may have the effect of revoking it, if done with such intention.

In Scotland, the system of registration of deeds and other writings prevents the occurrence of many of the questions that arise in England on this head, but the intention and effect of the cancellation or destruction of documents would in most cases be a question of evidence; and where it is necessary to know the contents of the destroyed paper, its effect may be judicially declared by a form of suit called an action for *proving the tenor*, as indeed may be done in an English court of equity by a bill to recover the contents of a lost document. In the Scotch law, again, a deed or other writing may be judicially cancelled or set aside by an action of reduction, and the courts in England substantially exercise a similar jurisdiction.

It would appear that where a testator has prescribed certain forms for the authentication of his will, and such forms have either not been observed by him, or if observed, have, in some essential particular, been negated by obliteration, an intention to revoke will be presumed: thus, where a Scotchman, who had long resided in India, executed a will, concluding, 'In testimony of this being my last will and testament, I hereto set my hand and seal;' and the document was found in his repositories with the part to which the seal had evidently been affixed cut (not torn) off, the House of Lords held the deed to be cancelled, because the testator had himself, besides the usual solemnities, prescribed a seal as necessary to the authentication of his will. A will, however mutilated or cancelled by a testator during his insanity, would be good; and of course there is no effectual cancellation when done by a third party without sufficient authority. But all such considerations are questions of evidence. See DEED, WILL.

CANCELLING OF LETTERS-PATENT. The Lord Chancellor may cancel the Queen's Letters-patent, when granted contrary to the law, 'which,' says Blackstone, quoting Sir Edward Coke, 'is the highest point of his jurisdiction.' See LETTERS-PATENT, CHANCELLOR.

CANCER, a disease characterised by slow

CANCER.

alterations of structure, or tumours in various parts of the body, occurring either simultaneously or in a certain order of succession. In many cases, an isolated tumour in an external part is the earliest symptom; it is then viewed as the starting-point of the disease, and is termed a *malignant tumour* (*tumor mali moris*), from its presumed tendency to infect the system, and to cause the reproduction of growths similar to itself. It is right, however, to remark, that upon the pathology of C. authorities are by no means agreed, some holding that a constitutional taint or *diathesis* must always precede any local development of C., and that the first growth in point of time (or primary C.) is therefore only the first of a series determined by a pre-existing cause in the blood or general system; while others hold that C. is originally a truly local disease, or even that a growth at first simple (*non-malignant* or *benign*), may, in consequence of local causes, *degenerate*—i. e., become cancerous, and infect the whole system with the morbid tendency thus secondarily acquired. The discussion of this disputed question involves statements of a too complicated kind to be in place here; but it is a question of considerable importance, as bearing on the probability or improbability of curing the disease by extirpating the primary tumour at an early stage of its development. All authorities are agreed that, when any trace of secondary C. exists, the removal of the parts affected gives scarcely any hope of a favourable result, and, accordingly, operations under these circumstances, unless merely for the relief of local suffering, are discountenanced by all respectable surgeons. The disease, however, is one of which the ignorant as well as the learned have a well-founded dread, and hence it presents a large field for the practice of imposture, and for that less deliberate, but often not less hurtful kind of quackery which is the result of pure ignorance, grafted on a meddlesome desire to do good. We propose to give such a sketch of the characters and progress of cancerous disease as may serve, in some degree, as a protection against ignorance on the one hand, and deception on the other.

The leading character of C. being a tumour or morbid growth in a part, it is important, in the first place, to observe that not all, nor even the majority, of morbid growths are cancerous. A very large proportion of growths, involving swelling or change of structure in a part, are either determined by a previous process of inflammation—leading to chronic abscess and induration—or belong to what is called the non-malignant order of tumours—e. g., cysts, fatty and fibrous tumours, simple hypertrophy of glandular structures, cartilaginous, bony, calcareous, and vascular growths. See TUMOUR. Further, among the tumours admitted by general consent into the order of cancerous, there are widely different degrees of *malignancy* or *cancerousness*, so to speak; some having the tendency to spread rapidly, and infect the system at an early period, while others remain local for a considerable time, and may be removed while yet local, with good hope of a permanent recovery.

Now, the practical distinction, or *diagnosis*, to use the technical phrase, of these different tumours, is founded upon a very careful and delicate appreciation of the characters of the malignant and non-malignant tumours, considered as morbid products, and also upon a thorough knowledge of the anatomy and relations of the textures in which they arise. One of the leading characters of malignant tumours is the tendency to involve, by a kind of specific destruction or degeneration, the ultimate elements of the textures in which they arise, and in which they

spread. The attempt, therefore, to distinguish these from other growths, must always call for the highest qualities of the surgeon—large experience, guided at every step by consummate science, and, in particular, by minute and thorough knowledge of natural structure. And the difficulties of the inquiry are such, that even in the dead body, or in a tumour excised from the living body, all the resources of the anatomist, aided by the microscope, will occasionally fail in distinctly and surely discovering the true character of the morbid structure.

The most common seats of C. are, among external parts, the female breast, the eye, the tongue, the lip, the male genital organs, and the bones; among internal organs, the liver, stomach, uterus, rectum, gullet, peritoneum, and lymphatic glands. Some of these parts are more liable to primary, others to secondary cancer. Thus, the female breast, the neck of the uterus, the lower lip, the scrotum, the extremity of the penis, are very often the seats of a single cancerous tumour, which in its early stage at least seems to be unconnected with any constitutional taint; while the liver, the bones, and the lymphatic glands are more frequently the seats of secondary or multiple cancerous tumours. There are also differences in the character of the C. itself, apart from its anatomical seat, which are to be taken into account in estimating the probability of its being solitary. Some of these differences are regarded by pathologists as amounting almost to specific distinctions; thus, *scirrhus*, or hard C., observed most frequently in the breast, uterus, and stomach, is more frequently solitary than *encephaloid* (brain-like), otherwise called *medullary*, or soft C.; again, *melanosis*, or *melanic C.*, a variety charged with a brown or black pigment, is almost always multiple in its occurrence; while *epithelial C.*, or *epithelioma*, as it has been recently termed, of which examples are frequently found in the lip, scrotum, penis, or tongue, is so generally solitary as to have led some pathologists to place it in a class altogether apart from the truly cancerous growths, with which, however, it presents too many points of affinity in its fatal tendency to recur after operation, and to infect the lymphatic glands and other structures adjoining the part primarily affected. Again, there are certain varieties of fibrous and of cartilaginous tumour, as well as certain tumours of bone, and bone-like tumours developed in soft parts (osteoid), which must be regarded, in the meantime, as occupying a doubtful position between the malignant and non-malignant growths. (Paget, *Lectures on Surgical Pathology*, vol. ii.)

Generally speaking, a tumour may be said to fall under the suspicion of being C. when it more or less completely infiltrates the texture in which it arises, and passes from it into the surrounding textures; when it invades the lymphatic glands adjoining the part first affected; when it is attended by stinging or darting pains, or by obstinate and slowly extending ulceration, not due to pressure; when it occurs in a person having impaired health, or past the middle period of life, and is not traceable to any known cause of inflammatory disease or local irritation, nor to any other known constitutional disease, such as syphilis or scrofula. The probabilities are of course increased if the tumour be in one of the habitual seats of C., or if it be attended by evidence of disease in some internal organ known to be frequently thus affected. But it is hardly necessary to point out that the very complex elements of *diagnosis* here referred to ought to be always submitted to the scrutiny and judgment of a well-educated medical adviser, whose skill and personal character place him above suspicion, before the disease has assumed such a form as to be beyond

the reach of remedial procedure. The patient who broods in secret over a suspicion of C., or who declines to apply for advice from a fear of encountering the truth, is in all probability only cherishing the seeds of future suffering; while if, as often happens, the suspicion is unfounded, a few minutes' careful examination would suffice to remove a source of misery which otherwise would poison the mind for years.

These remarks apply still more emphatically to the misguided persons who trust to the non-professional *cancer-curer*, or to the quasi-professional specialist. The charlatan, who pretends to hold in his hands a secret remedy for this most terrible disease, will invariably be found to pronounce almost every tumour C., and every C. curable. By this indiscriminating procedure, and by the fallacious promise of a cure without an operation, many persons who have never been affected with C. at all, have been persuaded to submit to the slow torture of successive cauterisations by powerful caustics, at the expense of needless mutilation and no small risk to life. In other cases, truly cancerous tumours have been removed slowly and imperfectly, at the cost of frightful and protracted sufferings, only to return at the end of a few weeks; and Mr Spencer Wells has lately shewn that in some notorious instances persons were reported as cured, when they had actually died of the disease at no long period after the supposed cure was stated to have taken place. (*Cancer and Cancer-curers*, London, 1860.)

What is really known as to the cure of C., may be stated in few words. Modern pathological researches render it probable that a complete suspension of the progress of C. sometimes, though rarely, takes place; and individual tumours are found not unfrequently to undergo partial healing, or even to become entirely metamorphosed into inert cicatrices, while others, associated with them, continue to advance. The degree of rapidity of the advance of C. is also, as we have already stated, exceedingly variable. But these observations modify only to a very slight degree the general doctrine, that C. is a disease tending to a fatal issue, and hardly, if at all, under the control of remedies, as to its ultimate result. The removal of a cancerous tumour, indeed, is still resorted to by surgeons; and there appears to be no reasonable doubt that when performed early, and in well-selected cases, it has been followed by long-continued exemption. But the occasional spontaneous arrest of such growths on the one hand, and the doubtful results of operation in a large proportion of cases on the other, have combined to render surgeons of late years more chary of the use of the knife. In aged persons, in particular, the question often resolves itself into a calculation of the chances of life, founded on a great number of conflicting data, and only to be solved by a careful attention to the state of the general health, as well as to the rate of progress of the local disease. Operations are now very rarely performed after the lymphatic glands are involved, or when there is evidence of a deteriorated constitution, or of internal disease; but sometimes great pain, or profuse and exhausting discharge from an external tumour, may justify its removal, as a palliative measure, even under these unfavourable circumstances. For the mode of removal of cancerous and other tumours, see TUMOUR.

Among the lower animals, this disease is more rare; nevertheless, cases are not unfrequent, presenting the same malignant characters as those observed in the human subject. Usually manifesting itself in the form of a specific tumour of some organ or tissue, there is a tendency to the invasion of other parts of the system, and the

development of a constitutional state called the cancerous cachexia. M. U. Leblanc of Paris, the best veterinary authority on this subject, has shewn that the dog and cat are most frequently affected with C.; and next in frequency come the pig, ox, horse, and mule. It has not been observed in birds, reptiles, or fishes. Females are more liable to C. than males. It is hereditary, but not transmissible from animals to man, or from one animal to another. It does not disappear under the influence of remedies, but, if possible, the tumours should be excised when first seen, and if the knife fail to extirpate the malady, cauterisation should be had recourse to. A relapse is almost certain; but Leblanc says there is greater chance for the patient, when a carnivorous animal, if it is kept on a strictly vegetable diet.

CANCER, the *Crab*, the fourth of the twelve constellations of the zodiac, usually represented on the globe as a crab, and denoted in works on astronomy by the sign ♋, which resembles the number 69 laid sideways. It contains, according to Flamsteed, 83 stars, of which the principal is *Acubens*, a star of the third magnitude. In the divisions of the ecliptic, the sign called C. occupies a place between 90° and 120° from the vernal equinox; but owing to precession, the sign and the constellation have not coincided for nearly 2000 years. See ECLIPIC, PRECESSION, ZODIAC. Annexed is a representation of the constellation, which is one of the least striking

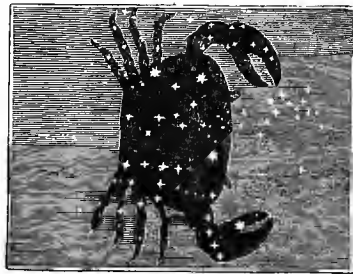

in the zodiac. Besides *Acubens*, it has two stars of the fourth magnitude, called by the Romans *Aselli* or the Little Asses; and a nebulous cluster of minute stars about 2° from the Asses, visible to the naked eye, and which goes by the name of *Præsepe* or the Manger.

CANCER. See CRAB.

CANCER, TROPIC OF. See TROPICS.

CANCER ROOT, or BEECH-DROPS (*Epiphegus Virginiana*), a parasitic plant of the natural order *Orobanchæe* (q. v.), a native of North America, growing almost exclusively on the exposed roots of beech-trees. Like all the other plants of its order, it has a curious appearance, having scales instead of leaves. Its stem is branching, and produces distant alternate white flowers, streaked with purple. The whole plant is powerfully astringent; and the root is brownish, spongy, and very bitter and nauseous in taste. It has acquired, in its native country, the reputation of being a cure for cancer. All parts of the plant are used, and externally more than internally. This plant, in conjunction with white oxide of arsenic, is believed to have formed a medicine once famous in North America under the name of *Martin's Cancer-powder*.—Another American plant of the same order, *Phelipæa biflora*, is sometimes also called C. R., and is used in the same way; and an infusion of the Common Broomrape (*Orobanche major*)—a native of Britain and of the south of Europe, parasitic on the roots of broom, furze, and

CANDAHAR—CANDELABRUM.

other leguminous plants—has been employed as a detergent application to foul sores.

CANDAHAR, or **KANDAHAR**, the capital of Central or Southern Afghanistan, situated about 200 miles to the south-west of Cabul. It is in lat. 32° 37' N., and long. 66° 20' E., and has an elevation of 3484 feet above the level of the sea. It is said to be an oblong square, while all its streets run straight, and cut one another at right angles—an alleged regularity which can hardly be reconciled with Elphinstone's avowed inability even to guess the extent of the city or the number of its inhabitants, which has been variously estimated at from 25,000 to 100,000. C. is well watered by two canals drawn from a neighbouring river, which send to almost every street, its own adequate supply; and the same means of irrigation have covered the immediate vicinity with gardens and orchards. C. is a place of great trade, attracting dealers from Bokhara, and even from Samarcand. Among its permanent residents, C. has a larger proportion of Afghans, chiefly of the Dooranee tribe, than any other city of Afghanistan. About 2 miles to the northward rises a precipitous rock, crowned by a fortress impregnable to everything but heavy artillery. Here, amid all the disasters of the Afghan war, the British maintained their ground. C. has been a pivot for the history of Central Asia during more than 2000 years. It is supposed to have been founded by Alexander of Macedon, owing, most probably, its name to the oriental corruption of Iskender or Scander, as in Scanderoon or Iskenderun of Syria. A comparative blank of upwards of 13 centuries in the history reaches to the famous Mahmoud of Ghiznee, who wrested the stronghold from the Afghans. From that epoch down to 1747, when the native rule was permanently established, C., with brief and precarious intervals of independence, was held by Tatory, India, and Persia in turn.

CANDEI'SH, a collectorate in the presidency of Bombay (lat. 20° 10'—21° 58' N., and long. 73° 37'—76° 20' E.), and containing 9311 square miles, with a comparatively scanty population of 778,112. It lies chiefly in the valley or basin of the middle part of the Taptee, which enters the Gulf of Cambay below Surat; and it is bounded mostly by territories of nearly all the powerful native princes—the Nizam, Scindia, Holkar, and the Guicowar. Through its situation, it necessarily suffered much from the long contest between the Mohammedans and the Mahrattas, and also from the struggles among the rival chiefs of the latter. Accordingly, when, in 1818, it fell to the East India Company on the overthrow of the Peishwa, it presented little better than a scene of desolation, with ruined mansions, dismantled towns, and dilapidated temples. The difficulties of the new government were considerably aggravated by the Bheels, a more than half-savage race, that formed about an eighth of the population; and even beasts of prey, particularly tigers, had, under the constant influences of human strife, multiplied to an unusual extent. But the improvement was regular and steady. Peace and security reigned; so that roads, formerly hazardous for armed parties, were traversed in safety by unarmed individuals. The staple productions are cotton, wheat, and other grains, and also a little indigo. The cultivators are generally in a progressive condition, more especially in the cotton districts, and the well-watered talooka of Baglan.

CANDELABRUM, a Latin word signifying properly a candlestick (from *candela*, a candle), but more frequently employed to mean a support for a lamp. There were, perhaps, no articles of furniture in which the ancients combined the beautiful with

the useful to so large an extent as in their candlesticks and lamps. Candelabra usually stood on the ground, and were of considerable height—from 4 to 8, or even 10 feet. The most common were of wood; but metals of all kinds, including the precious metals, were used for their construction, and sometimes they were even adorned with gems. The candelabra found at Herculaneum and Pompeii are mostly of bronze. In the temples and palaces of the emperors, they were frequently of marble, and of great size and richness. They have usually a capacious cup at the top, either for the purpose of containing oil enough to feed a large flame, or that they might be used for burning incense. Though varying greatly in details, a general design runs through the forms of the candelabra of antiquity. They have all a foot or feet, a shaft, and a plinth on which a lamp is placed, or which is furnished with a socket for a candle. The base often consists of three feet of a lion, goat, griffin, or other animal real

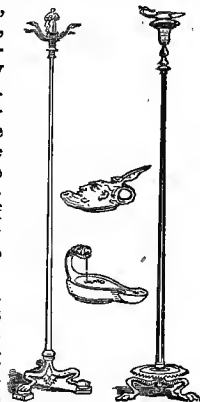

Ancient Roman
Candelabra.

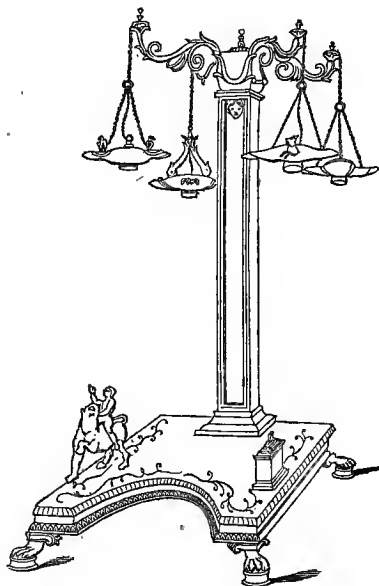

Candelabrum, with suspended Lamps.

or imaginary. Sometimes a figure was introduced either into the body of the shaft, or placed on the top of it, in either case supporting the superincumbent portion of the C. on its head. Sometimes a figure was substituted for the shaft altogether, the receptacle for the oil being placed in one hand. In others, the shaft is a sliding one, like that of a music-stand, the object being, of course, to raise or depress the light at pleasure.

In addition to the various kinds of candelabra which, from their height, seem to have stood on the floor, the ancients had others intended to be placed on a table. These consisted either of a pillar or of a

tree, and from the capital of the former, or the branches of the latter, lamps were suspended, as in the accompanying illustration, which we copy from Smith's *Dictionary of Greek and Roman Antiquities*. The C., in this instance, including the stand, is only three feet high. From the size of the stand in proportion to the rest of the C., it would seem to have been used for some other purpose.

CA'NDIA, in Turkish, 'KIR'D', called in the most ancient times *Idæa*, afterwards *Crete*, one of the largest islands of the Mediterranean, is situated at the entrance of the Archipelago, in long. 23° 40'—26° 40' E, lat. 34° 50'—35° 55' N. It is very irregular in form, its length being about 160 miles, and its breadth varying from 6 to 35 miles. The history of C. commences with Greek mythology, and historians and poets say that it was governed by its own kings, among whom were Saturn, Jupiter, and Minos, 1300 years before Christ. C. was conquered by the Romans under Metellus, who, on that account, had the title of 'Creticus;' on the division of the empire, it fell to the share of the eastern monarchs. In 823 A.D., it was conquered by the Saracens, who built the city of C. on the ruins of Heraclæa. In 1204, it was sold by Pope Boniface—to whom Baldwin I. gave it—to the Venetians. The Venetians divided the island into four provinces—Sitia, Candia, Retimo, and Canea. In 1645, the Turks besieged Canea, and in 1669 conquered the island, after a war which lasted 24 years, and a blockade of 13 years—30,985 Christians, and 118,754 Turks being killed or wounded in the siege. At present, the island belongs to the Sultan of Turkey.

The island of C. is for the most part mountainous, the mountains being chiefly composed of freestone or of marble, which is either gray or white. Towards the south side of the western part of the island, there is a chain of high mountains, extending in length about 37½ miles, which, from their appearing white, especially at their west end, were anciently called Leuci. Mount Ida, now called by the natives Upsiloritis, is one in a chain of mountains extending to the north-west of the island almost to Retimo; the mountain is of gray marble, and the surface loose stones: there is no verdure on it except a few small shrubs. Jupiter is said to have passed great part of his youth amongst these mountains in the exercise of hunting and drawing the bow.

The island abounds in springs and fountains, which are found even by the sea-side; most of the rivers are dry in summer, but in winter many of them are very dangerous torrents. The island does not produce any minerals of importance. The soil of C. is fertile, and produces wheat in abundance. The exports, which consist chiefly of oil, wool, linseed, and fruit, in 1857 amounted in value to £402,556, and the imports to £435,628.

C. had once, according to Homer in his *Odyssæy*, 90 cities; there are now only 3 principal towns: Megála Kástron or Candia, pop. 12,000, of which 8000 are Christians; Retimo or Rhithymnos, pop. 3200, of which 1500 are Christians; Canea or Khania, pop. 6000, of which 3800 are Christians. The total population of the island does not now number 200,000—less than half its amount at the outbreaking of the Greek revolution in 1821.

The language spoken by both Christians and Moslems in C. is modern Greek. The whole rural population may be said to have a common descent from the Cretans of the middle ages—the worldly advantages which used to result from embracing Islamism, induced whole districts to abandon the faith of their forefathers—but a mere change of religious faith was unaccompanied by any change of language.

CA'NDIDATE (Lat. *candidatus*). Among the Romans, a suitor for the office of consul, quæstor, prætor, &c., was named C. because, in appearing before the people, he wore a white (*candida*) toga without a tunic. His dress was chosen partly as an ostentation of humility, and partly as it served to display wounds received in battle. The candidature commonly lasted two years: in the first year, the C. was proved by the senate, whose decision, if favourable, was ratified by the popular assemblies; and, in the second, his name was entered in the list of candidates. During this period occurred the *ambitio*, or canvassing of voters, which often gave occasion to enormous bribery, in spite of the severe enactments passed to prevent the corruption of the electors. The elected C. was styled *Designatus*.

In the early Christian Church, newly baptized converts were styled CANDIDATES, on account of the white garments worn during eight days after baptism. In modern times, a German probationer or theological student who has been approved before the highest ecclesiastical authorities, is called a C.; but a still broader signification is also attached to the word, an applicant for any office whatever, religious or secular, being termed a candidate.

CA'NDLE, a cylinder of wax or fatty matter, with a wick, intended for giving light. Candles are made principally of tallow; also of the solid portion of palm and cocoa-nut oils, of bleached wax, and of spermaceti. They are either dipped, moulded, or rolled. 'Dips' are made by stretching a number of wicks upon a suitable frame, so that they may hang down at a distance from each other equal to about double the intended thickness of the C.; these are then dipped in a trough of melted tallow, and hung upon a rack until cooled, then dipped again and again, until the required thickness is obtained. The dipper has a number of frames prepared before commencing, and by the time he has dipped the last, the first is cool enough to dip again. The tallow in the trough has to be kept only a little above its melting point, for if it were much hotter, it would melt away a portion of the tallow already on the wick, instead of adding to it. Tallow-candles are much improved by being kept a year or a winter before using.

Moulds, or mould-candles, are cast by pouring the tallow down a pewter tube, along the axis of which the wick has been previously fixed. These tubes are well polished in the inside, and several are fitted in a frame, the upper part of which forms a trough, into which the moulds all open; and thus by pouring into the trough, all the moulds are filled at once.

Wax-candles are not moulded, on account of the great amount of contraction which wax undergoes in cooling, and the difficulty of drawing it from the moulds. The wicks are warmed, and suspended over a basin of melted wax, which is poured over them until they acquire the proper thickness; they are then rolled, while hot, between two flat pieces of smooth hard wood, kept wetted to prevent adhesion.

Great improvements have recently been made in the manufacture of candles, and these are especially interesting from being the direct results of the progress of scientific chemistry—of theory applied in practices. All oils or fats are composed of one or more fatty acids combined with a base, called glycerine. The fatty acids constitute the combustible and more solid portion of the compound. Both acid and base are very weak, and it is a general law in chemistry, that a strong base, under favourable conditions, will separate a weaker one from its acid, by combining with the acid, and taking the place of the weak base; and a strong acid will

CANDLEBERRY—CANDLEMAS.

in like manner displace a weaker one. Lime is a strong base, and being cheap, is used to separate the glycerine from the fatty acid of tallow, palm-oil, &c. This it does when the melted fat is stirred for some hours with a mixture of lime and water. The lime forms a hard insoluble soap, by combining with the fatty acid, and the glycerine remains in solution with the water. This lime-soap is then broken to powder; and the weak fatty acid separated by means of sulphuric acid, which combines with the lime, forming sulphate of lime. The whole being heated, the fatty acid floats on the top, is skimmed off, and the candles made from it. These are called composite candles; they give a purer light than ordinary tallow, from being freed from the glycerine, which not only softens the fat, but diminishes its combustibility. Pure stearic acid, or stearine, the chief fatty acid of tallow, is a hard crystalline substance, perfectly dry, and free from any greasiness, with a somewhat pearly lustre. Its crystalline structure presents a difficulty in the manufacture of candles, for when cast in moulds, it contracts on cooling, and leaves small spaces between the crystals. This has been obviated by mixing a little arsenic with it; but this method is now abandoned, on account of the poisonous gas evolved by the combustion of such candles, and the desired effect is obtained by mixing the stearine with a little wax, and pouring it into hot moulds.

To obviate the necessity of snuffing candles, several contrivances have been adopted; in all of them, the object is effected by causing the wick to bend over and its end to fall outside of the flame, and thus, by coming in contact with the oxygen of the air, to be completely burned—for such combustion cannot take place within the flame. See **FLAME**. This bending over is variously brought about. One method is by twisting the wick with one strand shorter than the rest, which is strained straight while the candles are being cast; and when released by the melting of a portion, it contracts, and bends the wick. Another method is by adding on one side of the wick a paste, consisting of a mixture of borax, bismuth, flour, and charcoal. Another, by coating one of the threads of the wick with a metallic envelope, by dipping it in fused bismuth; the metal fuses at the end of the burning wick, and forms a small globule, which bends the wick over, and is itself readily combustible at a red heat. These are called *metallic* wicks. Various other contrivances have been adopted for the same object.

Candles of this improved kind, in which the wick disappears in burning, and that bear a general resemblance to candles of wax, are now manufactured on an extensive scale, the progressive use of gas making apparently little impression on this branch of trade. Price's manufactory of 'patent' candles, as these improved candles usually are called, is perhaps the largest in England. It is situated at Vauxhall, in the neighbourhood of London, and its economic arrangements have attracted not a little public attention.

Candles were early introduced—with symbolical signification—into Christian worship, and are still so employed in the Roman Catholic Church. In the Church of England, candles are sometimes placed on the altar; but the practice is a subject of controversy. The numerous superstitious notions and observances connected with candles and other lights in all countries had a more remote origin, and may be considered as relics of the once uni- versally prevalent worship of the sun and of fire. Numerous omens are taken from them, and they are also used as charms. In Britain, a portion of the tallow rising up against the wick of the candle, is

called a winding-sheet, and regarded as a sure omen of death in the family. A bright spark at the candle denotes that the party directly opposite is to receive a letter. Windy weather is prophesied from the waving of the flame without visible cause, and wet weather if the wick does not light readily. Lights appearing to spring up from the ground, or issue out of a house, and traverse the road or air by invisible agency, the superstitious in Wales and elsewhere call *corpse-candles*. They are ominous of death, and their route indicates the road the corpse is to be carried for burial. The size and colour of the light tell whether the fated person is young or old. It is or was customary in some places to light a candle, previously blessed, during the time of a woman's travail. 'C. were supposed to be efficacious after death as well as before birth, for they were placed on the corpse. The object was doubtless to ward off evil spirits, who were supposed to be always on the alert to injure souls on entering and on quitting the world. See also **CANDLEMAS**.

CANDLEBERRY, CANDLEBERRY MYRTLE, WAX TREE, WAX MYRTLE, TALLOW TREE, or BAYBERRY (*Myrica cerifera*), a small tree or shrub of 4—18 feet high, but generally a low spreading shrub, a native of the United States of America, but most abundant and luxuriant in the south. It belongs to the natural order *Amentaceae*, sub-order *Myricaceae*, according to some, a distinct natural order, distinguished by naked flowers, with 1-celled ovary, a drupaceous fruit (stone-fruit)—the scales becoming fleshy—and a single erect seed. The genus *Myrica* has male and female flowers on separate plants; and the scales of the catkin in both male and female flowers are concave. The C. has evergreen oblongo-lanceolate leaves, with two small serratures on each side at the point, sprinkled with resinous dots. The bark and leaves when bruised emit a delightful fragrance. The drupes—popularly called berries—are about the size of peppercorns, and when ripe, are covered with a greenish-white wax, which is collected by boiling them and skimming it off, and is afterwards melted and refined. A bushel of berries will yield four or five pounds. It is used chiefly for candles, which burn slowly with little smoke, and emit an agreeable balsamic odour, but do not give a strong light. An excellent scented soap is made from it.—*M. Gale* is the **SWEET GALE** of the moors and bogs of Scotland, well known for its delightful fragrance, a native of the whole northern parts of the world. Several species are found at the Cape of Good Hope, one of which, *M. cordifolia*, bears the name of **WAX SHRUB**, and candles are made from its berries.

CANDLEMAS, in its ecclesiastical meaning, is the feast of the Purification of the Virgin Mary, and is observed on the 2d of February. This festival is very strictly kept by the Roman Catholic Church, there being a procession with many lighted candles, and those required for the service of the ensuing year being also on that occasion consecrated; hence the name **Candlemas Day**. In Scotland, this day is one of the four term-days appointed for periodical annual payments of money, interest, taxes, &c., and of entry to whitts—the three other term-days there being **Whitsunday, Lammas, and Martinmas**. See **TERM-DAYS**.

An old document of the time of Henry VIII., preserved in the archives of the Society of Antiquaries, London, concerning the rites and ceremonies in the English Church, speaks thus of the custom of carrying candles: 'On **Candlemas Daye** it shall be declared that the bearyinge of candels is done in the memorie of Christe, the spirituall lyghte whom Simeon dyd prophecye [*"a light to lighten the*

Gentiles"), as it is redde in the churchs that daye.' But an older and heathen origin is ascribed to the practice. The Romans were in the habit of burning candles on this day to the goddess Februa, the mother of Mars; and Pope Sergius, seeing it would be useless to prohibit a practice of so long standing, turned it to Christian account by enjoining a similar offering of candles to the Virgin. The candles were supposed to have the effect of frightening the devil and all evil spirits away from the persons who carried them, or from the houses in which they were placed. An order of council in 1584 prohibited the ceremony in England. There is a tradition in most parts of Europe to the effect that a fine C. portends a severe winter. In Scotland, the prognostication is expressed in the following distich:

'If Candlemas is fair and clear,
There'll be twa winters in the year.'

Christ's Presentation, the Holiday of St Simeon, and, in the north of England, the Wives' Feast-day, were names given to Candlemas Day. See Brand's *Popular Antiquities*, Bohn's edition.

CANDLE-NUT (*Aleurites triloba*), a tree of the natural order *Euphorbiaceae* (q. v.), a native of the South Sea Islands, Madagascar, Molucca, Java, &c., which produces a heart-shaped nut with a very hard shell, and a kernel good to eat when roasted, although in a raw state it possesses in a slight degree some of the active properties so common in the *Euphorbiaceae*, and is apt to cause purging and colic. It is about as large as a walnut. An excellent bland oil is procured from it, used both for food and as a lamp-oil. The inhabitants of the Society Islands after slightly baking these nuts in an oven, and removing the shell, bore holes through the kernels, and string them on rushes, hanging them up in their houses, to be used for torches, which are made by enclosing four or five strings in a leaf of the screw-pine (*Pandanus*). These torches are often used in fishing by night, and burn with much brilliancy. The lampblack used in tattooing was obtained from the shell of the candle-nut. A gummy substance exudes from the C. tree, which the Tahitians chew.

CANDLESTICK. The ordinary C. is so well known that no description is needed. The most important modern improvement in the C., is a contrivance for maintaining the candle at a uniform height, by means of a spring placed below the candle, and confined in the cylindrical body of the C.; this spring presses the candle upwards with sufficient force to drive it completely out, but for a collar at the top, against which the surface around the wick bears, and thus, as the candle melts, it yields to the pressure of the spring, and maintains a uniform height. The collar, when properly adjusted, also prevents the guttering to which composite candles are liable when exposed to currents of air or moved about.

CANDLISH, ROBERT SMITH, D.D., an eminent Scottish divine, was born in Glasgow in 1807, entered the university of his native city in 1822, and was licensed as a preacher in connection with the Established Church in 1831. In 1834 he became minister of St George's, Edinburgh. From this period, his public career may be said to have commenced. With intense zeal, he advocated the justice and necessity of ecclesiastical reforms, and became one of the boldest and most vigorous leaders of the popular or 'non-intrusion' party. After the Disruption (see FREE CHURCH), he co-operated with Dr Chalmers and other chiefs of the newly formed denomination in organising, consolidating,

and extending its aggressive efforts. Since the death of Dr Chalmers, he has been the most active and influential worker in the Free Church, and the man to whom, above all others, it is most deeply indebted. As a debater in church-courts, he is unequalled; as a preacher, he is noted for earnestness, strength, and acuteness of mind. His writings have not made the same impression on the community as his actions, but they are nevertheless highly respectable in point of ability. The principal are—*Contributions to the Exposition of the Book of Genesis, An Examination of Mr Maurice's Theological Essays, and Life in a Risen Saviour*.

CANDY. See CEYLON.

CANDYS (Gr.), a loose gown, worn by the Medes and Persians over their other garments. It was made of woollen cloth, which was either purple or of some other brilliant colour, and had wide sleeves. In the sculptures at Persepolis, nearly all the personages are represented as so attired. A gown of a very similar kind is still worn by Arabians, Turks, and other orientals.

CANDY-SUGAR is the popular name applied to ordinary sugar when procured in large crystals by the gradual and slow cooling of a concentrated solution of sugar. See SUGAR.

CANDYTUFT (*Iberis*), a genus of plants of the natural order *Cruciferae*, distinguished by unequal petals, the largest being towards the circumference of the dense corymbs in which the flowers grow, and by an emarginate pouch with the valves keeled and winged, the cells one-seeded, and the cotyledons accumbent. See COTYLEDON. The species are chiefly found in the countries surrounding the Mediterranean Sea, and the name C. is supposed to be derived from that of the island of Candia, the name *Iberis* from Iberia (Spain). One species, *I. amara*, remarkable for its bitterness, is a doubtful native of England. Some species are slightly shrubby, some are herbaceous perennials, some annuals. Some are among the most familiar ornaments of our flower-gardens, as the annual White and Purple C. (*I. umbellata*), the Sweet-scented C. (*I. odorata*), and two slightly shrubby species, *I. sempervirens* and *I. semperflorens*, the latter of which, in favourable situations, continues to blossom throughout the whole winter, and pleases the eye at all seasons, both by the abundance and the perfect whiteness of its flowers.

CANE, or KEN, a river rising in Bundelcund, near lat. 23° 54' N., and long. 80° 13' E., and, after a north-north-east course of 230 miles, entering the Jumna in lat. 25° 47' N., and long. 80° 35' E. It is too rapid and rugged for navigation; and is remarkable for the matchless beauty of its pebbles.

CANE, a term sometimes indiscriminately applied to any small and smooth rod, of the thickness of a walking-stick or less; but more correctly limited to the stems of the smaller palms and the larger grasses. We thus speak of Sugar C., Bamboo C., &c., among the latter; whilst among the former, this name is particularly appropriated to the species of the genus *Calamus*, also called Rattan. To this genus belong the canes largely imported from the tropical regions of the east for making bottoms of chairs, couches, &c. See RATTAN.

CANE SUGAR. See SUGAR.

CANE'A, or CANNA, called *Khania* (*Tà Chanidà*) by the Greeks, is the capital of the island of Candia or Crete, and situated on the northern coast, in lat. 35° 28' N., and long. 24° 2' E. It occupies the site of the ancient Cydonia. The present city is of Venetian origin, and dates from 1252 A.D. when a colony was sent from Venice to occupy it. The object of its

foundation was to keep down the Greeks, who had been in arms, and at open war with their Italian lords, almost without intermission from the day when the Venetians first set foot on their shores. Venetian coats of arms are still observed over the doorways of some of the principal houses. C. is surrounded by a strong wall and deep ditch, both of which, however, are in a state of great dilapidation; it has a good but very shallow harbour. C. is the principal mart for Candian commerce, and exports to France and Italy, oil, soap, wax, &c. Consuls from all nations are stationed here, and it is the residence of the Turkish governor of Candia, and of the Greek bishop. Pop. about 6000, of whom a seventh are Christians and Jews. The language spoken is modern Greek. The environs of C. are very beautiful.

CANE-BRAKE (*Arundinaria macrosperma*), a large kind of reed or grass, indigenous to the warmer parts of the United States of North America. It grows in marshy situations. It is of a genus allied to the bamboo. The flowers are in panicles.

CANELLA (*Canella alba*), a small tree common in the West Indies, where it is often called **WILD CINNAMON**. Its place in the botanical system has not yet been exactly ascertained, but it seems to be allied to *Pitosporeaceæ*. The fruit is a small black berry. The whole tree is very aromatic, and its flowers are extremely fragrant. The bark of the young branches is the *C. Bark* of apothecaries, also known in commerce as *White-wood Bark*, and sometimes called *White Cinnamon*. It forms a considerable article of export from the Bahamas. It has an aromatic fragrance, regarded as intermediate between that of cinnamon and that of cloves, and a bitterish, acrid, pungent taste. It is employed as a stomachic and stimulant tonic, and as an aromatic addition to tonics or to purgatives, in debilitated conditions of the digestive organs.

CANES VENA'TICI (Lat. Hunting Dogs), a constellation of the northern hemisphere, added by Helvetius, and known generally as the greyhounds of Helvetius. The dogs are distinguished by the names of Asterion and Chara. On the celestial globe, they are represented as being held in leash by Bootes, and apparently pursuing Ursa Major (q. v.) round the pole of the heavens.

CANG, CANQUE, or KEA, an instrument of degrading punishment in use in China. It consists of a large wooden collar fitting close round the neck, and the weight of which is usually from 50 to 60 pounds. Over the parts where the C. fastens are pasted slips of paper, on which the mandarin places his seal, so that the culprit may not be relieved until the full term of his sentence has expired, which sometimes extends to 15 days. On the C. is also inscribed, in large letters, the offence and the duration of the punishment. The criminal having been paraded through the streets by the police, is then left exposed in some thoroughfare of the city. As he is incapable of using his hands, he has to be fed during the time he is suffering the penalty.

CANGAS DE O'NIS, a town of the Asturias, Spain, about 35 miles east-south-east of Oviedo. It is a poor place, but in its vicinity are one or two interesting monastic structures, and the cave whence the Goths fled and hid themselves, after the battle of Guadalete, in 711, and from which, in 718, they issued, and annihilated the Moorish invaders. Pop. 6380.

CANICA'TTI, a town of Sicily, in the province of Girgenti, and 15 miles east-north-east of the city of that name. It is situated on the banks of the

Naro, is well built, and has sulphur mines. The inhabitants, 18,000 in number, are principally engaged in agricultural pursuits.

CANICULAR, CANICULAR DAYS, or DOG-DAYS, CANICULAR YEAR. Canicular was an old name of Canis Minor (q. v.); it was also used to denote Sirius, or the Dog-star, the largest and brightest of all the stars, and which is situated in the mouth of Canis Major (q. v.). From the *Heliacal Rising* (q. v.) of this star (Sirius), the ancients reckoned their dog-days, or *Dies Caniculares*, which were 40 in number—20 before, and 20 after the rising of the star. The rising of the dog-star was in ignorance supposed to be the occasion of the extreme heat and the diseases incidental to these days. It was by mere accident that the rising of the star coincided with the hottest season of the year, in the times and countries of the old astronomers. The time of its rising depends on the latitude of the place, and is later and later every year in all latitudes, owing to precession. In time, the star will rise in the dead of winter. The Canicular Year was that known among the Egyptians and Ethiopians. It was computed from one rising of Sirius to the next, and consisted ordinarily of 365 days, and every fourth year of 366. This year was sometimes called the *Heliacal Year*. The reason for computing the year from the rising of Sirius, seems to have been that, at the time, the heliacal rising coincided with the greatest swelling of the Nile.

CANIDÆ (Lat. *canis*, a dog), a family of the Digitigrade (q. v.) section of carnivorous mammalia, which, as now generally defined, is less extensive than the Linnæan genus *Canis*, the hyænas being excluded from it, and referred to the family *Viverridæ* (civets, ichneumon, &c.). These families are, indeed, closely connected, and hyænas may be said to form a connecting-link between them, the dentition, however, making a nearer approach than in either of them to that of the cats or *Felidæ*.—The C. have two flat tuberculous molar teeth or grinders on each side, behind the great carnivorous cheek-tooth—the last præmolar—of the upper jaw, a dentition resembling that of the bear family, or *Ursidæ*, to which they exhibit a further resemblance in their power of



Dentition of Canidæ.

adapting themselves to the use of vegetable food. Their whole organisation fits them to be less exclusively carnivorous than the feline tribe. They have generally three incisors or cutting teeth, with one large canine tooth, and four præmolars on each side in each jaw, two true molars on each side in the upper jaw, and three in the lower. The true molars are adapted for trashing either bones or vegetable food. The last præmolars in the upper jaw are remarkably large, and particularly adapted for cutting flesh. See **DOG, FENNEC, FOX, JACKAL, LYCAON, WOLF, &c.**

CANIS MA'JOR, the *Greater Dog*, a constellation of the southern hemisphere, below the feet of Orion. It contains Sirius, the brightest of all the stars, and its place may be found by means of this star, which is on the continuation of the line through the belt of Orion. According to Flamsteed, it contains 31 stars.

CANIS MINOR, the *Lesser Dog*, is a constellation of the southern hemisphere. It is near Canis Major, and just below Gemini. Procyon, of the first magnitude, is its principal star, and lies in a direct line between Sirius and Pollux; so that the position of the constellation may be found by means

CANISTER SHOT—CANNIBAL.

of this star. According to Flamsteed, it contains in all 14 stars.

CANISTER SHOT. See **CASE SHOT.**

CANKER, a disease of plants, especially fatal to fruit-trees in many gardens. It is a kind of gangrene, usually beginning in the young shoots and branches, and gradually proceeding towards the trunk, killing the tree in the course of a few years. Wet subsoils seem in many cases to induce it, and it begins most readily in shoots that have been imperfectly ripened and injured by frost, or which have received some accidental wound. Those varieties of fruit-trees which have been long propagated by grafting and budding are most liable to it. It is sometimes cured by *heading down* the tree, and causing it to throw out new branches.

CANKER, a vague term applied to various diseases of the lower animals, characterised by their chronic nature, and consisting chiefly in ulceration, suppuration, and the development of fungoid excrescences in the parts affected.

CANKER, in the foot of the horse. This malady, believed by Gerlach of Berlin to be truly cancerous, is observed in two different forms: in the acute stage, when the malady is chiefly local; and in the chronic stage, when the constitution suffers, and all local remedies fail to restore a healthy function of the structures of the foot.

Symptoms.—It usually commences by discharge from the heels, or the cleft of the frog of the horse's foot. The horn becomes soft and disintegrated, the vascular structures beneath become inflamed, and the pain which the animal endures is intolerable. It is therefore very lame on one, two, or all feet, according to the number affected. Though there is no constitutional fever, the horse becomes emaciated, and unfit for work. During wet weather, and on damp soil, the symptoms increase in severity. The sore structures bleed on the least touch, and considerable fungoid granulations, commonly called proud flesh, form rapidly.

Causes.—This disease is occasionally hereditary, and it is most frequently seen in low-bred draught or coach horses. Dirt, cold, and wet, favour the production of the disease, and there is always a tendency to relapse when once an animal has been affected.

Treatment.—Pare away detached portions of horn, and, in mild cases, sprinkle powdered acetate of copper over the sore; apply over this pledgets of tow, fixed over the foot by strips of iron or wood passed between shoe and foot. In severe cases, tar and nitric acid, creosote and turpentine, chloride of zinc paste, and other active caustics, have to be used for a time with the regular employment of pressure on the diseased surface. The animal requires to be treated constitutionally by periodical purgatives and alteratives. Good food, fresh air, and exercise often aid much in the treatment of the disease.

CANNA, one of the islands of the Hebrides, off the west coast of Scotland, 7 miles south-west of Skye, and 3 miles north-west of Rum. It belongs to Argyleshire, and is $4\frac{1}{2}$ miles long from east to west, and 1 mile broad. The surface stands high above the sea, and consists of trap (claystone, porphyry, and trap conglomerate, with fragments of old red sandstone and bituminous wood), which has overflowed thin laminae of coal and shale. The island has a hill of basalt, called *Compass Hill*, which reverses the magnetic needle.

CANNABINACEÆ, a natural order of Dicotyledonous plants, or, according to many, a sub-order of **URTICACEÆ** (q. v.), differing from the proper *Urticaceæ* chiefly in the suspended, exalbuminous

seed, and hooked or spiral embryo. But only two plants of the order or sub-order are known, both of them valuable, **HEMP** (q. v.) and the **HOP** (q. v.).

CANNÉ (ancient *Canna*), a town of Naples, in the province of Terra di Bari, 8 miles west-south-west of Barletta, not far from the mouth of the Ofanto, formerly the Aufidus. It is celebrated on account of the great victory here gained by Hannibal over the Romans in the summer of 216 B. C. Hannibal crossed the Aufidus at a ford, and attacked the Romans, who in a short time were almost annihilated by the terrible Numidian cavalry. Among those left on the field were Paulus Æmilius, the consul of the previous year; Minucius, the late Master of the Horse; and a vast number of Roman knights. The loss of the Romans is stated by Livy at 45,000 infantry and 3000 cavalry. As Hannibal lost in the battle 8000 men, he did not think it prudent to follow the advice of Maharbal, and advance rapidly on Rome. Twenty thousand Romans were made prisoners, partly on the field of battle and partly in the camp.

CANNES, a seaport town of France, in the department of Var, pleasantly situated on the Mediterranean, on the road to Nice. It is famed for its salubrity, which has induced a number of English families to make it a winter residence; Lord Brougham, among others, has a fine villa here. Latterly, the town has been much improved. It has fisheries of anchovies and sardines, and a trade in the produce of the district. After his escape from Elba, Bonaparte landed about a mile and a half to the east of C., March 1, 1815. Pop. 5000.

CANNIBAL (derived from a variety in the spelling of Caribs, the original inhabitants of the West India Islands, who were reputed to be man-eaters, and some tribes of whom, having no *r* in their language, pronounced their name *Canib*), means, like the Greek word *anthropophagos*, which is often used instead of it, one who feeds on human flesh. The practice is often attributed by classical and early Christian writers to races whose practices they denounce as abominable; but the denunciation is often better evidence of the abhorrence of cannibalism by those making the accusation than of its practice by the accused. Homer makes Polyphemus eat men, but only as one of his other unnatural attributes as a monster. The early Christian writers frequently attributed cannibalism to the unconverted. St Jerome gives his personal testimony to the practice, stating that when he was a little boy living in Gaul he beheld the Scots—a people of Britain—eating human flesh; and though there were plenty of cattle and sheep at their disposal, yet would they prefer a ham of the herdsman or a piece of female breast as a luxury. Statements in old authors still more absurd induced some thinkers to believe that cannibalism is unnatural, and to deny that it was ever practised by human beings except under the pressure of starvation. The accurate observation of late travellers has, however, put it beyond doubt that cannibalism has been and is systematically practised. Comte, as part of his system of positive philosophy, accepting of cannibalism as a condition of barbarism, maintains that the greatest step in human civilisation was the invention of slavery, since it put an end to the victor eating the vanquished. The facts, however, which we possess, shew that the people systematically addicted to human flesh are not the most degraded of the human race. For instance, in the Australian continent, where the larger animals are scarce, the people,

who are of an extremely degraded type, feed on worms and herbs, and have only been known in casual and exceptional conditions to feed on human flesh. The New Zealanders, on the other hand, who are the most highly developed aboriginal race with which late European civilisation has had to compete, were, down to a late period, systematic feeders on human flesh, despising the inefficient food which satisfied the natives of Australia. In Angas's *New Zealand Illustrated*, there is a picture of the country mansion of the accomplished chief Rangihæta, 'one of the finest specimens,' says the author, 'of elaborately ornamented dwellings yet extant.' Its name is Kai Tangata, which means, Eat man; and it had been so called in pleasing memorial of the feasts held within its walls. It has been supposed that the reason why, among the Jews and several eastern nations, the eating of swine's flesh was forbidden as an unclean food, was its resemblance to human flesh, and the danger that persons accustomed to the one might not retain their abhorrence of the other. In the Crusades, the Saracens charged their Christian enemies with eating unclean food, including flesh of men and of swine. In the old romance of Richard Cœur de Lion, he is represented, on recovering from sickness, as longing for a piece of pork; but that not being procurable, a piece of a Saracen's head was substituted for it, and pronounced by him to be infinitely more palatable. There have been many sad instances where people who naturally had a horror of such food, have been driven by starvation to eat human flesh—as in sieges and shipwrecks. Besides these instances, however, and the systematic cannibals, there is no doubt that people not otherwise habituated to the practice, have been excited by ferocity and revenge to eat, and with relish, the flesh of enemies. In many of the cannibal countries, only the flesh of enemies is consumed. As an instance that this is a natural development of ferocity in degraded natures, we may take the fate of the Princess Lamballe in the French Revolution, whose heart was plucked out by one of the savages of the mob, taken to a restaurant, and there cooked and eaten by him. The great Highland chief, Sir Ewen Cameron of Lochiel, in a death-struggle with an English trooper, killed him by hitting a piece out of his throat, and used to say it was the sweetest morsel he had ever tasted.

CANNING, GEORGE, a distinguished British statesman and orator, was born in London, April 11, 1770. His father, who was descended from an ancient family, incurred the displeasure of his relatives for marrying beneath his station, and died in poverty when his son was only a year old. His mother (who for a subsistence tried the stage, with but little success, married an actor, and subsequently a linen-draper) lived to rejoice in the success and participate in the good-fortune of her boy, whose education was liberally provided by an uncle. C. was first educated at Eton, from which he passed, at the age of 17, to Christ's Church College, Oxford, where he greatly distinguished himself, especially in classics. While here, he cultivated the friendship of the Hon. Charles Jenkinson (afterwards Lord Liverpool), who was of considerable service to him in after-life. From Oxford he went to Lincoln's Inn, but on the suggestion of Burke, as it is said, he soon relinquished the bar for a parliamentary career. He entered the House for Newport, Isle of Wight, in 1793, as the protégé and supporter of the minister, Pitt. In 1796, he was appointed an under-secretary of state. It was not, however, until 1798 that C. made a reputation as an orator and a statesman, by his speeches in favour of the abolition of the slave-trade, and

against Mr Tierney's motion regarding peace with the French Directory, the latter of which, especially, was regarded as a master-piece of eloquence, alike by the House and the country. In the debates on the Habeas Corpus Suspension Act, the union with Ireland, and other important questions, C. gave valuable assistance to the ministry, not only by his voice in parliament, but by his pen in a satirical paper, called the *Anti-Jacobin*, in which he especially lashed the 'New Philosophy,' as it was called, promulgated by the French republicans. *The Knife Grinder* is one of the best known and happiest of his efforts in this line. In 1801, Pitt resigned office, and C. joined the opposition against the Addington ministry. When Pitt again became premier in 1804, C. was made treasurer of the navy, an office which he held until Pitt's death in 1806. His opposition to the short-lived Grenville ministry which succeeded, savoured of the bitterness of party feeling, and his treatment of Fox in his last days, and of his memory after his death, was far from generous. When the Portland ministry was formed in 1807, C. was appointed Minister for Foreign Affairs, a position for which he was specially qualified, and his dispatches, written at this time, are models of manliness and lucidity. In 1812 all his eloquence was enlisted in favour of Catholic emancipation. During the same year he was elected for Liverpool, for which he was again returned three successive times. In 1814 he went as ambassador to Lisbon, returned in 1816, and was made President of the Board of Control, and supported the Liverpool ministry in all their arbitrary and repressive measures until 1820, when he resigned, in consequence of the action of the government against Queen Caroline. Nominated Governor-general of India in 1822, he was on the eve of departure when the suicide of the Marquis of Londonderry called him to the head of Foreign Affairs. In this capacity, C. conferred lasting benefits on his country. He infused a more liberal spirit into the cabinet, he asserted the independence of British politics against the diplomacy that would have entangled the nation with the Holy Alliance, and gave a new direction and impetus to commercial affairs by a gradual laying aside of the prohibitive system. He arranged the relations of Brazil and Portugal; drew the French cabinet into agreement with the British respecting Spanish American affairs; was the first to recognise the free states of Spanish America; promoted the treaty combining England, France, and Russia, for a settlement of the affairs of Greece, and which was signed July 6, 1827; protected Portugal from Spanish invasion; contended earnestly for Catholic emancipation; and prepared the way for a repeal of the corn-laws. In February 1827, a stroke of paralysis forced the Earl of Liverpool to resign, and Mr C. was called upon to form a new administration. His health, however, gave way under the cares of office, and he died 8th August of the same year. His remains were interred in Westminster Abbey, near those of Pitt. As a parliamentary orator, C. holds a prominent place in British annals. His acuteness of mind, power of expression, and well-pointed wit, were remarkable; but, on the whole, he was inferior to Pitt, Burke, and Fox. He lacked the imposing characteristics of the first, the overpowering enthusiasm of the second, and the winning address of the last. He was intensely British, and his foreign policy was of the character best calculated to promote British interests.

His speeches have been reprinted in 6 vols. 8vo, by Therry, and several memoirs, including one by his private secretary, Mr Stapleton, have been published.

CANNING—CANNON.

CANNING, CHARLES JOHN, VISCOUNT, second son of the above statesman, was born December 1812. Educated at Eton and Oxford, he succeeded to the peerage as Viscount C. on his mother's death in 1837, his elder brother, who was a captain in the navy, having been drowned at Madeira in 1828. In 1841 he became Under-secretary of State for Foreign Affairs in Sir Robert Peel's government, and afterwards Commissioner of Woods and Forests. When Lord Aberdeen came into office, he was made Postmaster-general; and in the beginning of 1856, he succeeded Lord Dalhousie as Governor-general of India, an office which he still holds. His conduct during the awful crisis of the

Indian mutiny was decried at the time by many as weak and pusillanimous; but the general opinion now, when all the circumstances of the case are better known, is that he acted with singular courage, moderation, and judiciousness.

CANNING, SIR STRATFORD. See STRATFORD DE REDCLIFFE, VISCOUNT.

CANNON, is a general name for large pieces of ordnance or artillery, as distinguished from those pieces which can be held in the hand while being fired. No military weapon in use before the invention of gunpowder can fairly come under this designation; they were more generally of the kinds

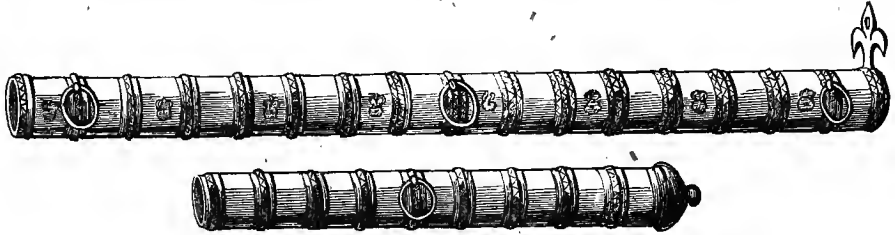

Earliest forms of English Cannon, from examples in the Tower of London.

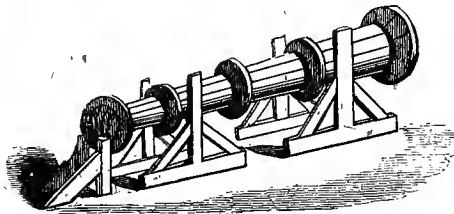

Mounting of a Cannon.—From Froissart.

described under BALISTA. At what exact date C. were first used is not known; but C., called 'crakys of war,' were employed by Edward III. against the Scots in 1327, by the French at the siege of Fuy Guillaume in 1338, and by Edward III. at Crecy, and at Calais in 1346. Figs. 1 and 2 represent early forms of English C., and fig. 3 a mode of mounting the C. on carriages. The first C. or bombards were clumsy, wider at the mouth than at the chamber, and made of iron bars hooped together with iron rings. The balls fired from them were first made of stone, afterwards superseded by iron. In the 15th c., various kinds were known by the names, of C., bombards, culverins, serpentines, &c. Bombards of great length and power were employed by Louis XI. during his Flemish campaign in 1477, some with stone balls, some with iron. About this time, C. began to be made by casting instead of with hooped bars; and bronze or brass as a material began to be used as well as iron. The C. of the 16th c. were generally smaller, but better finished, than those of the 15th. The largest C. made in the 17th c., so far as is known, was the Bejapoor cast-iron gun, 'Malick é Meidan,' or 'Lord of the Plain,' made either by Aurungzebe or by the Mahrattas; it was 14 feet long, 28 inches bore, and required a ball of 1600 lbs. weight. From the time of the great European wars in that century, C. have undergone vast improvements, as well as the science and art of artillery necessary for their management. Major Straith, a leading authority on this matter, gives the following tabular view of the chief kinds of

ordnance now, or rather recently, in use in the British service, army and navy:

Kind.	Name.	Calibre.	Length.	Weight.
		Inch.	Feet. Inch.	Cwt.
Iron Shell Guns,	12 inch,	12	8 4	90
	10 "	10	9 4	84
	8 "	8	8 9	60
	32-pounders,	6 4	9 5	56
Long Iron Guns,	24 "	5 8	9 0	47
	18 "	5 3	9 0	42
	12 "	4 6	9 0	33
	9 "	4 2	8 6	28
Long Brass Guns,	12 "	(medium), 4 6	6 7	18
	9 "	4 2	6 0	13
	6 "	(heavy), 3 7	8 6	23
	6 "	(light), 3 7	5 0	5
	3 "	(colonial), 2 9	4 0	3
Iron Howitzers,	10 inch,	10 0	5 0	40
	8 "	8 0	4 0	20
	32-pounders,	6 3	5 3	17
Brass Howitzers,	24 "	5 0	4 9	12
	12 "	4 6	3 9	6
	66 "	8 0	5 2	29
	42 "	6 8	4 4	22
Iron Carronades,	32 "	6 2	4 0	17
	24 "	5 7	3 9	13
	18 "	5 2	3 3	10
Iron Mortars,	12 "	4 5	2 8	6
	13 inch,	13 0	3 1	36
	10 "	10 0	2 4	16
Brass Mortars,	8 "	8 0	1 11	8
	5 1/2 "	5 5	1 3	150 lb.
	4 1/2 "	4 6	1 0	104 "

It must be borne in mind, however, that many of the novelties introduced within the last few years

are not here included. Nevertheless the table will be useful for occasional reference. The apparent inconsistencies in length and weight are due to the great differences in thickness of metal; and if we were to go beyond the limits of the table, we should find that, during half a century, iron 32-pounders have varied from 63 down to so low as 25 cwt., and 24-pounders from 50 to 33 cwt.; in each case the length and weight varying, while the calibre remained constant. In the above table, the calibre is not always precisely the same for the same weight of ball; as instanced by the 32-pounders, which have 6.2, 6.3, and 6.4 inches calibre; this is due to the fact that some guns have more *windage*, or space round the ball, than others.

In England, during the last few years, great expense has been incurred in replacing old C. by others of larger power and calibre; while the French are gradually bringing about a limitation in the number of kinds and sizes, for the sake of simplicity.

This being merely a general or collective notice of all kinds of C. as a class, particulars concerning each kind will be found under such headings as ARMSTRONG GUN, CARRONADE, GUN, HOWITZER, LANCASTER GUN, MORTAR, SHELL GUN, &c.

CANNON, ALLOYS FOR. The material generally used for the manufacture of ordnance is bronze (q. v.), consisting of about 90 parts of copper to about 10 parts of tin. In the casting of small C., such as 8-pounders, the alloy used contains 92½ parts of copper to 7½ parts of tin; while in the larger C. the tin is increased until the proportion reaches 88 to 12. The presence of the tin increases the hardness of the alloy, but this is obtained at the expense of the tenacity. Great care must be taken to insure the purity of the copper and the tin. If lead is present, the alloy is always more or less soft, and, moreover, liable to fuse after repeated explosions; while the presence of a mere trace of sulphur, arsenic, phosphorus, &c., renders the alloy very brittle. The finest and best kinds of tin are those known as Cornish or as Banca tin, which are almost free from lead, &c. It is customary, in the casting of C., to use up old C. or other bronze implements, so as to form a beginning of the fused metal in the furnace, and then to add little by little the extra amount of copper and tin. This mode of procedure is followed, owing to the difficulty found in getting copper and tin to amalgamate readily, so as to yield an alloy of uniform composition. This point is of great importance in the casting of ordnance, as the metals, when not properly alloyed, are liable to separate during cooling, and yield a C. of variable composition throughout.

CANNON FOUNDING is a very important manufacture, requiring a careful application of metallurgic processes. In 1856, the government invited iron smelters to send specimens of iron to the Royal Gun Factory at Woolwich, to test the capabilities of English metal for the manufacture of good guns. After three years of almost incessant experiments, it was announced, in 1859, that Netherton and Parkhead iron from Staffordshire, Bowling iron from Yorkshire, Blaenavon iron from Monmouthshire, and some other kinds, possess as many good qualities for the purpose as any foreign iron whatever—a decision which was as unexpected as it was welcome.

There are now many important questions under discussion concerning the manufacture of large ordnance. Whether cast-iron, or wrought-iron bars bound together with iron-hoops; whether iron, or steel; whether steel outside of iron, or iron outside of steel; whether iron or brass; if cast, whether cast

hollow or solid; whether to be made for breech-loading or for muzzle-loading; whether for smooth bore or rifled bore—these are points on which elaborate and costly experiments are being made. Some of the results will be noticed under the particular kinds of ordnance to which they more especially relate.

When the earlier guns, made of hooped bars, were superseded by cast guns, the latter were always cast hollow; but a French founder, in 1749, discovered a mode of boring guns cast solid. Ever since that time, cannon have been more frequently cast solid than hollow, under a belief that the texture of the metal is rendered closer by this arrangement. This, as well as many other questions relating to the manufacture of large ordnance, is at the present day undergoing reconsideration.

British iron cannon were wholly made by contract until within the last few years, mostly at the great works in Yorkshire and Staffordshire, and at Carron in Scotland; but a large factory has recently been established within the arsenal at Woolwich, and the government has to some extent acquired the power of lowering the price and expediting the supply. The casting does not differ much in detail from that of other large masses of iron-work. There is a central pattern or model of well-seasoned wood, or of iron; there is an exterior casting-box, or jacket of iron; and there is a mass of well-compacted sand and clay, or sand and coke-dust, in the annular space between the pattern and the jacket. The jacket and the annulus of sand are built up piecemeal, so that the mould shall be vertical in the casting-pit, with the muzzle upwards. At Woolwich there are furnaces, each of which would contain molten metal enough for a large gun, such as a 68-pounder; but it is deemed better to melt in two furnaces for the larger castings, and to let the two streams flow together into the mould. An additional mass of iron is left at the top, to compress the metal of the cannon by its weight when in the liquid state. After a due length of time for cooling, the jacket is opened and removed, the annulus of sand is knocked off, and the cannon is bored within and turned without, until the proper degree of smoothness is attained. In boring, according to some plans, the gun revolves, while the cutter is stationary; in others, the cutter revolves, while the gun is stationary. The cutter is a strong sharp steel tool at the end of a long bar; and a train of mechanism drives it onwards as fast as the bore is made. If the gun be cast hollow, the boring is only a kind of scraping of the interior; but if solid, the whole calibre is formed by a long-continued action of the cutter, which brings off the metal in fine fragments.

All the brass guns for British service are made by the government at Woolwich. The metal is in reality bronze, not brass (see preceding article). The general processes are similar to those for iron ordnance, with modifications depending partly on the smaller size of the guns, and partly on the characteristics of the metal. In France, brass guns are used much more largely than in England; they are lighter, stronger, and more durable than those of iron; and it is a question now largely discussed among military men, whether brass guns are or are not worth the greatly increased cost which they involve.

Certain peculiarities in the manufacture of special kinds of ordnance are noticed in the articles relating to them.

CANNON-BALL TREE (*Couroupita Guianensis*), a tree of the natural order *Lecythidaceae*, a native of Guiana, of great size, the trunk being often more than two feet in diameter. It has large

ovate-oblong leaves; the flowers are produced in racemes, they are white and rose-coloured; and the fruit is large, 'about the size of a 36-pound shot,' nearly round. The hard woody shell of this fruit is used for drinking-vessels.

CANNSTADT, a town of Württemberg, beautifully situated on the Neckar, about 3 miles north-east of Stuttgart. It owes its origin to the Romans, of whose presence there are still found many traces. It has numerous mineral springs, discharging 800,000 cubic feet of water in the 24 hours, which are much frequented during the season; manufactures of woollens, cottons, tobacco, &c.; and a large trade by means of the Neckar. Pop. 5350.

CANO, ALONSO, an illustrious Spanish painter, the founder of the School of Granada, in which city he was born, March 1601. He received his first instructions in the principles of art from his father, Miguel Cano, who was an architect; studied sculpture under J. Montanes, and painting under Pacheco and Juan de Castillo; and attained celebrity so early, that, in 1638 or 1639, he was appointed court painter and architect to the king. C. was of a hasty temper, and was accused of having murdered his wife in a fit of violent jealousy, but the accusation appears to have been quite groundless. He was, however, subjected to the torture; but no confession having been elicited, he was acquitted and received again into the royal favour, named residentiary of Granada, and spent his last years in acts of devotion and charity. He died at Granada in 1664 or 1667.

In the opinion of Fuseli, he excelled all his contemporaries except Velasquez. His eminence in the three departments of the fine arts—sculpture, painting, and architecture—obtained for him the hyperbolic honour of being called the *Michael Angelo* of Spain. His pictures, marked by graceful design and pleasing colouring, are very numerous, and are preserved in Granada, Seville, Madrid, Malaga, and other Spanish cities.

CANOE,* is a boat made of a hollowed trunk of a tree, or of the bark shaped and strengthened. Canoes have been made large enough to carry twenty or thirty hogsheads of sugar. Some have decks, and carry sail of rush or silk-grass; but they are generally open boats, rowed by paddles, and steered by an oar. They are seldom wide enough for two men to sit abreast, but vary greatly in length. Near sea-coasts, canoes are often made of light wooden-frames, covered with seal-skins, which are also drawn across as a deck, with only a hole left for one man to sit in. In the Hudson's Bay Territories, canoes are used which are light enough to be carried over the *portages*, or portions of river too shallow for navigation. Canoes, hollowed out of the trunks of oaks, seem to have been in use among the early inhabitants of the British Islands. They have been dug up in considerable numbers in England, Scotland, and Ireland. They appear to have been chiefly of two sorts—one about 10 feet long, with square ends, and projecting handles; the other, about 20 feet long, sometimes sharp at both ends, sometimes round at the prow and square at

ANCIENT CANOE.



Foreshortened View, shewing the End.

the stern. The accompanying wood-cut shews one of this last variety, dug out of a marsh in Sussex.

CANON, a word originally Greek, and signifying a measuring-rod (see **CANOE**—foot-note), applied in various arts and sciences to what serves for a rule or standard, but particularly employed to designate collectively those books which constitute the Holy Scripture, and are accepted by Christians as a rule of faith. See **BIBLE**. In ecclesiastical language, the word *canon* signifies, besides, not only a church-precept, but also the decree of a universal council, which is held valid as law. See **CANON LAW**. At one period the word was used to designate the prayers which the Roman Catholic priests said before, at, and after the consecration of the Host; the term is also employed to denote the catalogue or register of Catholic saints.

CANON, an ecclesiastical dignitary, so called as living under a rule, or as following the rule or canon of divine service. His office is of no great antiquity. According to Paschier, the name was not known before Charlemagne. This, however, is

not precisely true, for the term C. was applied in the 4th c. to cenobites living under a common rule; but the office of C. is supposed to have been first instituted by Chrodegand, or Chrodegang, Bishop of Metz, in 763. It is at least certain that he was the author of the oldest canonical rule, which was simply an adaptation of the monastic rule (commonly but erroneously attributed to St Augustine) to the priests and 'clerks' specially

* The word is sometimes said to have been borrowed by the Spaniards from the native Indian name of such boats. But a similar name exists in the Aryan languages: Ger. *kahn*, a boat; Old Fr. *cane*, a ship, and *canot*, a boat. The root of these words is the same as that of *cane* (Lat. *canna*), a reed or hollow stem, and signifies hollowness, capacity; Gr. *chaino*, to gape or yawn. From the same root come *cann*, a drinking-cup; *cannon* (Ital. *cannone*, properly a large tube, being an augmentative from *canna*, a hollow stem or tube); *canon* (Gr.), a ruler or straight rod, most readily obtained from a joint of a reed; *canal* (Lat. *canalis*, a pipe or conduit).

attached to the service of a cathedral or other church. It enjoined on the canons manual labour, the practice of silence at certain times, confession twice a year, and other duties needless to specify. The canons formed the council of the bishop; and assisted him in the government of his diocese. They lived in a house called a *monastery*, slept in a common room, ate at the same table, and were originally supported out of the episcopal revenues. In 816, Louis le Débonnaire induced the Council of Aix-la-Chapelle to draw up a general rule for the whole body of canons. Canons found their way not long afterwards into England, Scotland, and Ireland. Various reforms of C. were made in the 11th and beginning of the 12th century. Gradually, however, many began to emancipate themselves from the restrictions of monastic life, and to live independent of any rule, which is not at all surprising, for the canons were wont to keep apart from the 'lower clergy,' as they called parish priests and others who really laboured to impart religious instruction. They were often of noble families, loved titles—at Lyon, they were called *counts*—and in general were men of the world rather than true churchmen. Some of these reformed or remodelled Canons were called Black Canons, from wearing a black cassock; others, White Canons, from wearing a white habit like the *Præmonstratenses* of Picardy in France. The class of *secular* canons, whose manner of life was not conventional, and who therefore escaped destruction in England when the monasteries were abolished by Henry VIII., probably originated in a tendency to relax the severity of rule enjoined on the regulars, which indeed was hardly less stringent than in the case of ordinary monks. Secular canons still exist in the Anglican Church, and their duties—making allowance for the difference between the Roman Catholic and Protestant religions—are much the same in kind as they were before the Reformation. See CATHEDRAL.

CANON, in Music, a kind of fugue in which not merely a certain period or phrase is to be imitated or answered, but the whole of the first part with which the C. begins is imitated throughout by all the other parts. As in fugues, the melody of the part to be imitated is called the subject, and the others its reply. The C. is the highest degree of mechanical musical contrivance. The ancients spent more time in the construction and resolving of mere puzzling and unentertaining canons, than in the cultivation of good harmony and melody. Good canons, however, are always interesting, and different from any other composition. For a full treatment of writing a C., see Marpurg's *Abhandlung von der Fuge*, published by Peters, Leipzig.

CANON LAW is a collection of ecclesiastical constitutions for the government and regulation of the Roman Catholic Church, although many of its regulations have been admitted into the ecclesiastical system of the Church of England, and still influence other Protestant bodies. It was compiled from the opinions of the ancient Latin Fathers, the decrees of general councils, and the decretal epistles and bulls of the Holy See. These, from a state of disorder and confusion, were gradually reduced into method, and may be briefly described in the following chronological order: 1. *Gratian's Decree*, which was a collection of ordinances, in three books, commenced by Ivo, Bishop of Chartres, 1114 A. D., and subsequently corrected and arranged by Gratian, a Benedictine monk, in the year 1150, after the manner of Justinian's *Pandects of the Roman Law*. This work comprises ecclesiastical legislation, as it may be called, from the time of Constantine the Great, at the beginning of the 4th, to that of Pope Alexander III.,

at the end of the 12th century. 2. The *Decretals*. They are a collection of canonical epistles, in five books, written by popes alone, or assisted by some cardinals, to determine any controversy, and first published about the year 1230, by Raimundus Barcinus. They lay down rules respecting the lives and conversation of the clergy, matrimony and divorces, inquisition of criminal matters, purgation, penance, excommunication, and other matters deemed to be within the cognizance of the ecclesiastical courts. To these five books of Gregory, Boniface VIII. added a sixth, published 1298 A. D., called *Sextus Decretalium*, or the *Sext*, which is itself divided into five books, and forms a supplement to the work of Barcinus, of which it follows the arrangement. The *Sext* consists of decisions promulgated after the pontificate of Gregory IX. Then there came the *Clementines*, which were constitutions of Pope Clement V., published 1308 A. D. These decretals form the principal portion of the canon law. John Andreas, a celebrated canonist in the 14th c., wrote a commentary on them, which he entitled *Novella*, from a very beautiful daughter he had of that name, whom he bred a scholar; the father being a professor of law at Bologna, had instructed his daughter so well in it, that she assisted him in reading lectures to his scholars, and therefore, to perpetuate her memory, he gave that book the title of *Novella*. 3. The *Extravagants* of John XXII. and other later popes, by which term is meant to be denoted documents which transcend the limits of a particular collection of regulations. These books, viz., *Gratian's Decree*, the *Decretals*, and the *Extravagants*, together form the *Corpus Juris Canonici*, or great body of the 'canon law,' as formerly received and administered by the Church of Rome. There are, however, other publications of a later period, of more or less authority, but which do not appear to have received the formal sanction of the Holy See.

This C. L., borrowing from the Roman civil law many of its principles and rules of proceeding, has at different times undergone careful revision and the most learned and scientific treatment at the hands of its professors, and was very generally received in those Christian states which acknowledge the supremacy of the pope; and it still gives ecclesiastical law more or less to Roman Catholic Christendom, although its provisions have in many countries been considerably modified by the *concordats* (q. v.) which the popes now and then find it expedient to enter into with Roman Catholic sovereigns and governments, whose municipal system does not admit of the application of the C. L. in its integrity. Indeed, the fact of its main object being to establish the supremacy of the ecclesiastical authority over the temporal power, is sufficient to explain why, in modern times, it is found to conflict with the views of public law and government, even in the case of the most absolute and despotic governments.

This ecclesiastical system, however, never obtained a firm footing in England, and the great lawyers and statesmen have always shewn not only an unwillingness to defer to its authority, but even an aversion to its rule. There was, however, a kind of national C. L. in England, composed of *legative* and *provincial* constitutions, adapted to the particular necessities of the English Church. The legative constitutions were ecclesiastical laws, enacted in national synods, held under the Cardinals Otho and Othobon, legates from Pope Gregory IX. and Pope Clement IV., in the reign of King Henry III., about the years 1220 and 1268. The *provincial* constitutions are principally the decrees of provincial synods, held under divers archbishops of Canterbury, from Stephen

Langton, in the reign of Henry III., to Henry Chicheley, in the reign of Henry V., and adopted also by the provinces of York in the reign of Henry VI. At the dawn of the Reformation, in the reign of Henry VIII., it was enacted in parliament that a review should be had of the C. L.; and till such review should be made, all canons, constitutions, ordinances, and synodals provincial being then already made, and not repugnant to the law of the land or the king's prerogative, should still be used and executed. And as no such review has yet been perfected, upon this enactment now depends the authority of the C. L. in England, the limitations of which appear, upon the whole, to be as follows: that no canon contrary to the common or statute law, or the prerogative royal, is of any validity; that, subject to this condition, the canons made anterior to the parliamentary provision above mentioned, and adopted in our system (for there are some which have had no reception among us), are binding both on clergy and laity; but that canons made since that period, and having no sanction from the parliament, are, as regards the laity at least, of no force. See CANONS OF THE CHURCH OF ENGLAND.

In Scotland, Presbyterian though the ecclesiastical system of that country be, the old Roman C. L. still prevails to a certain extent. 'So deep hath this canon law been rooted,' observes Lord Stair in his *Institutes of the Scotch Law*, 'that even where the pope's authority is rejected, yet consideration must be had to these laws, not only as those by which church benefices have been erected and ordered, but as likewise containing many equitable and profitable laws, which, because of their weighty matter, and their being once received, may more fitly be retained than rejected.' In two old Scotch acts of parliament, made in 1540 and 1551, the C. L. is used in conjunction with the Roman law to denote the common law of the country, the expression used being 'the common law, baith canon, civil, and statutes of the realme.' See on the subject of this article generally, the following authorities—Blackstone's *Commentaries*, by Kerr, vol. i. pp. 65 and 66; Stephen's *Commentaries*, 4th edition, vol. i. pp. 61 and 69—vol. ii. pp. 251, 256, 257, and 290—vol. iii. pp. 45, 48, and 421—and vol. iv. p. 242; Dr Irving's *Study of the Civil Law*; and Phillimore on the *Influence of the Ecclesiastical Law, &c.*, 1851. See also a discriminating article on this subject in Knight's *Political Dictionary*, 1845; and see Wharton's *Law Dictionary*, 2d edition, 1859. It will also be found carefully treated in Dr Hook's *Church Dictionary*, 7th edition, 1854. In regard to Scotland, see Stair's *Institutes of the Law of Scotland*, I. 1, 13, and II. 8, 29; and Erskine's *Institutes of the same law*, I. 1, 28.

CANONICAL HOURS are the times fixed for divine service in the Catholic Church, but no longer strictly adhered to. These have not always been the same, and it is not known when nor by whom they were settled—some say by Popes Damasus, or Gelasius, or Gregory—but they are now fixed at seven; viz., Matins and Lauds, Prime, Tierce, Sext, Nones, Vespers, and Compline. These used to be observed as follows: Prime, Tierce, Sext, and Nones, at the first, third, sixth, and ninth hours of the day, counting from six in the morning; Vespers at the eleventh hour; Compline, or Completorium, as completing the services of the day, at midnight; and Matins shortly after midnight. These hours were by the Anglo-Saxons called Uthsang, Primesang, Undersang, Middaysang, Noon-sang, Evensang, and Nightsang. The first two and the last formed the nocturnal, the remaining four the diurnal offices. The reasons given for the

dividing the day into seven parts were—that in seven days the creation was completed, that seven times a day the just man falls, there are seven graces of the Holy Spirit, seven divisions of the Lord's Prayer, seven ages of a man's life, &c. The hours had also each its mystical reference to certain sacred occurrences, such as the incidents at our Lord's birth and crucifixion. The word 'hour,' in C. H., is derived, as some have suggested, from *ora*, a prayer; but more probably from *hora*, an hour, and called canonical because according to the canon or rule of the church. The proper offices for the C. H. are to be found in the BREVIARY (q. v.).

CANONICALS, a term used to describe the proper ecclesiastical dress of the clergy. See VESTMENTS.

CANONISATION, in the Church of Rome, the act of the pope by which a deceased person is solemnly declared to be a saint. Something analogous to it may be found in the Apotheosis (q. v.) of the ancient Romans. It had its origin in the practice of the early church, at the dispensation of the Lord's Supper, to name and pray for those who had died as martyrs. Their names, deeds, and sufferings, the manner and day of their death, were inserted in the catalogue of martyrs, called the *Canon*, and they were called saints. Each bishop was at first accustomed to declare deceased persons to be saints. The exclusive exercise of this power was gradually assumed by the popes, and proved a very fruitful source of revenue, the prevalent notions with regard to saints having become such as to attach to it a very great importance. The first papal C. was accomplished by John XV. The popes have possessed the exclusive right since 1170. The right of *Beatification* (q. v.) also belongs to them. When the pope thinks proper to canonise, he declares his views in a consistory, and an inquiry is instituted as to the virtues and merits of the person proposed. The form of a regular process at law is adopted, and an ecclesiastic is specially appointed to contend against the claims advanced, who receives the designation of *Advocatus Diaboli*; but no instance ever yet occurred of the Devil's Advocate winning a case. When a favourable decision is pronounced, the ceremony of C. is performed in St Peter's Church with great pomp. The last C. was in 1839.

The Greek Church also recognises *Canonisation*. The right to perform the ceremony lies with the Patriarch of Constantinople, but it has rarely occurred.

CANONRY, the office and dignity of a CANON. See CATHEDRAL.

CANONS, Book of, in Scottish ecclesiastical history, a code of canons or rules for the Church of Scotland, prepared by the Scottish bishops, in obedience to the command of Charles I., revised by Laud, and confirmed by letters-patent under the great seal, 23d May 1635. It tended much to increase the dissatisfaction prevalent throughout Scotland, and which soon broke out so violently. It not only required the most strict adherence to the Liturgy, then not yet published, but enjoined many things concerning ceremonies in worship beyond what Laud had been able to introduce in the Church of England; it also took away the powers of church-courts, and decreed the penalty of excommunication against all who should deny the government of the church by bishops to be scriptural, whilst its very first canon decreed that penalty against all who should deny the king's supremacy in ecclesiastical affairs.

CANONS OF THE CHURCH OF ENGLAND, called Constitutions and Canons

Ecclesiastical, agreed upon, with the king's licence, in the synod held at London in 1603—1604. They were drawn up by the Convocation, in order to give effect to the decisions of the Conference held at Hampton; and are, for the most part, a digest of old canons, with some new ones added. They are 141 in number. They are the basis of the ecclesiastical law, as far as the clergy are concerned, but they are not binding upon the laity, except in so far as they are declaratory of the ancient canon law. There had been a previous body of canons drawn up in 1571, but these had not been sanctioned by the sovereign. In 1640, the Convocation, which was then assembled with the parliament, prolonged its session beyond it, and passed a body of canons of a very arbitrary character; amongst other things, enjoining that on some Sunday in every quarter, every officiating minister should insist on the divine right of kings and their prerogatives, and enforce conformity to the rites of the Church of England. In these canons, it was directed that the communion-table should be raised in, and be placed as in cathedrals, as is now done in all churches. These canons were abrogated by an act passed in the 13th year of Charles II. An account of these canons and those now in force may be found at length in Hook's *Church Directory*.—Every clergyman, when instituted to a benefice or licensed to a cure, promises CANONICAL OBEDIENCE to the bishop—i. e., the obedience due according to the canons of the church.

CANOPIC VASES were vases used by the Egyptian priests to contain the viscera of embalmed bodies. They were arranged in a series of four—the first contained the stomach and larger intestines; the second, the smaller intestines; the third, the lungs and heart; and the fourth, the liver and gall-bladder; and each had on its lid the head of the particular deity who was supposed to preside over the contents.

CANOPUS, or CANO'BUS, a city of ancient Egypt, from which the Canopic mouth of the Nile derived its name, was situated on the sea-coast, 15 miles east of Alexandria. The Canopic mouth of the Nile appears to have been at an early period the only one into which foreign ships could enter. At C. the boundary-line between Asia and Africa was drawn by the ancient geographers. There was a temple of Hercules here, which was a secure sanctuary to all who fled to it; also one of Serapis, as several extant Greek inscriptions shew. The inhabitants of C., a mixed Egypto-Hellenic people, were infamous, in the Greek and Roman times, for their profligacy. The city declined after the rise of Alexandria. Traces of its ruins are visible about 3 miles from Aboukir.

CANOPUS is also the name of a very brilliant star of the southern hemisphere, in the constellation of the ship *Argo*, and, as Plutarch relates, received its name from Canopus, the pilot of Menelaus.

CANOPY (Lat. *Canopeum*; Gr. *Kānopeion*, from *Kānope*, gnat or mosquito). The derivation of this word throws a curious light on its original meaning, which probably was a mosquito-curtain. The simplest form of C., in this its primitive sense, is that mentioned by Herodotus (ii. 95), who tells us that the fishermen on the Nile were in the habit of suspending the net with which they had fished during the day on an upright pole, from which it was expanded into the form of a tent, and served to protect them from the attacks of insects during the night. As it has been proved that insects will not pass through the meshes of a net, though wide enough to admit them, it is probable that this simple contrivance may have been quite effectual for the purpose

for which it was used. Horace (Epod. ix. 9), and others of the ancient writers, mention gnat-curtains (*canopea*). Subsequently, the same term came to be used for the projecting covering and hangings of a bed, without reference to their original use, and latterly for any projecting covering of a similar form, to whatever use it might be adapted, or of whatever materials it might be formed. C. is thus used to signify the covering which is borne over the heads of kings and other persons of distinction, and still more frequently over the Holy Sacrament and the image of Christ, in processions in Roman Catholic countries. See BALDACHIN.

In Gothic architecture, C. is the term applied to those rich coverings which are frequently met with over niches and tombs, and sometimes over doors and windows. It belongs chiefly to the decorated and perpendicular styles, though it was not unknown much earlier. The C. consists of a roof, which may be supported on pillars all round, or may have one, or if in an angle *two*, sides attached to the wall, with dependent ornamental work representing drapery. The early English canopies are usually simple in form; those in French buildings of the same period being greatly more complicated and elaborate, as, for example, those in the cathedrals of Chartres and Bayeux. In the decorated style, the canopies were richly ornamented and very various in form, as in the accompanying illustration. Some canopies are ornamented

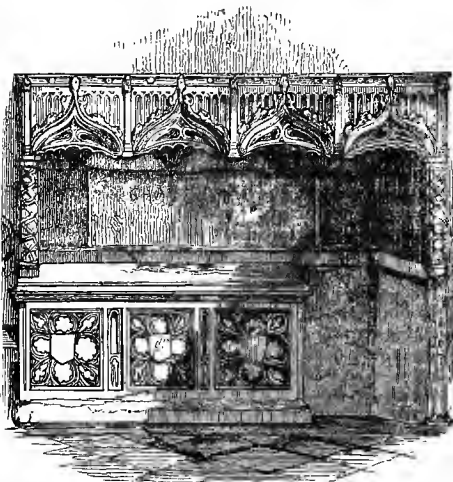

Canopy over Chaucer's Tomb in Westminster Abbey.

by pinnacles supporting smaller canopies, the whole terminating in a structure resembling a small turret, or crocketed spire. In the perpendicular style, though more varied in form, the canopies resemble those in the decorated. Most of the cathedrals and larger churches of England furnish examples of canopies, many of which are enumerated in Parker's *Glossary of Architecture*. For the use of canopies in Italian architecture, see BALDACHIN.

CANOSA, a town of Naples, in the province of Terra di Bari, 13 miles south-west of Barletta. It is situated on the declivity of a steep hill, upon the summit of which there are the remains of an old castle. It has a cathedral; and in an adjoining court is a tomb to Bohemond, Prince of Antioch. It is chiefly remarkable, however, in connection with the discovered antiquities of ancient *Canusium* (one of the chief cities of the Apulians, the origin of which

is obscured in the mists of mythology), on the site of whose citadel the modern town is said to stand. The antiquities consist of subterranean sepulchres, containing painted vases and funereal furniture of the most magnificent description in perfect order, painted busts, marble statues, &c. Many of the bodies found here were attired in cloth of gold, with head-dresses gleaming with precious stones, and earrings and bracelets of rich and exquisite workmanship. The objects were transferred to the museum at Naples. The ruins of an amphitheatre, aqueduct, &c., have also been found. C. suffered by earthquake in 1851. Pop. 8000.

CANOSSA, a town of Modena, Northern Italy, about 12 miles south-west of Reggio, celebrated as the place where, in 1077, the Emperor Henri IV. of Germany obtained absolution from Pope Gregory VII., after he had abased himself by three days' supplication, bareheaded and barefooted.

CANOVA, ANTONIO, the founder of a new school of Italian sculpture, was born, November 1, 1757, at Possagno, a village in the Venetian territory. Having displayed in boyhood great talent in modelling, the artist gained the patronage of Giovanni Faliero, a Venetian senator, by whom he was sent to work under a sculptor at Bassano. His first imaginative performance, 'Eurydice,' half the size of life, was executed in his 17th year. After this he went to Venice, where his study of art properly began. In 1779, Faliero sent him to Rome, with an introduction to Cav. Zuliano, the Venetian ambassador, and one of the most illustrious patrons of art at this time in Italy. In Rome the first result of his studies appeared in the statue of 'Apollo,' which must be regarded as his earliest effort in ideal sculpture; but a far greater progress toward the pure style of the antique was evident in his next work, 'Theseus with the Centaur.' Nevertheless, G. did not rigorously adhere to the severe simplicity of the antique, but rather took pains to mitigate it by a peculiar grace and loveliness of his own, such as characterised his group of 'Cupid and Psyche,' which was produced soon after he had completed the monument of Pope Clement XIV. This is apparent even in the colossal monument of Clement XIII. (erected in St Peter's, 1792); though this work, on the whole, is a magnificent effort of genius, simple in style, and with nothing overwrought in the figures. Among his other works may be noticed a 'Winged Cupid,' 'Venus and Adonis,' a 'Psyche holding a Butterfly,' 'Penitent Magdalen,' in life-size; 'Hercules hurling Lichas from the rock,' a colossal work, but not free from affectation; 'Kreugas and Damoxenos' (two pugilists), 'Palamedes,' and 'Perseus with the head of the Medusa,' a work which, more than all previous efforts, served to raise his fame. In 1802, C. was appointed by Pope Pius VII. chief curator of all Roman works of art in the Papal States; but was soon called away to Paris, to prepare the model of a colossal statue of Bonaparte.

After the fall of the French empire, C., in 1815, was employed by the Roman government as ambassador to recover the works of art which had been taken to Paris, and paid a visit to England. On his return to Rome, he was created Marquis of Ischia, with a pension of 3000 scudi. This money he expended in the support of art and artists in Rome. C. died in Venice, 13th October 1822. A marble statue was erected to his memory in the Church de' Frati, 1827. Another monument to C. was erected in the library of the capitol, by order of Leo XII., in 1833.

It is universally allowed that to C. belongs the

honour of having restored to sculpture the position which it had lost among the modern fine arts. After Michael Angelo Buonarrotti and Bernini, he was the third of epoch-making Italian sculptors. His delicate execution and masterly treatment of marble are unrivalled, and even his faults—viz., his exaggerated nicety and careflessness, and his use of corrosives to produce fine finish—served to attract by the novel effects which they produced. The essential characteristic of all his works is sentiment—often verging, however, on sentimentalism—and this also, like his delicacy in details, was accordant with the taste prevalent in his time, and was the chief cause of his popularity, as of his errors. When judged by the sterner principles of antique sculpture, the works of C. are found deficient in that objective or realistic character which Thorwaldsen could express so well.

During his leisure hours C. amused himself in painting, in which he attained such a degree of excellence in following the colouring of the Venetian masters, that his pictures have even deceived connoisseurs. In his private life, C. was a very amiable and benevolent man. Biographies of C. have been written by Missirini (4 vols. Prato, 1824), Cicognara (Venice, 1823), and Rosini (Pisa, 1825).

CANROBERT, FRANÇOIS CERTAIN, DE, Marshal of France, born in 1809, studied in the military school of St Cyr, and in 1828 entered the army. In 1835 he sailed for Algeria, and during the war in the province of Oran was made a captain. In the storming of Constantine, he was one of the first who entered the breach, when he received a wound in the leg. About the same time he had the decoration of the Legion of Honour conferred upon him. In 1846 he became lieutenant-colonel, and soon after colonel. In 1848 he had the command of an expedition against the tribes of the Bouaou, whom he defeated at the Pass of Djerma, and was victorious against the Kabyles. As general of brigade, in 1850 he led an expedition through the rocky country of Narah, and destroyed the Arab stronghold there. In January 1853, he became a general of division. He had the command of the first division of the French army under Marshal St Arnaud, sent to the Crimea in 1854; and at the battle of the Alma, was wounded in the breast and hand by the splinter of a shell. On the death of the marshal, C. took the chief command of the French army; and at Inkermann was slightly wounded, and had a horse killed under him. In 1855 he resigned his position to General Pelissier, and resumed the command of the first division. The same year he was made G.C.B. On the birth of the heir to the imperial throne, March 16, 1856, he was created a marshal of France. In the war in Italy against the Austrians, in 1859, C. had the command of the third division of the French army; and at the battle of Magenta, June 4, his *corps d'armée* turned the left of the Austrians. In the great battle of Solferino, on the 24th of the same month, his division was hotly engaged, and lost 1000 men in killed and wounded.

CANSO (Cape), the eastern extremity of Nova Scotia, and the southern boundary of the entrance of Chebucto or Chedabucto Bay. It is in lat. 45° 17' N., and long. 61° W.—2. (Strait), a passage of 17 miles in length and 2½ in average breadth, connecting the inlet just mentioned with the Gulf of St Lawrence, so as to form an island of Cape Breton. Of the three channels between that inland sea and the open ocean, it is the one that is least frequently used by European vessels.

CANT, on shipboard, is a name given to such

timbers, near the bow and stern, as lie obliquely to the line of keel. It is also a general term for anything sloping, inclined, or turned aside. 'Canting' is to turn anything over, or out of its proper position.

CANT, ANDREW, a Scottish divine of the 17th c., was first minister of Pitsligo, in the north of Scotland, and afterwards in Aberdeen. In July 1638, he was one of the commissioners sent to that city, to compel the inhabitants to subscribe the National Covenant; and in November of the same year, he was a member of the memorable General Assembly, held at Glasgow, which abolished Episcopacy in Scotland. He was with the Scots army when it obtained possession of Newcastle, August 30, 1640; and in 1641, on the second visit of Charles I. to Scotland, C. preached before his majesty at Edinburgh. In 1660, in consequence of a complaint presented to the magistrates of Aberdeen, charging him with having published a seditious book, entitled *Lex Rex*, and with fulminating anathemas and imprecations against many of his congregation, C. relinquished his charge and left the town. He died about 1664.

CANTABILE, in Music, is found in several significations. In general, it is placed over passages of easy and flowing melody, as well in instrumental as vocal music. In songs, the melodies which lie chiefly in the middle region of the voice are marked C.: extreme tones of the voice have a peculiar *timbre* and character quite foreign to the cantabile. C. marked at the beginning of a piece means rather slow than quick. In the C. style the finest effects can be produced by the singer in swelling, sustained sound, the portamento, &c. C. is also called *cantilene*.

CANTABRI, a rude race of mountaineers in ancient Spain, were of Iberian origin, and lived in the district now known as Burgos, and on the coasts of the Bay of Biscay, which derived from them its name, *Oceanus Cantabricus*. The most important of their nine towns were Juliobrica (near the source of the Ebro), Vellica, and Concana. The C. are described as like the Scythians and Thracians in hardihood and martial character, sleeping on the bare earth, enduring extreme pain without a murmur, and, like most savages, leaving agricultural toil to their women. Their bravery was evinced in the Cantabrian war, a six years' contest with the Romans, begun under Augustus, and concluded by Agrippa, 25—19 B.C. Tiberius afterwards stationed garrisons in the towns of the conquered C.; but some portion retreated into their fastnesses among the mountains, where they preserved their independence. They are supposed to be the ancestors of the **BASQUES** (q. v.).

CANTABRIAN MOUNTAINS, the general name of the several ranges of coast and boundary mountains, extending along the north coast of Spain, from Cape Finisterre, to the southern base of the West Pyrenees, and so dividing the coast districts from the interior elevated plateau of Castile. The summits of the mountains here and there reach the lower line of the snow region, with a more gentle slope on the south side, and forming plateau-districts from 1600 to 2000 feet high on the north, where the slopes are steeper and intersected by coast rivers, leave in several parts only narrow stripes of flat coast-land, and running out into the sea form several bold promontories. The whole group of mountains is named variously by the people of various localities, and includes the Sierra de Aralar, Salvada, Anagná, Sejos, Albas, and Altuna—all more or less wild and romantic, but having those fertile and prosperous trading districts which

distinguish the Basque Provinces and Asturias from the sterile central plateau of Spain.

CANTAL, a central department of France, formed out of the south portion of the old province of Auvergne. It has an area of 2090 square miles, and a population, in 1856, of 247,665. —See **AUVERGNE**.

CANTALIVER, or **CANT-LIVER**, a large bracket used in architecture for supporting cornices, balconies, and even stairs. Cantalivers are often highly ornamented. The accompanying example is from a stair at the corner of Randolph Crescent, Edinburgh.

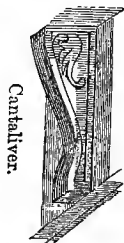

CANTARINI, SIMONE, also known as **SIMONE DA PESARO** or **IL PESARESE**, an Italian painter, was born at Pesaro in 1612. He studied under Guido Reni at Bologna; but his intolerable arrogance made him numerous enemies, and in consequence he left the city, and went to Rome, where he won a high reputation, and was thought by many to excel even his master in the graceful finish of his brush. On his return to Bologna, he opened a school, but shortly after accepted an invitation from the Duke of Mantua to visit that city. Here also his excessive self-esteem involved him in disagreeable relations with everybody, and at last he quarrelled with the duke himself, on which he left for Verona, where he died in 1648, under suspicion either of having poisoned himself, or of having been poisoned by a Mantuan painter whom he had injured. C. was distinguished in modelling and flesh-colouring. A 'Madonna upborne by Angels,' and a head of Guido when old, in the gallery at Bologna; and others elsewhere, remain as proofs of his skill. His thirty-seven etchings closely resemble the etchings of Guido Reni, and have, in several instances, been fraudulently sold with the mark of this master forged upon them.

CANTA'TA, in Music, is a name given to a vocal composition; but it is so very indefinite, that it in no way shews in what respect such composition differs from any other. In Zedler of Halle's great *Lexicon*, the C. is defined as a 'long vocal composition, the text of which is Italian,' &c.; while in Sulzer's *Theorie der Schönen Künste*, it is said to be 'a short piece of vocal music of a pathetic nature,' &c. The C. is always more extended and wrought out than the simple song, and consists of different movements.

CANTEEN, is a refreshment-house in a barrack, for the use of the soldiers. The chief articles of food are supplied to the troops direct by the government; but malt liquor, spirits, and small grocery-ware, the soldier is left to buy for himself; and the C. is, or is intended to be, a shop where he could make these purchases economically without the necessity of going beyond the precincts of the barrack. Practically, however, they are little more than beer and spirit shops. One of the officers twice a week inspects the goods sold at the C., and occasionally insists on the price being lowered. No soldier is obliged to buy anything at the C.; he may lay out his small sums elsewhere if he prefer. Between the years 1836 and 1845, it was found that, among 112 canteens in the United Kingdom, the rent and head-money paid varied from £4 per annum (one at Guernsey) to £1344 per annum (one at Woolwich); they brought in collectively to the government about £70,000 annually. Great intoxication having resulted from the sale of spirits at the canteens, the War Office prohibited

CANTEEN—CANTERBURY.

such sale in 1847; as a consequence, the rents had to be lowered to the extent of £20,000 in the following year, the cantineers finding their profits much reduced. It is believed that the rent paid is injurious to the soldiers, who are charged higher prices within the barrack than without, and who are thence driven to places where dangerous temptations are at hand. So bad, at one time, were the disorderly scenes at the canteens, that many officers suggested their suppression altogether. A committee on barrack-accommodation (see **BAR-RACKS**) lately recommended an improved organization.

In French barracks, the C. is a sort of club-room for the whole regiment. The cantineer is a non-commissioned officer, who acts merely as an agent for all, selling the liquors and commodities at prime cost.

CANTEEN, besides its application to a room or building, is a name also given to a vessel used by soldiers to contain whatever beverage may be obtainable on the march or in the field. It is sometimes of tin, sometimes of wood. In the British army, the C. is a wooden vessel, holding about three pints, painted blue, and inscribed with the number or designation of the regiment, battalion, and company to which the soldier belongs.

There is still another use of the word C., as a name for a leathern or wooden chest, divided into compartments, and containing the plate and table-équipage for a military officer when on active service.

CANTERBURY, a municipal and parliamentary borough, a county by itself, a cathedral city, and seat of the metropolitan see of all England, in East Kent, on the Stour, 56 miles east-south-east of London, on the high road from London to Dover. The distance from London by the South-Eastern Railway is 81 miles; by the London, Chatham, and Dover line, about 60. It stands on a flat between hills of moderate height. It has the aspect of an old town, many of the houses along the high street having gabled ends and projecting fronts. It has little manufacture or traffic. The chief trade is in corn, wool, and hops. Pop. 13,398. Many are engaged in the hop-grounds around. C. returns two members to parliament. It is noted for its brawn. Some remains of the walls (1½ mile in circuit and 20 feet high) which formerly surrounded C., and one of the gates, still exist. Near the city wall is a large artificial mound, known as the Dane John (probably *Donjon*), and connected with this mound is a public garden, laid out in the end of the 18th c., from the top of which is a fine view of the country around. But the great glory of C. is its magnificent

Cathedral. When St Augustine became Archbishop of Canterbury, 597 A.D., he consecrated, under the name Christ's Church, a church said to have been formerly used by Roman Christians. Cuthbert, the 11th archbishop, 740 A.D., added a church to the east of this. In the course of ages, it received numerous additions, until it assumed its present magnificent form. Among those who helped to repair, enlarge, and rebuild it, were Archbishops Odo (940 A.D.), Lanfranc (1070), and Anselm (1093). In 1174 the choir was destroyed by fire, and in order to the rebuilding of it, a number of French and English artificers were summoned. Among the former was a certain William of Sens, and to him, a man of real genius, the work was intrusted. The church was rich in relics: Plegmund had brought hither the body of the martyr Blasius from Rome; there were the relics of St Wilfred, St Dunstan, and St Elfege; the murder of Thomas Becket (q. v.) had recently added a still

more popular name to the list of martyrs. The offerings at these shrines, especially the last, contributed greatly to defray the expenses of the magnificent work. William of Sens did not, however, live to see its completion. He was succeeded by another William, an Englishman, and to him we owe the completion of the existing unique and beautiful choir, terminated by the corona or circular chapel called Becket's Crown. Gervasius, a monk, who witnessed the fire of 1174, and has left an account of it, tells us that the parts of Lanfranc's church which remained in his time were the nave, the central and western towers, the western transepts, and their eastern chapels. In the 14th c., the nave and transepts were transformed into the Perpendicular Style of that period. The central tower, called the Angel Steeple, was carried up (1486—1504) to about double its original height, also in the Perpendicular Style; it is 234 feet high, and 35 feet in diameter. The north-west tower was taken down in 1834; it was 113 feet high, and divided into five stories. The Norman plinth still remains on each side of the nave in the side aisles, and portions of Norman ashlar, may still be seen about the transepts outside the west wall, and on the east piers of the great tower. The indiscriminate use of the 'Round' or 'Norman,' and the 'Pointed' or 'Early English' arch, is also a very striking feature in the eastern part of the building. The Lady Chapel, now called the Dean's Chapel, stands on the north side of the church, and was built in 1468; the roof is a fan-vault. The north transept is called the Martyrdom, for here took place the murder of Becket, on Tuesday, December 29, 1170. Fifty years later, his remains were translated from the crypt to a shrine in the newly erected Trinity Chapel, eastward of the choir. About the year 1500, the yearly offerings at this shrine amounted to £4000; but they had then declined much in value. A curious mosaic pavement still remains in front of the place where the shrine stood, and the stone steps which lead up to it are worn by the knees of countless pilgrims; but the shrine itself was demolished in 1538, and the bones of the saint burned by order of Henry VIII. In 1643, the building was further 'purified,' as it was called, by order of parliament. Still very many most interesting monuments remain—such as the tombs of Stephen Langton; that which is commonly, but wrongly, supposed to be the tomb of Archbishop Theobald; with those of the Black Prince, of Henry IV., of Archbishops Maphan, Peckham, Chicheley, Courtenay, Sudbury, Stratford, Kemp, Bourchier, Warham, and of Cardinal Pole. The total exterior length of the cathedral is 545 feet, by 156 in breadth at the eastern transept. The crypt is of greater extent and loftier—owing to the choir being raised by numerous steps at the east end—than any other in England.

The Archbishop of C. is primate of all England, metropolitan, and first peer of the realm. He ranks next to royalty, and crowns the sovereign. His ecclesiastical province includes all England, except the six northern counties. Among his privileges, he can confer degrees in divinity, law, and medicine. His seats are at Lambeth and Addington Park. He is patron of 149 livings, and has an income of £15,000 a year. There are four-teen old churches in C., mostly of rough flint, and containing fragments of still older structures. St Martin's Church stands on the site of one of the 7th c., and is partly built of ancient Roman brick and tile. Attached to the cathedral is a grammar school, remodelled by Henry VIII. Part of St Augustine's Benedictine Abbey still remains, with its fine gateway, near the cathedral. It occupied, with its

precincts, sixteen acres. The old buildings have lately received large modern additions, in order to fit them for the purposes of a missionary college in connection with the Church of England. Another recent institution for education is the Clergy Orphan School, which occupies a conspicuous position on St Thomas's Hill, about a mile out of the city. The ruins of a Norman castle, 88 by 80 feet, the third in size in England, stands near the city wall. C. stood, in Roman times, at the union of two Roman roads from Dover and Lympne, the chief seaports of the Romans. C. was the capital of Kent, and the centre from which England was Christianised. St Augustine, the apostle of England, sent by Gregory I., was the first archbishop, and baptised King Ethelbert of Kent. C. was the Saxon *Caer Cant*, City of Kent, and capital of the kingdom of Kent. The Danes in the 9th, 10th, and 11th centuries often ravaged and burned the city. Henry VIII. confiscated the treasures of the cathedral, and Edward VI. levied fresh exactions from it. The cathedral suffered much in the parliamentary struggles, but it has been in recent times repaired.

CANTERBURY, a settlement of about 2400 square miles, on the east coast of the north island of the New Zealand group, with Christchurch as its capital, and Lyttelton as its port. The district professes to be more specially set apart for Episcopalians. In 1853, its external trade stood thus: imports, £216,383, 5s. 2d.; exports, £108,713, 12s. 4d.—total, £325,096, 17s. 6d. Of this amount, wool, to the weight of 1,352,011 lbs., gave £90,134, 1s. 4d., or more than five-sixths of the whole. The other articles, arranged in order of worth, were potatoes, wheat, cheese, oats, oil, whalebone, tallow, sheepskins, barley, gold-dust, hides, curiosities, and seeds.

CANTERBURY BELLS. See CAMPANULA.

CANTHARELLUS. See FUNGI, EDIBLE.

CANTHARIDINE. See CANTHARIS.

CANTHARIS (Gr. a small beetle, plural *Cantharides*), a genus of insects of the order *Coleoptera*, section *Heteromera*. See COLEOPTERA. It belongs to a family called *Trachelides*, or necked beetles, the head being separated from the thorax by a distinct neck or pedicel, and forms the type of a subdivision of that family called *Cantharidiae*, many of the species of which possess blistering properties analogous to those of the common BLISTERING FLY, SPANISH FLY, or BLISTER BEETLE (*C. vesicatoria*). This insect, the best known and most important of the genus, is about an inch long; has a large heart-shaped head, rather broader than the thorax; thread-like antennae three times longer than the head; a nearly quadrangular thorax; and soft elytra (wing-covers) concealing the abdomen, and of equal breadth throughout. It is of a bright glossy green colour, and exhibits not a little of that metallic brilliancy which characterises many beetles, and in particular many of the *Cantharidiae*. This metallic brilliancy is of use in detecting cases of poisoning by *Cantharides*, golden green particles being always seen in powders made of these insects, and these particles remaining long unchanged whilst decomposition is taking place around them. The common Blistering Fly is found in the south of Europe, and in the south of Siberia. It is abundant in Italy, Sicily, and Spain, in the south of France, in Hungary, and in some parts of Germany and Russia. It is rare in England, but in 1837 great numbers appeared in Essex, Suffolk, and the Isle of Wight. The larva is not well known. The perfect insect feeds on the leaves of the ash, privet, lilac, elder, and honey-suckle; and rests on them during the night, the day being its time of activity. It is therefore taken by beating the branches of the trees in the morning or

evening, when it is comparatively lethargic, a cloth being spread below to receive the insects as they fall. The gathering of *Cantharides* takes place, in the south of France, in the month of May. It requires great caution to prevent injury to those who engage in it, the insects emitting a volatile substance with a strong smell, which causes inflammation of the eyes and eyelids, convulsive sneezing, and irritation of the throat and bronchial-tubes, nor can they be handled without danger of blistering. Those who collect them, therefore, generally wear gloves and veils. Unpleasant effects have been experienced from even sitting under trees on the leaves of which cantharides were numerous. Various methods are employed for killing cantharides when they have been taken; the cloths containing them are very generally immersed in hot vinegar and water, and they are afterwards carefully dried; sometimes they are killed by the vapour of vinegar, and sometimes by oil of turpentine. Unless kept with great care, they soon begin to lose their active properties, although, in stoppered bottles, they remain fit for use for years. They are very liable to be injured by mites, and afford a favourite food also to a kind of moth and to some other insects. They are imported into Britain from the south of Europe, and also from St Petersburg. The Russian cantharides are rather more highly esteemed than any other.—Some of the species of the genus *Meloë*, including one or two British species, are occasionally used as vesicants, but their use seems to be attended with danger, except in veterinary practice.

The active principle of the blistering flies is *cantharidine*, which possesses such powerful blistering properties, that $\frac{1}{10}$ th of a grain placed on the lip rapidly causes the rise of small blisters. Administered internally, blistering flies cause heat in the throat, stomach, intestines, respiratory organs, &c.; and if in large doses, they give rise to inflammation of a serious nature, and sufficient to cause death. Externally, they are employed as a *blistering agent*. There are various medicinal preparations of blistering flies, such as *Vinegar of Cantharides*, obtained by macerating blistering flies in acetic acid; *Tincture of Cantharides*, procured by digesting blistering flies in proof-spirit, &c.; but that most commonly employed is *Plaster of Cantharides* or *Blistering Plaster*, obtained by mixing equal parts of blistering flies, yellow wax, resin, and lard. See BLISTER.

CANTICLES, a word which literally signifies songs, but which is specially applied to a canonical book of the Old Testament, called in Hebrew *The Song of Songs*—i. e., the most beautiful song. The author is commonly supposed to be Solomon, and in the rich luxurious splendour of its colouring, it admirably harmonises with the 'golden time' of that magnificent monarch. The theme which it celebrates is love; but what kind of love, whether earthly or spiritual, is a question that has perplexed biblical critics. The oldest interpretations are allegorical, and are either political or religious. The former of these, considered C. as the symbolical expression of a deep longing for the reunion of the kingdoms of Judah and Israel; the latter, of the love of God for his chosen people, the Jews. The religious interpretation passed over from Judaism to Christianity, and assumed a new aspect in consequence. Origen and Jerome found in Christ, the Beloved Bridegroom, and in the Church, the Bride. Similarly did Augustine and others explain the poem. Only among the theologians of the Syrian school, especially in that remarkable man Theodorus of Mopsuestia, do we find an effort made to adhere to more intelligible principles of interpretation, but the 'mystical view' obtained the upper hand. At the

CANTILENA—CANTON.

Reformation, it was opposed by Erasmus, and adopted by Luther. It is still the popular view of the poem among orthodox theologians, many of whom have endeavoured to unfold its supposed spiritual or mystical meaning often with more ingenuity than wisdom. Whether C. is one song, an anthology of detached erotic idyls, or a whole formed of connected parts, is doubtful. Father Simon was the first to maintain the second of these opinions; which has been since advocated by Eichhorn, Jahn, Pareau, and others. Sir William Jones and Dr Mason Good adopt the third; Ewald, on the other hand, does not consider it idyllic at all, but maintains that it is a drama in five parts; while Bossuet regarded it as a pastoral eclogue, consisting of seven acts, each act filling a day, concluding with the Sabbath. Its object, according to Dr Davidson, 'appears to be to depict true, chaste love in humble life.'

CANTILENA. See CANTABLE.

CANTYRE, or KINTYRE (Gaelic, headland), a long narrow peninsula of Argyleshire, running north and south between Arran Isle and the Atlantic, and united at the north end with the mainland of Scotland by the isthmus of Tarbet, a mile broad between East Loch Tarbet, a small loch or bay of Loch Fyne, and West Loch Tarbet. It is 40 miles long, and, on an average, 6½ broad. The surface is much diversified by low, undulating, moorish hills, with many lochs. The highest point is Bennear, 1515 feet. It contains much cultivated land. The north four-fifths of C., and the south-west corner round the Mull, or promontory, of Kintyre, consist chiefly of mica slate. Old red sandstone occurs on the south-east shore. Coal is found between Campbelton and the west coast. A light-house, 297 feet above the sea, stands on the Mull of Kintyre. C. includes 10 parishes. Pop. 17,916. Campbelton (q. v.) is the chief seat of population. C. was in ancient times peopled by Picts and Celts more densely than the rest of Scotland. The Scots from Ireland subdued it in 210 A. D., were expelled from it in 446, but returned in 503 under Fergus, the first Scottish king, who fixed his seat at Campbelton. Kenneth II. (MacAlpine), on defeating the Picts in 843, removed to Forteviot. From the 8th to the 12th c., C. was occupied by Northmen from Scandinavia, and afterwards by the Macdonalds of the Isles, and more lately by the Campbells. Many burying-grounds and small ruined chapels or monasteries in C., shew its former populousness. Near these chapels, and in the villages, are many high, upright slate crosses, with rude figures and inscriptions on them. C. contains many ancient watch or ward forts often vitrified.

CANTO, in Music, an Italian term for the highest vocal part or treble. See also SOPRANO.

CANTO FERMO, in Church Music, means plain song, or choral song in unison, and in notes all of equal length. Its introduction into the Christian church is attributed to Pops Gregory the Great, before the invention of the modern notation. See also GREGORIAN TONES.

CANTON. In Heraldry, the C. occupies a corner of the shield, either dexter or sinister, and in size is the third of the chief. It is one of the nine honourable ordinaries, 'and of great esteem.'

CANTON (from the Fr. *canton*, a corner, a district; Ger. *kante*, a point, corner, border; allied to Eng. *cantle*), signifies in geography a division of territory, constituting a separate government or state, as in Switzerland. In France, C. is a subdivision of an *arrondissement*.

CANTON, a large commercial city and port in the south of China, and capital of the province of

Kwang-tung. It is situated in lat. 23° 7' 10" N., and long. 113° 14' 30" E., on the north side of the Choo-Keang or Pearl River, 32 miles from the sea. The river (the entrance to which is known by the name of the Bocca Tigris) is very picturesque. The city is surrounded by a rampart six miles in circumference, and entered by 12 gates, to each of which a guard-house is attached. It forms an irregular square, and is divided by a wall into the North and South, or Old and New City. The former is inhabited by the Tatar population, the latter by Chinese; and between the two, communication is maintained by four gates in the separating wall. The suburbs are very extensive, and in one of these, facing the river, stood the European factories or *hongs*. Many of the streets of C. are devoted to distinct trades; thus there is 'Carpenter' Street, 'Apothecary' Street, &c. The Joss-houses, chiefly Buddhist temples, are said to be 124 in number. The largest of these, on Honam Island, covers seven acres, and has 175 priests attached; there are several many-storied towers or pagodas, a Mohammedan mosque, a founding hospital, an English and an American missionary hospital. The former, conducted by Dr Hobson, was opened by him in the western suburb April 1, 1848, and continued in most successful operation till October 1856, when the difficulties that arose between Yeh and the British authorities compelled its temporary abandonment. It appears from the printed report, that from July 1, 1855, to June 30, 1856, 32,618 persons attended, and 14,600 books of religious information were distributed. Streets of wooden houses were formerly to be seen on the river-side, but these were swept away during the late quarrel with Yeh; and one large site that they occupied is now walled in, preparatory to the erection of the new foreign factories, the old ones having been totally destroyed by fire. A very remarkable example of life upon the water is the boat-town of Canton. The total population of the city has been vaguely estimated at 1,000,000. The climate of C. may be pronounced healthy; though the heat from June to September is oppressive, and the thermometer sometimes stands at 100° in the shade. The north-east monsoon commences in October, and is the prevailing wind till March, when the south-west monsoon sets in. Its average temperature is 70½° F., and the annual fall of rain 70-625 inches. The Cantonese are notorious for their turbulence and hatred of foreigners, and the European factories have more than once been attacked by infuriated mobs, who were only kept at bay by force of arms. This hostility may, however, be greatly due to the baneful influence of those in power; for here the government of the mandarins of the present Manchoo Tatar dynasty appears to have reached its maximum of corruption and barbarity, and was fitly represented by the notorious Yeh, late governor-general of Kwang-tung and Kwang-se. The author of *Twelve Years in China* gives us some startling facts illustrative of mandarinic rule in this part of China. After the defeat of the Triad rebels, who besieged C. in 1844-1845, it is estimated that 1,000,000 of people perished in the province, of whom some 100,000 were executed in the city of Canton. British trade had been confined almost entirely to C. for about 200 years, when the monopoly of the East India Company ceased on the 22d April 1834. Since that date the proceedings of the C. government officers have originated two wars with the British. The city was captured by the allied French and English forces December 1857, and is at the present time (September 1860) garrisoned by them. See CHINA. After the treaty of Nankin (signed 29th August 1842), C. was known as one of the five ports; Amoy, Foochow, Ningpo, and

CANTONMENTS—CANVAS.

Shanghai, having also been thrown open to foreign commerce.

Placed at a distance from the capital, the principal tea-districts, and the great commercial marts of the empire—with the anchorage at Whampoa, 12 miles from the warehouse of the merchant—C.

never met the requirements of the trade of which it was so long the only emporium; and since the more northern ports have been opened, it has become of less importance.

The following official trade returns are taken from the *North China Herald* of May 26, 1860:

A COMPARATIVE STATEMENT OF THE QUANTITIES OF TEA EXPORTED FROM THE CANTON WATERS TO THE COUNTRIES AND PLACES UNDERMENTIONED DURING THE FIVE YEARS ENDING 31ST DECEMBER 1859.

Countries.	1855.	1856.	1857.	1858.	1859.
	lbs.	lbs.		lbs.	lbs.
Great Britain,	17,608,000	31,819,000	No direct trade. Port blockaded by allied French, and English forces.	26,227,556	28,695,770
United States,	1,629,170	7,518,484		1,400,000	2,336,000
Continent of Europe,	909,400	1,327,100	?	?	1,500,000
Australia,	101,800	2,075,820			3,000,000
Total,	20,243,370	42,740,404		27,627,556	35,531,770

Value of the exports from the port of C., in British vessels, during the year 1859, 11,799,297 dollars; value of the imports into the port of C., in British vessels, during the year 1859, 8,971,451 dollars.

The Middle Kingdom, by Dr S. W. Williams; *The Chinese*, by Sir John Davis; *Meadow's Chinese*; *Twelve Years in China* (Edin., 1860); *Report of the Missionary Hospital in the Western Suburbs of Canton*; *North China Herald*, May 26, 1860.

CANTONMENTS, in the general operations of European armies, are temporary resting-places. Many circumstances, especially the state of the weather and the supply of food, influence a general in determining whether to go into C. or to encamp, in the intervals between active operations; or he may take the former course during an armistice. The quartermaster-general previously examines the district, and determines how many men and horses to place in each village; arrangements are also made for a main-guard, cavalry pickets, alarm-posts, road-barricades, lines of sentries, mounted orderlies, &c., to guard against a sudden surprise from the enemy. In C. the men are not generally under canvas, as described in **CAMP**.

In India, C. are *permanent* places, regular military towns, distinct and at some little distance from the principal cities. If on a large scale, such a cantonment contains barracks for European cavalry, infantry, and artillery; rows of bungalows or houses, each enclosed in a garden, for the officers; rows of huts for the native soldiery; magazines and parade-grounds; public offices and buildings of various kinds; and a bazaar for the accommodation of the native troops. During the revolt in 1857—1858, most of the outbreaks began in the cantonments. It was in the cantonment outside Cawnpore that Nena Sahib commenced his treachery.

CANTONNÉE, in Heraldry. When a cross is placed between four other objects, e.g., scallop shells, it is said to be cantonnée.

CANTON'S PHOSPHORUS, or **PYROPHORUS**, is obtained by heating in a close vessel 3 parts oyster-shells and 1 part sublimed sulphur, when the sulphuret of calcium (CaS) is formed, which takes fire when exposed to or thrown into the air.

CANTOR. See **PRECENTOR**.

CANTU, CESARE, one of the best of modern Italian authors, was born September 5, 1805, at Brescia, in Northern Italy, and was educated at Sondrio, where he was appointed professor of *belles-lettres*. Having been imprisoned for the offence of expressing liberal tendencies in a historical work on Lombardy, C. spent his leisure hours in describing the sorrows of a prisoner in the form of

a historical romance, *Margherita Pusterla* (Florence, 1845). C. has also written several religious hymns and songs, which have become popular; but his great work—the greatest Italian historical work of the present century—is the *Storia Universale* (35 vols., Turin, 1837—1842). It is reckoned by the Italians among their classical works.

CANTU'RO, or **CANTU'**, a town of Northern Italy, 5 miles south-east of Como. It is situated in the midst of a rich district, has a church with an elegant tower, which served as a beacon during the middle ages, and manufactures of iron-wares. Pop. 5500.

CANUN, a Turkish musical instrument, strung with gut-strings; is played on by the fingers, on which are thimbles of tortoise-shell, pointed with pieces of cocoa-nut, forming plectra for striking the strings with. The C. is a favourite instrument with the ladies in seraglios, many of whom produce very pleasant music and harmony on it.

CANUTE, king of England, succeeded to the command of the Danes in England on the death of his father, Swein or Sweyn, and was by them proclaimed king of England. On the death of Ethelred, he shared the sovereignty with Edmund Ironside, who ruled over the south, while C. was monarch over the north of England. The sudden decease or assassination of Edmund made C. sole ruler in 1017, and he continued to reign until his death, in 1035 or 1036. His rule was marked at first by cruelty, but when all who were likely to interfere with his power had been disposed of, he exhibited great mildness and justice, combined with talent and judgment. The Anglo-Saxons, whose complete subjugation he had effected, did not feel their chains: they had experienced no such good government since the time of Alfred and Athelstane. He was easily accessible to all his subjects; and won the hearts of the people by his love for old ballads and songs, and his liberal patronage of minstrels and of gleemen. He also wrote verses himself, and one ballad—all of which, with the exception of one verse, has been lost—long continued popular among the peasantry. In his latter years he became very religious, made a pilgrimage to Rome, and built monastic establishments.

CANVAS, regarded from an artist's point of view, is the principal material upon which oil-paintings are made. Two kinds are prepared for this purpose, of which the best is called *ticking*. Before it is put into the artist's hands, it is usually *primed*, or grounded (see **GROUND**) of a neutral gray, or other tint, as he may direct. Certain sizes of C. being in greater request than others, are kept ready stretched on frames. Those used for portraits are

known by the names of *kit-cat*, which measures 28 or 29 inches by 36; *three-quarters*, 25 by 30 inches; *half-length*, 40 by 50; *Bishop's half-length*, 44 or 45 by 56; *Bishop's whole length*, 58 by 94.

CANVAS, SHIP'S. See SAIL, SAILCLOTH.

CANZONE is the name of one of the oldest and most prized forms of the Italian lyric. The word is borrowed from the Provençals, whose *cançons* or *chansons*, however, were not restricted to any precise form, but were simply verses intended to be sung. The Italian writers first attempted to regulate the wayward and arbitrary character of the Provençal *cançons*; Dante, and subsequently Petrarch, being especially successful. The *Canzone Petrarquesca* or *Toscana* was any considerable lyrical poem, composed of stanzas exactly corresponding to one another in number of lines, measure, and position of rhymes, and which customarily closed with a short stanza. About the end of the 16th c., the Italian writers began to deviate from the strict form of the Petrarchian canzone. Torquato Tasso and Chiabrera are the most notable names in the new movement. The most of the canzones of the latter—called by their author *canzonette*—are written in short lines and stanzas, the position of the rhymes being also completely arbitrary.

CAOUTCHOUC, GUM ELASTIC, or INDIA RUBBER, a substance which, on account of its peculiar properties, is extensively used in the arts, and of which the use is continually and rapidly increasing. It is one of the products of the wonderful chemistry of nature, being found in the milky juices of plants, and most abundantly in the natural orders *Moraceæ*, *Artocarpacææ*, *Euphorbiacææ*, *Apocynacææ*, *Asclepiadacææ*, and *Papayacææ*. It exists in the milky juice of plants growing in temperate climates; but it is only in tropical and subtropical countries that it occurs so abundantly as to be of economical importance. Its uses to the plants in which it is elaborated have not been ascertained; and the conjectures of theorists on this subject are not supported by arguments sufficient to give them much probability. In the milky juice, the C. is diffused in the form of minute globules, and not, strictly speaking, in solution; and when the juice is extracted from the plant, and allowed to stand for a short time, these globules separate from the watery part of it, and form a sort of cream on the top, or, in close vessels, appear throughout it as a flaky coagulum. The first specimens of C. seen in Europe were brought from the East Indies; but its nature and properties were first examined with care by M. de la Condamine, whose attention was attracted to it in South America, and who published a memoir on the subject in 1735. It was at first known by the name of *Elastic Gum*, but it received that of India Rubber from the discovery of its use for rubbing out black-lead pencil marks, for which purpose it began to be imported into Britain in small quantities about the end of last century, being much valued by artists, and sold at a high price. Even before this time, its employment for the manufacture of flexible tubes for the use of surgeons and chemists had been successfully attempted; but the expensive character of the solvents then known for it, prevented its general application to any purpose in the arts. It was not till 1820 that its employment began to extend beyond the rubbing out of pencil marks, although in the meantime the quantity imported had increased so that the price was diminished, and it was common enough in the hands even of school-boys. Its application to the manufacture of water-proof cloth first gave it commercial importance. About the same time, a method was discovered of fabricating articles of various

kinds by casting C. in moulds. Its elasticity and flexibility, its insolubility in water, and its great impenetrability to gases and fluids in general, have now been found to adapt it to a great variety of uses. In one form or another, it is spread in thin layers, to make water-proof cloth; it is drawn into threads to give elasticity to articles of dress; pipes for conveying gas are made of it, pipes for fire-engines, cylinders for the use of printers and calico-printers, cushions for billiard-tables, buffers for railway carriages, rings to be placed around the stoppers of bottles to render them air-tight, a varnish useful for many purposes, and an almost endless variety of other articles. It is also employed in combination with sulphur to form VULCANISED INDIA RUBBER, the uses of which are fully as numerous and as great as those of C. itself.

The C. of commerce is obtained from the East Indies and from South America. That of the East Indies is in great part the produce of *Ficus elastica*, a species of fig (natural order *Moraceæ*), often called the India-rubber tree, which grows in great abundance on rocky declivities in the forests of Sylhet, and is now perhaps one of the most common ornaments of British hothouses. In its native country, it becomes a tree of great size; and its large, oval, thick, glossy leaves make it an object of great beauty. Its fruit is small and uneatable. It grows with very great rapidity. The milky juice is extracted by making incisions through the bark down to the wood, completely round the trunk or branch, and at distances of about a foot from each other. The juice is acrid and tenacious. Fifty ounces of the juice yield fully fifteen ounces of C.—Other species of fig also yield C., particularly the sacred fig or Peepul (*F. religiosa*) of India.—The C. of South America is obtained chiefly from the *Siphonia elastica* (also known as *Hevea C.*), a tree of the natural order *Euphorbiacææ*. This tree is common in the forests of Guiana and Brazil, and has been introduced into the West Indies. It has a trunk 50—60 feet high, scaly, very straight, and branched only at the summit. The milky juice is obtained by incisions through the bark; and the natives of South America make clay-moulds, often pear-shaped or like small bottles, which they smear with the juice, and then dry in smoke, so as to impart to the C. a black colour. Successive layers of juice are applied and dried, until a sufficient thickness is attained. The C. which is obtained from the East Indies is generally in junks and balls, and is light in colour, owing to its being dried by the sun instead of over a fire, as in South America. When the layers are sufficiently united, the clay or other mould is broken, and the *bottle* or *ball* India rubber is fit for immediate use, and is preferred in this state for some purposes; but the layers are often imperfectly united, and impurities are found to have been fraudulently introduced between them, in order to increase the weight.—Among the other trees yielding C. are *Collophora utilis* and *Cameraria latifolia*, in South America; *Vahea gummiifera*, in Madagascar; and *Urceola elastica* and *Willughbeia edulis*, in the East Indies—all belonging to the natural order *Apocynacææ*. *Urceola elastica* yields it in great abundance, and of the finest quality. It grows in the island of Sumatra. An attempt has recently been made to import the juice of the tree and subject it to the drying process in this country, but little has as yet been imported into Britain. The characters of the juice are, that it possesses the consistence of cream, has a yellow colour, is miscible with water, but not with naphtha or other of the solvents of ordinary C., and has the specific gravity of 1012—ordinary C. being 925. The juice contains 31·70 per cent. of caoutchouc. When heated, it

CAOUTCHOUC.

coagulates (as the glaire of egg does), owing to the presence of albumen, and exposed to the air, it dries up, and leaves a film of caoutchouc. In the preparation of pure C., the natural juice is mixed with five or six times its bulk of water, and then either heated or mixed with common salt or hydrochloric acid, when the pure C. separates as a white opaque substance, which becomes transparent when dry. The chemical composition of pure C. is regarded as C_8H_7 ; and it is therefore a compound of carbon and hydrogen alone.

Commercial C. is a tough fibrous substance, possessing elastic properties in the highest degree. Reduced to the temperature of freezing water (32° F.), it hardens, and in greater part, if not entirely, loses its elasticity, but does not become brittle. When heated, as by placing in boiling water, it softens, and becomes very much more elastic than at ordinary temperatures, though it does not in any degree dissolve in the water. If suddenly stretched to seven or eight times its original length, it becomes warm; and if kept in this outstretched form for several weeks, it appears to lose, in great part, its elastic properties, and in this condition is readily cut into those thin threads which are used in the *elastic* put in gloves, bonnets, &c., and the elasticity of which is readily renewed by the application of gentle heat. Commercial C. is insoluble in water and alcohol, is not acted upon by alkalis or acids, except when the latter are concentrated, and heat is applied; but is soluble in ether, chloroform, bisulphuret of carbon, naphtha, crude petroleum, benzol, and the essential oils of turpentine, lavender, and sassafras. Many other essential and fixed oils, when heated with C., cause it to soften, and produce thick glutinous compounds, especially linseed oil, which in the proportion of $1\frac{1}{2}$ lb. of the oil to 4 oz. C. in thin strips or films, yields a solution which, when strained, is of great use in rendering shoes, cloth, &c., water-proof. When heated to 248° F., C. fuses; and at 600° it is volatilised, at the same time undergoing decomposition, and yields a liquid called *Caoutchoucine* or *Caoutchisine*, with the specific gravity 680, and possessing great solvent powers over C. and other substances. Caoutchoucine is necessarily very expensive, and hence its use is limited; but cordage steeped in it and dried acquires great supple and tenacious properties, and cloth saturated with it, and dried by exposure to the air, becomes water-tight.

In the employment of C. as a branch of manufacture, the first operation is the purification of the crude material as it comes from abroad. The crude material is cut into minute shreds, and washed by powerful machinery, immersed in water, which releases the solid impurities, and the pure C. being removed, is placed on iron trays, and dried in a room heated by steam. The material then undergoes a process of kneading under very heavy rollers, which causes the adhesion of the various pieces of C. to each other, and ultimately yields a mass or block of C. in which the condensation is so perfect that all air-holes, and other cells and interstices, disappear. The block of C. is then cut under water by powerful knives or shears into sheets, from which the pieces sold by stationers may be shaped out, or from which C. bands or thread may be obtained. In the manufacture of square threads, mere cutting is had recourse to; and the delicacy of the operation may be understood when it is stated that one pound of C. will yield 32,000 yards of thread. The round thread elastic is prepared from C. which has been treated with about double its weight of bisulphide of carbon, containing about 5 per cent. of alcohol, which yields a soft

material resembling in consistence bread-dough or putty; and this being squeezed through a series of small holes, is obtained in minute round threads, which are first received on an endless piece of velvet, and ultimately on an endless web of common cloth 500 to 600 yards long, during the transit of the threads across which, the solvent or bisulphide of carbon evaporates, and leaves the caoutchouc. When it is wished to weave these threads into cloth, they are wound upon bobbins, taking care to stretch the C. as much as possible, so as to deprive it, for the time being, of its elasticity; and after it has been woven into the cloth, a hot iron is passed over the fabric, and immediately the C. resumes its elasticity.

In the manufacture of water-proof clothing, or *Mackintoshes* (see MACKINTOSH), the C. is treated with one or other of the solvents already mentioned; but that generally employed, from its cheapness, is ordinary spirits of turpentine. An objection to the use of the latter is, that the odour of it never altogether leaves the fabric. The employment of ether as the solvent, which would leave the fabric without offensive odour, has hitherto been prevented by the expense. The solution, which is in the form of a somewhat thick liquid, is laid on the cloth with a wooden spatula, after which the cloth is passed through rollers, which cause the equal distribution of the C.; and the cloth being subsequently carried over rollers, and suspended in a shed to dry, is again and again treated with the solution, till the coating of C. is sufficiently thick. This process yields *single water-proof cloth*; but if two pieces of cloth be similarly treated, and the surfaces with the covering of C. be laid face to face, and the whole passed through heavy rollers, the two coatings of C. adhere together, and the compound fabric constitutes *double water-proof cloth*. The C. which is thus left on cloth is much softer than ordinary C., and is more liable to become glutinous and sticky, when slightly heated. But experiments shew that if the juice, in its natural state, were applied to cloth, the C. left would be of the harder variety. It is found that when the juice, as it exudes from the tree, is mixed with about an ounce of liquor ammonia to the pound of juice, and enclosed in hermetically sealed vessels, it can be exported, and retains its properties for years.

One objection to the use of water-proof clothing is, that while the rain is excluded, the escape of the moisture from the skin is prevented. The disagreeable smell usually adhering to the fabric, is considerably diminished by exposing it to the fumes of certain essences, such as chamomile, verbena root, lavender, whorl-flowers, &c.; or to the gases given off during the heating of sublimed sulphur with ammonia and alcohol, and subsequent airing. The latter process is resorted to in the deodorising of mattresses and air-cushions. Among the more uncommon uses of C., is its employment in the paving of the carriage entrance-court at Windsor Castle, the Admiralty courtyard, and the stables at Woolwich. It has likewise been used for loobbies, staircases, &c.

VULCANISED C.—Important as the applications of pure C. are, its employment in the arts and manufactures was limited, till the introduction of the compound of sulphur and C., known as *Vulcanised C.*, and which was first discovered by Goodyear, in America, who kept his process a secret, till the same material was discovered independently by Hancock, in England, and patented by him. The usual process of vulcanising is to mix the C., previously reduced to a state of fine division by grinding, with sublimed sulphur, and submit the mixture to a heat of 800° F.,

when sulphur and C. unite to form a *sulphide of C.*, which is so far a chemical compound, that neither the sulphur nor the C. can be dissolved out by their ordinary solvents. The vulcanised C. obtained in this way is never entirely homogeneous, owing to the difficulty of thoroughly incorporating the ingredients before heating; and hence, in the preparation of the finer sorts, the C. is first immersed for a few minutes in bisulphide of carbon, containing $\frac{2}{3}$ or 3 per cent. of its weight of chloride of sulphur, and then heated; the sulphur thus becomes more thoroughly incorporated with the C., and the product is a fine variety of *vulcanised caoutchouc*. In this manner, India-rubber overshoes are manufactured, as well as many other articles. A more effectual combination of the sulphur and C. is supposed to be obtained by treating the C. with kermes mineral, or the sulphuret of antimony (SbS_3), and applying a temperature of 250° to 280° F.

The properties of vulcanised C. are—1. It possesses elasticity at all ordinary temperatures, even at the freezing and boiling points of water. 2. It is not dissolved by turpentine, bisulphide of carbon, naphtha, or any other known solvent, and is scarcely affected by acids or alkalies. 3. It resists compression in the highest degree. The uses to which the ordinary form of vulcanised C. is put, are almost endless. Elastic rings or bands for letters, flexible gas-pipes, water-pipes for brewery and other purposes, fire-hose, life-boats, ocean and river electric cables, springs for doors and windows, buffers for railway carriages, open-worked mats, and rugs for doors and rooms, and washers for the largest used engines, as well as hats, braces, boots, shoes, machinery-belts, harness, saddle-girths, and noiseless carriage-wheels, are a few of the many appliances of this substance.

Modifications of vulcanised C. are obtained by mixing silicate of magnesia, pipe-clay, ground porcelain, oxide of lead, and magnesia, with the sulphur and caoutchouc. These substances all give density and compactness to the finished material. The oxide of lead also imparts a smoothness of skin to the manufactured article, which is taken advantage of in the preparation of goloshes or India-rubber shoes. The magnesia imparts hardness, and yields a material so rigid, that it can be manufactured into buttons, combs, picture frames, knife handles, &c., and be made into slates for schools, and veneers for furniture, &c. Another kind of vulcanised C. is obtained by the addition of vegetable or mineral tar, or natural bitumen, to the sulphur and caoutchouc. Coal-tar can be used, and is first boiled for two or three hours till the adherent water and naphtha are driven off, and the whole becomes not unlike soft pitch, and this, when allowed to cool, acquires the consistence of ordinary caoutchouc. If this substance be added in considerable proportion to sulphur and C., and heated to about 300° , a compound is obtained which resembles ordinary vulcanised C. in properties, possessing great elasticity, &c., and which may be similarly employed in the manufacture of numberless articles. A mixture of two parts of the prepared tar to one of C. is used for rendering coarse fabrics water-proof, though, for finer articles, the proportion of tar is diminished. A mixture of tar and C. with fully more than their weight of sulphur, heated for about six hours, at a temperature of 230° , and afterwards to 300° and 320° , yields a material, which can be cast into moulds, or rolled into sheets, and which, when cold, admits of the finest polish, and is so hard and black, that it rivals the expensive substance, jet, in appearance and other properties, and can be similarly cut and fashioned into the most elaborately carved bracelets, shawl-pins, thimbles, hair-combs of all shapes, cork-screws,

pencil-cases, and other ornamental and useful articles. At the present time (1860), these articles are rare; but there is little doubt—from their resemblance to jet in lightness, colour, and high polish, and their elasticity, which prevents them from being broken when allowed to fall—that such things will very shortly command public attention and approbation. Several other modes of employing C. require to be mentioned. Heated with sulphur and finely divided sand, and made into small cakes, it is now sold in shops as an ink-eraser. When one pound of C. in shavings or fragments is mixed with four gallons of coal-tar naphtha, and allowed to stand for ten or twelve days, a liquid of the consistence of cream is obtained, which, treated with twice its weight of shell-lac, and heated, yields a thickish substance, capable of being obtained in slabs when spread out. If this mixture be heated in an iron vessel to 248° F., and brushed over the surface of two pieces of wood, it causes them to adhere so firmly, that, when fractured, the wood gives way at other parts rather than those which are cemented together. The consumption of C. is rapidly increasing from year to year. In 1830, only 446 cwts. of the crude material was imported into Britain; in 1853, the quantity had risen to 19,607 cwts.; and in 1857, it was 22,000 cwts.

Notwithstanding the numerous uses to which C. is already applied, it is believed by every one at all connected with the manufacture, that it is as yet only in its infancy; and that singly, or coupled with gutta-percha, and other substances, new fields of application for it will shortly be opened up.

CAP, in Ship-building, is a strong, thick block of wood fixed near the top of each mast; it has a hole to receive the upper end of the lower mast, and another to receive the lower end of the topmast, with eyebolts to aid in hoisting the topmast. There is also a C. of smaller size at the point of junction between the topmast and the top-gallant-mast. When made of iron, the C. is called a *crance*.

CAP. See PERCUSSION CAP.

CAP OF MAINTENANCE, or **DIGNITY**, is a cap worn by noble and royal personages on certain state occasions. Such a cap was sent by Pope Julius II. to King Henry VIII., for writing his book against Martin Luther.

CAPACITY, LEGAL, is such a condition of individuals, in regard to their natural qualities and actual position under the constitution of the country, as fits them for the application of the laws civil and criminal. Generally speaking, all persons have this legal capacity excepting *aliens*, persons *attainted*, *convicts*, *insane* persons, and to some extent also *infants*, *femmes coverts* or married women, and persons under *duress*; see these heads. See also CONVEYANCE, CONTRACT, PLAINTIFF, PURSUER, DEFENDANT, SUIT.

CAP-A-PIE (Fr. head to foot), in the military language of the middle ages, was applied to a knight or soldier armed at all points, or from head to foot, with armour for defence and weapons for attack.

CAPARISONED, in Heraldry. A war-horse completely furnished for the field is said to be caparisoned.

CAPE, in Geography, the extremity of a portion of land projecting into the sea beyond the general line of the shore. On a low sandy coast, a cape generally forms an obtuse angle, being merely a change in the trending of the land. On rocky shores, capes usually form acute angles, and are here sometimes called points or promontories.

CAPE BRETON—CAPE OF GOOD HOPE.

CAPE BRETON, a rocky island of irregular form in British North America, stretching in N. lat. between 45° and 47°, and in W. long. between 60° and 61° 30'. It is separated from the peninsula of Nova Scotia by Chebucto or Chedabucto Bay and the Gut of Canso, contains 3120 square miles, and has a population of 35,000. Its principal exports are pine, oak, birch, maple, fish, and coal. Though the island produces maize and other grains, yet it depends for its bread-stuffs chiefly on the United States. C. B., originally a French possession, was taken by the English in 1745; but being subsequently restored to France, it was again captured in 1758, and ceded in 1763. After having been for a time a distinct colony, it now forms part of the province of Nova Scotia. The towns are Sydney, Arichat, and Port Hood, the once famous Louisbourg, stripped of its fortifications, having become merely a village.

CAPE COAST CASTLE, the chief settlement of Great Britain in North or Upper Guinea, lat. 5° 5' N., and long. 1° 13' W. The place, as its name implies, is defended by a fort, or rather by three forts. It has a population of 10,000. During 1853, the external trade of the entire Gold Coast, C. C. C. being the capital, was as follows: imports, £118,270; exports, £124,394: total, £242,664. Under the latter head, the principal articles were palm-oil, gold-dust, tortoise-shell, and maize.

CAPE COD, properly a narrow peninsula of Massachusetts, which, with a length of 65 miles, forms the south-east boundary of the great bay of that state. The northern extremity, marked by a revolving light 155 feet high above the level of the sea, is in lat. 42° 3' 40" N., and long. 70° 14' 48" W.

CAPE HATTERAS, a dangerously low point of North Carolina, United States, in lat. 35° 14' N., and long. 75° 30' W. It forms the eastern extremity of the insular banks of the same name, projecting virtually into the Florida Stream, and marking the spot where the coast-line abruptly turns from the direction of north-east to that of due north.

CAPE HA'YTIËN (formerly called *Cape François* and *Cape Henri*), a seaport town, of the island of Hayti, on its north coast, in lat. 19° 40' N., long. 72° 54' W. It is pleasantly situated on a small bay, partly encircled by hills, has wide and well-paved streets, and some handsome squares. A great portion of it, however, is in ruins, the effects of the revolutionary wars at the end of last century. Safe anchorage is found within the harbour, which, however, is rather difficult of access. C. H. carries on a considerable trade with the United States. Population stated at from 12,000 to 16,000.

CAPE HORN, or **HOORN**, the most southerly point of America, terminating an island of its own name, in the archipelago of Tierra del Fuego. It is in lat. 55° 58' 40" S., and long. 67° 16' W., having a perennially antarctic climate, and being in itself merely a detached link, bare and rugged, of the chain of the Andes. It was discovered by Schouten, a native of Hoorn in Holland, about 90 years later than the Strait of Magellan, and since then the course of navigation has been round the cape instead of through the strait.

CAPE LA HAGUE, a promontory of France, forming the north-west extremity of the peninsula of Cotentin, in the department of Manche. It juts out into the English Channel, opposite the island of Alderney, and about 16 miles north-north-west of Cherbourg, and 50 miles south of St Alban's Head, in Dorsetshire.

CAPE LA HOGUE, often confounded with Cape la Hague, is situated on the east side of the same

peninsula. Here the united English and Dutch fleets defeated the French in 1692.

CAPE OF GOOD HOPE, popularly regarded as the most southerly promontory of Africa, though it is half a degree to the north of Cape Agulhas. The latter is merely a projection on a coast-line, which diverges inconsiderably from a parallel; but the former is really the turning-point from south to east on the voyage from Europe to India. This celebrated promontory is in lat. 34° 22' S., and long. 18° 29' E., being the termination of Table Mountain, which, as it recedes towards the bay of its own name, rises from the height of 1000 feet above the sea to that of 3582. The Cape (for so it is called by way of eminence) was discovered and doubled by Diaz, a Portuguese navigator, as early as 1486—six years before Columbus, in aiming at the same goal by a different route, led the way to America. But it was only in 1497 that Vasco de Gama realised the value of Diaz's discovery, by rounding it on his adventurous voyage from Lisbon to Calicut. The result was not merely to open a new channel for the traffic of the East, but it was also to transfer trading superiority from the republics of Italy to the states of Western Europe.

CAPE OF GOOD HOPE, a colony of the United Kingdom, which takes its name from the promontory above mentioned. The Portuguese, possessing in Brazil a more central house of call in the direction of India, were comparatively independent of Table Bay as a halting-place. In like manner the Dutch, who had supplanted the original discoverers at once in India and in Brazil, must have felt something of the same indifference. It was, therefore, only in 1652, when they were on the very point of being expelled from South America, that they founded Cape Town (q. v.), as the first settlement of Europeans in South Africa. The Dutch contemplated at first but little more than what they found among the Hottentots, the tending of flocks and herds, and this would be all the more likely to provoke and aggravate animosities and collisions between the intruding strangers and the natives. Certainly the civilisation, such as it was, involved at least an average amount of injustice and inhumanity, until, with the aid of illusory purchase and violent occupation, it had, before the close of the 18th c., spread, with an indefinite boundary to the north, as far to the east as the Great Fish River, comprising within its extreme range a population of about 20,000 whites and an area equal to that of the British Isles. In 1795, this dependency of Holland, threatened with the revolutionary tide which had already overwhelmed Holland itself, was seized by a British force on behalf of the Prince of Orange. Restored, in 1802, to the Dutch under the treaty of Amiens, the Cape Colony was once more captured, and that finally and permanently, by the English in 1806. The new masters of the country, inheriting, in this respect, from their predecessors a ready-made feud, fronted on the east the Kafirs, a warlike and proud race, which, with the exception of pastoral pursuits, had nothing in common with the Hottentots. The almost inevitable results followed—a normal state of insecurity and strife on the border, diversified by at least three actual wars. After twice advancing to the Kei, the colony, as a whole, has receded to the Keiskamma, retaining, however, the port of East London; while the rest of the intermediate region has been placed, as British Kaffraria, under the military authorities of the empire. From the source of the Keiskamma, the eastern limit runs onward, as against Kaffraria

CAPE OF GOOD HOPE.

Proper, to the Orange, which thence down to the Atlantic forms the northern line—the western and southern confines being washed by the two adjacent oceans.

But, during brief periods, the country extended further, embracing, from 1842 to 1847, Port Natal (see NATAL) beyond Kaffraria, and, from 1848 to 1854, what is now the Free State (q. v.) between the Orange and its main affluent the Vaal. Across the last-mentioned stream, too, discontented or adventurous settlers, almost exclusively of Dutch origin, have planted, under the name of the Trans-Vaal Territory (q. v.), an apparently prosperous republic.

Without reckoning the outlying harbour in British Kaffraria, the colony stretches in S. lat. from 28° 10' to 34° 51', and in E. long. from 16° 20' to 27° 30'—the longest meridian, that of Cape Agulhas, being about 450 miles, and the longest parallel, pretty nearly that of the mouth of the Keiskamma, measuring about 100 more. Independently, therefore, of its offshoots, it cannot contain less than 200,000 square miles. For purposes, however, of administration, as distinguished from legislation, this immense area is divided into the Western and Eastern Provinces—the point of separation on the coast being about midway between the Cape itself and the Keiskamma. Each of the two contains 11 *divisions*. These 22, again, are broken up, according to size, into more or fewer *field cornetries*; while some of them, on the ground of populousness or extent, constitute two, or perhaps three, magisterial or judicial *districts*. Each province, moreover, is a diocese of the Church of England—Cape Town and Graham's Town, the respective capitals, being the Episcopal seats. A considerable portion of the community belong to the Dutch Presbyterian Church.

The two provinces have, to a certain extent, distinct administrations—the western being under the governor-in-chief, and the eastern under a lieutenant-governor. The two together are under one and the same legislature—a council of 15 nominated members, and an assembly of 46 elected representatives.

As vaguely numbered, the population is said to be about 280,000—the whites being perhaps a little more than a third of the whole. As the country from its earliest settlement in 1652 to 1795, and again from the peace of Amiens in 1802 to 1806, belonged to Holland, the white inhabitants are in a considerable proportion of Dutch descent. To judge roughly from the names of members of assembly, the two races are probably almost equal in numbers. Two causes have steadily been leading to this result. While the English element has, of course, been positively recruited by immigration from Europe, it has also been relatively strengthened by that overland emigration, which, almost exclusively under Dutch impulses, has poured swarm after swarm into the Free State, the Trans-Vaal Territory and the colony of Natal.

Hydrographically, the country is, as a whole, decidedly superior to most parts of Africa. The sea-board presents several comparatively safe and commodious harbours. Of these, however, two—Table Bay in the Western Province, and Algoa Bay in the Eastern—absorb nearly the whole—fully 97 per cent.—of the foreign trade. The others are—St Francis Bay, in the latter division; and in the former, Plettenberg Bay, Knysna Inlet, Mossel Bay, St Sebastian's Bay, and False Bay, on the Indian Ocean, with Saldanha Bay and St Helena Bay on the Atlantic. All these, as well as East London in British Kaffraria, are used chiefly in the coasting traffic. Even for this purpose, most of them—perhaps all of them but Saldanha Bay, and a part of False Bay—are safe against only one of the

prevailing winds, the north-west and the south-east. Great efforts, however, are making to improve the harbours generally; in Table Bay, a breakwater has been commenced. Hardly any of the ports command navigable communications with the interior.

The dividing ridge runs parallel with the coast, at a distance of about 100 miles. The opposite faces of this water-shed are as unlike to each other, in kind if not in degree, as those of the Andes. While the inner slope pours out its tribute exclusively towards the Orange, with its course of 1500 miles, the outer declivity sends down numberless streams, remarkable chiefly for their rapidity, at once to the sea. Of these last, moreover, the characteristics become more and more conspicuous in the north-east, for in that direction the dividing ridge rises gradually from about 3000 feet, till, amid the sources of the Orange, it attains fully thrice that height. The streams of the outer declivity, too, reach either ocean, not by a regular descent, but by successive leaps, for all round, to the west and south of the dividing ridge, there run parallel with it two subordinate ranges, each supporting its own terrace. On these plateaus, more particularly in the northern half of the Western Province, there is found many an arid and irremediable waste, styled *karoo* in the indigenous tongue. In other localities, likewise, throughout the colony, water appears to be scarce at certain seasons. Much may be done, and something has been done, to remedy the evil, both by digging and by irrigation. Such undertakings seem to be invaluable; even the parched mud of the *karoo*s, when borne down the Oliphant by inundations, is said to rival in fertility the alluvial sediment of the Nile.

The three chains of mountains present serious impediments to the opening of roads, being passable only through natural breaks or *kloofs*. Still many highways, generally good ones, have been laid out—depending partly on tolls and partly on assessments. Some of them penetrate from the south coast to the Free State; while, in the direction of west and east, the principal thoroughfare carries the mail in 12 days between the metropolis and Port Natal—soon to be connected also by the telegraphic wires.

The prevalent winds—the south-east in summer, and the north-west in winter—mitigate each the rigour, whether heat or cold, of its own season—and in spite of occasionally sudden and great changes, render the temperature, as a whole, perhaps the most salubrious, as well as the most delightful, in the world. The water-shed, again, with its ascending levels, crowds, as it were, into one every region in Europe from Sicily to Scotland. Every locality, in a measure, has its own staple production. If the Western Province yields nearly all the wine that is exported, the Eastern greatly preponderates in wool; while the southern shore, more especially at Plettenberg Bay and Knysna Inlet, excels in the growth of timber.

Perhaps the best summary view of the resources and capabilities of the country may be gathered from the list of exported articles. These, when arranged in order of value, stand thus: wool, wine, copper-ore, hides, goat-skins, sheep-skins, horses, flour, aloes, fish, fruits, oats, bran, beans and peas, wheat, barley, and maize. The whole of the exported articles exhibit a great increase in value during the last three years of authentic returns:

1855.	1856.	1857.
£970,839	£1,136,136	£1,938,406

Within the same period, the imported articles were doubled in value—

1855.	1856.	1857.
£1,175,469	£1,404,498	£2,637,192

CAPE RIVER—CAPEFIGUE.

The colonial revenue had in the same time augmented from £306,027 to £491,525. Finally, in the year last mentioned, the shipping was officially reported as follows :

	Vessels.	Tons.
Entered,	1,132	382,112
Cleared,	1,085	362,890
Total,	2,217	745,002

CAPE RIVER, properly *Vaunks*, taking its popular name from the proximity of its mouth to Cape Gracias a Dios, on the east reach of the Mosquito shore in Central America. After a generally north-east course of nearly 300 miles, it enters the Caribbean Sea, about lat. 14° 59' N., and long. 83° 11' W., being navigable for a considerable distance upwards.

CAPE ST VINCENT, a headland forming the south-west extremity of Portugal, in lat. 37° 2' N., long. 9° W., is celebrated on account of two naval battles in which British ships were engaged, fought off it, one in 1693, the other in 1797. In the former, Admiral Rooke, who with some 20 English and Dutch men-of-war was convoying a fleet of some 400 merchantmen, was attacked off this point by the French Admiral De Tourville, and after a running fight lost several ships, and 80 merchantmen. In February 1797, Sir John Jervis, with a fleet of 15 sail, gave battle to a Spanish fleet of 27 sail of the line, and defeated them, capturing four ships and driving the rest into Cadiz Bay, where they were blockaded.

CAPE TOWN, the capital of Cape Colony, takes its name, like the colony, from the grand turning-point between the Atlantic and Indian Oceans. It faces the south-west, or best sheltered side, of Table Bay, having at its back Table Mountain. Of the observatory, the lat. and long. respectively are 33° 56' S., and 18° 28' 7" E. The mean temperature is 58·3° F. for the winter, 76·6° for the summer, and 67·3° for the whole year. In 1849, the population was 23,749; and now, in 1860, it cannot be much less than 30,000. The city, originally Dutch, abounds in straight lines and right angles, the principal streets being threaded by canals. The houses generally are flat-roofed, with terraces in front. The castle, a regular fortification, with bastions and outworks, occupies the extreme east. Of the other public establishments, the most important are the exchange, the college, a literary institution, a public library, a botanic garden, a gas factory, several banks, various insurance companies, and 15 places of worship. There are two immigration agencies—a private society for introducing 'juvenile servants' from Holland, and a public board, supported by an annual grant of £50,000, for giving free passages to certain classes of settlers from the United Kingdom. C. T. has a municipal body of 12 commissioners and 48 ward-masters, and it returns 4 representatives to the colonial assembly, other constituencies electing only 2 each; and further, it has, since 1847, been the see of a bishop of the Church of England. In 1857, it had 44 registered vessels, ranging from 873 tons to 13—surpassing, in this respect, all the other ports of the colony at least sevenfold. It is the neighbourhood of C. T. that produces all the genuine Constantia wine. That wine, however, bears a very small proportion to the other wines. The official returns of exports for 1855 stood as follows: Constantia wine, 2983 gallons—£891; other wines, 613,766 gallons—£71,081; total, 616,749 gallons—£71,972. C. T. forms a convenient place of rest and refreshment for vessels on the route between Europe

and India. A telegraphic line from C. T. to the eastern frontier is in progress.

CAPE VERD, the most westerly headland in Africa, jutting out into the Atlantic Ocean, between the rivers Gambia and Senegal, in lat. 14° 43' N., long. 17° 34' W. It was discovered by the Portuguese about 1445, and is said to have derived its name from a group of gigantic baobab-trees which adorns its summit.

CAPE VERD ISLANDS (*Ilhas Verdes*), a group of islands belonging to Portugal, lying in lat. 14° 45'—17° 19' N., and long. 22° 45'—25° 25' W., and distant about 320 miles west of the cape from which they take their name. The principal islands are ten—viz., Santiago, the largest and most important, Fogo, Brava, Maio, Boavista, San Nicoláo, San Antonio, San Vicente, San Luzia, and Sal. There are besides four islets, barren and uninhabited. The total area is about 1700 square miles, with a population (1857) of 85,393. The islands are all very mountainous, and owe their origin to the action of submarine volcanoes. The highest elevation is reached in a volcanic peak, 9157 feet above the sea, on the island of Fogo, and which is still active. The climate is unhealthy during the rainy season. Though water is deficient, vegetation is luxuriant, yielding African and Southern European products. Sugar, cotton, coffee, tobacco, and indigo are grown, and the trade in archil, monopolised by government, has in some seasons yielded as much as £24,000. Several of the European domestic animals thrive well. Turtles are abundant in the surrounding seas, and whales also are fished by British and American vessels. Amber is found on the coasts, and great quantities of salt formed by solar evaporation is obtained from the lagunes on the shores, especially on the island of Sal. The inhabitants, who are mostly negroes, indolent but harmless, speak a corrupted form of Portuguese, called *Lingua Creoula*. The revenue for 1857—1858 was estimated at about £24,000, and the expenditure for the same year at £31,000. The islands are under a governor-general, exercising both civil and military authority. The chief ports are Porto Praya, on the island of Santiago, and Porto Grande, the best harbour in the whole group, on the island of San Vicente. The islands were discovered about the middle of the 15th c. by the Portuguese, who shortly after colonised them.

CAPE WRATH, a pyramidal promontory of unrivalled wildness and grandeur, forming the north-west extremity of Scotland and of Sutherland, and running out into the Atlantic, in lat. 58° 38' N., and long. 4° 58' 5" W. It consists of gneiss, with beds of dark hornblende rock, is intersected by complex granite veins, and presents deep fissures and tall pinnacles. From it a reef of rocks, perforated with arches and caverns, juts out into the sea. Off the cape is Stag Rock, a pillar 200 feet high. C. W. is 600 feet high, and there is a light-house near it, 400 feet above the sea, and seen 25 miles off. From the Cape can be seen N. Rona, 50 miles off; Hoy Head, Orkney; the Butt of Lewis; and a grand panorama of mountains in Sutherland.

CAPEFIGUE, BAPTISTE HONORÉ RAYMOND, a French publicist and historian, was born, 1802, at Marseille. He studied law at Aix, and in 1821 proceeded to Paris, for the purpose of completing his juridical course, but soon betook himself to journalism and authorship. He held a post in the foreign office until 1848. This, however, did not interfere with his amazing activity. Besides contributing extensively to many of the Parisian journals, he has 'manufactured' not less than a hundred volumes of history—not, indeed, intrinsically

valuable, but indicating wonderful facility in the use of the pen. His writings relate chiefly to events and characters in French history. The best is the *Histoire de la Restauration* (3d edit. 1842).

CAPELIN (*Mallotus Grœnlandicus*), a small fish of the family of *Salmonida*, extremely abundant on the coasts of Newfoundland, and much used as bait in the cod-fishery. It is also, in a dried state, an article of commerce, and is imported, although not very largely, into Britain, where it sometimes appears on the breakfast or supper table. Its flavour, which is very agreeable, suggests to most persons the idea of its belonging to the herring rather than the salmon family. It is nearly allied to the smelt, but the teeth are smaller and more numerous. It is the only known species of its genus.—Shoals of capelins arrive periodically on the coast of Newfoundland, the vast numbers changing the very colour of the sea.

CAPELLA, a bright star of the first magnitude, on the left shoulder of Auriga. C. is also called Capra or the *She-goat*, a name also sometimes given to Capricorn.—The poets fable C. to be Amalthea's goat, which suckled Jupiter in his infancy.

CAPELLA. See **A CAPELLA**.

CAPELLA, MARTIANUS MINEUS FELIX, a learned author belonging to the second half of the 5th c., was born in Africa, but where is not definitely ascertained. Of his life nothing whatever is known. The work which has preserved his name to posterity is the *Satiricon*, a kind of encyclopædia, highly esteemed during the middle ages as a work of reference. It is written in a medley of prose and verse, and is full of curious learning, but possesses no literary value; the style has all the bombastic pomp of the African school of later Latinists. It consists of nine books. The first two consist of an allegory, *The Nuptials of Philology and Mercury*, while the remaining seven are devoted to the 'liberal arts,' grammar, dialectics, rhetoric, geometry, arithmetic, astronomy, and music. The first edition of the *Satiricon* appeared in 1499, under the care of Franciscus Bodianus; the best in 1836, under the care of U. F. Kopp.

The book on astronomy is remarkable as containing a hint of the true theory of the solar system. Mercury and Venus are there declared to move round the *sun*, and not round the *earth*; and their relation to these bodies is properly explained. Now as Copernicus knew C., and quotes from him, it is not unlikely that he derived the first idea of his doctrine from this writer.

CAPERCAILLIE, **CAPERCAILLIE**, **WOOD-GROUSE**, or **COCK OF THE WOODS** (*Tetrao Urogallus*), the largest of the gallinaceous birds of Europe. It is a species of Grouse (q. v.), almost equal in size to the turkey; the male, which is the largest, sometimes weighing fifteen pounds or more. In figure and appearance, it much resembles the black-cock, but the tail of the male C. is rounded, and not forked, as in that species; and the male C. has the feathers of the head elongated. The general colour of the adult male is brownish black, minutely freckled with grayish white, and with lighter brown; the quill-feathers dark brown; the tail-feathers nearly black, some of the longer tail-coverts on the sides of the tail tipped with white; the chest is of a shining dark green; there is a small scarlet patch of naked skin above the eye, and the bill is whitish. The general colour of the female and of young males is dark brown, freckled with yellowish brown; the front of the neck and the chest are yellowish chestnut; and the feathers of the under parts are generally edged with white. The C. has the feet feathered to the toes, but the toes

are naked. It is an inhabitant of pine-woods; feeds on berries, seeds, worms, insects, &c., and on the young shoots of the pine, greatly preferring the Scotch fir to the spruce; occasionally also eating, at least in winter, the buds of the birch and other



Capercaillie.

trees. The female makes her nest on the ground, and lays from six to twelve eggs, of a pale reddish or yellowish brown, spotted with other shades of brown, and more than two inches long. Like the black-cock, the C. is polygamous.—The geographical distribution of the C. is very extensive: it is found on the pine-covered mountains of all parts of Europe, from Spain and Italy almost to the North Cape, and is abundant in the northern parts of Asia. It was at one time found both in Scotland and Ireland, but was completely extirpated about the end of the 18th or beginning of the 19th century. Through the exertions, however, of the Earl of Fife and other proprietors of great Highland estates, but particularly of the Marquis of Breadalbane, it has again been restored to the forests of the Highlands of Scotland. The C. is very capable of domestication, and breeds readily, if allowed the range of a space containing a few pine-trees. It is much esteemed for the table. The market of Stockholm is well supplied with it in winter; and since the establishment of steam communication, it has been regularly brought from Scandinavia to London.

CAPERNAÛM, meaning 'the field of repentance,' or 'city of comfort,' was in the time of our Saviour a favourite and exalted city, and one of the three which he upbraided 'because they repented not.' It was situated on the north-western coast of the Sea of Galilee, or Lake of Gennesareth. It is now a heap of ruins, extending more than a mile along the shore and back towards the mountains, so overgrown with grass and bushes, that it is difficult to move among them. C. is called by the natives of Syria Tell-hn.

CAPERS are the pickled flower-buds of the caper-bush (*Capparis spinosa*). They have an agreeable pungency of taste, with a slight bitterness, and have long been in very general use as a condiment and ingredient of sauces, along with boiled mutton and other kinds of food. They possess medicinal properties, being antiscorbutic, stimulant, and laxative. They are of a grayish green colour, to improve which, however, copper is sometimes used, as in the case of gherkins and other pickles, rendering them poisonous. This can be detected by thrusting a polished iron rod into the vessel which contains the C.; the surface of the rod soon becoming coated with copper, if it is present.—The caper-bush is a native of the south of

Europe, and other countries near the Mediterranean. It is extensively cultivated in some parts of the south of France and in Italy, but most of all in Sicily. It succeeds in the open air even at Paris, but in Britain requires the aid of artificial heat. It is a trailing, rambling shrub, loving dry places, and often growing on rocks or walls, adding a fresh charm of beauty to many an ancient ruin. It begins to flower early in summer, and continues flowering till winter. The buds are gathered every morning, and are immediately put into vinegar and salt: at the end of the season, they are sorted according to their size and colour, the greenest and least expanded being the best, and are again put into vinegar, the finest being sent to the market in



Caper (*Capparis spinosa*).

bottles, the coarser in small barrels. The fruit, which is a small berry, is also pickled in the south of Italy. The flower-buds of the caper of Mount Sinai (*Capparis Sinatica*) are pickled like those of the common species; the seeds are also pickled, and are called by a name signifying Mountain Pepper. The fruit of *Capparis aphylla* is made into a pickle in India. Species of *Capparis* are numerous in India, the warm parts of America, &c. See CAPARIDÆ.—Various substitutes for C. are sometimes used, as the flower-buds of the Marsh Marigold (*Caltha palustris*), those of the Indian Cress (*Tropæolum majus*), and those of the Bean Caper (*Zygophyllum Fabago*).

CAPETIAN DYNASTY, the third Frankish dynasty, founded about the close of the 10th c., when Hugo Capet ascended the throne. The surname **CAPER** has been derived from *cappetus*, 'a monk's hood,' because, though duke of France, Hugo was also abbot of St Martin de Tours. On the death of the last Carolingian monarch (Louis V., surnamed *Le Fainéant*—i. e., the Slothful), Hugo, the most powerful of French vassals, seized the throne, and by moderation and prudent concessions made to the authorities of the church, as well as to his brother-nobles, who had made themselves independent, contrived to retain the power he had seized. He was crowned at Noyon, July 3, 987. In order to establish his dynasty, Hugo caused his eldest son Robert to be crowned as co-regent, 988. Capet first made Paris the capital of France. He died in 996; when his son Robert, a well-disposed but feeble ruler, ascended the throne, who died 1031, beloved by his domestics, but despised by his neighbours and vassals, forgotten by his people, and permitting all power to vanish from his hands. It was during his long lethargic reign that the towns and cities of France began to form themselves into corporations, to act in their own name, to contract obligations, and lay the foundations of middle-class freedom. In many other ways, also, the happy dissolution of royal power sowed the seeds of national prosperity. Robert's sons were Henry, who succeeded him, and Robert, ancestor of the older House of Burgundy.

Henry left two sons—Philip I., who ascended the throne, and Hugo, who distinguished himself in the first crusade (1096), and died 1102. Philippe,

under the regency of Baldwin, Count of Flanders, came to the throne when only eight years old, and first really began to reign after the death of the regent (1066). He took hardly any part in the great movements and events of his times, but supported Robert, son of William the Conqueror, in his rebellion against his father. Consequently, William commenced an expedition against Paris, and would probably have dethroned Philippe, but died in 1089. By his dissolute course of life, Philippe fell under a sentence of excommunication issued by Pope Gregory VII. in 1094, and, after doing penance, died in 1108.

His successor, Louis VI., surnamed *Le Gros*, had, during Philippe's lifetime, been active in the support of the crown, and now extended the royal power which had been almost entirely confined within the duchy of Paris. By bold and vigorous measures he brought everywhere his vassals into real subjection to his authority, liberated the towns from baronial oppression, partly abolished feudal bondage, and extended considerably the jurisdiction of the crown. His life was an almost incessant contest with the small and turbulent vassals who had rioted in the license afforded them by the weakness of his predecessors. He died 1137, leaving a numerous family.

As his eldest son and co-regent, Philippe, had died during the reign of Louis, his second son, Louis VII., *le Jeune*, now came to the throne, and by his marriage with Eleanor of Guienne, heiress of the Duke of Aquitaine, gained a considerable accession to the power of the crown. He engaged in the second crusade, and led 100,000 men to the East; but was unsuccessful, and returned to France after an absence of two years. In 1152 he divorced his unfaithful wife Eleanor, who subsequently married Henry Plantagenet, afterwards Henry II. of England. This marriage made Henry far more powerful than the king of France, and Louis would probably have lost his crown had not the disturbances in England—the quarrels with Becket and with his own sons—proved sufficient to occupy Henry's attention. Louis le Jeune died 1180.

Philippe Auguste (q. v.), his son by a third marriage, ascended the throne ten months before his father's death, and proved himself the most able ruler of the Capetian dynasty. Against the wishes of his family, he married Isabelle of Hainault, great-granddaughter of the last of the Carolingians, and thus finally united the two houses. His successor, Louis VIII., who died 1226, was said to have been poisoned by the Count of Champagne, paramour of the queen, Blanca of Castile. Louis VIII. was followed by his son Louis IX. (SAINT LOUIS, q. v.), who died at Tunis, 1270. Of the eleven children of St Louis, the eldest, Louis, died aged 16 years, while the youngest, Robert, became the founder of the Bourbon dynasty (see **BOURBON**). The second son, Philippe III., *le Hardi*, succeeded his father, and, by the decease of two brothers and two uncles, acquired possession of Poitou, Auvergne, and Toulouse. His son (Philippe IV., *le Bel*) acquired by marriage Champagne with Navarre. These acquisitions, and his attempt to secure for his uncle, Charles of Anjou, the throne of Naples, involved Philippe III. in contentions with Italy and Spain. He subjugated Navarre, 1276, and died of the plague in 1285. Philippe IV., *le Bel*, succeeded to the throne when seventeen years old. He soon gave signs of a despotic character, plundered the estates of the church, defied papal authority, persecuted the order of Templars (q. v.), and removed the residence of the popes to Avignon. The atrocious act of burning the grand-master, with sixty knights, of the order of Templars, after they had recalled all

the confessions drawn from them by torture, has left an ineffaceable blot on the name of Philippe le Bel. He died 1314, and left three sons and a daughter.

The eldest son, Louis X., *le Hutin*, who ascended the throne, displayed remarkable weakness of character, and died 1316. He was succeeded by Philippe V., *le Long*, second son of Philippe le Bel, who died without issue. By his death (1322) the crown came to Charles IV., *le Bel*, third son of Philippe le Bel, and the last of the direct line of the Capetian kings. He died 1328, leaving by his third marriage a daughter, named Blanche, who married Philippe, Duke of Orleans, and died (1392) leaving no issue. Isabelle (daughter of Philippe le Bel) married Edward II. of England, and was mother of Edward III., who consequently took the title of king of France, which was retained by the kings of England until the reign of George III.; but Philippe of Valois, cousin of the last Capetian king, and grandson of Philippe III., *le Hardi*, claimed the crown of France by virtue of the Salic law, and so founded the dynasty of Valois (q. v.).

CAPIAS, in the practice of the English common law, is a writ directed against the person, and so called from the commencement of the process in the old Latin form. It has various applications, the principal of which are the following :

CAPIAS AD RESPONDENDUM is a writ which a plaintiff is at liberty to sue out upon affidavit against a defendant who, there is reason to believe, is about to quit England, and against whom there is a cause of action to the amount of £20 or upwards, whether as matter of contract or of damage. The writ directs the sheriff to arrest the defendant, who remains in custody on such arrest until he shall have either given a bail-bond with reasonable sureties, or made a deposit of the plaintiff's demand, together with £10 for costs.

CAPIAS AD SATISFACIENDUM, or **CA. SA.** This is one of the writs by which a plaintiff can put a judgment recovered by him in execution. The object of it is to imprison the debtor till satisfaction be made of the debt or damages and costs. See on the subject of **Capias** generally, **APPREHEND, ARREST, ATTACHMENT, EXECUTION, and BAIL.**

CAPILLAIRE, a medicinal syrup, used as a pectoral in chronic catarrhs, is prepared by adding sugar and orange-flower water to an infusion of the fern called **MAIDENHAIR** (q. v.), or by pouring boiling syrup on the fern.

CAPILLARIES. The tubes which convey the blood from the left side of the heart to the various parts of the body are termed arteries, while those which return it to the right side of the heart, after it has discharged its various functions in the body, are known as veins. The name of capillary (from *capilla*, a hair) is given to the minute vessels which form the connection between the

terminal branches of the arteries and the commencements of the trunks of the veins. These little vessels are of various sizes, some admitting only one blood-corpuscle at once, while others are large enough to allow of the simultaneous passage of two, three, or more corpuscles. In the muscular tissue their average diameter is 0.003 of a line; they are smallest in the brain, and largest in bone. Their arrangement varies in different parts. In the accompanying figure, which represents their distribution in muscular tissue, they run for the most part parallel to one another; in other cases (as around fat-cells) they have a spherical arrangement, and in the skin and in parts of the intestines they form loops; and many other forms of distribution might be mentioned. These various arrangements have been discovered by the microscopic examination of tissues that have been successfully injected with coloured fluids.

The circulation of the blood through the C. may be readily seen in the web between the toes of the hind-foot of the frog, in the tongue of that animal, in the tail or gills of the tadpole, in the wing of the bat, &c.

The principal uses of the capillary system of vessels will be noticed in the articles on **DIGESTION, NUTRITION, RESPIRATION, and SECRETION.**

CAPILLARY ACTION. When a clean glass tube with a fine bore, open at both ends, is plunged into a liquid capable of wetting it, such as water, the liquid is found (1) to rise in the tube above the level of its surface in the vessel containing it; (2) to rise the higher in the tube above that level the finer its bore is; (3) to stand above the general level in the tube where it approaches the sides (as in fig. 1, which is drawn on a greatly exaggerated scale), so that its upper surface in the tube is curved and concave. When a similar tube is plunged into a liquid incapable of wetting it, such as mercury, phenomena of a precisely opposite nature are presented. The liquid stands in the tube below the level of its surface in the vessel; and where it

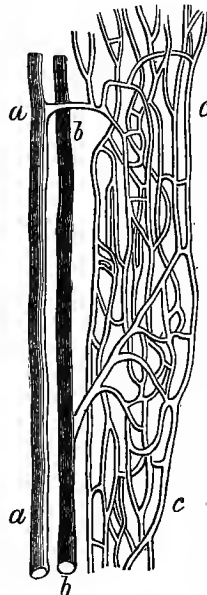

Capillaries :

a, the artery; b, the vein; c, the intervening capillaries.

lary (from *capilla*, a hair) is given to the minute vessels which form the connection between the



Fig. 1.

Fig. 2.

approaches the sides of the tube, it stands below its general level in the tube, so that its upper surface is curved and convex as in fig. 2, the convexity and depression in the tube increasing with the fineness of its bore. While such is the case with the two classes of liquids described, there are others on which fine tubes have no action, so that they stand in such tubes at the same level as in the vessel, and with plane upper surfaces. These are the leading phenomena to be explained by what is called **C. A.**, the tubes with fine hair-like bores being called capillary tubes, from *Laticapilla*, a hair. The phenomena, however, though connected by name with such tubes, are not dependent on them, but may be produced without their intervention by any contrivance which gives room for the so-called capillary action. For instance, if two plates of glass with parallel faces be placed

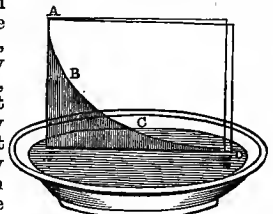

Fig. 3.

together with two of their edges in contact, and the two opposite be separated a very little by a fine wedge; and then if they be put standing with their common edge vertical in a trough (fig. 3), containing a little coloured fluid capable of wetting the glass, the fluid will rise between the plates, the height attained at any point being inversely as the distance between the plates at that point, so that its upper surface will be a curve of the kind known as the hyperbola—being highest near the common edge, and lowest near the edges separated by the wedge. If the same apparatus be placed in a trough containing mercury, the mercury will be depressed between the plates till its upper surface forms a hyperbola convex to the zenith.

To understand the peculiar action producing these phenomena, it must be kept in view that the surface of a fluid at rest under gravity is a horizontal plane (see HYDROSTATICS), and that this plane is maintained by gravity and the mutual attractions of the particles of the fluid mass. Suppose now a fluid at rest in a vessel to have a foreign body, such as a capillary tube, suddenly plunged into it, and separating, as by walls, a portion of the fluid from the rest.

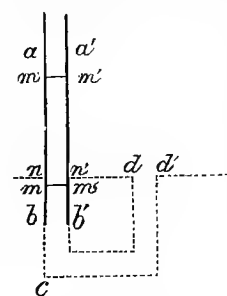

Fig. 4.

By cohesion (q. v.), the fluid particles inside the tube will be held on—drawn downwards—to the mass of the fluid, while by adhesion (q. v.) they will be drawn upwards towards the sides of the tube. By the ordinary action of gravity, as in tubes of a large size, the fluid will at once tend to rise in the tube to its level in the vessel. Whether it will succeed in doing so, or whether it will rise still higher, must depend on the adjustment of the forces of cohesion between the fluid particles and their adhesion to the solid of the tube. The relation of these forces may be generally explained as follows: Let mm' (fig. 4) be the surface of the column, mn , of a liquid contained in a space, $abb'a'$, above or below the surface, nm' , of the external liquid. There being equilibrium between the liquid in the tube and in the vessel, any line of liquid particles may be taken and supposed to be detached from the rest and enclosed in a tube, without altering the forces exerted. Let the line included between the dotted lines be conceived so detached. The actions which the particles of the liquid in the tube exert on each other, or sustain from the sides of the tube, have no tendency to make the liquid move either up or down. But the column, mb , in the tube has some action exerted on it by the sides of the tube above the surface, mm' . Let A , depending on the force of adhesion, represent this upward action of the tube. The column is also attracted downwards by the detached column bc , i. e., by the liquid in the imaginary tube. Let C , depending on the force of cohesion, represent this downward action of the liquid. Also the part bc of the liquid is attracted upwards by the tube ab by the attraction which we have represented by A . Thus the liquid column is acted on by two upward actions = $2A$, and a downward action, C . The whole force acting on it, excluding gravity, is $2A - C$. Gravity would make the liquid rise to nm' at once, i. e., till it stood as high in the tube as in the vessel. Whether, then, it will rise above nm' , or be depressed below it, must depend on whether $2A$ is greater than C , equal to it, or less than it. If $2A = C$, the liquid will stand in the

tube at the level nm' , as if these forces did not act at all. If $2A > C$, then $2A - C$ will be an upward force, and the column will be raised above the level nm' . If $2A < C$, then $2A - C$ will be a downward force, and the column will be depressed.

Regarding the forms of the upper surfaces of columns of liquid in capillary tubes, it can be demonstrated mathematically that the same relations of the forces of attraction and cohesion, which determine the elevation or depression of the liquid column, determine also the form of its upper surface in the two cases of elevation and depression. In fact, the case of the elevated column resembles that of a cylinder of any very elastic substance (so elastic as to suffer change of form very readily under pressure), supported wholly by the rim at one of its ends; or, what is the same thing, by vertical forces acting in the lines composing its outer surface. Gravity draws down the concentric shells, of which the cylinder may be conceived to be composed, the further the more remote they are from the outermost, or that which is directly supported, the central rod being the most depressed. The reader who desires fuller information on this subject of the curvature in capillary tubes, should refer to the chapter on Capillarity in Webster's *Hydrostatics*. It appears from various experiments there recounted, that the form of the surface has an important bearing on the cause of the production of the whole phenomena.

The third fact of observation—viz., that the liquid rises higher or is more depressed the finer the bore of the tube—is thus explained in the case of elevation: Since the action of adhesion is confined to the superficial layer of the fluid, and between the same substances is, *ceteris paribus*, constant in quantity for an equal extent of surface, the wider the tube the shorter must be the column sustained, as the contents of the column raised by cohesion increase more rapidly when the bore increases than the attracting surface. The column increases with the square of the diameter of the tube, while the attracting surface increases only with the diameter. The height, therefore, is inversely as the breadth of the tube: That the depression must increase as the bore of the tube diminishes, appears from reasoning similar to that employed in the case just discussed.

The degree of elevation varies with the nature of the fluid, the variation depending partly on the difference of cohesion between the particles of the fluid, and partly on the difference of adhesion between the fluid and glass. It is found that temperature affects these forces, so that the height diminishes as the temperature rises.

The depression of mercury in a fine glass tube makes it necessary to use a correction in reading off the height of the mercurial column in the barometer, which, owing to it, stands always a little lower than the height due to the atmospheric pressure. Experience, however, has shewn that the capillary depression is nearly one-half less in tubes which have had the mercury boiled within them than in unboiled tubes, as by the boiling a film of air, which in unboiled tubes adheres to the glass, is expelled. By widening the bore of the tube also, the error may be diminished so as to be neglected altogether. In a tube of $\frac{1}{4}$ inch in diameter, in which the mercury has been boiled, the depression is 0.02 inch, while with a similar tube of $\frac{1}{2}$ inch diameter it is only 0.003. The depression of mercury, it is found, is slightly increased by an elevation of temperature. It may be mentioned that in reading off the level of mercury in any instrument, such as the barometer, the height should be taken from the convexity of the curve. If the liquid used in the

instrument, however, wets the tube, the height should be taken from the concavity.

As already stated, the phenomena are not dependent on the intervention of tubes; any capillary cavity suffices to produce them. When two light bodies, such as two bits of cork, are left to float on water, near each other, they soon come together, moving at last with a rush. This is sometimes given as an example of the gravitation that draws the planets to the sun; but it is really owing to this capillary action that we are considering. When the liquid wets the floating bodies, it rises slightly all round them, and this sustained liquid hangs as a weight on them on all sides. So long as it rises equally, there is no motion; but when the bodies come near each other, the space between them becomes like part of the inside of a capillary tube, the water rises higher there than on the other sides, and the bodies move towards the sides that are most strongly pulled. When the floating bodies are not wetted by the liquid, the surface between the two bodies is depressed, as that of mercury is inside a glass tube, and the bodies descend, as it were, down the opposing slopes, and meet in the bottom of the hollow. If one of two bodies floating on water is smeared with oil so as to prevent the water from adhering, instead of coming together, the two will recede from each other, for reasons analogous to the above.

C. A. plays a most important part in nature in a great variety of ways. An instance of its employment by man is seen in the wicks of lamps and candles, which, being composed of fibrous materials, furnish hair-like channels by which the melted oil is elevated to the flame, and supplied as fast as it is consumed. C. A. influences the circulation of fluids in the porous tissues of animals, and it is the principal mode in which water, with the various substances which it holds in solution, is supplied to the roots of growing plants. It is through it that in summer droughts moisture is raised to the surface for the maintenance of vegetable life. C. A., too, affects many phenomena usually considered under the head DIFFUSION (q. v.) of fluids and gases. The reader, on referring to the article OSMOTIC ACTION, will also see that it enters into the explanation of the phenomena known as exosmosis and endosmosis.

A familiar illustration of C. A. is furnished when one end of a towel happens to be left in a basin of water, while the other hangs over the side below the level of the water; the basin is soon emptied of its contents. It is important to observe that, although the towel will become wet, not a drop will flow from it, unless the outside end reach below the level of the water in the basin. In this respect C. A. resembles that of the syphon. And this shews the error of supposing that water may rise through the earth by C. A., and flow out as springs at a higher level than the source whence it is drawn.

Some very interesting experiments have been made by M. Poiseuille (*Ann. de Chimie et de Phys.* III. xxi. 76) concerning the flow of liquids through capillary tubes, the results of which must here be stated. It appears that when the tube exceeds a certain length—which is greater as the bore increases—the following laws regulate the rate of efflux of the liquid, the efflux taking place under pressure: 1. The flow increases directly as the pressure, so that under double the pressure, double the amount is discharged in equal times. 2. In tubes of equal diameter, the quantities discharged vary inversely as the length of the tube. If a tube 2 inches long discharge 100 grains in 5 minutes, a tube 4 inches long will only discharge 50 grains. 3. In tubes

of equal lengths, but different diameters, the flow is as the fourth power of the diameters. If one be $\frac{1}{4}$ of an inch in bore, and the other $\frac{1}{16}$, the efflux from the larger will be 16 times as great as from the smaller. It is further found that the efflux varies with the nature of the liquid, the material of the tube not appearing to affect the result in any great degree. No law of the rate of efflux has yet been discovered, depending on the density, capillarity, or fluidity of the fluids.

It may be mentioned, in conclusion, that the tubes to be used in the experiments on capillarity should be perfectly clean and dry. If wetted, the film of moisture on the tube forms a new tube, and the action will be the same as with a tube of the substance forming the film. The reader should consult on the whole subject, Webster's *Hydrostatics*, chapter on 'Capillarity,' and Miller's *Elements of Chemistry*.

CAPITA, DISTRIBUTION PER—i. e., distribution by heads, or by numbers, equally—occurs in the case of several claimants to the property of a deceased person, all severally claiming in their own right, in equal degree of kindred, and not under any right of representation. See INHERITANCE, SUCCESSION.

CAPITAL (Lat. *capitulum*, from *caput*, the head), the head of a column, pilaster, &c. Till the period of the renaissance, the head of a column in English was called chapter (chapter), its diminutive being chapitrel. See COLUMN.

CAPITAL, in Fortification, is an imaginary line dividing a defence-work into two similar and equal parts. The C. of a bastion is a right line drawn from the point or salient angle to the middle of the gorge or entrance in the rear. The C. of a ravelin is a right line drawn from the re-entering angle of the counterscarp to the salient angle of the ravelin. See the wood-cut in CAPONIERE.

CAPITAL, in Geography, the principal city or town of a country, that in which the sovereign usually resides, and where the legislature meets, and the chief legal courts are held.

CAPITAL, in Trade and Political Economy, is in its restricted sense applied to the money, or the property convertible into money, with which a trader or producer carries on his business. In this sense, Adam Smith and many other writers call it stock; and there is a convenience in having a separate term for expressing this sense of the word C., since it is totally different from its wider sense as an element in political economy. Many attempts have been made to define C. in its general sense, but with very imperfect success, since no sooner is a restrictive definition laid down, than some one can point at things which are C., and yet are not included in the definition. It has, for instance, been called the produce of past labour stored up and applied to the facilitating of future labour; but, as we shall see, many things become C. which the hand of man has never touched. There is no doubt, however, that the existence of C. arises out of the fact of labour or industry having been exercised; and perhaps a good general understanding of its character may be derived from treating it as the *impetus* or *impetus* which past industry gives to facilitate future industry. Wherever something is reserved from immediate consumption, and made to serve in future production, there is capital. We cannot have a better illustration than in the first bow and arrow made by the savage. He has expended on this machine for securing his food a portion of the time and labour which he might have given to the tedious task of catching his food with his own hands, and at

this sacrifice he has obtained the means of more easily and economically obtaining it in future. All C. is not, however, *directly* made by the industry of the owner, or, indeed, by industry at all. The accidental finder of a diamond, or a pearl, worth £100, possesses so much capital. His acquisition, however, would have no value but for those productions of industry which it is permitted to represent, and if pearls and diamonds were often found, they would cease to be valuable; the trade of finding them is as laborious and as ill remunerated in the long-run as most others. The owner of a barren heath, which was intrinsically worth nothing, finds it become suddenly valuable by the progress of a large town; but it is the industry of that town which has given the value, and the owner having the good-fortune to have a hold on a portion of the produce of that industry, becomes a capitalist. It is impossible to enumerate all the elements of which C. in the general sense consists, or all the ways in which it can be made. Whatever thing done enables some other thing to be done which supplies any of the necessities or wishes of the human race becomes capital. Thus, the education and skill of the barrister, the physician, and the artist—the agility, acquired through long and toilsome practice, of the rope-dancer and the juggler—all are capital. It makes C. to shift the place of a thing, bringing it from where it is not, to where it is, wanted. So, also, the changing of a person's place may become C. to him, as where he leaves a district in which his trade is not required, or exceeds the demand, for one where he can pursue it to advantage. Successful emigration thus creates C., bringing into human use districts of land which previously lay useless. The total C. at any time in existence consists of an aggregate of the several capitals at the command of individuals or communities. But it is essential to any unit of C. that it should be sufficient for the purpose it is intended for, otherwise it may seem to be, but will not in reality be, a part of the general aggregate—it will, in fact, be lost. If an expenditure of £1000 be necessary to raise a sunk ship, and only £900 are expended, that sum which might have been available for some other purpose is lost. C., as distinguished from property or wealth, is a *moving force*; and if it be not sufficiently strong for accomplishing its purpose, it is lost. This is one of the most important truths in all political economy, since most of the great losses suffered by communities and individuals arise from undertakings for which they have not adequate C., or for which that which seems to be C. does not really turn out to be so. Perhaps the most memorable mistake of this kind ever made was when the French revolutionary government issued assignats (q. v.). These were ostensibly issued on a good security—namely, the security of the forfeited land. But however valuable that land might be in the long-run, it was not available to pay the assignats; there was no purchaser for it; and the assignats consequently fell in value. Gold to a far less amount than the money value of the land—that is to say, than the price which would be paid for it when sold in the natural course of things—would have been a sufficient C. for the issue of these assignats. The same mistake is often exhibited on a small scale when a landed proprietor keeps together a large estate which he cannot afford to improve and cultivate properly. It loses its power of C. in his hands; and he would be much better off if he sold a portion of it for money to be invested in improvements on the remainder. Probably 19 out of every 20 bankruptcies arise from the bankrupts having undertaken enterprises beyond the reach of their C.—

from over-trading, or over-speculating, as it is otherwise called. When speculation becomes epidemic, the whole community suffers from undertakings too great for its C., and a crisis occurs. Such was the great railway crisis of 1847. Parliament had, in the previous year, passed bills for the construction of railways, which, if they had all been made, would have cost upwards of £130,000,000—a sum which the country, rich as it was, could not afford to advance. Though it is an axiom that people cannot trade beyond their C., yet what can be accomplished by any given amount of C. must depend on the skill and sagacity of the person employing it. Competition no doubt tends to equalise profits, but competition is itself a contest in which each tries to drive a more profitable trade than his neighbours, and some are more successful than others. A frequent element of success is the rapid circulation of C., by which it is made to return many profits, though perhaps small ones, in the course of the year. The trader who turns over his C. ten times at a profit of 3 per cent., makes more than he who draws a single profit of 10.

If the nature of C., as the produce of past, and the promoter of future industry, were better understood by the working-classes, they would be saved from much unhappiness and mischief. Whatever C. may be to the rich man, it is bread itself to the working family. The withdrawal of the C. embarked in the cotton trade alone would starve millions; and yet many educated men have endeavoured to teach working-people that C. is their natural enemy. Its strength may no doubt be sometimes used for evil purposes, but none save evil results can arise from destroying it. The only way in which any man can effectually protect himself from such mischief as he supposes it may do, is to save, and become a participator in it. Itself the result of industry, it is a more powerful instrument in the hands of him who has made it than in any other's. The savings of working-men are the best laid out C. in the world. The first pound laid past is the most profitable of all—it represents freedom from debt, and the capacity of its owner to purchase what he wants with ready money—a privilege probably bringing him a profit of many pounds, or many hundreds per cent. upon his capital.

CAPITAL ACCOUNT; such is the name given to what concerns the capital stock of a railway or other public company. In authorising a railway company—which we take as an example—parliament gives power to raise so much money by shares, and so much by borrowing. The amount that may be borrowed is equal to a third of the share stock, but it cannot be legally borrowed until at least one-half of the share stock has been paid up. The form of borrowing is that of giving a mortgage on the whole property of the railway; the deed of mortgage, which is called a debenture, expresses the sum lent, the rate of interest that is to be paid, and the period for which the loan is given. See **DEBENTURE**. Unitedly, the money got for shares and by debentures forms the capital of the company; and, deposited in a bank, constitutes the *Capital Account*. On this fund the directors of the company make draughts to pay for the land, and all the works connected with the line, as also rails, locomotives, carriages, and, in short, everything involved in perfecting the railway up to the point of working. From the first, the holders of debentures receive interest, which must be paid in all circumstances, and the principal must be returned at the conclusion of the period for which it has been borrowed; at least, such are the ordinary obligations towards debenture holders. For the share part of the capital no return is made till the

CAPITAL FELONIES—CAPITAL PUNISHMENT.

railway has been in operation, and drawings come in from the traffic.

As soon as traffic commences, there begins a new account called the *Revenue Account*, and which, kept in the same or a different bank, has no connection with the Capital Account. This, it may be judged, at once introduces a great complexity into the financial affairs of railways. In ordinary businesses, the profits of a concern are the free proceeds after deducting interest on capital and all expenses; and no attempt is made to keep two accounts, or to detach one part of the revenue from the other. As shareholders in a railway occupy the position of partners in a business, it might be expected that they would receive a divisible part of the proceeds equal to their respective claims after all expenses whatsoever had been paid. This is not the plan usually adopted. In general, the shareholders are only temporary partners; they buy shares in order to sell them at an advance. What they mainly look to is the rise on shares in the market, and therefore any process of management which can promote this important object meets their approval. Hence, the keeping of two accounts, two bank pass-books, and two books of cheques. From the revenue account are drawn all payments for wages, rates, and taxes, coke, oil, and other petty furnishings, also repairs on carriages and locomotives, maintenance of way, and general management. What remains is the fund, whence is paid, first, the interest on debentures, and second, the dividend of the shareholders. From the C. A. are drawn all other outlays: first, the repayment of principal to debenture holders, and second, the expenditure for new carriages and locomotives, new rails, and other substantial repairs upon and additions to the plant. As all railway traffic exceeds the expectations formed respecting it, the demands on the C. A. for fresh additions of one kind or other, become exceedingly onerous. Were the shareholders to look to ultimate advantages, they would sanction the payment for permanent improvements out of the current revenue; but, as has been stated, shareholders for the most part care nothing for the remote and contingent prosperity of the undertaking, and will not, or cannot make a corresponding sacrifice. Greatly diminished by primary outlay, and now operated upon for all sorts of additions and improvements, the C. A. is at length exhausted, and new powers have to be got from parliament to create new shares and new debentures, and which shares are only taken up by being guaranteed a preferable claim on the funds of the company. Where a large extension of traffic must be provided for, the creation of fresh capital is indispensable and legitimate; but it is equally open to remark that the C. A., as usually conducted, affords the means of enormously increasing the company's obligations, and is, in fact, an expedient to give good dividends to present holders of stock at the cost of their successors. Perceiving what must be the consequences, those among the proprietary of the small and more prudently managed railways who look to permanent investment, lose no opportunity to urge 'that the capital account shall be closed, and the whole expenditure of the company, including the payment of dividends and interests, be taken from revenue.' Objections are raised to these remonstrances, sometimes on plausible, sometimes on sufficiently valid, grounds; and it may be said that in remarkably few cases have railway companies been able, or been disposed, to close their Capital Account. See RAILWAYS (Legislation and Management). W. C.

CAPITAL FELONIES. See FELONIES.

CAPITAL PUNISHMENT in criminal juris-

prudence is the punishment of death. It is called *capital* punishment because the head (Lat. *caput*), from being the most vital, is usually that part of the body which is acted on. This applies especially to beheading and hanging; but almost all modes of depriving a criminal of life appear to have in view the peculiar vulnerability, and, at the same time, vitality of the head. This extreme penalty, notwithstanding the practice of the world from the remotest times down to the present day, has frequently been reprobated by philosophers and philanthropists, who have even gone so far as to deny the right so to punish to any earthly power. The weight of authority, however, appears in favour of capital punishment. Mr Bentham, one of the most reasonable and discriminating authorities on the subject, in his well-known and valuable treatise, says, that the idea of C. P. would naturally suggest itself in the infancy of a state. When any one had committed an offence, and disturbed the peace of society, the question would then first arise: 'How shall we prevent these things?' and the answer most likely to occur to a set of barbarians would be: 'Extirpate the offender, and give yourself no further trouble about him.' And in conformity with this view of the matter, he alludes in a note to the case of the Hottentots, who have no fixed laws to direct them in the distribution of justice, and consequently, when an offence has been committed, there is no form of trial, or proportion of punishments to offences; but the kraal (village) is called together, the delinquent is placed in the midst, and without further ceremony, demolished with their clubs, the chief striking the first blow. The Marquis Beccaria, in his remarkable *Essay on Crimes and Punishments*, strongly argues against the capital sentence being carried out in any case, denying the right, in fact, of government so to punish, and maintaining, besides, that it is a less efficacious method of deterring others, than the continued example of a living culprit condemned, by labouring as a slave, to repair the injury he has done to society. Bentham, on the contrary, holds that death is regarded by most men as the greatest of all evils; and that especially among those who are attached to life by the ties of reputation, affection, enjoyment, hope, or fear, it appears to be a more efficacious punishment than any other. On the question of right, Beccaria is still more pointedly refuted by Sir Samuel Romilly, who observed: 'Beccaria and his disciples confess that it is not the greatest of evils, and recommend other punishments as being more severe and effectual, forgetting, undoubtedly, that if human tribunals have a right to inflict a severer punishment than death, they must have a right to inflict death itself' (*Memoirs*, vol. iii. p. 278). It is not a little interesting to know, that such was the opinion of one who did so much as a statesman to mitigate the severity of the criminal law.

Against C. P. arguments are often urged from Scripture, based on the general principle of Christian charity. To these it is replied that they proceed on a misapprehension and misapplication of the principle; and reference is confidently made to the Old Testament as sufficiently exhibiting the mind of the great Lawgiver in regard to this matter.

Death was, in former times in England, the ordinary punishment for all felonies, and the certain doom of those who could not avail themselves of *benefit of clergy* (q. v.), i. e., the common law inflicted death on every felon *who could not read*, and the law implied that punishment, where a statute made any new offence felony. On the other hand, the numerous acts of parliament creating felonies without benefit of clergy, shew that the statute law

CAPITAL PUNISHMENT.

was still more sanguinary, so that of the 160 offences referred to by Blackstone as punishable with death, four-fifths had been made so during the reigns of the first three Georges. That some idea may be formed of such Draconian justice as was then established, we may mention the following as among the offences which involved sentence of death—stealing in a dwelling-house to the amount of 40s.; stealing privately in a shop goods of the value of 5s.; counterfeiting the stamps that were used for the sale of *perfumery*! and doing the same with the stamps used for the certificates for *hair-powder*! Thanks, however, to the exertions of Sir Samuel Romilly, the inhumanity and impolicy of such a state of the criminal code gave way, towards the end of the reign of George III., to a course of legislation which has reduced the application of death as a punishment within its present humane limits. Practically, indeed, it is only in the case of treason and murder that the capital sentence is ever pronounced; and even then, it is not always carried out, for the crown reserves to itself and exercises a right of review which frequently leads to such a change in the convict's fate as at least spares his life. This discretionary control on the part of the executive is essential in the present state of the law, which affords no means for a judicial appeal on the merits; for the very nature of the punishment, when finally executed, precludes the idea of all benefit to the sufferer, should the verdict of the jury afterwards turn out erroneous, and the innocence, instead of the guilt, of the accused be established. The law as it stands, indeed, allows a capital sentence to be reversed if technical error can be shewn on the face of the judgment or other matter of record—but what avails that, after the sentence has been executed?

In Scotland, the administration of the criminal law has perhaps been, on the whole, as severe as in England. Mr Erskine says, that 'those crimes that are in their consequences *most hurtful to society*, are punished capitally or by death; a category that is certainly sufficiently indefinite; and anciently, it might be shewn that the executions in Scotland for offences corresponding to those which were capitally punished in England, were, in proportion to the population, quite as numerous as those in the latter country. But in the more modern practice of Scotland, capital sentence was only pronounced in the four pleas of the crown—viz., murder, rape, robbery, and wilful fire-raising, to which may be added housebreaking. At present the penal system in Scotland may be said to be identical with that in England, death, as a punishment, being only inflicted in the case of convictions for murder.

With respect to the mode of executing C. P., we need not detain the reader by any account of the obsolete cruelties and tortures of former times. It may suffice to state that *hanging* and *beheading* are the two methods which now, for the most part, are practised in the different European states, indeed, with the exception of Spain, by all. In the last country, the death of the culprit is instantaneously caused by the *Garrote* (q. v.). In England, Scotland, and Ireland, and in all the dependencies of the crown, the convict is hanged; while in France he is decapitated by the *Guillotine* (q. v.), an instrument which an old Scotch machine called the *Maiden* (q. v.), and used for the same purpose, very much resembled. In most of the German states, beheading is the mode of execution adopted; but in Austria, criminals convicted of capital offences are hanged, as in England.

The following works may be consulted on the subject of this article: Basil Montagu *On the Punishment of Death*, 3 vols. (1809, 1812, 1813), in which

he collects the opinions of different eminent authorities; *Memoirs of Sir Samuel Romilly*, 3 vols. (1840), and his miscellaneous law-pamphlets; Jeremy Bentham's *Rationale of Punishment* (1830); Beccaria's *Essay on Crimes and Punishments* (1775); Edward Gibbon Wakefield's *Facts Relating to the Punishment of Death in the Metropolis* (1831); and Frederic Hill's *Crime, its Amount, Causes, and Remedies* (1853).

CAPITAL PUNISHMENTS IN THE ARMY AND NAVY.—

1. *In the army*.—The law on this subject is contained in the 19th of the Articles of War now in force, which prescribes death as the punishment of the following offences, or such other punishment as by a court-martial shall be awarded. (1.) Any officer or soldier who shall excite or join in any mutiny or sedition in any forces belonging to her Majesty's army, or Royal Marines, or who shall not use his utmost endeavours to suppress it, and knowing of it, shall not give immediate information of it to his commanding officer; or (2) who shall hold correspondence with, or give advice or intelligence to, any rebel or enemy of her Majesty; or (3) who shall treat with any rebel or enemy without her Majesty's licence, or licence of the chief commander; or (4) shall misbehave himself before the enemy; or (5) shall shamefully abandon or deliver up any garrison, fortress, post, or guard committed to his charge; or (6) shall compel the governor or commanding officer to deliver up or abandon such place; or (7) shall induce others to misbehave before the enemy, or abandon or deliver up their posts; or (8) shall desert her Majesty's service; or (9) shall leave his post before being regularly relieved, or shall sleep on his post; or (10) shall strike or offer any violence to his superior officer, being in the execution of his office, or shall disobey any lawful command of his superior officer; or (11) who, being confined in a military prison, shall offer any violence against a visitor or other his superior military officer, being in the execution of his office.

By article 20, it is declared that no judgment of death by a court-martial shall pass, unless two-thirds at least of the officers present shall concur therein; and by article 21, it is provided that judgment of death may be commuted for penal servitude for any term not less than four years, or for imprisonment for such term as shall seem meet.

It would appear that the employment of a soldier in the service subsequent to his arrest on a capital charge, may operate as a remission of the sentence of death. This is illustrated by the following case, mentioned by Mr Prendergast in his *Law Relating to Officers in the Army* (2d ed., 1855, p. 245): In 1811, private John Weblin of the 3d Buffs was sentenced to be shot. The commander-in-chief, the Duke of Wellington, in his 'Remarks' upon the proceedings, took notice that, through some extraordinary inattention, the prisoner had actually been permitted to serve in an engagement with the enemy, after he had been put into arrest for his crime. On this ground, the duke pronounced that he was under the necessity of *pardonning* the prisoner.

In the army, C. P. is inflicted by the offender being either shot or hanged—the latter being the more disgraceful mode of execution.

2. *In the navy*.—These are regulated by the 22 Geo. II. c. 33, amended by the 10 and 11 Vict. c. 59. By the first of these acts, certain offences in the navy, whether on board ship or on shore, were punished with death absolutely, without any discretion in the court to alter or mitigate the sentence. But, by the 10 and 11 Vict., this severity is removed (excepting in the cases of murder and other unnatural offences mentioned in the act), and courts-martial are authorised to abstain from pronouncing judgment

of death, if they shall think fit, and to impose such other punishment instead as the nature and degree of the offence may deserve. In this discretionary sense, the following offences are punishable, in the navy, with death: (1) The holding illegal correspondence with an enemy; (2) the not acquainting, within 12 hours after the opportunity to do so, the commander-in-chief, or other superior officer of the squadron, with any message from an enemy or rebel; (3) all spies bringing seducing letters from an enemy or rebel, or endeavouring to corrupt any one in the fleet to betray his trust; (4) the relieving an enemy or rebel in any way, directly or indirectly; (5) not preparing for fight when duty commands, or not making due preparations on likelihood of engagement, and not encouraging the inferior officers and men to fight courageously; (6) the treacherously or cowardly yielding or crying for quarter; (7) disobeying orders in time of action, or not using all possible endeavours to put the same effectually in execution; (8) being guilty of cowardice or neglect of duty in time of action; (9) through cowardice, negligence, or disaffection, forbearing to pursue the chase of any enemy, pirate, or rebel, beaten or flying, or not relieving or assisting a known friend in view to the utmost; (10) deserting to the enemy, or running away with any of her Majesty's ships or their belongings, or any pieces to the weakening of the service, or cowardly or treacherously yielding up the same; (11) deserting simply, or enticing others so to do; (12) making, or endeavouring to make, any mutinous assembly on any pretence whatsoever; (13) uttering words of sedition or mutiny; (14) concealing traitorous or mutinous practices or designs; (15) striking a superior officer, or offering any violence to him, being in execution of his office, on any pretence whatsoever; (16) unlawfully burning or setting fire to any ship property or furniture, not then appertaining to an enemy, pirate, or rebel; (17) neglect in steering any of her Majesty's ships, so that the same be stranded, split, or hazarded; (18) sleeping on watch, or negligently performing duty, or forsaking station; and (19) robbery.

It is stated by Mr Prendergast, in the work to which we have referred (p. 244), that a sentence of death pronounced by a court-martial does not operate as an absolute dismissal from the service; for if the offender should be pardoned, he is restored to his former position.

But though a pardon operates as a restoration to the service, the greater question still remains to be judicially decided, whether a restoration to the service operates as a pardon. This question is inseparably connected with the fate of the gallant but unfortunate Sir Walter Raleigh. He had been condemned to death for alleged participation in a treasonable plot to raise Arabella Stuart to the throne; and, after undergoing 13 years' imprisonment, he received from James I., by a commission under the Great Seal, the command of a fleet and army fitted out against the Spanish possessions in South America, with power of life and death over the king's subjects serving in the expedition. The enterprise failed; and on Sir Walter's return to England, James caused his head to be struck off, according to the sentence originally pronounced. On shewing cause against his execution, Sir Walter pleaded that his commission was tantamount to a pardon, and quoted a case of a man who had been condemned for felony, having been pardoned on account of his subsequent service in the wars of Gascony. Lord Chief-Justice Montague, however, held that though an implied pardon of the kind cited might hold good in felony, that treason could only be pardoned by express words. There is the high legal authority of the present Lord Chancellor

(Lord Campbell*) for saying that the chief-justice declared and expounded the law soundly; and that in strictness Sir Walter's attainder, under the former judgment, could only be done away with by letters-patent under the Great Seal, expressly reciting the treason, and granting a free pardon. See, on the subject of these two articles, ARTICLES OF WAR, and MUTINY ACT.

As to the mode of C. P. in the navy, the culprit, where he is an officer, is shot; where he is a common seaman, he is usually hanged at the yard-arm.

CAPITALS (*majuscula*), in contradistinction to small letters (*minuscula*), are the large letters employed in writing and printing to help the eye, to relieve the uniformity of the page, to increase the facility of keeping and finding the place, to mark the beginnings of sentences, proper names, &c.—Among the ancients, and during the earlier part of the middle ages, no distinction of C. and small letters was known; and after the practice had been introduced of beginning books and chapters with great letters often adorned or illustrated with much artistic ability, it was long before C. were employed in such a way as could afford much real advantage to the reader. At the present day, they are universally employed, even in the printing of Greek and Latin books. Considerable diversity has existed at different times with regard to the employment of them, the books of the 17th and 18th c. exhibiting a much greater proportion of them than those of the present day. In German books, all substantives usually begin with a capital letter; in English and French books of the present day, they in general appear only at the beginnings of sentences and of proper names. Adjectives formed from proper names, as *English*, *French*, &c., are generally begun with a capital in English books, but not in French nor in German ones.

CAPITANA'TA, a province of Naples corresponding to the *Davunia* of the ancients, is bounded N. and E. by the Adriatic, and on the S. W. by the Apennines. It stretches along the Adriatic about 70 miles in a straight line, and its average breadth is about 45 miles; but its coast-line, measuring round the great promontory of Monte Gargano, which has been called 'the spur of Italy,' is fully 100 miles, and its breadth between the extremity of that projection and the Apennines, 75 miles. Pop. (1856), 334,878. The greater part of the surface is a sandy plain sloping from the Apennines to the Adriatic, and watered only by some inconsiderable streams. The rearing and feeding of cattle form the chief occupations of the inhabitants. Wheat, wine, and fruits of various kinds are produced in quantities sufficient to admit of exportation. There are important salt-works, quarries of alabaster, and potters' clay. Foggia is the chief town.

CAPITATION, from the Latin *caput*, a head, means something applicable to all persons, or to the people by the head. A tax levied on all persons, without reference to property or other incidents, is called a C. tax, and sometimes a poll tax. The former term was often used in France for the tax better known as the *taille*, although this offensive impost was not imposed on all alike, the nobility enjoying many exemptions from it.

CAPITOL, the fortress of ancient Rome, and site of the national sanctuary the temple of Jupiter, was situated on the *Mons Capiolinus*, the smallest but most famous of the seven hills on which Rome was built. The hill itself was first termed *Mons Saturninus*, afterwards *Mons Tarpeius* and *Rupes Tarpeia*, and after the foundation of the Capitol, *Mons*

* *Lives of the Chief-Justices*, vol. i. pp. 357, 358.

Capitolinus, though a particular portion of it retained its ancient name of *Rupes Tarpeia*. It was steep and abrupt in almost every part, formed a natural fortress, and was strengthened here and there by towers. The C. was founded by Tarquinius Priscus, and completed by Tarquinius Superbus, who tasked the people to work at it. The whole mount had a circumference of about 800 paces. During the civil wars under Sulla, the temple was burned (according to Tacitus, by design), and after its restoration, destroyed during the Vitellian riots. It was rebuilt by Vespasian, after whose death it was again destroyed by fire, but was once more restored by Domitian, who instituted here the Capitoline Games. Domitian's structure lasted to a late period of the empire. Regarding the site of the C., there has been great dispute; the German scholars, for the most part, maintaining that it occupied the south-west summit of the hill, and the Italians, the north-east. The latter situation has the weight of probabilities in its favour. From that portion of the mount named the Tarpeian Rock, state criminals were thrown down. According to the description given by Dionysius of Halicarnassus, the temple of Jupiter, with its peristyle of columns, was 200 feet long by 185 feet wide, and was divided into three cellae, separated from each other by walls, and respectively dedicated to Jupiter, Juno, and Minerva. In the spacious portico, the people feasted on triumphal occasions. The scanty ruins remaining in the present day consist of a substructure of peperino or volcanic tufa, a wall of the same materials, and some remains of the south front, together with a portion of the great flight of steps leading to the temple.

The modern C. (*Campidoglio*), built on the site, and partly on the foundation of the ancient C., was designed by Michael Angelo, but is one of his inferior works. The main entrance, however, presents a splendid view. It is used as a kind of hotel-de-ville and museum.

Besides the great temple of Jupiter, the most important structures on the Capitoline Mount were the temple of Jupiter Tonans, built by the Emperor Augustus; and the magnificent *Tabularium*, containing archives, and, in connection with the *Ærarium* ("Treasury"), serving as a library and place for lectures, &c. The remains of this structure, built by Quintus Catulus, 73 B.C., have still an imposing aspect.

CAPITULARIES (Lat. *capitularia*). *Capitularium* is literally a hook divided into chapters; and the plural of the word was the name given to the laws issued by the kings of the first and second of the Frankish races, from Charles Martel downwards. These laws proceeded from the great assemblies of the king, nobles, and bishops, which formed the states of the kingdom, and, from their general character, were opposed to the laws issued for the separate states, which were called *leges*. They were divided into general and special C., according to the more or less general nature of the interests which they embraced, and the mode of their publication. They have by no means been all preserved. The most famous are those of Charlemagne and of St Louis. In 827, Abbot Angenius, of Fontenelles, made a collection of the C. of Charlemagne, and of his son, Louis le Débonnaire. Other collections were made by private persons, and, in 847, one by authority of the king, but they are all very imperfect and ill arranged. After Charles the Simple, in 922, no more C. were issued, and no similar laws or statutes exist from that period till the time of Louis le Gros, in 1100. The best collections are those of Baluze (Paris, 1677 and 1780), and of Pertz, in the *Monumenta Germaniæ*.

CAPITULATION, a treaty consisting of several specified conditions (Lat. *capitula*, heads). In the military sense of the word, a C. is a treaty of surrender to an enemy. When a place can no longer be defended, on account of failure of ammunition or provisions, or the progress made by the besieging-party, a white flag is commonly put up, as a sign that the besieged are willing to capitulate. According to the kind and degree of peril in which the fortress is placed, so are the terms which the governor may reasonably expect from his successful opponent. Sometimes the arms and military stores are left to the besieged, but more frequently they are taken by the besiegers, except articles of private property belonging to the officers and men. The 'honours of war,' the marching out with drums beating and colours flying, are usually stipulated for, unless the conqueror exacts very severe terms. The mildest form of a C. is a *convention*, agreed to when the conqueror is not strong enough to insist on stringent conditions.

CAPITZ, a town on the island of Panay, in the Philippine Archipelago. It is situated on a plain on the north coast, near the rivers Panay, Panitan, and Ivisan, by which it is sometimes inundated during the rainy season. It is defended by a small fort, and is the residence of a Spanish alcaide. Pop. 11,000.

CAP'NOMANCY, a word formed from the Greek *capnos*, smoke, and *manteia*, divination. The ancients practised it in two different ways—either they threw grains of jasmine or poppy on the burning coals, and watched the motions and the density of the smoke that rose from them, or they watched the smoke of sacrifices. This latter kind of C. was most generally employed, and that to which the greatest importance was attached. If the smoke was thin, and ascended in a right line, instead of being blown back by the breeze, or spreading over the altar, the augury was good. It was also believed that the inhalation of the smoke rising from the victims or from the fire which consumed them, gifted the priests with prophetic inspiration.

CAPO D'ISTRIA, a fortified seaport town of Austria, situated on a rocky island in the Gulf of Trieste, 8 miles south-west of the city of Trieste. It is capital of the circle of Istria, with the peninsula of which it is connected by a stone causeway, nearly half a mile long. Its old buildings, ruinous walls, and narrow streets, give the town a gloomy aspect. It has a cathedral, manufactures of leather and soap, and a trade in wine, oil, and salt. Pop. 6870. In ancient times, this place was known as *Ægida*, and afterwards as *Justinopolis*, in honour of Justin II, who restored it.

CAPO D'ISTRIA, or **CAPO D'ISTRIS**, JOHN ANTHONY, COUNT, president of the Greek republic from 1827 to 1831, was born in Corfu, 1780. His family had been settled in that island since the 14th c., but originally came from the Illyrian town of Capo d'Istria (q. v.), near Trieste. He devoted himself to political life, and after having held a high position in the Ionian Islands, he entered the diplomatic service of Russia. Here his diplomacy tended to the separation of Greece from Turkey. In 1827, he was elected president of Greece; and in January 1828, he landed in Greece, and entered upon the duties of his office. He was a patriot, a philanthropist, and an able diplomatist, but by no means equal to the task which he now undertook. Everything was in disorder; the people had been long enslaved, and knew not how to use their freedom; and the president had been so much imbued with the centralising principles prevalent at the courts

CAPONIERE—CAPRI.

which he had frequented, that some of his measures, especially that restricting the liberty of the press, gave offence to the most temperate of the enlightened lovers of civil liberty. His career was cut short by his assassination in a church at Nauplia on October 9, 1831. The assassins were relatives of Peter Mauromichali, against whom he was urging on a prosecution, for alleged offences against the state.

CAPONIERE, or **CAPONNIÈRE**, in Fortification, is a parapet 8 or 10 feet high, with a superior slope, terminating in a small glacis. It is placed in the ditch of a fortified place, to cover or screen the defenders while passing from one defence-work to another. Generally, it has a banquette, on which musketeers may stand to fire over the crest. If there is a passage between two such parapets, it is a *full caponnière*; if on one side only, a *half caponnière*. Generally, the parapets are of earth, and the passage open overhead; but sometimes caponnières are vaulted galleries of brickwork, loopholed at the sides for musketry; while in field-works, palisade caponnières are occasionally thrown across the ditches of redoubts.

Reserving to the article FORTIFICATION a notice of the connecting-links between various defence-works, we give, in the annexed cut, a plan of what is called a *front of fortification*, illustrating many parts already described in the *Encyclopædia*, and

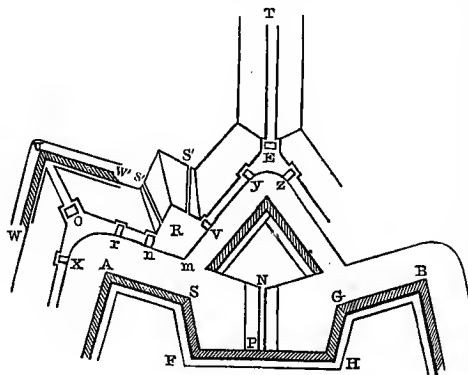

Front of Fortification.

many others still remaining to be described. ASF is one half of a *bastion*; BGH, one half of another bastion; AS, BG are *faces* of the bastions; SF, GH are the *flanks*; A and B are *salient angles*; S and G are *shoulders*; F and H are *re-entering angles*; FH is the *curtain* between two bastions; PN is the caponnière, stretching across the main ditch from the curtain to the ravelin N; the white space on which the letters XAmSVyGB stand is the *ditch*; ORE is the *covert* or *covered-way*; R is the *place of arms*; S', S' are *sally-ports* cut through the *glacis*; X, r, n, V, y, and z, are *traverses*; WUW' is a *fleche*, outside a salient angle of the glacis; OU is a second caponnière, leading to the *fleche*, with a traverse at O; E, T are a traverse and a caponnière leading to a redoubt supposed to be beyond the glacis; a line in the direction UA would describe the *capital* of one of the bastions.

CAPPADO'CIA, anciently, a province, and subsequently a kingdom in the west of Asia (in part the present Caramania). It was bounded by Lycaonia on the W., by Cilicia and Syria on the S., by Armenia on the E., and by Pontus on the N. During the time that it belonged to the Persian

empire, however, it included Pontus, which was called Lesser Cappadocia. In 17 A.D., C. was erected into a separate province of the Roman empire, by Tiberius.

CAPPAGH BROWN, a bituminous earth, which yields pigments of various shades of brown, the two most strongly marked being known as Light and Dark Cappagh Brown. The colouring matters are oxide of manganese and iron. The C. Browns are transparent and permanent; and when not applied too thickly, they dry well in oil. The name is derived from Cappagh, near Cork, in Ireland. C. B. is also called Encrome Mineral, and more frequently, Manganese Brown.

CAPPARI'DEÆ, or **CAPPARIDA'CEÆ**, a natural order of exogenous plants, allied to *Crucifera*, and including about 350 known species, herbaceous plants, shrubs, and trees, mostly natives of tropical and sub-tropical countries. The leaves are generally alternate, stalked, undivided, or palmate; the flowers solitary or clustered; the calyx of four sepals, sometimes cohering in a tube; the corolla of four, or sometimes eight petals, sometimes wanting, the stamens generally a multiple of four, or indefinitely numerous, placed on a hemispherical or elongated disk; the ovary one-celled, the style thread-like or wanting; the ovules curved; the fruit either dry and pod-like (tribe *Cleomeæ*), or a berry (tribe *Cappareæ*).—To this order belongs the well-known caper-bush. See **CAPERS**. Many of the species possess stimulant properties; some are poisonous. One of the most interesting plants of the order is the Siwák (*Capparis sodata*), a bush or small tree, one of the most characteristic features of the vegetation of Africa, from the Great Desert to the Niger, the small berries of which have a pungent taste like pepper, and when dried, constitute an important ingredient in the food of the inhabitants of those regions; whilst the roots when burned yield no small quantity of salt.—*Barth's Travels*.

CAPPEL, a village of Switzerland, in the canton of Zurich, and ten miles south-south-west of the city of that name. It is interesting as the place where the great reformer Zwinglius was killed in a conflict with troops of the Roman Catholic cantons, October 1531. A monument has been erected here to his memory.

CAPRI (the ancient *Capree*), a charming island in the Mediterranean, at the entrance of the Bay of Naples, about three miles from Cape Campanella, and twenty miles south of the city of Naples. On its small area of about eleven miles in circumference, it displays a rich variety of beautiful scenery, ruins of antiquity, and points of historical interest, and contains a population of about 6000 souls. The island is composed of two mountain masses, separated from each other by a depression like the seat of a saddle. That on the west, called Monte Solaro, which is the highest and largest, has an elevation of about 1900 feet. The eastern part does not attain a height of more than 860 feet above the sea. At the base of the eastern mountain is situated the town of C., built on a shelving rock, and guarded by walls, gates, and draw-bridges, with a cathedral, and a population, including the district, of about 4000. It commands a beautiful prospect, and communicates with the little town of Anacapri, on the western table-land, by a flight of 535 rude steps, cut in the face of the rock. There are only two safe landing-places on the island, and these are at C. and near it. C. was a celebrated place, in the times of Augustus and Tiberius. Ruins are still found of Roman baths and aqueducts, and of the twelve grand villas or palaces

CAPRICCIO—CAPSICINE.

built in honour of the twelve chief deities by the Emperor Tiberius, who passed the last ten years of his life here in the practice of the grossest licentiousness and cruelty. The inhabitants now consist of fishermen, sailors, and a few traders, with vine-dressers and cultivators of olives in Anacapri. Wherever a tree can be planted, the hopeful and industrious people have prepared for it a soil by persevering toil in terrace-culture. Delicious quails, which in vast numbers alight on the island during their migrations to and from Africa, in spring and autumn, are taken in nets, and form an important item in the resources of Capri. To the west of the town of C. is situated the *Grotta Azzurra* (Blue Grotto), a remarkable cavern, entered from the sea by a narrow opening not more than three feet high. Inside, however, it is found to be of magnificent proportions, and of marvellous beauty, the gorgeous colouring being said to be produced by the reflection and refraction of the sun's rays through the water. Elliptical in form, it has a length of 165 feet, a breadth of 100 in the widest part, and a height of 40 in the loftiest, with 48 feet of water beneath.

CAPRICCIO (Ital.), in Art, is applied to a picture or other work which designedly violates the ordinary rules of composition. Foliated ornaments, with Cupids or other figures appearing in them in situations not strictly natural, are capriccios.

CAPRICCIO, in Music, is a species of free composition, without being subject to rule as to form or figure. Locatelli, at the beginning of the 18th c., composed capriccios for the violin. The most celebrated C. of modern times is Mendelssohn's B minor C. for pianoforte and orchestra.

CAPRICORNUS, the *Goat*, a southern constellation, and the tenth sign of the zodiac (q. v.); denoted by the sign ♄, representing the crooked horns of a goat. It is usually represented on the globe as having the forepart of a goat, but the hinder part of a fish (see fig.). It is one of the least striking of the zodiacal constellations. It was, however,



Capricornus.

celebrated among the ancients, who regarded it as the harbinger of good-fortune, and as marking the southern tropic or winter solstice, wherefore they called it the 'Southern Gate of the Sun.' It contains no large stars, the two largest, which are situated in the horns, being only of the third magnitude. Neither of these rises above the horizon in our latitude. See **TROPIC**.

CAPRIDÆ, a family of ruminant quadrupeds, which, as defined by some naturalists, may be described as the *Sheep and Goat* family, including

the Linnæan genera *Ovis* (Sheep, q. v.) and *Capra* (Goat, q. v.); but which is extended by others to include Antelopes, their persistent horns being regarded as the great distinction between them and the *Cervidæ* or Deer family. In the more restricted sense, the name designates a very natural family, yet differing from the *Bovidæ* or Ox family more in general appearance than in other characters; whilst links of connection with the Antelopes are not wanting, a very remarkable one being found in the Prong-horn of America.

CAPRIFICATION, a method which has long been employed in the Levant for securing and hastening the maturation of figs, and which consists in suspending fruit-bearing branches of the wild fig above or beside those of the cultivated tree. The notion once entertained, that this practice is analogous to that by which the fecundation of the female palm-tree is secured, is inconsistent with the now well-known fact, that the fig has both male and female flowers within its own receptacle; and it is therefore supposed that the effects of C. may result from the agency of a species of insect, of which the eggs have been deposited in the early wild figs, and which may promote fecundation by entering the receptacle of the cultivated fig, or perhaps by puncturing it may cause it to ripen sooner. In hope of a similar advantage, some French and English cultivators have inserted into figs straws dipped in olive-oil. But C. is scarcely practised in the western parts of Europe, and has even been discontinued as unnecessary in some parts of the east where it once prevailed.

CAPRIFOLIA/CEÆ, a natural order of exogenous plants, consisting of shrubs and herbaceous plants, which have opposite leaves without stipules, and flowers disposed in corymbs, in heads, or in whorls. The calyx is 4—5-cleft; the corolla monopetalous, tubular, or wheel-shaped, sometimes irregular. The stamens are adherent to the corolla at its base, and alternate with its lobes. The ovary is free, 1—5-celled. The fruit is generally a berry, sometimes dry, but not splitting open when ripe. The order is very nearly related to *Cinchonaceæ*, differing chiefly in the want of stipules. More than 200 species are known, chiefly natives of the temperate and colder parts of the northern hemisphere. To this order belong the Honeysuckle, Elder, Viburnum, and Snowberry. Emetic and cathartic properties are prevalent in it.

CAPRIMULGIDÆ, a family of birds, of the order *Insectores*, and tribe *Fissirostres*, nearly allied to the *Hirundinidæ* or Swallow tribe, but differing from them in the still greater width of gape, and in having long stiff bristles at the base of the bill. They are insectivorous birds. They have very long wings, short legs, and toes united at the base by a membrane. The European goatsucker may be said to be the type of the family, which includes also the Whip-poor-will and Night-hawk of America, with many other species widely distributed over the globe, and now arranged by naturalists in a number of genera.

CAPSA'LI, a seaport town of the Ionian Islands, capital of Cerigo, or Cythera, is built upon a narrow ridge, terminating in a precipitous rock near the south end of the island. It has an old castle and a good harbour. Pop. 5000.

CAPSICINE, an alkaloid, is the active principle in capsicum or Cayenne pepper, and can be obtained from it. It is a thick liquid, of a reddish colour, and possessing such acrid properties, that half a grain diffused through a large room causes every one therein to sneeze violently.

CAPSICUM—CAPTAIN.

CAPSICUM, a genus of plants of the natural order *Solanaceæ*, having a wheel-shaped corolla, projecting and converging stamens, and a dry berry. The species are all of a shrubby, bushy appearance, and have more or less woody stems, although they are annual or biennial plants. The number of species is very uncertain, some botanists distinguishing many, whilst others regard them as mere varieties of a few. They are natives of the warm parts of America and of Asia, have simple leaves, and rather inconspicuous flowers, and some of them are in very general cultivation in tropical and sub-tropical countries for their fruit, which is extremely pungent and stimulant, and is employed in sauces, mixed pickles, &c., often under its Mexican name of *Chillies*; and when dried and ground, forms the spice called *Cayenne Pepper*. As a condiment, it improves the flavour of food, aids digestion, and prevents flatulence. In tropical countries, it counteracts the enervating influence of external heat. In medicine, it is used as a stimulant, rubefacient, and vesicant; is often administered in combination with cinchona; and is particularly valuable both internally administered and as a gargle, not only in relaxed conditions of the throat, but in some of those diseases in which the throat is most dangerously affected. As a medicine, C. is administered in pills mixed with bread; in the form of *tincture*, obtained by digesting the bruised C. in alcohol; or of an *infusion*, procured by digestion in water, with varying proportions of salt and vinegar. A gargle of C. is prepared by infusing it in water, along with candy-sugar and vinegar, and thereafter adding a little infusion of roses. It has no narcotic properties. It owes its power chiefly to *Capsicine* (q. v.). The fruits of the different species of C. differ in form, being round, oval, conical, heart-shaped, &c.; they vary from half an inch to four inches in length, and are sometimes of a bright red, sometimes of a yellow colour. In all, the dry berry has an inflated appearance, and contains numerous whitish flattened seeds, which are even more pungent than the leathery epidermis, or the spongy pulp. Cayenne pepper consists chiefly of the ground seeds. *C. annuum*, sometimes called Common C., or Chilly Pepper, is perhaps the most common species in cultivation; and in the southern parts of Britain, if raised on a hotbed as a tender annual, it produces fruit in the open border. There are several varieties of it. *C. frutescens*, sometimes called Goat Pepper, and *C. baccatum*, sometimes called Bird Pepper, have greater pungency, and the former is generally described as the true Cayenne Pepper. *C. cerasiforme*, with a small cherry-like fruit, and therefore called Cherry Pepper, and *C. grossum*, with a large, oblong, or ovate fruit, known as Bell Pepper, are frequently cultivated.—The fruit is used either ripe or unripe, except for making Cayenne Pepper, for which ripe fruit is employed. The fruit brought from South America is sometimes sold by druggists under the name *Guinea Pepper*.

CAPSTAN, on shipboard, is a ponderous mass of timber, whose uses are to heave the anchor, hoist up masts and guns, take in and discharge cargo, &c. It has very firm supports on the deck underneath it. It comprises a *barrel*, round which a rope or a chain coils; *whelps*, or pieces of timber, which enlarge the diameter without greatly increasing the weight; the *drum-head*, a polygonal flat piece of timber at the top, pierced laterally with holes; the *step*, or lowest part, which rests upon and is bolted to the beams; the *saucer*, an iron socket let into the top of the step; the *pivot* or *spindle*, which, resting on the saucer, forms the axis around which the C. turns; the *pawls*, short bars of iron, to prevent the re-action of the C.: *bars* which enter the

holes, and are the levers for enabling the sailors to work the C.; *pins*, placed vertically through the drum-head, for temporarily retaining the bars in their places; and the *shifter*, a rope connecting the outer ends of the bars. Many improvements have recently been made in the arrangement and action of capstans; among which is Wardill's, for increasing the bite or holding of a chain-cable around the circumference.

CAPSULE, in Botany, a dry fruit, *syncarpous* (or formed of several carpels united together into one), and opening either by valves, as in the fox-glove, primrose, and rhododendron, or by pores near the summit, which some regard as a sort of valves, and of which beautiful examples may be seen in the poppy and snapdragon. Capsules are either one-celled or many-celled. The *Pyxidium* is a variety of C., which opens as if cut around near the summit, presenting the appearance of a cup with a lid, of which a very beautiful example may be seen in the *Anagallis*, or Pimpernel; and another in the great woody fruit of the different species of *Lecythis* and other *Lecythidaceæ*.

CAPTAIN, MILITARY, is perhaps the most general designation given to an officer of land forces; something equivalent to it being found in most European languages. As a word, it simply means a *head* or *leader*, and may be applied to a chief over any number of men. *Captain-general* is in some countries a very high command. In the time of Queen Elizabeth, there was, among other high military officers, a Captain-general of footmen. In the organisation of the British army at the present day, there is one C. to every *company* of infantry, and every *troop* of cavalry, and a first and second C. to every battery of artillery. The duty of the C. is to see to the men of his company in everything that relates to discipline, exercises, billeting, pay, settlement of accounts, mess, kit, clothing, arms, ammunition, accoutrements, stores, barracks, cooking, &c.; to receive orders concerning these matters from the major, and to enforce these orders among the men. He is responsible to the major, and is assisted in his duties by the lieutenant and ensign or cornet. A C. of artillery commands more men, and has more responsibility than a C. of infantry or cavalry; he is privileged to be mentioned by name in military dispatches, like colonels and majors. The second C. of artillery used to be called C.-lieutenant. The Army Estimates for 1860—1861 provide for 149 captains of cavalry, 946 of infantry, 121 of artillery, 94 for engineers, and 94 for colonial corps—1404 in all, in full commission. On the occasions of a general promotion by brevet (see BREVET), captains become majors. The value of a C.'s commission, and the circumstances of purchase connected with it, are noticed under COMMISSIONS, ARMY.

CAPTAIN, NAVAL, is the general designation for the commander of a ship. It is not universal, for some vessels of war are commanded by officers lower in rank than C.; while the chief officer of a merchant-vessel is often called *master*. The commanders of all ships, from first-rates down to ship-rigged sloops, are captains. The captains rise to the command of larger and larger ships, with increase of pay, according to length of service. The C. is responsible for everything on shipboard, in discipline, navigation, equipment—all, in short, that concerns the *personnel* or the *matériel* of the ship. If his ship belongs to a particular fleet or naval station, he is responsible to some admiral or commodore; if not, he is directly responsible to the Admiralty. The C. of that particular ship in a fleet which carries the admiral is called *flag-C.*

and is higher in rank than others. Owing to various circumstances, the captains in the navy are very numerous. A naval officer is always on half-pay, except when attached to a ship in actual commission; and thus in times of peace there are always more naval captains on half than on full pay. The Navy Estimates for 1860—1861 provide for about 120 captains in commission on full-pay. About 600 are provided for on half-pay, under the three designations of the *active* list, the *reserved* list, and the *retired* list. The naval captains share with those of the army in the advantages of a general promotion by brevet. They rank in dignity with majors in the army, and with lieutenant-colonels after three years' service.

The word *C.* is used in other ways also in the navy. The *C. of the Fleet* is a temporary officer in large fleets; he promulgates the admiral's orders, and receives all the reports and returns, filling, in short, a post equivalent to that of *Chief of the Staff* in an army. Among the seamen on board a ship, the chief of each gang is called *C.*; such as the *C. of the after-guard*, of the forecabin, of the hold, of the main-top, of each gun, &c.

CAPTION, in the practice of the law of England, may be defined as that part of a legal instrument which shews the authority under which it is executed, or taken, as the word implies. It also states the time and place of the execution. The word *C.* is also improperly used in England to signify an arrest—a meaning which it strictly and technically bears in Scotland, where, until the passing of the 1 and 2 Vict. c. 114, called the Personal Diligence Act, which authorises more simple forms of legal process, it was the only recognised civil warrant for the apprehension of a debtor or obligee. This word is also used in Scotland to denote a summary warrant of imprisonment, granted on the application of the clerk of court, for the purpose of forcing back the pleadings and other papers in a lawsuit, which had been borrowed by the party against whom the *C.* has issued, and by whom they are unduly and illegally retained. See on the subject of this article **INDICTMENT**, **COMMISSION**, **DILIGENCE**, **WARRANT**, **HORNING**.

CAPTIVES. It is laid down by Blackstone, that, as in the goods of an enemy, so also in his person, a man may acquire a sort of qualified property in him as a captive or prisoner of war—at least till the ransom of the captive is paid. In Scotland, all legal proceedings against a captive are stopped till his liberation, although, in some cases, execution against his estate may proceed.

CAPTURE may be simply defined as prize taken in time of war. The law on this subject is stated with precision in a paper addressed on behalf of the British government to the American ambassador at London in September 1794: 'When two powers are at war, they have a right to make prizes of the ships, goods, and effects of each other, upon the high seas. Whatever is the property of the enemy, may be acquired by capture at sea; but the property of a friend cannot be taken, provided he observes his neutrality. Hence the law of nations has established—that the goods of an enemy on board the ship of a friend may be taken—that the lawful goods of a friend on board the ship of an enemy ought to be restored—that contraband goods going to the enemy, though the property of a friend, may be taken as prize; because supplying the enemy with what enables him better to carry on the war, is a departure from neutrality.' The procedure to be adopted for determining whether the *C.* be or be not lawful prize, is now regulated by the 3 and 4 Vict. c. 65.

During the Russian war in 1854, there appeared in the *London Gazette*, under date the 28th March of that year, a declaration stating, *inter alia*, that her Majesty would waive the right of seizing enemy's property laden on board a neutral vessel, unless it be contraband of war, and that it was not her Majesty's intention to issue letters of marque for the commissioning of privateers. The right of seizing enemy's property on board a neutral vessel, whether contraband of war or not, had always before been maintained by England. On the re-establishment of peace with Russia, a treaty was signed, and the following declarations adopted: 1. Privateering is and remains abolished; 2. A neutral flag covers an enemy's goods, with the exception of contraband of war; 3. Neutral goods, with the exception of contraband of war, are not liable to *C.* under an enemy's flag; 4. Blockades, in order to be binding, must be effectual—that is to say, maintained by force sufficient to prevent effectually access to the coast of the enemy.

As to the right to property captured from the enemy, and its distribution as prize or booty of war among the officers and men of the army and navy, see **BOOTY** and **PRIZE**.

CAPUA, a fortified city of Naples, in the province of Terra di Lavoro, beautifully situated in a rich plain, on the left bank of the Volturno, about 18 miles north of the city of Naples, with which it is connected by railway. It is a military station of the first class, its defences having been greatly extended and improved by Vanban. As it is the only fortress which guards the approach to Naples from the north, it is regarded as one of the keys of the country. The only objects of interest in the city are the cathedral, with some splendid granite columns from ancient *Casilinum*, upon the site of which town *C.* was built in the 9th c.; the church of the *Annunziata*, with some has-reliefs; and the arch of the *Piazza dei Giudici*, under which many ancient inscriptions are preserved. Pop. (1857) 10,000.

The ancient *Capua*, which enjoyed a reputation for wealth and population second only to Rome and Carthage, was situated about two miles south-east of the present city, where its ruins are still to be seen, its site being occupied by the modern town of Santa Maria di Capua. *C.* was founded by the Etruscans, under the name of *Volturnum*, as early, according to some authorities, as 800 B.C., and was the chief city of the twelve said to have been founded by them in this part of Italy. Its present name was derived from the Samnites, who captured it in 423 B.C. After the battle of Cannæ, 216 B.C., the popular party opened the gates to Hannibal, whose army was greatly enervated by its luxurious winter-quarters here. The Romans obtained possession of the city in 211 B.C. In the 5th c., A.D., *C.* was devastated by the Vandals under Genseric. It recovered its prosperity again to some extent, but it was totally destroyed by the Saracens in 840. The citizens, who had fled to the mountains, were induced by their bishop to return some 16 years later, and found the modern *Capua*. From the remains of the ancient *C.*, it has been estimated that it had a circumference of 5 or 6 miles, and a population of 300,000. It had seven gates. Among the Roman antiquities, one of the most remarkable is the amphitheatre, built of bricks, and faced with white marble. Well-preserved arches, corridors and seats for spectators, still remain. It is calculated to have been capable of holding 100,000 persons, and must have been altogether one of the most magnificent buildings of the kind in Italy.

CAPUCHIN MONKEY, or **CAPUCHIN** **SAPAJOU**, a name often given to *Cebus capuchinus*,

CAPUCHINS—CARACAL.

and some other species of the genus *Cebus*, South American monkeys, which have the head covered with short hair, so disposed as to resemble the cowl of a capuchin, the face being almost naked, or only covered with a little down. See **CEBUS**. *Pithecia chirotopes*, a South American monkey of a genus



Capuchin Monkey (*Pithecia chirotopes*).

allied to *Cebus*, is also sometimes called the C. M., or Capuchin of the Orinoko.

CAPUCHINS, a branch of the order of *Franciscans* (q. v.), so designated from the *capuche* which is their head-dress.

CAPUDAN-PASHA', the High Admiral of Turkey. He has the entire command of the navy, and the management of all naval affairs. The port of Pera, contiguous to the arsenal, the Turkish islands in the Archipelago, and a number of sea-ports and maritime districts, are under him, even in their civil administration.

CAPUT MO'RTUÛM VITRIOLI, or **COL-COTHAR**, is the name given by the alchemists to the red powder (mainly red oxide of iron) which remains in the retorts when green vitriol or the sulphate of iron is calcined.

CAPYBARA (*Hydrochaerus Capybara*), a quadruped of the order *Gires* or *Rodentia*, and of the



Capybara (*Hydrochaerus Capybara*).

family *Cavida*, strongly resembling the Cavy or Guinea-pig, although it is the largest existing rodent known, and aquatic in its habits. It is a native of South America, and abounds in many of the large

tropical rivers. It is equal in size to a small pig. The dentition resembles that of the cavy, except that the grinding teeth are composed of numerous transverse plates, the number of the plates increasing as the animal advances in age; an interesting point of resemblance to the dentition of the elephant, and a link of connection between the rodents and the pachydermata. The C. feeds exclusively on vegetable food, browsing on the grass near the rivers, and often committing great ravages in plantations of sugar-cane. It runs badly, but swims and dives well, and has the power of remaining under water for seven or eight minutes. It is very inoffensive, and easily tamed. The flesh, except that of old males, is good, and is eaten by all classes of persons. The C. is sometimes called *Water-hog*, of which *Hydrochaerus* is a Greek translation. In Demerara, it is called *Water-horse*, a corruption of the Dutch *Water Haas*—i. e., water-hare.

CARA'BIDÆ, a tribe of beetles, or coleopterous insects, of the section *Pentamera* (see **COLEOPTERA**), corresponding with the genus *Carabus* of Linnæus, but of which the species are extremely numerous, those already known being numbered by thousands. They mostly feed on other insects, worms, &c., and are extremely voracious and active, habits which are fully shared by their larvæ. Some of them burrow in the earth; most of them live under stones, under the bark of trees, among moss, &c.; and their bodies are adapted to this mode of life, being very firm and hard. Their legs are in general

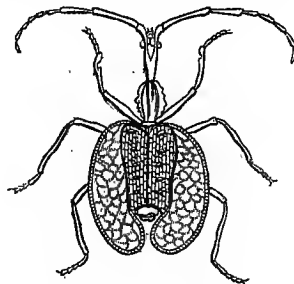

Mormolyce phyllodes.

pretty long, and most of them pursue their prey rather by the use of their legs than of their wings, some of them indeed being wingless, or having only rudimentary wings. Many of them exhibit much beauty of colours and metallic lustre. The largest British species is only about an inch long, but some foreign ones are much larger. Some of the species of the restricted genus *Carabus* are among the most common British insects. Their wings are not fitted for flight.—A very large and singular insect of the tribe C. is *Mormolyce phyllodes*, a native of Java, which, in consequence of the extremely depressed form of its body, resembles some of the *Mantida* (q. v.), and the insects known as *Leaf-insects* (q. v.). To this tribe belong also the *Bombardier Beetles* (q. v.).

CARABOU. See **REINDEER**.

CARACAL (*Felis Caracal*), a species of *Lynx* (q. v.), found in the warmer parts of Asia, and throughout the whole of Africa; and more probably than any European species, the lynx of the ancients. It is larger than a fox, about the same height, but much more powerful; of a uniform deep brown or wine-red colour, except two spots near each eye, the under parts of the body, and inner

CARACALLA—CARACCI.

parts of the legs, which are white, and tufts of long black hair which terminate the ears. The C. is powerful enough to tear a hound to pieces. It is often represented as of a very savage disposition ;

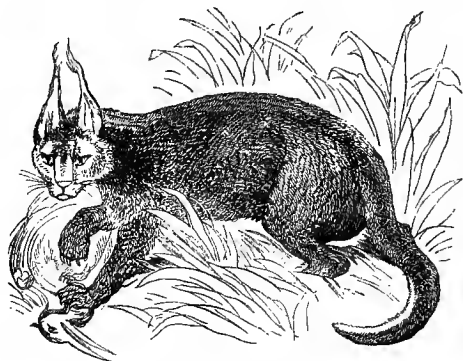

Caracal (*Felis Caracal*).

but it is capable of being tamed, and has been employed in hunting.

CARACA'LLA, properly named MARCUS AURELIUS ANTONINUS BASSILANUS, a Roman emperor, the son of the Emperor Septimius Severus, was born at Lyon, 188 A.D. He was playfully named by his father Caracalla, from his long hooded tunie, made in the fashion of the Gauls, and so called in their language. After his father's death, 211 A.D., he ascended the throne as co-regent with his brother Publius Septimius Antoninus Geta, whom he afterwards caused to be murdered. Having bribed (at enormous cost) the Prætorians to overlook this foul deed, and to make him sole emperor, C. next directed his cruelty against all the friends and adherents of Geta, of whom twenty thousand of both sexes—including the great jurist Papinianus—were put to death. Innumerable acts of oppression and robbery were employed to raise supplies for the unbounded extravagance of the despot, and to pay his soldiers. In his famous constitution, he bestowed Roman citizenship on all his free subjects not citizens—who formed the majority, especially in the provinces—but simply in order to levy a greater amount of taxes on releases and heritages, which were paid only by citizens. In his campaigns, he imitated, at one time, Alexander, at another time, Sulla; while his main object was to oppress and exhaust the provinces which had been in a great measure spared by the tyranny of former emperors. In 217 he was assassinated, at the instigation of Macrinus, prefect of the Prætorians, by one of his veterans named Martialis, on the 8th of April 217, on the way from Edessa to Carrhae. Historians paint the life of C. in the darkest colours. Among the buildings of C. in Rome, the baths—Thermæ Caracallæ—near Porta Capena were most celebrated, and their ruins are still magnificent.

CARACARA, or CARACARA EAGLE (*Polyborus*), a genus of birds of prey peculiar to America, and regarded as a connecting-link between eagles and vultures; agreeing with the former in their strongly hooked bill and claws, but with the latter in their naked face and propensity to prey on carrion. The name C. is originally Brazilian, and is derived from the peculiar hoarse cry of a common Brazilian species (*P. Braziliensis*), a bird of very fine plumage, and about 50 inches in expanse of wings, which is

of frequent occurrence over a large extent of the American continent, and is sometimes to be seen even in the southern parts of the United States.



Caracara (*Polyborus Braziliensis*).

CARA'CCAS, the capital of the republic of Venezuela, the most northerly state in South America, with Guiana on the E., and New Granada on the W., is situated in lat. 10° 30' N., and long. 67° 5' W., 16 miles to the south of La Guayra, its port on the Caribbean Sea. It is 2880 feet above the tide-level, enjoying from this elevation a healthy air and a temperature so moderate as to average 68° and 72° F. in February and June respectively. Standing immediately above the confluence of four streams, it is well supplied with cool water, which is distributed by means of fountains, pipes, and reservoirs. The neighbourhood is subject to earthquakes—12,000 citizens having, in 1812, perished from this cause. The present population is estimated at about 40,000. The streets are straight and regular. The most splendid edifice in the city is the Church of Alta Gracia for the people of colour, excelling even the cathedral in the richness of its decorations.

CARACCAS, the province of which the foregoing city is the capital, extends in N. lat. from 7° 38' to 10° 46', and in W. long. from 65° 30' to 68°, and contains about 250,000 inhabitants. With a generally mountainous interior, the immediate coast is flat, presenting, besides La Guayra above mentioned, several harbours or roadsteads. The exports of the province are cocoa, coffee, dye-woods, hides, indigo, and sarsaparilla.

CARA'CCI, a celebrated family of Italian painters, the founders of the Bolognese school of painting.

CARACCI, LUDOVICO, the son of a butcher, was born at Bologna, 1555. As a student, he was so inapt that his master recommended him to abandon the pursuit; but instead of that, he went to Venice and Parma, making acquaintance with the works of the great masters there, and returned to Bologna imbued with art principles quite opposed to the superficial mannerism then prevailing in his native city. In conjunction with two of his cousins, who, instructed by him, had imbibed the same ideas, he founded, in spite of great opposition, the school which afterwards became so famous in the history of painting. The first principle of this new school was, that 'observation of nature ought to be combined with imitation of the best masters.' The allied artists found numerous pupils, to whom they gave practical instructions in drawing from natural and artistic models, with theoretical lessons on perspective, anatomy, &c. So great was their success,

that, in the course of a short time, all other schools of painting were closed in Bologna. Some of the finest works of this master are preserved in the *Accademia delle Belle Arte*, Bologna—among others, the 'Madonna and Child Throned,' 'Madonna and Child Standing,' the 'Transfiguration,' and the 'Nativity of St John the Baptist.' Ludovico died in 1619.

CARACCI, AGOSTINO, cousin of Ludovico, was born (1558) in Bologna. He became a disciple of his cousin, but he was of too versatile a genius to devote himself closely to any subject, though his magnificent painting of the 'Communion of St Jerome' proves that he might have attained to very great eminence, had he devoted his undivided attention to the art; but he was in the habit of abandoning his easel for literature, poetry, and engraving on copper. As an engraver, indeed, he holds an important position in Italian art. He accompanied his younger brother, Annibale, to Rome, and there assisted in some of the paintings in the Farnese Gallery; but his brother, who was a slave to his art, soon quarrelled with him for his inattention, and he left Rome, and went to Parma. He died in 1602.

CARACCI, ANNIBALE, brother of Agostino, was born (1560) in Bologna, where he learned, under his father, the business of a tailor, from which he was called away by Ludovico Caracci. His progress in the study of painting was rapid, and at first he took principally for his models Correggio, Titian, and Paul Veronese. His picture of 'St Roche distributing Alms' first gained for Annibale C. a wide reputation. His fame reached Rome, and he was employed to paint the Farnese Gallery there, which is considered his greatest work, and the manner of which partakes somewhat of Raphael and Correggio. On this gallery he was employed some eight years, and he received for his work the incredibly paltry sum of 500 crowns. In disgust and vexation, the artist threw aside his pallet. He died in Rome in 1609, where his remains were interred, close to Raphael's tomb, in the Pantheon. Annibale C. was one of the greatest followers of Correggio, and in composition approached most nearly to the style of Raphael. Ludovico had a greater talent in teaching, and Agostino had a more versatile invention, but Annibale was unquestionably the greatest artist of the three Caracci.

CARACCI, ANTONIO, natural son of Agostino, was born at Venice 1583, died in 1618. He was a pupil under Annibale, and painted some excellent pictures.

CARACCI, FRANCESCO (styled FRANCESCHINI), brother of Agostino and Annibale, was born in 1595, and distinguished himself as an eminent designer. He died 1622.—The best Italian masters of the 17th c.—Domenichino, Guido Reni, Albani, and others—proceeded from the school of the Caracci.

CARACCIOLI. The name of a Neapolitan family unfortunately associated with the memory of Lord Nelson. Several members of this family were employed in political offices.—LOUIS ANTOINE DE C., born in Paris 1721, died 1803, was the author of a pseudograph, entitled *Lettres Intéressantes du Pape Clement XIV.*, which mystified many readers throughout Europe.—FRANCESCO C., a meritorious Neapolitan admiral, entered in early life the marine service, and distinguished himself at Toulon, 1793. In the year 1798, the offensive conduct of the court of Naples toward C. induced him to return from Palermo, where the court was then residing, to Naples, where he entered into the service of the republic established by the French invaders, and, with a few vessels, prevented the attempted landing of a Sicilian and British fleet. In 1799, when Ruffo took Naples, C. was arrested, contrary to the

terms of capitulation, sentenced to death by the junta, hanged on the mast of a frigate, and his corpse thrown into the sea. This affair, to which Lord Nelson was a consenting party, is a stain on the reputation of the English admiral.

CARACTACUS, a king of the Silures, who inhabited South Wales, was one of the most persistent enemies of the Romans in Britain. For nine years he warred gallantly against the invaders, but at length was completely overthrown. His wife and daughters fell into the hands of the victors, and his brothers surrendered. C. himself fled to Cartimandua, queen of the Brigantes, who delivered him up to the Romans. He was carried to Rome, 51 A.D., and exhibited to the people by the Emperor Claudius. When he approached the imperial seat, we are told, he addressed Claudius in so noble a manner, that he and his relatives were immediately pardoned. They appear, however, to have lived during the remainder of their lives in Italy.

CARADOC SANDSTONE AND BALA BEDS, a division of the Lower Silurian System, so named from their development at Caer Caradoc, in Shropshire. They consist of sandstones, grits, and slates, with occasional beds of limestone. Enormous masses of contemporaneous igneous rocks are interstratified with them. They attain a thickness of 9000 feet, not including the igneous rocks. Fossils are very abundant in some beds. They consist chiefly of Trilobites (q. v.), Brachiopoda (q. v.), and Graptolites (q. v.).

The Silurian rocks in the southern districts of Ayrshire belong to this division.

CARAGLIO, a town of the Sardinian states, in the province of Coni, six miles west of the city of that name. It is situated on the Grana, and has manufactures of silk. Pop. 6268.

CARAMANIA. See KARAMAN.

CARAMBOLA, an East Indian fruit, of the size and shape of a duck's egg, but with five acute angles, or longitudinal ribs. It has a yellow, thin, smooth rind, and a clear watery pulp, in some varieties sweet, in others acid, of very agreeable flavour. It is often used in making sherbets, and in tarts and preserves; and is known to the British in India as the *Covromandel Gooseberry*. It is one of the most universally cultivated and abundant of the fruits of India. It is produced by the *Averrhoa Carambola*, a small evergreen tree, or bush, of the natural order *Oxalidaceae*. The BILIMBI, or BLIMBING, is the very acid fruit of another species of the same genus, *A. Bilimbi*, also East Indian. Both species are now much cultivated in the tropical parts of America. Both exhibit an irritability of leaf resembling that of the sensitive plant; they also display in a remarkable degree the phenomena known to physiologists as those of Sleep (q. v.) in plants.

CARAMEL is the name applied to the dark brown and nearly tasteless substance produced on the application of heat to sugar (q. v.). It is likewise formed during the roasting of all materials containing sugar, such as coffee, chicory, and malt (see BEER), and is one cause of the dark colour of porter and infusions of coffee. It is also employed in the colouring of whisky, wines, vinegar, &c.

CARAMNASSA, a river in the sub-presidency of Bengal, which rises in lat. 24° 34' N., and long. 83° 46' E., and, after a course of about 150 miles, enters the Ganges from the right in lat. 25° 28' N., and long. 83° 58' E. It is remarkable on several grounds. Though, on issuing from its

source, it is clear as crystal, it is yet said to be both nauseous and noxious—a peculiarity which the natives impute to various supernatural causes; about 50 miles from its mouth, it is crossed by a stone bridge of three wide arches, which forms part of the grand road from Calcutta to Delhi; and lastly, it is so exceptionally subject to floods, that it has been known to rise 25 feet in a night, when scarcely any rain had fallen in the adjacent plain of the Ganges itself.

CARANA RESIN, more commonly, but less correctly, called GUM CARANA, is a resinous substance imported from the tropical parts of America. Its properties and uses resemble those of taca-mahac. It is entirely soluble in alcohol, and melts in a slight heat. It is not well known what tree produces it.

CARANJA, an island on the east side of the ordinary entrance of the harbour of Bombay (q. v.), separated from the mainland by a narrow and unserviceable channel of four miles in length. It is itself two miles broad, being comparatively level and fertile, with the exception of two hills—the Little Hill in the north, and the Great in the south.

CARANX. See SCAD.

CARAPA, a genus of plants of the natural order *Meliacea*, natives of warm climates. *C. Guianensis*, or *guareoides*, sometimes called the Anderaba, also the *C. tree*, is a large tree with beautiful shining pinnate leaves, which have many leaflets, a native of Guiana and the adjacent countries, where its bark has a great reputation as a febrifuge, and the oil obtained from its seeds is much used for lamps. Masts of ships are made of its trunk. The oil, which is called Oil of Carapa, is thick and bitter, and is anthelmintic.—*C. Touloucouna*, or *Guineensis*, an African species, yields a similar oil, which is employed by the negroes for making soap, and for anointing their bodies, its bitterness protecting them from the bites of insects, a purpose to which the Oil of *C.* is also applied in South America.—These species are very similar, and are supposed by some botanists not to be essentially distinct.

CARAPACE, the dorsal shield or buckler of chelomian reptiles (Tortoises and Turtles), and of the *Crustacea Malacostraca* (Crabs, Lobsters, &c.). In animals so widely different, however, there is only a general similarity in the appearance of the *C.*, and the purpose which it serves; its organic relations are very different. For notice of these, we refer to the articles CHELONIA and CRUSTACEA.

CARAT, originally, it would seem, the name given to the seeds of the Abyssinian Coral Flower (q. v.) or Coral-tree (*Erythrina Abyssinica*); but these, which are small, and very equal in size, having been used in weighing gold and precious stones, *C.* has become the designation of the weight commonly used for weighing precious stones, and particularly diamonds. The seeds of the Carob (q. v.) tree have also been said to be the original *C.* weights of jewellers, but with less probability.

Goldsmiths and assayers divide the troy pound, ounce, or any other weight, into 24 parts, and call each a *C.*, as a means of stating the proportion of pure gold contained in any alloy of gold with other metals. Thus, the gold of our coinage and of wedding-rings, which contains $\frac{22}{24}$ of pure gold, is called '22 carats fine,' or 22 *C.* gold. The lower standard used for watch-cases, &c., which contains $\frac{18}{24}$ of pure gold, is called 18 *C.*, and so on. The *C.* used in this sense has therefore no absolute weight; it merely denotes a ratio. This, however, is not the case with the *C.* used for weighing diamonds, which has a fixed weight, equal to $3\frac{1}{2}$ troy grains, and is

divided into quarters, or 'C. grains,' eighths, sixteenths, thirty-seconds, and sixty-fourths. These *C.* grains are thus less than troy grains, and therefore the jeweller has to keep a separate set of diamond weights.

CARAVACA, a town of Spain, in the province of Murcia, about 39 miles north-west of the city of that name, is situated on the slope of a hill crowned with a fine old castle. Its principal streets are wide, clean, and well paved; it has a fine church, with a miraculous cross, that is annually taken down and bathed in the waters of the town, to which it is supposed to communicate sanitary properties. It has manufactures of linen and woollen fabrics, soap, paper, leather, &c. Pop. about 10,000.

CARAVAGGIO, a town of Lombardy, Northern Italy, about 24 miles east of Milan. In the principal church are some esteemed paintings by Campi; and *C.* is also celebrated as the birthplace of the painters, Polidoro Caldara and Michael Angelo Merighi, both surnamed Caravaggio. In the neighbourhood is a sanctuary of the Madonna, built from designs of Pellegrini (1575). Pop. 6200.

CARAVAGGIO, MICHAEL ANGELO AMERIGHI or MERIGHI DA, a celebrated Italian painter, was born 1569, at Caravaggio in Lombardy, Northern Italy. His father, who was a mason, employed him in making paste for the fresco-painters, and in this way the artistic genius of the boy was stirred. After studying the works of the great masters in Milan and Venice, he went to Rome, where he lived for some time in very reduced circumstances. At length, a picture of his attracted the notice of Cardinal del Monte, who now patronised the young artist; but the ferocious and quarrelsome character of *C.* soon involved him in difficulties. Having fled from Rome to Malta, on account of manslaughter, he obtained the favour of the grand-master by painting an altar-piece in the church of St John, and other pictures. His quarrelsome nature soon forced him to flee from Malta; and in making his way back to Rome, he was wounded, lost all his baggage, caught a violent fever, and on reaching Porto Ercole, lay down on a bank and died (1609), at the age of 40. Truthness to nature was the object aimed at by *C.*, who left all schools, and devoted himself to paint life as he found it in lanes, alleys, and other resorts of the lower classes. He studied no such matters as refined sentiment or elevation of realities, but gave in his paintings expression to his own wild and gloomy character. One of his best paintings, 'The Fraudulent Gamblers,' is preserved in the Sciarra Gallery, at Rome. His shadows are deep, his backgrounds very obscure; in consequence of which the whole picture seems to possess a kind of mysterious greatness, that is very imposing. Even Rubens confessed that *C.* was his superior in chiaro-oscuro. When he painted on sacred subjects, he remained falsely faithful to the low realities of Italian life; so that several of his pictures painted for churches, had to be removed from their places, because they could not be harmonised with sacred associations. Kugler, the German critic, has justly said of one of *C.*'s most celebrated works, a 'Burial of Christ,' that it appears 'like nothing better than the funeral of a gipsy-chieftain.'—An earlier Italian painter of less eminence, POLIDORO CALDARA DA CARAVAGGIO, was born in 1495, and murdered in 1543.

CARAVAN (from the Persian *karvan*, i. e., trader), the name given to the great assemblages of travellers which, at stated times, traverse the deserts of Asia and Africa. Many caravans are entirely for the purposes of trade, the merchants associating themselves for mutual help and protection. A *C.*

CARAVANCES—CARBAZOTIC ACID.

sometimes has so many as 1000 camels, which follow each other in single file, so that it may be a mile or more in length. The most celebrated caravans are those formed by pilgrims going to Mecca, particularly those which annually assemble at Cairo and at

Damascus. The latter consists of 30,000 to 50,000 pilgrims, and is under the special protection of the Turkish sultan. The trade between Tripoli and the interior of Africa is exclusively carried on by caravans, also that between Darfur and Egypt.



Caravan.

CARAVANCES. See CHICK PEA.

CARAVANSARAI, or KHAN, an eastern institution, a sort of unfurnished inn to provide travellers with a shelter. Those in towns and cities, which are generally built for traders, and charged a small sum a day, are handsomer and more convenient—having doors to the apartments—than those met with on the roads or outside the walls of the cities. They commonly consist of a square building of four wings built round a courtyard, in which the beasts of burden may be enclosed, and where there is usually a well of water; the lodgings are small rooms, about 7 or 8 feet high, which run round the courtyard, and are bare of every article of furniture.

These caravansarais are an institution of very ancient date, being the 'inns' of Gen. xlii. 27, xliii. 21; and it was in the stable of such a place, there being no room for his parents in the lodging apartments, that our Saviour was born (Luke ii. 7). They belong either to government, to some private individual, or are the property of the church (mosques); those situated in towns or cities are charged, but not more than two or three Turkish piastres a day; those situated on the road are usually free. There are some large and very handsome caravansarais at Cairo, Damascus, Beyrout, Aleppo, &c.

CARAWAY (*Carum carui*), a plant of the natural order *Umbelliferae*, growing abundantly in meadows and rich pastures in the middle and south of Europe, and in some parts of Asia, naturalised in many places in Britain. In some parts of Holland and Germany, and also in the counties of Kent and Essex in England, it is extensively cultivated for its aromatic seeds—in more strict botanical language, *carpels*—which are used medicinally as a carminative and tonic, and are also very much used as an aromatic condiment; and by confectioners, distillers, and perfumers, entering into the preparation of liqueurs, cakes, sweetmeats, scented soaps, &c. They depend for their aromatic properties on a volatile oil called Oil of C., which is obtained by bruising C. seeds, and distilling them with water, and is at first limpid and colourless, but becomes yellow, and subsequently brown by keeping. Oil of C. is used medicinally to relieve flatulence, and to correct the nauseating and griping tendencies of some cathartic medicines; also in the preparation of *Spirit of C.*, and *C. Water*.—*Spirit of C.*, which may be prepared either by dissolving the oil of C. in proof-spirit, or by distilling bruised C. seeds along with proof-spirit, is much used in Russia and Germany as a liqueur (*Kümmel-branntwein*), sweetened with sugar.—C. has a branching stem 1–2 feet high, with finely divided leaves, and dense umbels of whitish flowers. The fruit is oblong; each carpel having five thread-like

ribs, with a single *vitta* (see *UMBELLIFERÆ*) in each of the interstices. The white carrot-shaped root of C. is sometimes used like carrots or parsnips, but has a very strong flavour.—C. has a great



Caraway.

enemy in the CARAWAY MOTH (*Hæmylis dancella*), the larva of which destroys both its stem and flowers.

CARBAZOTIC ACID, or PICRIC ACID, is a substance of great importance in dyeing, which is obtained by the action of strong nitric acid and heat on many complex organic materials, such as silk, indigo, salicine, and a variety of resins. On a commercial scale, it is best obtained from the oil of tar, which distils over from crude tar between 300° and 400°, or from the resin of *Xanthorrhoea hastilis*. The hot nitric acid solution is strained from impurities, and on cooling, yellow crystals separate of C. A., which can be purified by washing with cold water. These crystals are readily soluble in alcohol and ether, and dissolve in 80 or 90 times their weight of cold water, yielding a yellow solution, which has a very bitter taste, and stains the skin yellow; and when silk which has been treated with a mordant of alum, or cream of tartar, is immersed in a solution of C. A., it is dyed of a beautiful permanent yellow colour. The bitter taste of C. A. has led to its being fraudulently employed,

CARBINE—CARBON.

instead of hops, in communicating a bitter taste to beer.

CARBINE is a light kind of musket, named probably from the Carabins. See next article. It is now used by the cavalry, the yeomanry cavalry, the Irish constabulary, and other corps. The best carbines are now rifled. A considerable number of American carbines, rifled and breech-loading, were purchased at a high price by the English government in 1856. This American C. has a barrel only 22 inches in length, and a total weight of $7\frac{1}{2}$ lbs. It is simple in construction, has a great range, hits a mark with accuracy, may be fired with rapidity, requires little cleaning, can be loaded without a ramrod, and supplies itself with caps from a reservoir in the hammer. Among English makers, Mr Prince has successfully applied the breech-loading principle to carbines. The new Victoria Cavalry C. has a barrel 26 inches long, with 0.733 inch bore; its weight is $7\frac{1}{2}$ lbs., and it is fired with $2\frac{1}{2}$ drachms of powder.

CARBINEERS, or **CARABINEERS**, are said to have derived their designation from the Arabs, among whom the *Carabins* or *Karabins* were light horsemen, stationed at outposts to harass the enemy, defend narrow passes, &c.; in action, they took the place of skirmishers. A corps under the same name was raised in France in 1560; but the designation has not been much used in that country since the introduction of Hussars and Lancers. In the English army, C. was at one time a frequent designation for cavalry; but now there is only one regiment, the 6th Dragoon Guards, known by this title; and the distinction between them and other cavalry is little more than nominal.

CARBOHYDROGENS, or **HYDROCARBONS**, are a series of compounds belonging to organic chemistry, which are composed of carbon and hydrogen, in such proportions that the various members of the group differ from each other in definite and regular numbers of atoms of carbon and hydrogen. The best marked group of hydrocarbons commences with Methylene (C_2H_2), which may be regarded as the first step in the ladder, and by the successive addition of other two atoms of carbon and hydrogen, we obtain Ethylene or Olefiant Gas (C_4H_4), Propylene (C_6H_6), Butylene or Oil Gas (C_8H_8), Amylene ($C_{10}H_{10}$), &c. There are also series beginning with Methyl (C_1H_3), then Ethyl (C_2H_5), and with Hydride of Methyl or Marsh Gas (C_2H_4), then Hydride of Ethyl (C_4H_6). The members of these groups are likewise characterised by a gradual ascending difference in their chemical and physical properties, especially the boiling-point, which rises by a given amount.

CARBOLIC ACID, or **PHENIC ACID** (HO, C_6H_5O), is the principal acid substance procured during the destructive distillation of coal. It is produced also by the distillation of gum benzoin and the resin of *Xanthorrhæa hastilis*, and is present in the urine of the cow and some other animals. It is a liquid with a hot burning taste, and its principal property of popular interest is its antiseptic power, in which it rivals creosote; and indeed the greater part of the preserving power which coal-tar and the oils derived from it exhibit, when wood is saturated with them, is due to the C. A. present. It is proposed to use it for purifying the streams which flow through towns, and rendering the sewerage (q. v.) inoffensive.

CARBON is one of the elementary substances largely diffused in nature. It occurs uncombined in the mineral graphite or black-lead (q. v.), and in the diamond (q. v.), which is pure crystallised

carbon. It is much more abundant, however, in a state of combination. United with oxygen, it occurs as carbonic acid (CO_2) (q. v.) in the atmosphere, in natural waters, in limestone, dolomite, and iron-stone. In coal, it is found combined with hydrogen and oxygen; and in plants and animals, it occurs as one of the elements building up wood, starch, gum, sugar, oil, bone (gelatine), and flesh (fibrine). Indeed, there is no other element which is so characteristic of plant and animal organisms, and it ranks as the only element never absent in substances obtained from the two kingdoms of organic nature. Wood-charcoal, coke, lampblack, and animal charcoal, are artificial varieties, more or less impure, of carbon.

The atomic weight or equivalent of C. is 6; the specific gravity greatly varies; that of the diamond is 3.330 to 3.550 (water being 1.000), and of graphite 1.800. C., in its ordinary forms, is a good conductor of electricity; in the form of diamond, it is a non-conductor. Of heat, the lighter varieties of C., such as wood-charcoal, are very bad conductors; graphite in mass has very considerable conducting powers. At ordinary temperatures, all the varieties of C. are extremely unalterable; so much so, that it is customary to char the ends of piles of wood which are to be driven into the ground, so as by this coating of non-decaying C. to preserve the interior wood; and with a similar object, the interior of casks and other wooden vessels intended to hold water during sea-voyages, are charred (coated with C.), to keep the wood from passing into decay, and thereby to preserve the water *sweet*. Its power of arresting odours and colours likewise varies much. See **BONE-BLACK**. In the simple property, even of combustion, there is a marked difference. Wood-charcoal takes fire with the greatest readiness, bone-black less so; then follow in order of difficulty of combustion—coke, anthracite, lampblack, black-lead, and the diamond. Indeed, black-lead is so non-combustible, that crucibles to withstand very high heats for prolonged periods without breakage or burning, are made of black-lead; and the diamond (q. v.) completely resists all ordinary modes of setting fire to it. In the property of hardness, how soft and velvet-like does lampblack feel to the touch, and yet how hard is that diamond which cuts glass, and is the hardest of all gems, and indeed of all things!

Carbon for electrical purposes.—When C. is obtained of sufficient density, it is found to be a good conductor of electricity, and to make an excellent electro-negative element in a galvanic pair. Graphite displays these qualities to advantage, and so does the hard incrustation of C. that is found sublimed in gas retorts. Coke and wood-charcoal are too porous to possess them to any great extent. The scarcity of graphite, and the precarious supply of retort-C., preclude the possibility of obtaining much practical advantage from the electrical properties of C. with these substances alone. We are indebted, however, to Professor Bunsen of Heidelberg for the discovery of a process whereby a C. of the requisite density can be manufactured with great ease and economy. The carbons thus obtained for galvanic batteries rival platinum in electric energy, and they have aided in no small degree, from their cheapness, in heightening the utility of galvanic electricity. The Bunsen carbons, as manufactured in Germany, are of the form of hollow cylinders, whereas those made in France and this country are solid rectangular prisms. The following are the more important details of the process. Two parts of coke, and one of baking coal—the proportion varying to some extent with the materials—are ground to a fine powder, and passed

CARBONARI—CARBONIC ACID.

through a sieve. The powder so got is transferred to iron-plats moulds of the required shape, the seams of which are merely clasped together, and luted with clay. No pressure is employed in filling them, other than that of shaking. When the moulds are filled, they are placed in a furnace, and kept there till all carburetted hydrogen has escaped from them. They are then taken out, and allowed to cool before the mass within is removed, which is now found to have taken a solid form, and to be so hard that it may be turned or ground to the exact size wanted. At this stage, the carbons are destitute of electrical action, and they must consequently be rendered more dense by a subsequent process. This consists in soaking them thoroughly in thick sirup, or, better still, in gas-tar thickened by boiling, and laying them aside till dry, after which they are packed with charcoal-dust in fire-proof crucibles, and exposed for a considerable time to a high heat. If one soaking and charring is not enough, the same may be repeated until sufficient density is obtained. Throughout the process, it is essential that all flaming matters be driven off, so as to leave only the C. in the mould; and care must be taken that no air be admitted to the mould when under the action of heat, otherwise there would be a loss of C. from combustion. The manufacture of these carbons may be carried on contemporaneously with that of gas. The sticks of C. used for the electric light are obtained by sawing up either C. made by this process or the C. of the gas retorts.

CARBONARI (literally, 'coiliers' or 'charcoal-burners'), the name of a secret political society, first, in some degree, made known in 1820. The constitution, like the precise objects of the C., still remains in a great measure secret; though they have printed instructions, catechisms, statutes, rituals, &c., for their associates. The statements respecting the high antiquity of this secret confederacy are quite fabulous. There is every reason to believe that it originated during the last French régime in Naples. Botta, in his *Storia d'Italia*, states that, under Murat's government, the Neapolitan republicans, equally hating the French and King Ferdinand, escaped into the wild defiles of the Abruzzi, and here, naming themselves 'C.,' formed a secret society. It is said that their leader, Capobianco, had great powers of popular eloquence, and that their motto or war-cry was, 'Vengeance for the lamb torn by the wolf!'

The peculiar phraseology of the C. is taken from the vocation of charcoal-burners. For instance, they are (or were) wont to speak of 'clearing the forest of wolves.' The 'wolves,' probably meant at first foreign tyrants; but in the course of time, after the restoration of the Neapolitan Bourbons, such symbolical expressions had reference to their despicable misrule. Among themselves, the initiated were styled 'good cousins.' The various societies do not seem to have possessed a common centre, or to have been properly organised for combined action. A place of meeting was styled 'a hut' (*baracca*); the external neighbourhood, 'the forest;' and the interior of the hut was the *vendita* or 'place for selling coal.' A union of several of these huts formed a 'republic.' The superior huts (*alte vendite*) at Naples and Salerno endeavoured, but without success, to effect a centralisation of the Carbonari. The society, soon after its institution, numbered 24,000—30,000 adherents, and increased so rapidly in Italy that, in March 1820, it is said as many as 650,000 new members were initiated, including considerable numbers of the military and the clergy. The religious and Protestant character of the order is expressed in its statutes, which include the article: 'That every Carbonaro has the natural

and unalterable right of worshipping God according to his own convictions.' Though Carbonarism did not arise from the lodges of freemasons (as several have supposed), it has borrowed many forms of masonry.

After the restoration of the Bourbons, several secret political unions were formed in France, and in 1820 were confederated with the Carbonari. Paris, after the prosecutions against the secret societies of Italy, was made the head-quarters of a Carbonarism which, adopting all the symbolic phraseology, rules, and regulations of the Italian societies, received from the rapidly systematising genius of the French, an organic character which it had never before possessed. The initiated styled themselves *bons cousins*, and spoke of the uninitiated as *pagans* (heathens). Written documents and communications were strictly prohibited by the heads of the union, and treachery was to be punished by assassination. After the close of the French and Spanish war, the C., whose activity in contriving plots had excited the terror of the French prefects, restricted its endeavours to the circulation of republican ideas, without direct attempts towards insurrection. After the July revolution, several of the leading French C. attached themselves to the new régime, and their society was gradually dissolved. In its place the new *Charbonnerie Démocratique* was founded, having for its object the establishment of a republican government, founded on the principles of Babeuf (q. v.). The endeavour of these new C. to make Paris the centre of all political movements, led to the secession of the Italian refugees, who associated themselves under the title 'Young Italy.' French Carbonarism is not known to exist at present, and it is possible that even in Italy the triumphs of constitutional patriotism during the last year have rendered its existence no longer necessary, but it certainly was alive at the commencement of the late Franco-Sardinian war with Austria; and one of the rumours of the time was, that the French Emperor—who, in his young republican days, had been a member of this society—had entered on the war of liberation, to conciliate his old associates, who had menaced him with the fate of a traitor.

CARBONATED or **ACIDULOUS WATERS** are those which contain a great excess of carbonic acid gas. The amount of gas in ordinary spring and well waters does not amount to more than 3—8 cubic inches in 100 cubic inches of the water; but in waters entitled to be called C., the proportion of gas to 100 cubic inches of water rises 30—60, when they are considered rich; 100—200, when they are very rich; and in the waters of St Nectaire it is said that the proportion of gas is as high as 400 volumes to 100 of the water. These waters sparkle much when poured from one vessel to another. The carbonic acid is free, but is generally accompanied (1) by bi-carbonate of soda, when the water is called *carbonated-alkaline* or *acidulo-alkaline*, as in the Seltzer, Pyrmont, Salzbrunn, Altwasser, and Reincrz acidulous mineral springs; or (2) by carbonate of iron, when the water is named *carbonated* or *acidulous chalybeate*. See **CHALYBEATE WATERS**. The mineral spring at Irkeston, near Nottingham, is the only water of this nature in Britain. The C. or A. W. are very refreshing and exhilarating, and are useful in certain disordered states of the stomach; they relieve nausea, and generally increase the discharge of liquid from the system. They are objectionable in the case of persons of a full and inflammatory state of body.

CARBONIC ACID, FIXED AIR, or CHOKE-DAMP, is a substance occurring free as a gas in

CARBONIC ACID—CARBONIC OXIDE.

the atmosphere, to the extent of 1 volume to 2500

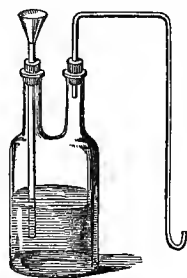

of air, and also in combination with a variety of substances. It is most easily prepared for experimental purposes from chips of marble, water, and hydrochloric acid, which are placed in a gas bottle with tubes (see fig.). The hydrochloric acid (HCl) acts on the marble (CaO, CO_2), and forms chloride of calcium (CaCl), water (HO), and carbonic acid (CO_2), which escapes as gas with effervescence, and may be conducted by a proper tube under the mouths of jars filled with water and placed on a pneumatic trough. Where C. A. is required in large quantities, it is prepared in a leaden vessel from chalk (CaO, CO_2) and sulphuric acid (SO_3) diluted with water, when sulphate of lime (CaO, SO_3) is formed, and C. A. escapes as gas.

The atomic weight or equivalent of C. A. is 22; it is a clear, colourless gas, with a pleasant, acidulous smell and taste. Under great pressure and cold, it can be condensed into a liquid, and even a solid resembling snow in appearance. Under ordinary atmospheric pressure, C. A. dissolves in water to the extent of 2 volumes of gas in 3 of water; but under increased pressure, a very much larger amount of gas is taken up by the water, and in this way the various kinds of **AERATED WATERS** (q. v.) are prepared. The gas is more than half as heavy again as ordinary air, being 1529. It is incombustible, and a non-supporter of combustion, at once extinguishing a lighted candle, gas jet, or even a piece of burning phosphorus, when these are placed in a jar filled with the gas, or even in a mixture of C. A. and air. This power of putting out flame and fire has been turned to account in the extinguishing of burning coal-mines, where, all the openings to the mine being properly secured, C. A., in the form of the spent air from an ordinary coal-furnace, has been passed into the mine, with the result of successfully stopping the fire. It is irrespirable in a concentrated form, producing spasm of the glottis, which prevents the admission of the gas into the system; and when mixed with air, it can be breathed without suspicion, and then acts as a narcotic poison, even when present only to the extent of 4 or 5 per cent. of the air. The deadly effects of C. A. are observed, in the combustion of charcoal, coal, or *coal-gas*, in chaffers, furnaces, or in fireplaces with the dampers down, when the deadly fumes of C. A. steal more or less quickly over the inmates of the room, and they almost unconsciously become its victims—thus unknowingly following the course of the Parisian suicide, who purposely lights a charcoal fire in the centre of his room, and prepares for death; and in overcrowded rooms where the C. A., exhaled from the lungs of each inmate at every breath, poisons the air of the apartment, and day by day slowly but surely robs the robust of health, and ultimately of life. In such cases as the Black Hole of Calcutta (q. v.), where there was scarcely any outlet for the poisonous gas, only a few hours may be required to complete the catastrophe.

Though poisonous when inhaled by the lungs, C. A. is rather refreshing when taken into the stomach. Thus, aerated beverages of all kinds—beer, champagne, and carbonated mineral waters—owe their refreshing and invigorating qualities to the presence of C. A.; and if the gas be allowed to escape, they become almost tasteless, stale, and mawkish.

Besides abounding everywhere in the atmosphere, C. A. is largely evolved from fissures in the earth, especially in volcanic districts. In the *poison* or *Upas valley* of Java, which is a valley of an oval form, about $\frac{3}{4}$ of a mile in circumference, and 30 to 35 feet deep, the carbonic rises to a height of about 18 feet from the surface, and the whole bottom of the valley is devoid of vegetable and animal life, and is strewn here and there with the bleached bones of man and other animals that have unluckily stepped within the deadly circle. A dog thrown in, dies in 14 seconds; and birds attempting to fly across the valley, instantly drop down dead. In the neighbourhood of the lake of Laach, in Rhenish Prussia, the amount of C. A. evolved every day has been estimated at 600,000 lbs. weight. In a state of combination, C. A. forms an ingredient in a great number of minerals called *carbonates*, such as chalk, limestone of various kinds (CaO, CO_2), black-band iron-stone (carbonate of iron, FeO, CO_2), malachite (carbonate of copper, $\text{CuO}, \text{HO}, + \text{CuO}, \text{CO}_2$), &c. C. A. is the principal product of combustion; the carbon of the burning substance (coal, candle, coal-gas, wood, paper, &c.) uniting with the oxygen of the atmosphere, and forming C. A. (CO_2). It is also a product of respiration (q. v.), and is evolved more or less largely by all animals, not only by the mouth, but in exhalations from the skin, and is present in blood, urine, &c. It is evolved during the fermentation (q. v.) of beer, wine, &c., and often remains in brewers' vats when the liquor has been drawn off. During the decay of vegetable and animal matters, C. A. is produced, and in explosions of fire-damp in coal mines, it is formed in large quantity, and fills the underground passages.

C. A. forms the largest ingredient in the food of vegetables, and is therefore abstracted in large quantity from the air by plants. It enters into combination with the majority of the oxides of the metals and other compounds, to form a class of salts called *carbonates*, several of which have been referred to. C. A. when present in a vessel in quantity may be recognised by the power of extinguishing a lighted candle, or by not burning itself. C. A. in the form of gas may be readily recognised in the atmosphere by exposing a little lime-water in a saucer, or other shallow vessel, when the lime (CaO) abstracts the C. A. (CO_2) from the air, a white film of carbonate of lime or chalk (CaO, CO_2) is formed on the surface of the liquid. A solution of Baryta (q. v.) in water is more delicate in its action on the C. A. of the air, and more readily indicates its presence.

CARBONIC OXIDE is a compound of one atom of carbon and one atom of oxygen, is represented by the symbol CO, and has the atomic weight 16. It does not occur naturally, but may be observed burning with a pale-blue flame in fireplaces and stoves, especially in frosty weather. During the combustion of the fuel at the lower part of the grate, the oxygen of the air unites with the carbon of the fuel to form carbonic acid (CO_2); and this gas rising up through red-hot coal or carbon (C), has part of its oxygen abstracted by the carbon, and two atoms of carbonic oxide (CO) are produced, which taking fire on the top of the coals, burn with the characteristic blue flame, abstracting more oxygen from the air, and re-forming carbonic acid (CO_2). C. O. can be prepared for experimental purposes by heating a mixture of oxalic acid ($\text{HO}, \text{C}_2\text{O}_3$) and sulphuric acid (SO_3) in a retort, when the latter abstracts the water from the oxalic acid, and the other elements (C_2O_3) escape as carbonic acid (CO_2), and C. O. (CO). On passing the mixed gases through a solution of potash (KO), the carbonic acid is retained as carbonate of potash (KOCO_2), whilst

CARBONIC OXIDE—CARBONIFEROUS SYSTEM.

the C. O. remains as gas. C. O. is a transparent, colourless gas, a little lighter than air, being 967, and has never been liquefied nor solidified. It burns with a blue flame, but is a non-supporter of combustion, and at once extinguishes a lighted candle introduced into it. It is very poisonous, and even when largely diluted with air, if inhaled, it produces a sensation of oppression and tightness of the head, and ultimately acts as a narcotic poison. It does not take part in any natural phenomena, nor is it put to any use in the arts and manufactures, and in these respects, affords a striking contrast to carbonic acid, which has so many duties to perform in nature and in the arts.

CARBONIFEROUS SYSTEM, the name given to the strata which, in geological order, rest upon the Devonian measures, and are capped by the Permian series. They derive their designation from the amount of carbon contained in them, for to them the great coal-fields of the world belong. In an economic sense, they are the most valuable series of rocks in the earth's crust, forming the great storehouse from which is obtained the chief supply of coal, iron, and lime.

The rocks of the system are composed of a vast series of beds of sandstone, limestone, shale, and coal. In some coal-fields, these are so interstratified, that it is impossible to subdivide the strata in the order of time. In the Edinburgh district, there are nearly 100 coal-seams, omitting all under six inches in thickness. Out of the whole depth of the strata, amounting to about 6300 feet, these seams occupy only 204 feet. The remainder consists of sandstone and shale in the upper half; towards the middle, limestones appear, and these increase downwards in the number and thickness of the

beds, but are still intermixed with seams of coal. The same arrangement exists in the other coal-fields of Scotland, as well as in those of the north of England. In other districts, the limestone is confined to the lower portion of the measures, and separated from the coal-bearing strata, so as to form a natural subdivision of the system into—
1. *The Coal Measures*, consisting of shale, sandstone, and grit, with occasional seams of coal; and 2. *The Mountain or Carboniferous Limestone*, a calcareous rock, containing marine shells and corals, and devoid of coal. A coarse quartzose sandstone, passing into conglomerate, is occasionally developed to a considerable extent between these two divisions. This is a local deposit, being almost confined to England, and may be considered as one of the coal sandstones, of coarser texture than usual. Being occasionally used for millstones, it is called *Millstone grit*. It is accompanied with shales containing the usual coal plants, but generally without any true coal seams. Another locally developed series of beds, consisting of indurated shales, sandstones, and grits, occurs below the carboniferous limestone in South Wales and Ireland, and is known as the *Lower Limestone Shales*. These rest conformably on a series of yellow sandstones, which have been generally referred to the Devonian Measures, but which, from their organic contents, as well as from their stratigraphical position, seem to be basement beds of the carboniferous series. The existence and development of these various beds in the United Kingdom will be better understood by an examination of the following table. The maximum thickness of the beds is given in feet when known; the blanks shew the absence of the division from the particular coal-field:

	Edinburgh.	Glasgow.	N. York.	Derby.	S. Wales.	Kerry.	Clare.	N. Ireland.
COAL MEASURES,	6300	2800	2000	2700	12,000	2000	2000	2200
MILLSTONE GRIT,			400	1800	1,000			1800
MOUNTAIN LIMESTONE,			1659	1000	1,500	1500	3000	6400
LOWER LIMESTONE SHALES,					500	4650	150	1200
YELLOW SANDSTONE,						3000	unknown	depth 2000

In the midland counties, the coal measures are the only portion of the carboniferous system present, and these rest on the Silurian or older rocks. In Devonshire, there occurs an extensive series of shales and sandstones, with a few beds of earthy anthracite or culm, associated with argillaceous rocks, probably belonging to the lower limestone shales, much indurated, and traversed by slaty cleavage.

From the great economic value of the contents of the C. S., we are better acquainted with its fossils than with any fauna or flora that flourished before the tertiary epoch. As coal is the result of the mineralisation of vegetable matter, the coal measures must necessarily abound in the remains of plants. No less than 294 species have been described as found in Britain alone. Numerous impressions of plants, as well as traces of structure, are found in the seams of coal themselves; but the more distinct forms are preserved in the interstratified beds of mud and ironstone, often in great number and exquisite beauty. Such remains consist chiefly of impressions of leaves separated from their branches; of casts of trunks, more or less in a broken state; and of roots much compressed, yet occupying their original position in the clay soil now indurated into shale; with these occur pieces of wood, or remains of trees, in which the vegetable texture is to some extent preserved. The great proportion of the plants seem to have flourished in marshy swamps, and to have accumulated where they grew, like peat, the material afterwards converted into coal. Hence a stratum of shale in which are imbedded the roots of *Sigillaria*, *Calamites*, &c., is the invariable

floor on which the coal seam rests. The chief coal plants are *Lepidodendron* (q. v.), *Sigillaria* (q. v.), *Calamites* (q. v.), *Trigonocarpum* (q. v.), and *Ferns* (q. v.). The existence of cone-bearing trees during this epoch, has been proved from the microscopic examination of prepared sections of fossil woods in which the small discs occur that are characteristic of and peculiar to the coniferae.

The animal remains are as numerous and as well preserved as the vegetable. They are found chiefly in the limestone; the greater part, indeed, of this rock, is made up bodily of corals and crinoids. No other such accumulation for extent and variety is known; it has its nearest parallel in the somewhat similar formation now going on in the Southern Archipelago. The corals and crinoids were specifically as well as individually numerous. The *tribratulæ* and other allied forms of bivalve shells, though belonging to a comparatively limited number of genera, were very abundant. The more highly developed mollusca were also numerous; they belonged to a great number of generic types. But the most remarkable group was the fishes. At no time were they more abundant. They belonged to the Ganoid and Placoid groups of Agassiz. The Ganoids, having their entire surface covered with scales, were numerous; some of them inhabited shallow water near the shore, and fed on crustaceans and shell-fish, for crushing which they had a formidable apparatus of conical teeth of a very complicated structure. Others were inhabitants of deep water, and were more powerful and predaceous, and more rapid in their movements. Their jaws were produced into a long snout, like

CARBUNCLE—CARDAMOMS.

the crocodile of the Ganges, and armed with a double series of enormous teeth, which were sometimes as much as four inches long by two inches broad, as in *Megalichthys* (q. v.), dimensions rarely attained even by the largest known reptiles. Associated with these were a great number of sharks belonging to the *Cestraciontidae* (q. v.), a family of which we have only a single living representative. They were furnished with a long bony spine to strengthen the dorsal fin, and thus enable them to turn speedily in the water, as they required to do in seizing their prey. These spines are often found fossil. The only remains referred to a higher division of the animal kingdom yet found belong to the saurian *Archegosaurus* (q. v.), found in the coal-fields of Germany.

CARBUNCLE, a name given by lapidaries to the beautiful mineral called *Pyrope* (q. v.), by mineralogists. The C. of the ancients appears to have been either *pyrope*, or the deep-red variety of noble garnet (see **GARNET**), which is in every respect very similar to it, or probably included both.

CARBUNCLE (Lat. *carbunculus*, a little coal) derives its name from the two prominent symptoms—a glowing fiery redness, and a burning pain. It consists of an inflammation, caused by some vitiated condition of the blood, or some atmospheric influence, attacking a patch of skin on the shoulders, nape of the neck, or indeed on any part of the body. The part swells slightly, feels hard, and this hardness extends deeply into the tissues; the pain is very severe, and the patient much depressed with loss of appetite, and general derangement of the secretions. As the disease advances, the redness assumes a dark purple or livid hue, the cuticle rises in blisters, and many small specks of matter appear on its surface, which discharge, and leave apertures like those in the rose of a watering-pot; through this a thin viscid fluid escapes, and occasionally a small slough or core of the true skin which has been killed by the disease. Sometimes these apertures meet, forming large openings, and in others the whole patch of skin sloughs and comes away.

The treatment of C. consists in restoring the secreting organs to a healthy condition, the agents for which must depend on the individual case; in supporting the patient's strength by easily digested food, wine, brandy and bark, with nitric acid; relieving pain by opiates, and encouraging suppuration with warm poultices; carrot, turnip, and yeast poultices being favourite applications in this disease. To prevent excessive loss of skin, the C. must be divided freely with a knife from one margin of the inflamed patch to the opposite one.

CARBURETTED HYDROGEN is a term in chemistry applied to several compounds of carbon and hydrogen. Thus, light carburetted or mono-carburetted hydrogen (CH_2) is the gaseous compound popularly known as marsh gas and fire-damp, and is the principal constituent of coal-gas. See **GAS**. Heavy carburetted or bi-carburetted hydrogen (C_2H_2) is otherwise known as Olefiant Gas (q. v.).

CARCAJENTÉ, a town of Valencia, Spain, about 28 miles south-south-west of the city of Valencia, situated on a rich plain near the right bank of the Juncar. It is well built, with good streets, and has a palace belonging to the Marquis of Calzada. It has some manufactures of linen and woollen, and a trade in the agricultural produce of the district. Pop. 7280.

CARCANET, a jewelled chain or necklace. Venice was famous for the manufacture of carcanets in the 15th century.

CARCASS, in military pyrotechny, is a hollow case of iron, sometimes globular, and sometimes ovate, filled with combustibles. It is fired from a mortar. Its chief use is to ignite buildings in the enemy's quarter, and to give sufficient light to aim the shot and shells. Carcasses are said to have been first used by one of the princely ecclesiastics of Germany, the Bishop of Munster, when he fought against the Duke of Luxembourg at Groll, in 1672. The oval carcasses, being uncertain in their flight, are now nearly abandoned. The round carcasses now made are chiefly those here indicated:

Diameter.	Composition.	Weight.
13 inch.	18 lbs.	213 lbs.
10 "	7 "	100 "
8 "	3 "	51 "
5 "	19 oz.	17 "
4 $\frac{3}{4}$ "	7 "	9 "

Carcasses are not intended to burst, but to send out, through holes, a furious and inextinguishable fire, which lasts 8 or 10 minutes. The composition with which they are filled, consists of saltpetre, sulphur, mealed gunpowder, pitch, rosin, tallow, and Venice turpentine, about one-half being saltpetre. The composition is packed in tightly through one of the holes; and the holes are stopped with fuses adjusted to ignite the composition after a certain space of time. Sometimes old pistol barrels, loaded to the muzzle, are introduced with the composition. Compare those details with **CASE-SHOT**, and **SHELLS**.

CARCASSONE, a town in the department of Aude, France, situated on the river Aude, and the *Canal du Midi*, about 55 miles south-east of Toulouse. It is divided into two parts, the old and new towns. The modern town is well built, with streets running at right angles to each other, squares adorned with trees, pleasant boulevards, and several marble fountains. The old town, built on a height, is much more picturesque, with its ramparts and towers, some parts of them dating from the time of the Visigoths, and the rest, with the castle, from the 11th or 12th century. This old town suffered greatly at the hands of the fierce bigot Simon de Montfort and his crusaders, who here burned 400 of the Albigenses. In the 14th c. it effectually resisted the Black Prince. The cloth manufactures are important, employing, it is said, upwards of 7000 people. C. has also manufactures of paper, leather, linen, and soap. Pop., exclusive of garrison, 15,000. The ancient name of the town was Carcaso, which was a place of some note in the time of Cæsar.

CARCHARIAS. See **SHARK**.

CARDAMINE. See **CRESS**, **BITTER**.

CARDAMOMS are the capsules of certain species of plants of the natural order *Scitamineæ* (q. v.), and belonging to at least two genera, *Amomum* and *Elettaria*. They are three-celled, and contain numerous wrinkled seeds, which form an aromatic pungent spice, weaker than pepper, and with a peculiar but agreeable taste. On account of their cordial and stimulant properties, they are employed in medicine, very generally to qualify other medicines; they are also used in confectionary, although not to a great extent in Britain; but in Asia they are a favourite condiment; and in the north of Germany, they are used in almost every household to flavour pastry.—The C. recognised in the British pharmacopœias, and called *True* or *Officinal C.*, also known in commerce as *Malabar C.*, are the produce of *Elettaria Cardamomum*, a native of the mountains of Malabar and Canara. They depend for their qualities on a peculiar pungent essential oil, called *Oil of Cardamom*, which may be obtained from them by distilling them with water, and when fresh, is

CARDAN—CARDIFF.

colourless. Other kinds of C. occur in commerce, but none is equal to the true C. in commercial value. The different kinds of C. differ not only in strength, but in the character of their aroma. The plants producing them have much general similarity.

CARDAN, JEROME, a celebrated mathematician, naturalist, physician, and philosopher, born at Pavia, September 24, 1501, was the illegitimate son of a physician and juriconsult at Milan. He received his early education at home, and completed his studies in Pavia and Padua. After some years, he became professor of mathematics at Milan. Here his reputation began to grow. After a few years, he began to lecture on medicine, to the practice of which he ultimately betook himself. By 1546, his reputation had so increased, that he was invited by the king of Denmark to accept a professorship at Copenhagen, which, however, he declined; and in 1552, we find him proceeding to Scotland, on an invitation from Hamilton, primate of that country. He managed to cure the primate of an inveterate asthma, which had defied the skill of the most celebrated physicians, and returned to Milan enriched by the bounty of his patient. Here he again settled for some time. In the autumn of 1559, however, he removed to Pavia as professor of medicine, whence, again, in the same capacity, he removed to Bologna, where he continued teaching till 1570, when we find him imprisoned for debt. Having regained his liberty in 1571, he went to Rome to avoid his creditors. Here he was speedily admitted a member of the medical college, and pensioned by Pope Gregory XII. The rest of his life he spent, without public employment, in Rome, where he died, September 2, 1576, a few weeks after finishing his autobiography. Some writers assert, but on no sufficient authority, that he starved himself to death, to fulfil a prediction which he had made as to the time when he should die. It is certain, however, that he was a devoted astrologer, and cast horoscopes for himself and others. The fancifulness necessary to support the faith of an astrologer imbued all his scientific writings. These were very voluminous. A summary of his notions on physics and metaphysics is given in his two works—*De Subtilitate*, in 21 books, and *De Rerum Varietate*, in 17 books. On the whole, he wrote 122 treatises on physics, mathematics, astronomy, astrology, rhetoric, history, ethics, dialectics, natural history, music, and medicine. These, it need scarcely be said, abound in incoherent paradoxes, contradictions, and capricious abstractions, more than enough to overwhelm the few profound ideas which he originated. A formula for the solution of certain kinds of cubic equations is called 'Cardan's formula,' and was published by him, as his own invention, in the *Ars Magna sive de Regulis Algebraicis* (1545); but it would appear that the formula was really the invention of one Tartalea or Tartaglia. In religion, C. was heterodox, and commonly reputed an atheist. His numerous writings were collected and edited by Charles Sphou (10 vols., Lyon, 1663).

CARDBOARD, or **CARD**, is made by pasting together several layers of paper, according to the thickness and quality required. *Bristol-board*, used by artists, is made entirely of white paper; ordinary C., of fine white paper outside, with one or more sheets of coarse cartridge-paper between. According to the number of layers, they are called *three*, *four*, *six*, or *eight sheet boards*. *Mill-board*, used by bookbinders as the basis of book-covers, is made of coarse brown paper, glued and strongly pressed.

The workman arranges the paper in the order required for pasting, and the pile, called a *head*, is

placed at his left hand, the paste-tub on his right. He lifts a sheet from the head with his left hand, brushes it over with paste with his right; then another is laid upon that and pasted, until he comes to the last required to complete the thickness of one board, when he removes two sheets, and only pastes the upper one, which thus forms the lower sheet of another board. This is repeated till the whole head is pasted, when it is removed to a press, and the water of the paste squeezed out at the edges. The boards are then separated, and dried by hanging them in a room artificially heated. The C., which is now rough and warped, is smoothed and flattened by making a pile consisting alternately of sheets of rough C. and copper plates, with a copper plate at top and bottom. This pile is passed between iron rollers, and the smooth surface of the copper impressed upon the C., which is thus flattened and beautifully polished.

The enamelling of address-cards is produced by brushing over the C. a mixture of *China* or *Krennits white* (a fine variety of white lead) and size. After drying, this surface is rubbed lightly over with a piece of flannel, previously dipped in finely powdered talc; it is then polished by rubbing vigorously with a hard close-set brush.

CARDIA, the upper orifice of the stomach, called, on account of its vicinity to the heart, by the same Greek name, *cardia*, and probably hardly distinguished from it in the earliest times of Greek medicine.

CARDIAC MEDICINES, stomachic and stimulating remedies—cordials, so called from their action on the heart through the stomach. See **CARDIA**.

CARDIALGIA, pain of the heart or stomach (**CARDIA**). The name is commonly applied to the particular variety of pain called *heartburn*, arising from a disordered stomach, and accompanied with acid eructations. See **INDIGESTION**.

CARDIFF (*Caer-Taff*, Fort of the Taff), a parliamentary and municipal borough and seaport, the county town of Glamorgan, South Wales, situated on the river Taff, 170 miles west of London by railway. The population has risen from 2000 in 1801, to 36,000 in 1859, with a floating population of about 5000. C., with Cowbridge and Llantrissant, returns one member to parliament. The town extends about one mile in each direction from the town-hall, having Roath on the east and Canton on the west, Maindy on the north and Bute Town on the south.

Among the public buildings are the Glamorgan-shire and Monmouthshire infirmary, new town-hall, and county jail. There are also many private buildings of a superior character. Of places of worship in C., 9 belong to the Church of England, 10 to the Independent and Baptist communities, 6 to the Wesleyan, and about 6 to other sects.

The port of C. is the outlet for the large mineral and manufactured produce of the central portion of the South Wales mineral-field, in which are the populous districts of Merthyr Tydvil, Rhymney, and Aberdare, with which this port is connected by the Taff Vale, the Rhymney, and the Ely Valley Railways, and the Glamorganshire Canal. The Bute docks, east and west, with an area of 65 acres, constructed by the late Marquis of Bute, and the present trustees to the estate, have cost upwards of a million sterling, and belong entirely to the present marquis. There are 31 staitths on the quays of the docks, with machinery of a peculiar construction for the purpose of loading vessels with coal, by which the breaking of the coal is almost entirely prevented. Each of these staitths is capable

of shipping 600 tons of coal in a day of 12 hours. There is also a tidal harbour, with 7 staiths, each capable of shipping 400 tons of coal per day, and a marine gridiron near the entrance-gates of the docks. Height of water at spring-tide, 31 feet 8½ inches; at neap-tide, 21 feet 7½ inches. Width of sea-gates, 55 feet; length of quays, 9100 feet; width of dock, 300 feet southern, and 500 feet northern part; depth, 25 feet. Exports during 1859—coal, 1,490,312 tons; iron, 195,961 tons; coke, 16,339 tons. Imports during 1859—number of ships, 7855; registered tonnage, 1,184,557 tons; iron ore, 74,934 tons. The quantity of export has recently doubled itself every five years. The imports to C. also include copper ore, live cattle, salted provisions, foreign fruit and vegetables, corn and flour, &c. The Penarth Docks and Ely Tidal Harbour, about 3 miles to the westward, form another outlet for the trade of the district. Steamers ply between the port of C. and London, Liverpool, Bristol, Cork, Whitehaven, and Burnham.

The assizes (half-yearly) and the quarter-sessions are held at the Town Hall. The ancient city of Llandaff, now a mere village, is almost connected with Cardiff. Cardiff Castle is partly now in ruins, and partly occupied by the Marquis of Bute. It was built in the 11th c., on the site of an older one. Robert Duke of Normandy, brother of Henry I., died in it, after being a prisoner for 28 years. Cromwell (1648) got possession of the Castle by treachery, after bombarding it three days; and he afterwards hanged the traitor as an example to his own soldiery. This town was anciently an important one, successively under the British, Romans, and Normans.

CARDIGAN (anciently, *Aberteifi*, Mouth of the Teify), the county town of Cardiganshire, a parliamentary and municipal borough and seaport, in the south-west corner of the county, on the right bank of the Teify, 3 miles from its mouth, and 239 miles north by west of London. The vicinity exhibits romantic scenery on the Teify, and grand rocks on the coast. The streets, except the chief one, are narrow, irregular, and steep; and the houses mostly built of slate-rock, and of an inferior description. Pop. 3876. With Aberystwith, Lampeter, and Adpar, C. returns one member to parliament. In 1858, 616 vessels, of 27,612 tons, entered and cleared the port. The general trade is confined to vessels of 20 to 100 tons. Vessels of 400 tons reach the town by spring-tides. C. became an important town about the Norman Conquest. The Normans were frequently defeated before mastering it. There are the remains of a castle on a low cliff on the Teify, which is supposed to have been founded, in 1160, by a Norman baron. The town suffered much in the struggles between the Welsh and the Normans. The Teify, which runs past the town, is said to have been the last British resort of the beaver.

CARDIGAN BAY, a semicircular bend of St George's Channel, on the west coast of Wales, 45 miles wide from north to south, and 20 miles deep, with a sweep of coast of 110 miles. Its exterior points are Brach-y-Pwll, off which lies Bardsey Isle, in Caernarvon, and Sturm Head, in Pembroke. It receives the rivers Mawddach, Dovy, Ystwith, Yren, and Teify. It has 3 to 30 fathoms water, with three reefs. A strong current sweeps round the bay from south to north. Almost all the harbours on the coast are obstructed by bars. A great part of C. B. is said to have been once dry land, protected, as Holland now is, by dams and dikes, and containing 16 towns, and the land is said to have been submerged about 520 A. D.

CARDIGANSHIRE, a maritime county in

South Wales, on Cardigan Bay, with an area of 675 square miles, a half being waste. The surface is hilly, interspersed with fertile valleys. A rugged, bleak range of hills runs through the middle of the county, from the south-west to the north-east, between the coast and the Teify, ending abruptly in a shelving beach in the middle of the coast, but on other parts there are rich flat tracts. The county contains little wood. The chief rivers are the Teify, which rises in a small lake near the centre of the county, and runs 70 miles south-east and east along the south border of the county, the Claerwen, Ystwith, and Rheidol. C. contains some romantic waterfalls, especially the Rheidol Falls and the Devil's Bridge, and above 20 small lakes or llyns, noted for their wild beauty. C. reposes on Lower Silurian slates and shales, containing few or no organic remains. Rich veins of copper, lead, zinc, and silver occur. The climate is cold and wet, but mild though wet on the coast. Snow lies long on the hills in winter. Summer is delightful in the valleys. C. is an agricultural county, and its chief branch of industry is the rearing of live-stock. The chief crops are oats, barley, and potatoes on the poor clay and peat soils of the mountains, and wheat, barley, and potatoes on the flat loams of the coast and valleys. The cattle and horses are small. There are some manufactures of coarse woollens and gloves, stockings and hats. Oats, barley, cattle, sheep, pigs, butter, slates, and woollens are exported. Cardigan is the county town; the other chief towns being Aberystwith, Lampeter, Adpar, Aberayron, Tregaron. C. sends one member to parliament. Pop. 70,796, only 3000 of whom use the English language. In 834, the king of C. became king of all Wales, under the title of Roderick the Great. He divided Wales among his three sons. After this, the Danes and Normans overran Cardiganshire. The county has many remains of British and Roman camps and roads, Druidical circles, cairns, and castles. Many Welsh princes and bards were buried in the abbey of Strata Florida, 16 miles south-east of Aberystwith, and some of the records of the principality were kept here. In C. there is a curious practice of sending presents (*biddings*) to a new-married couple, which, when sold, often realise £50 or £60. C. was disturbed, 1843—1844, with the Rebecca riots.

CARDINAL (Lat. *cardinalis*, principal, from *cardo*, a hinge). Cardinals are the highest dignitaries in the Roman Church after the pope, whose electors and councillors they are. The title, however, had at first a more general application. The pope being the sovereign bishop over the whole Romish Church, and having, as such, many duties to fulfil inconsistent with those of a particular diocese, had, from very early times, a number of bishops, priests, and deacons whom he appointed his vicars and coadjutors for the management of the diocese of Rome. The bishops exercised the episcopal function in the pope's stead, each having a peculiar church within the diocese. The priests were titular parsons of the churches in the city of Rome, and had the cure of souls. The deacons had charge of some churches and chapels of devotion, which they held as deaconries, with the additional duty of assisting the pope when he officiated in public. These three classes of ecclesiastics were called *cardinati* or *cardinales*, to denote that they were the first or chief over the rest, and that all the affairs of the diocese of Rome were under their direction. At a subsequent period, the priests and deacons of other cities of importance assumed the title of C., to distinguish them from other priests and deacons over whom they claimed supremacy; but the popes subsequently ordained that none but those

whom they had chosen should be honoured with that title. Amongst those whom the popes thus appointed were the seven bishops *suburbicarii*, who took their titles from places in the neighbourhood of Rome. These bishops were called *hebdomadarii*, because they attended the pope for a week each in his turn. These cardinals took part with the Roman clergy in the election of the pope, who was generally chosen from their number. About the beginning of the 12th c., the popes having formed a regular court, began to bestow the rank of C. priest or C. deacon on any individual of the clergy, or even of the laity, whom they chose to select; and to each, whether Roman or foreign, they gave the title of some particular church in Rome, but without attaching to it any obligatory service. Thus the cardinals became a separate body elected for life, and the officiating priests of the Roman parishes were gradually deprived of the title. In 1159, Nicholas II. limited the right of election to the popedom to the cardinals thus appointed, leaving to the rest of the clergy and people of Rome merely the right of approving of the election of a new pope, and to the emperor that of confirming it. Even these prerogatives, in course of time, were withdrawn. Notwithstanding the great powers thus intrusted to them, the bishops in the great councils of the church continued to take precedence of the cardinals; and it was not till 1614 that Louis XIII. of France, in the sitting of the parliament of Paris, adjudged precedence to the cardinals over the ecclesiastical peers—bishops and abbots. The power of the popes to appoint cardinals has often been contested, and their right to precedence denied, by the other dignified ecclesiastics. In 1567, Pope Pius V. forbade any clergyman not appointed by the pope to assume the title of C.; and Sextus V., in December 1586, fixed their number at 70—viz., the 6 bishops *suburbicarii*, 50 priests, and 14 deacons, and on this footing they have since remained, though the number is seldom complete, the pope generally leaving some vacancies for extraordinary cases. The number has frequently fallen greatly under 70. When Nicholas III. was chosen pope, there were but eight cardinals; and a little before the death of Alexander IV., there were but four. Sometimes before Sextus V. the number was exceeded, as in the pontificate of Pius IV., when there were 74. The body of cardinals is styled the Sacred College. Most of the cardinals reside in Rome, and either enjoy ecclesiastical benefices, or are employed in the administration. When not so provided for, the cardinals receive an allowance of 100 dollars monthly from the papal treasury. Some cardinals belong to monastic orders, and reside in their convents even after their election. The jurisdiction of the C. bishops in the place in which they are established is truly episcopal, but they are not obliged to reside. That of the C. priests and deacons is almost episcopal, but extends no further than the church and sacristy. They have there an episcopal seat under a canopy, like bishops, and they there solemnly give the people their blessing. The creation of cardinals is wholly in the pope. If the new-created C. is at Rome, he goes the same day to visit the pope, who puts the red cap on his head. The red hat, which Innocent IV. ordained that cardinals should wear, to shew that they ought to expose themselves to the shedding of their blood in the cause of the church, is afterwards given in a public consistory. A number of symbolical ceremonies accompany this investiture. The cardinals that are absent, when chosen, have the cap sent them by a special messenger from the pope. The hat is given by the pope's own hands; and many cardinals who do not visit Rome, die

without ever having received it. The only exception is in favour of members of royal houses, to whom the hat is sent. Pope Urban VIII., in 1630, gave to the cardinals the title of Eminence,

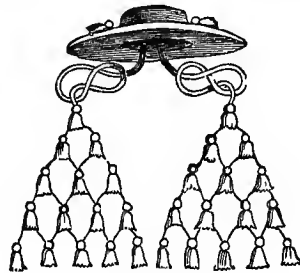

Cardinal's Hat.

which they shared with the grand-master of the Order of Malta, and the ecclesiastical electors of the German or Roman Empire. The pope often employs cardinals as ambassadors, and the individual thus employed is styled Legate a *Latere*. A C. legate acts, or recently acted, as governor of the Northern Provinces of the Papal States, which thence received the name of Legations. The chief secretary of state, the *Camerlengo* or minister of finances, the Vicar of Rome, and other leading officials, are always chosen from among the cardinals. The Council of Cardinals, when assembled under the presidency of the pope to discuss matters of church and state, is called the Consistorium. There are public consistories, which are held on great occasions, and correspond to the levees of other sovereigns; and private and secret consistories, which are the privy council of the pope. Moreri's *Dictionary, voce Cardinal*, contains a list of cardinals from 1119 to 1724, with their names, countries, &c., and the dates of their election and death.

CARDINAL BIRD, or RED BIRD (*Guarica cardinalis*), also called cardinal finch, cardinal grosbeak, and Virginian nightingale, one of the

Cardinal Finch (*Guarica cardinalis*).

finest song-birds of America, belongs to the family of *Fringillidae*, and differs from the true grosbeaks (*Coccothraustes*) in having the beak slightly bulging. The general colour of the male is red, the head being vermilion, and only a small portion of the plumage around the base of the bill being black. The feathers of the crown are long, and erected into

a conical crest, like a red cap. The C. B. abounds in Texas, Florida, and the Southern States of America generally, migrating northwards in spring, but never further than Massachusetts, where only a few stragglers are seen. Its loud, clear, sweet, and varied song is to be heard chiefly in the mornings and evenings. In size it exceeds any of the British *Fringillidae*, being about equal to the starling.

CARDINAL FLOWER. See LOBELIA.

CARDINAL POINTS. See COMPASS, MARINERS'.

CARDINAL VIRTUES (*Lat. cardinalis*, chief, from *cardo*, a hinge). The C. V. of the ancients were Justice, Prudence, Temperance, Fortitude. They were so called because the whole of human virtue was supposed to hinge or turn upon them. In other words, they were considered as a full and comprehensive classification of man's various duties.

This mode of dividing the virtues is to be found as far back as Socrates. The ancient moralists treated under Ethics the whole sum of human duty and virtue. Thus, Aristotle considers the great problem of the science to be the determination of man's highest good, together with the means of realising it. Hence, he includes both the social virtues and the prudential regard to the welfare of the individual in the same scheme. Of the four C. V., it will be seen that the first, Justice, is the social virtue; that Prudence (which, properly speaking, includes Temperance also) regards the wellbeing of the individual; while Fortitude is necessary to both. This last was a virtue greatly esteemed in the ancient world, each one's lot being much less secure than with us in the present day; it was impossible to say what sufferings might be in store for the most prosperously situated of men.

Dr Whewell has made an attempt to correct the more obvious defects of the classification, and has substituted one which he deems free from those defects. The most notable omission, in the ancient scheme, judged from the modern point of view, is the absence of all reference, either expressly or by implication, to the virtue of Goodness or Benevolence. This was characteristic of the pagan moralists; for although good deeds were abundantly practised among the ancients, they did not account it a part of human virtue to flow out spontaneously in every kind of active benevolence, including the most wicked and worthless among the objects of it. Aristotle, in discussing the various acts and outgoings of friendship, never loses sight of the *reciprocal* obligations on the other side; so that when a rich man befriends, with his wealth, one that is poor, the inequality must be made good by a greater amount of honour or respect on the part of him that is so befriended.

Accordingly, to adapt the classification to the altered point of view, Benevolence has to be added to the list. This is Dr Whewell's first virtue; the others are Justice, Truth, Purity, and Order. But the scheme, as thus amended, is scarcely less objectionable than before. The virtue named last, Order, which means obedience to authority, cannot but contain a very large portion of all the rest; seeing that Justice, Truth, &c., are enjoined by positive law. Then, what is understood by Purity, including the control of the two powerful appetites, Hunger and Sex, is partly prudential and partly social.

The ethical discussions of modern times may be very much aided, if we divide the totality of human virtue on the following plan. There are three distinct classes of human actions, which are all approved of or accounted virtuous, but on different grounds, and in a different manner.

1. There are actions which are forbidden by society under penalties; in other words, men are punished for committing them. Such are theft, breach of bargain, slander, violence to the person, and all the offences against our fellow-men that are prohibited by the law of the land. The avoiding of all these actions is signified to be a part of our duty, by the suffering inflicted on the doers of them. The law fines, imprisons, or puts to death those who will not conform to its regulations.

The law of the land is not the only power that prescribes conduct enforced by penalties. The public opinion of the country at large forbids certain actions, and punishes transgressors by excluding them from social intercourse; such, for example, are acts of unchastity, more especially when committed by women. There are also codes enacted by particular societies, as the code of honour among gentlemen, which constitutes some actions offences that are not so by law, or by universal opinion. Cowardice is one of the qualities most obnoxious to the code of honour.

The actions prohibited by law are obviously such as could not be allowed without the entire subversion of human society. If murder and theft were to go unpunished, the principal end for which men associate together in communities—that is, protection and security—would not be attained. It is impossible that we should not disapprove of all such actions, and approve of the contrary.

2. There are some actions that are accounted virtuous, while their opposites are not punished, as in the case of those now mentioned. Doing good to persons that have no claim upon us—in other words, benevolence or philanthropy—is considered highly praiseworthy; but the neglecting of this is not usually visited with any punishment or censure; so that if it be a duty to perform acts of benevolence, it is a duty generically different from paying our debts, and respecting the person and property of our neighbour. The motives brought to bear on the two cases are widely contrasted: in the one, we *punish* for doing the action forbidden; in the other, we *reward* for doing the thing enjoined, and inflict no punishment if that is neglected. Here lies the difference between *duty*, strictly so called, and *merit*. In the bare performance of duty there is no merit; a man would not even be commended for the punctual payment of his just debts, if it were not that many people are deficient in this respect, and in the comparison with these the correct person excites in our minds a feeling of satisfaction. *Disapprobation* is the sentiment properly concerned with duty, or rather, with breach of duty; *approbation* is bestowed on all who do something over and above their duty. This distinction is known in every department of practical life; while speculative moralists habitually lose sight of it.

3. The virtues included under Prudence are in a different position from either of the foregoing classes. Bearing the common names, virtue and duty, by which they are recognised as worthy of approbation or commendation, they are nevertheless unaccompanied with the sanctions either of punishment or of reward. The imprudent man is subject to no legal penalty, unless he clearly involves other persons in his imprudence; and the prudent man is not rewarded with the praise, esteem, or other benefits conferred upon the benevolent man. It is true that the young are punished by parents or teachers for imprudences; and some governments take such a paternal care of their subjects, as to punish them for sins against themselves. Men have been sent to prison, because of their endangering their own salvation by embracing heresy; but at the present day, such a proceeding is considered

CARDING OF COTTON—CARDS.

beyond the function of government. Men and women, arrived at maturity, are expected to take care of their own interests; even if they do not, no one punishes them; if they do, no one rewards them. We have, it is true, a certain feeling of disesteem in the one case, and of esteem or commendation in the other; neither of which, however, attains any considerable strength until more than the individual's self is involved. In short, although we cannot divest ourselves of all sentiment as lookers on, when men behave prudently or imprudently, our rule is *non-interference*; and this constitutes a marked distinction between the self-regarding and the social vices and virtues.

Accordingly, when ethical writers are endeavouring to probe the foundations of the moral sense in man, they ought to consider separately those three different species of conduct, for the sentiment excited by each is marked by strong peculiarities. To class social duties enforced by punishment, social virtues stimulated by rewards, and prudence, which is accompanied by neither, under one common designation, and discuss them as if they were essentially the same, is to confuse, instead of clearing up, the first principles of morality.

In Roman Catholic systems of theology, there are declared to be four *cardinal virtues*—'Prudence, Fortitude, Temperance, and Justice'—from which all other 'moral' virtues are represented as flowing. But there is a prior division of virtues into the two classes of *theological* and *moral*; the theological virtues being Faith, Hope, and Charity. The distinction between these two classes is represented as consisting in this, that the theological virtues '*immediately* regard God;' and the moral virtues do not immediately regard God, but are commanded and rewarded by God, and are beneficial to ourselves.

CARDING OF COTTON, &c., the process of disentangling and arranging in parallel rows the fibres of cotton. This operation may be compared to the combing and brushing of one's hair, and the *card* combines the properties of the comb and brush, being a brush with wire teeth instead of hairs. These teeth are inserted in strips of leather, which are fixed upon the surface of a cylinder. Several such cylinders are arranged so that the ends of the teeth are nearly in contact; and the cotton being brought to them, is caught up, passed from one to the other, and combed out as the cylinders revolve in the form of beautiful films or fleeces, which are removed by a smaller drum-card, called the 'doffer,' and again from this by the 'doffing-knife.' These films, which are of the width of the drum, are next contracted to a narrow ribbon, by being passed through a funnel; and thus narrowed, are called the 'card ends' or 'slivers,' and are now ready for the next process of 'drawing' or 'doubling.' See **SPINNING**.

CARDINIA, a genus of fossil conchiferæ, containing 85 species, which extend from the Silurian to the inferior oolite. They have an oval or oblong shell, attenuated posteriorly, and marked with lines of growth, and an external ligament. They occur abundantly in the valuable layers of clay-ironstones called 'mussel-bands.' In Derbyshire, this material is wrought, like marble, into vases.

CARDITIS, or inflammation of the heart, a form of disease of very rare occurrence, if the term be limited in its application to cases of true acute inflammation of the muscular structure of the heart itself. C., however, was commonly understood in a wider sense, so as to include certain forms of disease of the external and internal lining membrane of the heart; and it is only since the beginning of the

present century that, owing to the improvements in medical pathology and diagnosis, the names of Pericarditis and Endocarditis (q. v.) have come prominently into view as indicating the most ordinary inflammatory affections of the heart. See **HEART, DISEASES OF**.

CARDIUM AND CARDIA'CEÆ. See **COCKLE**.

CARDO'NA, a town of Catalonia, Spain, about 44 miles north-west of Barcelona. It is situated on a declivity on the right bank of the Cardener, is surrounded by walls, pierced with six gates, and commanded by a castle on a height. It is celebrated on account of a mountain of salt in its vicinity, which has a height of about 500 feet, and measures a league round. When the sun shines on this gigantic mass, the effect is of the most brilliant and gorgeous description. Pop. about 2500.

CARDOON (*Cymara Cardunculus*), a perennial plant of the same genus with the **ARTICHOKE** (q. v.), a native of the south of Europe and the north of Africa. It very much resembles the artichoke, but is of larger size, whilst the flowers (heads of flowers) are smaller. It has long been in cultivation, for the sake of the blanched leaf-stalks and midribs of the leaves, which are used as a salad, or more generally as a boiled vegetable during winter.

CARDS. All that we know of C., for certain, is, that they are of ancient and eastern origin. What is asserted by Count de Gebelin and the earliest writers upon the subject, that in their primary stage they constituted some sort of symbolic and even moral game, is not so well established. The Hindu and Chinese C. are, however, emblematic in a very high degree—the former illustrating the ten avatars, or incarnations of the deity Vishnu; and the so-called paper-tickets of the Chinese typifying the stars, the human virtues, and, indeed, almost anything you please. The learned Sir William Jones expresses himself convinced that the Hindu game of *Chaturaji*—the Four Rajahs or Kings—a species of highly complicated chess, was the first germ of that party-coloured pasteboard which has been the ruin of so many modern fortunes. In the wardrobe accounts of Edward I., there is an item of money paid for the use of that monarch for playing at the Four Kings—'ad opus regis ad ludendum ad *quatuor reges*, viii.s. v.d.'—which is supposed to have been a game at C.; but how and when painted C. took the place of carved figures, is still but matter of conjecture.

A pack of Hindustani C., in the possession of the Royal Asiatic Society, and presented to Captain Cromline Smith in 1815 by a high-caste Brahman, was declared by the donor to be actually 1000 years old. 'Nor,' quoth the Brahman, 'can any of us now play at them, for they are not like our modern cards at all.' Neither, indeed, do they bear any remarkable resemblance to our own—the pack consisting of no less than eight suits of divers colours, the kings being mounted upon elephants, and the viziers, or second honours, upon horses, tigers, and bulls. Moreover, there are other marks by which the respective value of the common C. may be distinguished, which would puzzle our club quidnuncs not a little—such as 'a pine-apple in a shallow cup,' and 'a something like a parasol without a handle, and with two broken ribs sticking through the top.' In the Chinese dictionary, called *Ching-tze-tung*, it is asserted that dotted C. were invented in the reign of Seun-ho (1120 A.D.), and devised for the amusement of his numerous wives: there are thirty C. in each of these packs, three suits of nine C. each, and three single C. superior to all the others. The name of one of the suits is

CARDS.

Kew-ko-wan—that is to say, the nine ten-thousands of kwan, strings of beads, shells, or money; and the titles of the other two suits are equally concise and significant. The Chinese C. have, however, a decided advantage over those of Hindustan in being oblong instead of circular.

C. do not appear to have been known in Europe until towards the end of the 14th century. 'In the year 1379,' writes Carelluyzo, 'was brought into Viterbo the game at cards, which comes from the country of the Saracens, and is with them called *naib*.' 'Whence afterwards,' says Mr W. Chatto (*Origin and History of Playing Cards*, Lond. 1848), 'perhaps Jackanapes, Jack of cards.' This entry occurs in the accounts of the treasurer of Charles VI. of France, in 1393: 'Given to Jacquemin Gringonneur, painter, for three packs of cards, gilt and coloured, and variously ornamented for the amusement of the king, fifty-six sols of Paris.' From the date of this year being immediately subsequent to that in which the king lost his reason, the story goes that C. were invented to divert his royal melancholy; but they were certainly of earlier use in France. The French clergy took greatly to C. about this time; we are afraid, too, it was to the ungentle game of All-fours, since we find them specially forbidden that amusement by the synod of Langres, in 1404.

Card-making became a regular trade in Germany fourteen years after this, and it, as well as card-painting, seems to have been carried on for some time exclusively by females; the wood-engraving of C., however, did not begin until some time afterwards. The pips were then very prettily imagined, the suits consisting of hearts, bells, acorns, and leaves. The place of her majesty the queen was filled by a knight in those days; and it is to Italy, and not to Germany or France, that the glory of giving *place aux dames* must be conceded. There was also no ace whatever! By 1420, gambling by means of C. had grown to such a pitch, as to provoke St Bernardin to preach against it at Bologna; and that so eloquently, as to cause his hearers to make a fire in the public Place, and throw all the C. in their possession into it—a proceeding which must have been hailed with joy by the Messrs De la Rue of that period. The signs upon Italian C., which seem to have been the first imported into England, were cups, swords, money, and clubs; but in the third year of Edward IV., their further importation was forbidden, and the home-trade of card-making protected. C. were played by that time, we read, 'in all places of worship' in this country, by which it was meant, not in the churches, but in the houses of all the gentry. Henry VII. was a cardplayer; and there are not a few entries in that mean monarch's privy-purse account of his majesty's little losings. His daughter Margaret, at the age of fourteen, was found by James IV. of Scotland—the first time he ever saw her—in the act of playing cards; and it was most probably *écarté*, for he at once 'proposed' to her, and she 'accepted' him. There was a sum regularly allotted to the Princess, afterwards Queen, Mary, as pocket-money for this especial purpose; the sums given her at a time for immediate disbursement ranging from 20s. to 40s., but one entry being so disgracefully low (for a princess) as 'two and tuppence.' James I. likewise played a good deal, but so sleepily, that he required somebody to hold his C. for him.

About the year 1660, heraldic C. were first introduced into England, the King of Clubs being represented by the arms of the pope; of Spades, by those of the king of France; of Diamonds, by those of the king of Spain; and of Hearts, by those of the king of England. From these heraldic

C., we suppose, Mr Chatto derives the word coat-card, instead of court-card, which is certainly in more general use. In 1679, a pack was published containing the history of all the popish plots, 'excellently engraved on copper-plates, with very large descriptions under each card. Aspersers of this pack,' it is added by their disinterested publisher, 'plainly shew themselves to be popishly affected.'

The French, from whom we derive our ordinary suits of diamond, heart, spade, and club—*carreau*, *cœur*, *pique*, and *trèfle*—were continually changing their court-cards, and representing on them all sorts of historical characters. In the earlier periods, their kings were David, Alexander, Cæsar, and Charlemagne, or Solomon, Augustus, Clovis, and Constantine; about all of whom, as well as their queens, Père Daniel has the most ingenious theories. Troops, says he, however brave and numerous, require to have prudent and experienced generals. The *trèfle* or clover-plant, which abounds in the meadows of France, denotes that a chief ought always to encamp his army in a place where he may obtain forage for his cavalry; *piques* and *carreaux* signify magazines of arms, which ought ever to be well stored—the *carreau* being a sort of heavy arrow shot from a cross-bow, and which was so called from its head being squared (*carré*); *cœurs*, hearts, signified courage of both commanders and soldiers; the *ace* was the Latin *as*, and represented money, the sinews of war: and so on.

At the time of the French Revolution, the places of the card-kings were filled by four philosophers—Molière, La Fontaine, Voltaire, and Rousseau; and those of the queens by four virtues—Prudence, Justice, Temperance, and Fortitude.

Many attempts have been made to put down card-playing by the strong hand of the law; but the history of the Four Kings has, nevertheless, always retained its students. Not a few enthusiastic players have absolutely died in harness, with cards in their hands, such as the great Bath player Lookup, who expired at his favourite 'Double Dumby,' not even being permitted by inexorable Death to play out the game. The Four Kings, like their flesh-and-blood originals, are likely to lose all sway over the New World; for Mr Chatto informs us, that the court-cards, if they can be called so, of a republican pack recently (1848) manufactured at New York, have neither kings nor queens; the President of Hearts being Washington; of Diamonds, John Adams; of Clubs, Franklin; and of Spades, Lafayette. One of the queens is Venus, modestly concealing her charms; and the others are respectively Fortune, Ceres, and Minerva: while the knaves are fitly represented by Indian chiefs.

The manufacture of playing-cards comprises many interesting processes. The cardboard employed for this purpose is formed of several thicknesses of paper pasted together; there are usually four such thicknesses; and the paper is so selected as to take paste, paint, and polish equally well. The sheets of paper are pasted with a brush, and are united by successive processes of cold-drying, hot-drying, and hydraulic pressure. Each sheet is large enough for forty cards. The outer surfaces of the outer sheets are prepared with a kind of flinty coating, which gives sharpness to the outline of the various coloured devices. Most packs of cards are now made with coloured backs. The ground-tint is laid on with a brush, and consists of distemper colour, or pigments mixed with warm melted size. The device impressed on this ground-tint is often very beautiful. Messrs De la Rue, the leading firm

in the manufacture, employ tasteful artists, and invest a large amount of capital, in the introduction of new patterns. On cards sold at moderate prices, the colours at the back are generally two—one for the ground, and one for the device; but some of the choicer specimens display several colours; and many of the designs are due to the pencil of Mr Owen Jones. The printing of the design is done on the sheets of paper, before the pasting to form cardboard. The pips or spots on the faces of playing-cards are now *spades, clubs, hearts, and diamonds*; but at different times, and in different countries, there have been leaves, acorns, bells, cups, swords, fruit, heads, parasols, and other objects similarly represented. In English cards, the colours are red and black; Messrs De la Rue once introduced red, black, green, and blue for the four suits; but the novelty was not encouraged by card-players. The same makers have also endeavoured to supersede the clumsy devices of kings, queens, and knaves, by something more artistic; but this, too, failed commercially; for the old patterns, like the old willow-pattern dinner-plates, are still preferred—simply because the users have become accustomed to them. Until within the last few years, the printing of cards was generally done by *stencilling*, the colour being applied through perforated devices in a stencil-plate. The colour employed for this purpose is mixed up with a kind of paste. When there is a device at the back, the outline of the device is printed from an engraved wood-block, and the rest filled in by stencilling. The stencilling of the front and back can be done either before or after the pasting of the sheets into cardboard. One great improvement in the manufacture, has been the substitution of oil colour for paste or size colour; and another, the substitution of printing for stencilling. Messrs De la Rue have expended large sums of money on these novelties; for many experiments had to be made, to determine how best to employ oil colour so that the spots or pips may be equal-tinted, the outline clear and sharp, the pigment well adherent to the surface, and the drying such as to admit of polishing without stickiness. The plates for printing are engraved on copper or brass, or are produced by electrotype, or are built up with small pieces of metal or interlaced wire. The printing is done in the usual way of colour-printing, with as many plates as there are colours (usually five), and one for the outlines; it is executed on the sheets of paper, before being pasted into cardboard. When the printing, drying, and pasting are all completed, a careful polishing is effected by means of brush-wheels, pasteboard wheels, heated plates, and heated rollers; in such a way that the polish on the back may differ from that on the face—since it is found that too equally polished surfaces do not slide quite so readily over each other. Every pack of cards made in England for home-use pays a duty of one shilling, which duty is levied on the ace of spades. The maker engraves a plate for twenty aces of spades; the printing is done by the government at Somerset House, and £1 is paid by the maker for every sheet of aces so printed. The cardboard, when all the printing is finished, is cut up into cards; every card is minutely examined, and placed among the 'Moguls,' 'Harrys,' or 'Highlanders,' as they are technically called, according to the degree in which they may be faultless or slightly specked; and the cards are finally made up into packs. Persons wishing the best cards should ask for 'Moguls,' the usual retail price for a pack of which is 2/3 to 3/9.

A few years ago, it was estimated that about half a million packs of cards are made annually in England, by about seven or eight firms. Card-playing is not now so general in England as it

was early in the century, and the number made has consequently lessened, although the quality has greatly improved. All the cards used in Russia, with a few exceptions, are made at an imperial manufactory in St Petersburg, where the operations are conducted on a large scale, and where the number of packs made exceeds manifold the whole produce of England. The French cards are somewhat smaller and thinner than those of England.

CARDUE'LIS. See GOLDFINCH.

CARDUUS. See THISTLE.

CARE, or CARLE SUNDAY, the Sunday before Palm Sunday, said to be so called because it was the practice in many parts of the country to eat gray peas, called carlings, fried in butter, pepper, and salt, on this day. This practice apparently had its more immediate origin in the custom of the Roman Catholic Church of eating hallowed beans fried at this time—these beans being described in some religious books as symbolical of confession, and their steeping before use, of meditation. It appears, however, to have been adopted by this church from a heathen custom. See Brand's *Popular Antiquities*.

CARE'NING is the operation of heaving down a ship on one side, in order to expose the other side for cleaning by the process of *Breaming* (q. v.). C. is seldom now performed upon English ships, partly because the use of copper-sheathing lessens the fouling of the bottom, and partly because caissons and hydraulic lifts afford means for raising ships out of the water. The *Great Eastern* has lately (September 1860) been placed upon an open scaffolding or frame, called a *gridiron*, in Milford Haven, and floated so as to render cleansing possible without the dangerous and difficult process of careening.

In sea-phrase, a vessel is said to 'careen' when she leans over very much through press of sail.

CARET (from the Latin *careo*, I am wanting), a character of this form, λ , denoting that something has been omitted, and is interlined.

CAREW, THOMAS, a poet of the reign of Charles I., descended from an old family in Gloucestershire, was born 1589. Having been educated at Oxford, he travelled abroad for some time, and on his return was received at court, and patronised by Charles I. C. deserves mention chiefly as the precursor and representative of what may be called the courtier and conventional school of poetry, whose chief characteristic was scholarly ease and elegance, with a spice of indelicacy, and even indecency. C.'s poems, mostly lyrical, and treating of trifling subjects, are among the best of their kind, and exhibit much fancy and tenderness. He died 1639. Several editions of his poems, which first appeared in 1640, have been published.

CAREX, a genus of plants of the natural order *Cyperaceæ*, of which the species are very numerous—more than 450—principally abounding in the temperate and colder parts of the world. More than 60 are natives of Britain. The English name *SEDGE* or *SEG* is sometimes employed as synonymous with C., but is popularly applied only to some of the species. This genus is distinguished by unisexual flowers, the male flowers with one glume, the female enclosed in a flask-shaped involucre. Some of the species are plants of the very humblest growth, others are two or three feet in height; all are of unpretending, grassy, or rush-like appearance. Some grow in wet, and others in dry situations; some are of great value in the economy of nature, as forming the principal part of the vegetation of swamps, which they gradually convert into fertile ground. The

running roots, or rather *rhizomes*, of some help to bind the sands of sea-shores, particularly *C. arenaria*, which is carefully planted for this purpose on the

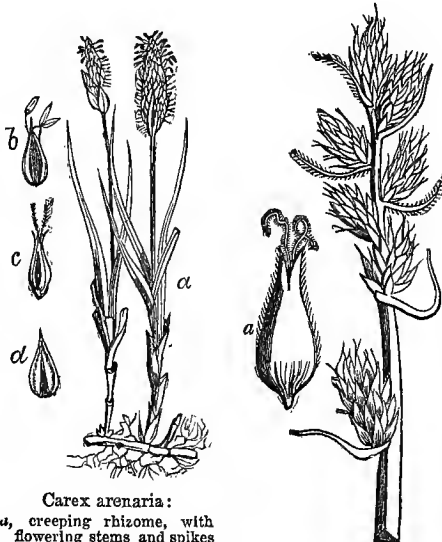

Carex arenaria:

a, creeping rhizome, with flowering stems and spikes of flowers; b, a male flower, detached; c, a female flower, detached; d, a glume.

Carex Vulpina:

a, a female flower.

dikes of Holland. None are valued by the agriculturist, as they are very deficient in nutritive quality, and in general they abound only in very inferior pastures, and good tillage and drainage lead to their speedy disappearance. The rhizomes of *C. arenaria*, *C. hirta*, and *C. disticha*, are sometimes used under the name of *German Sarsaparilla*, as a diaphoretic and demulcent medicine—a bad substitute for sarsaparilla. The two former are common in Britain. The dried leaves of *C. sylvatica* are used by the Laplanders to cover their legs and hands as a protection from frost-biting and chilblains, being worn in the inside of their shoes and gloves.

CAREY, WILLIAM, D.D., a distinguished minister and missionary belonging to the Baptist body, was born at Paulersbury, a village in Northamptonshire, August 1761. He served his time as a shoemaker, but began to preach about his 20th year. A pamphlet which he published about this time, attracted the attention of his co-workers in the ministry to the subject of Foreign Missions, and ultimately a missionary society, chiefly through C.'s exertions, was formed. C. and a Mr Thomas were chosen its first missionaries to India in 1793. From that time until his death in 1836, C. was indefatigable (under many difficulties, especially in his early years) in his efforts to spread the knowledge of the gospel among the heathen. Under his direction, the Serampore mission, of which he was the principal founder, had up to 1832 issued above 200,000 Bibles, or portions thereof, in about forty Oriental languages or dialects, besides a great number of tracts and other religious works in various languages. A great proportion of the actual literary labour involved in these undertakings was performed by C. himself, whose Sanscrit and other grammars have been highly spoken of by the late Mr Wilson Boden, professor of Sanscrit at Oxford. C. was professor of Oriental Languages at Fort-William College, Calcutta, from 1800 to 1830.

CAREY, HENRY C., a political economist of the United States, born at Philadelphia in 1793. In 1836, he published an essay on the *Rate of Wages*, which was expanded into the *Principles of Political Economy* (1837—1840). The value of this work may be estimated from the fact, that no less an authority than Frederic Bastiat copied its leading ideas. It was translated into Italian and Swedish, and favourably noticed in all the important politico-economic journals of Europe. In 1838, C. published *The Credit System of France, Great Britain, and the United States*; and in 1848, *The Past, the Present, and the Future*, a production marked by great vigour and originality of thought, and which endeavours to controvert the leading doctrine of Ricardo, Malthus, &c. In 1853 appeared the *Slave Trade*, and *Letters on the International Copyright*; and in 1858, the first and second volumes of his *Principles of Social Science*. As regards copyright, he opposes any international arrangement to check piracy, of which, for the special benefit of certain American publishers, he may be said to be the advocate.

CA'RGÓ is a general name for all the merchandise carried on board a trading-ship. Sometimes it is applied also to the invoice of the cargo. The term *deck-cargo*, is given to the commodities on deck, which are not usually included in the policy of insurance.

For the security of the Customs' revenue, the master of every coasting-vessel is bound to keep a *cargo-book*, recording the name of the vessel, the name of the owner, the port of departure, the port of destination, the goods taken, the names of the shippers and consignees, the time of departure, and other particulars. The Custom-house officers may demand to see this book at any time. The C. of passenger-ships is placed, in some degree, under the control of the emigration officers by an act passed in 1852.

CA'RIA, in ancient geography, the south-westernmost country of Asia Minor, bounded N. by Lydia, E. by Phrygia, S.E. by Lycia, and W. and S.W. by the Mediterranean. A large portion of what was C. is mountainous. The chief ranges were called the Cadmian and the Latmian. The most important river was the *Mæander*, famous for its windings. C. was, at an early date, governed by petty princes or kings; it afterwards became a part of the Persian empire, the former princes continuing to rule as satraps; and it subsequently came into the hands of the early Macedonian kings of Egypt; and finally, with the rest of Asia, into those of the Romans. Among the chief towns were Cnidus, Halicarnassus, and Miletus.

CARIA'CO, a seaport of Venezuela, at the mouth of a river, and at the head of a gulf of the same name. It is 40 miles to the east of Cumana, in lat. 10° 30' N., and long. 63° 40' W. Pop. 7000. The gulf, long and narrow, with good anchorage, and well-wooded shores, is open only on the west, and that to a portion of the Caribbean Sea, which is itself breasted by a chain of islands.

CARIACOU, CA'RJACOU, or VIRGINIAN DEER (*Cervus Virginianus*), a species of deer found in all parts of North America, from Mexico to about N. lat. 43°, and from the Atlantic to the Pacific Ocean. It is the species commonly called Deer by the Anglo-Americans. It is smaller and more elegant than the common stag; of very variable colour—light reddish brown in spring, slaty blue in autumn, and dull brown in winter; the belly, throat, chin, and inner parts of the limbs white. The horns of the adult male are of moderate size, bent strongly backward, and then suddenly

forward, so as to bring their tips nearly above the nose; they have several snags. The fawn is profusely decked with white spots, arranged in lines, and sometimes running into stripes. The name C. is extended generically to several nearly allied species, found in Mexico, California, &c.

CARIA'MA (*Microdactylus cristatus*), a bird of the order *Grallæ*, allied to the cranes, but exhibiting also points of strong resemblance to gallinaceous birds, among which it has therefore been proposed to rank it, next to the guans. It is a native of Guiana, Brazil, and Paraguay, inhabiting open plains and the outskirts of forests, where it feeds chiefly on serpents, lizards, and insects. It is larger than the common heron; the plumage is brown, finely waved with darker brown, whitish on the lower parts. When pursued, the C. seeks safety by running, and does not readily attempt to use its wings. Its voice resembles that of a young turkey. It is much esteemed for the table, and it is sometimes reared in a domesticated state.

CARIBBEAN SEA, the grandest inlet of the western hemisphere—corresponding, in several respects, to the Mediterranean in the eastern—is separated from the Gulf of Mexico by Yucatan, and from the Atlantic Ocean by the great arch of the Antilles, between Cuba and Trinidad inclusive, stretching in N. lat. from about 8° to about 22°, and in W. long. from about 61° to about 89°. The C. S. forms the turning-point in the vast cycle of waters known as the GULF STREAM (q. v.), that wheels round, with the regularity of time itself, from Southern Africa to Northern Europe. It pours its waters into the Gulf of Mexico on the west, which shoots forth, on the east, the Florida Stream with the computed volume of 3000 Mississippi. To supply this enormous efflux, the C. S. draws on the Atlantic, laying under contribution nearly all the trade-wind regions of that ocean, so as literally to become the receptacle of the Amazon and the Orinoco. To the British Isles, it is, in this connection, an object of peculiar interest. Rendering still warmer the warm floods which it concentrates, it imparts to the Florida Stream that high temperature which tends, with the aid of the prevalent winds, to mitigate climates from Guernsey to Shetland. In common with the islands of its eastern boundary, the C. S. takes its name from their now extinct aborigines, the Caribs.

CARIBBEE BARK, or **PITON BARK**, is the bark of *Bxostemma Caribæum*, a small tree which grows in the West Indies and in Mexico, and belongs to the natural order *Cinchonaceæ*. The genus *Bxostemma* is very nearly allied to *Cinchona*, from which it differs in having the stamens exserted, whereas in *Cinchona* they are included within the corolla. *B. Caribæum* has ovate lanceolate leaves, and is known in the West Indies as the *Sea-side Beech*. C. B. has a very bitter taste, and a very faint smell. It contains none of the characteristic alkaloids of cinchona, yet very much resembles it in some of its properties, and is one of the barks sometimes substituted for the true cinchona barks.

CARICA. See PAPAUA.

CARICATURE (Ital. *caricatura*, from *caricare*, to load or overcharge). The etymology of this word indicates its meaning very distinctly, which is that of a representation of a face, form, or character, in which the salient features are exaggerated or overloaded, to the extent of producing a ludicrous effect, without entirely, or even essentially destroying the resemblance. C. may be regarded as the opposite of idealisation; the former consisting in a disproportionate development of some, very frequently of one only, of the characteristics of the

subject treated, the latter in a proportionate elevation of them all. Nay, further, the destruction of harmony is essential to C., and where harmony is the prevailing quality of its subject, the required effect may frequently be produced by this means alone; whereas harmony belongs of necessity to idealisation, and where its absence was the characteristic defect of the object as a real existence, an ideal of a lumble kind may frequently be produced by simply restoring it.

When used with reference to sensible representation, C. stands, to the genuine productions of the plastic and pictorial arts, in the same relation in which farce stands to the legitimate drama. Both C. and farce are thus degenerate forms of art; and though requiring much cleverness for their successful execution, and often affording lively satisfaction to the spectator, can scarcely be said in general to have an elevating object, or any other tendency than to amuse. When used as ancillary to well-directed and merited satire, C. assumes a nobler character, and it is to the credit of our nation that it is so frequently thus employed in our ephemeral literature. The best examples of C. which have ever appeared in the literature of any people, are to be found in the pages of *Punch*.

CARIES (*rottenness*) is a disease of bone analogous to the ulceration of soft tissues. It is characterised by a gradual loss of substance, from the particles of bone being absorbed, or being cast off and washed away in a purulent discharge. It begins as an unhealthy inflammation, followed by exudation of new materials, and softening of the part affected. On examination, the bone-cells are found filled with a reddish glairy fluid, and in scrofulous patients, deposits of tubercle. After C. has existed for some time, an abscess forms, and bursts; its aperture remains open, discharging a thin fluid, which contains particles of the bone. If a probe be passed through this opening, it will be felt to sink into some soft gritty substance; this is the carious bone, which, if removed, and well washed, will be found to resemble in whiteness and fragility loaf-sugar softening in hot water.

C. may attack any bone, but it usually selects the vertebrae, those of the wrist and foot, and the soft ends of long bones forming joints. To this terrible disease most deformities, not congenital, are owing. The carious vertebrae yield under the weight of the trunk, and the spine curves forwards, or to one side. In the joint-ends of bones, the part enlarges, the cartilages become affected, matter forms, and amputation of the limb, or excision of the joint, is frequently necessary to save the patient's life. Too often the disease recurs with night-sweats, hectic, and death.

The causes of C. are constitutional, though it may be accidentally determined to some particular part of the body by any irritation, such as a blow, or exposure to atmospheric changes. Scrofulous persons, and those who have had syphilis or mercury in excess at any period of their lives, are more subject to it than others. If affecting a small bone, the latter may be entirely removed; and if the disease is strictly limited to the ends of bones forming a joint, these may be excised. Within the last thirty years, great advances have been made in this department of surgery, and C. of the joints is but seldom counted a sufficient reason for amputation; the knee, hip, shoulder, elbow, ankle, and wrist joints have all been repeatedly excised successfully in this country. In situations where the part cannot be reached by instruments, lotions of dilute acid may be injected, with the view of stimulating the carious surface to assume a healing action.

The treatment of C. consists in supporting the patient's strength by judicious change of air, and tonics, with the administration of medicines, such as cod-liver oil in scrofula, which appear to combat the constitutional predisposition to the disease. In those parts where the diseased bone can be reached, it should be gouged or scraped away, so as to leave a healthy surface of bone, which may granulate up, and heal.

CARIES OF THE TEETH depends, it is supposed, on an original faulty formation of their substance, when, after any depressing cause, especially in scrofulous and ill-nourished persons, they soften and crumble away, at last laying open the cavity which contains the nervous pulp of the tooth, and producing toothache. *Treatment*.—The carious surface should be removed, and, as a substitute for the lost substance, gold or some other substance should be stuffed into the cavity. If the pulp be exposed, the hole should be stuffed with some softer material, till the parts are somewhat hardened; for this, Mr Tomes of London recommends a plug of cotton-wool dipped in a mixture of mastich, a drachm, and rectified spirit or Eau-de-Cologne, an ounce and a half; or of gutta-percha dissolved in chloroform.

CARIGNA'NO, a town of Piedmont, in the province of Turin, about 11 miles south of the city of that name. It is situated near the left bank of the Po, in the midst of a most beautiful country; has some fine churches, manufactures of silk-twist, and a population of 8000. This town gives name to a branch of the House of Savoy.

CARILLON. See BELL.

CARIMATA, a name applied to the passage between Borneo and Billiton; also to a cluster of islets in the same passage; and lastly, to the principal member of the group, whose highest point, a peak of 2000 feet, is in lat. 1° 36' S., and long. 108° 54' E.

CARINA'RIA, a remarkable and interesting genus of gasteropodous mollusks, of the order called *Heteropoda* or *Nucleobranchiata*, having a thin shell, in form somewhat like that of a limpet, which, however, only covers the visceral sac (heart, gills, &c.), leaving the greater part of the animal exposed. The shells of some of the species have been sometimes denominated *Venus's Slipper* and *Glass Nautilus*. The body is gelatinous, and so transparent that much of its interior organisation can be seen. Nearly opposite to the part of the hack occupied by the shell is a sort of vertical fin, answering to the foot of the other gasteropods. The species of C. are all marine, are found only in the seas of the warmer latitudes, and generally swim with the back downward. Closely allied to C. is the genus *Pivola*, in which there is no shell at all.

CARI'NI, a town of Sicily, in the intendency of Palermo, and 12 miles west-north-west of the city of that name. It has an old castle; and a population of 7000, chiefly engaged in fishing.

CARINO'LA, a town of Naples, in the province of Terra di Lavoro, 20 miles south-east of Gaeta. It has a cathedral, and a Franciscan convent. The district produces excellent wine. Pop. about 5000.

CARI'NTHIA (Ger. *Kärnten*), a crown-land of the Austrian empire, forming part of the old kingdom of Illyria, with an area of 3958 square miles, and a population, in 1857, of 332,593, a decrease of nearly 14,000, as compared with 1854. The principal river is the Drave, which passes through the country from

west to east, in a course of almost 150 miles. The general aspect of the country is mountainous, with long deep valleys, that of the Drave widening at Villach and Klagenfurt into a great plain. The valley of the Drave divides the *Noric* from the *Carinthian Alps*. Agriculture is carried on to a limited extent, owing to the mountainous character of the country, great part of which is occupied in pasture, or covered with brush-wood. Many horses and cattle are reared and exported. The principal products are mineral. One of the principal branches of industry is the manufacture of hardware; the other manufactures include woollens, silk stuffs, and cottons. The capital is Klagenfurt.—The ancient inhabitants were the *Carni*, who derived their name from the Celtic word *carn* or *corn*, Lat. *cornu*, Eng. *horn*—an allusion to the craggy, horn-like pinnacles of their hills. Before the time of Augustus, it belonged to Noricum, afterwards to the Roman empire. By and by the Carni were swept away in the deluge of immigration from the east, and Slaves settled in the country. After some time the Slaves themselves were so heavily oppressed by the Avari, that they called to their assistance a Frank, named Samo, who founded the kingdom of Carantania, which included much more than the present C., but fell to pieces after his death. Charlemagne added C. to the empire of the Franks, and made it a markgratdom. Finally, it came into the possession of Austria (q. v.).

CARI'SSA, a genus of plants of the natural order *Apocynaceae*. *C. Carandas* is a thorny shrub, much used for fences in India; and the fruit, called carandas—a berry about the size of a small plum—for tarts and preserves.

CARLEN, EMILIE, a well-known Swedish novelist, was born, 1810, in Stockholm, or, as some say, 1807, at Strömstad. Her maiden name was Schmidt or Smith. During childhood, her talent in imaginative fiction was remarked by her friends; but it was not till 1838 that her first novel, *Waldemar Klein*, was given to the world. She was then a widow, having been married, in 1827, to M. Flygare. In 1841, she was again married to J. G. Carlen, a lawyer, and known as a poet, in Stockholm. Her literary productiveness has been very remarkable, her fictions being chiefly founded on the characteristics of the lower orders in Sweden; and, although faulty in many respects, they are especially rich and striking in incident; and her characters, without exhibiting any very deep insight or subtle analytic power, are yet intelligible and consistent. Among her many works, which have been translated into English, are *The Rose of Thistledale*, *The Birthright*, *The Hermit*, *The Events of a Year*, *The Lover's Stratagem*, *Gustavus Lindurm*, *The Maiden's Tower*, *Woman's Life*, &c. Her works are largely circulated both in Europe and in America.

CARLETON, WILLIAM, one of the most popular living writers of tales describing Irish life and manners, was born, 1798, at Prillisk, in the county of Tyrone. Bred and educated among the peasantry, he passed through the common sufferings and privations of Irish poverty, and, after receiving some scanty instruction in a hedge-school, he, in his 17th year, went to an academy which a relative had opened at Glasslough, where he remained two years. Afterwards, a vague ambition led him to Dublin, where he arrived with only some three shillings in his pocket, and where, in 1830, he published his *Traits and Stories of the Irish Peasantry*. Their freshness of style pleased the public, and won the favour of critics. A second series, issued in 1832, was also well received; and, in 1839, he published

a powerful story, entitled *Fardorougha the Miser*, in several passages of which, however, his humour becomes extravagant. Subsequently, C. published a series of tales (3 vols., Dub. 1841), mostly of pathetic interest, but including a very genial and humorous sketch of the *Misfortunes of Barney Branagan*, which proved a great favourite. The story of *Valentine M'Clutchy* is half-political and half-religious in its tendency, defending the Irish Catholic priesthood, and advocating repeal of the Union; it appeared in 1845. Other narratives—*Rody the Rover*, 1846; *The Black Prophet*, 1847; and *The Tithe Proctor*, 1849—are more or less vehicles of party-spirit, but contain many proofs of the author's genius. *Willey Reilly*, 3 vols., appeared in 1855, and *The Evil Eye* in 1860. C. is the true historian of the Irish people. Sharing in their qualities of mind and temperament, he has a true sympathy with all their joys and sorrows, and a graphic and picturesque pen with which to describe them. In consideration of his literary services, he enjoys a government pension of £200 a year.

CARLI, GIOVANNI RINALDO, a distinguished Italian economist and archaeologist, was born at Capo d'Istria, April 1720. Educated at home and at Flambro in the Friuli, he was, in his 24th year, appointed professor of astronomy and navigation at Padua. In 1754, he published the first volume of his great work *On the History of the Coins and Currency, and on the Institution of the Mints of Italy*, the fourth and last volume of which appeared six years later. The book treats of the monetary history of Italy from the fall of the Western Empire until the 17th c., and is profusely illustrated with representations of coins, national and foreign, circulating in Italy during the various ages; and their value as compared with the price of provisions at different periods is also calculated. His merits as a financier were not overlooked. He was made President of the Council of Commerce and Public Economy at Milan, and afterwards President of the New Council of Finances, into which branch of administration he introduced many admirable reforms. The inhabitants were also indebted to his influence for the abolition of the Inquisitional Tribunal. He also wrote some valuable works on Istrian and other antiquities; dissertations on classical subjects; against sorcery; against Rousseau's theory of natural religion, &c. He died February 1795. His works, exclusive of his *Italian Antiquities*, were published in 19 vols. 8vo (Milan, 1784—1794).

CARLINE THISTLE (*Carlina*), a genus of plants of the natural order *Compositæ*, closely allied to the true Thistles, from which they are distinguished by the inner scales of the involucre spreading like rays, and being coloured and shining. These involucre scales are remarkably hygrometric, expanding in dry and closing together in wet weather, and this property they retain for a long time; the heads of flowers are therefore often nailed on cottage-doors in many parts of Europe, to indicate the weather. The name C. T. is derived from a legend, that an angel shewed the root of one of the species to Charlemagne as a remedy for a plague. This species, *C. acutis*, grows on hills and mountains, especially in calcareous soils in the middle latitudes of Europe. It has a very short stem, and very large heads of flowers, and was formerly in high repute for the medicinal virtues of its root—which is in large doses a drastic purgative—but its use is now almost confined to veterinary practice.—The only British species is the common C. T. (*C. vulgaris*), not unfrequent in England and some parts of Scotland, and sometimes rather a troublesome weed, but always indicative of a

poor soil. It has a stem about a foot high; and many purplish heads of flowers set amidst straw-coloured rays.



Carlina Thistle (*Carlina acutis*).

CARLINGS, in Ship-building, are small beams laid fore and aft, and resting upon the main or deck beams. These, with other pieces called *ledges*, laid at right angles to them, form a framework by which the deck is supported.

CARLISLE, a parliamentary and municipal borough, episcopal city, and ancient town in North Cumberland, the capital of the county, 12 miles east of the Solway Firth, 300 miles north-west-by-north of London, 101 miles south of Edinburgh, and 60 west-south-west of Newcastle. It is a chief station on the west railway route from London to Edinburgh, and is the terminus of seven different lines of railway. It stands on an eminence in a wide plain at the confluence of, and nearly surrounded by, the Eden, Caldew, and Peteril. Many fine new streets and buildings have been lately added to the city. The chief branches of industry are cotton, gingham, and check manufactures; print, iron, and dye works; and salmon-fisheries. It has a small cathedral of red freestone, of which Paley was archdeacon. The castle was founded in 1092, and is now a barracks; the remains of the keep form a massive lofty tower, with a very deep well. Mary Queen of Scots was confined in the castle after the battle of Langside. A canal of 11 miles, from Bowness on the Solway Firth to C., formerly admitted vessels of 100 tons; but the bed of the canal has now been converted into a railway, from which a line also branches to the newly formed port of Silloth, where an extensive dock has been constructed on the Solway, at a distance of 20 miles from Carlisle. Pop. in 1763, 4000; 1801, 10,221; 1851, 26,310. C. returns two members to parliament. In 1858, 833 vessels, of 72,697 tons, entered and cleared the Port of C., which stands where the canal formerly joined the Solway. Roman remains have been found here—coins, altars, inscriptions, brass incense vases, &c. Being near the west end of Hadrian's Wall, C. was probably a Roman station. It was the seat of the ancient kings of Cumbria. The Picts and Scots ravaged it. About 900, it was destroyed by the Danes, after which it remained desolate for 200 years. Thence to the union of England and Scotland, it was closely connected with the border wars, and underwent many sieges. To its being long a fortified border town it owed much

of its importance and privileges, but it declined much after the union. The C. corporation, in 1745, proclaimed Prince Charles king of Great Britain. The Duke of Cumberland afterwards took the city, and punished the chief actors with death, and the inhabitants with other cruelties. In 1133, Henry I. made C. a bishopric.—The C. Tables of Mortality, based on the deaths which occurred in C. 1779—1787, were drawn up by Dr Heysham, and have been ever since much used by life-insurance offices, as being nearest the average.

CARLISLE CATHEDRAL was commenced about 1092 by Walter, a Norman. It was founded by William Rufus, and dedicated in 1101 by Henry I.; and in 1133, was made the cathedral church of the newly formed diocese. A great part of the original Norman building was destroyed by fire in 1292. The new edifice contains specimens of all the styles of early English—simple pointed, geometric, and flowing. Two-thirds of the fine Norman nave, originally 141 feet long, were destroyed by Cromwell; the portion that was left has long been used as a parish church. In 1853, the restoration was commenced. The choir is one of the finest in England, 138 feet long, and 72 high, and consists of 8 pointed arches. The east window, consisting of 9 lights, is considered the finest decorated window in England. The tower is very low, rising but one story above the choir. It formerly supported a timber spire, which was removed in 1661. This cathedral has four canons.

CARLISLE, GEORGE WILLIAM FREDERICK HOWARD, EARL OF, K.G., was born April 18, 1802. Educated at Eton and Oxford, he, in 1821, obtained the Chancellor and Newdegate prizes for his Latin and English poems. He entered the public service in 1826 as an attaché. In 1830, he (then Lord Morpeth), along with Henry (now Lord) Brougham, was elected one of the representatives of the important constituency of Yorkshire, and after the Reform Bill for the West Riding, a position which he held in the liberal interest for several years. Under the administration of Lord Melbourne, he held the office of chief secretary for Ireland (1835—1841), and his impartial distribution of patronage made him very popular in Dublin. Rejected in 1841 by the West Riding, he was again elected in 1846, and remained one of its representatives until the death of his father (1848) called him to the House of Lords. Under Lord John Russell's ministry (1846—1852), he was Chief Commissioner of Woods and Forests, and afterwards Chancellor of the Duchy of Lancaster. When Lord Palmerston was made prime minister in 1855, C. was appointed Lord Lieutenant of Ireland, a post which he held until the advent of the Earl of Derby's government in 1858; and he succeeded to the same office again when Lord Palmerston was reinstated in 1859. C. has obtained some reputation as a literary man, chiefly by his lectures on his travels in the United States, on the life and writings of Pope, and his *Diary in Turkish and Greek Waters*.

CARLOS, Don, Infante of Spain, born July 3, 1545, at Valladolid, was the son of Philip II. After his recognition as heir to the throne, in 1560, Don C. was sent to study at the university of Alcalá de Henares; where, however, he profited so little, that the king, regarding him as unqualified to reign, invited a nephew, the Archduke Rudolf, to Spain, intending to make him heir to the throne. Excluded from all participation in the government, Don C. conceived a strong aversion toward the king's confidants, and especially was unwilling that the Duke of Alva should have the government of Flanders. In confession to a priest, on Christmas

eve 1567, he betrayed his purpose to assassinate a certain person; and as the king was believed to be the intended victim, this confession was divulged. The papers of Don C. were seized, and being tried, he was found guilty of conspiring against the life of the king, and of traitorously endeavouring to raise an insurrection in Flanders. The sentence was left for the king to pronounce. Philip declared that he could make no exception in favour of such an unworthy son; but sentence of death was not formally recorded. Shortly afterwards, he died, July 24, 1568, and was interred in the Dominican monastery, El-Real, at Madrid. The suspicion that he was poisoned or strangled, has no valid evidence to support it. Schiller, in his tragedy *Don Carlos*, has widely departed from historical testimonies.

CARLOS DE BOURBON, DON MARIA ISIDOR, born March 29, 1788, was the second son of Charles IV. of Spain, and was educated chiefly by priests. After the expulsion of the French from Spain, his brother, Ferdinand VII., reascended the throne; but having married thrice without issue, Don C. began to cherish the hope of succeeding his brother. An insurrection in his interest broke out in 1825, in Catalonia; but was put down, Don C. himself not participating in it. A fourth time, however, the indefatigable Ferdinand married, and the result was a daughter, the Infanta Maria Isabella (present queen of Spain), born October 10, 1830. Now, as the Salique Law, excluding females from succession to the throne, had been abrogated, the hopes of the Carlists, as the followers of Don C. were called, were destroyed. During the illness of the king, in September 1832, the Carlists succeeded so far as to win from him a re-institution of the Salique Law; but he revoked it again as soon as he had partially recovered, and thus Don C. was again disappointed. As he still continued his agitation, he was banished, in 1833, to Portugal, and, soon afterwards, was commanded to reside in the Papal States. But before C. had embarked for Italy, King Ferdinand VII. died, September 29, 1833. Don C. was now recognised as heir to the throne of Spain, not only by the Carlists but also by Dom Miguel in Portugal; and having refused to obey the queen-regent's order for his deportation to Italy, he was declared a rebel, October 16, 1833. By the quadruple alliance of Spain, Portugal, England, and France, both C. and Dom Miguel were banished from Portugal, and in June 1834, the former embarked for England. In the following month, he returned to the continent, passed in disguise through Paris, and travelled through Bordeaux and Bayonne, into Spain, where he excited an insurrection in the northern provinces, but was ultimately compelled to escape into France. In 1836, his claims to the throne were unanimously rejected by the Constituent Cortes. Subsequently, Don C. lived for some time at Bourges, in France, where he kept up the pompous etiquette of the Spanish court. In 1844, he abdicated in favour of his eldest son, also named Don Carlos; and in 1847 he was permitted to retire to Trieste, where he died, March 10, 1855.—DON CARLOS, the Younger, born January 31, 1818, is better known as the Count de Montemolin. This second pretender made an attempt, in April 1849, to pass under a disguise through France into Spain, but failed, and was imprisoned for a few days in the citadel of Perpignan. Recently (1860), a Carlist insurrection was once more attempted, in consequence of which the Count de Montemolin and his brother were arrested, but liberated after the former had written and signed a renunciation of all his claims to the Spanish throne. Against this act his brother Ferdinand has registered his protest.

CARLOVINGIANS, the second dynasty of Frankish kings. The origin of the family is traced to Arnulph, Bishop of Metz, who died in 631. His son, Anagéise, married a daughter of Pepin, of Landen, in Austrasia. His sons, Martin and Pepin d'Heristall (q. v.), as the greatest territorial lords in Austrasia, were called to the office of Mayor of the Palace. Martin was assassinated; Pepin, by force of arms, compelled the weak Merovingian king, Theodoric III., to invest him with the offices of Mayor of the Palace in all the three Frankish states, Neustria, Austrasia, and Burgundy. Pepin allowed the Merovingian kings to remain upon the throne, but they were kings only in name. He died on 17th December 714, and left as his successor, his young grandson, Theodoald; but Charles Martel (q. v.), a natural son of Pepin, was made Mayor of the Palace by the Austrasians, and in this capacity subjected the three states to his power. He died in 741. His two sons, Carloman and Pepin le Bref, divided the kingdom, although for a time the nominal Merovingian dynasty still subsisted; but Pepin at last formally assumed the royal power, and was crowned King of the Franks on 3d May 752. This is the formal commencement of the Carolingian dynasty. Pepin began the conquest of Italy. His sons, Carloman and Charles the Great or Charlemagne (q. v.), succeeded him, of whom the latter soon reigned alone, and prodigiously extended his dominions. In 800, Pope Leo III. set upon his head the crown of the Western Roman Empire. He divided his dominions amongst his sons, of whom, however, only one, Louis le Débonnaire, survived him, who, in the list of the kings of France, appears as Louis I., but who was properly Emperor and King of the Franks. With Charlemagne, however, the high abilities of his family suddenly disappeared, and his successors shewed much weakness of character. Family feuds broke out during the life of Louis le Débonnaire, who had divided his dominions in part amongst his sons, and he terminated an inglorious reign in 840. By a treaty concluded in August 843, Lotharius I., the eldest son of Louis, obtained the imperial crown and the kingdom of Italy, with Lorraine, Franche Comté, Provence, and the Lyonnais; Louis, his brother, called Louis the German, obtained the German part of his father's dominions; and Charles the Bald, the son of a second marriage, obtained Neustria, Aquitania, and the *Spanish Mark*, and may almost be regarded as the founder of the French monarchy. The Emperor Lotharius I. died in 855, and his dominions were again divided—his eldest son, Louis II., being Emperor and King of Italy, and his two other sons kings of Lorraine and of Provence, but their kingdoms reverted to the emperor.—Charles the Fat, a son of Louis the German, having become emperor, was elected by the French nobles to be their king in 882; and being previously in possession of Italy and Germany, united under his sway great part of Charlemagne's empire. But he was a weak monarch, and was deposed in 887. The imperial dignity passed by the marriage of the daughter of the Emperor Arnulph with Fritlar, Count of Franconia, to another family. The French dynasty, of which Charles the Bald may be deemed the founder, continued in a succession of weak monarchs for about a century, till it terminated with the reign of Louis V., on whose death, Hugh Capet, the most powerful nobleman in France, seized the crown in 987. The Carolingian kings had for some time previous possessed no real power. A subsequent marriage, however, connected their family with that of the Capets, and enabled the kings of France to trace their descent from Charlemagne.

The Carolingian dynasty figures in the early history of France as the ally of the church. It aided the popes against the Lombards; made war on the Aquitanians, who pillaged and despoiled the churches; established the temporal power of the successors of St Peter; subdued and converted the still pagan Saxons; and fought the Mohammedans in Spain. Nor, on the other hand, do we find the church ungrateful: it sanctioned, by benediction and prayer, the conquests of this powerful family; in various ways impressed its sacred stamp of approbation upon it; and for its sake resuscitated the imposing idea of an empire of the west. But this alliance, which was advantageous to the policy of kings like Pepin le Bref and his son Charlemagne, because they had genius, vigour, and design, became at a later period, under their feeble successors, a chief cause of the overthrow of the dynasty, for the clergy after 814 grew stronger and more exacting every day, and forced the monarchs to new concessions.

CARLOVITZ, or KARLOVITZ, a town of the Austrian empire, in the military frontier of Slavonia. It is situated on the right bank of the Danube, about 8 miles south-south-east of Peterwardein, and is noted for its excellent wine, and for the treaty concluded here in 1699. The wine—especially the red variety—ranks with the best and strongest obtained in Hungary, and in some years the product has amounted to about 1½ million of gallons. Pop. about 5000. The important treaty or peace of C. was concluded, in 1699, between the allies Austria, Russia, Poland, and Venice on one side, and the Porte on the other, and included the following articles: That Austria should repossess the territories captured by the Turks during two centuries (which included Hungary and Slavonia, and she also acquired Transylvania); that Venice should hold the Morea as far as the isthmus; that Poland should take back Podolia and the lands in the Ukraine conquered by Mohammed IV., but should cede certain places in Moldavia; and that Russia should have the territory of Azof.

CARLOW, the capital town of Carlow county, Ireland, situated at the confluence of the Burren and the Barrow, 56 miles south-west of Dublin by rail. It is a well-built town, with two principal streets, from which branch many smaller ones, and a suburb, Graigue, in Queen's County, on the opposite side of the river, with which it is connected by a bridge. It has a Roman Catholic cathedral and divinity college. C. has extensive flour-mills, and is the emporium for the agricultural produce of the district, which is largely exported from this place. Pop. 9121. It returns one member to parliament. There are here the remains of a castle, picturesquely situated on an eminence on the Barrow, founded in 1180 by Sir Hugh de Lacy. In 1361 the Duke of Clarence established the Exchequer of the kingdom in this place. It constituted one of the boundaries of the PALE, beyond which the king's writ was not recognised by the 'Irishry.' Its first charter was granted in the 13th c. by William Marshall, Earl of Pembroke. The town grew up around this castle, which was several times besieged by, and alternately in the possession of, the English and Irish. The castle (one of great extent) was in the possession of the insurgents in 1650, when it was closely invested by General Ireton and the republican army. The garrison surrendered on conditions to Sir Hardress Waller, whom Ireton had left to conduct the siege. It was then dismantled; and about one-half of this once stately castle now remains a picturesque ruin. In the Irish insurrection of 1798, the insurgents attacked the town, but were repulsed by the

garrison and yeomanry, and 600 of them killed. The Barrow is here navigable for small-craft to its junction with the Grand Canal at Athy.

CARLOW, a small inland county of Ireland, in Leinster province, with an area of about 346 square miles, of which $\frac{5}{8}$ ths are arable. C., except in the southern extremity, where it is hilly, is a triangular fertile level, or gently undulating plain, between the Wicklow and Wexford range of hills on the east, and the highlands beyond the Barrow on the west. The chief rivers are the Barrow and Slaney. C. consists chiefly of granite, covered in the middle plain, or richer tracts, by limestone gravel, on which are fine loams and pasture. In the uplands, the soil is gravelly. Lower, carboniferous limestone crops out in the valley of the Barrow. On the west side of the county begins the great coal district of Leinster. In 1858, $\frac{3}{4}$ ths of the county was in crop, the chief crops being oats, potatoes, barley, and wheat. There are many dairies on the plains. The chief exports are corn, flour, meal, butter, &c. Along the Barrow, which falls above a foot per mile, are a great many extensive corn-mills. Pop. 1841, 86,228; 1851, 68,059. It returns two members to parliament. In 1851, there were in the county 59 national schools, with 6948 scholars. The chief towns are Carlow, Tullow, and Bagenalstown. At Old Leighlin a synod was held in 630, to settle the time of Easter. Several engagements occurred in the county during the Irish rebellion of 1798. The chief antiquities of C. are cromlechs, castles, and the cathedral church of Old Leighlin. A cromlech near Carlow town has a covering stone 23 feet long, and of nearly 90 tons.

CARLSBAD, or **KAISER-KARLSBAD**, a town in Bohemia, much celebrated for its hot mineral springs, and frequented in summer by visitors of the most aristocratic character from all parts of Europe. The permanent population does not amount to more than about 4000, who mostly live by services rendered to the visitors, or by making articles of various kinds, chiefly of Bohemian glass, to be sold to them. The visitors in a season, which usually lasts from 15th June to 15th August, amount to 5000 or 6000. The wells have been frequented from a very early period, but have been of great celebrity since the 14th century. The scenery is extremely beautiful. The town is well built, the accommodation for guests good, and the place free from some of the abuses too common at other German spas. No gaming-houses exist here. The temperature of the hot springs varies from 117° to 165° Fahrenheit. The principal spring, the Sprudel, has a very large volume, and is forced up to a height of 3 feet from the ground. Altogether, the daily flow of the springs of C. is estimated at 2,000,000 gallons. The principal ingredient in the water is sulphate of soda. The whole town of C. appears to stand on a vast caldron of boiling water, which is kept from bursting only by the safety-valves the springs provide. On one occasion, after an explosion, poles of 30 fathoms in length, thrust into the aperture, did not reach the bottom. A congress of German powers was held here in August 1819, in which various resolutions, denunciatory of a free press and liberal opinions, were arrived at, and measures of repression determined on.

CARLSBURG, or **KARLSBURG**, a town of Transylvania, situated on the right bank of the Maros, here crossed by a bridge some 200 yards in length, 48 miles south of Klausenburg. It is built partly on a hill, and partly in a valley, is fortified, and has a citadel surrounded by walls with bastions. Gold and silver, obtained from the mines of Transylvania, are purified and coined here. The only

manufacture of importance is saltpetre. Maros Porto, the chief shipping-place for Transylvanian rock-salt, is within half a mile of the town. C. occupies the site of the ancient *Apulum*, remains of which are still found. Pop. 12,300.

CARLSKRONA, capital of the province of the same name in Sweden, is situated on the rocky island of Trotsö, and its adjoining islets in the Baltic, which are connected by bridges, in lat. 56° 9' N., long. 15° 35' E. The town was built in 1680 by Charles XI., who gave it his own name, and conferred upon it several important privileges, besides making it the great naval station and arsenal of Sweden, instead of Stockholm. It has a magnificent harbour, with a sufficient depth of water to float the largest vessels. The only practicable entrance for large ships is defended by two strong forts. The dry docks, blasted out of the granite rock at vast expense, are an attraction to strangers. The inhabitants are chiefly employed in connection with the arsenal. Pop. (1859) 14,513.

The province of C. or Bleking is situated in the south of Sweden, in lat. 56°—56° 30' N., long. 14° 30'—16° E. It has the Baltic on its south and east margins. It has an area of about 1130 square miles, with a population (1855) of 111,255. It is hilly without being mountainous, and generally fertile, yielding rye and potatoes abundantly, and also wheat, oats, and peas. The fisheries employ a considerable number of the inhabitants.

CARLSRUHE, the capital of the grand duchy of Baden, is situated a few miles eastward from the Rhine. It was founded by the Markgraf Charles-William of Baden-Durlach, in 1715, and built on a curious and regular plan in connection with the palace, which constitutes the centre point from which the streets, so far as constructed, diverge in the shape of an extended fan. The streets are wide and well paved. There are a number of fine buildings; flourishing educational institutions; the Court Library contains 80,000 vols.; a public library, 90,000; and there are valuable collections of antiquities, objects of natural history, &c. An aqueduct from the Durlach supplies the town with water. In the market-place, which is the finest of the public squares, a stone pyramid encloses the remains of the founder of the city. The manufactures include jewellery, carpets, chemical products, cloth, carriages, tobacco, &c. C. is now one of the principal stations on the railway through the Grand Duchy of Baden. Pop. (1858) 25,762.

CARLSTAD, a town of Sweden, on the island of Tingvalla, in Lake Wenern, about 160 miles west of Stockholm. It is connected with the mainland by two bridges, one of which is a large and very handsome structure. The town is well built, has a cathedral, cabinet of natural history, &c., and commands extensive views of the most beautiful scenery. Its trade is large, consisting in exports of iron, copper, timber, and corn. Pop. between 4000 and 5000.

CARLSTADT, a town of Croatia, in Austria, situated in a rich plain between the rivers Kulpa and Korona, 33 miles south-west of Agram. It is fortified—the original fortress having been erected in the 16th c. to resist the Turks—has an old castle, and armoury of 30,000 stand of arms. It has a large garrison, the Austrian executive looking upon it as a place of considerable importance, on account of its position on a navigable river, and on the great road into the centre of Croatia from the coast. It has few manufactures, but an active transit trade. Pop. 6600.

CARLUKE, a municipal borough in the middle

of Lanarkshire, near the right bank of the Clyde, 6 miles north-west of Lanark. Pop. 2845. There are cotton manufactures and much weaving, besides coal, iron, and limestone mines. The orchards around cover 130 acres. Not far off is Lec, the seat of the Lockharts, where is preserved the famous Lee Penny, noticed by Sir W. Scott in the *Talisman*. Roman coins have been found here. General Roy, the antiquary, author of the *Military Antiquities of the Romans in North Britain*, was a native of Carluke.

CARLYLE, THOMAS, was born 4th December 1795, in the town of Ecclefechan, parish of Hoddum, Dumfriesshire, Scotland. Educated first at the parish school, and afterwards at Annan, he passed to Edinburgh University, with a view to entering the Scottish Church, in his 15th or 16th year. Here he studied irregularly, but with amazing avidity. The stories which are related of his immense reading are almost fabulous. About the middle of his theological curriculum, C. felt wholly disinclined to become a clergyman, and, after a short period spent in teaching at Dysart, in Fifeshire, he embraced literature as a profession. His first efforts were contributions to Brewster's *Encyclopædia*. In 1824, he published a translation of Legendre's *Geometry*, to which he prefixed an Essay on Proportion, mathematics having, during his college years, been a favourite study with him. In 1823—1824 had appeared in the *London Magazine* his *Life of Schiller*, and, during the same year, his translation of Goethe's *Wilhelm Meister*. In 1825, the *Life of Schiller* was recast, and published in a separate form. It was very highly praised; indeed, one can discern in the criticisms of the book certain indications of the genius of Carlyle. The translation of *Wilhelm Meister* met with a somewhat different fate. De Quincey, in one of his acrid and capricious moods, fell foul both of Goethe and his translator; while Lord Jeffrey, in the *Edinburgh Review*, admitting C. to be 'a person of talents,' slashed in cavalier fashion at the book. In 1827, C. married Miss Welch, a lineal descendant of John Knox, and, during the same year, appeared his *Specimens of German Romance* (4 vols., Tait, Edinburgh). From 1827 to 1834, he resided chiefly at Craigenputtock, a small property in Dumfriesshire, belonging to his wife—the 'loneliest nook in Britain,' as he says himself in a letter to Goethe, 'fifteen miles north-west of Dumfries, among the granite hills and the black morasses which stretch westward through Galloway almost to the Irish Sea.' Here C. revolved in his mind the great questions in philosophy, literature, social life, and politics, to the elucidation of which—after his own singular fashion—he has earnestly dedicated his whole life. Here, also, he commenced to write the splendid series of critical and biographical essays which first familiarised Englishmen with the riches of modern German thought. For this work, he was incomparably better fitted than any man then living in Great Britain. Possessing a knowledge of the German tongue such as no foreigner ever surpassed, he was also inspired by the conviction, that the literature of Germany in depth, truthfulness, sincerity, and earnestness of purpose, was greatly superior to what was admired and relished at home. Gifted, moreover, in a degree altogether unexampled, with a talent for portraiture, he soon painted in ineffaceable colours on the British memory, the images of Schiller, Fichte, Jean Paul Richter, and other foreign magnates, until then almost unheard of. Gradually, educated circles awoke to the fact, that a literary Columbus had appeared among them, who had discovered a 'New World' of letters, the freshness and grandeur of

which were sure to attract, sooner or later, multitudes of adventurous spirits. One of his most beautiful, eloquent, and solid essays written at Craigenputtock, was that on *Burns* (*Edinburgh Review*, 1828). It has given the tone to all subsequent criticism on the Scottish poet. The article on *German Literature*, in the same periodical, is a masterly review of a subject, the importance of which C. at length succeeded in compelling his countrymen to acknowledge. But his *chef-d'œuvre*, written on his moorland farm, was *Sartor Resartus* ('The Tailor done over,' the title of an old Scottish song). This work, like all his after-productions, an indescribable mixture of the sublime and the grotesque, was offered to various London firms, and rejected on the advice of their sapient 'tasters,' and at length published in successive portions in *Fraser's Magazine* (1833—1834). It professes to be a history or biography of a certain Herr Teufelsdröckh ('Devil's Dirt'), professor in the university of Weissnichtwo ('Kennaquhair'), and contains the manifold opinions, speculations, inward agonies, and trials of that strange personage—or rather of C. himself. The whole book quivers with tragic pathos, solemn aspiration, or riotous humour. C. now removed to London, where he still resides. In 1837 appeared the first work which bore the author's name, *The French Revolution, a History*. Nothing can be more gorgeous than the style of this 'prose epic.' A fiery enthusiasm pervades it, now softened with tenderness, and again darkened with grim mockery, making it throughout the most wonderful image of that wild epoch. C. looks on the explosion of national wrath as a work of the divine Nemesis, who 'in the fulness of times' destroys, with sacred fury, the accumulated falsehoods of centuries. To him, therefore, the Revolution is a 'truth clad in hell-fire.' During the same year, he delivered in London a series of lectures on *German Literature*; in 1838, another series on *The History of Literature, or the Successive Periods of European Culture*; in 1839, another on *The Revolutions of Modern Europe*; and a fourth in 1840, on *Heroes, Hero-worship, and the Heroic in History*; of these only the last has been published. Meanwhile, the first edition of his *Miscellanies* (contributions to the reviews) had appeared in 1838, and his *Chartism* in 1839. In 1843 followed *Past and Present*, which, like its predecessor, shewed the deep anxious sorrowful interest C. was taking in the actual condition of his countrymen. In 1845, he published what is by many considered his master-piece—*Oliver Cromwell's Letters and Speeches, with Elucidations and a Connecting Narrative*. The research displayed in this book is something marvellous, but the author has been nobly rewarded for his toil, inasmuch as his vindication of the Protector's character is most triumphant. To C. has thus fallen the unspeakable honour of replacing in the Pantheon of English history the statue of England's greatest ruler. In 1850, the *Later-day Pamphlets*, the fiercest, most sardonic, most furious of all his writings, came out. The violence of the language in these pamphlets offended many. Next year (1851) appeared the *Life of John Sterling*—a biography of intense fascination for the younger intellects of the age. The latest production of C. is the first and second volumes of *The History of Frederick II. of Prussia*—called *Frederick the Great* (1858). The remaining volumes are announced for publication.

What position C. will ultimately occupy in the literature of his country, is not easy to determine. That his *genius* will never want ample recognition, is most certain; but his *writings* derive so much of their interest and power from what is peculiar to,

CARMAGNOLA—CARMONA.

or at least characteristic of, the present time, that future ages may possibly wonder at their fiery splendours, and fail to sympathise with their prophetic enthusiasms.

CARMAGNO'LA, a town of Piedmont, situated near the left bank of the Po, about 16 miles south of Turin. It has a massive old tower, the remains of a very strong castle, which formerly served as a defence for the town. The *condottiere*, Francesco Bussone, afterwards Conte di Carmagnola, was a native of this place. It has manufactures of jewellery, and a trade in silk, flax, linen, cattle, and agricultural produce. Pop. 13,000.

CAR'MAGNOLE, the name of a popular song and dance, which was notorious as the accompaniment of many excesses in the French Revolution. It first became popular in the south of France, where it was named after Carmagnole, in Piedmont, the home of many Savoyard boys who played the tune. The song began with :

Madame Vêto avait promis,

and every verse ended with the refrain :

Dansons la Carmagnole—vive le son—du canon !

Fashion soon adopted the word, which was next applied to a sort of jacket, worn as a symbol of patriotism. Afterwards, it was applied to the bombastic and fanatical reports of the successes and glory of the French arms. With the Reign of Terror, the song and the jacket, associated with so many dismal recollections, together disappeared.

CAR'MEL is a mountain-ridge, 6 or 8 miles long, stretching nearly north and south from the plain of Esdraelon into the sea, the only great promontory on the low coast of Palestine. It is composed of a whitish stone, in which flints, sometimes curiously shaped, are imbedded. The height has been variously stated, but is probably about 1000 feet above the level of the plain. On the east is the river Kishon, and the Plain of Esdraelon; on the west, a small plain descending to the sea. Oaks, pines, olives, laurels, and other trees grow abundantly on the mountain; and various wild-fruits evince its ancient fertility and cultivation. The name C. means, *The garden of God*, or 'a very fruitful region.' Mount C. is renowned in Jewish history, and is often alluded to in the imagery of the prophets. On the summit of Mount C., there is a monastery called Elias, after the prophet Elijah, the monks of which take the name of 'Carmelites.' It is built on the supposed site of the grotto where Elijah lived, and the spot where he slew the priests of Baal. For an invalid in search of retirement, with every beauty that climate and natural scenery can offer, there can be no place superior to the convent on Carmel.

CARMEL, KNIGHTS OF THE ORDER OF OUR LADY OF MOUNT, were instituted by Henry IV. of France, and incorporated with the Order of the Knights of St Lazarus of Jerusalem. The Order of Mount C. consisted of 100 gentlemen, all French, who were to attend the king in his wars, and had considerable revenues assigned to them. The order was confirmed by bull by Pope Paul V. in 1607. The great master was created by the king putting about his neck a tawny ribbon, suspending a cross of gold, with the cloak of the order, and granting him power to raise 100 knights. None were admitted but those who had four descents of nobility both by father and mother.

CAR'MELITES, or **ORDER OF OUR LADY OF MOUNT CARMEL**, a monastic order probably founded as an association of hermits on Mount Carmel by Berthold, Count of Limoges, about 1156. A legend, however, ascribes the foundation of the order to the prophet Elijah; and another makes the Virgin Mary to have been a Carmelite nun. Driven out by the Saracens in the 13th c., the C. wandered over Europe; and Simon Stoch, their general, changed them into a mendicant order in 1247. From that time, they shared in the usual vices of the mendicant orders. They subsequently divided into several branches, more or less rigid in their rules, one distinguished by walking barefooted. They exist at the present day in many Roman Catholic countries.—The order of *Carmelites*, or *Carmelite Nuns*, was instituted in 1452, and is very numerous in Italy.

CARMINATIVES (from Lat. *carmen*, a charm), medicines to relieve flatulence and pain in the bowels, such as cardamoms, peppermint, ginger, and other stimulating aromatics.

CAR'MINE, or **CARMIN** (Arabic, *kermes*), is a beautiful red pigment obtained from cochineal, and which is employed in the manufacture of the finer red inks, in the dyeing of silk, in colouring artificial flowers, and in miniature and water-colour painting. It was first prepared by a Franciscan monk at Pisa, who discovered it accidentally, while compounding some medicine containing cochineal; and in 1656, it began to be manufactured. It is the finest red colour known, and was more largely used formerly than now for imparting a healthy aspect to the cheek of beauty. One process for its preparation is to digest 1 lb. of cochineal in 3 gallons of water, for 15 minutes; then add 1 ounce of cream of tartar; heat gently for 10 minutes; add half an ounce of alum; boil for 2 or 3 minutes; and after allowing any impurities to settle, the clear liquid is placed in clean glass pans, when the C. is slowly deposited. After a time, the liquid is drained off, and the C. dried in the shade. In the preparation of C., much depends on a clear atmosphere and a bright sunny day, as the pretty colour of the C. is never nearly so good when it has been prepared in dull weather, and this accounts in great part for the superiority of French C. over that prepared in England. The great expense of pure C. has led to the fabrication and vending of substitutes. The *rouge* of the theatres is made from red sandal-wood, Brazil wood, benzoin, and alum, which are boiled in brandy or vinegar till a paint of an intense red colour remains. A more harmless material is obtained by evaporating the mixture till the liquid is driven off, and making up the red residue with balm of Mecca, spermaceti, or butter of cacao. The depth of the red tint may be lessened by the addition of chalk. The little colour-sauces called *rouge dishes*, obtained from Portugal, contain pure C.; but imitations are made in London. *Spanish wool* and *Oriental wool*, which are impregnated with red paint, intended for use on the cheek for improving the complexion, are seldom genuine.

CAR'MÔË, or **KARMÔË**, an island of Norway, at the entrance of the Bukke Fiord, in the North Sea, and 20 miles north-west of Stavanger, in lat. 59° 20' N., long. 5° 15' E. A strait 2 miles in width separates it from the mainland. With a length of 21 miles, and average breadth of 5, it has a population of 6400, who are principally engaged in the fisheries, and in cattle-rearing.

CARMO'NA, a town of Andalusia, Spain, 20 miles north-east of Seville. It is situated on an

CARNAC—CARNELIAN.

elevated ridge, overlooking a rich and olive-clad plain, and its old massive Moorish walls and castle give it a very picturesque appearance. It has a fine old Gothic church, and the gates of Cordova is a most interesting piece of architecture. It has manufactures of woollen cloth, hats, leather; also flour and oil mills, and an important annual cattle-fair. Pop. 15,121.

CARNAC, a village in the department of Morbihan, France, 17 miles south-east of Lorient. It is remarkable on account of the great Celtic monument situated about three-quarters of a mile from this village, on a wide desolate plain near the seashore. The monument consists of 10,000—12,000 rude broken obelisks of granite, resting with their smaller ends in the ground, rising, many of them, to a height of 18 feet, though a large proportion does not exceed 3 feet, and arranged in 11 parallel rows, forming 10 avenues, extending from east to west, and having at one end a curved row of 18 stones, the extremities of which touch the outer horizontal rows. The origin and object of the monument remain a mystery. Similar but smaller structures are found to the west of C., at Erdevan and St Barhe.

CARNAHUBA PALM, or **CARANAIBA PALM** (*Copernicia cerifera*), a very beautiful species of palm, which abounds in the northern parts of Brazil, in some places forming vast forests. It attains a height of only 20 to 40 feet; but its timber is valuable, is used in Brazil for a great variety of purposes, and is imported into Britain for veneering. The fruit is black, and about the size of an olive; it is sweet, and is eaten both raw and prepared in various ways. Scales of wax cover the under side of the leaves, and drop off when the fallen and withered leaves are shaken. Being collected in this way, the wax is melted into masses; and bees' wax is often adulterated with it. It has been imported into Britain, and used in the manufacture of candles, but no method has yet been devised to free it of its yellowish colour.

CARNA'RIA (Lat. *caro, carnis*, flesh), the Latinised form of the French *Carnassiers*, the name given by Cuvier to a great order of *Mammalia*, which, according to his system, includes all the not marsupial *Feræ* of Linnæus, and along with them the bats, from the Linnæan order *Primates*. The C. have the toes terminated by claws; none of them have an opposable thumb on any of the extremities; they have incisors or cutting teeth, canine teeth or tusks, and molar teeth or grinders, but their dentition varies according to their kind of food, some preying on insects, others on the higher animals, whilst many of them are by no means exclusively addicted to animal food, but subsist in great part, and a few bats entirely, on vegetable substances. Cuvier at first included the marsupial quadrupeds in this order; but afterwards, recognising more fully the great importance of the characteristic from which they derive their name, constituted them into a distinct order, the remaining C. being divided into *Cheiroptera* (Bats, q. v.), *Insectivora* (q. v.), and *Carnivora* (q. v.).

CARNA'TIC, a country of somewhat indefinite dimensions on the east or Coromandel coast of the peninsula of Hindustan. While some carry it as far inland as the Western Ghauts, others limit its breadth to about 75 miles. The length is generally taken from Cape Comorin to about 16° north. The C. is no longer a recognised division of the country, and exists only in history as the grand theatre of the struggle of last century between France and England for supremacy in India.

CARNATION (from Lat. *caro*, flesh). Flesh-tints

in painting are called carnations. The art of producing the true colour of flesh, from the rarity with which it is acquired by artists, would seem to be one of the most difficult branches of colouring. Whether from their painting less from the nude than the old masters, or from some other cause, it is certain that the moderns, and particularly the English, have been very unsuccessful in this respect. It is said that the pigments must be laid on thick and pasty. The ochres are preferable to vermilion for the local colours; and ultramarine ashes, or Veronese green, mixed with asphaltum, may be used for the shadows.

CARNATION, one of the finest of florists' flowers, a double-flowering variety of the Clove Pink (*Dianthus caryophyllus*, see **PINK**), and existing only in a state of cultivation. It has long been a universal favourite, both on account of its beauty and fragrance, although it does not appear to have been known to the ancients. The stem is about three feet high, and generally receives support. There are varieties, called *Tree Carnations*, with much taller stems, but they are not amongst the varieties esteemed by florists. The flowers are often three inches or more in diameter. Scarlet, purple, and pink are the prevailing colours; but whatever are the colours of a C., it is of no value, in the eyes of a florist, unless they are perfectly distinct. Fulness and perfect regularity are also deemed essential. The varieties are extremely numerous: those which have only two colours, disposed in large stripes through the petals, are called *Flake Carnations*; those which have three shades of colour, also in stripes, *Bizarre Carnations*; and those which have the flowers spotted with different colours, and the petals serrated or fringed, receive the name of *Picotees*. Great attention is at present paid in Britain to the cultivation of the C., and very fine specimens are often to be seen in the gardens of cottagers, especially about towns and villages. The soil for carnations must be rich, rather open, and the manure well rotted and intimately mixed. The finest kinds are generally grown in pots, and receive protection from cold winds and heavy rains, although free access of air is indispensable. Carnations are propagated in summer either by layers or by *pipings*, which are short cuttings of shoots that have not yet flowered, each having two joints. The young plants are transferred in spring to the bed in which they are to flower.

CARNE'ADES, a Greek philosopher, born at Cyrene, in Africa, about 213 B. C. He studied logic at Athens under Diogenes, but became a partisan of the Academy, and an enemy of the Stoics, whose stern and almost dogmatic ethics did not suit his sceptical predilections. Conspicuous for his eloquence and skill in 'tongue-fence,' he was destitute of any convictions moral or intellectual, and had even arrived at the conclusion that no criterion of truth existed in man. In 155 B. C., along with Diogenes and Critolaus, he was sent as ambassador to Rome, where he delivered two orations on justice, in the first of which he eulogised the virtue, and in the second proved that it did not exist. Honest Cato, who had no relish for intellectual jugglery, and thought it a knavish excellence at the best, moved the senate to send the philosopher home to his school, lest the Roman youth should be demoralised. C. died at Athens, 129 B. C. He was remarkable for his industry, negligent habits, and impatient temper.

CARNELIAN, or **CORNELIAN**, in Mineralogy, the name given to some of the finer varieties of Chalcedony (q. v.). The colour is blood red or flesh-colour, reddish brown, reddish white or yellow, more

rarely milk white. The fracture is in the common C. perfectly conchoidal, but there is a variety of a somewhat fibrous structure with a splintery fracture. C. is found in pieces of irregular form and in lamellar concretions. The finest specimens are brought from the East, but it is found in Scotland and in many parts of Europe and America. It is much used by the lapidary, and in the East it is prized beyond every other stone, the gems excepted. Bright red C. of unmixed colour is most highly valued, but a mass of considerable size is seldom found with the colour equal throughout.

CARNIOLA (Ger. *Krain*), a crown-land of the Austrian empire, formerly part of the kingdom of Illyria, has an area of 3811 square miles, with a population (1857) of 457,328, being a decrease of nearly 50,000 as compared with the census return of 1854. A continuation of the Carinthian Alps passes through it in the north, and the Julian Alps in the south. The scenery of the country abounds in interesting and singular features, amongst which one of the most notable is the rock-bridge of Saint Kanzian, 130 feet high, and 160 feet broad, with a perfect arch 62 feet high, and 154 feet long. The Save is the principal river; the Kulpa is its chief tributary. The singular lake of Zirknitz (q. v.) is in Carniola. The climate of C. is in general mild, except in the high mountainous parts. The country does not produce corn or cattle enough to supply the wants of its inhabitants. Millet, pulse, and wild-fruits are principal articles of food with many of the lower classes. Maize is cultivated in some places, and some districts yield excellent wines and much fine fruit. Flax is largely cultivated; silk is produced in some places, and much honey and bees' wax. The principal products of the mineral kingdom are iron, quicksilver, and marble; the quicksilver mines of Idria are the most important in Europe. Linen-weaving, and the manufacture of a coarse lace, are common among the peasantry. Laybach is the capital.

C. received its present name after the settlement here of the Slavonic Wends. Charlemagne conquered it, and gave it to the dukes of Friuli. From 972 it had markgraves of its own, sometimes called Dukes, who possessed, however, only a part of the country. On the extinction of the male line of the markgraves, part of the territory passed to the Dukes of Austria, in the 13th c., and the remainder was acquired by them in the 14th, since which time it has remained in the possession of Austria.

CARNIVAL (from the Lat. *caro*, flesh, and *vale*, farewell—'farewell to flesh!'), a festival in Italy, which originally began on the feast of the Epiphany, and continued to Ash-Wednesday, when the fast of Lent made an end of the preceding feasting, masquerading, and buffoonery. In later times, the C. was limited to the time of from three to eight days before Ash-Wednesday. Without doubt, the forms and customs still preserved in the celebration of the C. originated in the heathen festivals of spring-time; and they still remind us, partly of the Lupercalia and Bacchanalia of Southern Europe, and partly of the Yule-feast among northern peoples. Banquets of rich meats and drinking-bouts were the chief attractions of the C. during the middle ages. Shrove-tide (q. v.), or Shrove-Tuesday, called also Fasten-Even or Pancake-Tuesday, was a relic of the English C., and formerly a season of extraordinary sport and feasting. The rich commenced the festive time at the feast of Epiphany, or on 'Three Kings' Day;' but the middle classes restricted their days of revelry to the week immediately preceding Lent; while the poor indulged in only a few days of mad mirth. According to a papal order, the clergy

were allowed to commence their bacchanalia two days before the laity. The several chief days of C. had distinct names, such as 'fat' or 'greasy Sunday,' 'blue Monday' (or 'fool's consecration'), &c. The Tuesday before the beginning of Lent was especially styled C.—the *Fastnacht* of the German people. The customs of making presents of green nosegays or garlands, and planting fir-trees before houses during C., remind us of the *thyrsus* of the ancient Bacchanals, and equally of the decorations of the Yule-tide or Christmas season among northern people. The ancient custom, also, of scourging women accidentally met with during the Lupercalia (q. v.), was preserved in the mediæval observance of the carnival. In most countries, especially where Protestantism prevails, the observance of the C. is now limited to dancing and masked balls on certain days; but in Italy, as Goethe says in his charming sketch of the Roman C., it is still a general popular festive time. In former times, Venice was distinguished by the pomp and splendour of its C.; but afterwards, Rome became most prominent. The years of angry politics, 1848 and 1849, had a discouraging effect on the attempts which had been made to restore the gaiety of C. in the Roman Catholic towns of Germany.

CARNIVORA (Lat. flesh-devouring), in Cuvier's system of zoology, a principal division of the order of *Mammalia* called *Carnassiers* or *Carnaria* (q. v.), and including the most *carnivorous* or sanguinary of that order—the quadrupeds which chiefly prey on other vertebrate and warm-blooded animals. The C. have six incisors or cutting teeth in each jaw; their tusks or canine teeth are very strong, and even their molar teeth or grinders are usually furnished with cutting edges. But even the C. are carnivorous in very different degrees, and some of them have teeth and other organs adapted to a partial use of some kinds of vegetable food. Cuvier



Carnivora:
Jaws and Teeth of Lion.

subdivided the C. into three tribes—*Plantigrada* (q. v.), *Digitigrada* (q. v.), and *Amphibia* (Seals, q. v., &c.). The digestive apparatus of carnivorous animals is more simple than that of the herbivorous; the stomach is single, and in general of comparatively small size, and the intestines are comparatively short and unconvoluted. Their muscular energy is very great, their respiration and circulation very active, and their demand for food very constant. Some of them are adapted for seizing their prey by leaping, others by running, a few by swimming and diving. Most of them can only seize it with their mouths; but some have also, for this purpose, sharp retractile claws.

CARNOT, LAZARE NICOLAS MARGUERITE, born May 13, 1753, at Nolay, in the department of *Côte d'Or*, Burgundy, gained distinction at an early period by his talents in mathematical science and military engineering. In 1791, he became a member of the Legislative Assembly, and, in the Convention, voted for the death of Louis XVI. After taking the command of the army of the north, and gaining the victory of Wattignies, he was elected into the Committee of Public Safety, in which he was intrusted with the chief direction of military affairs, and greatly contributed to the successes of the French army. Though he endeavoured to restrict the power of Robespierre, he was accused,

CAROB—CAROLINA.

with others, after the Reign of Terror; but the charge was dismissed. In 1797, having opposed the extreme measures of Barras, his colleague in the Directory, C., as a suspected royalist, was sentenced to deportation. He escaped into Germany, where he wrote his defence, which conduced to the overthrow of his colleagues in 1799. The 18th Brumaire brought him back to Paris, where he was made Minister of War, 1800; and by his energy, skill, and fertility of administrative resource, helped to achieve the brilliant results of the Italian and Rhenish campaigns. He retired, however, from his office when he understood the ambitious plans of the emperor, but hastened, when he witnessed the reverses of the empire, to offer his services to Napoleon, who gave him the command of Antwerp in 1814, which he heroically defended. During the Hundred Days, he held office as Minister of the Interior; and after the second restoration, retired first to Warsaw, and next to Magdeburg, where he died, August 2, 1823. Among C.'s numerous writings on mathematics and military tactics, &c., we may notice his *Essai sur les Machines en Général* (1786), *Réflexions sur la Métaphysique du Calcul Infinitésimal* (1797), and the *Géométrie de Position* (1813).—His son, LAZARE HYPOLYTE CARNOT, born at St Omer, April 6, 1801, one of the leaders of the French democracy, was in early life a disciple of St Simon, hut, like others, left that school on account of the lax morals advocated by *Enfantin*—protesting against 'the organisation of adultery'—and devoted himself to the inculcation of a more orthodox and virtuous socialism in various periodicals. In 1847, he declared himself a republican in his brochure, *Les Radicaux et la Charte*; and, after the February Revolution, was appointed Minister of Public Instruction, but not finding himself in sufficient rapport with his colleagues, he resigned. He also maintained, and still does, a position of tacit opposition to the empire, having refused to take the oath of allegiance.

CAROB, A'LGAROA, or LOCUST-TREE (*Ceratonia siliqua*), a tree of the natural order *Leguminosae*, sub-order *Caesalpinieae*, a native of the countries around the Mediterranean Sea, in size and manner of growth much resembling the apple-tree, but with abruptly pinnate dark evergreen leaves, which have about two or three pair of large oval leaflets. The flowers are destitute of corolla; the fruit is a brown leathery pod, 4—8 inches long, a little curved, and containing a fleshy and at last spongy and mealy pulp, of an agreeable sweet taste, in which lie a number of shining brown seeds, somewhat resembling small flattened beans. The seeds are bitter and of no use, but the sweet pulp renders the pods an important article of food to the poorer classes of the countries in which the tree grows. They are very much used by the Moors and Arabs. They are also valuable as food for horses, for which they are much employed in the south of Europe, and have of late years begun to be extensively imported into Britain, under the name of *Locust Beans*, which name and that of *St John's Bread* they have received in consequence of an ancient opinion or tradition, that they are the 'locusts' which formed the food of John the Baptist in the wilderness. It seems probable that they are the 'husks' (*heration*) of the parable of the Prodigal Son.—The Arabs make of the pulp of the C. a preserve like tamarinds, which is gently aperient.—The C. tree is too tender for the climate of Britain. Dr Royle thinks its introduction into the north of India would be an important addition to the resources of that country, and a valuable safeguard against famine. The produce is extremely abundant,

some trees yielding as much as 800 or 900 lbs. of pods. The wood is hard, and much valued, and the bark and leaves are used for tanning.—The **LOCUST-TREE** (q. v.) of America is quite distinct from this.

CAROLINA, NORTH, an Atlantic state of the American Union, having South Carolina and Georgia on the S., Tennessee on the W., and Virginia on the N.; in lat. 33° 53'—36° 53' N., and long. 75° 25'—84° 30' W., being about 450 miles long, and about 180 broad, with an area of about 45,000 square miles. The census of 1850 gave 553,028 whites, 27,463 free negroes, 288,412 slaves, and 831 aborigines—869,734 in all. In 1855, the population was 923,800.—North C. sends 8 members to the lower house of Congress, returning also, in common with every other state, 2 senators to the upper. Within its own range, North C., in addition to a governor and two legislative bodies, has an executive council. The revenue is about 500,000 dollars; while a debt of upwards of 7,000,000 is invested chiefly in beneficial works, such as railways and canals, and general improvements on the more available streams. Of railways, there are, in actual operation, 763 miles. The principal rivers are the Chowan, Roanoke, Tar, Neuse, and Cape Fear. Of these, the first four divide themselves equally between Albemarle and Pamlico Sounds—inlets which, besides being shallow and difficult in themselves, are almost entirely cut off from the sea by a nearly continuous series of low islands; and the last of the five, though it does fall into the open ocean, is yet not materially superior to the others, never shewing more than 14 feet of water on the bar. With this insular breast-work the mainland is geologically connected to a depth of about 60 miles, being everywhere alluvial, and in many places swampy. To the west of this belt, the country, after undulating into hills, is traversed by the ridges of the Alleghanies, which, culminating in Mount Mitchell to an elevation of 6470 feet, bear aloft between them a table-land of fully one-third of that altitude. Through the maritime tract, and even beyond it, the rivers are generally practicable for steam-boats. Among the productions, the most characteristic is the pitch-pine of the lower levels; so that, in the matter of naval stores, this state surpasses all the rest of the Union taken together. In mineral resources, also, North C. takes a lead, more especially in gold, copper, iron, and coal. In 1858, the value of imports into North C. only amounted to 174,272 dollars, and the total value of exports in the same year was but 541,216 dollars. The chief towns are Raleigh, the capital, near the Neuse; and Wilmington and Fayetteville on the Cape Fear, the former within reach of tide-water, and the latter at the head of the navigation. North C. was first permanently colonised from Virginia in 1653. Down to 1693, it continued to form one province along with South Carolina, the two being frequently, even at the present day, classed as the Carolinas. In a local declaration of independence of May 1775, 14 months before the 4th of July 1776, North C. first formally demanded a separation from Great Britain.

CAROLINA, SOUTH, an Atlantic state of the American Union, of a triangular form, with North Carolina and Georgia on its inland sides. It extends between 32° and 35° 10' N. lat., and 78° 35' and 83° 30' W. long., having an area estimated at from 25,000 to 30,000 square miles. Pop. in 1855, 704,800. The census of 1850 gave 274,563 whites, 8960 free negroes, and 384,984 slaves—668,507 in all; the sum-total of 1800 having been 345,591, or considerably more than half. South C. returns 6 members to the lower house of Congress. It

differs from all the other states in appointing its presidential electors and its executive, not by the popular suffrage, but by the joint vote of the two branches of the local legislature, being thus as pre-eminent in the aristocracy of its constitution as in the numerical preponderance of its coloured population. Education, as well as politics, exhibits the same tendency. While the higher classes are confessedly distinguished for ability and eloquence, the free schools for the great body of the people muster only 9122 pupils. Physically a continuation of its northern neighbour, South C., behind a breast-work of islets, presents a low belt, generally swampy, of about 100 miles in depth, rising backward through an undulating region to a height of 4000 feet in the Alleghanies. With such a range of soil and climate, the productions are very various—cotton, rice, tobacco, indigo, sugar, silk, maize, and wheat. In the first two articles, South C. stands pre-eminent, exporting more rice than all the other states together, and yielding more cotton, in proportion to area, than any other state. Its mineral treasures are chiefly gold, lead, and iron—coal being unknown. With a debt, in 1857, of 2,693,277 dollars, the revenue is about 600,000 dollars. Of the income, about five-sixths depend on direct taxation; and of this proportion, about three-fifths, or about one-half of the whole, are raised by a poll-tax of 75 cents on a slave, and of 2 dollars, or 200 cents, on a free negro. With 22 miles of canal, South C. has 733 of railway. The chief rivers, each the receptacle of considerable affluents, are the Great Pedee, Santee, and Edisto, and also the Savannah, as common to Georgia and South C., the whole being said to furnish an inland navigation of 2400 miles. The maritime communications, too, are decidedly preferable to those of North Carolina. In 1853, the value of the imports amounted to 2,071,519 dollars, while the exports were valued at 16,924,436 dollars. The chief towns are Charleston, Columbia, the capital, and Georgetown.

CAROLINA PINK. See SPIGELIA.

CAROLINE, AMELIA ELIZABETH, wife of George IV. of Great Britain, was the second daughter of Charles William Ferdinand, Duke of Brunswick Wolfenbüttel, and of the Princess Augusta of Britain. She was born on 17th May 1768, and spent her youth under great restraint at her father's court. In 1795, she was married to the Prince of Wales. The marriage was disagreeable to him, and although she bore him a daughter, the Princess Charlotte, he separated from her immediately on her recovery from childbed; and she lived by herself in a country residence at Blackheath, the object of much sympathy, the people regarding her as the victim of her husband's love of vice. Reports to her discredit led the king, in 1808, to cause investigation to be made into her conduct, which was found to be imprudent, but not criminal. In 1814, she obtained leave to visit Brunswick, and afterwards to make a further tour. She visited the coasts of the Mediterranean, and lived for some time on the Lake of Como, an Italian, by name Bergami, being all the while in her company. When her husband ascended the throne in 1820, she was offered an annuity of £50,000 sterling to renounce the title of queen, and live abroad; but she refused, and made a triumphal entry into London, whereupon the government instituted proceedings against her for adultery. Much that was very offensive was proved as to her conduct; but the manner in which she had been used by her husband, and the splendid defence of Brougham, caused such a general feeling in her favour, that

the ministry were obliged to give up the Divorce Bill, after it had passed the House of Lords. She now fully assumed the rank of royalty, but was refused coronation, and turned away from the door of Westminster Abbey on the day of the coronation of her husband. She died on 7th August 1821.

CAROTID ARTERY. The great artery which on each side distributes blood to the different parts of the head, appears to have derived its name either from Gr. *kara*, the head, or, more probably, from Gr. *karos*, sleep, there being an old idea, which the researches of Dr Alexander Fleming have shewn to be correct, that there was some connection between deep sleep and compression of these vessels.

Each C. A. consists of the primitive or common carotid, which, at the upper margin of the larynx or organ of voice, separates into two great divisions, of nearly equal size—the external and the internal carotid. The external carotid supplies the larynx, tongue, face, and scalp with blood; its principal branches being the superior thyroid, the lingual, the facial, the occipital, the posterior aural, the internal maxillary, and the temporal. The last-named artery is occasionally opened by the surgeon in preference to a vein, as, for example, in certain cases of cerebral apoplexy. The internal carotid enters the cavity of the cranium through a somewhat tortuous canal in the temporal bone, and after perforating the dura mater, or fibrous membrane of the brain, separates into the anterior and middle cerebral arteries, which are the principal arteries of the brain; while in its course through the dura mater, it gives off the ophthalmic artery, which subdivides into several small branches that supply the eye and surrounding parts. See CIRCULATION.

Surgery.—Wounds of the carotid trunks are generally from stabs. Suicides have a vague desire to cut them, but rarely cut sufficiently deep by the side of the windpipe. Of course, should either vessel be wounded, death results almost immediately. Punctured wounds, however, may not be immediately fatal; they may heal, or a false aneurism (q. v.) may result. Such an occurrence happened about four years ago in Scotland. A young man was stabbed close to the root of the neck; a pulsating tumour formed, which rapidly increased, and would undoubtedly have burst before long, had not Professor Syme of Edinburgh cut into it, and, by an operation requiring extraordinary courage and dexterity, tied the common C. A. above and below the part stabbed; thereby saving not only the life of the patient, but that of the man who had inflicted the wound, and who was then in prison awaiting his trial.

Sir Astley Cooper was the first to tie the common carotid for spontaneous aneurism, in November 1805; and since then, the operation has been successfully performed in a number of cases. Owing to the numerous interchange of branches between vessels of both sides of the head, cutting off the supply of blood through one carotid is seldom followed by affections of the brain. Such have, however, occurred in a few instances; but Dr Mussey of America tied both carotids within twelve days of each other without any such result.

The common carotid in the horse is the termination of the right arteria innominata. It is a large vessel, about an inch long, which emerges from the chest below the windpipe, and divides into the right and left carotids. These bend upward, having the windpipe between them, gradually inclining inwards at the upper part, where each divides into external and internal carotid, and a large anastomosing branch arising from between these two.

CARP (*Cyprinus carpio*), a fish of the family

CARP—CARPATHIAN MOUNTAINS.

Cyprinus (q. v.), of which, indeed, it may be regarded as the type, a native of the central countries of Europe, and corresponding latitudes in Asia, but on account of its value as an article of food, long naturalised in many countries in which it is not indigenous. No fish, indeed, except its congener the goldfish, has been so much transported by man from one place to another; and this has been the more easily and successfully accomplished, that the C. can subsist longer than most fishes out of the water, if only kept

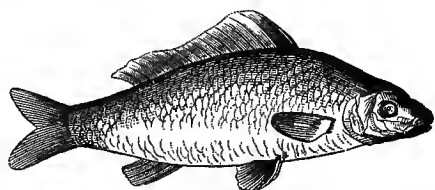

Carp (*Cyprinus carpio*).

moist. The C. is said not to be originally a native of England, but the statements sometimes made as to the time of its introduction are untrustworthy; it certainly existed in England before the 16th century. It is mentioned in the famous Boke of St Albans, in 1496, by Dame Juliana Barnes, as a 'dayntous fyssh, but scarce.' The C. spawns in May, and is out of condition until July. It does not succeed so well in Scotland, of which country it is certainly not a native, as in the south of England; and in northern countries generally, it neither increases so rapidly in size, nor exhibits so great fecundity, as in more congenial climates. Its fecundity, in favourable circumstances, is prodigious; more than 700,000 eggs have been found in the ovaries of a single C. of moderate size. The C. is rather an inhabitant of lakes and ponds than of rivers, in which, if it is found, it shews a preference for the stillest parts. It feeds chiefly on aquatic plants, and may be fattened on lettuces and similar soft vegetables, for which its teeth are remarkably adapted, being few, mostly large, flat, and situated on the pharynx very far back in the mouth; worms, mollusks, and insects, however, form part of its food. It deposits its spawn on weeds. It is said to live to a great age, even 150 or 200 years; its scales, 'like the productions of the cuticle in some other animals, becoming gray and white with age.' It is known to attain the weight of 3 lbs. when six years old. A C. of 18 or 19 lbs. weight is deemed of extraordinary size in England, but one of 70 lbs. weight, and nearly 9 feet long, was taken near Frankfort-on-the-Oder, and 30 or 40 lbs. is not an unusual size in some of the German lakes. In Austria and Prussia, many lakes and ponds are let at a high rent for the C. which they contain.—Of the other species of the genus *Cyprinus*, as now restricted, which are found in Britain, none belong to the section having barbules at the angles of the mouth. See CRUCIAN, GIBEL, and GOLDFISH.

To the angler, the C. is not a very valuable fish, as he is by no means a free biter. When hooked, however, he runs strongly, and fights with considerable determination and cunning. In still water, the best means of fishing for C. is with a very light quill-float. A small piece of dead rush will answer the purpose equally well, or better. The float should be fixed on the line so that the bait may be upon the bottom, and if that be clear of weeds (the angler must take care that it is so), the C. will easily see and pick up the bait. It is advisable, however, in fishing for C. to use two rods and the

float to one of these should be so placed that the bait may be just off the bottom. The former tackle should be baited with well-scoured red worms, gentles, or grubs of some sort; the latter with a green pea, boiled wheat, or pasta. The hooks should be of No. 8 size, and tolerably stout in the wire, and the gut perfectly round and good, and as fine as is consistent with the size of the fish angled for. In using green peas or wheat, boil until the skin cracks. Very small potatoes of the size of a bean have been known to attract good carp. The best paste is bread worked up with a little brandy or gin. Gentles, wasp grubs, flies, and other insects, worms, or caterpillars, may all, at times, take carp. When a C. bites, he nibbles at the bait for some seconds before he takes it, and often takes off the tail of the worm, or strips the hook completely. But it is quite useless to strike until the float disappears entirely.

The place designed to be fished should be baited previously some two or three evenings in succession, and the depth of the water should be taken the night before; but with all these precautions, when the angler goes out for large C., he will have, as Walton says, to practise a large measure of patience.

CARPATHIAN MOUNTAINS, the mountains which enclose Hungary and Transylvania on the north, east, and south in a great semicircle (whose concavity is towards the south-west), extending over a space of 800 miles from Presburg on the Danube to Orsova on the same river, between lat. 44° 30'—49° 40' N., long. 17°—26° E. The C. M. form part of the great mountain system of Central Europe, separated from the mountains of Silesia and Moravia by the Valley of the March, and from the Alps and Mount Hæmus by the Valley of the Danube. Almost the whole of the C. M. lie within the Austrian dominions. They form two great masses, one in Hungary to the north-west, and one in Transylvania to the south-east, with ranges of lower and wooded mountains between. The highest group of the Hungarian Carpathians is that of *Tatra* or the *Carpat*, in the very north of Hungary, a majestic mass of granite mountains, exhibiting much grandeur in its naked precipices, and in some of its peaks rising to the height of more than 8000 feet, the Lomnitz peak being 8133 feet high. On the northern declivity of the Eisthal peak exists the only glacier in the Carpathians. The Tatra group is penetrated by no valleys, but only by wild ravines, and is separated from the rest of the range by deep depressions. There is a great difference of climate between its southern and northern sides. These higher mountains yield few minerals, but the lower Carpathians of Hungary, which stretch around them in groups and ranges, abound in minerals of various kinds. The mines of Schemnitz (q. v.) are of great celebrity. Many of the Hungarian mountains are of limestone. The mountains of Transylvania are mostly of primitive rocks. On the eastern and southern borders, they reach the height of 9000 feet and upwards. Mount Butschetje, the culminating peak, has an elevation of 9528 feet above the sea. The C. M. are generally clothed with wood to a height of more than 4000 feet—in some parts, forests are found at 5500 feet—and with steep precipices, narrow ravines, extinct craters, and cones of volcanic origin, they exhibit scenes of grandeur rarely exceeded. The lower parts of the mountains are beautifully clothed with vineyards, walnut groves, &c., above which ascend forests of cherry, beech, and pine. The ranges which connect the high mountains of Hungary with those of Transylvania are in great part composed of sandstone, have an unfruitful soil, and comparatively little population or cultivation.

CARPEL—CARPENTRY.

CARPEL (Gr. *karpos*, fruit), in Botany, a modified leaf forming the whole or part of the pistil of a flower. The number of ovaries and stigmas in the pistil depends on the number of carpels of which it is composed, but sometimes several are so intimately united that they appear as one. It is the upper surface of the leaf which forms the inner surface of the carpel. At its margins, the ovules are developed, like the buds formed on true leaves of some kinds of plants. The fruit, as well as the pistil, may therefore be said to be composed of one or more carpels.

CARPENTARIA, GULF OF, a broad and deep indentation of the north coast of Australia, stretching from 11° to 17° 30' S. lat., and from 136° to 142° E. long. It is said to have been named from Carpenter, a Dutchman, who discovered, and partly explored it in 1627. The Gulf of C.—resembling, in this respect, Torres Strait, of which it is, in fact, an arm—contains many islands, particularly the Groote cluster, near the west extremity, and the Wellesley group towards the south-east. The shores of the mainland are generally low; and, in the rainy season, the floods are such as materially to freshen the sea.

CARPENTER, WILLIAM BENJAMIN, M.D., F.R.S., one of the most distinguished physiologists and writers on physiology of the present day. Very shortly after his graduation, in Edinburgh in 1839, he published his *Principles of General and Comparative Physiology*, which was one of the earliest works giving a general view of the science of life. This work, under its original title, passed through three editions, when it was thought desirable, from its greatly increased size, to separate the two subjects of which it treats; and in 1854 a volume, entitled *The Principles of Comparative Physiology*, was published, which will be followed by a companion volume on *The Principles of General Physiology*. These works, together with *The Principles of Human Physiology*, which originally appeared in 1846, and reached a fourth edition in 1853, will form a perfect cyclopædia of biological science. C. has likewise published *A Manual of Physiology; The Microscope, its Revelations and its Uses*; a prize essay upon *The Use and Abuse of Alcoholic Liquors*; and numerous memoirs on various departments of Physiology, Microscopical Anatomy, and Natural History, in the *Philosophical Transactions*, the *Transactions of the British Association*, &c. His most important original researches are *On the Structure of Shells*; *On the Development of Purpura Lapillus*; and *On the Structure, Functions, and General History of the Foraminifera*; and for these, as well as for his continued physiological researches, he has received one of the royal medals awarded by the Royal Society. For several years he edited *The British and Foreign Medico-Chirurgical Review*, and he is now one of the editors of *The Natural History Review*. In 1848, he was appointed Professor of Medical Jurisprudence at University College, and soon afterwards was elected an Examiner in Physiology and Comparative Anatomy in the University of London; but he resigned these offices on his appointment, in 1856, as Registrar to that university.

CARPENTER, SHIP'S, is a warrant-officer, midway in rank between the commissioned and the petty officers, whose duty it is to see after necessary repairs of hull, masts, and spars. During battle, he watches for shot-holes, and is prepared with plugs to stop them up. He attends constantly to the state of the pumps. He makes a daily return to the senior lieutenant of each day's work, and is

expected to be always able to make a report as to the ship's qualities. He is assisted by a *C.'s mate* and a *C.'s crew*. His pay varies from £60 to £120 per annum, plus 3d. per day for 'tool-money.'

CARPENTER BEE, a name given to those bees that excavate their nests in wood. One of these,



Carpenter Bee (*Xylocopa*):
Shewing the Cells for Eggs and Larvæ, excavated in dead-wood.

Xylocopa violacea, has been already noticed, and its nest briefly described, in the article BEE (q. v.).

CARPENTRAS, a town of France, in the department of Vaucluse, is situated on the left bank of the Anzon, about 15 miles north-east of Avignon. It is surrounded by old walls, flanked with towers and pierced by four gates, one of which, the Porte d'Orange, is a fine structure. The principal buildings are the cathedral, with a tower dating from the 10th c., a massive aqueduct of 48 arches, the palace of justice, and the theatre. This town was known to the Romans as *Carpentoracæ*, and among other remains, a triumphal arch attests their former presence here. C. has manufactures of cottons, woollens, and leather; brandy distilleries, dye-works, &c. It is the entrepôt for the products of the district. Pop. 8332.

CARPENTRY is the art of framing timber for architectural and other purposes. Technically, the term is restricted to the framing of heavy work, such as the roofs, floorings, partitions, and all the wood-work concerned in maintaining the stability of an edifice, while the minor and ornamental fittings are called Joinery; but popularly the workman who does either kind of work is called a carpenter, and as the operations of both are so nearly identical, we shall treat the subject according to this sense.

The carpenter who has any pride or ambition in his work requires a sound knowledge of mechanical science, especially of all that relates to the Communication of Pressure, the Composition and Resolution of Forces, and the Strength of Materials, in order that he may adapt his work to the strain it will be required to resist. These subjects will be treated under their respective heads, and the present article confined to a popular description of the most useful methods of framing timber and smaller wood-work.

The preliminary preparation of timber is the work of the sawyer, who, by the saw-mill or pit-saw, divides the trunks of trees into planks, &c.; these are further divided by the carpenter, who uses hand-saws of various kinds, according to the work. For dividing wood into separate pieces in the direction of the fibre, the *ripping-saw* is used; for cross cutting, or sawing thin pieces in the direction of their length, the common *hand-saw* or the finer

toothed *panel-saw*; for making an incision of a given depth, and for cutting small pieces across the fibre, the *tenon-saw*, the *sash-saw*, or *dovetail-saw* is used. These are thin saws, stiffened by a strong piece of metal at the back to prevent crippling. When a curved cut is to be made, a very narrow saw without a back, called a *compass-saw* or a *keyhole-saw*, is used. The general name for these is *turning-saws*; they have their plates thin and narrow towards the bottom, and each succeeding tooth finer, and the teeth are not bent on contrary sides of the plate for clearing, as in broad saws.

The surface of wood is smoothed by planing. According to the work, different kinds of planes are used: the *jack-plane*, which is large and rough, for taking away the rough of the saw; the *trying-plane*, for bringing the surface perfectly level and true, or the *long-plane* for the same purpose, where the work is of great length, as for the joining edges of long boards to be glued together. The *smoothing-plane*, which is much smaller than these, gives the smooth finished surface. The *spoke-shave*, a sort of plane with a double handle, is used for paring and smoothing rounded work.

Ornamental mouldings are cut by means of moulding-planes, which have their cutting edges curved to the required pattern. A good stock of these is one of the most expensive items of the tool-chest.

The paring of wood, and the cutting of rectangular or prismatic cavities, notches, &c., are done by means of *chisels*. Those for cutting across the fibre are called *firmers* or *paring-chisels*; those for cutting deep and narrow cavities, *mortise-chisels*, which are made very thick and narrow, and fitted in the handles with a strong flange, to bear heavy blows with the mallet. Chisels for paring concave surfaces are called *gouges*. For boring holes, *brad-awls*, *gimblets*, *centrebites*, and *gouges* are used—the two latter are fixed in a *stock* or revolving handle, and are used for large holes. When it is required to ascertain if an angle be square, or of any given inclination, the *square*, or the *bevel* set to the required angle, is applied to test the work as it proceeds. When parallel edges are required, the *marking gauge* is used to draw the line to be worked to. When a simple straight line is required for working to, a piece of string is chalked, then stretched tightly over the wood and lifted in the middle, when, by its recoil, it strikes the wood and leaves a straight chalked line. The *straight-edge*, a strip of wood with one of its edges perfectly straight, is applied to detect superficial irregularities. The operation of planing the edge of a board straight is called *shoot-ing*, and such edges are said to be *shot*. When the joiner requires to ascertain whether the surface of a piece of wood is all in one plane, he takes two slips of wood with edges perfectly straight and parallel, and of equal width; these slips, called *winding-sticks*, are placed edge upwards, one at each end, across the board, and the workman looks in the longitudinal direction of the board over the upper edges, and if the two edges be not in the same plane, the board is planed down at the elevated parts until it is *out of wind*. For setting work level, a spirit-level, set in a wooden frame, or a plumb-level is used. For further description of the tools alluded to above, and in the rest of this article, see the special articles.

When two pieces of timber have to be united at their ends, as in lengthening the beams for roofing, partitions, the masts and keels of ships, &c., the operation is called *scarfing*, and the joint a *scarf*. The methods of scarfing are very numerous; those figured below will serve to illustrate the principal.

Fig. 1 is a section shewing the common or single step scarf, with plates, and the bolts passing through.

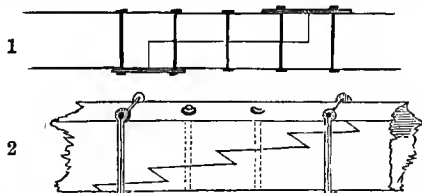

Fig. 2 is the French scarf, called *traits de Jupiter*, or Jupiter's lightnings, with the straps and bolts shewn. In these the scarf itself gives no resistance to the longitudinal strain. Fig. 3 shews a scarf in which the resistance of the wood to splitting is made available.

The following are the principal rules for scarfing as stated by Tredgold.

The length of the scarf should be, if bolts are not used—in oak, ash, or elm, six times the depth of the beam; in fir, twelve times the depth of the beam. If bolts and indents are combined, the length of the scarf should be—in oak, ash, or elm, twice the depth of the beam; in fir, four times the depth. In scarfing beams to resist transverse strains, straps driven on tight are better than bolts. The sum of the areas of the bolts should not be less than one-fifth the area of the beam, when a longitudinal strain is to be borne. No joint should be used in which shrinking or expansion can tend to tear the timbers. No joint can be made so strong as the timber itself. When two pieces of timber are connected so that the joint runs parallel with the fibres of both, it is called a *longitudinal joint*; but when the place of the joint is at right angles to the fibres of both, an *abutting joint*.

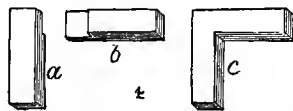
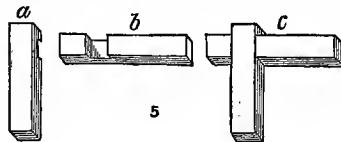

Fig. 4 is an example of common and simple joint, for connecting timbers at right or other angles. It



is called a *notched joint*, and requires bolting. Fig. 5 is a notched joint for crossing timbers. In both figures, *a* and *b* represent the pieces before joining, and *c* when united. Timbers may be joined end to end by a simple notching, or by dovetailed notching, as fig. 6. Other applications of dovetailing timbers are shewn in figs. 7 and 8. Tie-beams, connected to wall-plates, as in fig. 7, are said to be *cogged* or *cocked*, whether dovetail or simply notched.

The mortise and tenon joint is shewn in fig. 9; the cavity in *a* is the mortise, the projection on *b* the tenon. A very short tenon is called a *stub*

tenon. When a second minor tenon is made projecting from the principal tenon, it is called a *tusk tenon*.

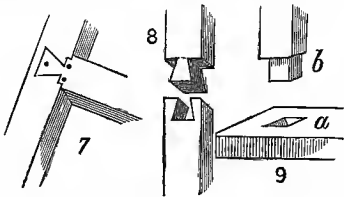

Figs. 10 and 11—shew methods of framing a rafter foot into a girder.

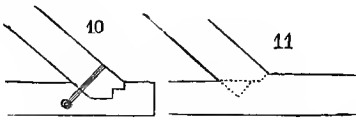

The above joints are some of those used in heavy work, or carpentry proper. For lighter joiner's work, similar methods of framing are used, only adapted to the work—to boards generally instead of beams; thus, for example, the mortise and tenon joint, made oblong instead of square, is used in framing doors, shutters, drawing-boards, or any other kind of extended superficial work liable to warping. An outside frame or skeleton is made with a panel or panels in the middle, and each piece of the frame has the grain at right angles to the piece into which it is mortised, in order that they shall eventually correct the warping.

Dove-tailing is extensively used for connecting

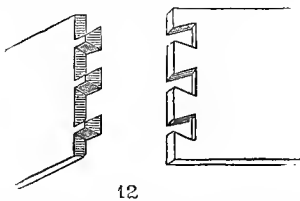

boards at right or other angles, as in making boxes, drawers, &c. The common dove-tail is shewn in fig. 12;

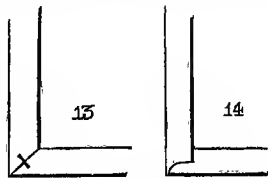

the common mitre, fig. 13; the lapped mitre, fig. 14; and the lapped and tongued mitre, fig. 15.



Modes of notching for boards are shewn in figs. 16, 17, and 18. Fig. 16 is called a *nosing*, also shewn at fig. 21, in its common application for fixing the *risers* to the *treads* of staircases. Common

dove-tailing is usually glued. Nails or pins and glue are used with the mitre and other notched joints.

Boards may be united at their edges to form an extended surface, as a flat plank partition, &c., either by simple gluing of the shot edges, by a *rebate* (fig. 19), or by a ploughed groove and a corresponding projection. The rebate is cut by means of a rebating plane; that in the figure is combined with a bead, the usual joint for wooden partitions. The groove, fig. 20, a sort of extended mortise, is cut by a plane with a projecting iron called the *plough*.

In all cases where glue is used in joints, it should be applied to both surfaces, which should be rubbed and pressed together until nearly all the glue is forced out, then kept pressed by a cramp or weights. White lead is used for outside joints.

Special departments of this subject, such as Roofs, Staircases, &c., will be treated under their respective heads.

CARPETS. Woven C., such as are now so common in this country, were first used in the east, where the custom of sitting cross-legged on the floor still renders them especially useful. Our rude forefathers covered the floors of their houses with rushes, hair, or straw; and in Norwegian farm-houses, where so many of our ancient customs still exist, the floor of the best room is commonly strewn with juniper-twigs. The first step towards a woven carpet was made by plating rushes to form a matting.

The principal varieties of C. now in use are the Turkey, the Axminster, the Brussels, the Wilton, the Venetian, the Dutch, the Kidderminster or Scotch, Whytock's Tapestry and Velvet Pile, and the Printed Felt Carpet.

The real Turkey carpet is made in one piece; those manufactured for the orientals are usually too small for use in this country. The patterns consist merely of curved and angular strips, of variegated but dark and unobtrusive colours. The warp is of strong linen or cotton, to which bunches or tufts of coloured worsted are tied according to the pattern, a drawing of which is placed before the weaver to copy. The surface is afterwards shorn level. Rugs are made in a similar manner; the coloured worsteds are tied very rapidly by young girls.

The *Axminster Carpet* is merely the English-made Turkey carpet, formerly manufactured as above at Axminster, in Devonshire. They are usually made to order, and of the size required for the room; from the tedious nature of the process of manufacture, they are very expensive.

Templeton's Patent Axminster Carpet is a very beautiful fabric, very much resembling that from which it derives its name, but it is wrought on the chenille principle.

The *Brussels Carpet* is a mixture of linen and worsted, but, like the Turkey carpet, the worsted only is shewn on the upper surface. The basis or cloth is a coarse linen fabric, and between the upper and under threads of the weft, several (usually five) worsted threads of different colours are firmly bound in. The pattern is produced by drawing to the

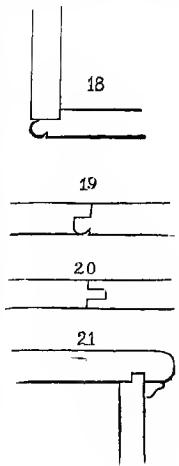

surface, between each reticulation of the cloth basis, a portion of the worsted thread of the colour required at that spot to produce the pattern; these updrawn portions are formed into loops, by being turned over wires, which are afterwards withdrawn, and the loops thus left standing above the basis form the figured surface of the carpet. This will be better understood by reference to the diagram, fig. 1, which is a slightly magnified section of a Brussels carpet, cut across the wires and the threads of the weft. The large dots above are the sections of the wire; the smaller dots, those of the weft or shoot threads; the waved lines, the warp; the parallel lines, the five coloured worsted threads; and the loops over the large dots are the updrawn worsted threads forming the surface of the carpet. The machinery and processes by which this arrangement is produced are rather complex, and require to be seen to be fully understood.

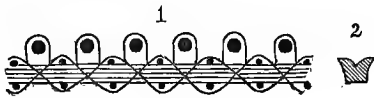

Carpet Weaving.

The *Wilton Carpet* is made like the Brussels, but the wire has a groove in its upper surface, fig. 2, and instead of being drawn out, it is liberated by passing a sharp knife through the worsted loop into this groove, and thus making a velvet pile surface instead of the looped thread.

The *Venetian Carpet* is produced in a common loom, and the pattern is all in the warp, which alone is visible, as it encloses the weft between its upper and under surfaces. The patterns are generally checks or stripes; the latter are chiefly used for stair carpets.

The *Dutch Carpet* is a coarser and cheaper variety of plain Venetian, sometimes made wholly of hemp, or of a mixture of coarse wool and cow-hair.

The *Kidderminster* or *Scotch Carpet* has usually a worsted warp and woollen weft, and the pattern is made by the combination of the colours of each. Three-ply C. of this kind are made especially in Kilmarnock. This is the most durable of the moderate-priced C., the patterns are not so brilliant as those of the Brussels or the Tapestry, but, being ingrained and woollen throughout, they retain their character until worn through. This, and the three immediately preceding descriptions of carpet, exhibit their patterns nearly similar on both sides, and are therefore reversible.

Whytock's Tapestry and Velvet Pile Carpet, as it is now frequently called, is becoming very extensively used as a cheap substitute for Brussels and Wilton, which it is made to resemble very closely in the brilliancy and variety of pattern. The manufacture of this carpet is very curious and ingenious. Instead of five coloured yarns, only one of which is drawn to the surface at any one place, while the other four remain buried between the upper and under threads of the cloth basis, a single coloured yarn is used, and the variety of colour produced by dyeing it of various colours at intervals of its length. The yarn is coiled upon a drum, and printed by means of rollers in such a manner that when the threads that encompass the roller shall be uncoiled and laid in lines side by side, they shall present an elongated printing of the pattern, so that a rose, for example, the outline of which should be nearly circular, will be an oval, with length equal to four times its breadth. When, however, the thread is looped over the wire, four inches of yarn being used for an inch of the carpet pattern, this elongation is exactly

compensated, and the rose appears in its proper proportions. The machinery required for this is, of course, much simpler than that for the Brussels, only one yarn having to be looped, and that always in the same manner.

The *Printed Felt C.* are, as the name implies, simply made by printing colours on felt. These are chiefly used for bedroom carpets.

A very beautiful fabric has been lately introduced, called the *Patent Wool Mosaic*, formed by cementing a velvet pile upon plain cloth. It is used for rugs, &c. The pile is formed by stretching lengths of woollen yarn between plates of finely perforated zinc, placed several yards apart, the colours of the threads being arranged so that their ends shall shew the pattern. The mass of yarn is then enclosed in a case, open at both ends, and compressed without deranging the fibres; and by means of a piston or ram at one end, a portion of this mass of yarn is forced forwards, the ends thus projecting are glued to the plain cloth, and when dried, are cut off to the length required for the pile. In this manner, several hundred slices are made from one setting of the yarn mosaic, and as many rugs produced.

CARPI, a town of Northern Italy, 10 miles north of the city of Modena. It is surrounded by walls, defended by a citadel, has a cathedral, and manufactures of silk and straw hats. Pop. 6500.—CARPI is also the name of a town in the government of Venice, 28 miles south-east of Verona, celebrated for the victory obtained here by Prince Eugene over the French in 1701. Pop. 1200.

CARPINI, JOHANNES DE PLANO, a celebrated Franciscan monk, born in Capitanata, Naples, about 1210; was one of the six friars selected by Pope Innocent IV. to proceed to the court of the emperor of the Mongols, whose warlike advances in 1246 threw Christendom into consternation, in order to pacify the terrible nomadic warriors, and, if possible, convert them to Christianity. The mission, accomplished under dreadful hardships, though without results so far as its main objects were concerned, was nevertheless far from unfruitful. Prior to this, the most monstrous fables had prevailed regarding the Tatars; and C.'s narrative, which gave a truthful and striking picture of their numbers, character, and civilisation, was the first to bring these myths into discredit. In this book he also argued, with great good sense, for a union amongst Christian princes, as the only means of resisting those fierce hordes in their progress westward. As a book of travels, its accuracy has been attested by modern travellers. Hakluyt copied most of this work, at second-hand, into his first volume of *Navigations and Discoveries*. The date of C.'s death is not certainly known.

CARPINO, a town of Naples, in the province of Capitanata, 22 miles north-east of San Severo, with a population of about 6000.

CARPOCRATES, or CARPOCRAS, flourished under Hadrian (130 A. D.) at Alexandria, where he founded the Gnostic sect of Carpocratians. According to him, the essence of true religion consisted in the union of the soul with the Monas or highest God, by means of contemplation, which elevated it above the superstitions of the popular faith, and liberated it from the necessity of submitting to the common laws of society. He only is to be reckoned wise who attains to this. Among those who have done so, are Jesus, Pythagoras, Plato, and Aristotle. The cosmogony of C. was of the usual Gnostic character, the central peculiarity of which was the belief that the worlds were created by angels. C. also held the doctrine of the transmigration

of souls. His followers existed down to the 6th century. Whether or not they were guilty of the abominations ascribed to them, is more than we can positively affirm; our only information concerning them being derived from *orthodox* writers, who were in the habit of slandering heretics.

CARPOLITES, a generic term applied to fossil fruits, which, in the present state of our knowledge, it is impossible to refer more precisely to their place in the vegetable kingdom. 100 species of such fruits have been described, 70 of which belong to the carboniferous system.

CARPUS. See **EXTREMITY**.

CARRA'CA, LA, a town of Andalusia, Spain, one of the chief naval arsenals of the kingdom, is situated 4 miles east-south-east of Cadiz. It has been completely isolated from the mainland by artificial means; and so low is its situation, that it was necessary to erect the buildings on piles. It is defended by four forts, and is altogether very complete as an arsenal.

CARRAGEEN, often incorrectly called *C. Moss*, or **IRISH MOSS**, a sea-weed (natural order, *Algæ*; sub-order, *Ceramiaceæ*), or rather several species of sea-weed, now used to a considerable extent both medicinally and as an article of food. The name *C.* is originally Irish; and the use of these sea-weeds appears to have been entirely confined to the peasantry of the coasts of Ireland, until about thirty years since they were recommended to general notice, and their medicinal virtues proclaimed by Mr Todhunter, of Dublin. They are, however, found on the rocky sea-shores of most parts of Europe, and of the eastern coasts of North America. The



Carrageen Moss (*Chondrus crispus*).

species which principally constitutes the *C.* of commerce is *Chondrus crispus*, of which the varieties are remarkably numerous. It is 2—12 inches long, branched by repeated forking, cartilaginous, flexible, reddish-brown. *C. mamillosus* also frequently occurs. *C.*, after being collected, is washed, bleached by exposure to the sun, dried, and packed up for the market. Its composition is as follows:

Vegetable jelly (carrageenin),	79.1
Mucus,	9.5
Two resins,	0.7
Ash,	2.0
Fibre and water,	8.7
	100.0

When treated for ten minutes with cold water, in the proportion of half an ounce of *C.* to three pints of water, and then boiled and strained, it yields, with or without spices, a very pleasant drink. With a larger proportion of *C.*, a thickish liquid or *mucilage* is obtained; and on boiling down this strong decoction, and cooling, a stiff *jelly*

is procured. Milk may be employed, instead of water, in the preparation of the various decoctions; and with the stronger one, along with sugar and spices, when thrown into a mould, a kind of *blanc mange* is obtained. *C.* is valued on account of its emollient and demulcent properties, and is likely to be found useful in most of those cases in which iodine might be exhibited; but its value seems to depend not a little on its being at once nutritious, a pleasant article of food, and easy of digestion. See **NUTRITION**. It has been much recommended in pulmonary consumption. In some parts of Ireland, *C.* boiled with water (mucilage) is used instead of size for mixing with the more common colours in house-painting.

CARRA'RA, a town of Northern Italy, 60 miles south-west of Modena. It is situated on the Avenza, near its mouth in the Mediterranean, and is surrounded by the marble hills which have made its celebrity. Many of the principal buildings are wholly or partially constructed of the inferior kinds of white marble. There are upwards of 30 marble quarries in the vicinity of the town, but not more than 6 or 7 furnish the marble used for statuary. Extensive works, fitted up with English machinery for sawing the marble, have been established near the town, in which are several shops for the sale of marble ornaments. Many foreign artists have set up their studios here, in order to save the expense which the export of the marble in its rough state entails. *C.* has a fine collegiate church of the 13th and 15th centuries, with some good sculptures, an academy of fine arts, and a population of 6000. The quarries have been worked for more than 2000 years.

The famous **CARRARA MARBLE** is a white saccharine limestone, which derives its value to the sculptor from its texture and purity. It was formerly supposed to belong to the Primitive rocks, but is now known to be a limestone of the Oolitic period, highly altered by plutonic action.

CARREL, ARMAND, a celebrated French publicist and republican leader, was born at Rouen in 1800, and was educated in the military school of St Cyr. After serving for some years in the army, he went to Paris, and devoted his attention to political and historical studies. In 1830, in connection with Thiers and Mignet, he became editor of the *National*, the most spirited and able of the journals opposed to the government of Charles X. *C.*'s colleagues being employed by the new government, he was left to conduct the *National* himself, which he did with a spirit and a freedom such as had not been witnessed in France for a long time—which on more than one occasion checked the arbitrary power government attempted to exercise, and gained for him the high admiration and esteem of the popular party. Government prosecutions of course followed his outspokenness, and heavy fines were decreed against him; but these were paid by public subscription, and each conviction only made his journal more famous. *C.*, however, dreaded revolution as much as he hated despotism, and had no sympathy with many of those who looked up to him as a leader. Provoked into a duel with Emile de Girardin, by an attack on his personal character, *C.* was mortally wounded, and died July 24, 1836. His funeral was attended by many of the most distinguished men in France.

CARRIAGE. See **COACH, CART, WAGON**.

CARRIAGE DEPARTMENT, ROYAL, at Woolwich, is one of the great national manufacturing establishments maintained for warlike armaments—one of those concerning which it is still

CARRICAL—CARRIER PIGEON.

an unsolved problem whether it is better and cheaper to manufacture by the government or by contract with private persons. This department was organised as a distinct establishment in 1803, and has been undergoing gradual enlargement ever since. Its primary work was that of making gun-carriages; but it now manufactures a great variety of articles in wood, more than half of which are for the use of the navy. Until 1854, the Board of Ordnance had power to lend or to refuse the services of the C. D. to the Admiralty; but since that year the matter rests with the War Office. The works, store-rooms, and yards are of vast size, often employing from 2000 to 3000 hands. In 1855, there were 10,000 pairs of wheels made, besides all the other articles in wood. There are more than 20 steam-engines in various parts of the establishment; and the wood-cutting and shaping machines are of the highest order of excellence.

CARRICAL, or **KARIKAL**, a French port within the limits of Tanjore, a district of the presidency of Madras. It stands in lat. 10° 55' N., and long. 79° 53' E., on the estuary of a small branch of the Cauvery, a tributary of the Bay of Bengal. C. is accessible from the sea only after the periodical rains, and then only for coasting craft. The town and territory contain 63 square miles, and about 50,000 inhabitants. The settlement, originally ceded to France by a native grant in 1759, and subsequently subdued by the British, was restored in 1814, on condition of being neither fortified nor garrisoned.

CARRICKFERGUS, a seaport town of Ireland, is situated on the Lough of Belfast, about 10 miles distant from the town of that name. Though locally within the county of Antrim, it forms a county of itself. C. extends nearly a mile along the north-western shore of the Lough. Its chief feature is its castle, a fine picturesque object, supposed to have been erected by De Courcy in the 12th century. It is situated on a rock about 30 feet high, projecting boldly into the sea, by which it is surrounded on three sides. The ballium or keep is 90 feet in height. From the top of the keep a splendid view is obtained, extending, in a clear atmosphere, to the Mourne Mountains and the Scotch coast. The castle contains a barrack, bomb-proof magazine, and ordnance store-rooms; and for many years, 22 pieces of ordnance, 12-pounders, were mounted on the works. At present, a total change is being made in the defence of the castle, and cannon of a very large calibre are to be mounted, which will command the entrance of the Lough. In 1575, a wall 16 feet high and 7 thick, with 7 bastions, to surround the town, was commenced, and completed in the year 1608; a considerable portion of the wall is still standing, and one of the four entrance-gates. On the 14th June 1690, King William III. landed here with his army, twelve days before the battle of the Boyne. The rock on which the king stepped on landing is at the end of the quay, projecting from it, and still forming the landing-place. In 1760, Commodore Thurot captured the castle, but on the approach of troops from Belfast, was forced to abandon it. The parish church, said to have been founded in the year 1164, on the site of a pagan temple, is a fine old building, dedicated to St Nicholas. There are several other churches and chapels in the town, and several good day and Sunday schools in connection with the religious bodies, and a fine model school has just been erected by the National Board. There is a Literary and Scientific Society, with reading-room, library, and museum. The fishery of the bay, which is famous for oysters of an unusual size, employs a good number of the inhabitants. There

are four spinning-mills, one for weaving linen, one bleaching establishment, a starch manufactory and a tan-yard. A market is held every Monday and Saturday, and a fair twice a year. The inhabitants are about 9000. The town returns one member to parliament. There are several barrows or tumuli in the vicinity. C. is connected by railway with Belfast and Portrush. A few years since, a shaft was opened by the Marquis of Downshire, in the hope of finding coal—without success; but salt of a superior quality, and in great abundance, was found. A company has been formed, and are working the mine. The length and breadth of the county are nearly equal—about 5 statute miles.

CARRICK-ON-SUIR, a town of Tipperary, situated, as its name implies, on the Suir, which is navigable at this point, 12 miles east of Clonmel, in the midst of very fine scenery. Pop. 6512. C. had formerly important woollen manufactures, but there is little or nothing carried on in this way now. It exports, however, much agricultural produce. C. became a place of note soon after the Norman Conquest. There are the remains of a castle—a fine feature in the place—built in 1309, on the site of an old priory of the Knights of St John of Jerusalem.

CARRIER, **JEAN BAPTISTE**, one of the most infamous and blood-thirsty members of the French National Convention, was born at the village of Yolai, near Aurillac, in Haut-Auvergne, in 1756. Entering the National Convention in 1792, he took an active part in the formation of the Revolutionary Tribunal, voted for the death of the king, demanded the arrest of the Duke of Orleans, and assisted in the overthrow of the Girondists. At Nantes, whither he was sent on a mission against the moderates, in October 1793, he found ample means for indulging his insatiable thirst for human blood. The utter defeat of the Vendéans had filled the prisons with captives, and C. proposed and carried a resolution for murdering the unhappy prisoners *en masse*. Accordingly, on November 15, he compelled 94 priests to embark in a vessel, under pretence of deportation, and during the night drowned the whole of them, by having the ship scuttled. Another of these *Navades*, as they were called, in which 138 persons were sacrificed, took place soon after, and they were repeated to the number of 25, their perpetrators facetiously terming them 'vertical deportations.' Other cruelties C. committed here. Men and women were tied together feet and hands, and thrown into the Loire; and this was called *marriage republicain* (republican marriage). With such recklessness were these murders committed, that, in one instance, a number of foreign war-prisoners were drowned by mistake. The water of the Loire was so poisoned by corpses, that its use for drinking and cooking was prohibited. 500 political prisoners were shot, as in a battue, on the bridge near Nantes. Even Robespierre was offended by these enormities, and recalled C., who boldly justified his own conduct before the Convention. The fall of Robespierre was, however, soon followed by outcries against Carrier; judgment was decreed against him, and he perished under the guillotine, December 16, 1794—dying with the protestation that, in all his cruelties, he had acted according to orders, and as a true republican patriot.

CARRIER PIGEON, a variety of the domestic Pigeon (q. v.), remarkable for the degree in which it possesses the instinct and power of returning from a distance to its accustomed home; and which has been, therefore, much employed to convey letters from one place to another. In Eastern countries,

CARRIER PIGEON—CARRIERS.

where such messengers are most frequently employed, it is the practice to bathe the pigeon's feet in vinegar to keep them cool, and to prevent it from alighting in quest of water, by which the letter might sustain injury. Pigeons intended for this use, must be brought from the place to which they are to return, within a short period, not exceeding a fortnight of their being let loose, and at a time when they have

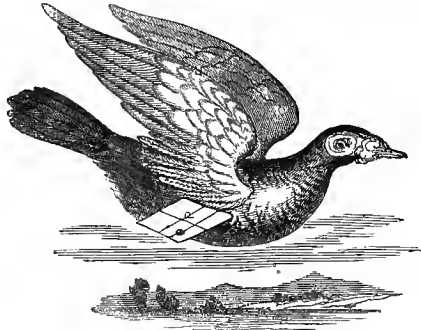

Carrier Pigeon.

young in their nest; the remarkable fecundity of the C. P. affording particular facilities for its employment in this way. The bird is also kept in the dark and without food, for at least eight hours before being let loose. The instinct by which it is guided, like most other instincts, has received no sufficient explanation. That it recognises objects by sight, and so directs its course, is nothing more than a conjecture, and as such, is only very partially supported by the fact of the great power of vision which these birds, in common with so many others, are known to possess, and by that of the C. P., on being let loose, immediately rising spirally to a great height in the air, as if to obtain opportunity for the exercise of this power. The C. P. has probably been more used in the Turkish dominions than in any other part of the world, and has often been intrusted with important messages both in affairs of war and of commerce. Its rate of flight is not less than thirty miles an hour, and it has been known to pass over great distances still more rapidly. The variety generally described as the C. P. (*Columba tabellaria* of Linnaeus, *C. Turcica* of some authors, but not generally regarded by naturalists as a distinct species), is of remarkably large size, about fifteen inches in length from the point of the bill to the extremity of the tail, and has the cere very large and carunculated, the eyes surrounded with a broad circle of naked red skin, and the wings reaching nearly to the extremity of the tail. There is, however, a smaller variety, which is said to be superior to it, and which has not the carunculated cere, nor the broad circle around the eye. Carrier pigeons are trained by being conveyed, when young, to short distances of a few miles from home and then let loose, the distance being gradually increased; and this training is said to render them much more secure as messengers.

CARRIERS, a class of persons who, in various forms, by land and sea, undertake the carrying of goods, particularly articles of commerce. In all countries aspiring to commercial intercourse, the **CARRYING TRADE**, as it is called, has been less or more developed. The method of carrying in Arabia, Persia, and some other countries in the east has, till the present time, been chiefly by means of the camel, an animal of great value, on account of its strength, patience, and power of endurance.

See **CAMEL**. In England and Scotland, previous to the general use of wheel-carriages, goods were carried on pack-horses, as is still practised in some parts of Spain with mules. See **PACK-HORSE**, also **MULE**. After the pack-horse came the one-horse cart and the four-wheeled wagon, as engines of land-conveyance. Carrying with one-horse carts settled down as a universal practice in Scotland, where it is still conducted in all districts not traversed by railways. The Scotch C., winding their way by roads over hill and dale, at the rate of about 20 miles a day, have ever been a respectable and useful body of men, exceedingly trustworthy, and moderate in their charges. In connection with Edinburgh, Glasgow, and other centres of traffic, they travel to and from provincial towns for the most part once a week on certain days, so that their arrival at any particular place may be reckoned on with great exactness. In England, the employing of wagons for carrying goods in connection with the metropolis and provincial towns is now of old date. These carriers' wagons, greatly limited in their range by the introduction of canals and railways, are still to be seen in some of the rural districts. A wagon of this kind is provided with four broad huge wheels; and being a heavy and clumsy engine of conveyance, is drawn by four

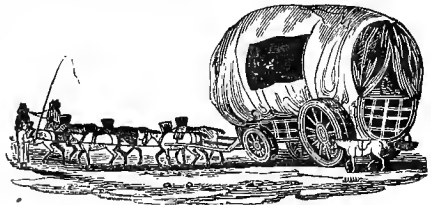

Covered English Wagon.

horses, though, when roads were bad in old times, six horses were not unusual. The driver ordinarily rode on a pony alongside the vehicle; now he more frequently walks, carrying a long whip. The wagon has a hooped top with movable covering; and the hinder part has always been left vacant for the use of passengers, who are necessarily huddled together on straw. Travelling in the 'tail of the wagon' is now entirely gone, or nearly so; but with all its rude inconveniences, it was common till past the middle of the 18th c., and has afforded scope for some of the most grotesque descriptions of Fielding and Smollett. The tedious process of carriage by these wagons largely increased the prices of goods, and retarded the growth of commerce. The first modification in the carrying trade took place by means of inland navigation, to which reference has already been made. See **CANAL**. The conveyance of cotton goods from Lancashire, of earthenware from Staffordshire, of metal goods from Birmingham, of salt from Cheshire, &c., became much more easy than before, owing to the large quantity which could be packed in each barge, and to the great amount of work done by each horse. The chief owners of the old wagons became, in time, the chief owners of the canal-boats; they paid rates or tolls to the canal companies. The celebrated English firm of Pickford & Co. has been for many generations, and still is, at the head of the goods carrying trade.

When railways were established, a great struggle ensued; the owners of the road-wagons and canal-barges had a formidable competition. They wisely accommodated themselves to a state of things which they could not prevent, and added the trade of railway goods C. to their former business. Three

CARRIERS.

systems were tried: 1. The company purchased road-wagons or vans, collected goods at the various towns, conveyed them by railway, and then distributed them at their several destinations. 2. The company confined their attention to the mere conveyance on their railway, leaving the collection and delivery to the ordinary carriers. 3. The company combined both systems, conveying on the railway everything that offered, and competing with the C. for the road-traffic. During the greater portion of the period in which the railway system has been in operation, the second of the above three plans has been adopted more extensively than either of the others. Taking as examples the greatest railway company and the greatest carrying firm, Messrs Pickford had warehouses or dépôts at all the principal towns where the London and North-western Railway had stations. The merchants and manufacturers were customers, not to the company, but to the firm, for the conveyance of merchandise. Messrs Pickford employed their own wagons and horses, clerks and porters, in collecting and delivering goods, and paid to the company so much per ton for the conveyance along the railway, the toll varying according to the nature of the goods and the distance run. There were seldom any quarrels or disputes under this system. The carrier was responsible to the customer from first to last for the safety of the merchandise; and he had a claim against the company for any injury while the merchandise was on the railway. Under the third system, disputes were much more frequent. The companies were bound by law to carry goods for all persons at certain tolls; but when they became road C. as well, they competed with the ordinary C. in a way which the latter could barely contend against. The Great Western Railway has been unfavourably distinguished for jealousies and lawsuits between the company and the carriers.

At the present time, the tendency is for the companies to take the responsibility of the whole conveyance, the C. acting as their agents, if willing so to do, or else endeavouring to maintain a fair competition. One of the greatest of the companies, the Midland, have in this way recently become C. on their own account, in order to obtain a share of the profit which accrues from road-traffic. The goods-vans traversing the streets of the metropolis, and other great towns, are now more frequently inscribed with the names of railway companies than with those of private carriers.

The goods-dépôts of the several railways are scenes of great activity during the night; for it is then that the arrival-trains are mostly unpacked, and the departure-trains mostly made up. During the day, vans are collecting goods from manufactories and warehouses; these goods are sorted at the dépôts, and are, when evening comes on, distributed among different trains, according to the part of the country to which they are to be conveyed. On the other hand, goods-trains arriving during the evening and night are unpacked, the goods classified according to districts, and sent out for delivery by road-vans on the following day.

The four-horse broad-wheel wagons, as already said, have almost disappeared from English roads; vans of lighter construction sufficing to convey merchandise from and to the various railway stations. Canals still command a trade, but it is chiefly in coal, stone, lime, ores, slate, bricks, and other articles very bulky in proportion to their value. The conveyance of manufactured goods has, for the most part, passed over to the railways.

In towns, there are C. whose business is confined wholly to short distances. Taking the metropolis as an example, there are C. residing in all the

villages and hamlets round about, each possessing one or more single-horse covered carts. Every morning the cart, containing miscellaneous articles collected in the village or hamlet, goes to London, and delivers each article at the particular house or establishment to which it is addressed. When thus emptied, it receives a supply of packages or other articles going from London to the suburbs, and makes its return-journey in the evening. The plan is cheap and convenient, and does not seem likely to be supplanted by any other; for no amount of railway extension would wholly accommodate short traffic. For the metropolis more strictly, however, an excellent system has been established by the 'London Parcels' Delivery Company.' Two or three times a day, parcels are conveyed from receiving-houses all over the metropolis to a central dépôt near Fetter Lane, there sorted, and sent out again for delivery. The metropolis, out to a wide distance, is separated into districts, and one or more carts, filled with parcels, are sent to each district at certain hours of the day. The speed is rapid, the times are punctual, and the service in general well conducted. The suburban C. have arranged among themselves a sort of central dépôt or 'house of call' in the Old Bailey, for the exchange of traffic; but their system is not so well organised as that of the company just named.

The progress of improvement in the English CARRYING TRADE is a type of the advances similarly made in the United States, where canals, railways, and coasting steam-vessels have generally superseded the old tedious methods of conveyance; and it is chiefly on the long and almost trackless routes to the shores of the Pacific that are now seen the old processes of carriage by pack-mules and horses and bullock-wagons, the cost of transit by these means being very great.

The term CARRYING TRADE has latterly been applied more specially to all kinds of conveyance of merchandise by sea, whether across the ocean or along the coast. In this broad view, it, in reality, involves the whole question of mercantile marine, British and foreign.

CARRIERS, LAW RESPECTING. A carrier, in Law, is one who offers to the public to convey passengers, or goods, from one place to another, for hire. The offer must be general—for a private person who contracts with another for carriage, is not a carrier in the legal sense, and does not incur the peculiar responsibilities which, in almost every country, it has been found expedient to attach to the occupation of a public or common carrier. Carriage, in law, is thus a peculiar modification of the contract of hiring. In Rome, the responsibilities of carriers by water were regulated by a pretorian edict, which was applicable also to innkeepers and stablers (Nautæ, Campones, Stabularii, Dig.; lib. iv. t. 9); and from that edict the law of carriage in modern Europe has been mainly borrowed, sometimes directly, as in Scotland, sometimes indirectly, as in England. The ground on which the edict increased the responsibilities attaching to an ordinary contract of hiring was, that the persons whom it enumerated were under peculiar temptations to consort, either personally or through their servants, with thieves and robbers, without the connection being such as to admit of proof; and that the public safety consequently required that they should be held responsible for whatever had been intrusted to them, till its safe delivery at the place to which they had undertaken to convey it. This responsibility in our own law extends not only to the acts of the carrier's servants, but also to those of the other guests in an inn, or the other passengers in a conveyance. The only exception to this liability

at common law is in the case of loss arising from the act of God or of the Queen's enemies—i. e., from the fury of the elements, or from war. But several statutory limitations have been introduced. There is no liability for articles of unusual value or fragility, unless an increased hire has been paid, expressly as insurance, in consequence of the greater risk (11 Geo. IV., and 1 Will. IV. c. 68, and 17 and 18 Vict. c. 31); and the proof of value is laid on the person claiming compensation. But the last-mentioned act, commonly called the Railway and Traffic Act of 1856, provides, on the other hand, that the company shall be liable for neglect or default in the carriage of goods, animals, &c.; notwithstanding any notice or condition or declaration made by the company, for the purpose of limiting their liability. The decisions of the courts have also somewhat limited the universal responsibility of the carrier. For example, it has been decided that he is not liable, *qua* C. (and the same applies to an innkeeper), for money taken from the pockets of the traveller; but that, if the money has been taken from the pockets of clothes which have been stolen, or from trunks which have been broken into, his responsibility comes into operation.

Under C. are included carters and porters, who offer themselves for hire, to carry goods from one part of a city to another. Whether the same be the case with hackney-coachmen, is more doubtful; though, from the extent to which they are now employed in the transport of luggage, there seems no sound reason for an exemption in their case. Wharfingers and warehousemen are liable only under the special contracts into which they may have entered, or in accordance with mercantile usage. In England, it has been decided that lodging-house keepers are in a different position from carriers and innkeepers, on the ground that they do not profess to entertain all-comers, or to receive their goods. C. are liable to make good to the owners of goods intrusted to them all losses arising from accidental fire. This rule was introduced into Scotland by the Mercantile Law Amendment Act of 1856; but it has not been decided whether an exception would be made in the case of fire occasioned by lightning. It is probable, however, that the English rule, by which this occurrence is excepted as the act of God from the category of ordinary accidents, would be held to rule the construction of the general words of the 17th section of the Scottish statute.

CARRION CROW. See CROW.—C. C., also called *Black Vulture*, is not in America, as in Britain, the name of a species of crow, but of one of the Vulture family. See VULTURE.

CARRION FLOWERS, a name which, on account of their smell resembling that of putrid meat, has been given to the flowers of many species of *Stapelia*. The genus *Stapelia* belongs to the natural order *Asclepiadaceæ*, and is remarkable for the excessive development of the cellular tissue of the stem and reduction of that of the leaves, resulting in a general aspect like that of the *Cactus* family. The species are natives of the Cape of Good Hope. The flowers are often large, and not devoid of beauty, but the carrion stench is very strong. It is not yet known to what chemical substance it is owing.

CARRON, a village in Stirlingshire, Scotland, on the right bank of the Carron Water, 3 miles east-north-east of Falkirk. It is celebrated for its ironworks, which are among the largest of the kind in Britain. The works were established in 1760; and are carried on by a company, who employ about 1200 men.

CARRON OIL. See BURNS.

CARRONADES are short iron guns, invented by Mr Gascoigne, and named after the Carron Iron Works in Scotland, where they were first made. They are lighter than ordinary guns, and have a chamber for powder, like mortars. They were made standard navy guns in 1779, to be carried on the poop, fore-castle, and upper works. Being manageable by a smaller number of hands than guns, and being very useful in close engagements, they were held in much favour during the great war: the seamen called them 'smashers.' A 68-pounder carronade weighed not much more than half as much as the 42-pounder gun in use in 1779. They range from 68-pounders down to 6-pounders. The denominations, weights, lengths, calibre, &c., of the chief varieties of carronade are noticed under CANNON.

Some C. are made shorter with a given bore. C. are but little used, except by the English and French. Though valuable at close quarters, they are no match for long guns at a distance; and therefore a ship armed only with C. would fare badly in a general action. In recent years, C. have to a considerable extent been replaced in the English navy by howitzers, long guns, and shell guns.

CARROT (*Daucus*), a genus of plants of the natural order *Umbelliferae*. They are mostly natives of the countries surrounding the Mediterranean Sea. The Common C. (*D. Carota*), is a biennial plant, common in Britain and most parts of Europe, also in the Caucasus; and is universally cultivated not only in Europe and the European colonies, but in China, Cochin China, &c., for the sake of its root. The root of the wild plant is slender, woody, and of a very strong flavour; that of the cultivated variety is much thicker and more fleshy, much milder in its flavour and qualities, generally red, but sometimes orange or yellowish white. The sub-varieties in cultivation are also distinguished by their form—some being longer and more tapering than others—by their size, and by the duration of their growth; the *early* kinds being also comparatively small, and almost exclusively cultivated in gardens for culinary use, whilst the larger and *late* kinds are often also grown in fields, for feeding cattle. The field cultivation of the C. is carried on to a much greater extent in some parts of France, Germany, and Belgium, than in Britain; but it is increasing in Britain. The C. appears to have been cultivated at an early period in Flanders and Germany, and to have been introduced into the gardens of England in the beginning of the 16th century. In the reign of Charles I., ladies wore C. leaves as an ornament instead of feathers; and the beauty of the leaves is still occasionally acknowledged by placing a root, or the upper portion of one, in water, that it may throw out young leaves to adorn apartments in winter. The C. prefers a light and rather sandy soil, and often succeeds very well on a peat soil. It is very liable to the attacks of the larva of the Crane Fly (q. v.), by which the greater part of a crop is sometimes destroyed when the young roots are about the thickness of a quill; on which account, in gardens where there is particular reason to apprehend danger from this enemy, it is the practice to make a number of successive sowings, some of which may probably escape. As an article of food, C. contains a large amount of what are called heat-producing compounds, with a small proportion of flesh-forming matter. It consists essentially of starch, sugar, and albumen, along with a volatile oil, which communicates a flavour to many dyspeptics

CARROUSEL—CARSTAIRS.

very unpleasant. The following is the composition of dried carrot :

Starch and sugar,	93·71
Albumen,	4·35
Red neutral substance (carotin),	0·84
Fixed and volatile oils,	1·00
Ash,	0·60
	100·00

C. is easy of digestion, and gently laxative. Boiled C. is used as a poultice for foul ulcers and other sores, and as a vermifuge. Grated C. forms an agreeable cooling, but also stimulant application. A sirup is prepared from carrots; and when cut into small pieces and roasted, they are occasionally used in Germany as a substitute for coffee. A strong ardent spirit is distilled from them in some parts of Europe, 10 lbs. of carrots yielding about half a pint. C. seeds are employed as a diuretic, also as a carminative and stimulant; those of the wild C. being preferred.—Besides the crane fly, already noticed, carrots have numerous other insect enemies. One of the most troublesome is the CARROT FLY (*Psila rosea*), a small dipterous fly, the larvæ of which, by eating away the surface of the

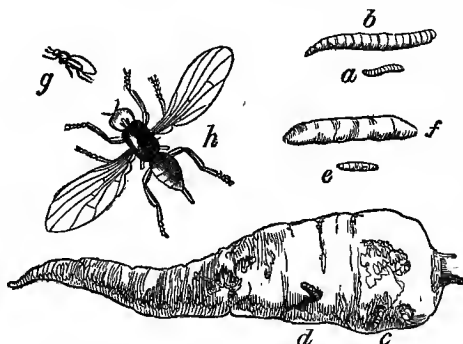

Carrot Fly (*Psila rosea*):*

a, larva, natural size; b, larva, magnified; c, d, its operations on the root; e, pupa, natural size; f, pupa, magnified; g, mature insect, natural size; h, mature insect, magnified.

root, cause what is commonly known as *rust* in carrots, and prepare them for the further operations of millepedes and other destroyers. The larvæ of several species of moth (*Depressaria*) are very injurious to them when in flower and seed. An aphid (*A. dauci*) often kills the young plants.

CARROUSEL (Fr.), a species of knightly exercise, which, down even to the beginning of the 18th c., was very common in all the courts of Europe. C. was a kind of imitation of the tournament, and for a time after the discontinuance of the latter seems to have supplied its place. The dresses, for the most part, were those of the knights of former times, and the combatants, or rather competitors, were divided into two parties, usually according to their different nationalities. One of the favourite exercises in France consisted in running at the pasteboard head of a Moor or Turk with a lance, cutting it down with a sword, or firing at it with a pistol. Another of these tests of skill and horsemanship, if not of courage, consisted in carrying off a whole line of rings, which were suspended for the purpose. The C. in France was not known earlier than the reign of Henry IV.; but it had existed for some little

time previously in Italy. There were brilliant carrouseles under Louis XIII., and two celebrated ones were given in honour of Mademoiselle de la Vallière—the one at Paris in 1662, the other at Versailles in 1664. The place where the first of these fêtes was held, has ever since been called the Place du Carrousel. A revival of the C. was attempted at Berlin in 1750; and in 1828 the Cavalry School at Saumur held one in honour of Madame la Duchesse de Berry. The so-called Eglinton Tournament—an entertainment given some years ago by the chivalrous Earl of Eglinton—was in reality a carrousel.

CARSE is a term applied in Scotland to low lands adjoining rivers. The word is of uncertain origin. In Stirlingshire, it is restricted in its sense to the level alluvial soils which are only a few feet above the river Forth. In Perthshire, it also applies to the whole of the slightly undulating lands to the north of the Tay, which form the C. of Gowrie. C. soils usually consist of argillaceous deposits, which produce crops of great luxuriance, although there are some which consist of hungry and barren clays. The richest of them are of a hazel colour, and become friable when exposed to the action of frost; the poorest, on the other hand, are of a yellow colour, containing little vegetable matter to render them amenable to cultivation. The best kinds of C. soils are generally farmed on the six-course shift—1. Grass; 2. Oats; 3. Beans; 4. Wheat; 5. Potatoes; 6. Turnips or Fallow. Large crops of grass are grown when the clover-plant catches. It is mostly made into hay, and the after-math is used for soiling horses and cattle in the straw-yards. The land is seldom pastured, as the feet of animals trample and destroy the grasses, when the weather is wet. The oat-crop is more uncertain on the carse, but in favourable years, the yield is large, and the quality of the grain is excellent. Beans are very successfully grown, indeed the best of the C. soils are the best bean-soils in Scotland. Where the land is rich, and not too stiff, the potato is sometimes largely grown. On the poorest description of the C. soils, the potato does not thrive. Wheat can be grown in closer succession on the C. lands, than on any other description of land with the same expenditure of manure. A large stud of horses are required on C. lands, to enable the farmers to prepare the land for the various crops, at the moment when the season suits. A small portion of the land is still usually summer-fallowed, as it is found that it cannot be kept thoroughly clean by green crops in rainy seasons.

CARSTAIRS, WILLIAM, a distinguished political and ecclesiastical character of the 17th c., who took a very active part in bringing about the Revolution of 1688, was born at Cathcart, near Glasgow, February 11, 1649. He was educated at the village school of Ormiston, in East Lothian, and subsequently at the university of Edinburgh, where he displayed a remarkable aptitude for learning. In his 24th year, Scotland being then in a most unsatisfactory state, alike from a political and religious point of view, C. went to study theology at Utrecht. His scholarship, polite address, knowledge of men, and great political information, especially regarding his own country, recommended him to the notice of the Prince of Orange, who chose him as his confidential adviser in all matters relating to Britain. In 1682, being in England on a mission of observation from Holland, he was employed to negotiate between the English and Scotch conspirators in the Rye House Plot. With others implicated, he was arrested and put to the torture

* For the accompanying illustration, and many others of a similar nature throughout this work, we are indebted to Morton's *Encyclopædia of Agriculture*.

CARSTENS—CART.

of the thumb-screw, but refused to confess anything that had not been previously revealed, and that only on condition that what he said should not be used in evidence, either directly or indirectly, against any other person. At this time, he had secrets from Holland of the greatest importance in his possession, which he carefully concealed, although there can be no doubt that their revelation would not only have saved him from torture, but have obtained for him great reward and honour. Britain, therefore, owes very much indeed to the firmness of C. at this juncture. He returned to Holland about the beginning of 1685; and, acting mainly on his advice, the Prince of Orange planned and carried out the invasion of 1688. He accompanied the prince as chaplain, and after the settlement of the crown, when the prince had been firmly established as William III., C. was instrumental in effecting a reconciliation between him and the Scottish Church, when the ill advice of other councillors had nearly led to an open rupture. From 1693 to the death of the king in 1702, he could not have had more influence in Scottish affairs if he had been prime-minister of the country; and his authority in church-matters was such, that he was popularly called 'Cardinal Carstairs.' He was elected Principal of the university of Edinburgh in 1704, and in this capacity used all his influence with government to obtain an increase of patronage for the Scottish colleges. In the same year, he was presented to the Church of Greyfriars, and was appointed Moderator of the General Assembly next succeeding, an office to which he was four times elected in the course of eleven years. He died August 1715, deeply regretted by the whole nation, and leaving a reputation for scholarship and sincere piety, as well as for unbounded charity and political sagacity rarely equalled.

CARSTENS, ASMUS JACOB, an eminent German artist, was born near Schleswig, May 10, 1754. In 1762 he went to Copenhagen, where, when first introduced to the Royal Gallery of Paintings and Casts from the Antique he was so excited that he shed tears of joy. After staying seven years in the Danish capital, where he produced his 'Baldur's Death,' and 'Eolus and Ulysses,' supporting himself chiefly by portrait-painting, he commenced a journey on foot to Rome, but was obliged to return for want of means after reaching Mantua. He resided in Lubeck for some time, but through the kindness of a wealthy amateur artist named Rodde, he contrived to reach Berlin, where his great composition, the 'Fall of the Angels' (with 200 figures), gained for him an appointment as professor in the academy, while his decoration of a saloon in the Dorville Palace obtained for him an introduction to the king and a pension. He was now enabled to visit Rome, where he devoted himself to the study of the works of Michael Angelo and Raphael. His first work in Rome, a 'Visit of the Argonauts to the Centaur Chiron,' was distinguished by purity of style, beauty of forms, and fine distribution of light. His numerous subsequent drawings mostly represented scenes from the ancient classic poets, with subjects from Ossian, Dante, and Shakspeare. C. died May 26, 1798.

CART, a species of carriage with two wheels, in which respect it differs from the ordinary wagon that has four wheels. There are different kinds of carts, according to the nature of the goods or articles to be carried, and they also differ considerably in different countries. The C. is little seen in England, where the heavy and more capacious wagon takes its place. It is, however, used for

agricultural and other purposes in Cumberland and adjoining northern counties. There, it differs only in a slight degree from the C. universally used in Scotland. The Scotch C. is an exceedingly convenient form of carriage for general merchandise, or for agricultural produce, and well adapted for being drawn on roads in a hilly country. A material advantage consists in its weight, being about only half a ton, while its usual load is from a ton to 22 cwt.; from which circumstance it is a particularly handy vehicle for comparatively light loads, and so far is superior to the English wagon, which is best adapted to carry huge loads of from two to three tons. In carrying hay, straw, or grain from the harvest-field, Scotch farmers employ a peculiar kind of C. without sides to admit of a bulky load; but they also, as occasion serves, use for a similar purpose an ordinary C., on which they place a movable frame, as is seen in the adjoining cut. All grain for

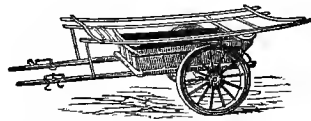

Scotch Cart, with movable frame.

market is carried in the one-horse C., and a driver takes charge of two carts. The following advantages of one-horse carts are well enumerated by Lord R. Seymour: 'A horse, when he acts singly, will do half as much more work as when he acts in conjunction with another; that is to say, that two horses will, separately, do as much work as three conjunctively. This arises, in the first place, from the single horse being so near the load he draws; and in the next place, from the point or line of draught being so much below his breast, it being usual to make the wheels of single-horse carts low. A horse harnessed singly has nothing but his load to contend with; whereas, when he draws in conjunction with another, he is generally embarrassed by some difference of rate, the horse behind or before him moving quicker or slower than himself; he is likewise frequently inconvenienced by the greater or less height of his neighbour: these considerations give a decided advantage to the single-horse cart. The very great ease with which a low C. is filled may be added; as a man may load it, with the help of a long-handled shovel or fork, by means of his hands only; whereas, in order to fill a higher C., not only the man's back, but his arms and whole person must be exerted.' To these just observations it need only be added, that in many parts of England there is a wasteful expenditure in horse-power, a pair of horses being often set to draw a clumsy wagon to market, containing a load which could with the greatest ease be drawn by one horse in a less ponderous machine.

The one-horse C. is employed by carriers all over Scotland, the load being usually piled high in a square form, and covered in with a woollen wrapper, in which state the C. is drawn 18 to 20 miles a day. See CARRIERS. In France and Germany, the carrier's C. is a more gigantic machine. Long in the body, very strong in construction, and poised on two high wheels with broad rims, this continental C. carries enormous loads, almost equal to what are seen in the large wagons of England. The ingenious manner in which the load is adjusted to rest exclusively on the wheels, and so relieve the single horse in the shafts, is matter of surprise to all strangers. All carts, whatsoever, in Great Britain, must bear the name and address of the

CARTAGENA—CARTHAGE.

owner, painted conspicuously on them, according to statute 1 and 2 Will. IV. c. 22. See **WAGON**.

CARTAGENA, a fortified seaport of Spain, on a bay of the Mediterranean, in lat. 37° 36' N., long. 0° 57' W. It is built partly on the declivity of a hill, and partly on a plain extending down to the sea, and is enclosed by hills which screen it from all winds. The harbour is one of the best in the Mediterranean, capacious enough to hold the largest fleets. The entrance is narrow, and completely commanded by the fortifications on an island called La Isoletta, on the south. It was formerly the largest naval arsenal not only in Spain but in Europe, but is now decayed and desolate. The city, which is surrounded by walls, has quite a Moorish aspect imparted to it by its old streets, as well as by its Moorish cathedral, and the ruins of an old castle on the top of a hill of the same order of architecture. C. has several well-built and spacious streets, but with one or two exceptions, they are all badly paved. Red marble is so plentiful, that it is used for the commonest purposes. C. has manufactures of sail-cloth and glass, and a trade in barilla, agricultural produce, &c. The tunny fishery is important, and the silver and lead mines, anciently wrought and recently reopened, promise to be again valuable. Pop. 33,593. C., which was a colony of the Carthaginians, was built by Hasdrubal 242 B.C., under the name of New Carthage. It formed the head-quarters of the Carthaginians in Spain, and soon became a city of much wealth and influence. It was captured by P. Scipio in 210 B.C., and became of importance under the Romans, who are said to have employed 40,000 men daily in the mines in the neighbourhood. It was sacked by the Goths, and did not again attain any note until the time of Philip II.

CARTE, THOMAS, an English historian, distinguished for his industry and research, was born at Clifton, in Warwickshire, where his father was parish minister, in 1686. Educated at Oxford, he afterwards took the degree of M.A. at Cambridge, and entering holy orders, was appointed reader at the Abbey Church, Bath; but being attached to the Stuarts, he resigned his office rather than take the oaths to the new government. In 1722, he was suspected of having been concerned in the conspiracy of Bishop Atterbury, whose secretary he was, and £1000 was offered for his apprehension; but he escaped to France, where he remained for some years. On his return to England, he published a life of the Duke of Ormond, remarkable for the fulness of its information. In 1747—1755, he published a *History of England*, bringing it down to the year 1654. This work is very valuable for its facts, but the author had not the capacity to grapple with these philosophically. Hume and other historians, however, have been much indebted to him for the materials of history. Among his other works was an edition of *Thuanus*; and at his death, in 1754, he left behind him 20 folio and 15 quarto volumes of MSS., in further illustration of the history of England to 1688, which have proved of great utility to subsequent writers. These are preserved in the Bodleian Library, Oxford.

CARTEL, during a time of war, is an agreement between the belligerents for an exchange of prisoners. Sometimes the name is given to a ship, called by the French a *bâtiment parlementaire*, commissioned to convey the exchanged prisoners, or to carry messages to the enemy. A ship, when thus employed, must carry no cargo, ammunition, or implement of war, except one gun for signals.

CARTER, ELIZABETH, an English lady, remarkable for her classical attainments, and also for her knowledge of modern languages, was born

December 1717, at Deal, Kent. Slow at first to learn, she afterwards displayed remarkable aptitude. In her 21st year she published a small volume of poems, and in the succeeding year she translated from the Italian of Algarotti *An Explanation of Newton's Philosophy for the Use of Ladies*. These publications brought her into note, and obtained for her the friendship of such men as Bishop Butler, Archbishop Secker, Sir Joshua Reynolds, Burke, and Dr Johnson, the latter of whom especially held her in great esteem, and had the highest opinion of her proficiency as a Greek scholar. A translation of Epictetus which she made, was most favourably received by the literary press of her time, both at home and abroad. She died unmarried, February 1806, at the age of 89.

CARTERET, JOHN, EARL GRANVILLE, a distinguished orator and statesman of the 18th c., was born April 1690, his father being Baron Carteret of Hawnes, Bedfordshire. His education, commenced at Westminster School, was completed at Oxford. From the latter place, according to Dean Swift's humorous assertion, he carried away more Greek, Latin, and philosophy than was at all becoming a person of such high rank. Introduced into the House of Peers in 1711, he spoke in favour of the Protestant succession, and in consequence received the early notice of George I., and obtained some lucrative appointments. In 1718—1719, he was appointed ambassador extraordinary to Sweden, and in the following year succeeded in concluding a peace between Sweden, Prussia, and Hanover. In 1721, he was appointed secretary of state, and in this capacity defended with great zeal the proceedings of government in the Atterbury conspiracy. In 1724, he was made lord lieutenant of Ireland. During his vice-regency, he was in constant intercourse, and held frequent discussion, with Dean Swift about public affairs. His lord lieutenancy, which lasted from 1724 to 1726, and again from 1729 to 1730, was popular, particularly the latter period. From 1730 to 1742, he was one of the most able and determined of the leaders of the opposition in the House of Lords against Sir Robert Walpole, and on his displacement, was made a secretary of state. On the death of his mother in 1744, he succeeded to the title of Earl Granville, and in the same year had to resign his seals of office, the Broad Bottom Ministry (q. v.) expressly excluding him; but he continued to receive marks of the royal favour. C. was a most liberal patron of men of letters. He died January 1763.

CARTHAGE, called *Carthago* by the Romans, *Carthædon* by the Greeks, both of which are but forms of the native name *Karth-hadtha*, i. e., 'New Town' (found on ancient coins), was the greatest city of antiquity on the north coast of Africa, and was situated in what now constitutes the state of Tunis, on a peninsula extending into a small bay of the Mediterranean Sea. It was founded, according to legend, by Dido (q. v.), a Phœnician queen, who had fled from Tyre after the murder of her husband almost nine centuries before the Christian era, but more probably (like the Anglo-Indian Calcutta) it originated in an emporium or *factory* established by the colonial merchants of Utica, and the capitalists of the mother-city Tyre, on account of the convenience of its situation. Unfortunately, we know very little of its growth. Our information only begins after C. had become one of the greatest commercial cities of the world, and we have but very scanty and one-sided accounts of it even then. The number of the inhabitants before its destruction amounted to about 700,000. The

CARTHAGE.

population was partly of Phœnician, partly of Libyan descent. The territory which the Carthaginians acquired by the subjugation of the Libyan tribes, and by the ultimate annexation of other older Phœnician colonies, with which they had at first been simply in alliance, such as Utica, Hadrumetum, Tunis, Hippo, the two Leptæ, &c., extended in the middle of the 5th c. B.C. southward to Lake Triton, eastward to the Great Syrtis, and westward to Hipporegius (now Bona). The maritime power of the Carthaginians enabled them also to extend their settlements and conquests to the other coasts of the Mediterranean. In the 6th c. B.C., they were masters of Sardinia, and had begun to contend for the possession of Sicily. Hanno (q. v.) founded colonies on the west coast of Africa beyond the Straits of Gibraltar, and Himilco visited the coasts of Spain and Gaul. The relations of C. to foreign states in earlier times are not very clear. The first treaty with the Romans was concluded in 509 B.C.; the second, in 348 B.C.; the third, in 306 B.C. The connected history of C. begins with the 5th c. B.C., a period of wars between the Carthaginians and the Greeks in Sicily. The Carthaginian army under Hamilcar was destroyed by Gelon at Himera in 480 B.C. It was not till 410 B.C. that the war began which ended in the conquest by the Carthaginians of some parts of the island. Dionysius the Elder, or rather the pestilence working for him, put a stop to their conquests, but did not succeed in expelling them. War raged almost constantly between Dionysius and the Carthaginians. The more feeble reign of Dionysius the Younger afforded them an opportunity of extending their conquests, yet they were frequently repelled and defeated by the Sicilian Greeks; and during 311–301 B.C., Agathocles carried the war into Africa, and attacked C. itself. After his death, the Carthaginians again increased their dominions in Sicily; and although Pyrrhus contended successfully against them at first, he left that island entirely in 275 B.C. The subjugation of the south of Italy by the Romans, brought the two great and conquering nations into collision, and the First Punic war arose, 264 B.C., and after a great naval victory of the Romans, terminated in 241, the Carthaginians giving up Sicily, Sardinia, and Corsica, and paying to the Romans a large sum of money. Soon after this, a mutiny of the hired troops of C., combined with an insurrection of the Libyan tribes, the ancient inhabitants of the country, who were kept down by the arbitrary rule of the Carthaginian colonists, threatened the entire ruin of the city. Hamilcar brought that bloody war, however, to a successful termination, and led an army to Spain, where he, and after him Hasdrubal, obtained great successes. Here was founded New C., now Cartagena (q. v.). After Hasdrubal's death, 221 B.C., Hannibal (q. v.), burning to revenge the defeat which his native city had sustained from the Romans, broke the treaty with them, and took Saguntum, 219 B.C. Thus began the Second Punic war, in which Hannibal pursued his career of conquest from Spain, through Gaul, and across the Alps into Italy itself, defeated the Romans with terrible slaughter in various battles, and, by that of Cannæ in particular, brought Rome to the very brink of ruin. Yet the war terminated in the total defeat of the Carthaginians by Publius Cornelius Scipio, who overthrew their power in Spain, and was victorious over Hannibal in the final and decisive battle of Zama, in Africa, in October 202. A peace was then concluded, in which the Carthaginians were limited to their African territories; but most of their ships of war and war-elephants were taken from them,

besides an immense sum of money, and they were taken bound not to make war without permission of the Romans. Massinissa, king of Numidia, skillfully availed himself of dissensions which arose within C. between the nobles and the people, to advance his own interests at the expense of the Carthaginians; and as they (151 B.C.) opposed him, and drove his adherents out of the city, the Romans seized the opportunity for a new declaration of war, 149 B.C., on the ground that the treaty was broken; and after a siege of two years, C. was taken by Publius Cornelius Scipio Aemilianus, 146 B.C. For six days the combat was maintained in the streets of the city, and for seventeen days the work of its destruction by fire was carried on by the conquerors. The country became a Roman province. C. Gracchus sent out 6000 colonists to found a new city on the site of Carthage. It was called Junonia, but it did not prosper. Augustus, carrying out the intention of his great uncle, restored the city, and the new C. had become, in the second and third centuries of the Christian era, one of the finest cities of the Roman empire. In 439 A.D., Genseric made it the capital of the Vandal kingdom; Belisarius conquered it in 533, and named it Justiniana; the Arabs under Hassan utterly destroyed it in 647 A.D.; and now only two or three small hamlets and a few ruins mark its site.

We have not very satisfactory accounts of the constitution of the Carthaginian state. It is certain that it was oligarchical, and that the chief power was in the hands of the great families (*gentes*), from whose members the senate, amounting to 300, was chosen. This senate appointed, as it were, a more select council of 30, and sometimes a still smaller one of only 10, at the head of whom were two *suffetes* (probably the same as the Hebrew *shofetim*, 'judges'), but it is not certain what relation these bore to one another, or how their power was apportioned between them. We can gather dimly, from various scattered statements, that the Carthaginian oligarchy, while despising the multitude, was itself split up into factions, and torn by family jealousies. Corruption largely prevailed; and it would perhaps have been better for the country if the power had been in the hands of a popular despot than of a band of insolent and tyrannical nobles.

The Carthaginian army was raised from the conscription of the subjugated Libyans, from the hired Numidians, and from slaves. In the time of Agathocles, the city sent forth 40,000 heavy armed infantry, 1000 cavalry, and 2000 war-chariots, but the state could easily raise 100,000 troops. The fleet in the First Punic war consisted of 350 ships, carrying 150,000 men. How C. contrived to raise revenues sufficient to cover the enormous expense her military and naval organisation involved, is not very clear. It was, in all likelihood, derived from tribute imposed on subject Libyan or Numidian races, in great part from mines in Spain, and from import duties derived from her maritime and inland trade, which was prodigiously great. Her merchantmen visited every coast and island of the Mediterranean, and even ventured as far as the Azores, Britain, the Baltic, &c.; while her caravans penetrated through Sahara to the gold-producing districts of the Niger, and through the Libyan Desert to the lands along the Nile.

The religion of the Carthaginians appears to have been substantially the same as that of the Phœnicians—a worship of the stars and of fire. Moloch was the chief deity, and to him children and captives were sacrificed. The highest natural manifestation of this deity was the Sun. Besides Moloch, the Carthaginians worshipped the Tyrian Hercules; Astarte, the goddess of the elements;

Esmon, the god of the celestial vault; and a variety of heroes, heroines, and genii or spirits, such as the Genius of Death, Hamilcar (who fell at the battle of Himera), Dido, the brothers Philani, &c., as well as a few of the lesser Greek divinities, of whom a knowledge had been obtained in Sicily. It does not appear that there was a distinct sacerdotal order in Carthage. Probably religious ceremonies were performed by the dignitaries of the state, but our knowledge on this interesting point is too meagre to permit of our arriving at any very definite conclusion.

CARTHAGE, CAPE, a headland of North Africa, jutting out into the Mediterranean, in lat. 36° 52' N., long. 10° 22' E. Traces of the ancient city of Carthage (q. v.) are found on it to the north of the Tunis lagoon.

CARTHAGE'NA, capital of the province of the same name in New Granada. It stands on the Caribbean Sea, a little to the south-west of the mouth of the Magdalena, in lat. 10° 26' N., and long. 77° 54' W., having the best harbour on the coast, with a naval arsenal and strong fortifications. Its population is estimated at 10,000, not more than one-tenth being white. The temperature ranges from 80° to 86° F.—the air, however, being dry and healthy. In the history of Spanish America, and more especially in that of the war of independence, the city occupies a prominent place.

CARTHAGENA BARK. See CINCCHONA.

CARTHA'GO, a term of various application in Central America.—1. An almost landlocked bay or lagoon of the Caribbean Sea near the north-west extremity of the Mosquito shore.—2. A river entering the same from the south-south-west, about lat. 15° N., and long. 84° W.—3. A river of Costa Rica, flowing into the Gulf of Nicoya, an inlet of the Pacific, near lat. 9° 30' N., and long. 84° 30' W.—4. A city, or rather the ruins of one, on the same, about 60 miles from its mouth. Down to 1841, it was the capital of Costa Rica; but being in that year all but destroyed by an earthquake, it was supplanted by San José, previously its superior in wealth and importance, about 15 miles to the west-north-west of itself. The volcano of its own name, doubtless connected with its overthrow, is valuable as a landmark to mariners.

CARTHAMINE, or **CARTHAMEINE**. The dye so called is obtained by a chemical process from safflower (q. v.), (*Carthamus tinctorius*), in crystals which are insoluble in water, but slightly soluble in alcohol and ether. When newly precipitated, C. immediately and permanently attaches itself to cotton or silk, but not to wool, requiring no mordant, dyeing the fabric a fine red, which is changed to yellow on the addition of alkalis, and may be returned to red again on being treated with acids.

CARTHUSIANS, a monastic order which owes its origin to St Bruno, who retired in 1086 with six companions to the solitude of La Chartreuse, near Grenoble, where they built hermitages, wore rude garments, and lived upon vegetables and coarse bread. From this place the order took its name. After Bruno's death it increased, and in 1134 received written rules from its fifth prior, Guigo, called the *Statuta Guigonis* or *Consuetudines Cartusie*, but the rules have been often changed. In 1170, the order received papal approbation, and thereafter extended rapidly. The C. made their appearance in England in 1180—1181. The name which their monasteries obtained there (Chartreuse-houses) was corrupted into charter-houses. Each Carthusian monk is required to dwell in a separate cell, with only a bed of straw, a pillow,

and coverlet of coarse woollen stuff, with the means of manual labour or of writing, and can leave his apartment only once a week. On festival days only, the monks eat together. At least once a week, there is a fast-day, on which only bread, water, and salt are allowed. Besides the ordinary monastic vows, the C. are under a vow of continual silence and of religious exercises. To break silence, except on particular days, is visited with the penance of flagellation. The use of flesh is forbidden, and of wine unmixed with water. The C., however, notwithstanding their vow of poverty, have built some magnificent convents, as *La Grande Chartreuse*, near Grenoble, and *Certosa*, near Pavia. They are given to hospitality and works of charity, and are on the whole better educated than the mendicant orders. They now exist chiefly in Italy, France, and Switzerland.—The Carthusian nuns arose at Salette, on the Rhone, in France, about 1229. They followed the rules of the Carthusian monks, but with some mitigation. Silence being a greater hardship for a woman than for a man, was not so rigorously insisted on.

CARTILAGE is a firm elastic substance, of a pearly whiteness, presenting to the unaided eye a uniform and homogeneous appearance. Cartilages may be divided into the *temporary*, the *permanent*, and the *accidental*. The *temporary* cartilages are substitutes for bone in the earlier periods of life, and after a certain time become ossified. See OSTEOLOGY. At birth the extremities and larger eminences of the long bones, and the margins of the flat bones are still cartilaginous, and this C. does not altogether disappear till the period of puberty. The *permanent* cartilages are either *articular* or *non-articular*. *Articular* cartilages are attached to the extremities of bones, and enter into the formations of joints. *Non-articular* cartilages are usually more flexible than the articular. They are sometimes attached to bones, to lengthen them out, as, for instance, in the nose, the auditory canal, and the Eustachian tube. See HEARING, ORGANS OF. In other cases they form the basis of distinct organs, as the larynx, the trachea, and the eyelids. *Accidental* cartilages are cartilaginous concretions, which are occasionally found in situations where they do not normally occur, and are of no general interest. The physical properties of cartilages, especially their elasticity, resisting power, and incapability of extension, are such as to fit them admirably for the functions which they have to perform in the animal economy. A brief notice of the microscopical characters of C. will be found in the article CELLS, and a reference to its chemical composition will be found in the articles CHONDRIN and GLUTEN.

CARTILAGINOUS FISHES are those fishes which have a skeleton destitute of bony fibres. In some of these fishes, the skeleton is merely rudimentary, so that they seem to form an intermediate link between vertebrate and invertebrate animals. In the lancelets (q. v.) (*Amphioxus*) it consists of nothing more than a slender, transparent, flexible dorsal column; in *Myxine* also it is a soft flexible tube, without appearance of vertebræ or of ribs; in the lampreys, the dorsal column is still a mere cylinder of cartilage, without any notable division into segments; whilst even in the sturgeon, the centre of the backbone is a continuous gelatinous cord, and in the sharks the vertebræ are formed of hollow cones, meeting at their apices in the middle, and having their cups filled with the remains of the gelatinous cord, an arrangement from which result great elasticity and flexibility. In many instances, even in the higher C. F., several vertebræ are united

in a single piece; in all of them the skull is formed of a single piece without sutures, although the general form agrees with that of the skull of other fishes, and the same parts or regions may be recognised. The calcareous matter present in the skeleton is always deposited in a granular manner, giving a characteristic dotted appearance; but even in the skull of the Basking Shark, one of the most highly organised, the earthy matter has been found to form little more than 3 per cent. of the whole substance; in the skeleton of the lamprey, it is only $1\frac{1}{2}$ per cent. In other parts of their organisation, C. F. differ from each other very widely; some of them possessing the organs of the senses in as great perfection as any fishes whatever, whilst in others these organs are very imperfectly developed. Linnæus placed the C. F. along with Batrachian reptiles in his class *Amphibia*. By the general consent of naturalists, however, they are placed in the class of Fishes. Cuvier, referring to the very different degrees of organisation which they exhibit, says 'they form a series ranging parallel to the bony fishes, just as the marsupial mammalia range parallel with the other ordinary mammalia.' Owen and others, admitting the justice of this view, have, however, pointed out in the C. F. generally, characters corresponding with those of the osseous fishes in their embryotic state, and with the permanent or mature conditions which prevailed among the fishes of some of the older geological periods. One remarkable characteristic even of the higher groups of C. F.—sturgeons, sharks, rays, &c.—is the *heteroocercal* tail, the vertebral column being prolonged into the upper portion of the caudal fin, and the lower one given off on its under side, as in the fossil fishes generally of the Old Red Sandstone and other oldest fish-producing rocks.—Cuvier divided C. F., or *Chondropterygii* (Gr. cartilage-finned), into three orders: *Sturiones* (Sturgeon, Chimæra, &c.), having the gills free, and gill-openings with a lid, like the osseous fishes; *Selachii* (Sharks and Rays), having the gills fixed, and consisting of folds of membrane on a plane surface, with numerous gill-openings, the jaws movable as in other fishes generally; and *Cyclostomi* (Lampreys, &c.), also having fixed gills and numerous gill-openings, the mouth adapted for sucking. Müller and Owen, however, separate the *Cyclostomi* of Cuvier from the other C. F., on account of important anatomical differences, particularly in the structure of the heart, which in the *Cyclostomi* wants the *bulbus arteriosus*, or thick muscular swelling of the commencement of the arterial system close to the ventricle; whilst this, which may, in fact, be considered as a third chamber of the heart, is present in the *Sturiones* and *Selachii*, and within it are three or more longitudinal rows of valves; characters derived from the vascular system being deemed by these great naturalists of the highest value in determining the arrangement of the class of fishes. The lancelets occupy a place by themselves, from their absolutely wanting a heart, and having the circulation carried on by the muscularity of the entire vascular system.

CARTOON (Ital. *cartone*, pasteboard; from Lat. *charta*, paper). In the fine arts, C. is a design on strong paper, of the full size of a work to be afterwards executed either in fresco, oil colour, or tapestry. The object of the artist in preparing a C. is, that he may adjust the drawing and composition of his subject in circumstances in which alterations can be effected with facility, before proceeding to the execution of the work itself. Cartoons are generally composed of a number of sheets of stout paper or pasteboard, pasted together at the edges, and stretched on a frame. The surface is sometimes *primed*, or washed with a ground-colour; but more frequently this process is dispensed with. The

drawing is made either in chalks or in *distemper* (q. v.), in which latter case the C. itself has very much the appearance of a fresco. Frequently only two colours are used, merely for the purpose of producing light and shade, in which case the C. is said to be *in chiaro oscuro*. The C., when finished, is transferred to the canvas or plaster on which the work is to be executed, either by tracing with a hard point, or by pricking with pins, charcoal in both cases being used. Sometimes lines are simply drawn across it, or, if it is wished to preserve it from injury, threads are stretched across it from pins placed at the required distances along the edges. In *fresco* painting (q. v.), the plaster on which the work is executed must be kept wet, in order that it may absorb the colour, and consequently only a small portion can be executed at a time. For this reason, the C. must be traced in small compartments of the size that the artist can finish without stopping. It is here, consequently, above all, that the necessity for the previous execution of a C. is greatest, as it would be impossible to sketch the whole design on the plaster in the first instance. But the great masters used such studies in *chiaro oscuro* as guides to them in almost all their more extensive works, and many of these monuments of their care, as well as of their genius, have been preserved. We have cartoons of Andrea Mantegna, Domenichino, the Caracci, &c.; but the finest specimens of cartoons in existence are those of Raphael at Hampton Court. These marvellous conceptions were sent to Flanders in the reign of Leo X., in order that they might be copied in tapestry in two sets, one of which was designed for the pope, the other for a present by the pope to Henry VIII. of England. The tapestries, which are very inferior to the designs, are still in existence. One set is in Rome, the other was in England till the death of Charles I., when it was purchased by the Spanish ambassador, and carried to Spain. At a recent period it was brought to London and offered for sale, but as no English purchaser was found, it was again carried to the continent. For many years the cartoons, originally twenty-five in number, lay neglected at Brussels, and many of them were destroyed. The seven now at Hampton Court were at length purchased by Rubens for King Charles I. It is an instance of Cromwell's good sense, in a direction in which it was not often exhibited, that at the dispersion of the royal collections, these cartoons were purchased for the nation by his special command. So low was the artistical taste of the time, however, that whilst the 'Triumph of Julius Cæsar,' by Andrea Mantegna, still at Hampton Court, was valued at £2000, the cartoons of Raphael were set down at £300! In Charles II.'s time, these remarkable works were again consigned to oblivion. An attempt was made to have them copied in tapestry, by which they were seriously injured. William III., strangely enough, followed in Cromwell's footsteps in appreciating what Charles II. had neglected. He had the cartoons restored, and built a gallery for them at Hampton Court, where, with the exception of a visit to Windsor in George III.'s time, they have since sojourned. The following are the subjects represented: 1. Paul Preaching at Athens; 2. The Death of Ananias; 3. Elymas, the Sorcerer, struck with Blindness; 4. Christ Delivering the Keys to Peter; 5. The Sacrifice at Lystra; 6. The Apostles Healing the Sick at the 'Beautiful Gate' of the Temple; 7. The Miraculous Draught of Fishes. Our space and our design equally preclude us from attempting any statement of the merits of these exquisite compositions. Several of the lost cartoons are partially transmitted to us by engravings, some of which were executed from the tapestries; others, it is believed,

CARTOUCH—CARTWRIGHT.

from the originals. The subjects of these are—1. The Adoration of the Kings; 2. Christ appearing to Mary Magdalene; 3. The Disciples at Emmaus; 4. The Murder of the Innocents; 5. The Ascension. These were engraved, along with the others, by Somereau, a French engraver, in 4to. Other cartoons of Raphael exist—one the property of the Duke of Buccleuch, and two in the possession of the king of Sardinia, which are said to have belonged to the set sent to Flanders. There is also a portion of one in the National Gallery in London, but it is now painted over with oil colour. The best engravings of the cartoons at Hampton Court are by Dorigny, Audran, and Holloway; but in future it is probable that they will be more known to the public by means of photographs, of which Messrs Colnaghi and others have already produced very beautiful specimens.

CARTOUC'H is a word much used in the French military service, but less frequently in the English. The name was once given to a wooden case containing 200 to 300 musket-bullets, and 8 or 10 1-lb balls, fired from a mortar or howitzer in defence of a ditch or intrenchment; but such missiles have been superseded by others. The cartridge-box carried by the soldiers used to be called a C. in England, and still is in France.

CARTOUCHE, the name by which the French, and we after them, designate the ovals on which the hieroglyphic characters for the names of Egyptian kings are sculptured. See **CAVO-RILIEVO**. C. is also used to signify a tablet, either for ornament or to receive an inscription, so formed as to resemble a sheet of paper or parchment, with the edges and ends rolled up. Cartouches are often seen on tombs. The same term is sometimes applied to modillions, or brackets supporting a cornice.

CARTRIDGE is a cylindrical case made to contain either the whole or a part of the materials for discharging from a firearm. Those for ordnance or large guns are chiefly made of serge and flannel, sewn up into the form of a bag, which, supplied with a given weight of powder, is tied round the neck, and strengthened by iron hoops. The weight varies from about 20 lbs. for a 68-pounder, to 6 oz. for a 1-pounder.

Cartridges for small-arms are usually paper tubes containing a leaden ball and a few drachms of powder. The C. paper employed is strong and hard. It is made into a tube by means of a mandrel or former, and thinner paper is also applied at certain parts, in such a way that the powder has two or three thicknesses of paper around it, while the bullet has only one. At Woolwich, a beautiful machine is employed to make the tubes or cases from the pulp itself, instead of from sheets of paper. The paper over the bullet is lubricated with some composition, and a bit of the paper is required to be bitten or twisted off before loading. This apparently trifling matter had something to do with the revolt in India in 1857; for the sepoy's professed a horror at the contamination of their lips with (possible) beef or pig fat in the lubricating composition. *Blank*-cartridges contain powder only; while *ball*-cartridges contain a bullet as well as powder. For distinction and safety, musket-cartridges are often in white paper, rifle in green, and blank in purple; and each sort is wrapped up in paper of the same colour.

In reference to army purposes, and to all the various kinds of small-arms employed, the balls used vary from 7 to 34 to the pound, with from 2 to 10 drachms of powder. The number of cartridges kept in store is almost incredibly large. In 1849, it amounted to 80,000,000; and in the busy years

which have since passed, it has often been much higher.

The chief cartridges used for shot guns and sporting purposes, are the common wire cartridges, and the various breech-loading cartridges. The wire cartridges contain only shot packed in a case, the interstices being filled with bone-dust. They are of three kinds: the first (Universal C.) having a plain paper-covering; the second (Royal C.) is, in addition, surrounded by a light wire net-work; and the third (Green C.) has a stronger wire net-work around it. The object of these cartridges (especially the Green C., which is propelled furthest) is further shooting and harder hitting than can be attained by loose shot. They are made of various bores and sizes, and containing various quantities, to suit all guns. The breech-loader C. is a stout cylindrical paper-case, some three inches in length.

In the annexed longitudinal section of one of the

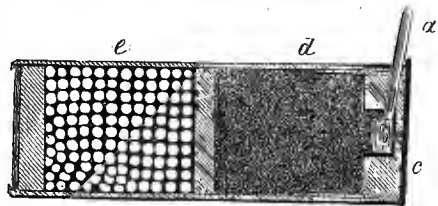

many kinds of cartridge adapted for breech-loaders, *a* is a brass pin which is forced by being struck by the hammer of the gun into the percussion-cap *b*, causing the explosion of the gunpowder in *d*, and the propulsion of the shot *e*. *c* is a brass capsule which closes up the end of the cartridge.

CARTRIDGE-PAPER is a light-coloured strong paper, originally manufactured for soldiers' cartridges (q. v.), is extensively used in art, its rough surface being useful for certain kinds of drawing. It is of three kinds—common C., engineers' C., and double engineers' cartridge-paper. The more common kind is also used as a wrapping-paper.

CARTWRIGHT, EDMUND, celebrated on account of his invention of the power-loom, was born April 24, 1743, at Marnham, Nottinghamshire. Educated at Oxford, he obtained a living in the English Church, and devoted himself exclusively to his ministerial duties and to literature, until a casual conversation, in 1784, directed his attention to machinery, and in 1785 he exhibited his first power-loom (q. v.) in action, an ingenious though very rude machine; upon which, however, he subsequently effected improvements rendering it almost perfect. Its introduction was vehemently opposed, and a mill fitted up with 500 of his looms was ignorantly and maliciously burned down. C., in 1790, took out a patent for combing wool, and secured patents for various other improvements in connection with manufactures. But his patents yielded him little return, and in 1809, government, in consideration of his inventions, granted him £10,000. C. was the author of a legendary poem, entitled *Arminia and Elvira*, and other poetical pieces. He died October 1823.—**CARTWRIGHT, JOHN** (born 1740; died 1824), known as Major Cartwright, and distinguished for his efforts to obtain parliamentary reform during the reign of George III., was elder brother of the above.

CARTWRIGHT, THOMAS, a distinguished puritan divine of the 16th c., was born in Hertfordshire about 1535. He studied at Cambridge, where, in 1570, he was chosen Margaret Divinity professor. His lectures here were too honestly critical of

the polity of the church to be acceptable to the chief authorities, who deprived him of his professorship, and subsequently of his fellowship. O. now travelled on the continent, and made the friendship of such men as Beza, who, in a letter concerning him, says, 'I think the sun doth not see a more learned man.' On the continent he officiated as minister at Antwerp, and afterwards at Middleburg, to the English residents at these places. On his return to England, he again became embroiled with the church and the government, and for his nonconformity suffered imprisonment several times. He was finally released in 1592, and permitted to preach; but the harassing persecutions, and the confinement to which he had been exposed, had permanently injured his health. His *Admonition to the Parliament* involved him in a controversy with Whitgift, afterwards Archbishop of Canterbury. See *Works of Whitgift*, edited by the Parker Society. He died December 1603. He wrote *A Confutation of the Rhemish Translation, Glosses, and Annotations on the New Testament*; a work which, it is said, Queen Elizabeth wanted Beza to undertake, but he declined on the ground that C. was more capable for the task.

CARUS, KARL GUST., a German scholar, physiologist, physician, and artist, was born at Leipsic 3d January 1789. He first attracted notice by a series of lectures on comparative anatomy, delivered in his native city about the year 1812. After having superintended, during the war of 1813, the French hospital at Pfaffendorf, he went to Dresden, where he was appointed professor of midwifery in the newly organised medico-chirurgical academy; but resigned his office when elected court-physician and councillor of state. In 1827, he accompanied the Prince of Saxony on his travels through Italy and Switzerland, and on his return, gave his attention seriously to painting, cultivating the art with no little success. His house is the rendezvous of all the most distinguished savans and artists in Dresden. C. has written a vast variety of works, all of which indicate great talent, and some of which are even marked by original and striking views, as, for instance, *Über den Kreislauf des Blutes der Insecten*, in which he demonstrates the circulation of the blood in insects.

CARVEL-BUILT. The difference between the *carvel* and the *clinker* methods of arranging the outer planks in ship and boat building is explained under CLINKER-BUILT.

CARVING, a subordinate branch of sculpture, is usually performed on ivory or wood. Ivory was the favourite material for this purpose in the east from an early period. Among the Babylonians, who likewise practised gem-engraving to a great extent, carved heads for staves were executed in vast quantities, as every Babylonian carried a staff and a signet-ring. During the palmy days of Grecian art, ivory was largely employed; the nude portion of the colossal statues of the gods being composed of some solid material overlaid with plates of ivory, while the remaining portions were of plate gold. At a later period, ivory was chiefly employed in small works, usually of a decorative character. During the earliest period, statues of the gods were generally of wood, painted, gilt, or draped with coloured robes, different kinds of wood being appropriated to different divinities. Carvings in ivory form an important branch of early Christian sculpture. Among the most curious of these are the ivory tablets adorned on the outside with low-reliefs, and in the inside coated with wax for the purpose of writing upon. The chair inlaid with ivory that belonged to Archbishop Maximilian in the cathedral

at Ravenna, is of this period (546—555). In the year 803, Charlemagne received two richly carved doors as a present from Constantinople, but works of the same kind were executed at a much earlier period. Towards the end of the middle ages, the art of carving in wood was brought to a high degree of perfection in Germany. Altars were adorned with carvings of this material, often of large size, and with numerous figures; in general, the nude portions were carefully and tastefully coloured after nature, and the draperies gilt. Specimens are to be seen in the churches at Altenberg, Erfurt, Prague, and in some churches in Pomerania. The finest and most perfect specimens are a series of reliefs relating to the doctrine of transubstantiation in the church at Tribees. Many of the Belgian churches also possess very beautiful examples of wood-carving. Michael Wohlgemuth of Nuremberg, and after him Veit Stoss, were eminent carvers in wood. The wood-carving on the great altar of the cathedral at Schleswig by Hans Bruggemann belongs to the beginning of the 16th century. Many graceful specimens of wood-carving, on a smaller scale, belonging to this period, are to be seen in museums. Nuremberg was celebrated for its wood-carvings; but only a few of the many works ascribed to him can be assigned with certainty to Albert Dürer. Portrait medallions, usually cut in box, were much in vogue during the early part of the 16th century. The first artist in this line was Hans Schwartz of Augsburg. During the 17th and 18th centuries, we find ivory again extensively employed in crucifixes, crosses, and goblets, with relief representations. The most eminent artist is Franz de Quesnoy.

CARY, REV. HENRY FRANCIS, known for his admirable translation of Dante, was born at Birmingham in 1772. At Oxford, where he entered Christ Church as a commoner in 1790, he was early distinguished as a classical scholar, and also for his knowledge of Italian, French, and English literature. In 1805 he translated Dante's *Inferno*, and in 1814 the whole of the *Divina Commedia*, a translation remarkable not only for its accuracy but for its expressiveness and force. He afterwards translated Pindar's *Odes* and Aristophanes's *Birds*, and wrote a series of memoirs, in continuation of Dr Johnson's *Lives of the Poets*. For some years he held the appointment of assistant-librarian in the British Museum, and died in 1844. A memoir by his son was published in 1847.

CARY, SIR ROBERT, son of Henry Cary, Lord Hunsdon, was born in 1559 or 1560, and rose to eminence in the civil service of Queen Elizabeth. For a number of years, he acted as English warden on the marches. As a courtier, he was present at the death of Elizabeth, 1603, and expeditiously rode on horseback to Edinburgh to communicate the intelligence to her successor, James VI. At the coronation of Charles I, he was elevated to the peerage as Earl of Monmouth. At his death without male issue the earldom became extinct. Sir Robert Cary wrote his *Memoirs* (Edin. 1808), a work interesting chiefly from notices connected with Border history.

CA'RYA. See HICKORY.

CARYA'TIDES (pl. of *Caryatis*, literally, a woman of Caryæ), a name given to female figures, in Greek architecture, when applied instead of columns to support a roof. The traditional account of the origin of the name is, that the inhabitants of Caryæ, a city in Arcadia, having joined the Persians after the battle of Thermopylæ, the Greeks, after their victory over the Persians, destroyed the town, slew the men, and carried the women into captivity. As male figures, representing Persians, were used

for this purpose, it occurred to Praxiteles, and other Athenian artists, that female Caryatæ, in their national costume, might be thus employed to commemorate the disgrace of their country. Lessing, and various other writers, have treated this account as fabulous; but it seems to be confirmed by a bas-relief preserved at Naples, in which two female figures are represented in the attitude of C., and which has a Greek inscription mentioning the conquest of Caryæ. Male figures used for the same purpose are called Atlantes (q. v.).



Caryatis :

From ruins in the Villa Strozzi, on the Appian Road—height, 7 feet 10 inches.

CARYOCAR, a genus of large trees of the natural order *Rhizobolacææ*, and almost constituting the whole order. They are all natives of Guiana and Brazil, and are sometimes called *Pekea* trees. They yield good timber for ship-building, and produce the delicious nuts, now not uncommon in the London market, called *Butter nuts* or *Souari nuts*. The fruit is a sort of drupe, containing several

combined nuts. The fleshy part of the drupe consists of a butter-like substance, which melts between the fingers, and is used in cookery instead of butter, on which account these trees are sometimes called *butter-trees*. It forms merely a thin covering for the nuts, the bristles on the outer surface of which, in some of the species, sting like the hairs of the nettle, and are very troublesome to those who open them. The kernels are remarkably soft. An oil is extracted from them which is scarcely inferior to olive oil. *C. nuciferum* is now cultivated in the island of Saint Vincent; but *C. butyrosomum*, *C. glabrum*, *C. tomentosum*, and other species appear equally worthy of attention.

CARYOPHYLLACEÆ, a natural order of exogenous plants, containing upwards of 1000 known species, mostly herbaceous plants, a few half shrubby. The stems are tumid at the articulations; the leaves always opposite and entire, often uniting around the stem. The flowers are regular; the calyx persistent, of 4—5 sepals, either free or united into a tube; the corolla of 4—5 petals, which are frequently bifid, and generally terminate in a claw at the base, sometimes wanting; the stamens as many, or twice as many, as the petals; the ovary of 2—5 carpels; the stigmas sessile; the fruit is a one-celled capsule, with central placenta, to which the seeds are attached.—The plants of this order are mostly natives of temperate and cold countries; some of them are only found on tropical mountains, near the limits of perpetual snow. Most of them are inconspicuous weeds; some produce beautiful flowers; almost all are insipid and inert; a few contain *saponine*, and afford a substitute for soap. See SOAPWORT. To this order belong the Pink, Carnation, Sweet William, Lychnis, Chickweed, Cockle, Spurry, &c.

CARYOPSIS, in Botany, a fruit in which the seed and pericarp are so incorporated as to be inseparable, and even undistinguishable. The grain or fruit of grasses, as Wheat, Barley, Rye, Maize, &c., is a caryopsis.

CARYOTA, a genus of palms, natives of the East Indies, one of which, *C. urens*, remarkable for the acidity of its fruit, which produces a burning

sensation when its pulp is applied to the skin, is also highly valuable for the great quantity of juice (*toddy*) which flows from its wounded spathes, sometimes, in the hot season, to the amount of 100 pints in twenty-four hours from a single tree. Sugar (*jaggery*) is made from this juice by boiling it down, and on this account this palm is sometimes called the Jaggery palm. The pith of old trees, or farinaceous part of the trunk, is also much used for food, and is said to be equal to the best sago. The outer part of the stem is very hard, and applicable to many purposes. The fibres of the leaf-stalks are made into ropes, which are very strong and durable; the leaf-stalks, merely stripped of the leaflets, are used as fishing-rods, being light, tapering, and elastic; and the woolly substance found at their base is sometimes used for calking ships. This palm is found both in India and Ceylon, and abounds chiefly in mountainous districts. It rises to a height of 60 feet, with a trunk of a foot in diameter, and a magnificent spreading head of great double pinnate leaves, and triangular leaflets, the apex of the triangle being their point of attachment.

CASACALENDA, a town of Naples, in the province of Molise, 17 miles north-east of Campobasso, on the site of the ancient Calca. Fruits and wine of good quality are produced in the district, where silk-worms are also reared. Pop. 5900.

CASALÈ, a city of the Sardinian States, situated on the right bank of the Po, which is here crossed by an iron bridge, 38 miles east-north-east of Turin. It is a place of considerable antiquity, and occupies the site of a more ancient town. Many Roman remains are found, and coins of the early ages of the republic. It has a cathedral, dating from the 8th c., with valuable archives. The old citadel, founded in 1590, was one of the strongest in Italy, and within recent years the fortifications have been greatly strengthened and extended. During the Italian campaign of 1859, C. was occupied by divisions of the Sardinian army, and for a short time formed the head-quarters of the French emperor. It has manufactures of silk-twist, and a trade in the produce of the district, which is very fertile. Pop. 21,000. C. gives its name to a province which has an area of about 350 square miles, and a population (1857) of 136,965.

CASA'L-MAGGIORE, a town of Lombardy, Northern Italy, on the left bank of the Po, 22 miles east-south-east of Cremona. Being subject to frequent inundations from the river, strong embankments have been constructed for its protection. It has manufactures of earthenware, leather, glass, &c. Pop. 5000.

CASA'L-PUSTERLENGO, a town of Lombardy, North Italy, 12 miles south-east of Lodi, on the road to Cremona. It has manufactures of silk fabrics, linen, and earthenware, and an extensive trade in Parmesan cheese, which is here manufactured of the best quality. Pop. 5600.

CASAMA'SSIMA, a town of Naples, in the province of Bari, 14 miles south-east of the city of that name. It has a convent and two abbeys, and the vicinity produces wine and almonds. Pop. 5600.

CASANOVA, FRANCIS, a celebrated painter of battles and landscapes, was born in London, of Venetian parents, 1732. Educated in Italy, he afterwards went to Paris, from which he was driven by the severe criticism of Diderot. C. then took up his abode in Dresden, where he painted chiefly battle-pieces, and by one of his greatest works gained a place in the Academy. He afterwards went to Vienna, and painted for the Empress Catharine her victory over the Turks. He died at 645

Briel, near Vienna, 1805. The execution, and especially the colouring of his works, are excellent.

CASANOVA DE SEINGALT, GIOVANNI JACOPO, a notable adventurer of the Cagliostro species, was born, 1725, in Venice, and studied in Padua, afterwards in Venice, intending to enter the church. Having been expelled for sufficient reasons from a seminary of priests, he travelled to Naples, visited Rome, and after many adventures, arrived in Constantinople. On his return to Venice in 1745, he supported himself for a time by his skill as a violinist, until he gained some celebrity by curing a senator who had been attacked by apoplexy. His irregularities again drove him from Venice. He now wandered about for some time among the chief cities in the north of Italy, Milan, Mantua, Verona, Ferrara, Bologna, Parma, &c., but in 1750 he proceeded to Paris, where he was patronised by the nobility, and became acquainted with several eminent authors. It is needless to mention in detail his endless, inexplicable peregrinations. He visited almost every European capital, was somehow introduced to the best company, invariably excited the disgust or ill-will of those who knew him, and had always to 'vanish' after a brief period of enjoyment. In 1761, we find him distinctly professing the miraculous after the Cagliostro fashion: he having undertaken to regenerate old Madame D'Urfé, into a young man—for a consideration! He died in Bohemia in 1803. His celebrated memoirs, *Mémoires écrits par Lui-même* (12 vols., Leip. 1826—1838), contain many interesting notices of the manners of his times, intermixed with details of his personal adventures.

CASAREEP, or CASSIRIPE, a sauce or condiment made from the juice of the Bitter Cassava or Manioc root. It is in the highest esteem in Guiana, where it is employed to flavour almost every dish; and it is the basis of the favourite West Indian dish called *pepper-pot*. It is a powerful antiseptic, and meat can by means of it be kept for a long time quite fresh, even in a tropical climate. It is made by evaporating and concentrating the juice, which is also mixed with various aromatics. The poisonous principle of the juice is dissipated in the evaporation, so that although the juice in a fresh state is readily fatal to life, the C. is perfectly safe and wholesome. C. is imported into Britain, unimpaired in its qualities.

CASAU BON, ISAAC DE, a great scholar and critic, was born February 8, 1559, at Geneva, where, in 1582, he was appointed professor of the Greek language. Subsequently he held professorships at Montpellier, 1596, and at Paris, 1598, but the death of Henry IV. rendered his position (C. being a Protestant) very insecure, and he therefore gladly accepted the offer of Sir Henry Wotton to visit England. King James received him with distinction, and appointed him sometime after prebendary of Canterbury and Westminster. He died in London, July 1, 1614. His acute investigation and criticism were applied to several branches of archæology and theology. Among his chief works may be mentioned the able dissertation, *De Satirica Græcorum Pœsi et Romanorum Satira* (1605), the treatise *De Libertate Ecclesiastica* (1607), and the *Exercitationes contra Baronium* (1614), a confutation of Cardinal Baronius. His critical and exegetical works include editions of Diogenes Laertius, Aristotle, Theophrastus, Suetonius, Persius, Polybius, Theocritus, Strabo, Dionysius of Halicarnassus, and Athenæus.

His son, **MERIC CASAU BON**, was born at Geneva, 14th August 1599; educated first at Sedan, he accompanied his father to England, and entered Christ Church College, Oxford, where he took his

degree of M.A. in 1621. He was appointed rector of Ickham, near Canterbury, 1628, and afterwards professor of theology at Oxford. He died at Oxford, July 14, 1671. His attachment to Charles I. deprived him of all his preferments during the Commonwealth, but at the Restoration he received them again. Meric was, like his father, distinguished for his erudition; edited the works of Marcus Aurelius Antoninus, Terence, Epictetus, &c.; and wrote a treatise, *De Enthusiasmo* (Lond. 1655).

CAS'BIN, or KAZVIN, a town of Persia, in the province of Irak-Ajemi, 90 miles west-north-west of Teheran. It is situated on an extensive plain of the same name, and is enclosed by walls. Before the time of Shah Abbas the Great, C. was for a brief period the capital of Persia. The plain affords good pasturage, and in the vicinity of the town are extensive vineyards and orchards. The town is very extensive, but a great part of it is now in ruins, owing to its frequent subjection to earthquakes; and the population, which at one time was estimated at 200,000, is now probably not more than a fifth of that number. Some velvets, brocades, and coarse cotton cloth are manufactured; and C. has also a considerable trade in raw silk, rice, &c.

CASCARILLA (i. e., little bark, from Span. *cascara*, bark), the name given in South America to many different kinds of bitter medicinal barks which form articles of commerce. Peruvian bark itself bears no other name in the districts which produce it; and the name C. has recently been introduced in botany for a subdivision of the genus *Cinchona* (q. v.). By European physicians and apothecaries, the name C. Bark (*cortex cascarille*) is given to the bark of the *Croton Eleutheria* (see *CROTON*), a small tree, a native of the West Indies, where it is known as the *Sweet-wood* and the *Sea-side Balsam*. It is imported in considerable quantities into Europe from the Bahama Islands, and appears in commerce in small thin fragments and in quills. It is sometimes employed as a substitute for cinchona, although inferior in tonic and febrifuge qualities. It is a favourite medicine in Germany.—The barks of a number of other species of *Croton* appear to possess properties similar to those of C. Bark.

CASE, in Grammar. See **DECLENSION**.

CASE, in legal phraseology, though often used as synonymous with Cause, has, both in the law of England and Scotland, separate though not always very definite meanings. A formal written argument, prepared with a view to obtaining the opinion of a court of law, is called a case. By 15 and 16 Vict. c. 86, s. 61, the practice theretofore prevailing in the Court of Chancery of directing cases for a court of common law, is abolished. In Scotland, cases were formerly resorted to in almost every suit of intricacy and difficulty; but the abuse which arose from this practice has been remedied by 13 and 14 Vict. c. 36, s. 14. The statements which are laid before the House of Lords in appeals from Scotland, are cases in the sense now indicated.—**CASE STATED**, in English law, is an enumeration of facts and points in dispute, on which litigants have found it possible to agree, with a view to a prompt decision of a cause.

CASE, in Letter-press Printing, a receptacle for types, generally made 34 inches long, 15 inches broad, and 1½ inch deep, and divided into compartments or 'boxes,' each of which contains types of one class or letter. A pair of cases consists of an upper and a lower case: the upper one has 98 'boxes,' and contains the capitals, small capitals, and some other letters that are only occasionally required in composition; the lower one has 53

CASE-HARDENING—CASEMENT.

'boxes,' and holds the letters of the small character, figures, spaces, and most of the points. The places assigned to the several letters of the alphabet in the boxes of the case are not precisely the same in all printing-offices, but the differences are few. The accompanying illustration shews a prevalent arrangement. When in use, the cases lie on a frame four

Upper Case.

A	B	C	D	E	F	G	P	Q	R	S	T	V	W
H	I	K	L	M	N	O	X	Y	Z	J	U	Æ	Œ
A	B	C	D	E	F	G						§	†
H	I	K	L	M	N	O							†
P	Q	R	S	T	V	W						¶	*
X	Y	Z	J	U	Æ	Œ	Æ	Œ				!	!
ff	&	fl	ff	£	SP	—				:	¢	?	

'	k	g		1	2	3	4	5	6	7	8
z	b	c	d	e	i	s	f	w	9	0	
j							fi	ff	n	qf	mf
y	l	m	n	h	o	p		4M SP	5M SP	6M SP	7M SP
q	v	u	t	3 M SPACES	a	r		4M SP	5M SP	6M SP	7M SP
x								.	.	QUAD	!

Lower Case.

feet high, and the compositor stands in front of them. The different sizes of the boxes in the lower case depend upon the comparative frequency in which the several letters occur in composition, and the position in the case allotted to each letter is such as to afford the greatest facility in composing. The letter e, which is most run upon in the English language, has a box much larger than any of the other compartments, and is placed directly in front of the compositor. In the upper case, the boxes are of uniform size, and the letters are placed in alphabetical order, the comparatively rare occurrence of capitals rendering it immaterial which letter is nearest the compositor's hand. A case will hold a quantity of 'letter' more than sufficient to 'set up' two pages of this work, which is equal to 15,000 types.

CASE-HARDENING is the process of forming a coating of steel on the surface of keys, gun-locks, candle-snuffers, tools, &c. The articles are first finished, or nearly so, in common bar or fibrous iron, and being heated to redness, are sprinkled with a little powdered yellow prussiate of potash, and heated again. The result is, that the heat decomposes the prussiate of potash, and the liberated carbon combines with the iron, forming a coating of steel on the surface of the articles. Another mode of C. is to surround the articles with a layer of some animal matter, such as the powder obtained from charred hoofs, horns, bones, or skin, along with a little common salt, and heat them, enclosed in a shut iron case, to redness, retaining them at that temperature for half an hour; the articles are then taken out, and cooled in cold water, or in oil, when they are of a delicate nature. Large articles necessarily require to be heated for several hours. The coating of steel is very thin, seldom exceeding $\frac{1}{16}$ th of an inch. Where it is wanted to be thicker, the articles are treated several times. The steely covering makes the articles more durable, and also admits of a better polish; and the process is resorted to with that object in the case of the better-class of firearms, bright steel grates, &c. It is even applied to rails for railways.

CASEINE, or **CASEUM**, is an organic compound allied to albumen (q. v.), found in the milk of the mammalia, and in peas, beans, and other leguminous seeds, when it receives the name of **LEGUMIN**. The proportion of C. in milk (q. v.) varies, but averages about 3 per cent., and it may be coagulated and separated therefrom by the addition of a little rennet (q. v.), as in the manufacture of cheese (q. v.), or by the employment of a few drops of a mineral acid, such as dilute sulphuric acid. In either case, the C. separates as *curd*, which still retains attached to it some oil and earthy salts, though the greater portion of these substances, along with the sugar, remain in the watery liquid or *whey*. The elementary bodies which enter into the composition of C., and the proportion in which these are present in 100 parts are—carbon, 53.83; hydrogen, 7.15; nitrogen, 15.65; oxygen, 22.52; and sulphur, 0.85. The properties of C. are, that it is not coagulated by heat, as is well evidenced in the heating of milk, but is coagulated on the addition of rennet; sulphuric, hydrochloric, or nitric acids; alcohol, creasote, or infusion of galls, but not by acetic acid. It also forms insoluble precipitates with solutions of the poisonous salts, acetate of lead, nitrate of silver, and bichloride of mercury (corrosive sublimate), and hence the efficacy of taking large doses of milk in cases of poisoning by those deadly salts, as the C. in the milk, forming an insoluble compound with the poison, keeps it from exerting its deadly powers.

The form of C. obtained from plants, and termed **legumin**, is generally procured from leguminous seeds, like peas or beans, though it can also be extracted from the majority of vegetable substances, especially from sweet and bitter almonds, and even from tea and coffee. Dried peas contain a fourth of their weight of legumin, and this can be extracted by bruising the peas to powder, and digesting in warm water for two or three hours. The liquid is then strained through cloth, which retains the insoluble matters, and allows the water with the legumin dissolved therein, and with starch mechanically suspended, to pass through. On settling, the starch falls to the bottom of the vessel, and the clear liquid holding the legumin in solution, on the addition of a small amount of acetic acid, yields a precipitate of legumin or vegetable caseine. So perfectly does the vegetable C. resemble the C. from milk, that the one can hardly be distinguished from the other by chemical tests or by taste; and at the present time there is regularly prepared in various parts of China, especially near Canton, a form of cheese from peas, which is sold to the populace in the streets of Canton under the name of *Taofoo*. C. is a most important article of food. See **NUTRITION**.

CASEMATE, originally a loopholed gallery excavated in a bastion, from which the garrison could do execution upon an enemy who had obtained possession of the ditch, without risk of loss to themselves. Hence the designation, from Span. *casa*, house, and *mator*, to kill. As defence from shells became more important, the term was subsequently applied to a bomb-proof vault in a fortress, for the security of the defenders, without direct reference to the annoyance of the enemy. A *casemated* battery consists of such a vault or vaults, with openings for the guns. A C. may also serve for barracks, or for an hospital, or for a store-house. The great want of ventilation in casemates renders them bad places for barracks; and the artillerymen are nearly stifled with smoke when firing from such confined places.

CASEMENT (It. *casamento*, a large house), a frame with hinges to open and shut, enclosing part

of the glazing of a window. Windows of this description are rare in this country, but are almost universal on the continent. Also a name for a deep, hollow, circular moulding, similar to the *scotia* of classical and the *cavetto* of Italian architecture. The C. is very prevalent in the perpendicular style of Gothic architecture, and is sometimes enriched with running foliage.

CASERNE is a barrack or building for the accommodation of the soldiers forming the garrison of a fortified town or post.

CASERTA, a town of Naples, in the province of Terra di Lavoro, is situated on a plain about 17 miles north-east of Naples. It is chiefly remarkable on account of its magnificent palace, one of the finest in Europe, and the frequent residence of the Neapolitan court. During 1860, C. acquired celebrity as the head-quarters of Garibaldi and his army. A royal silk manufactory has been established in the neighbourhood. Population, with adjoining hamlets, about 20,000.

CASE-SHOT, or CANISTER-SHOT, is an assemblage of bullets or small balls, enclosed in a cylindrical case or canister. The diameter of this canister is a little less than the bore of the gun from which it is to be discharged. According to the size of the canister, the balls vary from 1 lb. to $\frac{1}{4}$ oz. each, from 30 to 280 in number, and from $3\frac{1}{2}$ lbs. to 85 lbs. in total weight. The canister bursts immediately on leaving the gun, and the balls spread out into an irregular sort of cone. Within a range of 500 yards, they work great execution among troops; they are generally used at 200 or 300 yards.

In a more modern and effective kind, called *spherical case*, the bullets are enclosed, along with a charge of powder, in an iron shell, instead of a tin canister. It is often called *shrapnel shell*, from the name of its inventor. A spherical case-shot for a 68-lb. carronade, or for an 8-inch howitzer, contains 337 balls; for a 24-pounder gun, 128; and for an 18-pounder, 90. It is exploded by a fuse, the length of which depends on the distance of the point where the destructive effect is to be wrought. Its effect is something like that of a prolonged musket-fire. The shrapnel shell is not of much use against the hull of a ship; but is very destructive against masses of men on shore, or on the decks of a ship, with a greater range than that of ordinary canister. Artillerymen prefer just such an amount of charge as will burst the sphere, without scattering the balls very widely.

CASH (Fr. *caisse*, a chest for containing money) is sometimes used as synonymous with money, as distinguished from produce, in which sense it includes all immediately negotiable paper—bills, drafts, and bonds, as well as coin and bank-notes. At other times, it is used, in a limited sense, to denote coin and bank-notes, as distinguished from negotiable instruments which pass by indorsation.

CASH ACCOUNT, or CASH CREDIT, a form of account with a bank, by which a person is entitled to draw out sums as required by way of loan to a stipulated amount. The practice began about 1729 in Scotland, with the banks of which country it is still peculiarly identified; but it is not unknown elsewhere, though on a somewhat different plan. In connection with the Scotch banks, the C. A. system is placed on a distinct and secure basis, which we shall briefly describe. The persons procuring a credit of this kind are for the most part retail-dealers, tradesmen, and farmers, who possess a limited capital, and need occasional loans. Instead of borrowing money by bills or mortgages, they apply to a bank for a C. A. to the extent, it may be, of £500. In the origin of the system, the bank

may be said to have been influenced by three considerations—first, the necessity for making advantageous use of its capital; second, the desire to extend its issues of small notes; and third, the nature of the security offered. Since Sir Robert Peel's act restricting circulation of notes, the second of these reasons no longer operates; for the banks are now much above their authorised issue, and must hold an equal amount of coin against the surplus. What the bank particularly wants, is a customer who will be constantly depositing sums in notes of other banks, and drawing out sums in its own notes. The C. A. system aids this process. It secures a customer who will be frequently operating on his account, according to the exigencies of his business, and whose overdrafts, as well as deposits, tend to benefit the concern. Obviously, for the Debtor, the system works more advantageously than when a fixed sum is borrowed, for in that case interest would run on for the whole amount, whereas by a C. A. the trader merely draws what he requires; and by paying in his surplus money in small sums, he is charged with interest only on the sum actually at his debit from day to day. In negotiating a C. A., a bond is prepared by the bank stating the amount and the nature of the security, the cost of which is borne by the borrower. Banks often, in security, accept heritable property and policies of life insurance, but more commonly two persons in good credit become cautioners, or co-obligants along with the principal. Unless the liability of the cautioners respectively be expressly limited in the bond, each is liable for the whole amount. If the bank liberates one cautioner without the consent of the other, it loses its recourse. This recourse is not lost by accepting a dividend from the sequestrated (bankrupt) estate of a principal or cautioner; but it will be lost by accepting a composition from either of these persons without consent of the other. The bank can at any time stop the credit, and call for payment of the balance due. A cautioner can at any time withdraw his name from the credit, on paying up the balance, and the bank is bound to assign the debt to him. While cash accounts may be of great service to traders who act upon them discreetly, it is found that, in too many instances, these accounts are used as a dead-loan to the entire amount stipulated for; and for this, as well as a reason above assigned, banks care now very much less for this kind of business than formerly. Properly, traders are to look on the money procured on cash credits not as an addition to capital, but merely a temporary substitute for current business purposes while the capital is out with customers, and to be replaced accordingly until again required. It may be added, that the progress of commercial wealth in Scotland, now greatly lessens the necessity for having recourse to the C. A. system.

CASHEL, a town of Ireland, in Tipperary county, and 105 miles south-west of Dublin by rail. It is irregularly built on the south and east slopes of an isolated height, rising abruptly from a rich and extensive plain. Pop. 1841, 7036; 1851, 4798. C. is a bishop's see, and returns one member to parliament. The ancient kings of Munster resided here. The top of the height, or 'Rock of Cashel,' is occupied by an assemblage of the most interesting ruins in Ireland, which have a grand effect from the country around. The ruins consist of a cathedral, the largest and most remarkable in the country, founded 1169, burned 1495, and afterwards repaired; a stone-roofed chapel, built 1127 by Cormac MacCarthy, king of Munster, and the most perfect specimen of the kind in the country; Hore Abbey, founded 1260; the palace of the Munster kings;

CASHEW NUT—CASHMERE.

and a round tower, 90 feet high and 56 in circumference. The round tower is built of freestone, but the other ruins of limestone. At C., in 1172, the great synod was held in which the Irish prelates first acknowledged the authority of the English king and church.

CASHEW NUT (*Anacardium occidentale*), a tree of the natural order *Anacardiaceae*, a native probably of the tropical parts of both hemispheres, although it has been commonly regarded as of American origin. It is a spreading tree of no great height. It abounds in a clammy, milky juice, which turns black on exposure to the air, and is used in India for varnishing, but is so acrid as to produce painful inflammation when it comes in contact with the skin of some persons, or when they are exposed to its fumes. Others are comparatively unsusceptible of its influence. The fruit of this tree is a kidney-shaped nut, about an inch long, seated on the thicker end of a pear-shaped fleshy stalk, from which the botanical character of the genus is derived. The

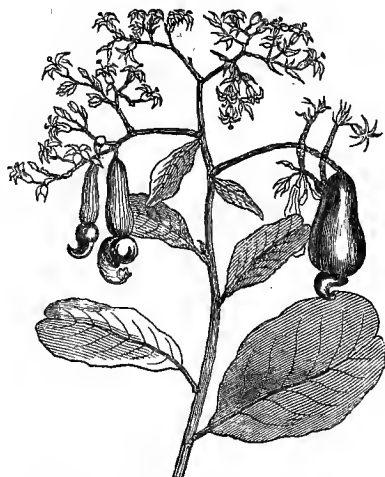

Cashew Nut (*Anacardium occidentale*).

shell is double, the outer shell being ash-coloured, and very smooth; and between it and the inner is a layer of very caustic black juice. The kernel is oily, and very pleasant and wholesome, and is in common use as an article of food in tropical countries, being made into puddings, roasted, and in various ways prepared for the table. In the West Indies, it is put into wine, particularly old Madeira wine, to which it is thought to communicate a peculiarly agreeable flavour, and for this use it is sometimes imported into Britain. It is also for the same reason sometimes an ingredient in chocolate. Yet the vapour which arises from it in roasting, but which is derived from the coating of the kernel, and not from the kernel itself, is so acrid as to cause erysipelas and other painful affections of the face in those who conduct the process, unless great caution is used.—The fleshy stalk, sometimes called the *Cashew Apple*, varies in size, being sometimes not much larger than a cherry, and sometimes as large as an orange, and is white, yellow, or red. It is perfectly free of the acidity characteristic of the natural order, is acid and eatable, very pleasant and refreshing, and much used by the inhabitants of the countries in which the tree grows. A very pleasant vinous liquor is obtained from it by fermentation; and this by distillation yields a spirituous liquor, highly

esteemed for its flavour. A gum which exudes from the bark of the tree, quite distinct from the milky juice already mentioned, is bland, and very similar to gum-arabic.

CASHGAR, or KASHGAR, a city of Chinese Turkestan, 140 miles north-west of Yarkand, in lat. 39° 25' N., long. 73° 57' E. It is surrounded by an earthen rampart, pierced with four gates, and being the most westerly place of importance in the Chinese empire, it is strongly garrisoned. It is the residence of an Uzbek chief, and has manufactures of cotton, gold and silver cloths, carpets, &c.; and an extensive trade with Central Asia. Population variously estimated at from 16,000 to 80,000. C. is said to have been an important commercial town before the Christian era, and was at one time the capital of Turkestan. It has been about a century in the possession of the Chinese.

CASHIERING is a punishment for officers in the army and navy. It is a severe form of dismissal from the sovereign's service, and implies that the officer, by some disgraceful conduct, has deserved not only dismissal, but disqualification for ever again entering the service. Sometimes there are words added, implying still deeper ignominy and degradation. On some rare occasions, when a court-martial has awarded C., the commander-in-chief has mitigated the punishment to simple dismissal. 'Scandalous and infamous conduct,' and 'Conduct unbecoming the character of an officer and a gentleman,' mark two degrees of offence which may lead, the one to C., the other to dismissal.

CASHMERE, a valley of the Himalaya, between India Proper and Middle Tibet, stretching between lat. 33° 15' and 34° 35' N., and long. 74° 10' and 75° 40' E. Its bottom, a comparative level of about 2000 square miles, is about 5500 feet above the sea; while the enclosure, as a whole, from ridge to ridge, besides fully doubling the area, attains, at some points, nearly thrice the altitude. The mountain-wall of this secluded region presents but few passes, and most of these too lofty to be practicable in winter. In fact, the Baramula itself does not admit a wheeled vehicle. Through this single opening, situated at the south-west, the Jhelum carries down towards the Punjab the gathered streams and lakes of the entire basin, and is navigable for the last 70 miles of its course. This net-work of waters, without swelling into inundations, affords everywhere a perennial supply for the purpose of irrigation. Besides the copious rains of spring, the snows of winter covering even the plains to a depth of two feet for four months, accumulate, in every gorge and on every declivity, reservoir above reservoir, against the demands of summer. C. is traditionally believed to have been a vast upland lake, and alluvial deposits beyond the reach of existing influences would seem to confirm the idea.

In regard to climate, moderate but steady frost prevails from November to March; and again, the heat, ranging from 75° F. in June, to 85° in August, is often disproportionately oppressive, through the stagnation of the landlocked atmosphere. The staple production is rice, which, from the singular facilities of irrigation, is an all but sure crop, yielding, even in a tolerable season, 30 or 40 returns; and in the abundance and excellence of its fruits, C. is said to surpass all the rest of the world. The valley is, in general, considered to be remarkably healthy. The inhabitants, almost universally held to be models of strength and beauty, amounted, before 1828, to 800,000, or to 400 in a square mile. But by casual famine and pestilence they have since been reduced to 200,000. The people are mostly Mohammedans, divided between the Sunnite and

Shiite sects. The manufactures—all superior of their kind—are shawls, leather, firearms, and attar of roses. The principal towns are Serinagur, Islamabad, Shupayon, Pampur, and Baramula. The history goes back, through colossal monuments chiefly of marble, beyond the dawn of authentic annals. In 1315, C. first received Mohammedanism; in 1586, it was annexed to the Mogul empire; in 1752, it fell under the power of the Afghans; and in 1819, it was subjugated by the Sikhs. Lastly, being ceded, at the close of the first war of the Punjab, to the British, it was by them transferred to Gholab Sing, as the nucleus of a state of its own name, which comprised also Jammu, Bulti, Ladakh, Chamba, &c. This new principality, with 25,000 square miles, and 750,000 inhabitants, is said to have a force of about 24,000 men of all arms.

CASHMERE GOAT, a variety of the common goat, remarkable for its very long, fine, and silky hair, from which the highly valued Cashmere shawls are made. It is not so much in Cashmere that this variety of goat is to be found, as in Tibet, from which the finest goat-hair is imported into Cashmere, to be there manufactured into shawls. The hair is even longer than that of the Angora goat, and not, like it, curled into ringlets, but straight. It is about eighteen inches long. A single goat



Cashmere Goat.

does not yield more than three ounces, and the fleeces of ten goats are requisite for the manufacture of a shawl a yard and a half square. The hair is spun by women, and dyed after it is spun. It is said that 16,000 looms are kept in constant employment in Cashmere, producing annually about 30,000 shawls. The shawls are woven in rudely constructed looms, a pair of shawls sometimes occupying three or four men a whole year in weaving. C. shawls, of the finest quality, are sold in London at from £100 to £400 each. Plain shawls are simply woven in the loom, but those with variegated patterns are worked with wooden needles, a separate needle being used for each colour. These shawls are in the highest request in India; but the hair of several other breeds of goat inferior to that of Tibet is employed for the manufacture of shawls called by the same name. Imitations of these are manufactured in France rather extensively, some from the Tibet wool entirely, and others of a mixture of this with silk and cotton. Twenty-four pounds of the best Tibetan goat-hair is said to sell in Cashmere for 20 rupees, or £10 sterling.

Attempts have been made to introduce the C. G. into Europe. Baron Alströmer attempted, in the end of last century, to naturalise it in Sweden; and a very spirited attempt to introduce it into Britain has recently been made by Mr

Towers. A mixed race, produced by crossing the C. G. and the Angora goat, has been found to possess most valuable qualities, the hair being long, fine, and more abundant than in any of the parent breeds.—The male of the C. G. has very large, flattened, wavy horns.

CASIMIR, properly Kazimierz, was the name of many Polish princes and kings. With the establishment of the power of Casimir I. in 1040, the predominance of Christianity was decided in Poland. But the most distinguished of this name was Casimir III., called Casimir the Great, who succeeded his father, Vladislaus Loketek, as king of Poland in 1333. He added Little Russia and Red Russia to his dominions; repelled the Tatars, who then threatened Poland; and waged successful war in Silesia, which he conquered but did not retain. He shewed great anxiety for the advancement of the arts and of learning in his kingdom, and for the improvement of the condition of the most oppressed classes, which won him the title of King of the Peasants. A Jewish mistress obtained from him liberties for the Jews, which they have since retained in Poland. He died in consequence of the falling of his horse in 1370.

CASINO, an Italian diminutive of *casa*, a house, signifies a place for social reunions. The Italian nobles have long had casinos detached from the palaces in which they live, whither they can retreat and enjoy themselves, and it is probable that the *public casinos* were the result of an attempt made by the middle classes to imitate their superiors. In Italy, a C. is generally close by a theatre, and is a place where musical or dancing soirées are held, containing a conversation-room, billiard-room, and rooms for other kinds of amusement, as well as small apartments where refreshments may be had. Casinos are numerous in Italy and Germany, and have been introduced into England. In general, they are not supposed to exert an edifying influence on the community.

CASINO, or **MONTE-CASINO**, a mountain overhanging the town of San-Germano (the ancient Casinum), in the Neapolitan province of Terra di Lavoro, between 50 and 60 miles north-north-west of Naples, is celebrated on account of the monastery founded here by St Benedict (q. v.) in 529 A. D. This monastery is remarkable for its noble architecture, its ancient wealth, its library and archives, and in modern times for the learning of its monks, who have a printing-press, from which several important works have issued. The beautiful situation of the abbey, and the reputation of the monks as masters of the healing art, formerly made Monte-Casino a favourite resort of pilgrims. Luigi Tosti, the librarian of the abbey, has given an account of its literary treasures in his *Storia della Badia di Monte-Casino* (3 vols., Nap. 1841—1843).

CASOLI, a town of Naples, in the province of Abruzzo Citra, situated on a hill 17 miles south of Chieti. It has two normal schools. Population between 5000 and 6000.

CASO'RIA, a town of Naples, 5 miles north-north-east from the capital. Silk is produced in the district. Pop. 8000.

CAS'PÉ, a town of Spain, in the province of Saragossa, 57 miles south-south-east of the city of that name. It is situated near the Ebro, has manufactures of oil and soap, and a trade in the agricultural produce of the district. Pop. 7500.

CASPIAN SEA, an inland sea or great salt-lake, the largest in the world, on the boundary between Europe and Asia, extending from lat. 36° 40' to 47° 20' N., and long. 46° 50' to 55° 10' E. Its length from north to south is about 700 miles, and its average

breadth about 200 miles. Its total area is estimated at 140,000 square miles. The coast-line is irregular, and on the east side especially there are several bays and indentations of coast, the principal being those of Mertvoi, Mangushlak, Kenderlinsk, Karabugos, and Balkan. From the west, the naphtha-impregnated peninsula of Apheron stretches into the C. opposite the Balkan Gulf; Mount Caucasus also rises on its west side. On the south rises the lofty range of the Elburz Mountains, between which, however, and the coast, on this side almost unbroken, extends a low flat plain of from 15 to 20 miles in breadth. On the north, it is bordered by great steppes, and the country eastward is a vast plain. It is probable that at one time its waters, which are said to be still diminishing, covered great part of the adjacent steppes. Some singular changes appear to take place in the level of the Caspian. Various measurements have made its depth and elevation different. One Russian measurement made it 348 feet below the level of the Black Sea, another only 84 feet. The latest estimate makes it only 38½ feet below the Black Sea. It has no tides, but its navigation is dangerous because of violent storms, especially from the south-east, by which its waters are sometimes driven for many miles over the adjacent plains. The depth near the southern end is about 600 feet, and in some places near the centre it attains a depth of nearly 3000 feet; but near the coast it is very shallow, seldom reaching a depth of more than 3 feet at 100 yards from the shore, and in many places a depth of 12 feet is not reached within several miles of the beach. On the north-east and east it is especially shallow. It receives the waters of a number of large rivers, of which the greatest is the Volga. The Ural, the Tereh, and the Kur also fall into it. The water of the C. S. is salt, but much less so than that of the ocean. Its northern parts are covered with ice during winter. It abounds in fish, and very valuable fisheries are carried on, especially for sturgeon and salmon. By a canal uniting the headwaters of the Volga with the rivers Tvertza and Schlina, the C. is united with the Baltic Sea. It belongs in part to Russia, in part to Persia, and in part to the Turkomans. The Russians have some vessels of war upon it, and the most of its commerce is in their hands. Steam-packets have been established on it. The chief Russian town upon its shores is Astrakhan, at the mouth of the Volga. Derbend, Guriev, Baku, and Krasnoi-yar are also Russian towns upon the Caspian Sea. Balfrush, Reshd, and Astrabad are Persian towns. The Turkomans have only a few fishing-villages on the eastern shore.

The C. S. was known to the Greeks and Romans. According to Strabo, it derived its name from the Caspii, a tribe inhabiting its western shores. The name Caspian was afterwards limited to the western portion of the lake—the eastern being designated the Hyrcanian Sea.

CASQUE. See HELMET.

CASS, LEWIS, an American statesman, born at Exeter, New Hampshire, in 1782. He was educated for the law, but quitting that profession, he entered the army in 1812, and rose rapidly to the rank of general, though his merit was not very conspicuous. In 1813, he was elected governor of Michigan, in which state he settled. During his governorship, he kept himself apart from party politics, yet all his measures had a decidedly democratic tendency. In 1831, C. was made minister at war under General Jackson, and in 1836 he was sent as plenipotentiary to Paris. In

this capacity he made himself popular by his replies, in *Galignani's Messenger*, to the attacks of the English press on the claims of the Union with regard to its north-east boundaries, and by his protest against the measures of Guizot; but the treaty concluded by Daniel Webster with Lord Ashburton was so much opposed to the views maintained by C., that he resigned his post, and in 1843 returned to America, where he was received with marks of popular favour. He now aimed at the presidency, and in 1844 was put in nomination; but was defeated, as he was also in 1848, when he made another effort to obtain the supreme power. In 1857 he was appointed secretary of state. Though active and energetic, he has no claim whatever to anything like comprehensive statesmanship. In regard to slavery, his conduct has been ludicrously inconsistent, determined solely, as it would seem, by a view to what would be popular with those whose favour he was seeking to secure at the moment. Latterly, he has gone wholly along with the slave-holding party, advocating an extension of territory with a view to extend the ramifications of slavery. But he is chiefly remarkable on account of his bitter hostility to Britain, against which he is ever ready to inflame the minds of his countrymen on the slightest and silliest pretext. He is author of the *History, Tradition, Languages, &c., of Indians in the United States*; of *France: its King, Court, and Government*; and other works.

CASSANDER, king of Macedonia, and son of Antipater, was born about 354 B.C. When young, he is said to have been ill used by Alexander the Great, and to have consequently conceived a mortal hatred to that monarch's family. On the death of his father, he expected to succeed to the regency; but Polysperchon received the honour instead, which so dissatisfied him, that he resolved to contest the sovereignty with his opponent. He was completely successful; but while pursuing his career of conquest in the south of Greece, he learned that Olympias, mother of Alexander, was committing havoc in the north, and consequently hurried back to Macedonia. In less than a year, Olympias was taken prisoner, and put to death. Only Roxana, wife of Alexander, and her son Ægus, now stood between him and the throne of Macedon; but he did not find it convenient to 'make away' with these two until several years had passed. Meanwhile, he married Thessalonica, half-sister to Alexander, in whose honour he founded, about 316 B.C., the town which bears her name. In the following year he caused Thebes, which Alexander had destroyed, to be rebuilt. He next became involved in a war with Antigonos, king of Asia, which, with an intervening peace of one year, lasted from 315 to 301 B.C., in the last of which years Antigonos was defeated and slain at the battle of Ipsus. Along with his auxiliaries Seleucus, Ptolemy, and Lysimachus, he seized and shared the dominions of the vanquished. The rest of his life was spent in intrigue and military enterprise. He died 297 or 296 B.C.

CASSANDRA, according to Homeric legend, was the fairest daughter of Priam and Hecuba, and the twin-sister of Helenus. The children playing in the court of the temple of the Thymbrean Apollo, not far from Ilium, till it was too late for them to return home, a bed of laurel-twigs was made for them in the temple; and there, in the morning, two snakes were found hicking their ears, from which resulted such an acuteness of hearing, that they could hear the voice of the gods. C. afterwards attracted the love of Apollo by her

beauty, and he taught her the secrets of prophecy; but displeased by her rejection of his suit, laid upon her the curse that her vaticinations should never be believed. Accordingly, she prophesied in vain of the treachery of the Grecian horse and the destruction of Troy. On the capture of the city, she fled to the temple of Minerva, but was torn from the altar by the Locrian Ajax, and ravished in the temple. She afterwards, in the distribution of the prey, fell to the share of Agamemnon, to whom she bore twin sons, but was murdered by Clytemnestra.

CASSANDRA, a peninsula in the province of Roumelia, European Turkey, situated between the Gulfs of Salonica and Cassandra, in lat. 40° N., long. 23° 30' E. The ancient name of this headland was *Pallene*. Grain of superior quality is raised here; wool, honey, and wax are produced; and silk-worms are extensively reared. The Gulf of Cassandra (ancient *Toronaius Sinus*) has a length of 33 miles from south-east to north-west, and a breadth of 10 miles.

CASSANO, a town of Naples, in the province of Calabria Citra, 34 miles north of Cosenza. It is situated in a valley in the midst of the most beautiful scenery, has a cathedral, an old castle built on an imposing mass of rock in the midst of the city, and manufactures of linen, leather, silk, cotton, and macaroni. Pop. 6000.

CASSANO, a town of Northern Italy, 17 miles east-north-east of Milan. It is situated on the right bank of the Adda, here crossed by a bridge on the railway to Brescia, and has extensive silk-mills. C. was the scene of two sanguinary battles—one in 1705 between the French under the Duke de Vendôme, and the Imperialists under Prince Eugene, in which the latter were defeated; the other in 1799, when the Russians and Austrians under Suwarow defeated the French under Moreau. Pop. 1200.

CASSATION, COURT OF. In the law of France, the act of annulling the decision of a court or judicial tribunal is called *cassation*, from the verb *casser*, to break or annul (Lat. *quater*; Eng. *quash*); and the function of cassation, as regards the judgments of all the other courts, is assigned to a special tribunal called the Court of C., which may thus be regarded, in a certain sense, as the last and highest court of appeal for the whole country. But as everything is excluded beyond the question whether or not the view taken of the law, and of the proper method of administering it by the inferior tribunal, has been the right one, the idea attached to this institution is less that of a court in the ordinary sense, than of a department of government to which the duty of inspecting the administration of justice is assigned. By the 65th article of the constitution of the year VIII., it was enacted that there shall be for the whole of France a tribunal of cassation, which shall pronounce on demands for cassation against judgments in the last resort pronounced by the tribunals; and the following article of the same constitution bears that this supreme tribunal shall pronounce no judgment on the foundation or merits of the cause, but that, in case of its breaking the judgment pronounced, it shall remit to the tribunal appealed from to pronounce another. The title of tribunal was afterwards changed for that of court, by a *senatus consultum* of the year XII.; but substantially the institution has retained its original character, notwithstanding all the changes of government which have occurred in France. The demand for cassation can be made only by the parties to the suit, or by the *procureur-général* of

the Court of C. for the public interest. Criminal as well as civil judgment may be reviewed by the Court of C., the only exceptions being the judgments of justices of the peace and of courts-martial, military and naval. The delay allowed for bringing a civil case before the Court of C. is three months for persons domiciled in France, six months for those in Corsica, a year for American colonists, and two for all persons resident beyond the Cape of Good Hope. In criminal matters, the procedure is greatly more prompt, three full days only being allowed to the person condemned to bring his action of C., and the same space being given to the *procureur-général*. In all criminal and police cases, the Court of C. may pronounce judgment immediately after the expiry of these days, and must do so within a month. The Court of C. is divided into three sections, one of which is devoted to criminal matters. Its staff consists of a president, who has the title of *first* president, and three vice-presidents, who are called presidents; 45 counsellors or ordinary judges; a *procureur-général*, or public prosecutor; 6 substitutes, who have the title of advocates-general; and several inferior officers. The presidents and counsellors are named by the sovereign for life, the other officers being removable at pleasure. No judgment can be pronounced unless 11 judges are present, the decision being determined by the majority. Where the numbers are equally divided, 5 judges are called in; and cases of peculiar difficulty may be judged of by the three sections united. The whole court, when presided over by the minister of justice, possesses also the right of discipline and censure over all judges for grave offences, not specially provided for by the law. When thus constituted, the Court of C. may suspend the judges of the imperial courts from the exercise of their functions, and call them to its bar. The *procureur-général* of the Court of C. likewise possesses a surveillance over the *procureurs-généraux* of the imperial courts.

The members of this august tribunal wear a red gown with a violet *toque*, or cap of velvet; the robes of the presidents and of the *procureur-général* being doubled with white fur.

CASSAVA, a West Indian name of the plant also called MANIOC (q. v.), and of the starch produced from it, which is otherwise called Brazilian arrow-root, and is popularly known in Britain as TAPIOCA (q. v.).

CASSAY, or MUNEEPOO'R, a mountainous country in Farther India, to the south-east of Upper Assam, stretching from 23° 49' to 25° 41' N. lat., and from 93° 5' to 94° 32' E. long., and containing, with an area of 7584 square miles, a population variously estimated at 30,000 and upwards. It is important to England merely from its being on the Burmese frontier. Accordingly, before the war of 1825 began, it was occupied by the British; and, being permanently ceded at the close of the contest, it was handed over, free from tribute, to the native rajah. The inhabitants are more generally Brahmanists than Buddhists. The productions are tea, rice, tobacco, indigo, cotton, sugar, opium, and mustard; and the manufactures are muslins, silks, and a few iron wares. The chief town is Muneepoor, which sometimes gives name to the principality.

CASSEL, the capital of the electorate of Hesse, pleasantly situated on both sides of the Fulda, here a navigable river, 120 miles by rail, north-north-east of Frankfurt on the Main. It contains about 32,000 inhabitants, besides about 4000 soldiers, and 2500 servants and labourers connected with the military. The oldest part of the town consists of a few very narrow, crooked streets, close on the banks of the Fulda; the more modern parts are

on hills, which rise gently from the river. C. is partially walled. In Friedrichs-Platz, the largest square in any German town, stands the Elector's palace, a comparatively mean structure: a little below is the first story of a magnificent palace commenced in 1820, and stopped in the following year by the death of the Elector who projected it. Amongst the other public buildings and institutions, one of the most important is the *Museum Fredericianum*, which has a library of 90,000 volumes and some valuable MSS. The Picture-gallery contains about 1400 paintings, including some excellent specimens of the best masters. In the cabinet of curiosities, there are examples shewing the gradual development and improvement of watchmaking from the earliest invention at Nuremberg to the present time. C. contains an observatory, and is the seat of a number of learned and scientific associations. From 1807 to 1813 it was the capital of the kingdom of Westphalia. It has been the scene of serious disturbances and revolutionary movements in recent periods of continental agitation. The gardens of Wilhelmshöhe, called the German Versailles, with their splendid fountains and cascades, and the colossal statue of Hercules, within the hollow of whose club eight persons can stand at one time, are only three miles from Cassel. There are manufactures of cotton, woollen, and silk fabrics, lace, and carpets. Under the name of *Chassala*, the town appears to have existed as early as the 10th century.

CASSEL, a town of France, in the department of the Nord, 27 miles north-west of Lille. It is pleasantly situated on a hill, overlooking a country on all sides so flat, that the view, although the elevation is only 800 feet, is said to be one of the widest in Europe, extending over the broad fertile plains of Flanders, and to the chalk cliffs of England, and taking in 32 towns and 100 villages. During the great trigonometrical survey undertaken in the reign of the first Napoleon, Mont Cassel was one of the chief signal-stations. C. has manufactures of lace, linen, thread, hosiery, &c. Pop. 2700. It was known to the Romans, who had a station here, as *Castellum*.

CASSIA, a name given by the ancients to a kind of medicinal bark, but their descriptions are so imperfect that it is impossible to determine what bark it is. The name is employed in the English translation of the Old Testament in Exodus xxx. 24, and in Psa. xlv. 8, its use in these places being derived from the Septuagint; and it is not improbably supposed that the substance intended is the same now known in our shops as *Cassia Bark*, or *Cassia lignea*.—2. *Cassia* is now the botanical name of a genus of plants of the natural order *Leguminosae*, sub-order *Cesalpineeae*, containing many species—more than two hundred having been described—trees, shrubs, and herbaceous plants, natives of Africa and of the warm parts of Asia and America. They have abruptly pinnate leaves, and flowers with deciduous calyx of five somewhat unequal sepals, corolla of five petals, of which the lower ones are the larger, ten free stamens, of which three are long, four short, and three abortive, and anthers opening by two holes at the top. The leaves and pods of many species have a peculiar sweetish but nauseous smell, and a nauseous bitter taste accompanied with a loathsome sliminess. They seem all to contain the purgative principle called Cathartine (q. v.), and the leaves of some of the Asiatic and African species are highly valued, and much used as a medicine, under the name of SENNA (q. v.). The leaves of *C. Marylandica* possess similar properties, and are now used to some extent in the United States of

America.—*C. Fistula* (*Cathartocarpus*) yields the C. of the pharmacopoeias, the *C. pods*, *Pipe C.*, or *Purging C.* of the shops. It is a large tree, a native of Egypt and other parts of Africa, perhaps also of the East Indies, in which, at all events, it is now widely diffused and cultivated, as well as in the West Indies and warm parts of America. Its leaves have 4—6 pair of ovate smooth leaflets, its flowers are yellow and in loose racemes; its pods, which have obtained for it the name of *Pudding-pipe Tree*, are sometimes two feet in length, cylindrical, black, consisting of thin brittle woody valves, within which is a cavity divided by numerous thin transverse partitions, each cell containing a single seed imbedded in a soft black pulp. It is this pulp that is the part used in medicine; it has a sweetish mucilaginous taste, and in small doses is a mild laxative. It is sometimes removed from the pods when fresh; or an extract is obtained, after they are dried, by boiling and evaporating. It is said to contain 61—69 per cent. of sugar. The C. pods of the West Indies contain much more pulp, and are therefore more valuable than those imported from the East.—3. *C. Bark*, or *C. lignea*, sometimes called *China Cinnamon*, is a bark very similar to cinnamon both in appearance and properties; but in thicker pieces, and less closely quilled, of a less sweet and delicate flavour, but more pungent. It is the produce of the *Cinnamomum Cassia* or *aromaticum*, a tree of the same genus with the Cinnamon-tree, a native of China, and extensively cultivated there. It is highly esteemed by the Chinese, and is now largely imported into Europe. As it contains a greater proportion of essential oil, and is also much cheaper than true cinnamon, it is much more generally used. The oil which it contains is called *Oil of Cassia*, and is very similar to Oil of Cinnamon. Coarse cinnamon is sometimes sold as cassia. *C. Buds* are believed to be the dried flower-buds of the same tree which yields *C. bark*. They are now imported into Britain in large quantities, and are much used in confectionery. In flavour and other qualities, they resemble *C. bark*; in appearance, they are very similar to cloves.

CASSIANUS, JOANNES, or JOANNES MASSILIENSIS, or JOANNES EREMITA, a Christian teacher of the ancient church, who flourished in the early part of the 5th c., and distinguished himself as the promoter of monachism in Southern Gaul, and as the opponent of the extreme dogmas of St Augustine respecting grace and free-will. Shortly before 415 A. D., he went to Massilia (Marseille), where he founded two monasteries according to the rules laid down in his *De Institutibus Cenobiorum*. One of these monasteries was for nuns; the other was the famous Abbey of St Victor, which under C. is said to have possessed not less than 5000 inmates, and which served as a model to a multitude of monastic institutions in Gaul and Spain. His *Collationes Patrum Sceticorum* is a work in 24 chapters, each of which gives a 'spiritual colloquy between monks in the desert of Sketis,' regarding the monastic life, and the vexed questions of theology. C.'s Grecian erudition, his dislike of dogmatic subtleties, and his zeal for monastic habits, led him to oppose the doctrine of St Augustine on works and grace, and to set up a doctrine which was known by the schoolmen as 'semi-pelagianism.' See PELAGIANISM. As C.'s doctrine gained support from the Massilian monks; St Augustine, having been informed of it by his friend Prosper of Aquitaine, wrote strongly against it, especially in his treatise *De Gratia et Libero Arbitrio, contra Collationem*. It is not known when C. died; but it must have been subsequent to 433 A. D. The first

collected edition of the various works attributed to him was published at Basel, in 1559; the best at Frankfurt, in 1722. The best account of his life and writings is by Wiggers, *De Johanni C.* (Rostock, 1824—1825).

CASSICAN (*Cassicus*), a genus of birds allied to starlings, having an exactly conical bill, thick at the base, and extremely sharp pointed, the commissure forming an angulated line, the bill ascending on the forehead, and encroaching circularly on the plumage. They are all American birds of gregarious habits, feeding both on fruits and insects, and exhibiting such surprising skill and ingenuity in the structure of their nests, that an old lady once gravely asked an American ornithologist whether he did not think they might be taught to darn stockings! The Crested C., or Crested Oriole (*C. cristatus*), is a native of Brazil, Guiana, and Paraguay. It is about 20 inches long, is sometimes seen in flocks of 50 or 100, and constructs its nest by knitting together shreds of a thin bark, *Tillandsias*, &c. The nest is about 36 inches long, and resembles a purse or pouch, the lower end hemispherical, and 10 inches wide, and is suspended from the extremity of a branch of a tall smooth-stemmed tree on the outskirts of a forest, apparently to insure safety from monkeys and serpents. Several of these nests are often to be seen hanging from the branches of the same tree.

CASSINI, the name of a family distinguished by their services in astronomy and geography.

CASSINI, GIOVANNI DOMENICO, was born at Perinaldo, near Nice, on the 8th of June 1625, and studied at the College of Jesuits, Genoa. In 1650 he was appointed to the astronomical chair in the university of Bologna. His first work related to the comet of 1652. He subsequently devoted himself to the determination of astronomical refraction, and of the sun's parallax, &c. In 1664—1665 he determined the period of Jupiter's rotation. Subsequently, he determined the periods of the planets Mars and Venus, as also of the apparent rotation of the sun. He it was who discovered the third and fifth satellites of Saturn, and afterwards the first and second, as well as the dual character of that planet's ring. He was also the first who carefully observed the zodiacal light; he demonstrated that the axis of the moon was not (as had been believed) at a right angle to the ecliptic, and explained the cause of the phenomenon known under the name of lunar libration. One of his finest observations was the coincidence of the nodes of the moon's equator and orbit. C. died September 14, 1712, at Paris, whither he had gone in 1669, at the invitation of Colbert, to take charge of the observatory erected by that minister.

CASSINI, JACQUES, son of the preceding, was born at Paris, February 18, 1677. In 1694 he was elected a member of the Academy of Sciences. He travelled in Italy, Holland, and England, where he formed the acquaintance of Newton, Halley, Flamsteed, &c., and was elected a member of the Royal Society of London. On the death of his father, he succeeded to the charge of the observatory at Paris, and died April 16, 1756. C. wrote several treatises on electricity, the barometer, &c. In his treatise, *De la Grandeur et de la Figure de la Terre* (Par. 1720), he attempted to shew that the earth must be a spheroid elongated at the poles. The Newtonians denied this, inasmuch as it was opposed to the ascertained facts of gravitation and rotation, which necessitated the earth's being a spheroid flattened at the poles. As an observer, C. was eminently successful. He determined the periods of rotation of all the satellites of Saturn then known, the inclination of the planetary orbits, the obliquity of

the ecliptic very nearly, and the length of the year, &c.—His son, CÆSAR CASSINI, was also engaged in scientific pursuits.

CASSINI, JEAN DOMINIQUE, COMTE DE, the son of Cæsar Cassini, was born at Paris, June 30, 1748. He succeeded to the charge of the observatory, and completed in 1789 the great topographical map of France, begun by his father. But it having been decreed in 1793 that the observatory should no longer be in the hands of one person, three others were in consequence elected to the superintendence of it along with C., whose conduct on learning this fact shewed that he had a greater regard for his own dignity than for the whole stellar universe. He refused to have anything more to do with astronomical science, and obstinately kept his purpose through a life that lasted nearly a century, and which was apparently so prolonged to test the durability of a Frenchman's disdain. In his 95th year he published a small volume of poems! He died October 18, 1845.

CASSIODORUS, or (according to several MSS.) CASSIODORIUS, MAGNUS AURELIUS, a Latin writer, who distinguished himself by his erudition in an age of barbarism, was born at Scylaceum (now Squillace), in Calabria, about 468 A.D. He was a member of a noble Roman family, and soon attracted the attention of Odoacer by his superior abilities and accomplishments. Under this monarch he held various offices, but after the defeat and murder of Odoacer by Theodoric the Ostrogoth, he passed into the service of the latter. The highest honours now fell upon him; and for years he administered the Ostrogothic power with remarkable prudence and success. In his 70th year, however, he withdrew to Calabria, where he founded the monastery of Viviers, and employed himself and the other monks in the invaluable work of copying classical MSS.; his great desire being to improve the education of the clergy. C. was about 100 years old when he died. Besides his grammatical and rhetorical manuals, which were used as text-books during the middle ages, he wrote a very important work, entitled *Variarum Epistolarum Libri XII.* This is a collection of state-papers, and is, in fact, the most extensive as well as the most reliable source of information which we possess in regard to everything connected with the Ostrogothic rule in Italy. The style, however, is very peculiar, and shews the influence which the political career of C. had exercised on his language and modes of thought. The editio princeps of the *Variarum* was printed at Augsburg in 1533.

CASSIOPEIA, the *Lady in her Chair*, a constellation in the northern hemisphere, near Cepheus, and not far from the north pole. It is marked by five stars of the third magnitude, forming a figure like an M. A line from Capella to the bright star in Cygnus passes nearly through the middle of this M. C., according to Flamsteed, contains 55 stars, all of small magnitude. The figure is that of a woman sitting in a chair with a branch in her hand. In the year 1572, there all at once appeared in C. a new star. It was first noticed by Tycho Brahe on the 11th November, when its lustre exceeded that of all the fixed stars, and nearly equalled that of Venus. The star gradually diminished in lustre, from the time of its being observed until, in March 1574, it disappeared. It is said to have alarmed all the astronomers of the age. Tycho Brahe wrote a treatise on it, and supposed that it had previously appeared in 945 and 1264; but this supposition would not appear to be founded on reliable observation. Sir John Herschel suggests the possibility of its reappearance in 1872.

CASSIQUIARÉ, or **CASSIQUIARI**, a river of Venezuela, South America, forming the south bifurcation of the Orinoco, which it leaves in lat. $3^{\circ} 10' N.$, long. $66^{\circ} 20' W.$, and after a rapid south-west course of about 130 miles, joins the Rio Negro in lat. $2^{\circ} 5' N.$, long. $67^{\circ} 40' W.$ About 100 yards in breadth when it issues from the Orinoco, it gradually increases until at its union with the Rio Negro it attains a width of 600 yards. By means of this singular river, water-communication is established, through the Amazon, Orinoco, and their affluents, between the interior of Brazil and the Caraccas in Venezuela.

CASSIS (Fr., the black currant-tree), a French liqueur prepared from black currants; the manufacture has recently become of great importance. See **CURRENT**.

CASSITERIDES. See **SCILLY ISLES**.

CASSIUS, **LONGINUS CAIUS**, one of Cæsar's assassins. At the breaking out of the civil war, though a tribune of the plebs, he sided with Pompey and the aristocratic faction against Cæsar. He was taken prisoner by the latter, who pardoned him, and even made him one of his legates. In 44 B. C., through the influence of Cæsar, he was made *Prætor Peregrinus*, and was promised the governorship of Syria in the following year. But his mean and jealous spirit could not endure the burden of gratitude imposed upon him by the generosity of the dictator, and he resolved to be released by the murder of his benefactor. Having attached to himself the ruttinous spirits among the subjugated aristocracy, and also won over M. Brutus, the pseudo-patriotic conspiracy was soon matured, and on the 15th of March, 44 B. C., Cæsar fell by the daggers of assassins. The result of this bloody deed was not what C. had expected. The popular feeling—as witnessed by the riots that broke out at Cæsar's funeral—was strongly against the murderers; and the military power fell into the hands of Mark Antony. C. therefore fled to the east, and made himself master of Syria. Afterwards he united his forces with those of Brutus, and having greedily plundered Asia Minor, they crossed the Hellespont in the beginning of 42 B. C., marched through Thrace, and took up a superior position near Philippi, in Macedonia. Here they were attacked by Antony and Octavian. The division commanded by C. was totally routed, although, on the other hand, Brutus succeeded in repulsing the troops of Octavian. C., supposing that all was lost, compelled his freedman, Pindarus, to put him to death. C.'s wife, a half-sister of Brutus, survived him upwards of sixty years. She died in the reign of Tiberius, 22 A. D.

CASSIUS, **PURPLE** OF, is a colouring substance of very ancient use, which is prepared by adding a mixed solution of protochloride and bichloride of tin gradually to a solution of chloride of gold, when a more or less abundant precipitate of the double stannate of gold and tin ($\text{AuO}, \text{SnO}_2 + \text{SnO}, \text{SnO}_2$) is thrown down. The Purple of C. is soluble in ammonia, yielding a very pretty purple solution, from which it can again be obtained, with solid form unchanged, by evaporating the ammonia. Mixed with borax, or some fusible glass, Purple of C. is employed by the potter to communicate a rich purple or rose tint to the better kinds of china, and it also imparts the red colour to the kind of glass known as *Bohemian glass*.

CASSIVELAUNUS, a British chief, who fought against Cæsar during his second invasion of the island, 54 B. C. He ruled the country north of the Thames, and had a great reputation as a warrior, but his capital was taken by the Romans, and he himself compelled to flee. He afterwards sued for

peace, which he obtained, on condition of paying tribute and giving hostages.

CASSOCK, a long loose coat, formerly in common wear, but now usually worn only by the clergy. As worn by the clergy of the Church of England, it is a long coat with a single upright collar. Black is the common colour for all orders of the clergy, but on state occasions bishops frequently wear purple cassocks. In the Roman Catholic Church, cassocks vary in colour according to the dignity of the wearer—priests wearing black, bishops purple, cardinals scarlet, and the pope white.

CASSOWARY (*Casuarus*), a genus of birds nearly allied to the ostrich (see **BREVIPENNES** and **OSTRICH**), but distinctively characterised by still greater shortness of wing, by a laterally compressed bill, by a bony crest, by pendent wattles on the naked neck, and by three toes on each foot, all furnished with claws, the inner toe short, and armed with a very long and sharp claw. There are also very important anatomical differences in its digestive organs, which are not adapted to the same coarse diet, for the C. 'has short intestines and small cæca, wants the intermediate stomach between the crop and gizzard, and its cloaca does not proportionally exceed that of other birds.' Only one species is known, *Casuarus galeatus*, sometimes called Emu by the older naturalists, before that name was appropriated to the Australian bird which now alone receives it. The C. is a native of the Moluccas, New Guinea, and other Asiatic islands, chiefly inhabiting deep forests. In general appearance, it is not unlike the ostrich, but has a much shorter neck. It is the largest known bird except the ostrich, and its height, when erect, is about five feet. It feeds on fruit, eggs, and succulent herbage. When attacked, it defends itself by kicking obliquely backwards with its feet, and by striking with its short wings, the rigid barless shafts of which, although useless even to aid it in running, are not



Cassowary.

without value as weapons. There are only about five of them in each wing, somewhat resembling the quills of a porcupine; and at the end of the last joint of the wing there is a spur. The colour of the C. is brownish black; the feathers are loosely webbed, and hang down, so that, at a little distance, the bird seems clothed with hair. Those of the rump are 14 inches long, hanging down in place of a tail. The head and upper part of the neck are naked and of a bluish colour, and there are two pendent wattles, partly red and partly blue, on the

front of the neck. On the breast is a callous bare part, on which the bird rests its body on the ground. The bony crest or helmet reaches from the base of the bill to the middle of the crown, and is about three inches high, exhibiting the most intense blue, purple, and scarlet blended together. The C. lays a few eggs, which it leaves to be hatched by the heat of the sun; and which are greenish, and have a much thinner shell than those of the ostrich. Its flesh is black, tough, and juiceless. The C. is not unfrequently to be seen in menageries in Europe, but is becoming more rare in its native regions, in which it is sometimes kept tame.

CAST, an impression produced by pouring a ductile substance, such as plaster of Paris, into a mould. This method was employed by the ancients in multiplying not only objects of art, such as the small household statues of the gods, but articles of direct utility. The so-called *Celts*, or chisels of bronze, which, with the moulds for casting them, are found in England, Ireland, and France, testify to the fact, that the art of casting from a mould is one of the earliest acquired by semi-civilised nations. Casts are of incalculable value in familiarising the eyes of those who can never look on the originals with the grand and beautiful forms of antique art. The best to be had in this country are those executed, and sold on application, at the British Museum. Casting, when applied to metals, is called *Founding* (q. v.).

CAST, CASTING-LINE. The casting-line, in Angling, is a gut-line on which the artificial flies are fastened. It is made up of several lengths of gut, knotted together, and usually from two to four yards long. The flies are attached at intervals of about two feet, and the line with its flies is called a *cast*. The term *cast* is also applied to a part of a stream where certain fish may be taken, as a trout-cast, a salmon-cast.

CAST IRON is the variety of Iron (q. v.) obtained from the Blast-furnace (q. v.). It is run while hot from the furnace into a series of small canals in sand, and the iron cooling and solidifying there, is ultimately broken up into *pigs* of C. I. about four feet long, and three to four inches in diameter. There are several varieties of C. I., which are well known in the arts. These varieties contain different proportions of carbon united with the iron, ranging from 5 down to 2 per cent.; and the greater the amount of carbon, the more easily fused is the iron, and consequently the more suitable for foundry purposes. No. 1 pig is the best, contains most carbon, fuses most readily, and is employed for small castings; No. 2 is second-rate, has less carbon, takes a higher heat to melt it, and is generally used for large pieces of machinery; No. 3 is third-rate, has less carbon than No. 2, a higher melting-point, and is retained for heavy machinery requiring great strength and some degree of toughness to resist sudden pressure or strain; No. 4 is fourth-rate, and No. 5 fifth-rate, and these contain still less carbon, their fusing-point is higher, and they are employed in the fabrication of malleable iron (q. v.). The various kinds of C. I. differ likewise in structure and appearance of surface. Thus, No. 1 is large-grained, with the appearance of small scales when a fresh surface is exposed, whilst the size of the grains decrease till, in No. 5, the grains or particles are so minute as to communicate a whitish granular aspect, so that this is technically called *white iron*. Besides these numbers, there is a variety of C. I. known to the trade as *silvery iron*, which may be obtained in any of the numbers, and which is characterised by a light silvery appearance, and by great comparative weakness

when fashioned into castings. This silvery iron is a source of great annoyance to manufacturers of iron, and, at the present time (1860), little is known regarding the cause of its production, and as little in reference to any means of preventing its formation.

CAST STEEL is employed for edge-tools, plane-irons, and other cutting instruments. It is generally prepared from Blistered Steel (q. v.). The latter is cut up into small pieces, and placed in crucibles, and covered with broken glass or some slag. These crucibles are about two feet high, and are made of very refractory clay, intermingled with a small proportion of coke. Being exposed to a high heat in a furnace for three or four hours, the steel is melted; and the crucible being lifted out of the furnace, the contents are poured into a cast-iron mould, and constitute cast steel. It is extremely hard, and may either be employed by itself in the fabrication of cutting instruments, or, where cheapness combined with strength is required, the cutting edge merely is made of C. S., the main body of the tool being ordinary tough bar iron. The union of the bar iron and C. S. is effected at the time when the latter is poured liquid into the moulds, when the two form such an intimate and complete union that the compound mass may be fashioned into any shape, and rolled and re-rolled without any tendency of the components to separate. In Germany, a variety of C. S., known as *natural steel*, is obtained by partially refining cast iron in a furnace with charcoal.

CASTALIA, a fountain on the slope of Parnassus, a little above Delphi, in Phocis, sacred to Apollo and the Muses. It was the 'holy-water' of the Delphian temple; and all who came to consult the oracle, or visited the place with any religious purpose whatever, were wont to bathe their hair *roro puro Castalia* (in the pure dew of C.), but those who wished to be purified from murder, bathed their whole body. The Roman poets feigned that its waters filled the mind of those who drank of it with poetic inspiration. It was imagined to have some connection with the river Cephissus, and to flow from the subterranean Styx. The fountain, whose waters are still pure and delightful as in the days of classical antiquity, now bears the name of St John, from a small chapel of that name close by.

CASTANETS, a musical instrument of percussion in the form of two hollow nut-shells, which are bound together by a band fastened on the thumb, and struck by the fingers to produce a trilling sound in keeping with the rhythm of the music. The *krotalon* of the ancients was somewhat similar. The C. were introduced into Spain by the Moors, where they retain the name of *castanulas*, from their resemblance to the form of the chestnut. The C. are now much used in the ballet and in the opera.

CASTAÑOS, DON FRANCISCO XAVIER DE, Duke of Baylen, a celebrated Spanish general, was born at Madrid in 1756, and studied in Germany the military tactics of Frederick the Great. For some time after his return to Spain, he had no opportunity of acquiring distinction; but when Napoleon I. invaded that country, C. received the command of a division of the Spanish army, and on the 22d of July 1808, compelled 20,000 French, under General Dupont, to surrender at Baylen. It is asserted, however, that the merit of this prodigious success belonged more to Aloys Reding, a Swiss by birth, and the second in command. In November of the same year, C. was in turn defeated by the French at Tudela. The arrival of Wellington necessarily reduced him to a subordinate position, but he took part in the important battles of Albuera, Salamanca, and

Vittoria. In 1811, he was appointed general of the 4th Spanish *corps d'armée*, and commandant of several provinces. In 1815, he was placed at the head of 80,000 troops, destined to invade France, some of which had already crossed the frontier when the news came of the battle of Waterloo. Although no great favourite with the court politicians, his talents could not be overlooked. In 1825 he was called to the state council, where he became a decided opponent of the Carlist party. He died 24th September 1852, at the advanced age of 96.

CASTE, a term applied chiefly to distinct classes or sections of society in India, and, in a modified sense, to social distinctions of an exclusive nature among the nations of the West. When, at the end of the 15th c., the Portuguese began to penetrate to India by the Cape of Good Hope, and to trade with the Deccan or southern portion of the Indian peninsula, they found arbitrary social laws, full of intricate regulations which constantly interfered with their intercourse with the natives, especially in matters involving the *subdivision of labour*. They found certain pursuits invariably followed by a certain class, and any attempt to induce a man to perform offices not appointed for the class of which he was a member, met with violent opposition, though such offices might, according to European notions, be more honourable than many he was content to fulfil. They observed, also, that these different classes often varied in appearance, the result, in some cases, of their addiction for many generations to the same pursuits; in others, of their having actually arisen from a different stock. Hence they applied to these various divisions of society the term *casta*—a Portuguese and Spanish word, meaning a breed. As applied to these classes of Hindu society, the word has passed into most European languages. From its frequent use in India, it has sometimes been erroneously considered of Hindu origin.* Of late, it has been spelled *caste*, but by old authors *cast*; and it is even a question, whether the word may not be as genuine English, as *casta* is Spanish.

In the south of India, the Portuguese became acquainted with what is considered the most exaggerated evil of caste. There are found there large numbers of a class called *Pariahs*, or, in other districts of India, *Chandalas*. They are probably the relics of some early conquered race, who have been degraded by uninterrupted ages of oppression, as is represented to have been the case with the Helots of Sparta, and people in a similar condition. These Pariahs were always identified with outcasts—i. e., persons who had forfeited the privileges of their original order. No one of any C. would have any communication with them. If one of them even touched a Nayar, or warrior of high C., he might with impunity kill him. Some sorts of food were defiled by even their shadow passing over them; and the name of Pariah or Chandala conveyed to the Hindu the idea of the utmost vileness and disgust. All who violated the institutions of their class were held to sink into this class—a condition which involved the loss of all human respectability and comfort. These regulations were, moreover, referred to religion.

As India was at this time the land of the marvellous, and its inhabitants, though as various as the different nations of Europe, viewed as one homogeneous people, what was only true of one portion of the peninsula, was considered as prevailing everywhere, and as identical with the

divisions of the Indians into *seven* tribes or castes, mentioned in olden times by Strabo, by Diodorus Siculus, and by Arrian. Nor was it forgotten that the Egyptians, whose early civilisation was as undoubted as that of India, were also divided, according to Herodotus, into seven classes of priests, warriors, herdsmen, swineherds, tradesmen, interpreters, and pilots, to each of which were assigned particular districts.

About the middle of the 16th c., however, Abraham Roger, chaplain of the Dutch factory at Pulicat, gained the confidence of a Brahman, acquainted with the Sanscrit language, and by this means learned pretty exactly the account of the origin of C. given in the *Laus of Menu*, a work inferred to have been written not later than 900 B.C., which was long known only by name in Europe, until about the end of the last century, when a copy was obtained, and translated by Sir William Jones. The whole of the Hindus are represented by Menu as divided into four classes:

1. The *Brahmans*, or *sacerdotal class*, who are said, at the moment of creation, to have issued from the *mouth* of Brahma. Their business is reading and teaching the Vedas, and the performance of sacrifice for themselves and others. They are to be the chief of all created beings; the rest of mortals enjoy life through them. By their imprecations, they can destroy kings, with all their troops, and elephants, and pomps. Indra, when cursed by one of them, was hurled from his own heaven, and compelled to animate a cat. Hence, the Brahman is to be treated with the most profound respect, even by kings. His life and person are protected by the severest laws in this world, and the most tremendous denunciations for the next. His own offences are treated with singular lenity; all offences against him, with terrible severity. He is forbidden to live by service, but on alms; and it is incumbent upon virtuous men and kings to support him with liberality; and all ceremonies of religion involve feasts and presents to him. The first part of his life is to be devoted to an unremitting study of the Vedas—books, he it observed, older than the code of Menu, and yet, except, perhaps, one of the later hymns, containing no mention of C. as a religious ordinance. He is to perform servile offices for his preceptor, and beg from door to door. In the second quarter, he lives with his wife, reads and teaches the Vedas, assists at sacrifices, and, 'clean and decent, his hair and beard clipped, his passions subdued, his mantle white, his body pure, with a staff and a copy of the Vedas in his hand, and bright golden rings in his ears,' he leads a studious and decorous life. The third quarter of his life he must spend in the woods, as an anchorite, clad in bark, without fire, wholly silent, and feeding on roots and fruits. The last period he is released from external forms and mortifications, and is to spend his time meditating on the divinity, until at length he quits the body, 'as a bird leaves the branch of a tree, at pleasure.'

2. The *Kshatrya*, or *Chaitree*, or *military class*, sprang from the *arm* of Brahma, and bear something of a sacred character. It is stated that the sacerdotal order cannot prosper without the military, or the military without the sacerdotal; and the prosperity of both, as well in this world as in the next, is made to depend on their cordial union. The Kshatrya are to give alms, to sacrifice, to read the Vedas, and defend the people. Though Brahman are to draw up and interpret laws, they are carefully excluded from administering them. The *executive* government is vested in the Kshatryas alone.

3. The *Vaisya*, or *Bais*, or *mercantile class*, sprang from the *thigh* of Brahma. Their grand duties are

* In Sanscrit, castes are called *Varnas*, i. e., 'colours;' colour being, no doubt, the chief distinction at first.

to keep cattle, carry on trade, lend on interest, cultivate the soil, and turn their attention to every description of practical knowledge. They are to be perfect men of business.

4. The *Sudras*, or *Sooders*, or *servile class*, came from the *foot* of Brahma. They are to serve the three superior classes, more especially the Brahmans. Their condition is never to be improved; they are not to accumulate property, and are unable by any means to approach the dignity of the higher classes. Utter and entire submissiveness to the Brahmans is the spirit of all a Sudra's duties, and this is to be enforced by penalties as severe as they are ridiculous. Yet, withal, the Sudras were not to be slaves, either public or private, and to occupy a position much higher than the Chandalas.

Mixture of castes, though not absolutely forbidden, entails disadvantages on the children, and the offspring of a Brahmical woman and a Sudra becomes a Chandala, or outcast.

Such—omitting the minute and childish laws and penalties, many hundreds in number, by which it is proposed to carry the principle of C. into the pettiest affairs of life—is a brief outline of it, as gathered from the code of Menu. There is no historical evidence that it ever existed in this form, and, from the nature of the case, we may conclude that it never did. In the *Toy-cart*, the oldest Hindu drama, no extravagant veneration for Brahmans anywhere appears. In fact, one of them is condemned to death; and the arrangements of society appear to have been the same as at present. The laws of C. form, it is true, a part of what is reputed to be Hindu law, but they have remained in all the states of India, Hindu as well as Mohammedan, to a great extent a dead-letter. There is nothing to shew that the code of Menu was drawn up for the regulation of any particular state. Some have even conjectured that it may have been the work of some learned man, designed to set forth his idea of a perfect commonwealth under Hindu institutions, just as Plato in *The Republic* gives us his idea of a model government under Greek institutions.

Be this as it may, the C. which at present exists throughout the greater part of India is very different from that described in the code of Menu, though to this it owes, no doubt, much of its stability and its importance in the eyes of Europeans. With the exception of the Brahmans, the pure castes have disappeared, and out of the intermixture of the others have sprung innumerable classes, many of them unauthorised except by the people themselves. So engrained in the whole community is this tendency to class distinctions, that Mussulmans, Jews, Parsees, and Christians fall, in some degree, into it; and even excommunicated or outcast Pariahs form castes among themselves. Most of the existing castes partake of the nature of associations for mutual support or familiar intercourse, and are dependent upon a man's trade, occupation, or profession. Many of them have been described by Mr Colebrooke in the *Asiatic Transactions*, vol. v. Many have had their origin in guilds, in schism from other castes, in the possession of a particular sort of property (as, for instance, landlords are spoken of as the C. of *zemindars*), and similar accidental circumstances. Their names are often due to the district in which the C. took its rise, to their founder, to their peculiar creed, or any random circumstance. In the Bengal presidency, there are many hundreds of such castes, almost every district containing some unknown in those adjacent. Among the lowest classes, and especially among the servants of the English at Calcutta, it has degenerated into a fastidious tenacity of the rights and privileges of station. For example,

the man who sweeps your room will not take an empty cup from your hand; your groom will not mow a little grass; a coolie will carry any load, however offensive, upon his head, but even in a matter of life and death, would refuse to carry a man, for that is the business of another caste. Such and many other regulations are described in every work on C., but are as unworthy of serious regard as are the assertions of self-importance found among little people all the world over. When an English servant pleads that such a thing 'is not his place,' his excuse is analogous to that of the Hindu servant when he pleads his caste. When an Englishman of birth or profession, which is held to confer gentility, refuses to associate with a tradesman or mechanic—or when members of a secret order exclude all others from their meetings—or when any other similar social distinction arises, it would present itself to the mind of the Hindu as a regulation of caste.

Nor does C., at the present day, *tie a man down to follow his father's business*, except, perhaps, in the case of the more sacred functions of the Brahmans. For the rest, Brahmans serve as soldiers, and even as cooks. Men of all castes have risen to power, just as in England our statesmen have sprung from every class of society. Nor, again, is loss of C. anything so terrible as has been represented; in most cases, it may be recovered by a frugal repast given to the members of the C.; or the outcast joins another C., among whom he will commonly be received with the heartiness due to a new convert. The question of the restoration of a Christian convert wishing to rejoin the Brahmical C., has been differently decided by his fellow caste-men in different places.

As in the West, so in the East, C. enters into all the most ordinary relations of life, producing laws often most tyrannical and too anomalous to admit of generalisation. In the West, however, whilst good sense and Christianity have ever tended to ameliorate social differences, the feeble mind of the Hindu and the records of his religion have had a contrary effect.

These modified views of C., which have begun to prevail in recent years, will be found more fully developed in *Shore On Indian Affairs*, Irving's *Theory and Practice of Caste*. Full accounts of the petty regulations of C., as laid down in the code of Menu, may be seen in Sir William Jones's *Translation of the Code of Menu*, Robertson's *Disquisition on India*, Richard's *India*, Elphinstone's *History of India*, Dubois's *India*, Colebrooke's *Asiatic Transactions*, vol. v., and in various articles in the *Calcutta Review*. An important work on *The Mythical and Legendary Accounts of Caste*, was published, Lond. 1858, being Part I. of *Original Sanscrit Texts on the Origin and Progress of the Religion and Institutions of India; collected, translated into English, and Illustrated by Notes. Chiefly for the Use of Students and others in India*. By John Muir, D.C.L.

The question how C. is to be dealt with in converts to Christianity, has now been determined by common consent of missionaries in India; and it receives no recognition within the Christian church. An opposite policy, in former times, founded on the opinion that C. might be regarded as merely a civil or social institution, and not as a part of the religion of the Hindus, is now believed to have been among the principal causes of the comparative decay of the churches or congregations founded during the 18th c. in the south of India.

CASTEGGIO, a town of Piedmont, Northern Italy, five miles east-north-east of Voghera. In the campaign of 1859, C. was occupied by Austrians

CASTEL—CASTELLIO.

prior to the battle of Montehello, in which they were defeated by the French and Sardinians. C. was also valorously but unsuccessfully defended by the Austrians in the great battle of Montebello between them and the army of Napoleon I. in 1800. As *Clastidium*, C. was an important military position as early as the times of the Gallic and Punic wars. Some Roman antiquities still remain, and numerous curious inscriptions and coins have been found. Pop. 2900.

CASTEL (from the Latin *castellum*) is a name prefixed to various places in Italy, France, Spain, Portugal, &c., of which the most important are

1. **C.-ARQUATO**, a town of Parma, North Italy, 19 miles south-east of Piacenza, picturesquely situated amid forests and vineyards, with a fine Gothic church and a noble old castle, from which the town derives its name. It has manufactures of silk, and a population of 4400.

2. **C.-BOLOGNESE**, a town of Central Italy, about 22 miles west-south-west from Ravenna. It derives its name from a strong fortress built here by the Bolognese in the 14th c.; and is historically famous as the scene of a decisive battle between the Milanese and Florentines in 1434, in which the latter were completely vanquished.

3. **C.-BUONO**, a town of Sicily, in the province of Palermo, eight miles south-east of Cefalu. It is noted for its mineral springs, and has a trade in manna. Pop. 7000.

4. **C.-FRANCO**, a town of Central Italy, eight miles east of Modena, with the old walls and ramparts of a castle built by Urhan VIII., and near the site of the battle between the consuls Hirtius and Pansa and Mark Antony.—Also the name of a town of Venice about 25 miles north-west from the city of that name, with linen and woollen manufactures, and a population of 6500.

5. **C.-GANDOLFO**, a village of the Papal States, 11 miles south-east of Rome, and near the west shore of Lake Albano. Its situation is extremely picturesque, and it commands extensive views of some of the most beautiful scenery in Italy. The pope has his summer residence here. In early times, the noble family of the Savelli had a stronghold at C., by means of which, for a period of nearly 400 years, they bade defiance to popes, barons, and *bourgeoisie*.

6. **C.-SARDO** (formerly *C. Aragonese*), a fortified town and seaport, the strongest on the island of Sardinia, is situated on a steep rock on the north coast, 16 miles north-east of Sassari. The environs produce wine. Pop. 2000.

7. **C.-SARRASIN**, a town of France, in the department of Tarn et Garonne, on the Songuine, 12 miles west from Montauban. It has the remains of an old castle said to be of Saracenic origin, a population of about 5000, manufactures of serge and worsted stockings, and a trade in the agricultural produce of the district.

8. **C.-TERMINI** (ancient *Camicianæ Aquæ*), a town of Sicily, in the province of Girgenti, and 16 miles north from the city of that name. It has extensive mines of rock-salt and sulphur, and a population of 5000.

9. **C.-VETRANO**, a town of Sicily, in the province of Trapani, 29 miles south-east of the town of that name. It is a decaying place with an old castle, several convents, manufactures of articles of coral and alabaster, and a population of 12,000. Some of the most esteemed white wine of Sicily is produced in the vicinity.

CASTELLAMARÉ, a fortified city and seaport of Naples, about 17 miles south-east of the city of that name. It is built on the lower slopes of

Monte d'Auro, and along a sheltered beach on the south-east side of the Gulf of Naples, over which it commands a magnificent view. It is on or near the site of the ancient *Stabie*, which was desolated by Sylla during the Social War, and where the elder Pliny afterwards lost his life when the city was overwhelmed with lava from Vesuvius. Some ancient remains have been found here. The town was sacked in the 15th c. by Pope Pius II., and again in the 17th c. by the Duc de Guise. It has a royal palace, a cathedral, several convents, among which that founded by Gonsalvo de Cordova, in the 16th c., is famous for the possession of an image of the Madonna, found in a well in the 11th c., which is greatly venerated by the peasantry, who make an annual pilgrimage to the church. The old castle, which gave name to the town, was built in the 12th century. C. has a royal dockyard, affording employment to many of the inhabitants, and manufactures of linen, silk, cotton, leather, and sail-cloth. Pop. 18,000.—**CASTELLAMARE** is also the name of a town in Sicily, situated at the head of a gulf of the same name, and 20 miles east from Trapani. It has a population of 8000, and exports of cotton, wine, fruit, and manna.—**C., GULF OF**, is an extensive bay on the north coast of Sicily. Its width from east to west, between Point Uomo Morto and Cape St Vito, is about 15 miles; and its depth about 14 miles. It has deep water and good anchorage, but is much exposed to north winds.

CASTELLAMONTE, a town of the Sardinian States, 10 miles south-west of Ivrea. It has an old castle, manufactures of earthenware, and a trade in the agricultural produce of the district. Pop. 5200.

CASTELLAN, or **CHÂTELAIN**, the keeper of a castle or *burg* in the middle ages. The office and the rank of the C. were various in various countries. In France and Flanders, the title C. belonged to the holders of certain demesnes, and was next in order of rank to that of a bailiff. In Germany, the C. had the jurisdiction of a Burg-graf during the ages of chivalry. In Poland, the title of C., with its appendages, remained in later times, and, after the 16th c., the castellans, with the waiwodes and bishops, formed the senate or superior legislative chamber.

CASTELLA'NA, a town of Naples, in the province of Bari, and 26 miles south-east of the city of that name. Its trade is confined to the produce of the district. Pop. 9000.

CASTELLANE'TA, a town of Terra di Otranto, Naples, 20 miles north-west of Otranto. It has a cathedral and several convents. Cotton is grown in the district. Pop. 5400.

CASTELLA'ZZO, a town of the Sardinian States, about 5 miles south-west of Alessandria. Pop. 5200.

CASTELLEONÉ, a town of Lombardy, North Italy, situated near the Oglio, about 12 miles north-north-west of Cremona. It is surrounded by old walls, has a fine church, and a population of 5700.

CASTELLIO, SEBASTIEN, a French theologian, was born in Dauphiné, in 1515. His proper name was *Châteillon*, which he Latinised, according to the usage of his time. About 1540, he was invited to Geneva by Calvin, and appointed Humanity professor; but having the misfortune, afterwards, to differ from the reformer in religious opinion, he was banished from the city, and went to Basle, where he spent the rest of his life in great poverty. See CALVIN.

Among his various writings may be mentioned

De Hæreticis, &c.—a treatise which argues against the right of the magistrate to punish heretical opinions, and which produced a reply from Beza; a Latin version of the Old and New Testaments, published in 1551, and dedicated to Edward VI. of England; and a posthumous work, in dialogue, on predestination, election, free-will, and faith, first published by Faustus Socinus in 1578.

CASTELLO'N DE LA PLA'NA, a town of Spain, capital of the province of the same name, is situated in the midst of a fruitful plain, about 4 miles from the Mediterranean, and 40 miles north-north-east of Valencia. A magnificent aqueduct supplies the means of irrigation. C. is surrounded by walls, and is for the most part well built. It has some handsome old churches, and a singular bell-tower 260 feet high. Ribalta, the celebrated Spanish painter, was a native of Castellon de la Plana. It has manufactures of linen, woollen, sail-cloth, paper, earthenware, and firearms; also brandy distilleries, and an active trade. Pop. 16,000.

CASTELNAUDARY, a town in the department of Aude, France, situated on a declivity, skirted at the base by the Canal du Midi, 22 miles west-north-west of Carcassone. It has manufactures of woollen and silk fabrics, and earthenware, and carries on a lively trade in agricultural produce. The canal at this point expands into a large basin, which serves as a haven. It suffered dreadfully in the crusade against the Albigenses, and was, in 1212, the scene of a battle between Simon de Montfort and Raymond, Count of Toulouse. In 1355, it was captured by the Black Prince. In 1632, Marshal Schomberg here gained a victory over the party of the Duke of Orleans, when the brave Duke of Montmorency was taken prisoner, and afterwards executed at Toulouse.

CASTELNUO'VO, a seaport town of Dalmatia, Austria, situated near the west entrance of the Gulf of Cattaro. It is surrounded by walls, and defended by two forts and a citadel. It has manufactures of brass, and a trade in the produce of the district, which is fertile. It was captured by the British in 1814. Pop., including commune, 7000.

CASTIGLIO'NÉ, LAKE OF, a lagoon of Tuscany, in the province of Siena. It lies to the north of Grosseto, and has a length of about 10 miles, with a breadth of from 1 to 3 miles. Receiving the waters of the Bruna and other rivers, it discharges its water by a short canal into the Mediterranean.

CASTIGLIO'NE, BALDASARRE, COUNT, one of the most elegant of the old Italian writers, was born, 1478, at Casatico, in the duchy of Mantua, and studied at Milan. His shining talents, knowledge, and pleasing manners made him a favourite of Guidobaldo di Montefeltro, Duke of Urbino, a great patron of literature, at whose court he was honourably entertained, along with other men of eminence in letters. He was employed by the duke as envoy to Henry VIII. of England, who made him a knight; and was afterwards sent in the same capacity to Louis XII. of France, under Guidobaldo's successor, in several important ambassadorial missions. He died at Toledo in 1529. His chief work is the book *Del Cortegiano*, a manual for courtiers, remarkable for its elegant style. His Italian and Latin poems are also models of elegance, and his *Letters* (2 vols., Padua, 1769—1771) contain interesting contributions to the political and literary history of his time. Tasso devoted a sonnet to the death of C., and Giulio Romano raised to his memory a monument in Padua.

CASTIGLIO'NE, CARLO OTTAVIO, COUNT, an eminent Italian philologist, was born at Milan in 1795. At an early period, he displayed a predi-

lection for antiquarian studies, more particularly numismatics. When only 24 years of age, he published a description of the Kufic coins in the cabinet of Brera, at Milan, under the title, *Monete Cufiche del Museo di Milano* (Milan, 1819), which shewed a great knowledge of oriental languages and history. C.'s principal work in the sphere of oriental literature is his *Mémoire géographique et numismatique sur la Partie orientale de la Barbarie appelée Afrikiah par les Arabes, suivi de Recherches sur les Berbères Atlantiques* (Milan, 1826), in which he seeks to ascertain the origin and the history of the towns in Barbary whose names are found on Arabic coins. Out of Italy, C. is perhaps best known by his edition of some fragments of the Mæso-Gothic translation of the Bible by Uphilas (q. v.), which had been discovered, in 1817, by Cardinal Mai among the palimpsests of the Ambrosian Library. At first, he published some specimens in conjunction with Mai, but in 1829, 1834, 1835, and 1839, appeared a variety of fragments of the Pauline epistles, edited by himself, and enriched with valuable disquisitions, commentaries, and glossaries.

CASTIGLIONE DELLÉ STIVIERÉ, a town of Lombardy, North Italy, 22 miles north-west of Mantua. It is walled, and defended by an ancient castle; but is chiefly celebrated on account of the victory obtained here by the French over the Austrians in 1796, and which gave the title of Duc de Castiglione to Marshal Augereau. Pop. 5200.

CASTILE (Spanish, *CAST'LLA*) forms, in a geographical and political point of view, the central district of the Spanish peninsula, being the middle and most strongly marked plateau of Spain, as well as the central seat of the monarchy. Both geographically and politically it is divided into Old and New Castile—*Castilla la Vieja* and *Castilla la Nueva*. The former district, situated in 40° 5'—43° 32' N. lat., and 1° 40'—5° 35' W. long., rises, in the form of an elevated plateau, to the height of 2500—3000 feet. It is walled in on all sides: on the north, by the highest masses of the Cantabrian Mountains, which separate it from the Basque provinces and Asturias; on the south, by the high ridge forming the water-shed between the Douro and the Tagus; while the Sierras de Oca, de Urbion, and Moncayo, and the heights of Leon and Tras-os-Montes bound it on the east and west. The high plateau of Old C. is but scantily watered, and its natural characteristics far from inviting. In many parts, nothing is presented to the eye but a wide, unwooded, almost treeless waste of lazar, unrefreshed by streams, in some parts monotonously covered with stunted grasses, and in others, almost destitute of vegetation. The traveller may walk many miles without finding a village, or even a solitary farmhouse. All Old C., however, is not a dusty desert. There are rich tracts in it producing some of the finest wheat in the world. Madder and grasses are also produced abundantly in some parts; and even the olive flourishes where it is protected from the frost and snow of winter, and from the cold winds prevailing in October and the following months. Iron and other minerals exist in plenty, but are not worked to any great extent. Sheep, cattle, pigs, and mules form the chief wealth of the inhabitants. Manufactures consist of coarse woollens, cotton, linen, leather, and glass.

The plateau of **NEW CASTILE**—which is situated between lat. 38° 23' and 41° 15' N., and long. 1° and 5° 25' W.—like Old C., is also enclosed by mountains. Though lying 1800 feet lower than Old C., New C. presents many similar characteristics of soil and scenery. It is mostly sterile, and scantily

irrigated; little rain falls, and the nightly dews are insufficient to refresh the plains, which are entirely destitute of trees, and, in summer, appear quite burned up. Olives, corn, pulse, and saffron, are cultivated in some neighbourhoods; but flocks of sheep constitute the chief wealth of extensive tracts of land. The commerce, carried on by means of long trains of mules, reminds the tourist of the caravan-traffic over eastern deserts. Industry is almost entirely restricted to manufactures of coarse woollen goods. The yield of the salt-mines in the south is considerable; and quicksilver, especially at Almaden (q. v.), and iron (manufactured at Toledo) are plentiful. The Castilians have even more than the general haughtiness of the Spanish character. Their language prevails throughout the educated classes, as in the literature of Spain, and their rulers have extended their sway over the whole nation.

In the present administrative division of Spain into forty-nine provinces, the division of Old and New C., though it will long be remembered by the people, is one belonging to past history. Old C. is now divided into the eight provinces of Burgos, Logroño, Santander, Sorja, Segovia, Avila, Palencia, and Valladolid. The population, distributed over an area of 22,797 square miles, amounted in 1857 to 1,752,084. New C. includes the five provinces—Madrid, Guadalaxara, Cuenca, Toledo, and Ciudad Real, and on an area of 30,882 square miles, has 1,587,649 inhabitants. Besides these provinces, the kingdom of Leon, Galicia, the principality of Asturias, and the districts of Estremadura, Andalusia, Granada, and Murcia, belonged to the crown of Castile.

C. first became an independent country in 762, and remained so until 1028, when it passed to Sancho III., king of Navarre. His son, Ferdinand I. (Great), founded the kingdom of C., and among other acquisitions annexed to it the kingdom of Leon. This union, however, was not permanent, Leon being made a separate kingdom for Ferdinand II. The two kingdoms, however, were afterwards reunited in the 13th c. in the person of Ferdinand III., and remained ever after under one sceptre. Among the successors of Ferdinand III., the most distinguished was Alfonso X., by whose direction the Alfonsine (astronomical) tables were drawn up. By the marriage of Isabella, sister and successor of Henry IV., with Ferdinand, king of Aragon (1469), the two crowns of C. and Aragon became united (1479), and from these sprang the kingdom of Spain, which, however, was not fully established before the death of Ferdinand, in 1516, when Charles I. of Spain (Charles V. of Germany) inherited both crowns.

CASTILLON, a town of France in the department of Gironde, situated on the right bank of the Dordogne, 26 miles east of Bordeaux. It has manufactures of cotton and woollen yarns, nails, and cordage. It is celebrated as the scene of the battle between the forces of Henry VI. of England and Charles VII. of France, July 1453, in which the English met with a signal defeat, their leader, the Earl of Shrewsbury, and his son, being slain. Of all their possessions in France, Calais alone remained to the English after this battle, the incidents of which were seized on by Shakespeare for the sixth scene in his play of *King Henry VI.*, Part I., Pop. 3650.

CASTING, in Angling, is the term applied to the act of throwing a fly or a fish-bait. In casting a fly with a single-handed rod, the beginner should let out about as much line as the length of the rod; grasp the rod just above the reel; then wave it back over the right or left shoulder, with a slightly circular sweep, so as to extend the line behind;

and then bring it forward with a steady cutting kind of action, urging the point of the rod towards the spot where the fly is to fall, taking care not to carry the point of the rod too far forward, or too low; or the line will not fall straight and evenly on the water. The object of the circular sweep behind is to prevent the fly from cracking off. By slightly raising the point of the rod just as the fly is delivered, the line is straightened; and the fly, checked in mid-career, falls like thistle-down upon the water. Always allow time for the line to go straight out behind, for if returned too quickly, the fly cracks off. In casting with the double-handed rod, the one hand grasps the rod above the reel, and the other below it, the lower hand acting as a pivot upon which the rod turns.

In casting a bait, either for spinning, trolling, or live-baiting, the bait is suffered to hang from the point of the rod about a yard. Taking the rod in both hands, the line clasped to the rod in his right, the angler waves the bait gently back; and having first drawn as much line as he requires off the reel, and laid it loosely at his feet, he sends the bait forward with a swing towards the point he desires to reach.

CASTING-NET, a species of net very widely distributed, having been found in use amongst various savage tribes in different parts of the world, some of whom, from long and constant practice, use it with a dexterity and address unknown in England. The nets used in England are usually from 13 to 20 feet in circumference when spread out. They are netted in the shape of a kind of long loose bag or cone; and so much is the number of meshes increased as the net progresses, that it is capable of being spread out in a perfectly flat and circular form, the apex of the cone forming the centre of the circle. To this apex is attached a rope of some yards in length; when casting, this rope is fastened round the left wrist of the caster. The bottom of the net, which forms, when it is held up by the apex, the base of the cone, or, when spread, the circumference of the circle, is hung around with perforated leads or bullets. These have not only the effect of carrying the net to the bottom of the water, but also, when it is cast, of causing the net to spread open. The bottom of the net is turned up some six inches or more in depth, and hung up on the inside about every ten inches or so, to an upper portion of the net, by stout strings, so as to form a kind of purse; this is called the 'tuck.' When the net is required to be cast, the caster, having fastened the rope to his wrist, and coiled it loosely in his left hand, hangs a portion of the net over his left shoulder; and then gathering as much of the outer edge of the net as he can collect in his right hand, and holding it up so as to open the net as much as possible, makes a semicircular sweep of the body and the right hand—rather difficult to accomplish without practice—and whirls the net away off the shoulder. The centrifugal motion thus communicated to the leads, &c., on the bottom of the net, causes it to open like a circle on the surface of the water, the leads carry it to the bottom, and the net thus covers all that comes within its circle. The rope is then pulled gradually, and worked from side to side, in order to narrow the circle, to bring it once more into a cone; and, in their efforts to escape, the fish that may have been covered are gradually driven into the tuck or purse of the net. When the leads are all close together, the net is lifted from the water, and the fish in the tuck are taken out. The cost of a cast-net is regulated by the circumference and the size of the mesh. They may be had from 12s. to 30s. or more.

CASTING-VOTE—CASTLE.

CASTING-VOTE, the vote by which the chairman or president of a meeting is generally empowered to *cast* the balance on the one side or the other, where the other votes are equally divided. In the House of Commons, the Speaker does not vote at all unless this occurrence takes place. As his position in this respect is felt to be a delicate one for a person whose duty it is to withdraw himself from the contentions of party, it is usual for the Speaker to vote in such a way as to give the House an opportunity of reconsidering its decision. The same rule prevails in select committees. Following a similar rule, the chairman at corporation and general meetings usually gives his casting-vote either in a way that will lead to a reconsideration of the subject, or for what seems the popular view of the case, although that may be at variance with his convictions.

CASTLE (Sax. *castel*; Lat. *castellum*, dimin. from *castrum*), a building constructed for the purpose of repelling attack. The root of the word is the same as that of *casa*, a little house or hut, and probably means a driving off or repelling; and it is worthy of notice, in confirmation of this view, that in Welsh the radical syllable *cas*, signifies a C., separated, and also hatred, malice, &c. The *castella*, left by the Romans in Britain and elsewhere, were constructed on the general model of their stationary encampments (*castra stativa*), (see **CAMP** and **ENCAMPMENT**); and though they may have suggested the castles of the middle ages, they differed from them in being designed for military purposes only, and not also as places of permanent residence. Even Burgh Castle, in Suffolk, the ancient Garamonium, and Richborough Castle, in Kent, the ancient Rutupia, were encampments or fortresses, rather than castles. The accompanying ground-plan, taken from Mr Roach Smith's interesting work on the *Antiquities of Richborough* and other places in Kent,

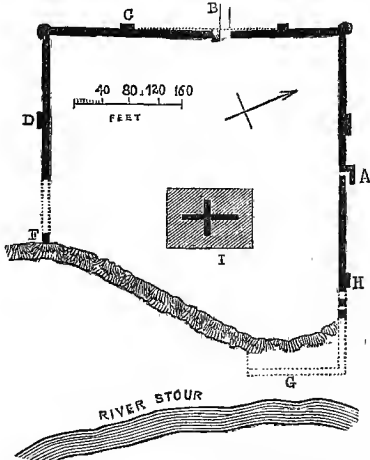

Plan of Roman Castrum at Richborough :

A, postern gate; B, decuman gate; C, D, square towers; F, corner of south wall projecting over the cliff; G, return wall overthrown; H, site of tower in north wall; I, surface of subterranean building.

will give a better conception than any mere description of the remains of the most remarkable Roman castellated fort to be found in this country.

Besides these monuments of the military occupation of the island by the Romans, traces are found in various parts of the country of encampments or

castles, which are ascribed to its aboriginal or early inhabitants. These are generally situated on the tops of hills; as, for example, the Herefordshire Beacon, on the Malvern Hills; Moel Arthur, in Flintshire; Chem Castle, in Cornwall; the Maiden Castle, in Dorsetshire; the Caterthuns, near Brechin, in Forfarshire; the Barnkin of Echt, in Aberdeenshire. It is probable that the Saxons adapted the Roman castles to a certain extent to their modes of defence, and traces of Saxon, and even Norman workmanship are found in structures which are



Roman Castellum.—From Vatican Virgil.

believed to have been originally Roman. One very frequent change consisted in raising a mound of earth on one side of the walls on which the keep or citadel was erected. The Decuman and Prætorian gates were also, as at Portchester, converted into the fortified entrances peculiar to the castellated structures of the middle ages. But of castles designed for residence as well as defence, there are few or none which are of higher antiquity than the Conquest. They were part of the organisation of the feudal system—castle-guard being one of the duties which the tenants were taken bound to pay in return for their lands; and till that system was developed by the Normans, the residences of persons of importance were probably guarded only by their domestic retainers, or, in extraordinary circumstances, perhaps by the national militia. The absence of strongholds is said to have been a reason why William the Conqueror so easily became master of the kingdom; and it was as a protection against the resentment which the Conquest occasioned, that most of the great Norman castles of England were built. As these castles grew in strength by the additions and improvements of each generation, they afforded their possessors the means not only of security from their fellow-subjects, but of independence as regarded the central government. The lord of every C. became a petty tyrant; and no small portion of the history of England, and, indeed, of Europe altogether, during the feudal period, consists of an account of the attempts which were made by the monarch to extirpate what Matthew Paris has emphatically designated as 'these nests of devils and dens of thieves.' Of castles of this description, it is said that in England, in the reign of Stephen (1135—1154), no fewer than 1115 were built.

The Norman C., which was the most complete structure of the kind, was generally surrounded by a moat or ditch; and in order that the ditch might be readily filled with water, the site chosen was usually either on the banks of a river, or on a peninsula running into a lake. In the latter case, the ditch was of course merely a deep cut made through the neck of land, by means of which the C. and its surroundings were converted into an island. On the inner side of the ditch, mounds

CASTLEBAR—CASTLES.

were constructed, which were surmounted with walls and towers, both of which, but particularly the latter, were supplied with battlements and bastions. The entrance-gates were also protected by towers, which were usually of great strength. The communication was by a bridge, sometimes of stone, but usually of wood, which was made to draw up and down; and the entrance, in addition to thick folding-doors, was protected by a Portcullis (q. v.), which was dropped down through grooves in the masonry at the sides. The gateway, in castles of the larger sort, was further defended by a Barbican (q. v.). On passing the external wall, you entered the Bailey (q. v.), which sometimes consisted of several courts, and contained the barracks, magazines, well, a chapel, and sometimes even a monastery. The only portion of the C. which was always spoken of as distinguished from the bailey, was the Keep (q. v.) or citadel, which corresponded to the pratorium of the Roman fortification. The keep was a species of internal C., more strongly defended than any other portion of the fortress, and placed in the most advantageous position, so as to afford a last chance to the garrison when driven from the external works. As the keep had the same design as the C. itself, it contained most of its appliances, even to a chapel, when large and complete. Under the keep was the Dungeon (q. v.). An excellent example of a keep is seen at

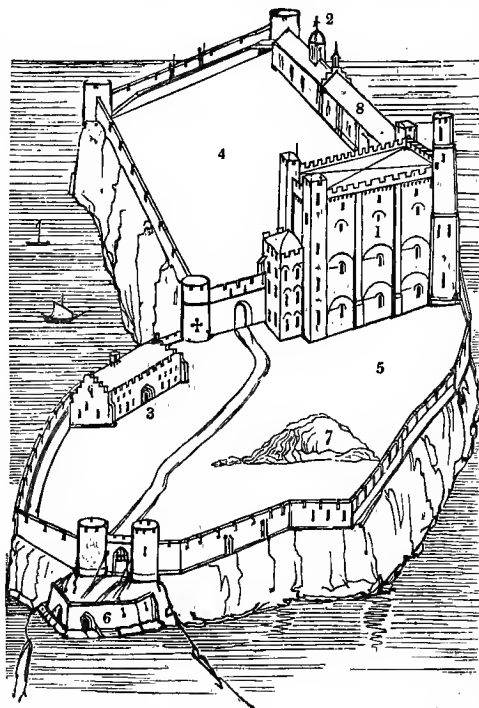

A NORMAN CASTLE.—From an Ancient Drawing published in *Grose's Military Antiquities* :

1. The Dungeon; 2. Chapel; 3. Stable; 4. Inner Bailey; 5. Outer Bailey; 6. Barbican; 7. Mount; 8. Soldiers' Lodgings. The Mount is supposed by Grose to be the Court-hill, where the lord dispensed justice, and where it was also executed.

Rochester Castle. The best known is probably that at Windsor, which forms so prominent an object in the surrounding landscape. The protection which

the walls of his C. afforded to the retainers of a baron, in a state of society in which life and property were extremely insecure, naturally led to the construction of houses around the moat, and to this custom a very large number of the towns, both in England and on the continent of Europe, owe their origin. Along the banks of the Rhine, this process of town-formation may be seen in all its earlier stages; from the few peasants' houses and the village church nestling under the ivy-covered ruin on the cliff, to the large and prosperous city of Coblenz. Strange as it may seem, the existence of these castles may be regarded not only as a cause, but as an effect of a certain feeling of security on the part of the surrounding population; for where a country was thoroughly insecure, the risk of the castles falling into the hands of the enemy, and thus proving a source not of protection but of oppression, was so great as to prevent their erection. It is on this ground that Sir Walter Scott explains the slight character of the fortresses on the Scottish border, notwithstanding centuries of warfare. 'It was early discovered that the English surpassed their neighbours in the arts of assaulting and defending fortified places. The policy of the Scotch, therefore, deterred them from erecting upon the borders buildings of such extent and strength, as being once taken by the foe, would have been capable of receiving a permanent garrison. To themselves, the woods and hills of their country were pointed out by the great Bruce as their safest bulwarks; and the maxim of the Douglasses, that "it was better to hear the lark sing, than the mouse cheep," was adopted by every border chief.' For these reasons, 'we do not find, on the Scottish borders, the splendid and extensive castles which graced and defended the opposite frontier. The Gothic grandeur of Alnwick, of Raby, and of Naworth, marks the wealthier and more secure state of the English nobles.' The residence of the Scottish chieftain 'was commonly a large square battlemented tower, called a *keep* or *peel*, placed on a precipice, or on the banks of a torrent, and, if the ground would permit, surrounded by a moat. In short, the situation of a border-house, encompassed by woods, and rendered almost inaccessible by torrents, by rocks and morasses, sufficiently indicated the pursuits and apprehensions of its inhabitants.' —*Minstrelsy of the Scottish Border*, Introduction.

CASTLEBAR, the capital of the county of Mayo, Ireland, 159 miles west-north-west of Dublin. It is situated on the Castlebar river, near the head of a valley at the north-west end of the great limestone plain which includes the greater part of the counties of Roscommon, Sligo, Galway, and Mayo. The two main streets cross each other, and the chief buildings are in a square near the west end. The suburbs, as in most of the west Irish towns, consist of the wretched hovels of agricultural labourers. Pop. 4027. C. has some coarse linen manufactures. Here the Irish, in the rebellion of 1641, massacred the English parliamentary army, and in 1786 was executed the famous 'fighting Fitzgerald.' In 1798, the French general, Humbert, held the town for a fortnight. In 1846 and 1847, C. suffered extremely from the famine.

CASTLEBREA'GH, LORD. See LONDONDERRY, MARQUIS OF.

CASTLES, in Heraldry, are often given as charges in the shields of persons who have reduced them, or been the first to mount their walls in an assault. The practice of heralds, in this as in other respects, has not been very consistent, as we learn that in 1602, a castle was granted by William Cambden, Clarencieux King of Arms, to William Frear, doctor of physic!

CASTLETOWN, the capital town and seat of government of the Isle of Man, called in Manx *Ballej Cashal*, or the Town of the Castle. C. is situated on the margin of Castletown Bay, near the southern extremity of the island, and surrounds Castle Rushen, a Danish fortress of prodigious strength, having walls from 12 to 18 feet in thickness, built of the limestone found on the spot, which is of so imperishable a nature that the sharp angles of the keep retain the marks of the builder's chisel, though completed in the 10th century. The castle was founded by Guthred II. of the Orrys kings of Man, and having been added to from time to time, it now consists of a pile of building of a most imposing appearance. It underwent a six months' siege by Robert Bruce in 1313. The keep is used as the public jail of the island, and the other portion of the castle consists of public offices, officers' apartments, and accommodation for the chancery and other superior courts.

Being in the neighbourhood of the bold coast-scenery of the Calf of Man, Spanish Head, &c., C. is a desirable resort for the numerous tourists who frequent the Isle of Man. Ship-building has of late made considerable progress in Castletown. Population in 1851, 2501.

CASTOR and POLLUX, the two principal stars in the constellation Gemini (q. v.), were so called from Castor and Pollux, sons of Leda and Tyndareus, king of Lacedæmon. Their sister was the famous Helen of Troy. On account of their mutual attachment, Zeus placed them among the stars.

CASTOR AND POLLUX, the name given to a meteor, seen at sea, and which, under the form of twin balls of fire, attaches itself to the masts of ships. Sailors predict fair weather from its appearance. Sometimes, however, only one ball of fire is seen; the meteor is then called Helena, and it is regarded as foreboding a storm. Shakspeare makes mention of this superstition in the *Tempest* (Act i. Scene 2).

CASTOR OIL, a fixed oil obtained from the seeds of the C. O. plant. In extracting the oil, the seeds are first bruised between heavy rollers, and then pressed in hempen bags under a hydraulic or screw press. The best variety of oil is thus obtained by pressure in the cold, and is known as *cold-drawn* C. O.; but if the bruised and pressed seeds be afterwards steamed or heated, and again pressed, a second quality of oil is obtained, which is apt to become partially solid or frozen in cold weather. In either case, the crude oil is heated with water to 212°, which coagulates, and separates the albumen and other impurities. Exposure to the sun's light bleaches the oil, and this process is resorted to on the large scale. When pure and cold drawn, C. O. is of a light-yellow colour; but when of inferior quality, it has a greenish, and occasionally a brownish tinge. It is somewhat thick and viscid. Its specific gravity is high for an oil, being about 960 (water being taken as 1000). It is miscible with alcohol or spirits of wine and ether. Reduced to a temperature of 0° F., it does not become solid; but exposed to the air, it very slowly becomes rancid, then dry and hard, and serves as a connecting-link between the drying and non-drying oils. It has a nauseous smell, and an acrid, disagreeable, and sickening taste, which may be overcome by the addition of a little magnesia. The principal acid present in it is *ricinic acid* ($\text{HO}, \text{C}_{26}\text{H}_{52}, \text{O}_6$), which is allied to oleic acid.

C. O. is one of the most convenient and mildest of purgative medicines. Given in doses of one or two tea-spoonfuls, with a little peppermint-water, it forms a gentle laxative for habits easily acted

on by medicine; while a dose of a table-spoonful, or a little more, will almost always succeed if it remains on the stomach. The only serious objections to the use of C. O., are its disagreeable flavour, and the sickness often produced by it; some persons get over this difficulty by floating the oil in hot coffee, which is said to remove its nauseous quality.

The adulterations of C. O. may be various. Several of the fixed oils, including lard, may be employed. The best test of its purity is its complete solubility in its own volume of absolute alcohol, which other fixed oils are not. Croton oil is occasionally added, to increase the purgative powers of the oil.

The CASTOR-OIL PLANT (*Ricinus communis*) is a native of the south of Asia, but now naturalised in the south of Europe, and in other warm regions of the globe. The genus *Ricinus* belongs to the natural order *Euphorbiaceæ*. It has panicled flowers, with 3-5-partite perianth; the fruit a tricoccus capsule, with one seed in each cell, the outside of the capsule generally covered with soft spines. The castor-oil plant is often cultivated in gardens in the middle, and even in the northern parts of Europe, where it is only an annual, attaining a height of 3-10 feet, but highly ornamental by its stately growth, its large, broad, palmato-peltate, 7-9-fid leaves, $\frac{3}{4}$ -2 feet in diameter, and its generally purplish hue. Its flowers are produced in long glaucous racemes. In warmer climates, it is perennial,



Castor-oil Plant:

a, end of a branch, with leaves and flowers; b, a capsule.

and its stem becomes arborescent, attaining even 30 feet in height, with a corresponding thickness, so that ladders are used for climbing it. Different species which have been described, are probably mere varieties. It was known to the ancients, and appears to have been valued by them. Its seeds have been found in Egyptian sarcophagi. From the resemblance of its seeds to an insect called *ricinus*, it received that name from the Romans. The seeds are oval, and about four lines long. They are chiefly valued for the oil which they yield, on account of which the plant is cultivated in the Levant, Spain, Provence, the West Indies, Brazil,

the United States of America, as far north as New Jersey, and in other tropical and warm temperate countries.—Although castor oil is chiefly used in medicine, it is not unfit for lamps and for oiling the wheels of machinery. The streets of Lima are lighted, and the machines used in the works of the sugar-plantations of Peru are oiled with it. The appearance of the castor-oil plant obtained for it the name of *Palma Christi*, by which it is still sometimes called. Its seeds were formerly known as *semina calapubica majoris*.

CASTOREUM, a substance secreted in two glandular sacs, closely connected with, but quite distinct from, the organs of reproduction in the Beaver (q. v.), and at one time held in the highest repute in medicine, although now regarded as almost inert, and chiefly used by perfumers. The C. sacs are pear-shaped, and it appears in commerce in these sacs themselves, connected in pairs as they are taken from the animal. C. is produced both by the male and by the female beaver. In Hudson's Bay commerce, ten pair of them are equal in value to one beaver skin. Russian C. is of much higher value than American. C. was well known to the ancients. From the time of Hippocrates, it was regarded as having a specific influence over the uterus, and is still in use in the north of Europe. It was at one time also esteemed a most valuable medicine in hysteria, catalepsy, and other spasmodic diseases.

CASTORIDÆ, a family of *Mammalia*, of the order *Rodentia*, of which the Beaver (*Castor*) is the type, and in which besides the beaver, the Coypu (*Myopotamus*), and the *Musquash*, some naturalists include other genera more commonly regarded as belonging to the Mouse and Rat family (*Muridæ*), as the Lemmings and Voles.

CASTRAMETATION is the art of encamping; and a *camp* is the result of that art. See **CAMP**, **ENCAMPMENT**.

CASTREN, MATTHIAS ALEXANDER, the greatest authority in regard to the Finnish people and language, was born in 1813, not far from the Lappish boundaries of Finland. He received his earliest instruction in the town of Tornea, and afterwards studied at Helsingfors. About the year 1838, he undertook a pedestrian excursion through Finnish Lapland, in order to extend his knowledge of the language and literature; and, in 1840, another through Carélia, to collect ballads, legends, &c., illustrative of Finnish mythology. On his return, he published in Swedish a translation of the famous Finnish poem, *Kalevala*, the metre and style of which have been imitated by Longfellow in his poem of *Hiawatha*. Aided by the government of his native province, he commenced his researches among the Finnish, Norwegian, and Russian Laplanders, as also among the European and Siberian Samoyeds. Appointed linguist and ethnographer to the St Petersburg Academy, C. between the years 1845 and 1849, prosecuted his laborious investigations as far east as China, and as far north as the Arctic Ocean. On his return, he was appointed first professor of the Finnish language and literature at the university of Helsingfors. He employed himself in preparing for publication the vast materials which he had collected, but died 7th May 1852, from exhaustion—a martyr to science. Before his death, appeared *Versuch einer ostjakischen Sprachlehre nebst kurzen Wörterverzeichnisse* (Petersburg, 1849), as the first instalment of his *Northern Travels and Researches*. He also wrote *Elementa Grammaticæ Syrjaenæ* (Helsingfors, 1844), and *Elementa Grammaticæ Tscheremissæ* (1845); *On the Influence of the Accent in the Lappish Language* (Petersburg, 1845);

De Affixis Personalibus Linguarum Alaicarum (Helsingfors, 1850), &c.

CASTRES, a town of France, in the department of Tarn, is situated on both sides of the river Agout, 46 miles east of Toulouse. The two parts of the town are united by two stone bridges. In the middle ages, C. was celebrated for its Benedictine abbey, the heads of which exercised a temporal sway over the place. Later, it was one of the strongholds of the reformed party, but it was forced to submit, and had its fortifications demolished in the reign of Louis XIII. C. has beautiful promenades, shaded by fine alleys of trees, and in the neighbourhood is a remarkable rocking-stone, 11 feet high, and weighing some 30 tons. It is of egg-shape, and rests upon its smaller end; a strong push is sufficient to cause its vibration. C. is a busy manufacturing place. Its fine wool-dyed goods are especially famous, and it has also manufactures of linen, leather, paper, soap, &c. Pop. 14,144.

CASTRI, or **KASTRI**, a village of modern Greece, in the government of Phocis, situated on the south declivity of Mount Parnassus, and worthy of notice, as occupying a portion of the site of the ancient Delphi (q. v.). The famous Castalian spring, now called the Fountain of St. John, is situated between 200 and 300 yards to the east of the village. Beside it grows a plane-tree, the only one in C., which is fabled to be that planted by Agamemnon.

CASTRO (ancient *Mitylene*), a seaport town of Asiatic Turkey, capital of the island of Mitylene, situated on the east coast, about 55 miles north-west of Smyrna. It is surrounded with walls, and defended by a castle, and its streets are narrow and dirty. Remains of the ancient town are found to the west. Pop. 6500.

CASTRO, INES DE, whose mournful fate is the subject of several tragedies and poems, was the daughter of Pedro Fernandez de Castro, and sprang from a branch of the royal family of Castile. She was appointed lady-in-waiting to the wife of Dom Pedro, son of Alfonso IV. of Portugal. Her beauty captivated Dom Pedro, and, after the death of his wife, in 1345, he secretly married Ines. Their stolen interviews took place in the convent of St. Clara, at Coimbra, until the secret was discovered and revealed to the king, who was made to believe that this union might prove injurious to the young Ferdinand, son of Dom Pedro by his deceased wife. Questioned by his father, Dom Pedro had not the courage to reveal the whole truth, while he refused to marry another. In the king's council, it was determined that Ines must die. To see this sentence executed, the king hastened to Coimbra, while his son, Dom Pedro, was engaged in hunting (1355); but the sight of the beautiful Ines, who, with her children, cast herself at the feet of the king, and prayed for mercy, diverted him for a few moments from his purpose. His advisers, however, soon obtained from the king permission to execute the sentence, and, in the course of an hour after the interview, Ines fell pierced by the daggers of assassins. Dom Pedro attempted a revolt against his father, but was pacified by the queen and the Archbishop of Braga, and promised not to seek revenge for the death of Ines. Two years afterwards, the king died, having shortly before his death recommended the murderers of Ines to leave Portugal, and seek shelter in Castile, where Peter the Cruel was then ruling. As several of Peter's nobles had escaped into Portugal, to avoid his oppression, he now proposed to Dom Pedro an exchange of fugitives; to which the latter (now king of Portugal) consented. Two of the assassins accordingly were delivered up, and were tortured and burned. Two

years afterwards, the king, in an assembly of the nobility, declared that he had been lawfully married, by papal sanction, and in the presence of the Archbishop of Guarda, to Ines de Castro. When this statement had been confirmed by several testimonies, the king gave orders that the corpse of Ines should be removed from its grave, clothed in royal attire, with a crown on the head, and seated on a throne, should receive homage as queen. This strange ceremony was performed, the nobles of Portugal bowing before the enthroned dead, and kissing the hem of the royal robe. The body was then removed to Alcobaca followed by the king, with the bishops and the nobility, all on foot. A splendid marble monument was erected over the grave of Ines, surmounted by her statue, wearing a crown.

CASTRO DEL RIO, a town of Andalusia, Spain, situated on a slope on the right bank of the Guadajocillo, 16 miles south-east of Cordova. A portion of the old town is surrounded by ruinous walls; the new town lying outside of these has some good streets. It has manufactures of woollen and linen fabrics, earthenware, &c., and considerable trade in agricultural produce. Pop. 9100.

CASTRO-GIOVANNI, a town of Sicily, in the province of Catania, is situated 13 miles north-east of Caltanissetta, on a remarkable fertile plateau, which rises precipitously to a height of 4000 feet above the sea-level. C. occupies the site of the ancient *Enna*, of which Ceres was the presiding goddess, and her most famous temple was here. The neighbourhood was the scene of Proserpine's abduction by Pluto. In connection with the Punio and Servile wars, Enna has a conspicuous part in early history. There are no remains of the old town. A castle and other buildings of Saracenic origin are still standing. The district yields sulphur to the amount of nearly 2500 tons yearly. Pop. 5000.

CASTRONUOVO, a town of Sicily, in the province of Palermo, 25 miles north of Girgenti. It is situated on a hill, is fortified, and in its vicinity are quarries of fine marble. Pop. about 6000.

CASTROVILLARI, a town of Naples, in the province of Calabria Citra, 34 miles north of Cosenza. It is situated on an eminence surrounded by mountains, is partially fortified, and has an old massive castle, and a trade in wine, manna, silk, &c. Pop. between 7000 and 8000.

CASTUEIRA, a town of Estremadura, Spain, 68 miles east-south-east of Badajoz. It is situated near the right bank of the Guadalefra, has several good streets, manufactures of brick, earthenware, &c., and a trade in agricultural produce; there is also some weaving carried on. Pop. 5600.

CASUAL POOR are persons temporarily relieved without being admitted to the roll of permanent paupers. See **POOR-LAWS**.

CASUALTIES OF SUPERIORITY, in the feudal law of Scotland, are such emoluments arising to the superior as depend on uncertain events. See **WARD-HOLDING**.

CASUARINA, a genus of trees of the natural order *Amentaceae*, and of the sub-order *Casuarineae*, which is regarded by some as a distinct natural order. The trees of this genus are almost exclusively Australian; one only, *C. equisetifolia*, being found in the South Sea Islands, the Indian Archipelago, the Malayan peninsula, and on the east side of the Bay of Bengal, as far north as Arracan. Some of them are large trees, producing timber of excellent quality, hard and heavy, the *Beef-wood* of the Australian colonists, so called from the resemblance in colour to raw

beef. *C. equisetifolia* is called in Australia the **SWAMP OAK**. It is a lofty tree, the *Toa* or *Aitoa* of the Society Islands, where it grows chiefly on the sides of hills, and where its wood was formerly used for clubs and other implements of war. It has been introduced into India, and is there much valued, as its wood bears a great strain, and is not readily injured by submersion in water. The hardness and durability of this wood led the earlier voyagers to the South Sea Islands to designate it *Iron Wood*. *C. quadricoloris* is the **SHE OAK** of New South Wales. **CASSOWARY TREE** is a popular generic name of the *Casuarinae*. Some of the species are scrubby bushes. All of them have a very peculiar appearance, their branches being long, slender, wiry, drooping, green, jointed, with very small scale-like sheaths instead of leaves. They resemble arborescent *Equisetaceae*. The fruit consists of hardened bracts, collected in a *strobilus*, or cone, and enclosing small winged nuts. The flowers have neither calyx nor corolla; the stamens and pistils are in separate flowers, the male flowers with only one stamen, the female flowers with a one-celled ovary, the male flowers in spikes, the female flowers in dense heads. More than 20 species are known.

CASUISTRY, called by Kant the *dialectics of conscience*, is that branch of theology and morals which professes to deal with very delicate moral questions—*casus conscientie*—and which supplies rules and principles of reasoning for resolving the same; drawn partly from natural reason and equity, and partly from the authority of Scripture, the canon law, councils, fathers, &c. C. has been, and still is, studied chiefly by Roman Catholic theologians; but at one period Protestant divines also paid some attention to the perilous science. The rudiments of it, however, are to be sought for in antiquity. Traces of it are found in the Stoic philosophers of ancient Greece. This is not to be wondered at, for C. is not, in its essence, a device of the schoolmen, although the latter elaborated it into a science, but a natural expression of the intellect and moral nature of man, when he is placed in circumstances of great perplexity. The sound and healthy reason of antiquity, however, could not enter into the morbid refinement, or rather the insidious corruption of morals found in certain Jewish and Christian writers. The *Talmud* (q. v.) contains an enormous accumulation of casuistical questions, while the sphere of Christian ethics in the middle ages often became a mere arena for unprofitable and pernicious disputations of this nature, as is seen in such works as the *Summa Raymundiana*, *Summa Astesana*, *Summa Bartholina*, which obtained their names from their respective compilers. At a later period, the Jesuits Molina, Escobar, Sanchez, Busenbaum, &c., became notorious for their abuse of ingenuity in the construction of moral puzzles, and for the flagrant immorality of their solutions. Some of them still 'suffer the vengeance' of Pascal's immortal satire. It is nevertheless indubitable, that in the life of every man—now as formerly—*casus conscientie* will at times arise, when the higher laws of morality come into collision with subordinate conventional ones. The dubiety as to what the path of duty is, what *ought* to be done, resulting from this collision, naturally and legitimately leads to many nice considerations. If these are carried on under the guidance of a pure conscience, no harm can ensue, but, on the contrary, much good. Such, however, is not the *perverted* C. of the Jesuits, 'the art of quibbling with God,' as M. Le Fevre, preceptor to Louis XIII., called it, in which a man seeks to justify, by subtle quirks, his immoral actions. Mayer has published an

account of all the writers on cases of conscience, ranging them under three heads—Lutheran, Calvinistic, and Romish.

CA'SUS BELLII, or a case of war, is the reason alleged by one power for going to war with another. It is found impossible to reduce these causes or reasons to any definite code, because an ambitious or aggressive power has no difficulty in making a reason to declare to others, without acknowledging the real reason.

CAT (Lat. *catus*), a name sometimes extended to the whole family of quadrupeds designated by zoologists *Felidae* (q. v.), the genus *Felis* of Linnaeus; and sometimes more restrictedly applied to a section of that family, containing a number of its smallest species, the domestic cat and species most nearly allied to it. These form the subject of the present article. They all pursue their prey on the branches of trees more than on the ground, and are most expert climbers, in which, however, they are rivalled by some of the other *Felidae*.

The origin of the domestic C. is by no means well ascertained; and by some naturalists it is described as a distinct species, under the name *Felis domestica*, which perhaps may be regarded as at least a convenient provisional designation, until satisfactory reasons can be adduced for referring it to some species existing in a wild state. By many, indeed, the domestic C. has been confidently pronounced to be a mere domesticated variety of the common Wild C. (*Felis Catus*) of Europe and the north of Asia; but to this there are many objections; the most important being that it is always of smaller size, contrary to what is usually observed of the effects of domestication in animals; and that in cats of the domesticated race which have run wild, and in their known progeny, there is no appearance whatever of a tendency to return to the type of the true wild cat.—Another opinion as to the origin of the domestic C. has obtained the assent of a considerable number of naturalists; that it is derived from the *Felis maniculata*, or Gloved C. of North Africa, a species discovered by the celebrated traveller Ruppell. But Mr Owen has stated a perfectly conclusive reason against identifying the domestic C. with the *Felis maniculata*, that the first deciduous molar tooth in the latter has a relatively thicker crown, and is supported by three roots, whilst the corresponding tooth both of the domestic C. and of the wild C. of Europe has a thinner crown, and only two roots.

The certainty, however, that the C. existed as a domestic animal in ancient Egypt, makes it not improbable that we ought to look for its original on the banks of the Nile, or in some of the countries from which the ancient Egyptians might most readily have obtained it. Of its rarity in Britain in former times, when the wild C. was common in all the woods which covered so much of the island, a curious evidence is afforded by a Welsh law quoted by Pennant—a law of the reign of Howel the Good, who died in 938 A. D.,—fixing the prices of cats according to their age and qualities, beginning with a price for a kitten before it could see, and enacting that if any one stole or killed the C. that guarded the prince's granary, he was to forfeit a milk ewe, its fleece and lamb; or as much wheat as when poured on the C. suspended by its tail, the head touching the floor, would form a heap high enough to cover the tip of the tail.

It is needless to describe an animal so well known as the domestic C., or to do more than allude to its purring, its mewling, and the other sounds which it makes, its aversion to wet its feet or fur, its love of heat and comfort, its stealthy manners when in

quest of prey, its patient watchfulness, so often fatal to mice, and other points of its natural history with which everybody is familiar.

The delight which a C. takes in tormenting a mouse before killing it, has sometimes been mentioned as an apparent exception to the general character of goodness manifest in the instincts of animals. It is an interesting circumstance, however, that when the prey is a bird instead of a mouse, a C. immediately inflicts a mortal wound, as if aware of its greater power of effecting its escape.

The eye of the C. is capable of much contraction and dilatation of its pupil, so that the animal can see in a very feeble light, and is thus adapted for those nocturnal habits to which, even in domestication, it shews so strong a natural tendency.

The fur of the C. is very free from any oily substance, so as to be readily injured by water, and is capable of being rendered highly electric by friction, particularly in very dry or frosty weather. An electric spark is readily obtained from the tip of the ear.

The strong statements of Buffon gave for a time great currency to the opinion, that the C. is incapable of affection, and retains, even in a domesticated state, its savage ferocity, merely restrained by selfishness, and disguised by cunning. The belief is very prevalent that the C. forms an attachment to places only, and not to persons. There are, however, well-authenticated stories which prove the C. to be capable of strong attachment to its master or mistress, although this quality is less frequently and remarkably displayed than by the dog. The instances which have, on the other hand, been recorded to shew the attachment of the C. to places, are well worthy of attention in connection with the subject of instinct in animals. Some of these instances of cats finding their way back from great distances to their former home, are very wonderful, and indeed cannot be explained on any grounds or principles known. The same instinct and power, however, are displayed by other animals.

The varieties of the domestic C. are neither numerous nor very different. The *Tortoise-shell C.* differs from the most common variety chiefly in colour, although it is also particularly elegant and delicate in form. It is much more common in the south of Europe than in Britain.—The *Angora C.* is a beautiful variety, remarkable for its long silky hair.—The *Chinese C.* has a fine glossy fur, and is remarkable for its pendulous ears.—The *Chartreuse* is of a bluish colour.—It is supposed that the *Tabby* may have undergone less change by domestication than any other variety.

The wild C. is still to be found in a few of the woods of the north of England, in the mountains of Wales, the Highlands of Scotland, and some parts of Ireland. It has entirely disappeared from districts where it was once common. It is the only beast of prey remaining in Britain the strength and fierceness of which make it at all dangerous to man; but an encounter with a wild C. is safe only to a man well armed. Fortunately, the instances of its attacking when unmolested are rare, but such instances have occurred. The wild C. is an inhabitant of deep thickets and recesses of woods, and of the rocky and bushy ravines of mountainous districts. Its fur is held in considerable estimation. The fur is soft, long, and thick. The colour of the face is yellowish-gray, with a band of black spots towards the muzzle; the forehead is brown; the head is gray, with two black stripes passing from the eyes, over and behind the ears; the back, sides, and limbs are gray, darker on the back, paler on the sides, with a blackish longitudinal stripe along the middle of the back, and numerous paler curved

ones on the sides; the tail is ringed with light-gray and black, the tip being black. The length of a medium-sized male wild C. is almost 2 feet, exclusive of the tail, but this length is sometimes very considerably exceeded.—We know no record of any attempt to domesticate the wild cat.



Wild Cat.

The animal often called wild C. in America is the Bay Lynx. See LYNX.

Superstitions regarding Cats.—Cats have been objects of superstition from the earliest ages. In Egypt, they were held in the highest reverence; temples were erected in their honour; sacrifices and devotions were offered up to them; and it was customary for the family in whose house a C. died to shave their eyebrows. In the middle ages, they were regarded as the familiars of witches. The favourite shape of Satan was said to be that of a black C.; and the animal was an object of dread instead of veneration. There is or was a belief among sailors, that the frolics of a C. at sea portended a storm. Many people still prophesy rainy weather from a C. washing its face; and a cat-call on the house-top was formerly held to signify death. Their superstitious connection with witches, and the foolish belief that a C. has nine lives, have led to the perpetration of great cruelties upon this harmless and very useful domestic animal. See Brand's *Popular Antiquities*, Ellis's revised edition.

CAT, on shipboard, is a name for many of the ropes or lines employed. A *cat-fall* is a rope for heaving up the anchor from the water's level to the bow; it works through *cat-blocks*, and is connected with the *cat-head*. *Cat-harpings* are small ropes for tightening the shrouds. The *cat-heads*, just named, are two strong short timbers projecting from the bow, on each side of the bowsprit. A *cat-hook* fastens the ring of the anchor to the cat-block.

CAT, or CAT-CASTLE, in the military engineering of the middle ages, was a kind of movable tower to cover the sappers as they advanced to a besieged place. The garrison sometimes poured down burning pitch and boiling oil from the walls upon the C.; but occasionally this stratagem was disastrous, for the besiegers availed themselves of the blazing tower to burn the wooden gates of the town or fortress.

CAT-O'-NINE-TAILS. See FLOGGING.

CATABRO'SA (Gr. *catabrōsis*, a gnawing), a genus of grasses formerly included in *Aira* (see HAIR-GRASS), but distinguished by the leathery *palææ*, which are ribbed, truncated, erose (as if gnawed at the points), awnless, and nearly equal. The glumes are much shorter than the spikelets,

membranaceous, and very obtuse. The general appearance is different from that of the genus *Aira*.—*C. aquatica* is a pretty common British grass. It is of very wide geographic and climatic



Catabrosa aquatica :

a, panicle; b, part of stem, with roots and leaves; c, a spikelet; d, glume.

range, being found throughout Europe, from Lapland to the Mediterranean, and also in the torrid regions of South America. It grows only in very moist situations, as the muddy margins of lakes and rivers, ditches, &c., and is only cultivated in irrigated meadows, or on the banks of rivers subject to be overflowed by high tides, where the ground is always wet and muddy. It is one of the most valuable grasses for such situations, its foliage being peculiarly sweet, and much relished by cattle. Both its foliage and its seeds, also, afford much food to water-fowl, and to some kinds of fish, particularly carp. Its leaves often float, and its stalks seldom rise, more than a foot or fifteen inches above the surface of the water. It has a stiff branching panicle, with whorled spreading branches, and its seeds are small. When its artificial propagation is attempted, it is more frequently by dropping freshly gathered stems into still waters, or scattering them on the mud, than by sowing the seeds. It is sometimes called WHORL GRASS, and sometimes SWEET WATER GRASS.

CATACOMBS (Gr. *kata*, and *kumbos*, a hollow), subterraneous chambers and passages formed generally in a rock, which is soft and easily excavated, such as *tufa*. C. are to be found in almost every country in which such rocks exist, and, in most cases, probably originated in mere quarries, which afterwards came to be used either as places of sepulture for the dead or as hiding-places for the living. The most celebrated C. in existence, and those which

are generally understood when C. ars spoken of, are those on the Via Appia, at a short distance from Rome. To these dreary crypts it is believed that the early Christians were in the habit of retiring, in order to celebrate their new worship, in times of persecution, and in them were buried many of the saints and martyrs of the primitive church. They consist of long narrow galleries, usually about 8 feet high and 5 wide, which twist and turn in all

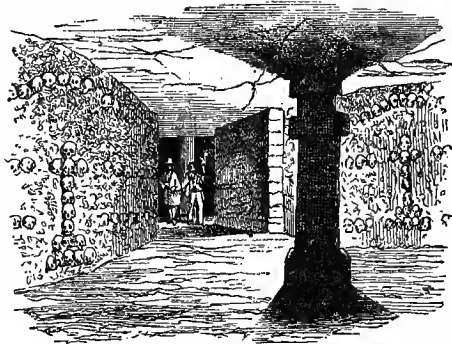

Interior of one of the Catacombs of Paris.

directions, very much resembling mines. The graves were constructed by hollowing out a portion of the rock, at the side of the gallery, large enough to contain the body. The entrance was then built up with stones, on which usually the letters D. M. (Deo Maximo), or X.P., the first two letters of the Greek name of Christ, were inscribed. Other inscriptions and marks, such as the cross, are also found. Though latterly devoted to purposes of Christian interment exclusively, it is believed that the C. were at one time used as burying-places by pagans also. At irregular intervals, these galleries expand into wide and lofty vaulted chambers, in which the service of the church was no doubt celebrated, and which still have the appearance of churches. The original extent of the C. is uncertain, the guides maintaining that they have a length of 20 miles, whereas about 6 only can now be ascertained to exist, and of these, many portions have either fallen in or become dangerous. When Rome was besieged by the Lombards in the 8th c., many of the C. were destroyed, and the popes afterwards caused the remains of many of the saints and martyrs to be removed and buried in the churches. Art found its way into the C. at an early period, and many remains of frescoes are still found in them. The C. at Naples, cut into the Capo di Monte, resemble those at Rome, and evidently were used for the same purposes, being in many parts literally covered with Christian symbols. In one of the large vaulted chambers there are paintings, which have retained a freshness which is wonderful, when the influences of time and the dampness of the situation are taken into account. The palm-tree, as a memorial of Judea, is a prominent object in these pictures. At Palermo and Syracuse there are similar C., the latter being of considerable extent. They are also found in Greece, in Asia Minor, in Syria, Persia, and Egypt. See NECROPOLIS. At Milo, one of the Cyclades, there is a hill which is honey-combed with a labyrinth of tombs running in every direction. In these, bassi-relievi and figures in *terra cotta* have been found, which prove them to be long anterior to the Christian era. In Peru and other parts of South America, C. have been discovered. The C. in Paris

are a species of charnel-houses, into which the contents of such burying-places as were found to be pestilential, and the bodies of some of the victims of 1792, were cast by a decree of the government.

CATAFALCO (Ital. a scaffold), or CATAFALQUE, a temporary structure of carpentry, intended to represent a tomb or cenotaph, and adorned with sculpture and painting. It was employed in funeral ceremonies. The most magnificent C. ever made, perhaps, was that used at the interment of Michael Angelo, at Florence.

CATALANI, ANGELICA, a highly celebrated Italian singer, born at Sinigaglia, in the States of the Church, some say in 1780, others in 1784, educated in the convent of St Lucien, near Rome, where, in her seventh year, she displayed such wonderful vocal powers that strangers flocked from all quarters to hear her. She made her first public appearance at Venice, in her 16th year, and experienced a succession of triumphs in every country in Europe for more than 30 years, amassing immense sums of money. The Italian Opera in Paris was twice under her direction; but her husband's interference and extravagance brought her into much trouble. Her large queenly person and fine countenance, the immense volume, range, and flexibility of her voice, her power of sustaining her notes, in contrast with the lightness and facility of her unerring execution, everywhere took her audience by storm. Her expression, although fine, and her whole style, surprised rather than touched the heart. In concert-singing, her great triumphs were in Rhode's Air with variations, and *God Save the King*—which she would call *shave*; and in Oratorios, Luther's Hymn, her delivery of which, especially when her marvellous voice alternated with the trumpet's sound, was so sublimely awful, that the audience were hushed and pale, and some were borne away fainting. The throat from which these wondrous sounds proceeded was physically of such dimensions, that a physician, when called to look into it, declared he could have passed down a penny-loaf! In 1830, Madame C. purchased a villa near Florence, formerly belonging to the Medici family, where she gave free instructions to girls who had a talent for singing, on condition of their taking the name of Catalani. In the spring of 1849, when political disturbances broke out in Tuscany, she repaired with her daughters to Paris, where she died of cholera on the 13th of June.

CATALAUNIAN PLAIN (*Campi Catalaunici*), the ancient name of the wide plain surrounding Chalons-sur-Marne, in the old province of Champagne, France, celebrated as the field of battle where the West Goths, and the forces under the Roman general Aëtius, gained a great victory over Attila in 451 A.D. A wild tradition (made the subject of a striking picture by Kaubach, 'Die Hunnenschlacht, or The Battle of the Huns') tells that three days after the great fight, the ghosts of the fallen myriads appeared on the plain, and renewed the conflict.

CATALDO, SAN, a town of Sicily, in the province of Caltanissetta, and 5 miles west of the town of that name. There are productive sulphur-mines in its vicinity. Pop. 8900.

CATALEPSY (*katalepsis*, a taking possession of), a state of more or less complete insensibility, with absence of the power of voluntary motion, and statue-like fixedness of the body and limbs in the attitude immediately preceding the attack, a like position being also retained, unless altered by force, until the return of consciousness. Such is the abridged description of C., as commonly given in works of authority. The patient is usually in good

health at the time of seizure, or subject only to nervous affections, such as hysteria (q. v.); sometimes the attack is preceded by disappointment, fear, violent exciting or depressing passions, or even religious emotions, being in such cases only an extreme form of what is otherwise called trance, reverie, or ecstasy (q. v.); on other occasions, the apparent cause is more purely physical, as in some of the hysterical cases, depending on suppressed menstruation. In all cases of cataleptic rigidity and insensibility, it may be presumed that the brain, as the organ of consciousness, is disturbed; but it does not appear that in any considerable proportion there is structural disease. Patients rarely die during the attack, which may, however, be protracted for an indefinite period, and may even endanger life indirectly by the debility consequent on imperfect nourishment. The circulation and respiration are, in most instances, little affected; cases, however, have been recorded in which, in consequence of their failure, the patient has been supposed to be dead. See DEATH, APPARENT. Many of the recorded cases of C. are little worthy of credit, and it has even been doubted whether this curious disease can ever be said to exist except as the result of some degree of deception, or at least voluntary and conscious regulation of the muscles on the part of the person affected. The combination of C. with hysteria, and its frequent association with what are called the higher phenomena of mesmerism (q. v.), are undoubtedly circumstances of great suspicion; but it would certainly be wrong to suppose that all the cases described were fictitious, and not less so to classify them all under the head of pure imposture. Epidemic C. has been described, and in such cases it would appear plain that the principle of imitation, so powerful in producing nervous disease, must have been at work. The remedies of C. are the same as those of the states to which it is so nearly allied, and of which it may be said to form a part. Moral means form a large part of the treatment, as in hysteria. In some cases, it may become necessary to administer food by means of the stomach-pump, and this even for weeks or months. We have seen such a case end in complete recovery.

CATALOGUE (Gr. a list). See BIBLIOGRAPHY, BRITISH MUSEUM, LIBRARY, STARS.

CATALONIA (Spanish, *Cataluña*), an old province and principality of Spain, now divided into the provinces of Barcelona, Tarragona, Lerida, and Gerona, the total area being 12,180 miles, and the population (1857), 1,735,420. C. occupies the north-eastern corner of Spain, having France on the north, and the Mediterranean on the east and south-east. It is watered by the Llobregat and the Ter, and by some of the affluents of the Ebro, the last-mentioned river having its embouchure in Catalonia. The coast is rugged, its boldest promontories being Capes Creus and San Sebastian, and its deepest indentations the Bays of Rosas and Tarragona. With the exception of a few low plains of limited extent, the soil of C. is that of a wild mountainous region formed by numerous offsets or terraces of the Pyrenees, one great ridge or series of ridges extending through the centre of the province.

The terraces, sloping abruptly down to the coast, or to the narrow coast plains, are divided by the valley of Llobregat into the lower and the upper Catalonian mountains.

The climate of C., though fog and rain are frequent, and extreme and rapid changes of temperature prevail, is on the whole healthy and favourable to vegetation. Near Barcelona, oranges flourish in the open air; the fields in some parts are bounded

by aloe-hedges, and olives grow on Montserrat. Cork-trees grow on the mountains, and thickets of thorn-apple, laurel, myrtle, pomegranate, box, rosemary, &c., extend where the cork has its limits. Northern upper C. has a more severe winter than the south; but everywhere, vineyards and olive-gardens cover the slopes, and cornfields extend in the valleys. Among the other products are hemp, flax, madder, barilla, and saffron. Hazel-nuts, a variety called Barcelona nuts, are extensively grown. Meadow-lands and pastures are comparatively rare, and horned cattle are, therefore, mostly confined to the districts bordering on the Pyrenees; while few horses and mules are kept; but sheep, goats, and swine are bred in considerable numbers. Silk-worms and bees are also reared. The coasts abound with fish, and game is plentiful. The minerals are coal, copper, manganese, zinc, lead, cobalt, salt, sulphur, and many varieties of marble.

C. is the principal manufacturing province of the kingdom—is, in fact, 'the Lancashire of Spain.' The inhabitants are neither French nor Spaniards, their language, costume, and habits being quite distinct from those of either; they have also local coins, weights, and measures. In energy, industry, and intelligence, they greatly surpass the rest of the Spaniards.

C., under the name of *Hispania Tarraconensis*, was one of the earliest, and remained among the last of the Roman provinces. It was invaded and captured by the Alans, who were followed by the Goths, hence its name, *Gothalania*, changed into *Gothalunia* or *Catalonia*. In the 8th c. the Arabs gained possession of the southern part. When Charlemagne, in 788, subjugated Spain as far as the Ebro, C. formed the central portion of the Spanish mark, governed by French counts, having Barcelona as their residence. They soon made themselves independent of France. In 1137, Earl Raymond Berengar, by his marriage, united C. with Aragon; and the marriage of Ferdinand and Isabella (1469) united both with Castile, and so C. became a portion of the Spanish monarchy, but never a very peaceable one. In modern times especially, it has been the scene of all the Carlist insurrections.

CATALYSIS (Gr. dissolution) is a term applied in Chemical Physics to a force supposed to be exerted by one substance upon a second, whereby the latter is subjected to change or decomposition, whilst the former, or acting substance, remains comparatively unaltered, and does not combine with it. The force, indeed, has been ascribed to the mere 'action of contact.' Fermentation is an example of this force (see BEER), when one part of yeast acting upon the sugar of the sweet worts, without entering into combination with it, compels 100 parts of sugar to pass into alcohol and carbonic acid. Germination, or the sprouting of grain when placed in the ground, is another example where one part of *diastase* changes 1000 parts of starch into sugar. No plausible theory has been brought forward to account for these changes, or to define what the force of C. is. Liebig has suggested, as an explanation, 'that a body in the act of combination or decomposition enables another body with which it is in contact to enter into the same state;' but this view does not explain C., as that force does not act in the majority of cases where changes are proceeding, and, moreover, the acting substance, while changing itself, never throws the body acted upon into the *same state of change*, but causes it to assume a new series of changes different from those pursued by itself.

CATALYSOTYPE, a name given by its inventor,

CATAMARAN—CATAPLASM.

Dr Wood, to a modification of the calotype process, upon the assumption that light set up a catalytic action (see CATALYSIS) among the ingredients employed. The paper is first washed with very dilute hydrochloric acid, to prevent the formation of yellow patches of insensitiveness, and then treated with syrup of iodide of iron containing a trace of free iodine; it is then partially dried between folds of blotting-paper, and sensitised by brushing over it a solution of nitrate of silver of ten grains to the ounce. Immediate exposure in the camera follows; after which, though no picture be visible at first, if it be allowed to remain in the dark for a period which varies with the length of time it was exposed, and the amount of light, a negative picture of great perfection is gradually developed. It is not necessary, however, for the explanation of this phenomenon, to assume that a catalytic action is set up, inasmuch as the ordinary chemical reactions are quite sufficient to account for it. As soon as *nitrate of silver* comes in contact with the moist *iodide of iron* with which the paper is first imbued, an interchange of elements takes place, *iodide of silver* is precipitated in the pores of the paper, and *protonitrate of iron* is diffused over the surface; and this latter salt is even a more energetic developing agent than the ordinary gallic acid, hence the seemingly spontaneous appearance of the picture. This process is so uncertain in its results, that it is seldom practised.

CATAMARAN is a raft formed of three planks lashed together, the middle one serving as a keel,



Indian Catamaran.

and the other two for the sides. The rower stands or kneels on the middle plank, and works a paddle. These simple vessels are used by the natives of Madras, to maintain communication between ships and the shore, ordinary boats being rendered unsafe by the surf. By the adoption of a similar construction on a larger scale, some of the catamarans are made large and strong enough to carry goods, and even artillery. Catamarans used in Brazil consist simply of three logs of wood tapered at the end and lashed together; they carry a sail.

CATANIA, or CATANEA, a city and seaport of Sicily, situated on the east coast, near the foot of Mount Etna, 31 miles north-north-west of Syracuse. The fertile and well-cultivated neighbourhood of C., extending along the south-east base of Mount Etna, is styled 'the granary of Sicily,' and has given to C. the title, 'La Bella Catania.' By eruptions of the great volcano and attendant earthquakes, the city has been several times almost entirely destroyed—especially in the year 1693; but out of its ruins it has always risen with increased beauty, and it is now the finest city in Sicily, being built throughout on a beautiful and consistent plan, from which no deviation is allowed. The harbour of C., formerly good, was choked by a stream of lava in 1693, and the mole was partly destroyed, so that now it has only a roadstead, which is guarded by a fort, and serves as a landing-place. It has several squares, the finest of which, in front of the cathedral, has a statue of an elephant sculptured in lava. Among

its chief public buildings are the Benedictine convent and church of San Nicolo, with one exception, the grandest structure of the kind in Europe; the town-hall; the cathedral, with its noble granite columns; and the university, founded in 1445. It has besides many handsome churches and convents, and several educational and charitable institutions, and is the seat of one of the three high courts in the island. The inhabitants, formerly much more numerous, now amount to about 55,000, and are distinguished by their commercial spirit and industry. C. has manufactures of silk and linen goods, and of articles in amber, lava, wood, &c. Among the remains of ancient times, that earthquakes have spared, are those of a theatre, an odeum, a temple of Ceres, Roman baths, and an aqueduct. C., anciently known by the name *Catana*, was founded by a Greek colony of Chalcidic origin, in the latter part of the 8th c. B. C.; and as early as the beginning of the 5th c. B. C., it was esteemed one of the most flourishing towns in Sicily. It was taken by the Athenians under Nicias, and was desolated by Dionysius I.; but again rose under the Roman sway into its former importance. Augustus here founded a Roman colony. It suffered at the hands of the Goths, but once more, under the Byzantine empire, became one of the principal cities in the island. C. gives name to the province of which it is the capital, and which is one of the richest in Sicily, with an area of 1743 square miles, and a population, in 1856, of 411,832.—C., GULF OF, an inlet of the Mediterranean, on the east coast of Sicily, extends in the form of a semicircle from La Trezza Bay to Cape Santa Croce, a distance of 18 miles. It is about 10 miles deep, and receives the river Giaretta.

CATANZA'RO, a city of Naples, in the district of Calabria Ultra II., is beautifully situated on the declivity of a rocky hill, near the Gulf of Squillace, and in the midst of a very fertile district. On account of its agreeable climate, many wealthy families have made it their residence. It has a cathedral, an old castle of the Norman period, a college, one of the largest, as it is one of the best conducted in the country, and is the seat of one of the four great civil courts of the kingdom. C. suffered very severely by an earthquake in 1783. It has manufactures of silk-velvet and woollen fabrics, and an active trade in agricultural produce. Pop. 13,600.

CATAPLASM (a Greek term for a poultice), an application to diseased or painful parts, for the purpose of promoting suppuration, relieving pain, and stimulating or soothing the skin, according to circumstances. A C. may be composed of any moist pulpy substance of sufficient consistence to retain the water without dripping or soaking through the thin muslin covering in which it is generally wrapped. The making of a poultice well is a matter of some nicety, and unless the proper consistence is given to the mass, the application is apt to do more harm than good. The linseed-meal poultice is the most easily made, and most satisfactory of all soothing applications. The meal is stirred gradually into a sufficient quantity of boiling water, placed in the bottom of a small basin or teacup, until a perfectly smooth pulp is formed of the proper consistence, and in quantity sufficient to cover completely, to the thickness of three-quarters of an inch, the whole pained part. The pulp is then folded up in muslin or thin calico, and applied as soon as the heat will permit it to be borne. The bread and milk, or even bread and water poultice, is also very good; as is also the oatmeal-porridge poultice, to which a little butter may be added with advantage. A spoonful

CATAPULTA—CATARACT.

or two of yeast may be added, if there are foul discharges, or peat charcoal may be sprinkled on the surface of the poultice before it is applied. Carrot poultices are in great favour with the people in some parts of the country. Hemlock poultices, made of the fresh leaves, or of the dried leaves, with the aid of some powder of the leaves, form a valuable sedative application in painful diseases; and poppy-heads, or even opium, are sometimes infused in the water of which a poultice is made, for the same purpose. A stimulating C. or poultice may be made by sprinkling oil of turpentine, or chloroform, or mustard in moderate quantity on the surface of any ordinary poultice. When considerable irritation of the skin in a short time is desirable, a mustard C. or sinapism (*sinapi*, mustard) is used.

CATAPULTA, an engine of war used by the ancients, somewhat resembling the crossbow. In the C., a string or rope, suddenly freed from great tension, gave a powerful impulse to an arrow placed in a groove. There were great catapults, fixed upon a

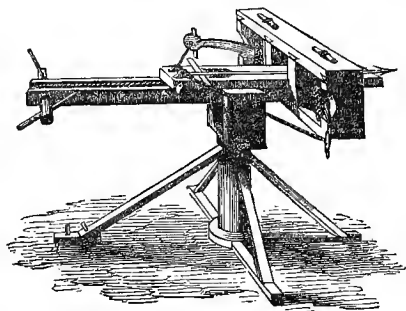

Catapulta.

scaffold with wheels, which were used in sieges, and small ones, carried in the hand, which were employed in the field. For a description of similar engines of ancient warfare, see articles BALISTA and ARBALEST.

CATARACT, an opaque condition of the lens of the eye. It is readily distinguished from opacities of the cornea, or clear front part of the eye, by its position just behind the pupil—that round and varying aperture in the iris through which light is admitted into the back of the eye. C. may affect the lens alone (lenticular C.), or the front or back of the capsule of the lens (capsular C.), or both lens and capsule (capsulo-lenticular C.). Its whiteness varies from that of half-boiled white of egg to that of snow. Heat will produce a like change on the lens out of the body, just as it changes white of egg from transparent to opaque. The rounded lens of the fish is seen at table in this opaque condition.

C. is painless, and unaccompanied by inflammation. It occasions blindness simply by obstructing the passage of the light; but C. alone does not produce so complete blindness but that the patient can tell light from darkness. It may occur at any age, but is most common in elderly persons, and is not unfrequent in children, who may be even born with it. The catoptric test, as it is called, is an ingenious method of distinguishing incipient C. from certain other deep affections of the eye. When a lighted candle is held before the eye of a person whose back is to the window, three candles are seen in the healthy eye. Two are erect—the large front one caused by the convex cornea, the smaller and fainter one behind by the convex front of the lens. The third, occasioned by the concave back of the lens, is in the middle; is small, bright, and turned upside down;

and, when the candle is moved, goes in the opposite direction, while the two erect images move with the candle. When the back of the lens becomes opaque, the inverted image is obscured or disappears; and when the front of the lens is affected, only the great front image, caused by the cornea, remains. This curious experiment may be tried on a large scale, by holding a common bi-convex lens a little way behind a watch-glass. Then, on greasing the back of the lens, to imitate C., the inverted image disappears, and on turning the lens round, all but the image in the watch-glass disappears.

No medical or other treatment has any influence in arresting the progress of C., nor can it be cured but by a surgical operation. A clever imposture used to be practised by quacks. By applying belladonna to the eye—as the surgeon does when he wishes to dilate the pupil for an examination or operation—some little light was temporarily admitted through the less opaque edge of the lens. The patient beginning to see somewhat better, after long and increasing dimness of vision, began to congratulate himself on a cure; the quack, of course, hastened to get his money without waiting for the further result, which was sure to be blank disappointment. So long as there is fair vision with one eye, the operation on the other may be delayed. It is a mistake to delay the operation in children on account of their tender age. The sooner it is done the better, both for the eye and the education of the child.

Three methods of operation are practised. 1. For *absorption* or solution. This is suitable for children, in whom the C., like the natural lens, is soft, and in all other cases in which there is reason to suppose that the C. is soft. An appropriate needle is passed through the cornea; made to open and lacerate the front of the capsule, the rags of which curl out of the way behind the iris, so that their subsequent opacity does not obstruct the light; then the soft cataractous lens is punctured and picked so as more effectually to admit the aqueous humour, which naturally fills the space between the lens and the cornea, and which has the remarkable property of absorbing or dissolving the lens or cataract when admitted within the capsule. This operation may require to be repeated several times, at intervals of a few weeks, before the whole C. is dissolved. 2. *Displacement*. A needle is passed through the fore part of the white of the eye, until it is seen through the upper part of the pupil, lying across the front of the upper part of the lens. This is now pressed back, so as to make the lens sink down and back into the vitreous humour, when it is either slowly absorbed, or may in part permanently remain. The older method of displacement, termed *couching*, in which the lens was pushed more directly downwards, is now abandoned, as more likely to press on the retina, and cause subsequent evil to the eye. 3. *Extraction*. Half the cornea, through nearly its whole breadth, is divided with Beer's knife, an operation requiring great skill; the front of the capsule is opened, and disposed of with a needle; and the lens is gently assisted out of its place, through the pupil, and out of the opening in the cornea, great care being taken not to allow the vitreous humour to follow. Displacement and extraction are both applicable to hard cataracts, the form it generally takes in old age, as the lens itself becomes naturally harder with age, as well as more flat and amber-tinted. Displacement is more likely to be followed by bad consequences, some time after, from the presence of the displaced lens, while the risk of extraction is greater at the operation. The surgeon must decide which is best for each case. Though not so simple and successful

as the operation for absorption through the cornea for soft C., displacement and extraction are generally very successful in restoring vision. The place of the lens is supplied by fluid humour, the refracting power of which is nearly equal to that of the lens, and the restoration of vision may be perfect. All of these operations require minute anatomical knowledge (see EYE), and great nicety and skill in the use of the instruments.

CATARRH (Gr. *katarreo*, I flow down), a disease of great frequency in temperate latitudes, especially in changeable moist climates in the winter season. From its well-known connection with sudden falls of temperature, and other epidemic or atmospheric causes (see INFLUENZA), as also from the chill often experienced at the commencement of the disease, it is popularly called a cold—a term, however, perhaps somewhat less definite in its meaning than C., which word is usually restricted to the case of a cold affecting the chest, and attended with discharge of mucus by coughing. A 'cold in the head' is termed, in strict scientific language, *Coryza*; we shall, however, keep both forms in view in the present article. C., or cold, commonly begins with a feeling of chilliness, which may or may not be attributable to external causes. Sometimes this is absent, there being only a sense of languor and indisposition; not unfrequently there is no sensation of an unusual kind, until a stuffing is experienced in the nostrils, or severe headache, or hoarseness with cough, or oppression of the breathing. The regular form of a cold is to attack the nostrils first, and afterwards the air-passages leading to the chest. When it habitually attacks the chest, without running through its ordinary course as indicated above, there is often some special cause of delicacy in the lungs, or some constitutional tendency towards consumption (q. v.). The discharge is in the beginning watery, becoming afterwards more abundant, glairy, and of yellowish colour; the early stages of the disease are attended by considerable irritation of the surfaces affected, and probably no one of the little miseries of life is more prostrating and discouraging for the time than a bad cold in the head. The tendency of C. to attack the chest, and thus to pass into Bronchitis or Pneumonia (q. v.), or to lay the foundation of tubercular disease, constitutes almost its only danger. See CHEST, DISEASES OF.

The treatment of a cold is commonly a simple matter, so far as the particular attack is concerned. Confinement to the house, and, in severe cases, to bed, or to the sofa, for a day or two; a warm hip or foot bath, to remove the chill; light farinaceous diet, and, if the stomach and bowels are at all loaded, a dose or two of some gentle laxative, are commonly sufficient to subdue the disease. Some persons cure their colds by entire abstinence from food, and as much as possible from drink; others by a large opiate, or by a succession of doses of Dover's powder; others by spirit of mildereris and pargoric; some even profess to carry out the popular maxim, 'stuff a cold, and starve a fever,' and maintain, that a good dinner, and a tumbler of whisky or brandy toddy, are the best specifics. That colds get well under all these methods, needs not be denied; but that any violently perturbative or specific practice assists the cure, or shortens the disease, has yet to be proved; and multiplied experience has shewn, that 'stuffing a cold' is by no means to be commended. In the later stages, however, a more liberal diet than at first, and in some cases even a moderate allowance of stimulants, affords considerable relief from the feeling of depression that remains for a time on the subsidence of a catarrh. The tendency to this disease, when habitual, and when

not dependent on any form of constitutional disorder requiring special means for its cure, is best met by the daily use of the cold bath, with frequent exercise in the open air, and proper ventilation of the sleeping-apartment; also by friction of the skin, and by clothing, which, without being oppressive, is comfortably warm. Exposure to draughts or sudden chills, when the surface is perspiring, is to be avoided; but a close confined air habitually breathed in a workshop or bedroom, is a fruitful predisposing cause of the disease.

CATAWBA, a light sparkling wine, of rich Muscadine flavour, produced in the neighbourhood of Cincinnati, Ohio, United States. It is made from a grape called the Catawba grape, 'first found growing on the banks of the Catawba River, in Carolina.' This wine, which is scarcely known in England, is now in extensive use in North America, where it is gradually superseding the importation of the Rhensish and French sparkling wines, to which, in general character, it bears a resemblance. The vineyards where the C. is produced, are situated on the steep and beautiful slopes with a southern exposure on the banks of the Ohio River, under the shelter of high hills on the north. The great grower of the C. has been Mr Longworth, an esteemed and wealthy proprietor in this quarter, who, embarking in the pursuit less on business considerations than as an enthusiast, has succeeded, after much patient care and expense, in producing a wine that throughout the States finds more favour, and commands a higher price, than the choicest wines imported. Some of the finer kinds of C. rival the best champagne in delicacy and purity, and are not to be confounded with inferior American imitations.

CATALO'GAN, or **CADVALO'NGA**, a town of the Philippines, capital of the island of Samar, on a small bay on the west coast. The houses are mostly constructed of nipa palm, but there are some of stone. Pop. about 7000.

CAT-BIRD (*Turdus felivox*), an American thrush, of the same group with the mocking-bird, which it resembles in its vocal powers. It is a bird of passage, making its way northward in spring through Georgia and Carolina as far as Massachusetts. It feeds on fruit and berries of all kinds, worms, and insects; builds a large nest of dry twigs, weeds, &c., without any attempt at concealment, in a bush or tree, often in the immediate vicinity of human habitations, and shews extraordinary boldness in the defence of its young. It has its name from a mewing cry which it utters when annoyed by an intruder approaching too near its nest.

CATCH, a species of musical composition peculiar to England, and in the canon style. The words of the C. are generally humorous, and intended to be sung in social parties over a glass. The music is generally for three voices, of which there exist hundreds of specimens from the time of Purcell to the present day. As in the canon, each voice takes up the subject at a certain distance after the first has begun. One of the best specimens of a C. is by Calcott, on Hawkins's and Burney's Histories of Music, where the humour lies in one of the parts repeating 'Burney's history'—sounding like 'burn his history'—while the others are advocating Hawkins.

CATCHFLY, the common English name of several plants of the natural order *Caryophyllaceæ*—as *Silene Armeria*, *S. Anghica*, *Lycchnis Viscaria*, &c.—which being clammy, in consequence of a peculiar exudation, on the calyx, on the joints of the stem, &c., often prove fatal to insects settling upon them.

See *LYCHNIS* and *SILENE*.—The name is sometimes employed by botanists as a sort of popular equivalent to *Silene*.—*Dionea muscipula* is also sometimes called the Carolina Catchfly. See *DIONEÆ*.

CATCHPOLE, a sheriff's officer, or bailiff, is so called in England, probably because he was in use to catch his victim by the *pole*, or head.

CATEAU, **LE**, or **CATEAU-CAMBRESIS**, a town of France, in the department of Nord, situated on the Selle, 14 miles east-south-east of Cambrai. C. has manufactures of shawls, merinoes, calicoes, and leather; it has also breweries and distilleries. Pop. 8620. It is celebrated as the place where, in 1559, the treaty known as that of Cateau-Cambresis was concluded between Henri II. of France and Philip II. of Spain, by which the former monarch ceded to the latter, Savoy, Corsica, and nearly 200 forts in Italy and the Low Countries.

CATECHISM, from a Greek word, *katêcheō*, which means to resound, or sound into one's ears; hence to instruct by word of mouth. Persons undergoing instruction in the principles of Christianity were hence called *catechumens* (*katêchoumenoi*), and the teacher appointed for this purpose was called a *catechist*. Hence any system of teaching by question and answer is called a Catechism.

Catechisms have long formed one of the principal means employed for popular instruction in the truths and duties of the Christian religion. The composition of the first catechisms was, in all probability, suggested by the ordinary oral instruction of catechumens, and was intended for the help both of teachers and pupils. It appears to have been in the 8th and 9th centuries that the first regular catechisms were compiled, of which that by Kero, a monk of St Gall, and that ascribed to Otfried of Weissenburg, are among the most noted. At later periods, the use of catechisms prevailed chiefly among the opponents of the hierarchy, as among the Waldenses, the Albigenses, the Wickliffites, and, above all, among the Bohemian Brethren. The term C. appears to have been first employed in its present sense among the latter. At an early period in the history of the Reformation, the Reformers began to avail themselves of this method of popular instruction, and their catechisms became important instruments in that great religious movement. In 1520, Luther published his first short catechism. In 1525, Justus Jonas and John Agricola were intrusted with the preparation of a catechism. In 1529, Luther published his Larger and Smaller Catechisms, which found a place among the symbolical books or standards of the Lutheran churches. A number of catechisms were published also by the Swiss Reformers, and by those of England and other countries. The Geneva catechisms, Larger and Smaller, were the work of Calvin. They were published in 1536, were speedily translated into various languages, and became acknowledged standards of the Reformed churches, not only in Switzerland but in the Low Countries, in France, and in Hungary. The Church of Geneva has set aside the authority of these catechisms.—The Zurich C. is received as a standard in the Church of Zurich.—The Heidelberg or Palatinate C. is of greater importance, however, than any other as a standard of the Swiss Reformed churches. It was compiled by the Heidelberg theologians, Caspar Olevian and Zacharias Ursinus, at the request of the Elector Frederic III. of the Palatinate; it was published in 1563, was approved by several synods, and was subjected to a revision by the Synod of Dort.—In the Church of Rome, the Romish or Tridentine C. is of high authority. It was prepared in accordance with the decrees of the Council of

Trent, by Archbishop Leon. Marino, Bishop Ægidius Foscorari, and the Portuguese Dominican, Francis Fureiro; revised by Cardinals Borromeo, Sirlet, and Antonian, and sanctioned by Pope Pius V. It was published at Rome in 1566.—The C. of the Orthodox Greek Church was prepared by Peter Mogilas, metropolitan in Kiew, and published in 1642. It received authority as a standard or symbolical book from a synod at Jerusalem in 1672. It is often called the Larger Russian C., to distinguish it from the Smaller C., prepared by order of Peter the Great.—Besides these catechisms, which have a historic interest, or are of importance from their symbolical character, there have appeared at all periods, since the Reformation, many others, both Protestant and Roman Catholic, some doctrinal, some controversial, some devoted to particular subjects, as the sacraments, or to particular purposes, as the preparation of candidates for admission to the Lord's Supper, some adapted to the mental capacity of very young children, &c. The opinion, however, has become prevalent, that doctrinal abstracts are not the best form in which religion can be presented to the young, and the use of catechisms has accordingly been in some measure relinquished in favour of other methods of instruction.

The C. of the Church of England, with which we are most familiar, is the smaller one published in the Book of Common Prayer. It is in two parts: the first contains and explains the Baptismal Covenant, the Creed, the Ten Commandments, and the Lord's Prayer; the second explains the two sacraments, Baptism and the Lord's Supper. It is not known with absolute certainty who was the author of the first part; probably Cranmer and Ridley had the principal hand in framing the questions and answers. It was originally put forth with the 42 Articles in the reign of Edward VI., and condemned as heretical in the reign of Mary. It must not be confounded with Cranmer's C., which was a larger work, differently arranged, and translated chiefly from the German C. used in Nuremberg. This first part of the church C. is spoken of as the *Shorter* Catechism.

There was a *larger* church C. compiled also in the reign of Edward VI., by Ponet, as is supposed, and it corresponds in some degree with the smaller work above described. It was afterwards revised and enlarged by Noel, Dean of St Paul's, and published in 1570; and though never officially promulgated by the church, it has some authority from having been approved by the lower house of Convocation. At the Hampton Court Conference, in the reign of James I., the *Shorter* C. was considered too short, and the larger one of Noel's too long; and accordingly, at the king's suggestion, an addition was made to the former of that explanation of the two sacraments which now forms the second part of the church catechism. This was drawn up by Dr Overall. The whole is a work much esteemed by all sections of the church, as remarkable for its simplicity, truth, and catholicity. It, however, states the baptismal theory in a way that is not very acceptable to the extreme Low Church party. The rubrics in the Common Prayer Book enjoin the teaching of the C. in the church on Sundays and holidays after the 2d lesson at Evening Prayer; and the 59th canon contains a like injunction, imposing penalties on the clergy who neglect this. The custom of catechising in the church had fallen into almost universal disuse, but in many parishes it has been revived with excellent results.

The Larger and Shorter Catechisms, which, with the Westminster Confession of Faith, constitute the standards or symbolical books of the Presbyterian

CATECHU—CATEGORIES.

churches throughout the British empire and the United States of America, were compiled by the Assembly (q. v.) of Divines at Westminster: the Shorter C. 'to be a directory for catechising such as are of weaker capacity;' the Larger, 'for catechising such as have made some proficiency in the knowledge of the Christian religion.' The Shorter C. was presented to the English House of Commons on 5th November 1647; the Larger on the 14th April 1648; and in July 1648, both received the sanction of the General Assembly of the Church of Scotland—the General Assembly, in the act approving of the Larger C., declaring it to be 'a rich treasure for increasing knowledge among the people of God,' and that 'they bless the Lord that so excellent a catechism has been prepared.' The Shorter C. has, however, been far more generally used for the purpose of instruction than the Larger, which has been generally felt to be too minute in its statements, and too burdensome to the memory to be employed as a catechism. Even the Shorter C. is regarded by many, who substantially adhere to its doctrine, as carrying the statement of dogmatic theology beyond what is proper for elementary instruction, whilst it has been long felt to be unsuitable for the very young and the very ignorant, and its use is now almost always preceded by that of catechisms more adapted to their capacity. Its influence, however, has been very great in forming the religious opinions, and in exercising and training the intellectual faculties, wherever Presbyterianism has prevailed; for it has been, and still is, in almost universal use among Presbyterians speaking the English language, and to a considerable extent among Independents or Congregationalists both in Britain and America. In Holland also, a translation of it has been much used. It is very generally regarded, by those whose doctrinal views are in accordance with it, as an admirable compend of Christian doctrine and duty.—The authorship of the Westminster Assembly's Catechisms has been the subject of much debate, or at least the authorship of the first drafts of them; it being admitted that they were prepared with great care by committees of the Assembly. But the probability appears to be, that their authorship is to be ascribed entirely to these committees; and that, like the Westminster Confession of Faith, they are thus the result of the joint labours of many. From discoveries recently made by Dr M'Crle, it seems probable that at least the plan or scheme of the Shorter C. is to be ascribed to Mr Palmer.

CATECHU, a substance employed both as a colouring matter and medicinally as an astringent. The C. of commerce is obtained chiefly from East Indian trees, such as the C. tree (*Acacia Catechu*), betel-nut, &c.; but the greater part of that which is exported from India is made from the C. tree. It is known in India by the name *Kutt*; and C. is said to be a name compounded of two words signifying *the juice of a tree* (*cate*, a tree, and *chu*, juice). **CUTCH** is another form of one or other of these names, and is a common commercial name. The heart-wood alone of the tree yields C., which is obtained by cutting it into small chips, and boiling it in water, straining the liquid from time to time, and adding fresh supplies of chips, till the extract is of sufficient consistence to be poured into clay moulds, which are usually of a square shape; or when of the thickness of tar, it is allowed to harden for two days, so that it will not run, and is formed into balls about the size of oranges, which are placed on husks of rice or on leaves, and appear in commerce enveloped in them. The C. manufacturers in Northern India move to different parts of the

country at different seasons, and erect temporary huts in the jungles, where they carry on their operations. The C. tree abounds chiefly in the Bombay and Bengal presidencies; is a small, erect, thorny tree, with a roundish head of (generally) prickly branches. Its sapwood is yellow, the heart-wood dark red. C. is brittle, and can readily be broken into fragments; is soluble in water, and possesses an astringent taste, but no odour. It is a very permanent colour, and is employed in the dyeing of blacks, browns, fawns, drabs, and greens. It contains much tannin, and an acid called Catechuic Acid, which can be isolated in white silky crystals. It is often adulterated with earthy substances, but its ready solubility in water and alcohol, should at once shew the presence of such, by leaving them behind in an insoluble state.—The C. of the betel-nut is obtained by boiling first the nuts, and then the extract to a proper consistency. A first boiling of the nuts for some hours is said to yield a black kind of C., called *Kassu*; and a second boiling, after the nuts are dried, a yellowish-brown kind, called *Coury*, which is considered the best, and is sold for the highest price. The former appears in commerce under the name of Colombo C. or Ceylon C. (or Cutch), in the form of circular flat cakes, covered on one side with husks of rice. The latter does not seem to reach Europe.—Gambir (q. v.) may be regarded as a kind of catechu. Kino (q. v.) is sometimes confounded with catechu. *Terra Japonica*, or **JAPAN EARTH**, is an old name for C., not quite disused, which was given to it on the supposition of its being an earthy substance brought from Japan.

CATECHUMENS (Gr. persons undergoing a course of instruction; see **CATECHISM**), the appellation given, in the early Christian Church, to those converted Jews and heathens who had not yet received baptism, but were undergoing a course of training and instruction preparatory to it. They had a place assigned them in the congregation, but were not permitted to be present at the dispensation of the Lord's Supper. In the apostolic age, converts appear to have been at once admitted to the sacraments; but afterwards this ceased to be the case, and a period of probation was required. The C. were divided into different classes or grades, according to their proficiency—those of the lowest grade were not permitted to be present during the prayers of the congregation; and those only of the highest, and who had been declared fit to be baptized at the next administration of the ordinance, were permitted to witness the dispensation of the Lord's Supper.—The term C. was afterwards employed to designate young members of the Christian Church who were receiving instruction to prepare them for confirmation or for the Lord's Supper, and it is still often used in this sense.

CATEGORIES. This designation has come down to us from Aristotle. One of the books of his *Organon* or Logical System is so named. The C., or Predicaments, as the schoolmen called them, are to be understood as an attempt at a comprehensive classification of all that exists, for the purposes of logical affirmation, proof, or disproof. The entire universe may be classified in various ways—as into things celestial and terrestrial; into matter and spirit; into organised and unorganised; into minerals, plants, animals, &c. But the classification contemplated under the C. proceeds on the very general properties or attributes that most extensively pervade all existing things, although in unequal degrees. A good example is Quantity, which pertains to everything that we know or can think of. We give the Aristotelian enumeration—the first column is the original Greek; the second,

the Latin rendering of the schoolmen; the third, the nearest corresponding English words :

Οὐσία,	Substantia,	Substance.
Ποσότης,	Quantitas,	Quantity.
Ποιότης,	Qualitas,	Quality.
Ἡσυχία,	Relatio,	Relation.
Ποιότης,	Actio,	Action.
Ἡσυχία,	Passio,	Passivity.
Ἡσυχία,	Ubi,	Position in Space.
Ἡσυχία,	Quando,	Position in Time.
Κατάστασις,	Situs,	Situation.
Ἐξουσία,	Habitus,	Possession.

Mr J. S. Mill has the following remarks on the above scheme: 'The imperfections of this classification are too obvious to require, and its merits are not sufficient to reward, a minute examination. It is a mere catalogue of the distinctions rudely marked out by the language of familiar life, with little or no attempt to penetrate, by philosophical analysis, to the *rationale* even of these common distinctions. Such an analysis, however superficially conducted, would have shewn the enumeration to be both redundant and defective. Some objects are admitted, and others repeated several times under different heads. It is like a division of animals into men, quadrupeds, horses, asses, and ponies. That, for instance, could not be a very comprehensive view of the nature of Relation, which could exclude action, passivity, and local situation from that category. The same observation applies to position in time and position in space; while the distinction between the latter and situation is merely verbal.'—*Logic*, book i., chap. iii., § 1. Some writers have endeavoured to save the C. from these objections, by declaring that the fourth, Relation, is to be looked upon as a general head, comprehending the remaining six under it. But there is no evidence that Aristotle had this view in his mind; on the contrary, it appears almost certain that his idea of Relation was too narrow and limited to admit of his giving it so great a comprehension.

Mr Mill gives as the result of his own analysis, the following enumeration and classification of existences or describable things:

1. Feelings, or States of Consciousness; which are the most comprehensive experience that the human mind can attain to, since even the external world is only known as conceived by our minds.
2. The Minds which experience those feelings.
3. The Bodies, or External Objects, which are supposed to excite all that class of feelings that we denominate Sensations.
4. The Successions and Co-existences, the Likenesses and Unlikenesses, between feelings or states of consciousness. Although those relations are considered by us to subsist between the bodies, or things, external to our minds, we are driven in the last resort to consider them as really subsisting between the states of each one's own individual mind.

Mr Mill shews that all possible Propositions—and it is with the truth or falsehood of Propositions that the science of Logic has chiefly to do—affirm or deny one or other of the following properties or facts: Existence—the most general attribute of all—Co-existence, Sequence or Succession, Causation—a peculiar case of Succession—and Resemblance. It is to arrive at this classification of Propositions, for the purposes of logic, that the foregoing analysis, corresponding to the Aristotelian C., was made. The properties affirmed of any thing or things, or the things of which any properties are affirmed, come under some one or other of the four heads above given.

The C. of Kant, which are sometimes brought into comparison with those of Aristotle, are conceived under a totally different point of view. See

Sir W. Hamilton's *Discussions on Philosophy*, 2d edit., p. 26. They refer to certain forms supposed to be inherent in the understanding itself, under which the mind embraces the objects of actual experience. The Kantian philosophy supposes that human knowledge is partly made up of the sensations of outward things—Colour, Sound, Touch, &c.—and partly of intuitions existing in the mind prior to all experience of the actual world. This is the point of difference between the school of Locke—who rejected all innate ideas, conceptions, or forms—and the school of Kant. No such question was raised under the Aristotelian categories. Kant's enumeration of his innate forms is as follows: 1. Quantity, including unity, multitude, totality; 2. Quality, including reality, negation, limitation; 3. Relation, including substance and accident, cause and effect, action and reaction; 4. Modality, which includes possibility, existence, necessity. These indicate the elements of our knowledge *a priori*; it being the opinion of the author, that such notions, as Causation, Necessity, &c., cannot be obtained from the exercise of our senses and intelligence upon the world of realities, but must have been somehow or other imprinted upon the mind originally.

CA'TENARY. The C. is the curve formed by a flexible homogeneous cord hanging freely between two points of support, and acted on by no other force than gravity. If the cord is not homogeneous, and the density varies in any regular way, the cord hangs in a curve slightly different in shape from that of the ordinary catenary. The C. possesses several remarkable properties, one of which is, that its centre of gravity (q. v.) is lower than that of any curve of equal perimeter, and with the same fixed points for its extremities. Where the cord is such that the weight of any part of it is proportioned to its horizontal projection, the curve is a parabola (q. v.). The latter curve and the ordinary C. are of importance chiefly in the theory of suspension bridges (q. v.). The properties of the C. will be found fully analysed in all the leading works on mechanics.

CATENIPORA, a genus of fossil lamelliferous corals peculiar to Paleozoic strata, confined in Britain to the Silurian measures. The genus is easily recognised. The cells are terminal and oval, arranged like a loose net-work of chains, hence called 'chain coral.' Vertical anastomosing lamellæ united the cells together, and formed a hemispherical polypidom, sometimes of great size.

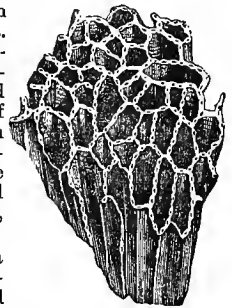

CATERINA, SANTA, a town of Sicily, in the province of Caltanissetta, and 7 miles north-north-west of the town of that name. *Catnipora escharoides*. It is situated on a hill near the river Salso, is fortified, has manufactures of fine earthenware; and in the neighbourhood are found jaspers and agates of good quality. Pop. 5800.

CATERPILLAR, the name given to the larvæ of lepidopterous insects—butterflies, moths, and hawk-moths. Caterpillars exhibit as great differences as subsist among the perfect insects into which they change, and the family, genus, and species may be determined by the characters of the C., as well as of the perfect insect. Their body is generally long, nearly cylindrical, soft, and consisting of twelve rings or segments besides the head,

with nine spiracles or small openings for respiration on each side. The head is much harder than the rest of the body, of a sort of almost horny substance, and has six small shining points on each side, which are regarded as simple or *stemmatic* eyes, and is also furnished with two very short rudimentary antennæ. The mouth is adapted for tearing, cutting, and masticating the substances on which the C. is destined to feed, which are very various in the different species, although in all extremely different from the food of the perfect insect: it is provided with two strong *mandibles*, or upper jaws; two *maxillæ*, or lower jaws; a *labium*, or lower lip; and four *palpi*, or feelers. In the mouth also is situated the *spinneret* of those species which, when they change into the chrysalis or pupa state, envelop themselves in silken cocoons. See SILK-WORM. The first three segments of the body are each furnished with a pair of feet, which are hard and scaly, and represent the six feet of the perfect insect; some of the remaining segments are also furnished with feet, varying in all from four to ten in number, the last pair situated at the posterior extremity of the body; but these feet are soft and membranous or fleshy, and armed at their extremity with a sort of circlet of minute hooks. All the feet or legs are very short. Those caterpillars in which the *pro-legs*, as they are

leaves, and fix them by threads, so forming a dwelling for themselves; and a few burrow and excavate galleries in the substance of leaves. Many feed on leaves; many being limited to a particular kind of plant, or to a few nearly allied plants. Some feed on flowers, some on seeds, some on roots, and some even on the woody portions of stems; some on wool, hides, furs, and other animal substances; a few on lard, and other kinds of fat. Among the admirable arrangements which make all nature harmonious, is the adjustment of the time of each kind of C.'s appearance to that of the leaf or flower on which it is to feed.

CA'TGUT is employed in the fabrication of the strings of violins, harps, guitars, and other musical instruments; as also in the cords used by clock-makers, in the bows of archers, and in whip-cord. It is generally prepared from the intestines of the sheep, rarely from those of the horse, ass, or mule, and *not* those of the cat. The first stage in the operation, is the thorough cleansing of the intestines from adherent feculent and fatty matters; after which they are steeped in water for several days, so as to loosen the external membrane, which can then be removed by scraping with a blunt knife. The material which is thus scraped off is employed for the cords of battle-doors and rackets, and also as thread in sewing the ends of intestines together. The scraped intestines are then steeped in water, and scraped again, when the large intestines are cut and placed in tubs with salt, to preserve them for the sausage-maker; and the smaller intestines are steeped in water, thereafter treated with a dilute solution of alkali (4 oz. potash, 4 oz. carbonate of potash, and 3 to 4 gallons of water, with occasionally a little alum), and are lastly drawn through a perforated brass thimble, and assorted into their respective sizes. In order to destroy any adherent animal matter, which would lead to putrefaction, and the consequent development of offensive odours, it is customary to subject the C. to the fumes of burning sulphur—sulphurous acid, which acts as an antiseptic (q. v.), and arrests decomposition. The best strings are used for musical instruments; and those which come from Italy, and are known as *Roman strings*, are the strongest. They are remarkable for their clearness and transparency. Cord for clockmakers is made from the smallest of the intestines, and occasionally from larger ones, which have been split longitudinally into several lengths. Whip-cord is fabricated from C. which has been twisted in a manner somewhat similar to single-corded ropes. The C. obtained from the intestines of horses, asses, and mules is principally made in France, and is employed instead of leather-belts for driving machinery.

CA'THARI, or CA'THARISTS (Gr. pure), a name very generally given to various sects which appeared in the church during the middle ages. It appears to have been sometimes assumed in profession of a purity of doctrine and morals superior to that which generally prevailed in the church, sometimes bestowed ironically in ridicule of such a profession, and perhaps was first used as a designation of the Paulicians (q. v.). It became a common appellation of sects which appeared in Lombardy in the beginning of the 11th c., and afterwards in France and the west of Germany. Having some connection with the Bulgarian Paulicians, they were sometimes called *Bulgarians*; sometimes also *Patarenes* or *Patarines*, sometimes *Publicans* or *Popelicans*, and in the Low Countries, *Piphles*. The names *Albigenses* and C. are often used as equivalent to one another; but we are under

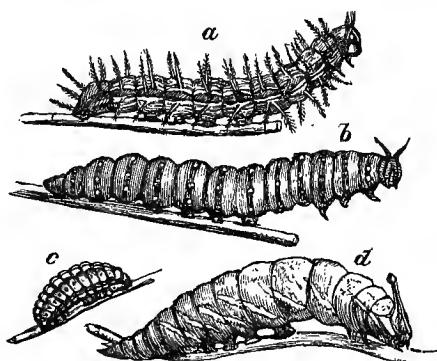

Caterpillars of Butterflies:
 a, silver-washed fritillary; b, swallow-tailed;
 c, chalk-hill blue; d, purple emperor.

sometimes called, or supplementary soft feet, are pretty equally distributed along the body, move by a sort of regular crawling motion; but those which have only four such feet situated near the posterior extremity, move by alternately taking hold by what may be called their fore-feet and their hind-feet, now stretching the body out to its full length, and now bending it into an arch, whilst the hinder part is brought forward almost into contact with the forepart. Caterpillars which move in this way are called *Geometers* or *Loopers*. Some caterpillars have the power of fixing themselves by the two hind feet to a twig, and stretching themselves out as straight as a rod, so that being in colour very like a twig of the tree on the leaves of which they feed, they are not readily observed. The muscular power required for this position of rest is very great, and Lyonnet found the number of muscles in a C. to be more than 4000. The skin of some caterpillars is naked, that of others is covered with hairs, spines, or tubercles. Some make for themselves nests or tents of silk, under which they dwell in societies, protected from the inclemency of the weather. Many construct cases or sheaths by agglutinating various substances together, as the C. of the common clothes-moth. Some roll together

the disadvantage of having to depend entirely on the writings of very bigoted adversaries for our knowledge of their doctrines and practices, and considerable obscurity rests on all this interesting part of ecclesiastical history. Manichæism, Gnosticism, and Montanism are ascribed to the C.; but there is much reason to think that the errors of a few were often indiscriminately charged upon all, and that such charges indeed sometimes rested on ignorant or willful misconstruction. It appears quite certain, that the C. differed considerably in their doctrines and in the degree of their opposition to the dominant church. Some of them advocated and practised a rigid asceticism. There is no good evidence that any of them nearly approached to the doctrines of the Reformation; although in their rejection of tradition, of the authority of Rome, of the worship of saints and images, &c., there are notable points of agreement with the views of the Reformers.

CATHARINE is the name of several saints of the Roman Catholic Church. The simple designation of *Saint C.*, however, is given to a virgin, said to have been of royal descent in Alexandria, who, publicly confessing the gospel at a sacrificial feast appointed by the Emperor Maximinus, was put to death in 307 A.D., after being tortured on a wheel. Hence the name of 'St Catharine's wheel.' Very extraordinary legends exist as to her converting 50 philosophers sent by the emperor to convert her in prison, besides a multitude of other persons; the conveyance of her head by the angels to Mount Sinai, &c. She is regarded as the patroness of girls' schools.—*St C. of Siena*, one of the most famous saints of Italy, was the daughter of a dyer in Siena, and was born there in 1347 A.D.; practised extraordinary mortifications; and was said to be favoured with extraordinary tokens of favour by Christ, whose wounds were impressed upon her body, &c. She became a Dominican, and therefore afterwards a patron saint of the Dominicans. She wrote devotional pieces, letters, and poems, which have been more than once printed: the best edition appeared at Siena and Lucca, in 1707—1713, in 4 vols. 4to, under the title of *Opere della serafica Santa Catarina*.—*St C. of Bologna* and *St C. of Sweden* are of less note.

CATHARINE I., Empress of Russia, was originally by name Martha Rabe, and was the posthumous daughter of John Rabe, a Swedish quarter-master in Livonia. Her mother died in 1685, when she was but three years old. Left helpless and destitute, a parish-clerk took compassion on her, and supported her, and a Lutheran clergyman in Marienburg afterwards received her into his house as an attendant on his children. In 1701, she married a Swedish dragoon, who next year was called to active service; and Marienburg being taken by the Russians, she became for some time the mistress of General Bauer; and afterwards entering the service of the Princess Menchikoff, she attracted the notice of Peter the Great. In 1703 she went over to the Greek Church, and took the name of Catharina Alexiewna. After being for some years the emperor's mistress, she was privately married to him in 1711; the marriage was publicly avowed in 1712; she was proclaimed empress in 1718, and was crowned at Moscow in 1724. She bore eight children to the emperor, all of whom died in childhood, except two daughters, Anne and Elizabeth, the latter of whom was afterwards Empress of Russia, and the former married the Duke of Holstein, and was the mother of the Emperor Peter III. When Peter the Great and his army seemed entirely in the power of the Turkish army on the Pruth in 1717, C., who was with

him, sought an interview with the Grand Vizier, and, by employing her jewels to bribe his attendants, succeeded in procuring the deliverance of the Russians. Her conduct on this occasion excited so much admiration and gratitude in the emperor, that he resolved to appoint her his successor. Yet in the end of the year 1724, she became the object of his displeasure and suspicion, on account of an alleged intimacy with a chamberlain, whom he caused to be beheaded. Menchikoff, who had always been attached to her interests, was at this time in disgrace. But she had contrived in a great measure to recover her position, when, on 28th January 1725, Peter the Great died. His death was kept secret as long as possible, that everything might be arranged for her taking possession of the throne; and the Archbishop of Pleskow came forward and declared before the troops and people, that the emperor, on his death-bed, had declared her alone worthy to be his successor. The hostility and hesitation of the nobles were at once overcome, and C. was acknowledged as Empress and sole Ruler of All the Russias. Under Menchikoff's direction, the affairs of government went on well enough for a time; but the empress ere long began to yield to the influence of a number of favourites, addicted herself to drunkenness, and lived such a life as could not fail to hurry her to the grave. She died, however, unexpectedly, 17th May 1727.

CATHARINE II., Empress of Russia, was born at Stettin on 25th April 1729. Her father, the Prince of Anhalt-Zerbst, was a Prussian field-marshal, and governor of Stettin. She received the name of Sophia Augusta; but the Empress Elizabeth of Russia having selected her for the wife of her nephew and intended successor, Peter, she passed from the Lutheran to the Greek Church, and took the name of Catharina Alexiewna. In 1745, her marriage took place. She soon quarrelled with her husband, and each of them lived a life of unrestrained vice. Among his attendants was a Count Soltikow, with whom her intimacy soon became scandalous; and Soltikow was sent on an embassy abroad. But the young Polish count, Stanislaus Poniatowski, almost immediately supplied his place. After the death of the Empress Elizabeth in 1761, Peter III. ascended the Russian throne; but the conjugal difference became continually wider. C. was banished to a separate abode; and the emperor seemed to entertain the design of divorcing her, declaring her only son, Paul, illegitimate, and marrying his mistress, Elizabeth Woronzow. The popular dislike to Peter, however, rapidly increased; and at length, he being dethroned by a conspiracy, C. was made empress. A few days afterwards, Peter was murdered (July 1762). What participation his wife had in his murder, has never been well ascertained.

C. now exerted herself to please the people, and among other things, made a great show of regard for the outward forms of the Greek Church, although her principles were, in reality, those of the infidelity then prevalent among the French philosophers. The government of the country was carried on with great energy; and her reign was remarkable for the rapid increase of the extent and power of Russia. Not long after her accession to the throne, her influence secured the election of her former favourite, Stanislaus Poniatowski, to the throne of Poland. In her own empire, however, discontentment was seriously manifested, the hopes of the disaffected being centred in the young prince Ivan, who was forthwith murdered in the castle of Schlüsselburg. From that time, the internal politics of Russia long consisted in great part of court intrigues for the humiliation of one favourite and the exaltation of another. The first partition of Poland in

1772, and the Turkish war which terminated in the peace of Kainardji in 1774, vastly increased the empires. The Turkish war which terminated in the peace of Jassy in 1792, had similar results, and also the war with Sweden, which terminated in 1790. The second and third partitions of Poland, and the incorporation of Courland with Russia, completed the triumphs of C.'s reign. She began a war with Persia, however, and cherished a scheme for the overthrow of the British power in India; but a stroke of apoplexy cut her off on November 9, 1796. She was a woman of great ability; but, utterly devoid of principle, she shrunk from no crime; and sensuality and ambition governed all her actions. She was shameless in vice; and always had a paramour, who dwelt in her palace, and might be regarded as filling an acknowledged office of state, with large revenues and determinate privileges. Yet distinguished authors flattered her; and she invited to her court some of the literati and philosophers of France. She was ever ready to commence great undertakings, but most of them were left unfinished; and little was really accomplished in her reign for the improvement of the country, or the progress of civilisation. On a visit to the southern provinces of the empire in 1787, she was gratified by a perpetual display of fictitious wealth and prosperity along the whole route. This imperial progress was also a triumphal procession of her vile favourite Potemkin (q. v.).

CATHARINE DE' MEDICI, the queen of Henri II. of France, was the daughter of Lorenzo de' Medici, Duke of Urbino, and was born at Florence in 1519. In her fourteenth year, she was brought to France, and married to Henri, the second son of Francis I. The marriage was a part of the political schemes of her uncle, Pope Clement VII., but as he died soon after, she found herself friendless and neglected at the French court. In these circumstances, she conducted herself with a submission which seemed even to indicate a want of proper spirit, but which gained her the favour of the old king, and in some measure also of her husband. It was not till the accession of her eldest son, Francis II., in 1559, that her love of power began to display itself. The Guises at this time possessed a power which seemed dangerous to that of the throne, and C. entered into a secret alliance with the Huguenots to oppose them. On the death of Francis II. in 1560, and accession of Charles IX., the government fell entirely into her hands. Caring little for religion in itself, although she was very prone to superstition, she disliked the Protestants, chiefly because their principles were opposed to the absolute despotism which she desired to maintain. Yet she sought to rally the Protestant leaders around the throne, in order to remove the Guises. This attempt having failed, and the civil war which ensued having ended in the peace of Amboise, highly favourable to the Protestants, she became alarmed at the increase of their power, and entered into a secret treaty with Spain for the extirpation of heretics; and subsequently into a plot with the Guises, in which at first only the murder of the Protestant leaders was contemplated, but which resulted in the fearful massacre of St Bartholomew's Day. This event brought the whole power of the state into the hands of the queen-mother, who boasted of the deed to Roman Catholic governments, and excused it to Protestant ones, for she now managed all the correspondence of the court. About this time she succeeded, by gold and intrigues, in getting her third son, afterwards Henri III., elected to the Polish throne. But her arbitrary and tyrannical administration roused the opposition of a Roman

Catholic party, at the head of whom was her own fourth son, the Duke of Alençon, who allied themselves with the Protestants. It was very generally believed that she was privy to the machinations that led to his death. When, after the death of Charles IX., Henri III. returned from Poland to be king of France, his mother still ruled the court, and had the principal share in all the intrigues, treacheries, and political transactions of that woful period. Having betrayed all who trusted them, she and her son found themselves at last forsaken and abhorred by all. The League and the Guises had no more confidence in them, than had the Protestants and Henri of Navarre. Vexation on this account preyed on the proud heart of the queen-mother in her last days; and amidst the confusion and strife of parties, she died at Blois, on 5th January 1589, unheeded and unlamented. Her ruling passion was ambition, and to this she was ready to sacrifice everything. Her unprincipled policy had almost subverted the French monarchy; her extravagance and luxury exhausted the finances of the country. Her influence was powerful in increasing the demoralisation of the court and of society. She unscrupulously employed beauties of her train to corrupt men from whose power she apprehended danger.

CATHARINE OF ARAGON, Queen of England, the first wife of Henry VIII., and fourth daughter of Ferdinand and Isabella, king and queen of Castile and Aragon, was born December 1485. She occupies a prominent place in English history, not for what she herself was, but for what she was the occasion of—the Reformation. Married, when scarcely sixteen, to Arthur, Prince of Wales, son of Henry VII., she was left a widow within a year; and in the course of a few months more a second marriage was projected for her by her father-in-law, with his second son Henry, as yet a boy of only twelve years old. The pope's dispensation enabling such near relatives to marry was obtained in 1503, and the marriage took place in June 1509, immediately after Henry's accession to the crown as Henry VIII. Although Henry was very far from being a model husband, he appears to have treated Queen C., who had born him several children, with all due respect, until about 1527, when he conceived a passion for Anne Boleyn (q. v.). He now expressed doubts as to the legality of his marriage, and set about obtaining a divorce. Pope Clement VII. would readily have annulled the marriage permitted by his predecessor, had he not feared Queen C.'s powerful nephew, the Emperor Charles V. He, however, granted a commission to Campeggio and Wolsey, to inquire into the validity of the marriage; but before these prelates Queen C. refused to plead, and appealed to the pope. The king craved judgment. The legates cited the queen, and declaring her contumacious when she appeared not, went on with the cause; but the wily Campeggio, anxious only for time for his master when the king expected an answer, prorogued the court until a future day. The king consulted the universities of Europe, many of which declared the marriage invalid. The pope now summoned the king to Rome, but Henry haughtily refused to appear either himself, or by deputy, which he maintained would be to sacrifice the prerogatives of his crown; and setting the pope at defiance, married Anne Boleyn. Cranmer, shortly afterwards (1533), declared the first marriage void, and Pope Clement annulled Cranmer's sentence, making the separation from Rome complete. Queen C. did not quit the kingdom, but took up her residence first at Ampthill, in Bedfordshire, and afterwards at Kimbolton Castle, Huntingdonshire, where she led an austere religious life until her decease

in January 1536. Queen C.'s personal character was unimpeachable, and her disposition sweet and gentle.

CATHARINE PARR, the sixth wife of Henry VIII, was the daughter of Sir Thomas Parr, and was born in 1513. Married first to Lord Burgh, and afterwards to Lord Latimer, she, in July 12, 1543, became queen of England by marriage with Henry VIII. She was distinguished for her learning and her knowledge of religious subjects, her discussion of which with the king had well-nigh brought her to the block, like so many of her predecessors. Her tact, however, saved her, and brought rebuke on her enemies; for she made it appear to the king's vanity, that she had only engaged him in discourse about the Reformation, in order to derive profit from his majesty's speech. She persuaded Henry to restore the right of succession to his daughters, and interested herself on behalf of the universities. After Henry's death, she married, 1547, Sir Thomas Seymour, and died the following year, not without suspicion of poison.

CATHARINE'S, **St. COLLEGE**, or **HALL**, Cambridge, was founded by Robert Wodelarke, Provost of King's College, 1473, for a master and three or more fellows. The visitors sent down to the university by Edward VI. ordered that there should be then six fellows, and in future a greater or less number as the revenues permitted. Besides these fellows on the principal foundation, there are eight others founded by subsequent benefactors, and called 'Bye Fellows.' Edwin Sandys, Archbishop of York, Bishop Overall, and Bishop Sherlock, were of this college.

CATHARTICS (Gr. *kathairō*, I purify), a name originally for all medicines supposed to purify the system from the matter of disease (*materies morbi*), which was generally presumed by the ancients to exist in all cases of fever and acute disease (see **CRISIS**), and to require to be separated or thrown off by the different excretions of the body. Ultimately, the term C. became limited in its signification to remedies acting on the bowels, which are popularly called *purgatives*—a mere translation of the Greek word. The principal C. are aloes, gamboge, colocynth, rhubarb, scammony, jalap, senna, Epsom and other salts, and castor oil. Sulphur and cream of tartar forms a well-known mild laxative; magnesia is also useful in many cases of indigestion with acidity. Croton oil and elaterium belong to a more dangerous class of C., as also does the favourite remedy of the ancients—the black hellebore. The doses and use of the more ordinary remedies of this class are explained in all works on medicine. See **CONSTIPATION**.

CATHARTINE, or **BITTER OF SENNA**, is the essential principle in senna which possesses laxative or purgative properties. It can be isolated as a yellowish-red uncrystallisable solid, which is deliquescent, soluble in water and alcohol, insoluble in ether, has a very bitter nauseous taste, a characteristic odour, and possesses great purging powers, accompanied by nausea and griping. Three grains of C. are a full dose.

CATHCART, **WILLIAM SHAW**, **EARL**, a British general and diplomatist, son of Baron Cathcart of Cathcart, county of Renfrew, was born September 17, 1755. Having studied at Glasgow, he entered the army, took a prominent part in the American war, and fought with distinction in Flanders and North Germany. In 1801, he was made lieutenant-general, and in 1803, commander-in-chief for Ireland. In 1805, he was engaged on a diplomatic mission to the Czar Alexander. In July 1807, he received the command of the land-forces employed

to co-operate with the fleet in the attack on Copenhagen, and, for his services in this capacity, was made a British peer, with the title of viscount, and received a vote of thanks from both Houses of parliament, January 28, 1808. In 1812, he was sent as ambassador to St Petersburg, accompanied the Czar Alexander in the campaigns of 1813 and 1814, and was present at the congresses of Chatillon and Vienna. He was raised to the rank of earl, June 18, 1814. The latter years of his life were chiefly spent at his country residence, Cartside, near Glasgow, where he died June 17, 1843.—His eldest son, **CHARLES MURRAY**, **EARL CATHCART** (formerly known as Lord Greenock), was born 1783; served in Spain and at Waterloo under Wellington; afterwards acted in Canada; and was made a general, and colonel of the 1st Dragoon Guards. He died July 1859.

CATHCART, **SIR GEORGE**, son of William, Earl Cathcart, was born in London, 1794. Educated at Eton and Edinburgh, he, in 1810, joined the 2d Life Guards, and fought with the grand army in the campaigns of 1812 and 1813; and as aide-de-camp to the Duke of Wellington, was present at Quatre Bras and Waterloo. In 1828, he was made lieutenant-colonel, and served in British America and the West Indies for about eight years; and in 1837 he proved himself an energetic and efficient officer in quelling the outbreak in Canada, where he remained for more than six years. In 1852, having held the appointment of deputy-lieutenant of the Tower for some years, he was made governor of the Cape of Good Hope, with command of the forces, and in this capacity succeeded in bringing to a successful end the harassing Kafir war. He returned to England in time to be sent out to the Crimea as general of division. His bravery here was conspicuous, especially in the battle of Inkermann, where the odds were so terribly against the British forces, and where he was slain. He was buried on the spot where he fell, and which, in his honour, was named Cathcart's Hill. C. was the author of a very valuable work, entitled *Commentaries on the War in Russia and Germany in 1812 and 1813* (London, 1850).

CATHEDRAL, from a Greek word *cathedra*, signifying a *seat*. Thus, 'to speak *ex cathedra*,' is to speak as from a *seat* of authority. The C. city is the seat of the bishop of the diocese, and his throne is placed in the C. church, which is the parish church of the whole diocese. The diocese was, in fact, anciently called *parochia*, until the application of this name to the smaller portions into which it was divided. A C. town has generally been understood to be entitled to the honours of a city, even although the town be not a borough incorporate; but in the case of Manchester, the claim was disallowed by a court of law. The distinction between C. and collegiate churches consists principally in the see of the bishop being at the former. The governing body of a C. is called the dean and chapter—i.e., the dean and canons who meet for corporate purposes in the chapter-house of the cathedral. The property of the C. vests in this body. They elect the bishop of the diocese on the issue of a *congé d'élire* from the crown, but as the person to be elected is always named, and they may be compelled by a mandamus to elect that person and no other, the election is merely a form.

The bishop is 'visitor' of the dean and chapter. In England, by the act of 1840, all members of cathedrals, except the dean, are styled canons. Their *seat* in the C. is called their *stall*. They are no longer called prebends. Canons must reside 3 months in each year. The act allows to the canons of Durham,

Manchester, St Paul's, and Westminster, an income of £1000 per annum; to those of every other C. in England, £500. The bishop was always considered of common right to have the patronage of canonries, but formerly there were exceptions. Now, the appointment to all canonries is vested either in the bishop, or in the crown. Where the bishop is patron, he 'collates,' and the dean and chapter 'induct,' by placing the new canon in a stall in the church. The crown appoints by letters-patent, and the canon is installed without collation. Honorary canons have no emoluments, but rank after the canons. Minor canons, of whom there are from 2 to 6 in each C., perform the daily choral services. The C. service is the usual Church of England service intoned, with an anthem and the Psalms chanted. For the general plan of C. buildings, see CHURCH. The more remarkable cathedrals will be noticed under the names of the towns in which they are situated. In England, the number of cathedrals is 29.

CATHELINEAU, JACQUES, general of the army in La Vendée, in the west of France, was born January 5, 1759, in very humble life, at Pin-en-Mauges, in Lower Anjou. Horrified at the atrocities and despotic acts of the Convention, he placed himself in opposition to it, and soon collected around him a body of loyal peasantry, whom he led against and defeated the Republicans in several conflicts. After the victory of Saumur (q. v.), the council of generals appointed him, as having the greatest influence over his countrymen, commander-in-chief. He immediately determined to make an attack upon Nantes, and managed to penetrate into the town, where he was wounded by a musket-ball, and his troops immediately dispersed. He was carried to St Florent, where he died July 11, 1793. He was a man of great simplicity and honesty of character, and his piety was such, that he was called the Saint of Anjou.

CATHERINE-WHEEL (see CATHELINE, Sr) is frequently used as a charge in coats of arms, when it is represented with teeth, thus:



CATHETER (Gr. *kathēmi*, to thrust into), was a name applied indifferently to all instruments used for passing along mucous canals. In modern times, however, it has generally been reserved for tubular rods through which fluids or air may pass, and which may give free exit to the accumulated contents of such organs as the urinary bladder. The C. for the latter purpose is a very old surgical instrument. The ancients made theirs of copper, which accumulated verdigris. In the 9th c. silver was substituted by the Arabian surgeons as a cleaner metal, and is still used by all who are not obliged, for economical reasons, to have their catheters made of German silver or pewter. The urinary C. for the male varies in length from 10 to 11 inches; the female C. need not be more than 4 or 5 inches. The form is a matter of indifference, but most surgeons prefer an instrument straight to within the last few inches of its length; the latter should be curved into the segment of a small circle. Others, however, use a double curve, and, indeed, nearly every surgeon has a peculiar fancy in this respect.

Flexible catheters are made of gum elastic, which may be used either alone or supported on a wire. Many other materials have been proposed. Of late years, gutta percha has been used, but owing to some awkward accidents—such as portions often breaking off in the bladder—it has not been generally adopted by surgeons.

CATHODE. See ANODE.

CATHOLIC CHURCH. The term catholic literally signifies *universal*. The phrase C. C. is therefore equivalent to 'universal church,' and cannot properly be applied to any particular sect or body, such as the Roman, Anglican, Genevan, Reformed Lutheran, or Presbyterian, all of which form merely portions more or less pure of the 'church universal.' It was first employed to distinguish the Christian Church from the Jewish; the latter being restricted to a single nation, whereas the former was intended for the world in general. Afterwards, it served to mark the difference between the orthodox Christian Church and the various sects which sprang from it, such as the Cerinthians, Basilidians, Arians, Macedonians, &c. The name has been retained by the Church of Rome, which was the visible successor of the primitive one; and although Protestant divines have been careful to deny its applicability to a church which they consider buried under the corrupt accretions of centuries, yet the term catholic is still used by the populace of almost every Protestant country as synonymous with Roman Catholic, so that from their minds all conception of the literal meaning of the word has vanished. For an account of the Church of Rome, see art. ROMAN CATHOLIC CHURCH.

CATHOLIC CREDITOR, in the law of Scotland, is one whose debt is secured over several or the whole subjects belonging to the debtor—e. g. over two or more heritable estates for the same debt. The C. C. is bound so to exercise his right as not unnecessarily to injure the securities of the other creditors. Thus, if he draw his whole debt from one of the subjects, he must assign his security over the others to the postponed creditors.

CATHOLIC (ROMAN) EMANCIPATION ACT (10 Geo. IV. c. 7). To render this famous measure intelligible, and still more to convey a conception of its importance to younger readers, it is necessary that we should preface our account of it by a slight sketch of the position of our Roman Catholic fellow-subjects before it was passed. From first to last, the sufferings of the Roman Catholics were the fruit of political tyranny quite as much as of religious rancour or fanaticism, and their release was effected by a change in the political rather than in the religious views or feelings of the dominant party. The first occasion on which even a promise of a different line of policy from that which had been originally adopted was held out to the Roman Catholics of Ireland, was on the termination of the revolutionary war in 1691; and had King William been able to carry out the views which his personal enlightenment and liberality dictated, it is probable that Catholic emancipation would have been hastened by more than a century. But the English parliament, which was intensely anti-Roman Catholic, enacted, on the 22d of October 1691, that Irish members of both Houses should take the oaths of supremacy; and three years later, a set of acts were passed, which placed the Roman Catholics in a worse position than at any previous period of their history. The whole population was disarmed, and the priests banished from the country. But what must have been still more intolerable, was the interference with the private arrangements of their families. All Roman Catholics were prohibited from acting as guardians not only to Protestant, but to Catholic children. At a somewhat later date (1704), it was enacted that if a son chose to turn Protestant, he should be entitled to dispossess his father, and at once to take possession of the family estate. Though Catholics were

CATHOLIC EMANCIPATION ACT.

not directly declared incapable of holding land, they were deprived of the right of acquiring it by purchase, or even by long lease; and if a Catholic chanced to occupy a place in a line of entail, he was passed over in favour of the next Protestant heir. No office of trust, civil or military, was now open to a Catholic; he was forbidden to vote at elections, to intermarry with a Protestant, or even to dwell in Limerick or Galway, except under certain conditions. But perhaps the most demoralising provision of all, was that which empowered the son of a Catholic to bring his father into Chancery, to force him to declare on oath the value of his property, and to settle such an allowance on him as the court should determine, not only for the father's life, but the son's.

Amongst the other burdens of this heavy time, may be mentioned the exclusion of Catholics from the profession of the law, and the regulation that if a Protestant lawyer married a Catholic, he should be held to have gone over to her faith: the prohibition against Catholics acting as schoolmasters, under the penalty of being prosecuted as convicts, by which the whole body was virtually excluded from the benefits of education: and the still more summary enactment, that if a priest celebrated marriage between a Protestant and a Catholic, he should be hanged. But as years passed away, the memory of the foul deeds of the Inquisition and the confessional, and of the other enormities of which Roman Catholics had been guilty in their days of power, waxed fainter; milder feelings began to prevail; and when Grattan appeared as the champion of their rights, the field was already in some degree prepared for his labours. Favoured by such influences, of which no one knew better how to avail himself, he succeeded, in 1780, in carrying, in the Irish parliament, the famous resolution, 'that the king's most excellent majesty, and the Lords and Commons of Ireland, are the only competent power to make laws to bind Ireland.' Many of the disqualifying statutes were now repealed, and the claim for complete equality with Englishmen and Protestants, or complete separation from the sister-country, was now formally urged. From this period till the final liberation was achieved, there was no rest. The Irish rebellion of 1798 brought home to the English nation the dangers to which it would constantly be exposed till the question was finally adjusted. The Act of Union of 1800 was the immediate consequence of that outbreak; and to this act the Irish were induced to consent by a virtual pledge entered into by Mr Pitt, to the effect that the Catholic disabilities should be at once removed. But, like William of Orange, Pitt had pledged himself to more than he was able to accomplish. The king was seized with scruples regarding the obligations imposed upon him by his coronation oath, and made a vigorous stand against the proposals of his minister.

At a subsequent period, efforts were made in the direction of emancipation by Mr Canning and Lord Castlereagh. About 1824, the press began to take up the question warmly; a Catholic Association was formed, to prepare petitions to parliament; the Irish priests stimulated their flocks to subscribe for the purposes of agitation; O'Connell rapidly became a power; and as early as March 1825, the importance of the question was so deeply felt, that Sir F. Burdett ventured to introduce a relief bill, which passed the Commons by a majority of 268 to 241, but was rejected by the Lords. A slight temporary reaction now took place, the superstitious fears of ignorant Protestants being excited by a 'no-pope' cry, and in consequence, a new relief bill, introduced in 1827, though supported by the last effort of Canuing's eloquence, was lost in the Commons by a majority

of 4. But the liberal view of the Roman Catholic claims was essentially the popular one—at least among the enlightened classes; and as a proof of this, under the hostile administration of the Duke of Wellington, the very same resolution which had been lost in 1827 by a minority of 4, was carried in 1828 by a majority of 6. The duke himself now began to waver in opinion, so that the beginning of the end was manifestly near. During O'Connell's famous canvass for the county of Clare, the duke declared in the House of Lords, 'if the public mind were now suffered to be tranquil, if the agitators of Ireland would only leave the public mind at rest, the people would become more satisfied, and I certainly think it would then be possible to do something.' O'Connell's return for Clare, notwithstanding the existence of the oaths which precluded him from taking his seat in the House, and the events which now followed in quick succession, made it clear that the 'something' of which the duke had spoken must be the passing of the emancipation bill in the ensuing session. The king's speech, which was read on the 5th February of the following year, accordingly contained a recommendation to parliament, to consider whether the civil disabilities of the Catholics could not be removed, 'consistently with the full and permanent security of our establishments in church and state.'

On the 5th March, Mr Peel brought forward the great measure. The majority on the motion in the Commons for going into committee was 188, in a house of 508 members; the debate on the second reading issued in a majority of 180; and the final majority, after the bill had passed through committee, in which not one of the many amendments proposed was carried, was 178 in a House of 462. In the Lords, the debate lasted three nights, the majority being 106 in favour of the second reading of a bill which, nine months before, the same House had refused, by a majority of 45, even to entertain—so rapid and threatening had been the progress of the agitation. On the 13th April 1829, this famous measure became the law of the land. It now only remains that, by mentioning the provisions of the act, we sum up the results of one of the most important controversies that ever agitated the inhabitants of this country. For the oath of supremacy, another oath was substituted, by which all Catholic members of parliament bound themselves to support the existing institutions of the state, and not to injure those of the church (see *ABJURATION*). Catholics were admitted to all corporate offices, and to an equal enjoyment of all municipal rights. The army and navy had already been opened to them. On the other hand, they were excluded from the offices of Regent, of Chancellor of England or Ireland, and of Viceroy of Ireland; from all offices connected with the church, its universities and schools, and from all disposal of church patronage. The most important security related to the franchise, in which a £10 was substituted for a 40s. qualification in Ireland. The clergy of the R. C. Church were left in the position of other dissenters, the government having declined either to endow them, or to introduce any machinery for prying into their relations to the pope. But the public use of their insignia of office, and of episcopal titles and names, was denied them; the extension of monachism was prohibited; and it was enacted that the number of Jesuits should not be increased, and that they should henceforth be subject to registration. For further information, see Miss Martineau's *History of England during the Peace from 1815 to 1846*. W. & R. Chambers, 1858.

CATHOLIC EPISTLES, the name given, according to Clemens Alexandrinus and Origen, to certain epistles, addressed not to particular churches or individuals, but either to the church universal or to a large and indefinite circle of readers. Originally, the C. E. comprised only the first epistle of John and the first of Peter, but, at least as early as the 4th c. (as evinced by the testimony of Eusebius), the term was applied to all the apostolic writings used as 'lessons' in the orthodox Christian churches. But this included the Epistle of James, of Jude, the 2d of Peter, and the 2d and 3d of John. These seven thus constituted the C. E., although the genuineness and authenticity of the last-mentioned five were not universally acknowledged; but this very incorporation with epistles whose canonicity was not questioned, naturally had the effect of confirming their authority, so that in a short time the entire seven came to be considered a portion of the canon.

CATHOLICOS, the title of the patriarchs or chief ecclesiastics in the hierarchy of the Armenian Church, and of the Christians of Georgia and Mingrelia.

CATILINA, LUCIUS SEPTIMIUS, descended from a patrician but impoverished family, was born about the year 108 B. C. During his youth, he attached himself to the party of Sulla. His bodily constitution, which was capable of enduring any amount of labour, fatigue, and hardship, allied to a mind which could stoop to every baseness and feared no crime, fitted him to take the lead in the conspiracy which has made his name infamous to all ages. In the year 68 B. C. he was elected prætor; in 67 B. C., governor of Africa; and in 66 B. C., he desired to stand for the consulship, but was disqualified on account of the accusations brought against him of maladministration in his province. Disappointed thus in his ambition, and burdened with many and heavy debts, he saw no hope for himself but in the chances of a political revolution, and therefore entered into a conspiracy, including many other young Roman nobles, in morals and circumstances greatly like himself. The plot, however, was revealed to Cicero by Fulvia, mistress of one of the conspirators. Operations were to commence with the assassination of Cicero in the Campus Martius, but the latter was kept aware of every step of the conspiracy, and contrived to frustrate the whole design. In the night of November 6 (63 B. C.), Catiline assembled his confederates, and explained to them a new plan for assassinating Cicero; for bringing up the Tuscan army (which he had seduced from its allegiance), under Manlius, from the encampment at Fesulæ; for setting fire to Rome, and putting to death the hostile senators and citizens. In the course of a few hours, everything was made known to Cicero. Accordingly, when the chosen assassins came to the house of the consul, on pretence of a visit, they were immediately repulsed. On the 8th of November, Catiline audaciously appeared in the senate, when Cicero—who had received intelligence that the insurrection had already broken out in Etruria—commenced the celebrated invective beginning: *Quousque tandem abutere, Catilina, patientia nostra?* &c. ('How long now, Catiline, will you abuse our patience?') The scoundrel was abashed, not by the keenness of Cicero's attack, but by the minute knowledge he displayed of the conspiracy. His attempt at a reply was miserable, and was drowned in cries of execration. With curses on his lips, he abruptly left the senate, and escaped from Rome during the night. Catiline and Manlius were now denounced as traitors, and an army under the consul, Antonius, was sent against them. The conspirators who

remained in Rome, the chief of whom was Lentulus, were arrested, tried, condemned, and executed, December 5. The insurrections in several parts of Italy were meanwhile suppressed; many who had resorted to Catiline's camp in Etruria, deserted when they heard what had taken place in Rome, and his intention to proceed into Gaul was frustrated. In the beginning of January (62), he returned by Pistoria (now Pistoja) into Etruria, where he encountered the forces under Antonius, and, after a desperate battle, in which he displayed almost superhuman courage and enthusiasm, was defeated and slain. The appearance of Catiline was in harmony with his character. He had a daring and reckless look; his face was haggard with a sense of crime; his eyes were wild and bloodshot, and his step unsteady, from nightly debauchery. The history of the Catiline conspiracy is given by Sallust in a remarkably concise and nervous style.

CATION. See ANODE.

CATKIN (*amentum*), in Botany, a spike of numerous, small, unisexual flowers, destitute of calyx and corolla, and furnished with scale-like bractæa instead, the whole inflorescence finally

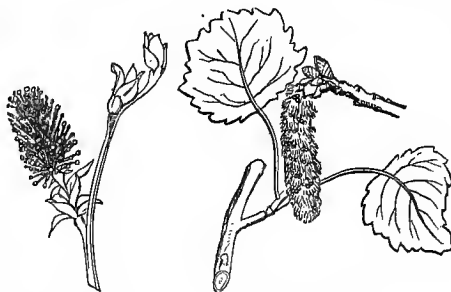

Catkin of Willow.

Catkin of Birch.

falling off by an articulation in a single piece. Examples are found in the willow, hazel, oak, birch, alder, and other trees and shrubs, forming the natural order **AMENTACEÆ** (q. v.). In some, as in the oak and hazel, the male flowers only are in catkins.

CATMINT (*Nepeta cataria*), a plant of the natural order *Labiata*, pretty common in England, in chalky and gravelly soils, but rare in Scotland and Ireland, widely diffused throughout Europe and the middle latitudes of Asia, and of North America; remarkable for the fondness which cats display for it. It appears to act upon them in a similar way to Valerian root; and when its leaves are bruised so as to be highly odoriferous, they are at once attracted to it, rub themselves on it, tear at it, and chew it. Its odour has been described as intermediate between that of mint and that of pennyroyal. It has erect stems, 2—3 feet high, dense whorls of many whitish flowers, tinged and spotted with rose-colour, and stalked heart-shaped leaves of a velvety softness, whitish and downy beneath.—Other species are numerous in the south of Europe, and middle latitudes of Asia.

CATO, MARCUS PORCIUS, surnamed *Censorius* and *Sapiens* ('the wise'), afterwards known as **CATO PRISCUS** or **CATO MAJOR**—to distinguish him from Cato of Utica—was born at Tusculum in 234 B. C. He inherited from his plebeian father a small farm in the country of the Sabines, where he busied himself in agricultural operations, and learned to love the simple and severe manners of his Roman forefathers, which still lingered round his rural home. Induced by Lucius Valerius Flaccus to

remove to Rome when that city was in a transition epoch, from the old-fashioned strictness and severe frugality of social habits, to the luxury and licentiousness of Grecian manners, C. appeared to protest against this, to denounce the degeneracy of the Philo-hellenic party, and to set a pattern of sterner and purer character. He soon distinguished himself as a pleader at the bar of justice, and after passing through minor offices, was elected consul. In his province of Nearer Spain, where an insurrection had broken out after the departure of the elder Scipio (206 B.C.), C. was so successful in quelling disturbances and restoring order, that in the following year he was honoured by a triumph. C. exhibited extraordinary military genius in Spain; his stratagems were brilliant, his plans of battle were marked by great skill, and his general movements were rapid, bold, and unexpected. In 187 B.C., a fine opportunity occurred for the display of 'antique Roman' notions. M. Fulvius Nobilior had just returned from Ætolia victorious, and sought the honour of a triumph. C. objected. Fulvius was indulgent to his soldiers, a man of literary taste, &c., and C. charges him, among other enormities, with 'keeping poets in his camp.' These rude prejudices of C. were not acceptable to the senate, and C.'s opposition was fruitless. In 184 B.C., C. was elected censor, and discharged so rigorously the duties of his office, that the epithet *Censorius*, formerly applied to all persons in the same station, was made his permanent surname. Many of his acts were highly commendable. He repaired the water-courses, paved the reservoirs, cleansed the drains, raised the rents paid by the publicans for the farming of the taxes, and diminished the contract prices paid by the state to the undertakers of public works. More questionable reforms were those in regard to the price of slaves, dress, furniture, equipage, &c. His despotism in enforcing his own idea of decency may be illustrated from the fact, that he degraded Manilius, a man of prætorian rank, for having kissed his wife in his daughter's presence in open day. C. was a thoroughly dogmatic moralist, intolerant, stoical, but great, because he manfully contended with rapidly swelling evils; yet not wise, because he opposed the bad and the good in the innovations of his age with equal animosity.

In the year 175 B.C., C. was sent to Carthage to negotiate on the differences between the Carthaginians and the Numidian king Masinissa; but having been offended by the Carthaginians, he returned to Rome, where, ever afterwards, he described Carthage as the most formidable rival of the empire, and concluded all his addresses in the senate-house—whatever the immediate subject might be—with the well-known words: '*Ceterum censeo, Carthaginem esse delendam*' ('For the rest, I vote that Carthage must be destroyed').

Though C. was acquainted with the Greek language and its literature, his severe principles led him to denounce the latter as injurious to national morals. He died 149 B.C., at the age of 85. C. was twice married. In his eightieth year, his second wife, Salonia, bore him a son, the grandfather of Cato of Utica. C. treated his slaves with shocking harshness and cruelty. In his old age, he became greedy of gain, yet never once allowed his avarice to interfere with his honesty as a state-functionary. He also composed various literary works, such as *De Re Rustica* (a treatise on agriculture)—much corrupted, however. The best editions are by Gesner and Schneider in their *Scriptores Rei Rusticæ*. His greatest historical work, *Origines*, has unfortunately perished; but some few fragments are given in Krause's *Historicorum Romanorum Fragmenta*

(Berlin, 1833). Fragments of C.'s orations—of which as many as 150 were read by Cicero—are given in Meyer's *Oratorum Romanorum Fragmenta* (Zurich, 1842).

CATO, MARCUS PORCIUS, named CATO THE YOUNGER, or CATO UTICENSIS (from the place of his death), was born 95 B.C. Having lost, during childhood, both parents, he was educated in the house of his uncle M. Livius Drusus, and, even in his boyhood, gave proofs of his decision and strength of character. In the year 72 B.C., he served with distinction in the campaign against Spartacus, but without finding satisfaction in military life, though he proved himself a good soldier. From Macedonia, where he was military tribune in 67, he went to Pergamum in search of the Stoic philosopher, Athenodorus, whom he brought back to his camp, and whom he induced to proceed with him to Rome, where he spent the time partly in philosophical studies, and partly in forensic discussions. Desirous of honestly qualifying himself for the quaestorship, he commenced to study all the financial questions connected with it. Immediately after his election, he introduced, in spite of violent opposition from those interested, a rigorous reform into the treasury offices. He quitted the quaestorship at the appointed time amid general applause. In 63 B.C., he was elected tribune, and also delivered his famous speech on the Catiline conspiracy, in which he denounced Cæsar as an accomplice of that political desperado, and determined the sentence of the senate. Strongly dreading the influence of unbridled greatness, and not discerning that an imperial genius—like that of Cæsar—was the only thing that could remedy the evils of that overgrown monster, the Roman Republic, he commenced a career of what seems to us blind pragmatical opposition to the three most powerful men in Rome—Crassus, Pompey, and Cæsar. C. was a noble but strait-laced theorist, who lacked the intuition into circumstances which belongs to men like Cæsar and Cromwell. His first opposition to Pompey was successful; but his opposition to Cæsar's consulate for the year 59 not only failed, but even served to hasten the formation of the first triumvirate between Cæsar, Pompey, and Crassus. He was afterwards forced to side with Pompey, who had resiled from his connection with Cæsar, and become reconciled to the aristocracy. After the battle of Pharsalia (48 B.C.), C. intended to join Pompey, but hearing the news of his death, escaped into Africa, where he was elected commander by the partisans of Pompey, but resigned the post in favour of Metellus Scipio, and undertook the defence of Utica. Here, when he had tidings of Cæsar's decisive victory over Scipio at Thapsus (April 6, 46 B.C.), C., finding that his troops were wholly intimidated, advised the Roman senators and knights to escape from Utica, and make terms with the victor, but prohibited all intercessions in his own favour. He resolved to die rather than surrender, and, after spending the night in reading Plato's *Phædo*, committed suicide by stabbing himself in the breast.

CATO, DIONYSIUS, is the name prefixed to a little volume of moral precepts in verse, which was a great favourite during the middle ages. Whether or not such a person ever existed, is a point of the greatest uncertainty. The title which the book itself commonly bears, is *Dionysii Catonis Disticha de Moribus ad Filium*. Its contents have been differently estimated: some scholars have considered the precepts admirable; others, weak and vapid: some have found indications of a superior scriptural knowledge; others, of a deep-rooted

paganism. The style has been pronounced the purest Latin and the most corrupt jargon. The truth would seem to be, that on a groundwork of excellent Latin of the Silver Age, the illiterate monks of a later period have, as it were, inwoven a multitude of their own barbaric errors, which preclude us from determining precisely the period when the volume was composed. It begins with a preface addressed by the supposed author to his son, after which come 56 injunctions of rather a simple character, such as *parentem ama*. This is followed by the substance and main portion of the book—viz., 144 moral precepts, each of which is expressed in two dactylic hexameters. During the middle ages, the *Disticha* was used as a text-book for young scholars. In the 15th c., more than 30 editions were printed. The best edition, however, is that published at Amsterdam in 1754 by Otto Arntzenius. Caxton translated it into English.

CA'TODON and CATODONTIDÆ. See CACHOLOI.

CATOPTRICS. The divisions of the science of optics are laid out and explained in the article OPTICS (q. v.). C. is that subdivision of geometrical optics which treats of the phenomena of light incident upon the surfaces of bodies, and reflected therefrom. All bodies reflect more or less light, even those through which it is most readily transmissible; light falling on such media, for instance, at a certain angle, is totally reflected. Rough surfaces scatter or disperse (see DISPERSION OF LIGHT) a large portion of what falls on them, through which it is that their peculiarities of figure, colour, &c., are seen by eyes in a variety of positions; they are not said to reflect light, but there is no doubt they do, though in such a way, owing to their inequalities, as never to present the proper phenomena of reflection. The surfaces with which C., accordingly, deals, are the smooth and polished. It tracks the course of rays and pencils of light after reflection from such surfaces, and determines the positions, and traces the forms, of images of objects as seen in mirrors of different kinds.

A ray of light is the smallest conceivable portion of a stream of light, and is represented by the line of its path, which is always a straight line. A pencil of light is an assemblage of rays constituting either a cylindrical or conical stream. A stream of light is called a converging pencil when the rays converge to the vertex of the cone, called a focus; and a diverging pencil, when they diverge from the vertex. The axis of the cone in each case is called the axis of the pencil. When the stream consists of parallel rays, the pencil is called cylindrical, and the axis of the cylinder is the axis of the pencil. In nature, all pencils of light are primarily diverging—every point of a luminous body throwing off light in a conical stream; converging rays, however, are continually produced in optical instruments, and when light diverges from a very distant body, such as a fixed star, the rays from it falling on any small body, such as a reflector in a telescope, may, without error, be regarded as forming a cylindrical pencil. When a ray falls upon any surface, the angle which it makes with the normal to the surface at the point of incidence is called the angle of incidence; and that which the reflected ray makes with the normal, is called the angle of reflection.

Two facts of observation form the groundwork of catoptrics. They are expressed in what are called the laws of reflection of light: 1. In the reflection of light, the incident ray, the normal to the surface at the point of incidence, and the reflected ray, lie all in one plane. 2. The angle of reflection is equal to the angle of incidence. These

laws are simple facts of observation and experiment, and they are easily verified experimentally. Rays of all colours and qualities follow these laws, so that white light, after reflection, remains undecomposed. The laws, too, hold, whatever be the nature, geometrically, of the surface. If the surface be a plane, the normal is the perpendicular to the plane at the point of incidence; if it be curved, then the normal is the perpendicular to the tangent plane at that point. From these laws and geometrical considerations may be deduced all the propositions of catoptrics. In the present work, only those can be noticed whose truth can in a manner be exhibited to the eye, without any rigid mathematical proof. They are arranged under the heads *Plane Surfaces* and *Curve Surfaces*.

Plane Surfaces.—1. When a pencil of parallel rays falls upon a plane mirror, the reflected pencil consists of parallel rays. A glance at the annexed figure (fig. 1), where PA and QB are two of the incident rays, and are reflected in the directions AR and BS respectively, will make the truth of this pretty clear to the eye. The proposition, however, may be rigidly demonstrated by aid of Euclid, book xi., with which, however, we shall not presume the reader to be acquainted. The reader may satisfy himself of its truth practically by taking a number of rods parallel to one another and inclined to the floor, and then turning them over till they shall again be equally inclined to the floor, when he will again find them all parallel.—2. If a diverging or converging pencil is incident on a plane mirror, the focus of the reflected pencil is situated on the opposite side of the mirror to that of the incident pencil, and at an equal distance from it. Suppose the pencil to be diverging from the focus Q (fig. 2), on the

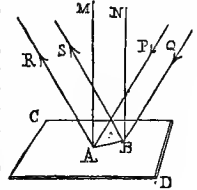

Fig. 1.

the mirror of the surface of which CB is a section. Draw QNq perpendicular to CB, and make $qN = QN$, then q is the focus of the reflected rays. For let QA, QB, QC be any of the incident rays in the plane of the figure; draw the line AM perpendicular to CB, and draw AR, making the angle MAR equal to the angle of incidence, MAQ. Then AR is the reflected ray. Join qA. Now it can be proved geometrically, and indeed is apparent at a glance, that qA and AR are in the same straight line; in other words, the reflected ray AR proceeds as if from q. In the same way, it may be shewn that the direction of any other reflected ray, as BS, is as if it proceeded from q; in other words, q is the focus of reflected rays; it is, however, only their virtual focus. See art. FOCUS. If a pencil of rays converged to q, it is evident that they would be reflected to Q as their real focus, so that a separate proof for the case of a converging pencil is unnecessary. The reader who has followed the above, will have no difficulty in understanding

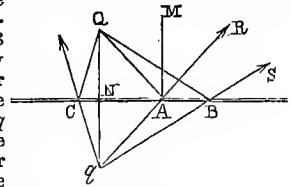

Fig. 2.

the above, will have no difficulty in understanding

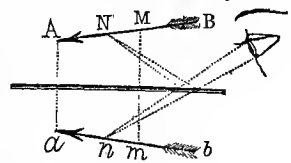

Fig. 3.

how the position and form of the image of an object placed before a plane mirror—as in fig. 3, where the object is the arrow AB, in the plane of the paper, to which the plane of the mirror is perpendicular—should be of the same form and magnitude as the object (as *ab* in the fig.), and at an equal distance from the mirror, on the opposite side of it, but with its different parts inverted with regard to a given direction. The highest point *a*, for instance, in the image, corresponds with the lowest point, *A*, in the object. He will also understand how, in the ordinary use of a looking-glass, the right hand of the image corresponds to the left hand of the object.

When two plane mirrors are placed with their reflecting surfaces towards each other, and parallel, they form the experiment called the Endless Gallery. Let (in fig. 4) the arrow, *Q*, be placed

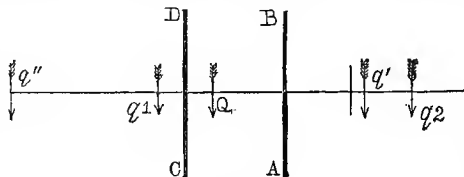

Fig. 4.

vertically between the parallel mirrors, CD, BA, with their silvered faces turned to one another, *Q* will produce in the mirror CD the image *q1*. This image will act as a new object to produce with the mirror BA the image *q2*, which, again, will produce with the mirror CD another image, and so on. Another series of images, such as *q'*, *q'*, &c., will similarly be produced at the same time, the first of the series being *q'*, the image of *Q* in the mirror BA. By an eye placed between the mirrors, the succession of images will be seen as described; and if the mirrors were perfectly plane and parallel, and reflected all the light incident on them, the number of the images of both series would be infinite. If, instead of being parallel, the mirrors are inclined at an angle, the form and position of the image of an object may be found in precisely the same way as in the former case, the image formed with the first mirror being regarded as a new (virtual) object, whose image, with regard to the second, has to be determined. For a curious application of two plane mirrors meeting and inclined at an angle an aliquot part of 180°, see art. KALEIDOSCOPE.—3. The two propositions already established are of extensive application, as has partly been shewn. They include the explanation

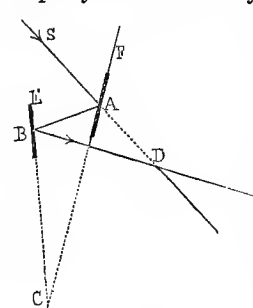

Fig. 5.

of all phenomena of light related to plane mirrors. The third proposition is one also of considerable utility, though not fundamental. It is: When a ray of light has been reflected at each of two mirrors inclined at a given angle to each other, in a plane perpendicular to their intersection, the reflected ray will deviate from its original course by an angle double the angle of inclination of the mirrors. Let A and B (fig. 5) be sections of the mirrors in a plane perpendicular to their intersection, and let their directions

be produced till they meet in C. Let SA, in the plane of A and B, be the ray incident on the first mirror at A, and let AB be the line in which it is thence reflected to B. After reflection at B, it will pass in the line BD, meeting SA, its original path, produced in D. The angle ADB evidently measures its deviation from its original course, and this angle is readily shewn to be double of the angle at C, which is that of the inclination of the mirrors. It is on this proposition that the important mathematical instruments called the Quadrant and Sextant (*q. v.*) depend.

Curved Surfaces.—As when a pencil of light is reflected by a curved mirror, each ray follows the ordinary law of reflection, in every case in which we can draw the normals for the different points of the surface, we can determine the direction in which the various rays of the pencil are reflected, as in the case of plane mirrors. It so happens that normals can be easily drawn only in the case of the sphere, and of a few 'surfaces of revolution,' as they are called. These are the paraboloid, the ellipsoid, and the hyperboloid of revolution. The paraboloid of revolution is of importance in optics, as it is used in some specula for telescopes. See arts. SPECULUM and TELESCOPE. The three surfaces last named are, however, all of them interesting, as being for pencils of light incident in certain ways what are called surfaces of accurate reflection—i. e., they reflect all the rays of the incident pencil to a single point or focus. We shall explain to what this property is owing in the case of the parabolic reflector, and state generally the facts regarding the other two.

1. The concave parabolic reflector is a surface of accurate reflection for pencils of rays parallel to the axis or central line of figure of the paraboloid. This results from the property of the surface, that the normal at any point of it passes through the axis, and bisects the angle between a line through that point, parallel to the axis, and a line joining the point to the focus of the generating parabola. Referring to fig. 6, suppose a ray incident on the surface at P, in the line SP, parallel to the axis AFG.

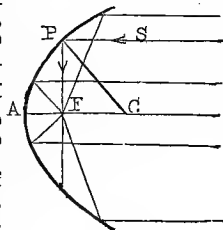

Fig. 6.

Then if F be the focus of the generating parabola, join PF. PF is the direction of the reflected ray. For PG, the normal at P, by the property of the surface, bisects the angle FPS, and therefore \angle (angle) FPG = \angle GPS. But SPG is the angle of incidence, and SP, PG, and FP are in one plane, and therefore, by the laws of reflection, FP is the reflected ray. In the same way, all rays whatever, parallel to the axis, must pass through F after reflection. If F were a luminous point, the rays from it, after reflection on the mirror, would all proceed in a cylindrical pencil parallel to the axis. This reflector, with a bright light in its focus, is accordingly of common use in light-houses.

2. In the concave ellipsoid mirror there are two points—viz., the foci of the generating ellipse, such that rays diverging from either will be accurately reflected to the other. This results from the property of the figure, that the normal at any point bisects the angle included between lines drawn to that point from the foci.

3. Owing to a property of the surface similar to that of the ellipsoid, a pencil of rays converging to the exterior focus of a hyperbolic reflector, will be accurately reflected to the focus of the generating hyperbola.

The converse of the above three propositions holds in the case of the mirrors being convex.

Though the sphere is not a surface of accurate reflection, except for rays diverging from the centre, and which on reflection are returned thereto, the spherical reflector is of great practical importance, because it can be made with greater facility and at less expense than the parabolic reflector. See art. TELESCOPE. It is necessary, then, to investigate the phenomena of light reflected from it.

4. *Spherical Mirrors*.—It is usual to treat of two cases, the one the more frequent in practice, the other the more general and comprehensive in theory. First, then, to find the focus of reflected rays when a small pencil of parallel rays is incident directly

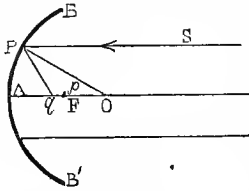

Fig. 7.

on a concave spherical mirror. Let BAB' (fig. 7) be a section of the mirror, O its centre of curvature, and A the centre of its aperture. AO is the axis of the mirror, and therefore of the incident pencil, because it is incident directly on the mirror; a pencil being called oblique when its axis is at an angle to the axis of the mirror. As the ray incident in the line OA will be reflected back in the same line—OA being the normal at A—the focus of reflected rays must be in OA. Let SP be one of the rays; it will be reflected so that $\angle qPO = \angle SPO$. But $\angle POq = \angle OPS$ by parallel lines. Therefore, $\angle qPO = \angle OPQ$, and Pq and Oq are equal. If, now, the incident pencil be very small—i. e., if P be very near A—then the line Pq will very nearly coincide with the line OA, and Pq and Oq will each of them become very nearly the half of OA. Let F be the middle point of OA—the point, namely, to which q tends as the pencil diminishes. Then F is called the principal focus of the mirror, and AF the principal focal length, which is thus = $\frac{1}{2}$ radius of the mirror. It will be observed that when AP is not small, q lies between A and F. Fq is called the aberration of the ray. When AP is large, the reflected rays will continually intersect, and form a luminous curve with a cusp at F. This curve is called the Caustic (q. v.). We shall now proceed to the more general case of a small pencil of diverging rays, incident directly on a concave spherical mirror. Let PAP' (fig. 8) be a section of the mirror, A the centre of its aperture, O of its curvature, and let F be its principal focus. Then, if Q be the focus of incident rays (as if proceeding from a candle there situated), q, the focus of the reflected rays, lies on QOA, since the pencil is incident directly, and the ray QOA, being incident in the line of the normal OA, is reflected back in the same line. Let PQ be any other ray of the pencil. It will be reflected in Pq, so that $\angle qPO = \angle OPQ$; and on the supposition that PA is very small, so that QP becomes nearly equal to QA, and qP to qA, it can be shewn, by Euclid, vi. 3, that $\frac{QO}{QA} = \frac{qO}{qA}$ very nearly. From this equation is deduced the formula $qA = \frac{QA \times AF}{QA - AF}$, which enables us to find qA, when QA and AF are known. Thus, let the radius of curvature

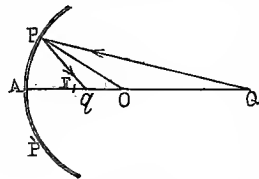

Fig. 8.

be 12 inches, and the distance of the source of the rays, or QA, 30 inches, the focal length $qA = \frac{30 \times 6}{30 - 6} = 7\frac{1}{2}$ inches. If the rays had diverged from q, it is clear they would have been reflected to Q. The points Q and q, accordingly, are called conjugate foci.

If the mirror be convex, as in fig. 9, instead of diverging rays be incident directly on it from Q, we should find, proceeding in exactly the same way as in the former case, the equation $qA = \frac{QA \times AF}{QA + AF}$; or taking the same numbers as before; $qA = \frac{30 \times 6}{30 + 6} = 5$ inches.

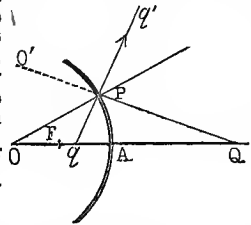

Fig. 9.

For information regarding the formation of images by spherical mirrors, the reader may consult Potter's *Elements of Optics*. See also the arts. MIRRORS and IMAGES.

By considering fig. 8, it is easy to see how the relative positions of the two conjugate foci, as they are called, Q, and q, vary as the distance, AQ, of the origin of the rays is changed. As Q is advanced towards O, q also approaches O, since the angles QPO and qPO always remain equal; and when the source of the light is in the centre, O, of the sphere, the reflected rays are all returned upon the source. As Q, again, recedes from O, q moves towards F, which it does not quite reach until the distance of Q is infinite, so that the incident rays may be considered as parallel, as in fig. 7. If Q is placed between O and F, then q will be to the right of O; and when Q coincides with F, the reflected rays will have no focus, but will be parallel. If Q is between F and A, the reflected rays will diverge, and will have their virtual focus to the left of A. The correctness of these deductions may easily be verified. The positions of the conjugates are traced in precisely the same way for the convex mirror, and the reader who is interested will find no difficulty in tracing them for himself.

CATOPTROMANCY, divination by the mirror or looking-glass. At Patras, in Greece, the sick foretold their death or recovery by means of a mirror let down with a thread until its base touched the water in a fountain before the temple of Ceres. The face of the sick person appearing healthy in the mirror, betokened recovery; if it looked ghastly, then death was sure to ensue. More modern superstitions attach ill-luck to the breaking of a looking-glass, and to seeing one's face in a glass by candle-light.

CATS, JACOB, a Dutch statesman and poet, was born at Brouwershaven, in Zeeland, in 1577, and after studying law, finally settled at Middelburg. He rose to high offices in the state, and was twice sent as ambassador to England, first in 1627, and again in 1652, while Cromwell was at the head of affairs. He died 1660. As a poet, he enjoyed the highest popularity. His poems are characterized by simplicity, rich fancy, clearness, and purity of style, and excellent moral tendency. The most highly prized of his productions were *Haravelyk*, *Trouwingh* (a series of romantic stories relating to remarkable marriages), and *Spiegel van den Ouden en Nieuwen Tijd*. The best edition of his works appeared at Amsterdam, in 19 vols., 1790—1800.

CAT'S-EYE, a beautiful mineral, a variety of

quartz receiving its name from the resemblance which the reflection of light from it, especially when cut *en cabochon*, or in a convex form, is supposed to exhibit to the light which seems to emanate from the interior of the eye of a cat. It has a sort of pearly appearance, and is *chatoyant* or characterised by a fine play of light, which results from the parallel arrangement of the minute fibres of the stone itself, or from an intimate mixture of some foreign substance, such as amethyst. It has been supposed that C. is silicified wood. It is of various colours, and is obtained chiefly from Malabar and Ceylon. The Singhalese are especially proud of it, believing it, although erroneously, to be only found in their island. It is often brought from that island, cut to resemble a monkey's face, from the idolatrous regard entertained for the monkey. A chatoyant variety of felspar has been sometimes confounded with C., and is also found in Ceylon.

CATSKILL MOUNTAINS, a group of the Alleghany chain, in its largest sense, situated near the right bank at once of the Hudson and of the Mohawk, in the state of New York. The loftiest points, Round Top and High Peak, are respectively 3800 feet and 3720 above tide-water; and, on a third eminence, a terrace of 2500 feet above the same level presents Catskill Mountain House, a favourite retreat in summer. The group is drained chiefly by Catskill Creek, which, at a village of its own name, enters the Hudson 111 miles above its mouth, and 34 below the confluence of the Mohawk.

CAT'S-TAIL. See **TYPHA**.

CAT'S-TAIL GRASS. See **TIMOTHY GRASS**.

CATTARO, a town of Austria, in the crown-land of Dalmatia, is situated at the head of the Gulf of Cattaro, about 36 miles south-east of Ragusa. It is strongly fortified, and surrounded on all sides by mountains. The castle, a massive and almost inaccessible building, stands on a precipitous rock immediately behind the town. C. has a cathedral, several churches and hospitals, and a population of 4000. C., which was at one time the capital of a small republic, was in 1807 annexed to the kingdom of Italy, but was handed over to Austria in 1814 by the treaty of Vienna.—**CATTARO, GULF OF**, or **BOCCA DI CATTARO**, an inlet of the Adriatic, near the south extremity of the Dalmatian coast. It consists of three basins or lakes, connected by straits of about half a mile in breadth. The outer entrance is only a mile and a half wide, and the total length of the gulf is about 30 miles. Mountains protect it from all winds, and it has a depth of from 15 to 20 fathoms.

CATTEGAT, or **KATTEGAT** (*Sinus Codanus*), the bay or arm of the sea situated between the east coast of Jutland and the west coast of Sweden, to the north of the Danish islands. It is connected with the Baltic Sea by the Great and Little Belt (q. v.), and by the Sound. The Skager Rack (q. v.) connects it with the North Sea. The length of the C. is about 150 miles, and its greatest breadth 85 miles. It is of unequal depth, and has dangerous sand-banks. The principal islands are Lasøe, Samsøe, and Anhalt. The Danish shores of the C. are low, but the Swedish shore is very steep and rocky.

CATTERMOLE, GEORGE, one of the most distinguished of living English painters in water-colours, was born at Dickleburgh, Norfolk, in 1800. His pictures, which embrace a wide range of subjects, are remarkable for their striking originality of conception, vigorous execution, and fine colour and tone. One of his best known and greatest pictures is 'Luther at the Diet of Spire,' containing 33 portraits of the principal characters, copied from the

authentic originals by the old masters. He also designed the engravings for his brother's *History of the Civil Wars*, and illustrated many scenes in Scott's novels and in Shakspeare's plays. Latterly, he has turned his attention chiefly to oil-painting.

CA'TTI, or **CHATTI**, a German people, included by Caesar under the name Suevi (q. v.), who inhabited a country pretty nearly corresponding to the present Hesse. The south-western part of their territory, around *Mattiacum*, was conquered by the Romans under Drusus. The C. took part in the general rising of the Germans under Hermann. Tacitus praises them as excellent foot-soldiers. During the reign of Marcus Aurelius, in the end of the 2d c., they made incursions into Roman Germany and Rhetia. Caracalla failed in an expedition against them and the Alemanni in the 3d century. About the middle of that century, their name began to give place to that of the Franks (q. v.), and is last mentioned by Claudian in the latter part of the 4th century.

CA'TTLE. See **Ox**.

CATTLE, in English Law. See **CHATTELS**.

CATTOLICA, a town of Sicily, in the province of Girgenti, and 14 miles north-west of the city of that name. It has extensive sulphur-works, and a population of 7200.

CATULLUS, VALERIUS, a celebrated Roman lyricist, was born at Verona, 87 B. C. His father was an intimate friend of Julius Cæsar, and the young poet must have frequently met the great warrior at the paternal residence, when the latter was on his way to Gaul. In early life, he went to Rome, where his career was that of an Epicurean, and the expense of this kind of living soon involved him in pecuniary difficulties. To release himself from these, he followed the prætor Memmius to Bithynia, with the intention, like his superior, of wringing a fortune out of the provincials. This fashionable but felonious method of acquiring money did not succeed in C.'s case, mainly, however, through the more dexterous cupidity of Memmius. After his return, C. appears to have lived mostly in Rome, and in very straitened circumstances. When he died is unknown. His poems, 116 in number, chiefly consisting of lyrics and epigrams—first brought to light by Benvenuto Campesani of Verona in the beginning of the 14th c.—have always been justly admired for their exquisite grace and beauty of style; but are, in many places, grossly indecent. In higher styles of writing, C. was equally successful, especially in his odes, of which, unfortunately, only four have been preserved. His heroic or narrative poem on the marriage of Peleus and Thetis—consisting of more than 400 hexameter lines—and the wild enthusiastic poem entitled *Atys*, are especially worthy of notice. Most of the earlier editions of C. include the works of Tibullus and Propertius. The best modern editions are by Sillig (Gött. 1823), Lachmann (Berl. 1829), and Döring (Altona, 1834). A very good translation into English was executed by the Hon. George Lamb (Lond. 1821).

CAUB, a town of Nassau, North Germany, on the right bank of the Rhine, 21 miles west-north-west of Wiesbaden. It is noteworthy as the place where Blucher crossed the Rhine with his army, January 1, 1814; and also as the place where toll is levied by the Duke of Nassau—the only ruler who now exercises this feudal privilege—from vessels navigating the Rhine. C. has underground slate-quarries; and opposite, on an island in the river, where Louis le Débonnaire died, 840, is a castle called the Pfalz, built in 1326, and which is said to

have been resorted to for safety by the Countesses Palatine during their confinement. Pop. 1500.

CAUCA, a river of New Granada, in South America, which, after flowing 500 miles to the north-east, and watering Popayan, Antioquia, and Caceres, joins the Magdalena on the left or west, 150 miles from the Caribbean Sea. It gives name to a generally fertile department of 68,300 square miles, and 200,000 inhabitants.

CAUCASIAN VARIETY OF MANKIND, an ethnological division adopted by Blumenbach, which included all the inhabitants, ancient and modern, of Europe (except the Fins); in Asia, the Hindus (of high class at least), Persians, Assyrians, Arabians, Jews, Phœnicians, inhabitants of Asia Minor and of the Caucasus, &c.; and in Africa, the Egyptians, Abyssinians, and Moors. What Blumenbach had called Caucasians, Dr Prichard, who may be said to have laid the real foundation of ethnology, makes to consist of two independent groups or varieties, grounding on a radical difference of language. One of these is the Syro-Arabian or Semitic (q. v.) race, and the other the Indo-European or Aryan (q. v.) race. The inhabitants of the Caucasus, so long held to be types of the European variety, are now by some excluded from it altogether, and classed with the sallow flat-faced Mongols, to which it is considered the nature of their language and other facts ally them more closely than the symmetry of their shape and complexion do to the European variety. The narrow basis upon which the theory of the Caucasian type was first formed is thus stated by Dr Latham: 'Blumenbach had a solitary Georgian skull; and that skull was the finest in his collection—that of a Greek being the next. Hence it was taken as the type of the skull of the more organised divisions of our species. More than this, it gave its name to the type, and introduced the term *Caucasian*. Never has a single head done more harm to science than was done in the way of posthumous mischief by the head of this well-shaped female from Georgia.' See ETHNOLOGY.

CAUCASUS, a mountain-range of great geographical and ethnographical importance, occupying the isthmus between the Black Sea and the Caspian, its general direction being from west-north-west to east-south-east—from the peninsula of Taman on the Black Sea, in lat. 45° 10' N., long. 36° 45' E., to the peninsula of Apsheron on the Caspian, in lat. 40° 20' N., long. 50° 20' E.—a length of about 750 miles. The breadth, including the secondary ranges and spurs, may be stated at about 150 miles, but the breadth of the higher C. is much less, not much exceeding 60 or 70 miles. This range, formerly belonging entirely to Asia, now forms part of the boundary-line between Europe and Asia. The higher and central part of the range is formed of parallel chains, not separated by deep and wide valleys, but remarkably connected by elevated plateaus, which are traversed by narrow fissures of extreme depth. The highest peaks are in the most central ridge or chain—Mount Elburz attaining an elevation of 18,000 feet above the sea, while Mount Kasbeck reaches a height of more than 16,000 feet, and several others rise above the line of perpetual snow, here between 10,000 and 11,000 feet high; but the whole amount of perpetual snow is not great, nor are the glaciers very large or numerous. This central chain is formed of trachyte. The secondary parallel chains are, on the inner side, mostly formed of argillaceous slate and Plutonic rocks; on the outer side, of limestone. The spurs and outlying mountains or hills are of less extent and importance than those of almost any other mountain-range of similar magnitude, subsiding as they do until they

are only about 200 feet high along the shores of the Black Sea. Some parts are entirely destitute of wood, but other parts are very densely wooded, and the secondary ranges, near the Black Sea, exhibit most magnificent forests of oak, beech, ash, maple, and walnut; grain is cultivated in some parts to a height of 8000 feet, while, in the lower valleys, rice, tobacco, cotton, indigo, &c., are produced. As might be expected from the geographical situation of the C., the climate, though it is generally healthy, is very different on the northern and southern sides, the vine growing wild in great abundance on the south, which is not the case on the north. The southern declivity of the mountains, towards Georgia, presents much exceedingly beautiful and romantic scenery.

There are no active volcanoes in Mount C., but every evidence of volcanic action. There are mud volcanoes at each end of the range, and there are also famous naphtha springs in the peninsula of Apsheron. See BAKU. Mineral springs also occur in many places. The bison, or aurochs, is found in the mountains; in the forests are many fur-bearing animals; and game abounds. Bears, wolves, and jackals are among the carnivorous animals. Lead, iron, sulphur, coal, and copper are found.

The waters of the C. flow into four principal rivers—the Kuban, and the Rion or Paz (the *Phasis* of the ancients), which flow into the Black Sea; and the Kur and the Terek, which flow into the Caspian. The Russians have carried a military road, with great labour and danger, through a valley somewhat wider than most of the Caucasian valleys, between the sources of the Kuban and the Terek. This road passes over a height of about 8000 feet, and is protected by many forts, but is exposed to other dangers besides those which arise from the hostility of the mountain tribes. The only other road is by the Pass of Derbend, near the Caspian Sea.

The resistance which the Caucasian tribes have, for more than half a century, offered to the arms of Russia, has attracted to them the attention of the world. But with the capture (1859) of the prophet-chief of the Lesghians—Schamyli, the most active and determined of the foes of Russia, who for a quarter of a century withstood and harassed the armies sent against him—the power of the Caucasians was greatly shattered; and though there are several tribes which still retain their independence, the Russians are said to regard the territory as virtually subjugated, now that they have got the great leader a prisoner. The general name Circassians (q. v.) is often, but not very correctly, applied to the tribes which inhabit the Caucasus, and whose whole number is not above 1,300,000 or 1,500,000. From the situation of Mount C., there have gathered together in it tribes belonging to a greater number of distinct races than can perhaps be found within the same space anywhere upon the earth. There are more than 100 different languages or dialects spoken; the Turkish-Tatar language, however, serving for a general medium of communication. The different tribes inhabiting the C., long believed to be the purest type of the Indo-European family, are now considered not to belong to it at all, but to have more affinity with the Mongolian races. See CAUCASIAN VARIETY OF MANKIND. The principal tribes are the Tsherkesses or Circassians, Ossetes, Lesghians, Abasians, Georgians, Misheges, and Mingrelians. The Georgians and Ossetes are at least nominally Christians; the Lesghians are fanatical Mohammedans. The Byzantine emperors and kings of Georgia planted Christian churches throughout this region, and many ruins of them remain, some of which are very beautiful. But the present

Christianity of the nominally Christian tribes is more akin to heathenism than to true Christianity. In character, they are distinguished by their valour and love of freedom, but cruelty and treachery are also amongst their marked traits. They carry on a little agriculture, but live more by the care of herds and flocks, and by hunting; they are not averse to robbery; and the only manufacture which is carried on among them is that of arms.

CAUCUS. See **AMERICANISMS.**

CAUDEBEC-LÈS-ELBEUF, a town of France, in the department of Seine-Inférieure, 12 miles south of Rouen. It has manufactures of cloth, and a population of 5454.—**CAUDEBEC** is also the name of a town in the same department, situated on the right bank of the Seine, 26 miles east of Havre. It is one of the prettiest and most picturesque little towns on the Seine, with its old wooden houses and elm-shaded quays. It has a fine Gothic church of the 15th c., and manufactures of cotton, sail-cloth, leather, and soap. Formerly the capital of the Pays de Caux, C. was strongly fortified; and in 1419, so obstinate was its resistance, that it took the great English general, Talbot, six months to capture it. Pop. 2100.

CAUDETÉ, a town of Murcia, Spain, 50 miles east-south-east of Albacete. The inhabitants, 5500 in number, are chiefly engaged in agricultural pursuits.—C. is also the name of a small place in New Castile, a few miles from Teruel, where there are some of the largest bone-deposits, fossilised and unfossilised, in Europe.

CAUDINE FORKS (*Furcula Caudinæ*), two high, narrow, and wooded mountain-gorges near the town of Caudium, in ancient Samnium, on the boundary towards Campania. These gorges are celebrated on account of the defeat here suffered by the Romans in the second Samnite war (321 B.C.). Four Roman legions, commanded by the two consuls Titus Veturius and Spurius Postumius, after marching through a narrow pass, found themselves locked in a spacious valley, surrounded on all sides by lofty mountains, with no way out save that by which they entered, and another pass on the opposite side. Attempting to defile through the latter, they found it blocked up with trees and stones, and commanded by the Samnites, who had also in the meantime made themselves masters of the other pass. Consequently, the four legions were compelled to encamp in the valley. After some days, famine compelled them to surrender unconditionally. The Samnite general, Caius Pontius, according to old custom, compelled the Romans to pass under the yoke, and then permitted them to march back. This submission was regarded as too ignominious for Rome, and consequently the two consuls and the other commanders were delivered again into the hands of the Samnites, who, however, refused to have them.

CAUL is a thin membrane encompassing the heads of some children when born, and is mentioned here on account of the extraordinary superstitions connected with it from very early ages down to the present day. It was the popular belief that children so born would turn out very fortunate, and that the C. brought fortune to those purchasing it. This superstition was so common in the primitive church, that St Chrysostom felt it his duty to inveigh against it in many of his homilies. In later times, midwives sold the C. to advocates at enormous prices, 'as an especial means of making them eloquent,' and to seamen, as an infallible preservative against drowning. It was also supposed that the health of the person born with it could be told by the C., which, if firm and crisp, betokened health, but if relaxed and flaccid, sickness or death. During

last century, it was common to find advertisements in the newspapers of cauls to be sold—from £10 to £30 being the prices asked for them. So recently as 8th May 1848, there was an advertisement in the *Times* of a C. to be sold, which 'was afloat with its late owner thirty years in all the perils of a seaman's life, and the owner died at last at the place of his birth.' The price asked was six guineas. Sir John Offley, of Madeley Manor, Staffordshire, by his will, proved at Doctors' Commons 1658, devised a C. set in jewels, which had covered him when he was born, to his daughter, thereafter to her son, and then to his own heirs-male. The C. was not to be concealed or sold out of the family. See Brand's *Popular Antiquities*, vol. iii.; *Notes and Queries*, 1st series, vol. vii.

CAULAINCOURT, **ARMAND AUGUSTIN LOUIS DE**, Duke of Vicenza, a statesman of the French empire, was born at Caulaincourt, a village in the department of Somme, December 9, 1772. He entered the army at the age of fifteen, rapidly attained promotion, and, as colonel of a regiment of carbiniers, distinguished himself in the campaign of 1800. He was made a general of division in 1805, and shortly after created Duke of Vicenza. In 1807, he was appointed ambassador at St Petersburg, where he soon gained the confidence of the czar, who often made use of his advice. Disputes having arisen between Alexander and Napoleon, C. endeavoured to restore amity and prevent war; but his proposals being rejected, he, in 1811, asked permission to resign his post, and received an appointment in the army of Spain. During the events of 1813, he was frequently employed as plenipotentiary in diplomatic affairs. In November of 1813, he was made Minister for Foreign Affairs, and in this capacity attended the congress at Chatillon, January 1814. When Napoleon abdicated, C. endeavoured to make use of his influence with Alexander to obtain the most favourable conditions for the fallen emperor, and, chiefly through his intervention, the island of Elba was ceded to Napoleon. During the Hundred Days, C. resumed office as Minister of Foreign Affairs, and was made a peer. On the second restoration, he retired into private life. He died in Paris, February 19, 1827.—His brother, **AUGUST JEAN GABRIEL**, Count of Caulaincourt, born 1777, served with distinction in all the campaigns from 1792 to 1812, when he fell in battle.

CAULIFLOWER, a variety of the common kale or cabbage, affording one of the most esteemed delicacies of the table. It was cultivated as a culinary vegetable by the Greeks and Romans. Its culture was, however, little attended to in England till the end of the 17th c.; but after that time, it rapidly increased, and prior to the French Revolution, C. formed an article of export from England to Holland, whilst English C. seed is still preferred on the continent. The C. is entirely the product of cultivation. The leaves are not in this, as in other varieties of the same species generally, the part used, nor are they so delicate and fit for use as those of most of the others, but the flower-buds and their stalks, or, properly speaking, the inflorescence of the plant deformed by cultivation, and forming a head or compact mass generally of a white colour. There are many subvarieties, but all of them are rather more tender than the ordinary forms of the species, and in Britain generally require more or less protection during winter, whilst the seed is sown on hotbeds, that the plants may be ready for planting out in spring. Later sowings are made in the open ground. The C. requires a moist rich loamy soil, with abundance of manure, and above all, very

careful cultivation, which is directed to the object of having the heads not merely large, but as compact as possible. Great care is bestowed on the selection of proper plants for seed. In Scotland, C. plants almost always require the protection of the frame during winter. C. may be preserved for some time fit for use by pulling the plant up by the roots, and hanging it in a cold and dry place.—BROCCOLI (q. v.) may be regarded as another kind of cauliflower.

CAULKING is the operation of driving oakum or untwisted rope into the seams of a ship, to render them water-tight. The quantity thus driven in depends on the thickness of the planking; it varies from 1 to 13 double threads of oakum, with 1 or 2 single threads of spun-yarn. The caulker first *raims* or *reems* the seam—that is, drives a C. iron into it, to widen the seam as much as possible, and close any rents or fissures in the wood; he then drives in a little spun-yarn or white oakum with a mallet and a kind of chisel, and afterwards a much larger quantity of black or coarse oakum. The fibres are driven in until they form a densely hard mass, which not only keeps out water, but strengthens the planking. The seam is finally coated with hot pitch or resin.

CAULOPTERIS, a generic name for the stems of fossil tree-ferns found in the Carboniferous and Triassic measures. They are hollow, and covered with the markings similar to the leaf-scars on recent tree-ferns. Twelve species have been described.

CAUSE. The words 'Cause,' 'Causality,' and 'Causation,' although familiar and intelligible in ordinary speech, have given rise to some of the most subtle questions in philosophy and theology. We shall here advert briefly to the chief meanings of these terms, and in so doing, we shall indicate the disputes that have arisen in connection with them.

In common language, we are accustomed to describe as the C. of an event, the one event immediately preceding it, and but for which it would not have happened. A man slips his foot on a ladder, falls, and is killed: we give the slipping of the foot as the C. of the fatality. A legislative assembly decides a question of great moment by the casting vote of the president, who is then not unfrequently spoken of as the C. of all the good or evil that followed on the decision. Now, a slight examination shews that this mode of speaking is defective, as expressing the whole fact, or, in other words, presumes a great deal that is not stated. In the supposed death from a fall, there are many conditions necessary to the result besides the slipping of the foot: the weight of the body, the height of the position, the hardness of the ground, the fragility of the human frame, all enter into the C. strictly represented; but for practical purposes, we leave out of account all those elements that are not at the moment under our control, and allude to the one that is so. And when we speak of the decision of an assembly being the effect of the president's vote, we mean that his share in the responsibility is peculiarly great, or that, in order to turn the vote in one way, all that is necessary is to secure his individual opinion. If we do not enumerate all the conditions of the event, it is because some of them will, in most cases, be understood without being expressed, or because, for the purpose in view, they may without detriment be overlooked.

When, however, we aim at strict accuracy, as in the investigations of science, we must not be content with singling out the one turning event, but must enumerate everything that is necessary to the

result. A *scientific C.* is the full assemblage of *conditions*, failing any one of which, the effect would not happen. In a full explanation of the phenomenon of the tides, we must enumerate all the circumstances connected with their production—the attraction of the sun and moon, the motions of the earth and the moon in their orbits, the globular form and rotation of the earth, the liquidity of the sea, the mode of distribution of the sea over the earth—every one of which facts is an essential in the full causation. The effect cannot be adequately accounted for without adverting to every one of those conditions, and it is therefore the sum-total of them that is rightly described as the C. of the tides. Taking this complete view of causation, it is found that every event that happens is the sequel to some previous event, in whose absence it would not have been, but which being present it is sure to occur. Between the phenomena existing at any instant, and the phenomena existing at the succeeding instant, there is an invariable order of succession; to certain facts, certain facts always do, and, as we believe, will continue to succeed. The invariable antecedent is termed the C.; the invariable consequent, the effect. What is termed the *Law of Universal Causation*, consists in this, 'that every consequent is connected in the manner now described with some particular antecedent, or set of antecedents.'—Mill's *Logic*, book iii. chap. 5.

The physical philosopher—the chemist or physiologist—trusts to the uniformity with which the same C. yields the same effect; and if he can find out the true succession in one instance, he is satisfied that the same succession will always hold. In the physical sciences, therefore, there is no dispute as to the law of causation itself; the controversies on that head occur only in *metaphysics*. It is made a serious problem by mental philosophers, and also by theologians, to determine how we come by the irresistible belief that we are said to possess, that every event has, and must have a cause. There are many answers to this question: eight are enumerated by Sir William Hamilton (*Discussions on Philosophy*, p. 611, 2d edit.). It is only necessary, however, to advert to the two radically opposite points of view from which the subject is now surveyed.

The one view is, that we have an instinct or *intuition* of the mind by which we are compelled to recognise this law, so that to us it is a necessary truth, which we cannot escape from if we would. Our experience of the outer world, doubtless, shews us that things follow one another in an orderly and uniform manner, that the stone that sinks in water to-day does not float to-morrow, but no experience could give us the sense of commanding necessity that we have of the law of C. and effect. 'Causation is not the mere invariable association of antecedent and consequent; we *feel* that it implies something more than this.' The philosophers who maintain this side give forth two different affirmations: the *one*, that we actually possess an intuitive belief of necessary causation; and the *other*, that our possession of the belief is a sufficient proof that the law actually pervades the universe. Experience operates to confirm us in those instinctive tendencies, but no amount of experience would have been able to create them.

The latest modification of the theory that ascribes our belief in causation to an intuition of the mind, is the doctrine promulgated by Sir W. Hamilton, to the effect that 'we are unable to think that the quantity of existence, of which the universe is the conceived sum, can be either amplified or diminished. We are able to conceive, indeed, the creation of a world; this, in fact, as easily as the creation of an

atom. But what is our thought of creation? It is not a thought of the mere springing of nothing into something. On the contrary, creation is conceived, and is by us conceivable, only as the evolution of existence from possibility into actuality, by the fiat of the Deity. And what is true of our concept of creation, holds of our concept of annihilation. We can think no real annihilation—no absolute sinking of something into nothing.—*Discussions*, p. 619. Thus, every effect must have a C., and every C. must have its effect, because, if it were not so, there would be either a pure creation or a pure annihilation, neither of which, according to Sir W. Hamilton, is thinkable or conceivable by the human mind. This doctrine, however, has not found acceptance even by those who, if not actual disciples of the author, are most disposed to receive his philosophy generally, as may be seen by referring to Professor Fraser's *Essays in Philosophy*, p. 170; M'Cosh *On the Divine Government*, p. 529, 4th edition; and Mansel, art. Metaphysics, *Encyclopædia Britannica*. So far from the creation or annihilation of matter or force being inconceivable, it may be said with truth, that until the end of last century, it was not known as a fact that the materials of the globe are absolutely indestructible. The effects of combustion and evaporation could hardly suggest anything else than the annihilation of a certain portion of material. Combustion merely transformed the material consumed into other shapes, nothing being absolutely lost. So much for ponderable matter. As regards force, or moving power, the demonstration that this is never absolutely lost, even on the many occasions when it is so to all appearance, is a still later result of laborious scientific inquiries, being, in fact, one of the conclusions arrived at within the last few years. See FORCE. To represent, therefore, one of the latest achievements of experimental science as a primitive intuition of the human mind, is to violate, in the strongest manner, our sense of propriety and consistency.

As opposed to the intuitional doctrine of causation, we have a variety of views by Hume, Dr Thomas Brown, and others, which need not be specified in detail. One may be given as an example. It has been seen that there are two affirmations in the theory just discussed; that the mind possesses an intuitive belief of causation, and that the possession of this belief is evidence of the existence of the law. Now, one or both of these affirmations may be denied; and the denial of either, by even a small minority of the human race, is held to be fatal to the theory, because *unanimity* is essential to the establishment of a universal instinct. Now, many men may possess an instinctive belief in the necessity of a cause to all effects, and of an effect to all causes; some, it is affirmed, do not; it cannot, therefore, be a universal or essential part of human nature.

In like manner, the second affirmation—namely, that the possession of an instinctive belief is a proof of the truth of the thing believed—is denied, on the ground that our instincts often dispose us to believe things that experience shews to be untrue. We have a strong natural tendency to believe in the universality and continuance of the exact order of things that we are ourselves born into, and are only put right by seeing the contrary. 'A mere disposition to believe, even if supposed instinctive, is no guarantee for the truth of the thing believed. If, indeed, the belief ever amounted to an irresistible necessity, there would be then no use in appealing from it, because there would be no possibility of altering it.' But even then the truth of the belief would not follow: it would only follow that mankind were under a permanent necessity of believing what

might possibly not be true; just as they were under a temporary necessity—quite as irresistible while it lasted—of believing that the heavens moved, and the earth stood still. But, in fact, there is no such permanent necessity. Many of the propositions of which this is most confidently stated, great numbers of human beings have disbelieved. The things which it has been supposed that nobody could possibly help believing, are innumerable; but no two generations would make out the same catalogue of them.—Mill's *Logic*, book iii. chap. 21. Mr Mill and others hold that the proof of the law of causation rests exclusively on the uniform and growing experience of the human race. This, however, is not inconsistent with our possessing the natural instinct above alluded to, by which we are led to suppose that what is will continue, and what has been will be repeated; an instinct that *coincides*, to a certain extent, with the law of C. and effect, and is therefore a predisposition on our part to accept what experience teaches on this head. It is only maintained that the instinct is of itself *no proof*, although useful in so far as it prepares us for what there is real evidence for believing. By yielding to the instinct in its crudest shape, the inhabitant of the tropics scouts the idea that water can ever be solid; the African would deny the existence of white men; and even an intelligent European could not be persuaded that any metal would float. Experience must correct the instinctive tendencies, otherwise no reliance can ever be placed upon them; by which we acknowledge it as the sole test of truth, while intuitive dispositions are no test whatever.

Even those who maintain the instinctive necessity of the conviction we are discussing, admit two great exceptions—viz., the existence of a FIRST C., itself uncaused, and the Liberty of the Will, or the exemption of human actions from the rule that applies so strictly to physical nature.

It is further contested between the two opposite schools of philosophy, whether or not MIND be the sole ultimate C. of all phenomena, as it is the C. most familiar to us—namely, the source of our voluntary exertions. On one side, it is affirmed to be 'inconceivable that dead force could continue unsupported for a moment beyond its creation. We cannot even conceive of change or phenomena without the energy of a mind.' 'The word action has no real significance, except when applied to the doings of an intelligent agent.' 'Phenomena may have the semblance of being produced by physical causes, but they are in reality produced by the immediate agency of a mind; if they do not proceed from the human, they are the result of the divine will.' To this it is replied, that we are here taking for granted that every kind of power is analogous to that which we happen to be first acquainted with; but it is a pure assumption without proof or relevance, to suppose that all modes of energy must conform to this one type.—Mill, book iii. chap. 5. It is further pointed out that even in ourselves, pure mind, or mind acting by itself, is not known to be an efficient C.; it must be mind together with body. The labourer cannot sustain a day's toil merely because of his *wish* to do so; he must be fed, and rested, and have all his bodily organs in good condition, in order to do his work. The human system, when employed as a prime mover, can no more dispense with the material conditions, than a steam-engine can work without coal, or when out of repair.—Bain *On the Emotions and the Will*, p. 472.

The subject of causation was very particularly studied by Aristotle. He enumerated four different kinds of causes, which have ever since had a place in

philosophy. These are the *material*, the *formal*, the *efficient*, and the *final*. The first, or *material*, is what anything is made of; brass or marble is the material C. of a statue. The *formal* is the form, type, or pattern according to which anything is made; the drawings of the architect would be the formal C. of a house. The *efficient* is the power acting to produce the work, the manual energy and skill of the workmen, or the mechanical prime mover, whether that be human or any other. The *final* C. is the end or motive on whose account the work is produced, the subsistence, profit, or pleasure of the workman. Aristotle mentions the case of a physician curing himself, as exemplifying all the causes in one and the same subject. It is obvious that these are what we should now term the aggregate of *conditions* necessary to the production of any work of man; it being essential that there should be a motive for the work (final), a material to operate upon (material), a plan to proceed by (formal), and an exertion of energy to do what is wanted (efficient). When nature is viewed as the result of a creative mind, these causes are considered as inhering in the Divine contriver.

In popular language, C. is held as identical with *explanation*. In other words, when a phenomenon which we are puzzled to account for is explained to our satisfaction, we say that we know its cause, but we often seek for, and are satisfied with, explanations that have no value in the view of science; and on the other hand, refuse to rest content with such as are scientifically valid. People occasionally insist on knowing the C. of gravity itself, something deeper than the discovery of Newton, and whatever explanation satisfies the mind, would be accepted as the cause. Sometimes a theological explanation is offered, and at other times, a metaphysical necessity is put forth.

CAUSTIC (Gr. burning), in Medicine and in Chemistry, is the term applied to such substances as exert a corroding or disintegrating action on the skin and flesh. *Lunar C.* is nitrate of silver, and *common C.* is potash. When used as a C. in medicine, the substance is fused and cast into moulds, which yield the C. in small sticks the thickness of an ordinary lead pencil, or rather less.—*Caustic* is also used in chemistry in an adjective sense—thus C. lime, or pure lime (CaO), as distinguished from mild lime, or the carbonate of lime (CaO,CO₂), C. magnesia (MgO), and mild magnesia (MgO,CO₂), &c.

CAUSTIC, CATACAUSTIC, and DIACAUSTIC. In Optics, Caustic is the name given to the curved line formed by the ultimate intersections of a system of rays reflected or refracted from a reflecting or refracting surface, when the reflection or refraction is inaccurate. When the caustic curve is formed by reflection, it is called the *Catacaustic*—sometimes simply the *Caustic*; when formed by refraction, it is called the *Diacaustic Curve*. In mathematical language, a curve formed by the ultimate intersections of a system of lines drawn according to a given law is called the *envelope*, and is such that the lines are all tangents to it. As in a system of rays reflected or refracted by the same surface *all* follow the same law, it follows that the C. is the envelope of reflected or refracted rays.

An example of the catacaustic is given in the annexed figure for the case of rays falling directly on a concave spherical mirror, BAB', from a point so distant as to be practically parallel. The curve may be said to be made up of an infinite number of points, such as C, where two very near rays, such as P, Q, intersect after reflection. This catacaustic is an epicycloid. The curve varies, of

course, with the nature of the reflecting surface. In the case represented in the figure, the cusp point is at F, the principal focus. No such simple example can be given of the diacaustic curve as

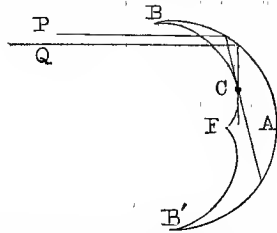

that above given of the catacaustic. It is only in the simplest cases that the curve takes a recognisable form. In the case of refraction at a plane surface, it is shewn that the diacaustic curve is the evolute either of the hyperbola or ellipse, according as the refractive index of the medium is greater or less than unity.

The reader may see a catacaustic on the surface of tea in a tea-cup about half full, by holding the circular rim to the sun's light. The space within the caustic curve is all brighter than that without, as it clearly should be, as *all* the light reflected affects that space, while no point without the curve is affected by more than the light reflected from half of the surface.

CAUTION, in the Law of Scotland, like *Guaranty* (q. v.) in England, is an obligation undertaken by a second party, whereby he binds himself, failing the primary obligant, to fulfil his obligation, whether it be of a pecuniary nature or otherwise. *Cautionary obligations*, like engagements of guaranty, are thus essentially of a secondary nature; and previous to the passing of the Mercantile Law Amendment Act (19 and 20 Vict. c. 60), it was customary in Scotland to distinguish between what was called *cautionary proper*, where the cautioner was bound avowedly as such, and *improper cautionary*, where both cautioner and principal were bound as principals. Since this period, however (1856), cautionary proper has ceased to exist otherwise than as the result of positive stipulation, under the saving-clause attached to the eighth section of the statute referred to, which enacts that 'nothing herein contained shall prevent any cautioner from stipulating, in the instrument of caution, that the creditor shall be bound, before proceeding against him, to discuss and do diligence against the principal debtor.' *Cautionary obligations* are generally gratuitous, being, for the most part, undertaken from motives of friendship; but it is by no means uncommon for them to be entered into in consideration of a premium paid by the person guaranteed, or by those interested in his fortunes. The existence of such a consideration has always been optional in Scotland, and this rule has recently been adopted in England (19 and 20 Vict. c. 97, § 3). Where a premium is paid, the transaction becomes a mere insurance of solvency, honesty, or efficiency; and associations of great public utility (see *GUARANTEE ASSOCIATION*) have been formed, both in England and Scotland, for the purpose of undertaking, as a speculation, to guarantee the good conduct of persons employed either in public or private offices of trust. The tendency of judicial decisions, both in England and Scotland, for many years past, has been to require greater strictness than formerly in the constitution of cautionary obligations; and latterly, the legislature itself has stepped in with the same object in view. By the statute which we have

already quoted, it is enacted that all such engagements shall be in writing, subscribed by the person undertaking or making them, or by some person duly authorised by him, otherwise they shall have no effect. If a cautionary obligation is dependent on a condition, it will, of course, be ineffectual unless the condition be complied with. The cautioner may, in general, plead every defence which was competent to the principal debtor, and the extinction of the primary obligation extinguishes the secondary one. The discharge of one cautioner, moreover, unless consented to by the rest, is a discharge to all. Cautioners bound subsequent to the passing of the act mentioned, have, in consequence of the eighth section already referred to, no right to what in Scotland was called Discussion (q. v.); but those bound prior to that act are entitled, as formerly, to require that the creditor shall first call on the principal debtor, and compel him to pay in so far as he is able, or, in law language, *discuss* him. The cautioner is entitled, on payment of the obligation, to an assignation of the debt and diligence, by which means he comes, in all respects, into the creditor's place; and, moreover, if the solvency or other conditions of the principal debtor should seem precarious, he may adopt legal measures for his relief. Co-cautioners, or persons bound together, whether their obligations be embodied in one or several deeds, are entitled to mutual relief. But where a co-cautioner obtains relief from the others, he must communicate to them the benefit of any deduction or ease which may have been allowed him in paying the debt.

Cautionary obligations are often undertaken in behalf of persons in situations in which the engagements and liabilities are prospective. In order that such obligations may be binding, the nature and extent of the liability must be fairly and fully disclosed to the cautioner. But while the cautioner must not be exposed to the danger arising from any transaction not in his view in entering into the contract, he is not entitled to withdraw without due notice and a reasonable time being given for entering into a new arrangement. The question whether the effects of a bond are prospective, or retrospective merely, will depend on its terms; the *presumption*, where these are in any way doubtful, being always in favour of the latter alternative. The creditor is bound to exercise a certain degree of vigilance over the conduct and circumstances of the person guaranteed, and not to permit any very gross departure from the terms of the contract, to the prejudice of the cautioner. Should this obligation be neglected, the cautioner will be freed from his obligation.

CAUTION, for a cash credit. See CASH CREDIT.

CAUTION, JUDICIAL, in the Law of Scotland, is of two kinds—for appearance, and for payment. If a creditor makes oath before a magistrate, that he believes his debtor to be meditating flight (*in meditatione fugæ*), he may obtain a warrant for his apprehension; and should he succeed in proving the alleged intention to flee, he may compel him to find C. to abide the judgment of a court (*judicio sisti*). The second kind of judicial C. is by *Bond of Presentation*, which is granted when the creditor is about to execute personal diligence, or has done so, and the cautioner, on condition of an indulgence to the debtor, binds himself that the debtor shall be forthcoming at the appointed time, otherwise he himself will pay the debt. The object of this form of C. is simply to protect the debtor from imprisonment, and allow him time.

CAUTION, JURATORY. See POOR'S ROLL, and 13 and 14 Vict. c. 36, § 34.

CAUVERIPU'RAM, a town of the district of Coimbatore, in the presidency of Madras, on the right bank of the Cauvery, in lat. 11° 54' N., and long. 77° 48' E. It takes its name from the neighbouring gorge of 30 miles in length through the Eastern Ghauts, along which the Cauvery finds a passage.

CAUVERY, a river in the south of Hindustan, rising near lat. 12° 25' N., and long. 75° 34' E., and flowing, with a course of 472 miles, into the Bay of Bengal by various mouths. Its delta, with a coast of 80 miles, and a depth of 70, lies almost wholly in the district of Tanjore. The C. is peculiarly available for irrigation; and for improving it in this respect, a grant of £50,000 was sanctioned in 1841. During the rainy season, the stream is navigable for small-craft.

CA'VA, LA, a town of Naples, in the province of Principato Citra, 3½ miles north-west of Salerno. It is a flourishing place, with manufactures of silk, cotton, linen, and pottery. Pop. 13,000. About a mile from C. is the celebrated Benedictine monastery of the Trinity, with its magnificent archives, containing 60,000 MSS. and 40,000 parchment rolls. Its library, at one time also rich in MSS. and rare printed books, has been dispersed. In the monastery church are the tombs of Queen Sibilla and of various anti-popes.

CAVAIGNAC, LOUIS EUGÈNE, was born in Paris 1802, and was educated in the Polytechnic School, and the *Ecole d'Application* at Metz. He first served in the Morea, and afterwards in Africa (whither he was sent in 1832 into a kind of honourable exile, in consequence of a too free expression of opinion in favour of republican institutions), where he acquired great distinction by his energy, coolness, and intrepidity. He was made chef de bataillon in 1837, and rose to the rank of brigade-general in 1844. In 1848, he was appointed governor-general of Algeria, but in view of the impending revolutionary dangers, was called to Paris, he having also been elected as a delegate to the National Assembly by the two departments of Lot and Seine. In the insurrection of June which followed, C., as Minister of War, had a most difficult task to play, and he displayed, during the four days and nights of the contest, remarkable presence of mind, firmness, and activity. His plan of action appeared strange and almost traitorous at the time. In opposition to the wishes of the National Assembly, who desired that the troops should be dispersed over Paris, he divided his men into three separate bodies, which had to clear their several routes from obstacles, in order to effect a reunion, streets and even quarters of the city being left for some time without military protection. Regarding the outbreak more as the beginning of a civil war than a mere insurrection, he, in fact, met the insurgents in true order of battle. His operations were successful, and his clemency was as remarkable as his generalship. When he had the power of assuming the dictatorship, he resigned it into the hands of the National Assembly, which appointed him President of the Council. As a candidate for the presidency of the republic, when Louis Napoleon was elected, he received about a million and a half of votes. On the *coup d'état* of December 1851, C. was arrested, but released after a short detention; and though he consistently refused to give in his adhesion to the Empire, he was permitted to reside in France without molestation. He died very suddenly of heart disease in October 1857, at his country house near Tours, and was buried in the cemetery of Montmartre, Paris, in presence of many thousand spectators, including several republican leaders. In debates, C. was remarkably unlike

his countrymen, being not voluble and declamatory, but sober, clear, and moderats.

CAVALIER, in Fortification, is a defence-work constructed on the *terre-plein* or level ground of a bastion. It rises to a height varying from 8 to 12 feet above the rampart, and has a parapet about 6 feet high. Its uses are to command any rising ground held by the enemy, within cannon-shot; and to guard the curtain, or plain wall between two bastions, from being enfiladed. For these purposes, it mounts heavy ordnance. It may be either curved, or bounded by straight sides.

CAVALIER (Fr. *chevalier*; Ital. *cavaliere*; Span. *caballero*, probably from the Latin *caballus*, a horse), originally meant any horse-soldier, but in English history is the name given to the party which adhered to King Charles I., in opposition to the Roundheads (q. v.) or friends of the Parliament.

CAVALLER-MAGGIORE, a town of the Sardinian states, in the province of Saluzzo, 24 miles north-east of Coni. It was formerly fortified and defended by two castles, but of these there is now hardly a vestige remaining. It is a busy place, with a population of 5300.

CAVALRY is a general name for horse-soldiers or troopers. The subdivisions are very numerous; such as Guards, Dragoons, Lancers, Hussars, Cuirassiers, Mounted Rifles, &c. The C. force of the British army is usually divided into *Household* and *Line*. The numbers voted for 1860—1861 were:

	Household Cavalry.	Line Cavalry Home Service.	Line Cavalry in India.
Officers,	99	526	385
Non-commissioned Officers,	188	884	642
Rank and File,	884	8919	6216

The difference between the household C. and the line is this: The former belong to the *Guards*, a specially favoured body of troops; while the latter comprise all who are *not* *Guards*. The regiments are 28 altogether. During more than half a century, the number was 26; but in 1858, two new regiments were created—viz., one to restore the 5th Dragoons, which had been struck out of the army list in 1799 for some misconduct; and an 18th regiment of Dragoons. The list comprises 2 regiments of Life Guards (red), 1 of Horse Guards (blue), 7 of Dragoon Guards, and 18 of Dragoons. Of these last-named 18 regiments, the 1st, 2d, and 6th, are simply called Dragoons; the 3d, 4th, 13th, and 14th, Light Dragoons; the 5th, 9th, 12th, 16th, and 17th, Lancers; the 7th, 8th, 10th, 11th, 15th, and 18th, Hussars. A distinction is sometimes made in the above regiments between *heavy* and *light* C.; and, in continental armies, this distinction is very marked; but in England, the men and horses are not selected with much reference to this matter; the heavy being often too light, and the light too heavy, to correspond with their designations.

The line C. regiments, in the British service, have generally 10 troops of 68 rank and file each, with about 115 commissioned and non-commissioned officers. Those in camp or barrack at home are about 120 fewer in number; while the *Guards* are little more than half as numerous. The officers for a full C. regiment comprise 1 colonel, 2 lieutenant-colonels, 2 majors, 10 captains, 29 subalterns and other commissioned officers, and 71 non-commissioned officers. A lieutenant-colonel in the *Guards* C. takes rank with a full colonel in the line C.; and a major in the former with a lieutenant-colonel in the latter—an arrangement that gives

rise to some favouritism and jealousy; for the *Guards* are in no sense more meritorious soldiers than the line.

The inspector of C. personally examines every C. recruit. Nine months of drilling is the least time requisite to make a recruit fit to mount on duty, during which period he is drilled for eight hours a day. Londoners and agricultural labourers are mostly sought for; provincial mechanics are not found so available. The purchase of C. horses is an important matter. The veterinary surgeon of the regiment is sent out to buy; but no horse is paid for till approved by the commanding officer. The usual maximum of price fixed is £25, for a horse 3 to 5 years old; but the horse costs the nation £50 or £60 by the time it is thoroughly fit for service. A C. college was established near Richmond in 1857, to give a good C. education to the sons of noblemen and gentlemen intended for the service; but it is not a government establishment.

A full C. regiment costs the country about £25,000 a year for pay, clothing, accoutrements, and horses. See **DRAGOONS**, **GUARDS**, **LANCERS**, &c.

CAVALRY TACTICS. Authorities differ concerning the proportion that ought to be observed between cavalry and infantry in an army. In France and Austria, the ratio is about 1 to 5; in Prussia and Bavaria, 1 to 4; in Russia, 1 to 6; in England, 1 to 8.

So far as concerns actual duties, heavy cavalry charge the enemy's cavalry and infantry, attack the guns, and cover a retreat; while the light cavalry make reconnaissances, carry dispatches and messages, maintain outposts, supply pickets, scour the country for forage, aid the commissariat, pursue the enemy, and make rapid manœuvres. At the battle of Balaklava, the heavy-cavalry charge was within the reasonable duties of the troops, but that of the light cavalry was not; the former succeeded, the latter failed. In the English cavalry, as stated in the last article, the distinction between heavy and light, in men and horses, is not observed so closely as on the continent; and C. T. are believed to suffer a little in consequence. A cavalry horse will walk 4 miles in an hour on general service, trot 8 miles in manœuvring, and gallop 11 miles in making a charge. The cavalry usually attack in line against cavalry, *en échelon* against artillery, and in column against infantry. When an attack is about to be made, the cavalry usually group into three bodies—the attacking, the supporting, and the reserve. Close combat and hand-to-hand struggle are the province of cavalry; infantry and artillery may fight at a distance, but cavalry cannot. It is rare that two bodies of cavalry stand to fight each other; the weaker of the two, or the less resolute, usually turns and gallops off. The work to be done by the horse is to pursue, to overwhelm, to cut down. They cannot wait to receive an attack like infantry; they must either pursue or retreat; and on this account it has been said, 'rest is incompatible with cavalry.' The infantry and artillery more frequently win the victory; but the cavalry prepare the way for doing this, capture prisoners and trophies, pursue the flying enemy, rapidly succour a menaced point, and cover the retreat of infantry and artillery, if retreat be necessary. Cavalry is necessary to finish off work mainly done by others; and, without its aid, signal success is seldom obtained on the field. Many of the brilliant achievements of the British in 1857 and the following year, in India, were rendered almost nugatory by the paucity of cavalry.

CAVAN, the capital of Cavan county, Ireland, is situated on a branch of the Annalee, in a rich

romantic vale, 70 miles north-west of Dublin. The suburbs are chiefly wretched cabins. The principal buildings are in the west outskirts. There is a fine public garden, bequeathed by a late Lady Farnham. The extensive and beautiful demesne of Lord Farnham lies between C. and Lough Oughter, which is about 5 miles west of the town. Pop. 3254. Agriculture forms the chief industry of the people.

CAVAN, an inland county in the south of Ulster Province, Ireland. It lies in the centre of the narrowest part of Ireland, the west end being only 18 miles from the Atlantic, and the east end 20 miles from the Irish Sea. Area, 746 square miles. About three-fourths of the land is arable. The surface is undulating, with bogs and hills in the north-west. There are many small loughs in the county. The chief rivers are the Erne, the Woodford, and the Annalee. The east half of C. rests on clay-slate and grauwacke; the mountain-district in the west consists of the Carboniferous formation. Of minerals, C. affords coal, iron, lead, and copper. There are many mineral springs. The climate is cold and damp; and the soil is poor, wet, and clayey, except along the streams. In 1858, about a fourth of the county was in crop, the chief crops being oats, potatoes, turnips, and flax. The farms are small. The population, which in 1841 was 243,158, in 1851 had dwindled down to 174,071. Agriculture forms the chief industry, but linen is manufactured to a considerable extent. Chief towns—Cavan, Bailieborough, and Belturbet. C. returns two members to parliament. The National Schools, in 1851, numbered 174, with 15,097 pupils.

CAVATINA, a short form of operatic air, of a soft character, differing from the ordinary aria in consisting only of one part, and that spun out more in the form of a song. Modern composers have, however, disregarded this difference. Rossini mixes both. Weber, in his operas, adds an introduction or a recitative. The most perfect specimen of the C. is that in Meyerbeer's opera of *Robert the Devil*.

CAVE, EDWARD, deserves mention as the founder of the *Gentleman's Magazine*, the first literary journal of the kind ever established. He was born at Newton, in Warwickshire, in 1691; obtained a good education at Rugby; and after many vicissitudes, became apprentice to a printer. Obtaining money enough to set up a small printing-office, he projected the *Gentleman's Magazine*, which has now existed more than a century and a quarter. He was the friend and early patron of Samuel Johnson. C. died January 1754.

CAVE, WILLIAM, an English divine and scholar of distinction, was born at Pickwell, Leicestershire, December 1637. He studied at Cambridge; was appointed to the vicarage of Islington in 1662; afterwards to the rectory of Allhallows the Great, London; and in 1690 to the vicarage of Isleworth, Middlesex. He died at Windsor, August 4, 1713. He was the author of many works of a religious character, the most important of which are the *Lives of the Apostles*, *Lives of the Fathers*, and *Primitive Christianity*, which were once standard works.

CAVEAT (Lat. *caveo*, to beware), a judicial warning or caution. Caveats, in England, are used to stop the enrolment of decrees in Chancery, the issuing of lunacy commissions, &c. It consists in an intimation by the party interested to the proper officer, to prevent him from taking any step without such intimation being made to the said party as shall enable him to appear and object.

CAVENDISH, HENRY, a distinguished philoso-

pher of the 18th c., son of Lord Charles Cavendish, and nephew of the third Duke of Devonshire, was born at Nice, October 10, 1731. He studied at Cambridge, and devoted his whole life to scientific investigations. The large fortune which was bequeathed to him by an uncle, enabled him to follow uninterruptedly his favourite pursuits. He almost secluded himself from the world, and was so averse to meet with strangers, that he had his library—a magnificent one—huilt at a distance from his house, so that he might not encounter persons coming to consult it; and his female domestic servants had orders to keep out of his sight, on pain of dismissal. His dinner he ordered daily by a note placed on the hall-table. He died, unmarried, February 1810, leaving considerably more than a million sterling to his relatives. As a philosopher, C. is entitled to the highest rank. To him it may almost be said we owe the foundation of pneumatic chemistry, for prior to his time it had hardly an existence. In 1760, he discovered the extreme levity of inflammable air, now known as hydrogen gas—a discovery which led to balloon experiments, and projects for aerial navigation; and later, he ascertained that water resulted from the union of two gases—a discovery, however, to which Watt (q. v.) is supposed to have an equal claim. The accuracy and completeness of C.'s processes are remarkable. So high an authority as Sir Humphry Davy declared, that they 'were all of a finished nature, and though many of them were performed in the very infancy of chemical science, yet their accuracy and their beauty have remained unimpaired amidst the progress of discovery.' C. also wrote papers on electricity, astronomical instruments, &c.

CAVENDISH, WILLIAM, Duke of Newcastle, a distinguished loyalist of the 17th c., son of Sir Charles Cavendish, younger brother of the first Earl of Devonshire, was born 1592. His learning and winning address made him a favourite at the court of James I., who, in 1610, made him a Knight of the Bath. Other honours rapidly succeeded. In 1620, he was made a peer of the realm. Charles I., about 1628, gave him the title of Earl of Newcastle-upon-Tyne, and in 1638 intrusted him with the tuition of his son, afterwards Charles II. His support of the king during the contest with the parliamentary forces was munificent. He contributed £10,000 to the treasury, and raised a troop of 200 knights and gentlemen, who served at their own cost. As general of all the forces raised north of the Trent, he had power to issue declarations, confer knighthood, coin money, and raise men; and the last part of his commission he executed with great zeal. The banquets C. gave to the king when he went north were magnificent enough to find record in history; one of them cost no less than £15,000, even in those days when money was more valuable than it now is. After the battle of Marston Moor, C. retired to the continent, where he resided, at times in great poverty, until the Restoration. On his return, he was created Duke of Newcastle. He died December 25, 1676. On the continent, he devoted himself to literature, and wrote a book on the management of horses, and several plays, not of a character to increase any man's reputation for intelligence.

CAVENDISH, MARGARET, Duchess of Newcastle, second wife of the above, born about the end of the reign of James I., is perhaps one of the most remarkable instances on record of a person afflicted with the *cacoëthes scribendi*, who had no capacity whatever for writing. She produced no less than 13 folio volumes, 10 of which were printed, treating,

indifferently, on all subjects in prose and poetry, and careless in all, both as to grammar and style. Her mania for scribbling kept up her maids at night, so that, if she chanced to wake with anything on her mind, they might be ready to note it down at once. The duchess was relieved, but a dead-weight fell upon the field of literature. She died in 1673.

CAVES, or CA'VERNS (Lat. *cavus*, hollow), are hollow places in the earth. They are either natural or artificial. Natural C. have been produced by the fracture and dislocation consequent on the upheaval of the strata, by water, or by both causes combined. The denuding or eroding power of water, which has produced the materials of stratified rocks, has formed caverns in the courses of rivers and on the coast-line of the sea. The moving waters, carrying with them gravel and sand, enter natural cracks and crevices, and by abrading their walls, increase their size, so as to form C.; or they attack less indurated portions of the solid strata, and form cavities bounded by the harder rock. Such caverns are of frequent occurrence round the shores of Britain, and indicate, where they occur, an ancient sea-margin of the island. In limestone rocks, the destroying power of water is increased when it contains chemical agents which have the power of dissolving the substance of the rock, and so causing it to be carried off in solution by the water.

C. most frequently occur in limestone rocks. They especially abound in the oolitic limestone, which on this account was called by the earlier continental geologists 'cavern limestone.' The celebrated C. of Franconia in Germany, of Kentucky (q. v.) in America, that of Kirkdale in Yorkshire, and many others, occur in this formation. Next to limestone, the triassic measures, containing rock-salt, a material easily removed by water, most abound in caverns. They are also frequently met with in igneous rocks—the picturesque cave of Fingal, in Staffa, is formed in basalt; and in South America and Iceland the modern lava contains large caverns.

Many caverns have a calcareous incrustation lining their interior, giving them a gorgeous appearance. Sometimes this deposit is pure white, and has, when the cave is lighted up, a richness and transparency that cannot be imagined. It is, however, more generally coloured by the impurities which the water has taken up from the superincumbent strata. To the incrustations which are suspended from the roof, like icicles, the name stalactite is given, while those rising from the floor are designated stalagmites. Sometimes the pendent stalactite is produced so as to meet the ascending stalagmite, and form pillars, as if to support the roof, as in the 'Organ' in the Blue John Mine, Derbyshire. The source and origin of this deposit has been satisfactorily explained by Liebig as follows. The mould of the superficial soil, being acted upon by moisture and air, evolves carbonic acid, which is dissolved by rain. The rain-water thus impregnated, permeating the calcareous strata, has the power of taking up a portion of the lime, which it retains in a liquid condition, until from evaporation the excess of carbonic acid is parted with, when the lime again returns to its solid state, and forms the incrustation.

C. have an additional interest to the geologist, from the occurrence in many of osseous remains under the calcareous incrustations of the floor. The bones are imbedded in mud, and frequently concreted into a firm calcareous breccia. They belong to the Pleistocene period, when the C. in Europe were inhabited by large hyenas and bears. Portions of other animals inhabiting the neighbourhood were

dragged by them into their dens, to serve as food. In this way the bones of herbivorous and other animals are found mixed with those of the beasts of prey; they have a broken and gnawed appearance, similar to what is produced on recent bones by the teeth of a hyena. No less than 33 species of mammals and 5 species of birds have been discovered in the C. of the British Islands, of which about the half still survive in Europe, while the remainder are extinct. The mammals are species of ox, deer, horse, wolf, dog, hare, fox, weasel, water-rat, mole, bat, hippopotamus, and rhinoceros, besides the hyena and bear; and the birds are species of lark, partridge, pigeon, goose, and crow.

The most productive ossiferous cavern in Britain is that at Kirkdale, 25 miles from York, in which the remains of about 300 hyenas have been detected, besides innumerable gnawed bones of those animals on which they preyed. The carboniferous limestones of Glamorganshire abound in caves, which have been explored by Buckland, and more recently and thoroughly by Dr Falconer. At the meeting of the Geological Society in June 1860, Dr Falconer thus describes the contents of one of them, called Bacon Hole. On the limestone floor of the cave are—(1.) a few inches of marine sand, abounding with *Litorina rudis*, *L. litoralis*, and *Clausilia nigricans*, with bones of an *Aroicola* and Birds; (2.) a thin layer of stalagmite; (3.) two feet of blackish sand, containing a mass of bones of *Elephas antiquus*, with remains of *Meles taxus* and *Putorius*; (4.) two feet of ochreous earth, limestone breccia, and sandy layers, with remains of *Elephas antiquus*, *Rhinoceros hemitechus*, *Hyena*, *Canis lupus*, *Ursus spelteus*, *Bos*, and *Cervus*; (5.) irregular stalagmite; (6.) two feet of limestone breccia and stalagmite, with bones of *Ursus* and *Bos*; (7.) a foot or so of irregular stalagmite, with *Ursus*; and (8.) dark-coloured superficial earth, kept sloppy by abundant drip, with bones of *Bos*, *Cervus*, *Canis vulpes*, horns of Reindeer and Roe-buck, together with shells of *Patella*, *Mytilus*, *Purpura*, and *Litorina* (probably brought into the cavern as food by birds), and also pieces of ancient British pottery. After a review of the Fauna of the bone caves of this country and of Europe, Dr Falconer concludes that the caves of Glamorganshire have probably been filled up with their mammalian remains since the deposition of the boulder-clay, and that there exist no mammalian remains in the ossiferous caves of England and Wales referable to a fauna of a more ancient geological date.

Ossiferous C. occur in all parts of the globe. The fossils of those in Australia shew that the fauna of the Pleistocene period had a remarkable resemblance to that of the present day. The remains consist chiefly of kangaroos and allied genera of Marsupials.

CA'VIARE, the salted roes of the common sturgeon (*Accipenser Sturio*) and other fishes of the same genus. See STURGEON. It is chiefly prepared in Russia, where it is greatly esteemed as an article of food. It is also used to a considerable extent in Italy and France. The species of sturgeon from the roe of which it is chiefly prepared, inhabit the Caspian and Black Seas and their tributary rivers. Among them are the Bielaga, or Great Sturgeon (*Accipenser Huso*), the Osseter (*A. Guldenstadti*), the Scherg or Sevruka (*A. stellatus*), and the Sterlet (*A. Ruthenus*). The C. made from the roe of the last-named species is esteemed particularly delicious, and is reserved for the Russian court. Astrakhan is a principal seat of the preparation of caviare. More than 400,000 lbs. of C. have been prepared in the Caspian fishery in a single year.

CAVITÉ, a town of considerable importance on the island of Luzon, one of the Philippines. It is situated on the bay of Manila, 10 miles south-south-west of the city of that name, of which it forms the quarantine station. It has a large cigar manufactory, is the chief naval dépôt of the Spanish possessions in the East, and gives name to a province with a population of 57,000. The population of the town itself is some 6000 or 7000.

CAVOR, or **CAVOUR**, a town of the Sardinian states, situated at the foot of the Alps, 7 miles south-south-east of Pinerolo. It has manufactures of silk-twist, linens, leather, &c., and marble and slate quarries. Pop. 6000 or 7000.

CAVO-RILIE'VO (Ital.). In this peculiar kind of rilievo, which was extensively employed by Egyptian artists, the highest surface of the object represented is only on a level with the plane of the original stone, the rounded sides being cut into it. The effect resembles that of a concave seal. It is correctly described as *intaglio rilievo*. A wood-cut is given in Fairholt's *Dictionary of Terms in Art of the Egyptian King Amunoph III. in hieroglyphics*.

CAVOUR, **COUNT CAMILLA BENSO DI**, a distinguished Italian statesman of the present time, the descendant of a noble and wealthy family of Piedmont, was born at Turin, August 10, 1810. He was educated for a military career, but his liberal tendencies being likely to prove an insuperable barrier to his promotion, he retired during the stirring events of 1830—1831, and devoted himself to agriculture, in which he introduced great improvements. He was the first to use guano in Piedmont; and, at his instigation, a national agricultural society was formed. During a residence in England, he made himself intimately acquainted with the political organisation of the country, and also with its industrial institutions; knowledge of which he made good use on his return to his own country in 1842. In conjunction with Count Cesare Balbo, he in 1847 established a political daily journal, in which he advocated the interests of the middle classes—a representative system, somewhat after the pattern of the English constitution, as opposed alike to absolutism on the one hand, and mob rule on the other. On his suggestion, the king was petitioned for a constitution, which was granted in February 1848. As a member of the Chamber of Deputies, during the stormy period which succeeded Charles Albert's declaration of war against Austria in March, C. strenuously opposed the ultra-democrats, and counselled an alliance with England as the surest guarantee for the success of the Italian arms. In the Marquis d'Azeglio's ministry, formed soon after the fatal battle of Novara, C. was successively Minister of Agriculture and Commerce, Minister of Marine, and Minister of Finance; and in 1852 he was appointed to succeed d'Azeglio as premier. From this time until his resignation in 1859, in consequence of the conclusion of the peace of Villafranca, C. was the originator as well as the director of the Sardinian policy. Taking upon himself at different times, in addition to the premiership, the duties of the Ministers of Finance, Commerce, and Agriculture, and latterly of Home and Foreign Affairs, he greatly improved the financial condition of the country, introduced free-trade, consolidated constitutionalism, weakened clerical influence, and made Sardinia a power of some account in Europe, by bringing her into alliance with England and France against Russia. The dispatches which C. penned in reply to those of Austria, prior to the outbreak of the Italian war, are on all hands acknowledged as master-pieces of astute diplomacy. In January 1860, C. was again called upon to preside over the Sardinian

government, the duties of Foreign Minister likewise devolving upon him, and temporarily those of the Minister of the Interior also. He still (November 1860) continues to direct the Sardinian policy.

CA'VY (*Cavia*), a genus of quadrupeds of the order *Rodentia*, regarded as the type of a family, *Cavidae*, differing from the Hare family (*Leporidae*) in the complete want of clavicles, in the want of growing roots to the molar teeth, and in having the incisors situated as in other quadrupeds generally, and not in the peculiar manner so characteristic of the hares. There are four molar teeth in each jaw, and in the genus *C.* these are compound; and the genus is further characterised by four toes on each of the fore-feet, and three on each of the hind-feet, by the feet not being webbed, by the females having only two teats, and by the want of a tail. One species, *Cavia Cobaya*, has been long well known as a domesticated animal, and has been a common pet and plaything of children in Europe, almost from the time of the discovery of America. It is sometimes called the COMMON *C.* or RESTLESS *C.*, but much more frequently receives the name of GUINEA-PIG, although it is neither nearly related to pigs, nor a native of Guinea. Perhaps *Guinea*, in this name, may be a corruption of *Guiana*, the cavies, and indeed the whole family of the *Cavidae*, being exclusively South American. The colours which the domesticated *C.* exhibits have never been seen in any of the wild cavies of South America; and as it is known to have exhibited the same variations of colour from about the time of its introduction into Europe, it is supposed to have been long domesticated by some of the South American tribes. The Guinea-pig multiplies with a rapidity exceeding that of any other known quadruped, producing young ones when only two months old, and afterwards at intervals of two



Cavy, or Guinea-pig.

months, and from four to twelve in a litter. This extraordinary fecundity is probably not so much the result of domestication, as a provision for the preservation of the race in a wild state, the little animal being very defenceless and destitute of means of escape, the ready prey of every carnivorous beast and bird.—The other species of *C.* much resemble the Guinea-pig. Some of them are very numerous in some parts of South America, and are sought for food, although no such use is made of the domesticated cavy. The Agouti (*q. v.*) and the Capybara (*q. v.*) are ranked among the *Cavidae*.

CAWK, a popular name for a massive variety of the mineral called Heavy Spar or Sulphate of Baryta. See **BARYTA**.

CAWNPORE, a city of the Doab, on the right bank of the Ganges, about 140 miles above Allahabad, at the junction of the Jumna, being separated by the river from Oude, whose capital, Lucknow, lies 53 miles to the north-east. The lat. is 26° 29' N., and the long. 80° 25' E. The stream in front, varying, according to the season, from 500 yards in width to more than a mile, presents a large

and motley assemblage of steam-vessels and native craft. C., at least as a place of note, is of recent origin, being indebted for its growth, besides its commercial facilities, partly to military and political considerations. In 1777, being then an appendage of Oude, it was assigned by the nawab as the station of a subsidiary force; and in 1801 it became, in name as well as in fact, British property. Its cantonments, having accommodation for 7000 troops, gradually accumulated about 50,000 native inhabitants; while the city itself contained a somewhat larger population of similar origin. During the mutiny of 1857, C. was the scene of Nana Sahib's massacre of his English captives. Though C. is only 379 feet above the sea, yet, during winter, considerable quantities of ice are made for preservation, through the exposing of water by night in shallow vessels.

CAWNPORE, the district of the above-described city, in the sub-presidency of the North-west Provinces. Occupying the entire breadth of the Doab, it touches at once the Jumna and the Ganges; while to the eastward it has Futtehpore, and, to the westward, Etawah and Furruckabad. With a population of about a million, it has an area of 2337 square miles stretching in lat. from 25° 55' to 27° N., and in long. from 79° 34' to 80° 37' E. It is an alluvial plain of great fertility. The vine is cultivated, and indigo grows wild. Besides its two mighty rivers and their navigable tributaries, the Ganges Canal traverses the country for about 60 miles.

CAXAMARCA, a province of Libertad, the most north-westerly department of Peru, with a capital of its own name. It is on the east side of the Andes, forming part of the basin of the Marañon. The province has 46,122 inhabitants, and the city about 12,000.

CAXAMARQUILLA, a town of Pataz, a province in the same department as Caxamarca. The whole of Pataz, with a population of 29,324, lies on the east bank of the Marañon.

CAXATA'MBO, a province of Ancas, the department immediately to the south of Libertad, above mentioned, with a capital of its own name. It contains 24,799 inhabitants.

CAXTON, WILLIAM, who introduced printing into England, was born in the Weald of Kent, about 1412. The particulars of the life of this great benefactor of his country are scanty. He was apprenticed to a mercer, and after his death in 1441, C. appears to have proceeded to the Low Countries, with a view to trade, either on his own account or as agent for some English merchants. His knowledge of trade must have been considerable, for in 1464 he was employed, along with Richard Whitehill, to 'continue and confirm a treaty of trade and commerce between Edward IV. and Philip, Duke of Burgundy,' with power to conclude a new one if necessary. In the Low Countries, he seems to have learned the art of printing. The first book he printed was Raoul le Fevre's *Recueil des Histoires de Troie*; the next work from his press was the *Oration of John Russell on Charles, Duke of Burgundy, being created a Knight of the Garter*; and the third, C.'s own translation of Raoul's work, completed at the request of Margaret, Duchess of Burgundy, in whose household C. for some time resided, in what capacity is not known. The last-mentioned work was probably printed in 1471; the date of the others is uncertain. The same uncertainty attaches to the time of his return to his own country, but it is known that he had established himself as a printer in Westminster before the year 1477. The first

book issued from his press here was the *Game and Playe of the Chess*. All C.'s works are printed in what is called Black Letter (q. v.). The types he at first employed resembled those in use in the Low Countries, much more than the finer specimens of the Venetian, Roman, and Parisian presses. C. had a good knowledge of German, French, and Dutch, and was the translator of several of the works that he printed; among others, of *The Hystorye of Reynart the Foze*.

CAYENNE, a term of various application in French Guiana, a territory on the left or north side of the estuary of the Amazon. 1. A river entering the Atlantic in lat. 4° 56' N., and long. 52° 20' W.—2. An islet of 30 miles in circuit at the mouth of the said river. It has a population of about 8000—about 5000 of them being emancipated slaves.—3. A city at the north-west point of the said islet, with a shallow harbour, which is defended by batteries. It contains nearly two-thirds of the above-stated population, and is the only town of note in the country.—4. One of the two districts of the colony, or popularly, in fact, the colony itself, is a place of exile for political offenders.

CAYENNE CHERRY. See EUGENIA.

CAYENNE PEPPER consists of the powder of the dried pods, and more especially of the dried seeds of different species of *Capsicum* (q. v.), particularly of *C. frutescens*.

CAYMAN, a name somewhat variously used, either as the distinctive appellation of some, or as a common name for all the *Crocodylidae* of South America. See ALLIGATOR. The genus *Alligator* is by some naturalists of the present day divided into three genera, to one of which the name C. (*Caiman*) is appropriated, and of which the type is the species called the Eye-browed C. (*Alligator palpebrosus*), to which the name C. is distinctively applied in Surinam and Guiana, a species very abundant there, but not one of the largest or more dangerous of its tribe. It is remarkable for the three bony plates, separated by sutures only, which form each eyebrow or eyelid, projecting as large knobs like a man's fist; and this, and the scarcely webbed-feet, constitute the most important characters of the genus or sub-genus Cayman. To this sub-genus belong also *A. trigonatus*, regarded by Cuvier as a mere variety of the same species, and *A. gibiceps*.

CAYMANS—in English, *Alligators*—three low islets of the Caribbean Sea, which form a dependency of Jamaica, being 130 miles to the north-west of it. Discovered by Columbus, they were by him called Tortugas, from the abundance of turtle—still the staple production of the group. On an area of about 2000 acres, the population does not exceed 200 or 300. The soil yields corn and vegetables; and the people rear hogs and poultry.

CAZA'LLA DE LA SIE'RRRA, a town of Spain, in the province of Seville, 39 miles north-east of the city of that name. It is situated on a declivity of the Sierra Morena; the district around is mountainous and well wooded, and abounds in minerals of various kinds, including iron, silver, copper, sulphur, and marble. The inhabitants, numbering between 7000 and 8000, are chiefly employed in smelting metals, manufacturing cannon, machinery, and agricultural implements. Some tanning, weaving, &c., are also carried on.

CAZEMBÉ, or KAZEMBE, an important country of Africa, the limits of which have not been clearly determined, but its centre has been fixed at about lat. 12° S., and long. 31° E. The king's rule extends over a great portion of the established

route across the continent of Africa, from the Congo, up the valley of Luŕa, and down the valley of Luapŕla. Vegetation is generally luxuriant. Its chief products are manioc, maize, salt, copper, iron, and ivory. The people are called Balonda or Balo.

CAZO'RLA, a town of Andalusia, Spain, 40 miles east-north-east of Jaen. C., which is a place of considerable antiquity, is pleasantly situated on a declivity, and is well watered by the Vega; has two old castles—one an Arab structure—manufactures of leather, earthenware, soap, and bricks, and a trade in agricultural produce. Pop. 7500.

CEANO'THUS. See **RED ROOT**.

CEARA, a province of Brazil, on the north coast, situated in lat. 2° 40'—7° 25' S., long. 37° 40'—41° 30' W. It has an area of at least 50,000 square miles, with 190,000 inhabitants. It abounds in balsams, gums, resins, and fruits; and among its minerals are gold, iron, copper, and salt.

CEBADILLA. See **SABADILLA**.

CEBUS (Gr. an ape or monkey), a genus of American monkeys, characterised by a round head and short muzzle, a facial angle of about 60°, long thumbs, and a long prehensile tail entirely covered with hair. The species are numerous, all of very lively disposition and gregarious habits, living in trees. They feed chiefly on fruits, but also on insects, worms, and mollusks. They are included under the popular designation **SAPAJOU** in its wider sense, and some of them are the monkeys to which this name is sometimes more strictly appropriated. The names **SAJOU** and **SAL** are also given to some of them, and some are called **Capuchin** (q. v.) monkeys. One of the most common species in Guiana is the **WEEPER MONKEY**, or **WEEPER SAPAJOU** (*C. Apella*).—The name **Capuchin** is perhaps most frequently given to *C. Capuchinus*, a brownish species, with head, feet, and hands generally black, and front, shoulders, and cheeks whitish.—Some of the species of *C.* are adorned with beards.—The name *Cebida* is sometimes given to the American monkeys collectively, as a family or tribe. See **MONKEY**.

CECIDOMYIA (Gr. *kekidion*, a gall-nut; and *myia*, a fly or gnat), a genus of dipterous (two-winged) insects of the family *Tipularia*—the gnat and mosquito family; having downy wings, which have three nervures, and are horizontal when at rest; antennæ as long as the body, with bead-like joints, and whirls of hairs at the joints; long legs, and the first joint of the tarsi very short. The species are numerous; nearly thirty are British. All are of small size, but some of them are very important on account of the ravages which their maggots effect in grain-crops. *C. cerealis*, sometimes called the **Barley Midge**, a brownish-red fly with silvery wings, of which the maggot is vermilion-coloured, is often very destructive to crops of barley and spelt in Germany. The little maggots live in families between the stalk and the sheath of the leaf, abstracting the juice of the plant.—The **WHEAT-FLY** (q. v.) and the **Hessian FLY** (q. v.) belong to this genus.—Some of the species of *C.* deposit their eggs on the young buds of trees, which the larvæ transform into galls.

CECIL, WILLIAM, LORD BURLEIGH, one of England's greatest statesmen, was born at Bourne, Lincolnshire, September 15, 1520. Educated at the grammar-schools of Grantham and Stamford, he thence passed to St John's College, Cambridge, where he was remarkable alike for his diligence and aptitude in learning. Entering Gray's Inn at the age of 21, he devoted himself assiduously to the

study of law. History, genealogy, and theology also formed part of his studies at this time; and his knowledge of the last recommended him to the notice of Henry VIII., who presented him with the reversion of the *custos brevium*, an office of value in the Common Pleas. An alliance with the daughter of Sir Anthony Cook procured him the friendship of the Protector Somerset, who, in 1547, appointed him Master of Requests; and in the following year his great talents procured for him the office of secretary of state. He shared in the disgrace of Somerset, even to imprisonment for three months; but in less than two years after his release, his pre-eminant abilities secured for him a re-appointment to the state secretaryship by the Duke of Northumberland, his former patron's sworn enemy. During his second secretaryship, C. effected most important and beneficial changes in the commercial policy of the country. With a sagacity far beyond the spirit of his age, he endeavoured to throw trade open, and did succeed in abolishing some monopolies; but others proved too strong for him, standing as he did alone, at a time when exclusive privileges were considered the only surties of a profitable trade. When Queen Mary ascended the throne, C., being a Protestant, resigned his official employment, because he could not conscientiously serve a Roman Catholic court; but as a private gentleman he maintained good relations with the Roman Catholic party, and was one of the few eminent Protestants who escaped in purse and person during that short but infamous reign. His freedom from persecution has given rise to the charge, that he was a 'trimmer'—a very unjust accusation, indeed. C. was naturally cautious and politic, and averse to extremes in religion; but though he took no part in bitter sectarian discussions, he never belied his conscience, and to him is mainly owing the rejection of the bill which the Roman Catholics had introduced into parliament, with the view to a wholesale confiscation of the estates of Protestants. Prior to Mary's death, C., foreseeing her end, had entered into correspondence with Elizabeth, who, on her accession to the throne (November 16, 1558), at once recognising C.'s capacity for government, appointed him secretary of state. A biography of C. from this time until his death would be a forty years' history of England, for he was alike the originator and director of that policy which, hitherto, has made Elizabeth's reign memorable above that of any other English sovereign; for although Elizabeth occasionally, in her caprice, favoured other courtiers, C. was the statesman whose judgment she relied on in all matters of consequence. His policy at home and abroad was at once shrewd and cautious, and also liberal and comprehensive, while he displayed a power of decision, ready and stern, when necessity demanded. As a statesman, C. was above animosities and favouritism; his enemies never suffered, and his friends profited nothing, by his power. Capacity, truth, and honour were what he sought in public men. Had he been less just, history might have been more generous to his memory. The queen created him Baron Burleigh in 1571, and conferred on him the Order of the Garter in the succeeding year, when he was also made lord high treasurer, an office he held until his death, August 15, 1598.

CECIL, ROBERT, EARL OF SALISBURY, son of the above, was born about 1550. On the death of his father, having previously held important state offices, he succeeded to what would now be called the premiership. On the accession of James I., C., who had carried on a private correspondence with that monarch before Elizabeth's death, was confirmed in

his office, and received many high honours, culminating in that of Earl of Salisbury. In 1608, he was made lord high treasurer, and the Exchequer was greatly improved in his hands. C. was a man of immense energy and far-reaching sagacity, undoubtedly the best minister the country had in his time; but he was cold, selfish, and unscrupulous as to the means he took to gain his ends, and get rid of his rivals. His connection with the disgrace of Essex and Raleigh laid him open to great and deserved odium, in the latter case especially. Like his father, however, he was free from the meanness and dishonesty of enriching himself out of the public money. He died May 24, 1612.

CECILIA, Sr, the patroness of music, is said to have suffered martyrdom in 230 A.D. Her heathen parents, as we are told, belonged to a noble Roman family, and betrothed their daughter, who had been converted to Christianity, to a heathen youth named Valerian. This youth and his brother Tiberius became Christian converts, and suffered martyrdom. C., when commanded to sacrifice to idols, firmly refused, and was condemned to death. Her persecutors, it is said, first threw her into a boiling bath, but on the following day they found her unhurt. The executioner next attempted to cut off her head, but found it impossible. Three days later, she died—rather a lame conclusion to such miraculous interference! As early as the 5th c., there is mention of a church dedicated to her at Rome; and in 821, by order of the Pope Paschal, her bones were deposited there. St C. is regarded as the inventor of the organ, and in the Roman Catholic Church her festival-day, November 22, is celebrated with splendid music. Chancer, Dryden, and Pope have celebrated St C., and the painters Raphael, Domenichino, Dolce, and others have represented her in fine pictures.—Another St C. was born in Africa, and suffered martyrdom by starvation under Diocletian. The Roman Catholic Church celebrates her festival on the 11th of February.

CECROPIA, a genus of trees of the natural order *Artocarpaceæ*. *C. peltata*, a native of the West Indies and of South America, sometimes called Trumpet-wood and Snake-wood, is remarkable for its

hollow stem and branches, exhibiting merely membranous partitions at the nodes. The small branches, these partitions being removed, are made into wind-instruments. The wood is very light, readily takes fire by friction against a harder piece of wood, and is much used by the Indians for procuring fire in this way. The fruit is agreeable, and resembles a raspberry. Both the trunk and branches yield a large quantity of saline matter, which is employed by the French planters in the purification of sugar. The bark is strong and fibrous, and is much used for cordage. It is also astringent, and is applied in diarrhoea and other diseases.

CECROPS, the first king of Attica, figures in Greek mythology as an Autochthon (q. v.), half-man and half-dragon. Belonging, as he does, to the prehistoric ages of Greece, his real character can only be guessed at. Tradition declared him to be the founder of marriage, the author of the political division of Attica into twelve states, and the introducer of agriculture, of navigation, and commerce. He is also said to have civilised the religious rites of the people. The name C. is given to various towns in Greece, and the legends in general seem to indicate a Pelasgic origin for the hero. The later accounts, that he came from Sais in Egypt, have no historic basis.

CE'DAR, or CEDAR OF LEBANON, a tree much celebrated from the most ancient times for its beauty, its magnificence, and its longevity, as well as for the excellence and durability of its timber. It is often mentioned in Scripture; it supplied the wood-work of Solomon's temple; and in the poetry of the Old Testament it is a frequent emblem of prosperity, strength, and stability. It belongs to the natural order *Conifera*, and is the *Pinus Cedrus* of the older botanists; but is now ranked in the genus *Abies* (see FIR); in the genus *Larix* (see LARCH), by those who make *Larix* a distinct genus from *Abies*, or is made the type of a genus, *Cedrus*, distinguished from *Larix* by evergreen leaves and carpels separating from the axis, and receives the name of *C. Libani*.

Of the celebrated CEDARS OF LEBANON, only a few now remain. They consist of a grove of some



Cedars of Lebanon.

400 trees, about three-quarters of a mile in circumference, partly old trees, and partly young ones. Learned travellers think that most of the trees in the grove may be 200 years old, and several between the ages of 400 and 800 years. There are twelve trees whose age is incalculable—seven standing very near each other; three more a little further on, nearly in a line with them; and two, not observed by any recent traveller except Lord Lindsay, on the northern edge of the grove. The largest of these two is 63 feet in circumference—following the sinuosities of the bark; one of the others measures 49 feet.

These trees are more remarkable for girth than stature, their height hardly exceeding 50 feet. Their age is variously estimated; the rules by which botanists determine the age of trees are not applicable to them, for their stems have ceased to grow in regular concentric rings; they owe their prolonged existence to the superior vitality of a portion of their bark, which has survived the decay of the rest. Russeger is inclined to admit that these trees may possibly number some 2000 years.

The Arabs, of all creeds, have a traditional veneration for these trees; they believe that an evil fate would surely overtake any one who shall dare to

in ditches, brooks, &c., especially near the sea and in saline soils. Its leaves are dark green and smooth, its petals involute at the tip. The wild plant, also called *SMALLAGE*, has a stem about two feet high, a tapering slender root, a penetrating offensive odour, a bitterish acrid taste, and almost poisonous qualities. By cultivation, it is so much changed that its taste becomes agreeably sweetish and aromatic, whilst either the leaf-stalks much increase in thickness, or the root swells in a turnip-like manner. These parts, blanched, are much used as a salad, or to impart flavour to soups, &c., and sometimes as a boiled vegetable. They contain sugar, mucilage, starch, and a substance resembling manna-sugar, which acts as a stimulant, particularly on the urinogenital organs, so that a very free and frequent indulgence in the use of *C.* cannot, in ordinary circumstances, be altogether favourable to health. Two principal varieties of *C.* are cultivated, that most common in Britain having long thick leaf-stalks, which are more or less tubular, sometimes almost solid, and, after blanching, either white or more or less tinged with red; whilst the other, called *TURNIP-ROOTED C.*, or *CELERIAC*, is chiefly remarkable for its swollen turnip-like root, and is in most general cultivation on the continent of Europe. The 'red' varieties of *C.* are esteemed rather more hardy than the 'white.' The blanching of the leaf-stalks is generally accomplished by drawing up earth to the plants, which are transplanted from the seed-bed into richly manured trenches; and as they grow, the trenches are filled up, and the earth finally raised into ridges, above which little more than the tops of the leaves appear. *C.* is thus obtained for use throughout the winter. In the northern parts of Britain, the seed is generally sown on a hotbed. *C.* seed is often used for flavouring, when the leaf-stalks cannot be obtained. —Another species of *C.* (*Apium australe*) grows abundantly in wet places on the shore about Cape Horn and in Staten Island. It is a large, hardy, and luxuriant plant, and is described as wholesome and very palatable, nearly equal in its wild state to our garden-celery. It seems well worthy of the attention of horticulturists.

CELESTINE, a mineral bearing the same relation to stromtia (q. v.) that heavy spar bears to baryta. It is essentially sulphate of stromtia (StO_3SO_3), with occasional admixture of sulphate of baryta, carbonate of lime, oxide of iron, &c., in small proportions. It much resembles heavy spar, but is not quite equal to it in specific gravity; is usually blue, often of a very beautiful indigo-blue; sometimes colourless, more rarely reddish or yellowish. Its crystallisation is rhombic, like that of heavy spar. Most beautiful specimens of crystallised *C.* are found in Sicily. *C.* derives its name from its colour. It is used as a source of stromtia.

CELESTINES, an order of hermits of St Damianus, founded by Peter de Morrone about 1264, and confirmed as a monkish order by Urban IV. in 1264 and 1274. They called themselves *C.* when their founder ascended the papal chair under the name of Celestine V. They are regarded as a branch of the great order of St Benedict, whose rule they follow; they wear a white garment with black hood and scapulary, and live a purely contemplative life. In the 13th and 14th centuries, the order rapidly spread through France, Italy, and Germany, but subsequently decayed. The French *C.* were secularised by order of Pope Pius VI. in 1776—1778; so also were the Neapolitan Celestines. In the present day, the order is almost extinct.

CELIBACY, from Lat. *caelebs*, unmarried. Notwithstanding the divine commendation of marriage

given in the Jewish Scriptures (Gen. i. 28), the opinion had become prevalent, even before the time of Christ, that *C.* was favourable to an intimate union with God. This notion took its origin in the wide-spread philosophy of a good and an evil principle. The body, consisting of matter, the seat of evil, was looked upon as the prison of the pure soul, which was thought to be defiled by bodily enjoyments. Among the Jewish sect of the Essenes, accordingly, a life of *C.* was held to be the chief road to sanctity. These ascetic views naturally led, in the first place, to the disapproval of second marriages. While, therefore, in the first Christian churches, every one was left at liberty to marry or not as he thought fit, the objection to those who married a second time had become so generally spread, that the Apostle Paul saw occasion to counsel such Christian converts as were in widowhood to remain so.

By the 2d c., however, the unmarried life generally had begun to be extolled, and to be held necessary for a life of sanctity, although several, at least, of the apostles themselves had been married. Two passages of Scripture (1 Cor. vii. and Rev. xiv. 4) were specially cited as proving that *C.* was the genuine condition of a Christian; and with the platonising Fathers of the 2d and 3d centuries, the unmarried of both sexes were held as standing higher than the married. Accordingly, although there was no express law against the marriage of the clergy, many, especially of the bishops, remained unmarried; a second marriage was, in their case, already strictly prohibited.

As the bishops of Rome rose in consideration, and gradually developed a firmer church government, they called upon all who belonged to the clerical order to live for the church alone, and not marry. This requirement met with constant resistance; still, it became more and more the custom, in the 4th c., for the higher clergy to refrain from marriage, and from them it went over to the lower orders and to the monks. Provincial synods now began expressly to interdict the clergy from marrying. The council of Tours (566) suspended for a year all secular priests and deacons who were found with their wives; and the Emperor Justinian by an edict declared all children born to a clergyman, after ordination, to be illegitimate, and incapable of inheritance. There were still, however, many married priests who resisted the law, and found encouragement in the opposition which the Greek Church made to that of Rome in this matter of celibacy. The council held at Constantinople in 692, declared, in opposition to the Church of Rome, that priests and deacons might live with their wives as the laity do, according to the ancient custom and ordinance of the apostles. The orthodox Greek Church has continued to adhere to this decision. Priests and deacons in that church may marry before ordination, and live in marriage after it; but they are not allowed to marry a second time. However, only a priest living in *C.* can be chosen as bishop or patriarch.

The Church of Rome continued its endeavours to enforce the law of *C.*; though, for several centuries, they were attended with only partial success. There still continued to be numbers of priests with wives, although the councils were always issuing new orders against them. Popes Leo IX. (1048—1054) and Nicolas II. (1058—1061) interdicted all priests that had wives or concubines from the exercise of any spiritual function, on pain of excommunication. Alexander II. (1061—1073) decreed excommunication against all who should attend a mass celebrated by a priest having a wife or concubine. This decision was renewed by Gregory VII. in a council held at

Rome in 1074, and a decretal was issued that every layman who should receive the communion from the hands of a married priest should be excommunicated, and that every priest who married or lived in concubinage, should be deposed. The decree met with the most violent opposition in all countries; but Gregory succeeded in carrying it out with the greatest rigour; and though individual instances of married priests were still to be found in the 12th and 13th centuries, the C. of the Roman Catholic clergy was established, and has since continued both in theory and practice.

The violence thus done to human nature did not fail to avenge itself in those rude times. The licentiousness and corruption of the priests and monks became in many cases boundless, and it was in vain that strict individuals, as well as councils, strove against it. The immorality and debasement of the clergy became a reproach and by-word in the mouth of the people, and gave a powerful impulse to the religious movement that began in the 16th century. The leading Reformers declared against the C. of the clergy as unfounded in Scripture, and contrary to the natural ordinance of God, and Luther set the example of marrying. This was not without effect on the Roman Catholic clergy, and the question of the abolition of C. was raised at the council of Trent (1563). But the majority of voices decided that God would not withhold the gift of chastity from those that rightly prayed for it, and the rule of C. was thus finally and for ever imposed on the ministers of the Roman Catholic Church. Those who have only received the lower kinds of consecration may marry on resigning their office. For all grades above a subdeacon, a papal dispensation is necessary. A priest that marries incurs excommunication, and is incapable of any spiritual function. If a married man wishes to become a priest, he receives consecration only on condition that he separate from his wife, and that she of her free will consent to the separation and enter a religious order, or take the vow of chastity. The priests of the united Græco-Catholic congregations in Rome have received permission from the popes to continue in marriage, if entered into before consecration, but on condition of always living apart from their wives three days before they celebrate mass.

Notwithstanding these decisions, the contest against clerical C. has again and again been resumed, in recent times, both within and without the Roman Catholic Church. In fact, all attempts at innovation within the bosom of Catholicism, connect themselves with the attack on C., the abolition of which would deeply affect the constitution and position of that church. So far back as 1817, the Catholic Faculty of Tübingen expressed the opinion that compulsory C. was one of the chief causes of the want of Catholic ministers. In 1826, the Catholic clergy of Silesia put in petitions to the bishop for the abolition of C.; and unions were afterwards formed in Baden, Würtemberg, Bavaria, Silesia, and Rhenish Prussia; which, along with alterations in the doctrines and ritual of the Romish Church, combined attacks on the prohibition of marriage to the clergy. A work was also published, entitled *The Introduction of Compulsory Celibacy among the Christian Priesthood, and its Consequences* (Altenb. 1828, new ed. 1845), which excited great attention. At last the abolition of the law came to be discussed in the legislatures of Baden, Saxony, and other countries. The church claimed this subject as belonging exclusively to her jurisdiction, and not to that of the state; and in Würtemberg the clergy induced the government to suppress the anti-celibacy society; but this only made their opponents in the press the more zealous. In

France, also, the question, about 1829, was eagerly discussed. And in Spain, the Academy of Ecclesiastical Science took the subject into consideration in a meeting held in 1842; while the Portuguese Chambers had previously, in 1835, discussed it, though without result. The same took place in Brazil, about 1827.

During the commotions of 1848, the subject was again brought into prominence in Germany. The German Catholics (q. v.) had already abolished C.; and a general measure was called for in the Frankfort parliament, in the Prussian Assembly, and in the press. In Austria, also, voices were raised against it; but here the state took the side of the pope, who, in a bull of 1847, had added fresh stringency to the rule of C., and condemned its infringement.

CELL (Lat. *cella*, from *celo*, to conceal). The Latin word had nearly all the significations which we attach to the English one, and a good many besides which we have not borrowed. For example, the whole space within the walls of an ancient temple was called the *cella*. But the interior was frequently divided into several *cellæ*, in which case each C. took the name of the deity whose statue it contained, and was called the C. of Jupiter, Juno, Minerva, and the like. In these cases, the word approached to its general meaning, which, with the Romans as with us, was that of a store-room, or small apartment where objects of any kind were stowed away. In modern architecture, the term Vaulting C. signifies the hollow space between the principal ribs of a vaulted roof.

CE'LLÉ, or ZELL, a town of Hanover, on the left bank of the Aller, which at this point becomes unavigable, 23 miles north-east of the city of Hanover. It is situated in the midst of a sandy plain, well built, and has a palace with a garden, in which Matilda, sister of George III., is buried. The inhabitants, about 10,000, are very industrious. The chief manufactures are linen, hosiery, tobacco, wafers, soap, &c. An active commerce is also carried on by the Aller, and by railway.

CELLINI, BENVENUTO, a celebrated Italian gold-worker, sculptor, founder, and medaillier, remarkable not only for his skill as an artist, but also for his checkered life, was born at Florence in the year 1500, and first displayed skill as a chaser and gold-worker. His autobiography is a remarkably curious and interesting work, presenting us with a complete picture of the author's life and character; his activity, his extraordinary weaknesses, the impetuosity of his passions, the perilous circumstances in which his quarrelsome disposition placed him (for C. thought nothing of committing manslaughter in a moment of rage), and the ludicrous vanity and credulity which are never absent from him. The book is also of great value in a historico-social point of view, but does not impress us favourably in regard either to the personal or social morals of the time.

At an early period, having been banished from Florence in consequence of an 'affray,' C. went to Rome, where he was employed by many distinguished patrons of art, but afterwards was allowed to return to Florence. Another 'affray' compelled him to flee to Rome a second time, where he secured the favour of Clement VII. C., by his own account, was as great in arms as in art; he declares that it was himself who killed the Constable Bourbon and the Prince of Orange at the siege of Rome. His reckless conduct for some years compelled his constant shifting between Rome and Florence, Mantua, and Naples. In 1537 he went to the court of France, where he was very honourably received. Illness, however, induced him to return yet once more to

Rome, where he had the misfortune to be imprisoned on a charge of plundering the treasures in the castle of St Angelo during the siege of Rome. At length he was liberated, through the intercession of the Cardinal of Ferrara, for whom he executed, out of gratitude, a fine cup, and various other works. He now accompanied his deliverer to France, and entered the service of Francis I.; but having incurred the displeasure of the ruling favourite, Madame d'Estampes, he returned to Florence—not, however, until, as usual, he had settled some matters with his 'sword'—where, under the patronage of Cosmo de' Medici, he executed several fine works in metal and marble—among them, the celebrated bronze group of 'Perseus with the Head of Medusa,' which now decorates the market-place in Florence. Among other preserved works of C., the splendid shield in Windsor Castle may be noticed. In his 58th year, he commenced writing his autobiography, and died in 1570 or 1572.

CELLS, in Physiology.—I. **ANIMAL CELLS.**—On examining, under a high magnifying power, any of the constituents of the animal body, we perceive that the smallest parts which appear to the naked eye as fibres, tubes, &c., are not ultimate elements in respect to form (morphotic elements), but that they contain and are built up of certain extremely minute particles, which differ in different organs, but always have a similar appearance in the same organs. By far the most important of these microscopic forms, which are known by histologists as 'simple elementary parts,' are the C., which not only form the starting-point of every animal and vegetable organism (the ovum in either kingdom of nature being simply a cell), but also—either as C., or after having undergone certain modifications which will be presently described—make up the tissues and organs of the perfect animal. Indeed, some of the lowest plants (red snow, gory dew), and of the simplest forms of animal life (GREGORINÆ, &c., q. v.), appear to consist of a single cell (see fig. 1).

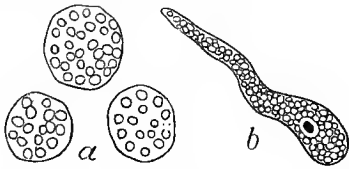

Fig. 1.

a, simplest forms of independent vegetable organisms, or unicellular plants; b, a gregorina—a unicellular animal organism.

While in plants the elementary parts generally unite directly with one another, in animals they are usually combined by an interstitial substance, which may be either solid or fluid, and is always derived from the blood or general nutrient fluid. If this interstitial substance take a part in the formation of the C., it is called a cytotblastema or a blastema, from *kutos*, a cell or vesicle, and *blastema*, germ-substance; if it has nothing to do with their maintenance, it is called the matrix. The cytotblastema is usually fluid, as in the blood, chyle, &c.; while the matrix is solid, as in cartilage, bone, &c.

In every cell, we can distinguish, if we use sufficiently high magnifying powers, a membranous envelope, known as the cell-wall or membrane, and certain contents. The latter are fluid or gelatinous, and besides containing particles or granules, usually exhibit a peculiar rounded body, the nucleus; which, again, contains in its interior a fluid and a still smaller corpuscle, the nucleolus.

The fundamental form of the cell is spherical or lenticular; it is such in all young C., and is persistent in those which occur in fluids, as, for example, the blood-corpuscles. Amongst other well-known

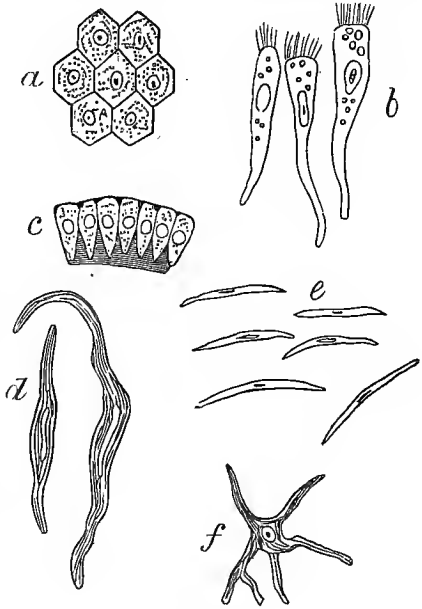

Fig. 2.

forms may be mentioned: a, the polygonal, as in pavement epithelium, or the pigment of the eye; b, the conical or pyramidal, as in ciliated epithelium; c, the cylindrical, as in cylinder epithelium; d, the fusiform, or spindle-shaped, as in contractile fibre-C.; e, the squamous, as epidermic scales; and f, the caudate, polar, or stellate, as the C. in the gray nervous tissue (see fig. 2).

With regard to size, the largest animal C.—excepting the unicellular organisms—are the yolk-C. of the ova of birds and amphibia, while the blood-C. of certain animals may be taken as representing the smallest cells. Average C. range from 0.005 to 0.01 of a line in diameter.

The cell-membrane is usually transparent and colourless, mostly smooth, and so thin as to exhibit only a single contour, rarely of any measurable thickness. No traces of structure can be detected in it. The granular appearance which the membrane occasionally presents, is due to projections depending on granules lying on the inside; and it vanishes on the addition of water, which causes the cell to be distended by endosmosis. See OSMOTIC ACTON.

C. which contain only fluid are rare (fat-C., blood-C.); generally, besides fluid, they contain elementary granules and vesicles, and sometimes crystals. As a general rule, the number of these morphotic elements increases with the age of the cell; sometimes, however, this is not apparent, in consequence of their being grouped in a single mass around the nucleus.

The nucleus is usually spherical or lenticular, transparent, and either colourless or yellowish, and ranges from 0.002 to 0.004 of a line in diameter. All nuclei are vesicles, as was originally maintained, in 1841, by Schwann (*Microscopical Researches into the Accordance in the Structure and Growth of Animals and Plants*, Sydenham Society's translation, 1847, p. 173), who must be regarded as the

founder of the cell-theory in its relation to animal tissues, and as has since been confirmed by Kölliker and other later observers. The contents of the nucleus usually consist,

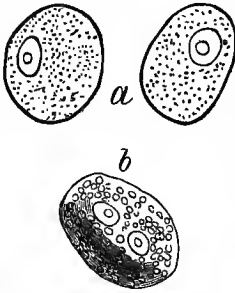

Fig. 3.

a, cells with a single nucleus;
b, a cell with two nuclei.

with the exception of the nucleolus, of a limpid or slightly yellowish fluid, from which water and acetic acid precipitate granular matter. In general, only one nucleus exists in each cell, except when it is multiplying (a process which we shall presently explain); occasionally, however, we meet with several nuclei—four, ten, or even twenty (see fig. 3).

The nucleolus is round, sharply defined, and often so small as to be almost immeasurable. Nucleoli are found in most nuclei so long as the latter are still young, and in many during their whole existence. As, however, nuclei exist in which no nucleolus can be detected, we cannot regard the nucleolus as so essential an element of the cell as the nucleus. Most commonly a nucleus contains only one nucleolus; two are not unfrequently seen; more are rare.

Our knowledge of the chemical composition of C. is very imperfect. That the cell-membrane is a protein substance (q. v.)—at all events in young C.—is obvious from its solubility in acetic acid and in dilute caustic alkalis; and the membrane of the nucleus seems to have a similar composition; while there are chemical reasons for believing that the nucleolus is composed of fat. In the contents of most C. we usually find such substances as occur in solution in the cytoblastema—viz., water, albumen, fat, extractive matters, and salts; and in the C. of secreting organs, as, for instance, the liver and kidneys, we find the special secretions of those glands; in the blood-C., we find hæmato-crystalline, &c.

There are two perfectly distinct ways in which C. can be generated: they may be developed independently of other C. in a plastic fluid (the cytoblastema); or they may be developed from pre-existing C. by cell-multiplication, the existing C. either producing secondary C. within themselves, or multiplying by division. In both these latter kinds of cell-development, the nucleus seems to be the centre of development of the young cells.

In order that free or independent cell-development shall take place, we must have a cytoblastema containing protein substances (probably fibrin), fat, and certain salts (especially phosphates) in solution; and very possibly the presence of the particles of pre-existing C. may also be necessary, in which case free cell-development ceases to exist. The chyle and lymph corpuscles may be mentioned as examples of this mode of cell-formation. The steps of the process are not very clearly made out, but we know that the nuclei are first formed, and that the cell-membranes are developed around them. Free cell-development is far less common in man and the higher animals than cell-multiplication, and, we believe, never occurs in the vegetable kingdom. All pathological cell-formations—the C. in pus (q. v.), and in other morbid exudations—come, however, under this head.

The development of C. within other C. is of very common occurrence. An original or parent cell produces two or more secondary or daughter C., and the process of formation is said to be

endogenous. Cartilage-C. afford a good example of this process. The nucleus and the contents of each parent cell undergo division into two parts, so that the number of C. is successively doubled. This process is exhibited in fig. 4, where *a* represents

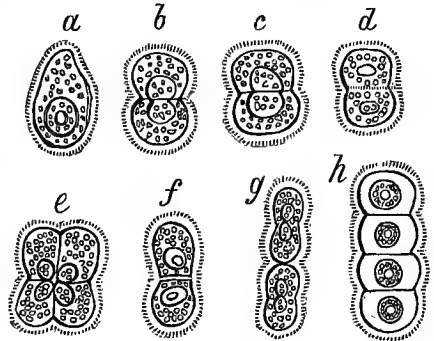

Fig. 4.

the original cell; *b*, the same, beginning to divide; *c*, the same, shewing the complete division of the nucleus; *d*, the same, with the halves of the nucleus separated, and the cavity of the cell subdivided; *e*, a continuation of the same process, with cleavage in a direction transverse to the first, so as to form a cluster of four C.; and *f*, *g*, *h*, the production of a longitudinal series of C., so as to produce filaments, by continuous cleavage in the same direction. The mode in which the multiplication of the nucleus takes place cannot be definitely made out in all cases, but when clear observation is possible, the nucleoli first divide into two, and then separate.

A multiplication of C. by division has been proved to take place in the red blood-C. of the embryos of birds and mammals, and in the first colourless blood-C. of the tadpole, and very probably occurs extensively in many embryonic and adult tissues, in which a self-multiplication of C. is certain, but where no parent C. with secondary C. can be detected. In fig. 5 are shewn the blood-C. of the



Fig. 5.

Blood-corpuscles of the Chick, in the act of division.

chick dividing in this manner. In this and similar cases we have an elongation of the cell, and the single nucleus becomes divided into two; the cell then suffers constriction in the middle, which proceeds till it finally separates into two parts, each of which contains a nucleus. This variety of cell-formation affords a good illustration of the doubt and difficulty connected with this class of investigations. It was altogether unknown to Schwann when he published his great work in 1839, and was first noticed and described by Remak in 1841, who, however, subsequently retracted his published view, and did not again advocate it till Kölliker confirmed his observation, and declared it to be correct.

No satisfactory theory has been propounded with the view of explaining the development of cells. Schwann compares the formation of C. with that of crystals, but it must be recollected that the molecular attraction concerned in the formation of

C. is so far peculiar, that—1. It never produces geometrical solids, but even in the nucleus and nucleolus determines a globular form; 2. That it aggregates not homogeneous, but chemically different substances; and 3. That the final result of its action—namely, the cell—is extremely limited in size, while a crystal may be of a comparatively indefinite magnitude.

The growth of C. requires some notice. Growth probably occurs in all C., although not in all to the same extent. It is most obvious in those which are formed directly round a nucleus, since in these the membranes which at first closely invest the nucleus, in time become distended and enlarged, and merely remain in contact with the nucleus at one point. Growth may take place either in surface or in thickness. The former is most commonly general—viz., in all those cases where C. increase without altering their form; but is sometimes partial—viz., in those cases in which the cell deviates considerably from the primary globular form. The latter occurs

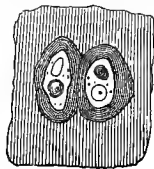

Fig. 6.

to a certain degree in all C., but in some kinds to a far greater extent than in others. In fig. 6, two cartilage-C., magnified 350 diameters, are shewn, in which the walls are much thickened; in addition to their nucleus, each contains a clear drop of fat. The nuclei and nucleoli also take part

to a certain extent in the growth of the cells. Schwann gives the following general explanation of the process of growth. He considers that the molecules of the cell-membrane exert an attractive influence on the fluid which surrounds them, and deposit its newly formed particles amongst themselves. If the deposition take place between the molecules already present in the substance of the membrane, the cell becomes distended; if it take place only in one or more definite directions, the membrane becomes thickened.

Having now traced the cell to the period of its full growth, we are prepared to consider the processes which occur in the interior of this minute organic structure, or, in other words, the physiology of cells. To enter satisfactorily into this subject, we ought to have an exact knowledge of the chemical composition of the contents of different cells. All that we know of the contents of C. generally is, as we have already stated, that they usually consist of a moderately concentrated solution of protein matters, with alkaline and earthy salts, and dissolved or suspended fat-particles; and that besides these ingredients many C. contain either a great preponderance of one of these constituents, to the almost entire exclusion of others, or are found to contain altogether new substances. Thus, there are C. with much protein matters, as the nerve-C., and with much fat, like the fat-C.; while there are other C. which specially contain hæmatine (the red colouring matter of the blood), pigment, biliary and urinary constituents, mucus, milk, sugar, &c.

The main cell-processes occurring in these variously constituted C. are absorption, secretion, and excretion. These depend principally, if not entirely, upon chemical and physical laws, and are to a great extent amenable to micro-chemical observation.

Absorption, or the appropriation of matters from without, is most manifest in those C. which at first have little or no contents save the nucleus. Although endosmose must be taken into account as a condition of absorption, C. must not be regarded merely as vesicles provided with indifferent porous membranes; for the filling of C. does not take place by their admitting every kind of matter

indiscriminately; but they have the power of taking up one constituent, and rejecting another, and thus exhibit a selective faculty.

The cell having thus become filled from without, we have next to inquire into the changes which take place in the membrane and in the contents. As regards the former, the membranes of most C. not only become denser and more solid with age, but they undergo changes in their chemical constitution. Thus, in the horny tissues, the young C. are easily soluble in alkalis and acids, while older C. of the same nature are scarcely affected by these re-agents; again, in cartilage-C., the membrane not only becomes firmer with age, and thickens as ossification proceeds, but is changed into a tissue yielding gelatine or glue on boiling, which subsequently becomes impregnated with salts of lime (phosphate and carbonate). See BONE.

The function of secretion is mainly carried on by changes in the contents of the cells. Thus, mucus is formed in the epithelial C. of the mucous membranes, pepsin in those of the gastric glands, bile in the C. of the liver, and septa in the C. of the ink-bag of the cuttle-fish. In these cases, the C. do not separate mucus, pepsin, &c., from the blood, but merely the materials from which they elaborate these substances. In other cases, as, for instance, in the C. of the kidney, the function of these minute organisms is not to manufacture new products, but merely to separate certain substances (urea, uric acid, &c.) from the blood, which, if not immediately removed from the general circulation, would speedily accumulate, and act as a deadly poison. That these C. merely separate the urea from the blood, and do not form it in their interior, is proved by the fact that, if the kidneys of an animal are extirpated, the urea and other urinary constituents may speedily be found in large quantity in the blood.

Excretion takes place by the bursting or solution of the distended secreting cell, usually into the duct of a secreting gland. The reader who desires further information on the functions of the C. in relation to secretion and excretion, is especially referred to an admirable memoir by Professor Goodsir, 'On Secreting Structures,' published in John and Harry D. S. Goodsir's *Anatomical and Pathological Researches*, 1845.

In conclusion, we must notice the metamorphoses of cells. The ovum itself is, as we have already mentioned, merely a nucleated cell; after impregnation, a number of secondary C. are formed within it, by a process of cleavage or segmentation. See articles GENERATION and OVUM. Some of the C. which occur in the ovum in its early stages soon coalesce with others to form the higher elementary parts, which we shall shortly enumerate; others, without entering into combinations, more or less change their previous nature, as the horny plates of the epidermis and nails; while others, again, undergo no change of form throughout the period of their existence.

The permanent C. are arranged by Kölliker (*Manual of Human Histology*, translated by Busk and Huxley, 1853, vol. i. p. 47) under the following heads:

1. *True Cells*, which have in no essential respect altered their cellular character. These occur in the epidermis and the epithelium; in the blood, chyle, and lymph; in the glandular secretions, in the fatty tissue, in the gray nervous substance, in the glands (liver, spleen, &c.), and the cartilages. Their varieties of form and contents have been already noticed. Regarding their modes of occurrence, some are either isolated in fluids or in solid tissues; others are united by apposition, without any intervening structure, into a cellular parenchyma;

while others, again, are conjoined by an intercellular substance of some kind.

2. *Metamorphosed Cells.* To these belong—*The horny scales*: flattened, polygonal, or fusiform; their membrane being fused into one mass with their contents. They occur in the epidermis, the laminated pavement epithelium, and the hair and nails. *The contractile fibre-C.*: fusiform, slightly flattened, considerably elongated C., whose membrane, with its soft, solid contents, is changed into a contractile substance. They occur in the smooth or involuntary muscles. *The tubules of the crystalline lens of the eye*: very elongated C., with viscid, albuminous contents. *The prisms of the enamel of the teeth*: greatly elongated, prismatic, and strongly calcified cells. *The bone-C.*: thickened C. (with *canaliculi*, or minute branching canals) which have coalesced with the matrix of the bones. *The transversely striated muscular C.*: large polygonal C. whose contents have become metamorphosed into a transversely striated or striped tissue, such as is found in voluntary muscular fibre. From these C. are formed all the different fibres, net-works, membranes, tubes, &c.; in short, all the higher elementary parts of which the animal body is composed.

For further information on C. and cell-development, the reader is referred, in addition to the works quoted in this article, to Leydig, *Lehrbuch der Histologie des Menschen und der Thiere*, 1857; and to Frey, *Histologie und Histochemie des Menschen*, 1859; while he will find full details on morbid cell-development (the development and growth of C. in tubercle, cancer, and other morbid deposits) in Vogel's *Pathological Anatomy of the Human Body*, translated by Day, 1847; and in Wedl's *Pathological Histology*, translated (for the Sydenham Society) by Busk, 1855.

II. VEGETABLE CELLS.—In the vegetable, as in the animal kingdom, the primary form of the cell is that of a sphere. There are, however, interfering influences, which usually alter or modify the primary form, of which the most important are, (1.) Special directions assumed in the development, in obedience to a law regulating the structure of the tissue in which the cell occurs; and (2.) Obstructions to the expansion of the cell in certain directions from the pressure of surrounding cells.

The most common forms referable to the law of development are, (1.) The *spherical* or fundamental form; (2.) The *cylindrical*, in which there is a tendency to elongation in the direction of a vertical axis; and (3.) The *tubular*, in which there is an excess of development in the direction of the two transverse axes.

The secondary modifications of these forms are numerous. Thus, in lax tissues, the spherical form may become an irregular spheroid, running out into *lobed*, and even *stellate* forms, as may be seen in the pith of rushes and the stems of various aquatic plants. Again, in seeds, the hard part of fruits, &c., the mutual pressure of the C. converts the spherical into *polyhedral* forms, of which the *dodecahedron*—giving a hexagonal section, and arising from equal pressure in all directions—is the most common, although *cubic* and many other forms occasionally occur.

The magnitude of the vegetable C. is very varied. In flax, the liber-cells have been found $\frac{1}{4}$, or even $\frac{2}{3}$ of an inch in length, and the cylindrical C. of some of the *Confervæ* are more than an inch long—although their transverse diameter is very minute—whilst, on the other hand, the spores of *Fungi* are C. of a diameter of $\frac{1}{1000}$ of an inch. The average diameter of the C. in the parenchymatous tissues is about $\frac{1}{100}$ of an inch.

Both the cell-wall and the contents differ from the corresponding parts in animal cells. In all young C. the wall is membranous, freely permeable by water, elastic, and flexible. In many cases it retains these properties, whilst in others it becomes much modified, as the cell grows older. It consists mainly of CELLULOSE (q. v.). As the vital and chemical phenomena exhibited by plants depend primarily upon operations in the interior of the cell, the careful study of the cell contents is of the highest importance. Of these contents, the most important are the *primordial utricle*, with the *protoplasm*, the *nucleus*, *chlorophyll corpuscles*, and *starch granules*.

The *primordial utricle* is a layer of substance of mucilaginous consistence (coloured yellow by iodine), lining the entire wall of the young cell, but often disappearing at a comparatively early period. The *protoplasm* is a tough mucilaginous and frequently granular fluid, which fills up the space in the interior of the cell not occupied by the nucleus. The nucleus or cytoblast is a globular or lenticular body, identical in its character with the substance of the *primordial utricle*, and occurring in the *protoplasm* of most young cells. Little is known with certainty regarding the *chlorophyll corpuscles*, except that, under the influence of solar light, green colouring matter is developed from them. Of the *starch granules*, which are very commonly found in the cell contents, we need not speak, as they are sufficiently described in the article STARCH.

In addition to the above organised structures, we must mention as frequent constituents of the cell-contents, fluid colouring matters, essential and fixed oils, resins, sugar, dextrose, gum, alkaloids, and mineral or organic salts, which are not unfrequently found in a crystalline form, when they are termed raphides.

There are two modes of cell-development in the vegetable kingdom—viz. (1.) *Cell-division*, where two or more new cells fill the cavity of the parent cell, and adhere to its membranes, appearing to divide it into compartments; and (2.) *Free cell-formation*—not to be confounded with a process of the same name which is supposed to occur in the animal kingdom—in which the whole or part of the cell-contents become detached from the cell-wall and resolved into new loose C., which ultimately escape from the parent cell. The former mode universally occurs in the formation of the C. by which growth is effected; the latter occurs only in the production of C. connected with reproduction. For further information, we must refer the reader to Von Mohl's *Principles of the Anatomy and Physiology of the Vegetable Cell*, translated by Henfrey, London, 1852.

CELLULAR TISSUE. This is the old term for a widely diffused animal texture, which has also received the names of areolar, reticular, filamentous, and connective tissue. If we make a cut through the skin, and proceed to raise it, we see that it is loosely connected with the subjacent parts by a soft, filamentous, elastic substance, which, when free from fat, has a white fleecy aspect. This is the tissue in question. It is also found underneath the serous and mucous membranes which are spread over internal surfaces, and serves to attach these membranes to the parts which they line. We likewise find it lying between the muscles, the blood-vessels, nerves, &c., occupying the interspaces between the different organs, and often investing each of them with a special sheath. While it thus connects and insulates entire organs, it at the same time performs a similar function in regard to the minute parts of which each organ is made up. Thus, for instance, in muscular tissue, it enters between the fibres of the muscle, uniting them into bundles; and similarly, it enters

CELLULAR TISSUE—CELSUS.

into glands, &c. This is termed *penetrating* or *parenchymal* cellular tissue.

It is not only one of the most general and most extensively distributed of the tissues, but it is continuous through the whole organism, and may be traced without interruption from any one region of the body to any other. It is in consequence of this continuity that dropical fluids, air, &c., effused into the C. T., may spread far from the spot where they were first introduced.

On examining a fragment of this tissue, when stretched out, we see with the naked eye that it presents the appearance of a multitude of fine, soft, colourless, elastic threads, like spun glass; intermixed with these are delicate films or laminae, crossing one another in all directions, and leaving open spaces, or areolae; hence the name of areolar tissue.

A small quantity of colourless transparent fluid is always present in this tissue; when abnormally increased, it gives rise to the form of general dropsy known as anasarca. The microscopic characters of C. T. are briefly noticed in the article TISSUES, ANIMAL.

CELLULAR TISSUE, in Botany, is any vegetable tissue formed of cohering cells alone, and in which there are no vessels. It is often called *parenchyma* (Gr. something spread out), although an attempt has been made to restrict that term to one kind of it, with cells of a particular form, and terms of Greek derivation have been multiplied for other kinds. The cells of C. T. vary much, both in form and size (see CELLS); but particular forms and sizes are characteristic of particular kinds or particular parts of plants. The products of the vital activity

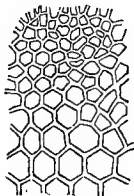

Cellular Tissue in a Leaf.

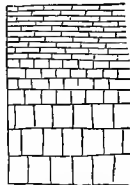

Muriform Cellular Tissue in Wood or Bark.

of plants are formed in the interior of cells, or by secretion from the inner side of their walls. Vessels being formed from cells, it is not easy to fix the limits between C. T. and *Vascular Tissue* (q. v.). Some kinds of plants, however, are entirely composed of C. T. (see next article); all consist of it in the earliest stages of their growth; none are at any time destitute of it. Fluids are transmitted from cell to cell, through the mass of C. T., passing through the walls of the cells where there are no openings that can be detected by the microscope. The soft and succulent parts of plants, which it is the care of the gardener to cherish and increase, consist chiefly of cellular tissue.

CELLULARES, in Botany, a designation applied to those plants which consist entirely of *Cellular Tissue* (q. v.), without proper vessels of any kind. C., thus defined, are a sub-class of acotyledonous plants, containing the orders *Lichens*, *Fungi*, and *Algae*. In the system of De Candolle, however, the name C. was given to the second grand division of plants, the first being called *Vasculares*, and the distinction between them being the presence or absence of vessels, the C. including all acotyledonous or cryptogamous plants. But ferns and mosses are not destitute of vessels; so that this system is not strictly accurate with regard to them: whilst, as all

vessels are now known to be formed by the elongation and union of cells, the distinction between vascular and cellular tissue is not generally regarded as affording a good basis for primary divisions in the classification of plants.

CELLULOSE is the term applied to the carbohydrate, $C_{12}H_{10}O_{10}$, which forms the mass of the cell-membranes of all plants. It is one of a class of compounds intimately connected in their chemical constitution, but presenting remarkable physical differences. Without entering into chemical details, we may mention the following points of difference between it and the chemically allied substances—sugar, dextrine, and starch. Sugar and dextrine are soluble in cold water, and occur in the cell sap in solution; starch is insoluble in cold water, but softens into a mucilage in boiling water, and is found in granules in the cell-contents; while C. is insoluble in cold or boiling water, and, as far as is at present known, is very slightly soluble in the strong mineral acids, its only perfect solvent being a solution of oxide of copper in ammonia.

The occurrence of C. in an organism was formerly regarded as a certain proof that the latter belonged to the vegetable kingdom. It has, however, been shewn to be a constituent of the lower animals.

Although C. forms a large proportion of the food of herbivorous animals, it is supposed to pass through the intestinal canal unchanged, and not to contribute directly to nutrition.

CELSUS, an Epicurean philosopher, but tinged with Platonism, lived in the 2d c. after Christ, and wrote, after 150 A.D., under the title *Logos Alethes* (the True Word), the first considerable polemic against Christianity. The book itself has perished; but considerable fragments have been preserved as quotations given by Origen in his answer, *Contra Celsum*, in eight books. In the fragments—which are very interesting, as shewing the views of a heathen philosopher in regard to Christianity—C., with wit and acuteness, but without depth or earnestness of thought, prefers against the new religion charges of unphilosophicalness and blind credulity; and especially endeavours to convict Christians of self-contradiction in their spiritual doctrine contrasted with their anthropomorphic representations of Deity; in their religious arrogance contrasted with their confession of sinfulness; and in their views of the necessity of redemption. He also reproaches Christians with their party divisions and ever-varying opinion. With regard to his own positive doctrines, he speaks of evil as necessary and eternal, as an essential property of the material world (*hyle*); sin as something that can never be entirely removed, and least of all, through a vicarious sacrifice. He charges Christians with having wilfully altered their sacred writings.

CELSUS, AULUS CORNELIUS, a Latin physician and writer, who flourished probably in the reign of Augustus. He was called the Roman Hippocrates, because he generally followed the great 'Father of Medicine,' and introduced the Hippocratic system among the Romans. C. wrote not only on medicine, but also on rhetoric, history, philosophy, the art of war, and agriculture. His style is succinct and clear, but full of Gracisms. The only great work of his which survives, is the *De Medicinâ*, which is divided into eight books. The portions relating to surgery are exceedingly interesting and valuable, because C. has there given an account of the opinions and observations of the Alexandrian school of medicine. The first edition of the *De Medicinâ* appeared at Florence in 1478. C.'s works have been translated into several modern languages. A translation into English was made by Dr Grieve, London, 1756.

CELT—CELTIC NATIONS.

Among the best editions are those of Krause (Leip. 1766), Dr Milligan's 2d edition (Edin. 1831), and one at Cologne, 1835.

CELT (Lat. *celtis*, a chisel), the name by which certain weapons or implements of the early inhabitants of Western Europe are known among archaeologists. Celts are either of *stone* or of *bronze*.

Stone celts vary in length from about 1 inch to 22 inches; but the most common size is from 6 to 8 inches in length, and from 2 to 3½ inches in breadth. They are made of almost every kind of stone, and shew considerable diversity of shape, almost all, however, having more or less resemblance to the muscle-shell. Fig. 1 in the accompanying wood-cut shews a stone C. of the better kind. The ruder celts are generally of slate, shale, schist, or grit; the finer, of flint, porphyry, greenstone, syenite, or agate. Many of the finer celts are beautifully shaped and highly polished. A remarkable example of this class, the property of Sir Coutts Lindsay, found near St Andrews, in Scotland, is described by Sir David Brewster in the *Philosophical Journal* for 1823. Recently, a class of celts found in the later geological strata have excited much interest as well among archaeologists as among geologists. They are obviously of the same type with the more common celts, but of ruder construction, as if fashioned by a more barbarous people. The stone C. was fastened into a handle of horn, hone, or wood, as shewn in the accompanying wood-cut. Fig. 2

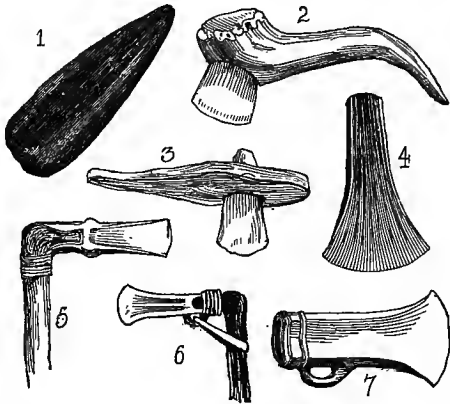

Celts.

represents a C. of serpentine, with a handle of deer-horn, found in one of the Swiss lakes in July 1859. Fig. 3 represents a stone C. with a wooden handle, found in the county of Tyrone, in Ireland.

Bronze celts vary in length from about 1 inch to 8 or 10 inches, the most common length being about 6 inches. They are sometimes ornamented with rudely incised lines or circles, and have occasionally been found wrapped up in linen, or enclosed in bronze cases or sheaths. They shew much greater diversity of shape than the stone celt. As many as four classes have been distinguished by archaeologists—1st, The simple wedge-shaped C., most nearly resembling the common form of the stone C., as in the accompanying wood-cut, fig. 4. 2d, The wedge-shaped C., with sides more or less overlapping, and a stop ridge or elevation between the blade and the part which received the handle, as in fig. 5. 3d, The wedge-shaped C., with sides greatly overlapping, with or without the stop-ridge, but with a loop or ear upon, and parallel to, its lower surface, as in fig. 6. 4th, The socketed C., or the C. with a

hollow to receive the handle, and generally with a loop or ear upon its lower surface, as in fig. 7.

Both stone and bronze celts were probably used for several purposes, serving for chisels, adzes, and axes, as well as for weapons of war, like the stone hatchets of the South Sea Islanders and other savage or barbarous tribes. Examples of stone and bronze celts of all classes (together with the moulds in which bronze celts were cast) may be seen in the British Museum at London, in the National Museum of the Antiquaries of Scotland at Edinburgh, and in the Museum of the Royal Irish Academy at Dublin. This last collection has more than 500 examples of stone celts, about one-half of which were found in deepening the bed of the Shannon or its tributaries, between the years 1843 and 1848. A hushel of bronze celts has more than once been discovered at one spot.

CELTIBERI, a powerful people of ancient Spain, supposed to have sprung from a blending of the Iberians or Spanish aborigines with Celtic invaders from Gaul. The C. inhabited a large inland district of the Peninsula, corresponding to the south-west half of Aragon, nearly the whole of Cuenca and Soria, and a great part of Burgos, but the name Celtiberia had often a wider signification, including the country as far south as the sources of the Guadalquivir. The C. were divided into four tribes, and were unquestionably one of the bravest and noblest peoples in the Peninsula. Their cavalry and infantry were equally excellent. For many years, they withstood the efforts of the Romans to subdue them, and it was not till after the campaigns of Sertorius that they began to adopt the Roman language, dress, and manners.

CELTIC NATIONS, one of the groups of the great Aryan (q. v.) family.

Languages.—In addition to the English, and retreating before it, there are at present four languages spoken in the British Isles—the Irish, the Highland Scotch (or Gaelic), the Manx, in the Isle of Man—all three nearly related to one another, and constituting the northern (Erse, Gadhelic) branch of the Celtic languages; whilst the fourth language, the Welsh, constitutes, together with the Cornish of Cornwall (extinct since 1778) and the Bas Breton of Brittany, the southern (Briton, Cymric, Cambric) branch. The remains of the language of the Gauls or Celts, the ancient inhabitants of France, closely resemble the British and Gadhelic idioms; hence the name Celtic languages has been applied to the whole of them. The Celtic idioms belong to the Indo-German (Aryan) family, as their numerals shew. Compare

Old Irish.	Old Welsh.	Sanscrit.
1. óin	un	áka
2. dá	don	dvāu
3. trí	tri	trayas
4. cethir (e = k)	pedwar	chatvāras
5. cóic	pimp	pañchan
6. ae	chwech	shash
7. secht(n)	seith	saptan
8. oct(n)	wyth	ashtan
9. noi(n)	nau	navan
10. deich	dec	daçan
20. fichet	ugelnt	vinçati
100. cét	cant	çata

The Gaulish was nearer to the Cymric branch, its numerals 4 and 5 having been *petor*, *pempe*. There are a few Gaulish inscriptions which shew a declension with full inflections; in old Irish, five cases still exist, but the terminations are very much mutilated; in Welsh, they have disappeared. Thus, the Gaulish name *Segomavros* is declined: gen. *-ri*, dat. *-ru*, acc. *-ron*: the old Irish, *fer*, a man, has the gen. *fir*, dat. *fir*, acc. *fer*, voc. *fir*; whilst the corresponding Welsh *gwr* is inflexible. Hence it follows that the

pseudo-simplicity of the Welsh is the result of grammatical decay, common in all Aryan languages, and does not at all warrant Latham's theory, that the Celts branched off from the primitive Indo-German nation before the development of case inflections.

History.—Of the separation of the Celts from the other Aryans or Indo-Germans, and their early migrations to Western Europe, no record has come down, the stories about Milesian colonies in Ireland, and migrations from Troy into Wales, being simply monkish fictions. At the dawn of history, we find the *Gauls* (Galli, Celtæ, *Galatai*) occupying France (Gallia), which was divided into *Aquitania*, between the Pyrenees and Garonne; *Gallia Celtica* Proper, between Garonne and Seine; and *Belyica*, from the Seine to the Rhine. The land about the *Rhone* being more early conquered by the Romans than the rest, was set apart by them under the name of *Gallia Narbonensis*, or *Gallia Lugdunensis* (from the towns Narbo and Lugdunum, Narbonne and Lyon). The whole of the four was called *Gaul beyond the Alps* (Gallia Transalpina). A great many tribes of Gauls had settled in Lombardy, where they founded *Mediolanum* (Milan), and which therefore took the name *Gallia Cisalpina* (Gaul this side the Alps). Other Gauls had penetrated into Spain, where they became mixed with the native Iberians, and thus gave rise to the *Celtiberians* about the river Iberus (Ebro). Numerous hosts migrated across the Rhine, occupied Southern Germany and Bohemia, and, following the course of the Danube, some invaded Thrace and Greece (278 B. C.); but being repelled, the main body of them settled in Asia Minor, in the province called after them *Galatia*. The Romans found the Gauls at first very formidable enemies; Rome itself was burned by them (389 B. C.), but gradually the Romans conquered first Gallia Cisalpina (222), then Gallia Narbonensis (112), and lastly, Cæsar subjected all France (52 B. C.), after which the Gauls soon became Romanised. The Gauls of Asia Minor, for a long time the terror of all the neighbourhood, were defeated by the Romans (187), and their land finally made a province of the empire (25 B. C.).—The *Britons* (*Britanni*; Welsh, *Brython*) were little known before Cæsar's two unsuccessful expeditions into Britannia; the country was conquered by the Roman general Agricola (78—84 A. D.), who secured the new province against the inroads of the Caledonians of Scotland by a fortification across the Scotch Lowlands, between the Forth and the Clyde, afterwards removed by the Emperor Hadrian further southward, to between Solway Firth and the mouth of the Tyne. The Britons were so much influenced by Roman civilisation—they were also early converted to Christianity—that the heathen Angles and Saxons, who conquered them in the 5th and 6th centuries, called them *Welsh*; a name which, with the other Teutons, applies to all nations speaking languages of Latin descent. A few of the Britons maintained their independence in Cornwall, Cumberland, and in the mountains of *Wales*. On the last, the name Welsh was ultimately fixed by the English; they themselves, however, called their nation *Cymro*, pl. *Cymry* (a compound of *cyn*, with, in common, and *bro*, land = having a common country, countrymen, in contradistinction to the foreign invader), a name which has nothing to do with Cimbr and Cimmeri. The Welsh remained independent under different petty princes till 1282, when Edward I. conquered them. A part of the Britons went over in the 4th c. to France, where they took possession of *Brittany*, which maintained a doubtful independence under dukes of its own till about 1500.—Whether the *Caledonians*, the oldest

inhabitants of Scotland, were Celts of the Cymric or Erse branch, is unknown. After the 3d c., their name disappears, and we hear, instead, of the *Scoti* and *Picti*. As to the latter, the same doubt prevails; but the *Scoti* were emigrants from Ireland, both *Scotus* and *Gadhelus* being common national names of the old Irish. From *Gadhel*, the modern *Gael*, *Gaelic* is derived, which has nothing to do with the name of the Galli.—*Ireland* (*Hibernia*, whence the modern *Éirinn* is derived) enters into the light of history with its conversion to Christianity by St Patrick (460). The four centuries following on this event are the brightest period in its history. Ireland was then the seat of piety and learning, and sent forth numerous missionaries, by whom many monasteries, centres of civilisation, were founded—as *Iona*, in Scotland, by Columba (563); *St Gall*, by Gallus (615); *Würzburg*, by Kilian (687). In the 7th c., we find Irish bishops at Ratisbon; and *Virgilius* (Feargal), (died 784), Bishop of Salzburg, played no small part in the ecclesiastical history of Germany. But Ireland remained politically divided among many princes, and so became an easy prey of those 'black heathens' the Scandinavians, whose invasions began 795, and who founded Norse kingdoms at Dublin, Waterford, Limerick, &c. In the fierce battles between the two nations, the prosperity of Ireland rapidly declined, and the English conquest (1171) only completed the ruin.—The Isle of *Man*, inhabited by a branch of the Irish, after having been subject to Welsh, Scotch, Norse princes in turn, acknowledged England's sovereignty in 1344.

Religion and Mythology.—A few notices in the classics and the Latin inscriptions of Gaul are our rather meagre sources of information on the Celtic paganism. As the three chief gods, or three of the chief gods, Lucan mentions *Teutates*, *Hesus*, and *Taranis*, all of them worshipped with human sacrifices. *Taranis* reappears as *Jupiter Taramivius* on an inscription; and from this identification with Jupiter, as well as from the fact that in Welsh *taran* means thunder, we may infer that he was the god of the thunderstorm. Other gods frequently occurring on inscriptions are *Apollo Grannus*, *Apollo Belenus*, *Mars Camulus*, *Minerva Belisama*, &c., all of them, however, empty names to us. A remarkable feature in Gaulish religion was the worship of certain *Mother Goddesses* (called on the inscriptions *Junones*, *Matronæ*, *Dææ Matres*, *Campestres*, *Nymphæ*). They are frequently connected with special localities, as in the inscriptions dedicated to *Matronis Lanehiabus*, *M. Hamavehis*, *M. Rumanehabus*, and on the one in Gaulish: *Matrebo Namawicabo*, 'to the Mothers of Nîmes.' To this class apparently belongs the *Dea Nehalennia*, once represented on a relief with a basket of fruit, and a dog for companion. Mela, the geographer, speaks of an island in the Atlantic, near Gaul, where there was an oracle superintended by nine maidens, who could cause storms, take the form of any animal, could cure what otherwise was incurable, and predicted the future. These goddesses, at once motherly and maidenly, residing in field and wood (campestres, nymphæ), givers of plenty and prophets of the future, are the heathen prototypes of the *fées* (fairies, as distinguished from 'elfs') of the middle ages. The 'little folk' were known to the Gauls under the name of *Dusi*. They believed in the existence of individual tutelary genii, as a stone of Lausanne shews, being erected by three Gauls *Suljis suis* (hence our sylph?). The belief in the transmigration of souls was common amongst the Gauls, or at least their priests the *Druids*, so called from their performing sacred rites in oak-woods (Welsh, *derw*, an oak; *derwydd*,

a Druid). These Druids were also the depositaries of knowledge and tradition, and constituted, in Gaul at least, a powerful hierarchy, with a supreme pontiff. Druids are found both in Ireland and in Wales, and the fées abound in Welsh tradition; but it is very doubtful whether the superhuman beings appearing in the Welsh poems of the 12th and 13th centuries—such as *Hu Gadarn*, the reputed founder of Bardic institutions (see beneath)—are genuine relics of the British religion. The belief in transmigration lasted very long, as the medieval Welsh tale of *Taliesin* speaks distinctly of Taliesin's successive existences. Though not properly mythological, we may mention here the romantic stories of the Britons about King *Arthur* and his knights. He is first mentioned by *Nennius* in the 9th c.; but his fable was further developed in the next centuries both in Wales and Brittany, then embodied in *Geoffrey of Monmouth's Historia Britonum*, which served as the groundwork of the French *Roman de Brut* of Wace. Through these works, and partly, also, through the direct influence of the oral traditions of Brittany, it passed into French literature, and thence spread over all Europe.

Literature.—The Gauls learned writing from the Greeks; later, they employed the Roman alphabet, as do the Welsh and Irish, the now used Irish character being nothing but the common Anglo-Saxon form of the Latin alphabet. Besides, however, the Irish claim an old character of their own, the Ogham, in which the letters are represented by a number of vertical strokes put in a right angle to a horizontal line, or else by horizontal strokes to a vertical line. Some of the Ogham inscriptions are said to be older than Christianity. Even more doubtful is the antiquity of a Welsh so-called Bardic alphabet, in which there seem to be no inscriptions extant, and which is, at any rate, an alteration of the Roman character. A feature common to all Celts is the existence of a kind of literary order, the *Bards* (q. v.), poets and guardians of tradition—in Gaul, nearly related to or part of the priesthood; in Wales and Ireland, in immediate connection with the kings.—A *Gaulish* literature there certainly was, as *Cæsar* informs us that, in the schools of the Druids, the young men used to learn by heart a great number of verses on theological and historical subjects. But these poems were never written down. It is highly probable that rhyme, first used by *St Ambrosius* (397) in his hymns, is of Gaulish origin, this being the common form even of the oldest Irish and Welsh poems.—The *Irish* literature began with the conversion, but our existing manuscripts are not older than the 9th or 8th century. Interlinear versions of biblical and other theological, or of grammatical writings are about the oldest manuscripts, many of which, in consequence of the missionary zeal of the nation, are to be found at *St Gall*, *Milan*, and other continental places. Then there are ecclesiastical hymns, one of the oldest ascribed to *Patrick*. A renowned author of poems, in the 10th century, was *Eochad O'Flin*. Secular poetry of ancient times there has come down to us none, but we have testimonies as old as the 12th c., of the existence of such, ascribed in a general way to the old pagan hero *Oisín*, son of *MacCúmhail*. The existing specimens, mostly warlike—except some dialogues between *Oisín* and *St Patrick*—are recent. Those Gaels that went over to Scotland, took, of course, similar traditions with them. With a partial knowledge of these, *Macpherson* composed (1765) the work which he declared (rather loosely) to be an English translation of the songs of the old Scotch poet *Ossian*, son of *Fingal* (the true *Oisín* was an Irishman).

The would-be Gaelic original of *Macpherson's* work, edited 1807, is in all probability a retranslation. Of Irish prose, the annals are the most important part: first, those of *Tigernach* (1088), then the *Annales Inisfallenenses*, *A. Ultonienses*; lastly, the *Annals of the Four Masters*, being a compilation made (1634) from older sources chiefly by four Franciscans, beginning with 242 after the Deluge, and ending with 1616 A.D.—The oldest remains of *Welsh* literature are the songs, so far as they are genuine, of the bards of the 6th c.—*Liwarch Hen*, *Aneurin*, *Taliesin*—having chiefly the life and deeds of contemporary princes for their subject, but few in number. In the 10th c., we have the collection of laws by *Howel Dda*. The historians *Gildas* and *Nennius*, of the 9th c., wrote in Latin.

The great age of *Welsh* literature is the 12th and succeeding centuries, when the energies of the nation were roused in the struggle with England. In this contest, the bards played a conspicuous part as agitators. After a long interval, we hear again of a great bard, *Meylyr* (1100); many follow, amongst whom *Kynddelw* (1200) deserves special mention, both as a poet (we have 49 pieces of his) and a patriot. *Welsh* poetry consists in—
1. Political lyrics, war-songs, songs in praise of chieftains, elegies on the same. 2. Religious hymns. 3. Pseudonymous poems, ascribed to *Merddin* (*Merlin*), the mythical enchanter, and *Taliesin*, the old bard, having generally the form of prophecies on the struggle between the Saxons and *Welsh*, and the ultimate triumph of the latter. Thus, in the *Avallennau* (or *Apple-trees*), attributed to *Merlin*, the *Welsh* nation is enigmatically represented under the image of 'seven score and seven sweet apple-trees,' whose fruits, princes (viz., the English) wish in vain to despoil. 4. The *Triads*, short memorial (?) verses in which three remarkable events, subjects, or persons are respectively mentioned, hence the name, embracing history, theology, jurisprudence. 5. Dialogues of dramatic character. There were—apparently now lost—also miracle plays actually represented.

The only remarkable remnant of *Cornish literature* comes under this head, being three ecclesiastical plays of the 14th c.—the *Creation*, the *Passion*, and the *Resurrection*.—In *Welsh* prose, we have first the chronicles. *Geoffrey's* chronicle, though Latin, is thoroughly national; then there is that of *Caradoc*, who begins where *Geoffrey* leaves off; and the *Liber Landavensis*, a history of the bishops of *Llandaff* down to 1132. Further, we have the *Mabinogion* (*Children's Tales*), romantic stories. The most interesting of these refer to *Arthur* and his champions; the lady of the fountain, *Peredur*, *Geraint* (now revived by *Thomson*), *Arthur's* boar-hunt. Amongst the non-Arthurian tales, special mention is deserved by the *Mabinogi of Taliesin*, interspersed with verses, relating the adventures, transformations into animal shape, and transigrations of that bard. There are besides some scientific writings, a treatise on medicine, another on geometry, and one on *Welsh* prosody by *Edeyrn* (1260). This last, a grammatical essay in and on a vernacular tongue, is paralleled in the middle ages only by *Icelandic* literature, to which, upon the whole, the *Welsh*, although not quite so high, bears a marked resemblance.

Concluding Remarks.—Altogether, the Celts are a very important branch of our Indo-German family. The incessant warfare of the Gauls bespeak at least activity of mind and body; the Irish missions have done a great deal for European civilisation; whilst the traditions of the Britons have deeply influenced medieval literature. The one great defect of the Celts is incapacity for political organisation. Their

very enthusiasm, lively feeling, and vivid imagination, have ever prevented them from taking coolly and deliberately those measures which lead to national unity; hence it is that they gave way before the more practical Roman and Teuton. But while they lost their independence, and oftentimes their very language in the contest with the foreigner, whose strong hand moulded them into national unity, yet they reacted on him in their turn. They are fast disappearing by merging into the English; but if the quiet resolution, the sturdy common sense, the talent for public life, state organisation, and political dominion, that characterise the modern British nation, are altogether Teutonic—on the other hand, their genuine refinement of manner and feeling, and their high poetical susceptibilities, are to no small extent due to the admixture of Celtic blood.

CELTIS. See NETTLE-TREE.

CEMBRA NUT AND CEMBRA PINE. See PINE.

CEMENTATION OF STEEL is the process followed in the production of *Blistered Steel* (q. v.), or *steel of cementation*.

CEMENTS. A cement is a substance used to make the surfaces of solid bodies adhere to one another; it is applied in a liquid or viscous state, and hardens after the surfaces are brought together. When fused metals or alloys are used in this manner, they are called solders. There is a great variety of C. derived from animal, vegetable, and mineral substances. The animal C. are chiefly composed of gelatine and albumen as their bases. Joiners' glue is an example. See GLUE. The binding materials of vegetable C. are gums, resins, and wax. The mineral C. are chiefly of lime and its compounds. In many C., animal, vegetable, and mineral substances are combined. The simplest of the mineral C. is plaster of Paris, which is used for uniting slabs of marble, alabaster, and many similar purposes. It is mixed with water to the consistence of thick cream, and then applied. This hardens rapidly, but is not very strong. Its hardening depends upon the true chemical combination of the water with anhydrous sulphate of lime, of which plaster of Paris is composed, and the formation thereby of a solid hydrate. The plaster of Paris may be mixed with thin glue, with diluted white of egg, or a solution of size or gum, instead of water, and is strengthened thereby.

Keene's marble cement is prepared by steeping plaster of Paris in a concentrated solution of alum, then recalcining and powdering. This powder is mixed with water in the same manner as plaster of Paris. It is used as a stucco for internal decorations, takes a high polish, and when coloured, forms beautiful imitations of mosaic, marbles, scagliola, &c.

A mixture of paper-pulp, size, and plaster of Paris in equal proportions, forms a useful cement, and is also used as a sort of papier-mâché for casting into architectural ornaments, &c.

Common mortar is one of the most important of the lime cements. It is composed of slaked lime, or a mixture of this with sand; its hardening depends upon the slow formation of carbonate of lime by the absorption of carbonic acid from the atmosphere, and a partial combination with the silica of the sand. Cow-hair is sometimes mixed with it, to bind it when laid in masses. In order to obtain a fine smooth paste, which is required for good mortar, the lime should be slaked rapidly by adding about three parts of water to one of lime; if the quantity of water is too small, a coarser or semi-crystalline hydrate of lime is produced by the slaking. For the mode of applying mortar, see BRICKWORK.

Ordinary mortar, when exposed to the continuous

action of water, softens and disintegrates, and some of the lime dissolves away. Lime which contains 20 or 30 per cent. of clay, or finely divided silica, produces a mortar which is not liable to this softening, but possesses the property of hardening under water; such lime is called *hydraulic*, and the mortar made from it, *hydraulic cement* or mortar.

Puzzolana, a porous lava found at Puzzuoli, near Naples, has been long celebrated for its property of forming a hydraulic cement, when mixed with ordinary lime. It is mainly composed of silicates of alumina, lime, and soda. Portland cement, so named from its resemblance to Portland stone when dry, is made from clay found in the valley of the Medway, which is intimately mixed with the neighbouring chalk, and then burned. Roman cement is similar to the Portland, but of a darker colour; it contains a larger proportion of clay, and solidifies more rapidly. These C. should be mixed with a sufficient quantity of water, to form a moderately thick paste; the surfaces to which they are applied should be well wetted, and the cement kept slightly moist until it hardens. The solidification of hydraulic cements depends upon the combination of the lime with the silica and alumina forming, first a hydrated compound, and finally a true silicate. They expand slightly in solidifying.

The following receipts include some of the most useful and reliable C. applicable to the purposes specified: For water-tight joints, such as slate cisterns, aquaria, &c., and for uniting broken pieces of stone, and filling up metallic joints—take equal parts of red and white lead, and work them into a stiff paste with boiled linseed oil. When used for metal joints, it should be made rather thin, and both pieces of metal, as well as the washer, well smeared with it. This cement slowly hardens, but becomes ultimately of almost flinty hardness. We have before us an aquarium, holding fifteen gallons of water, made of plate-glass, cemented at the angles to mahogany columns with this composition. It has stood without leaking for above three years, in spite of much rough handling and moving about; and the cement is now so hard, that it is difficult to scratch it with a knife.

Cement composed of ox-blood thickened with finely powdered quicklime, is used by copper-smiths, for securing the edges of rivets of copper boilers, and for steam-joints. Another cement for steam-joints is made with borings or turnings of cast-iron mixed with a little sal ammoniac and flower of sulphur. It should be stirred up with a small quantity of water, just sufficient to moisten it, then rammed into the joint, which should be bolted up as tightly as possible: 5 lbs. of iron borings to 2 oz. of sal ammoniac, and 1 oz. of sulphur, are the proportions recommended. A cement of this kind may be made of 4 lbs. iron borings, 2 lbs. pipe-clay, and 1 lb. of powdered earthenware fragments made into a paste with salt and water; or 2 parts litharge in fine powder, 1 part very fine sand, and 1 of quicklime that has slaked spontaneously in a damp place. These should be mixed, and kept from the air, and made into a paste with boiled linseed oil when about to be used. This is a valuable cement for steam-joints, for mending cracks in boilers, ovens, &c. Beale's Patent Fireproof Cement, for similar purposes, is composed of chalk, 12 parts; lime and salt, each 4 parts; Barnsey sand, 2 parts; iron filings or dust, 1 part; and blue or red clay, 1 part. These are ground and calcined together.

Electrical Cement—so called from its use in uniting the cylinders of electrical machines to their axes, and for a variety of similar purposes—is composed of 5 lbs. rosin, 1 lb. each of bees'-wax and red ochre,

and 4 oz. of plaster of Paris. This is Singer's formula. A cheaper cement of this kind may be made from 14 parts rosin, 2 red ochre, and 1 plaster of Paris. These should be melted together till the frothing ceases, and the composition runs smoothly. This is applicable to a variety of purposes, where a cheap and tolerably adhesive cement is required. It will serve as bottle-wax for sealing the tops of corks; but this is usually prepared from 4 parts rosin with 1 of tallow or suet, and red ochre or other colouring matter added.

For mending earthenware and china, &c., a variety of C. are recommended. For ornamental glass or china, which is not subjected to heat or rough usage, Canada balsam that has evaporated until rather hard, is a very useful cement; from its transparency, it makes an almost invisible joint. The surfaces should be slightly warmed, and the balsam brushed over them, after which they should be kept pressed together for a short time. Thick copal or mastic varnish may be used in the same manner. Gum shell-lac, dissolved in spirits of wine in sufficient quantity to form a treacly liquid, forms a stronger cement than the above, but its colour is objectionable for some purposes. The shell-lac may be dissolved in naphtha, but is not equal to that in spirits of wine. The *liquid glue* sold in the shops is usually prepared in this manner; another kind is made of a mixture of the solutions of shell-lac and India rubber. The cement sold in sticks at fairs and in the streets of London by loquacious itinerants, is shell-lac or gum mastic fused and moulded into a convenient form, and is one of the most useful C. when properly applied, by heating the surfaces to be joined just sufficiently to fuse the shell-lac, and then smearing them thinly with it, and pressing them together. If shell-lac is heated much above its fusing-point, it becomes carbonised and rotten, and therefore great care must be used in fusing any composition of which it is an ingredient. The *marine glue*, a mixture of shell-lac and India rubber, is a remarkable cement, and when applied, as the last, with the precautions just alluded to, is so strong, that glass or china cemented with it, and then dashed on the ground, or otherwise broken again, will give way in any part rather than that cemented. This cement may be purchased ready made. For the mode of preparing it, see *GLUE*.

Universal Cement, used for the above and many other purposes, is prepared as follows: Curdle skim-milk with rennet or vinegar, press out the whey, and dry the curd at a very gentle heat, but as quickly as possible. When it has become quite dry, grind it in a coffee or pepper mill, and next triturate it in a mortar until reduced to a very fine powder. Mix this powder with $\frac{1}{10}$ th of its weight of new dry quicklime, also in very fine powder, and to every ounce of the mixture add 5 or 6 grains of powdered camphor; triturate the whole well together, and keep it in small wide-mouthed phials well corked. When required, make it into a paste with a little water, and apply it immediately.

Cheese Cement is similar in composition and uses. Take two parts of grated cheese and one of quicklime in fine powder; beat these together with white of egg to form a paste, and use immediately.

The following is the reputed formula for preparing the *Armenian or Diamond Cement*, used by the Armenian jewellers for attaching diamonds, &c., without any metallic setting: 'Dissolve 5 or 6 bits of gum-mastic, each the size of a large pea, in as much rectified spirit of wine as will suffice to render it liquid; and in another vessel dissolve as much isinglass, previously a little softened in water—though none of the water must be used—in French brandy, or good rum, as will make a 2-ounce phial

of very strong glue, adding two very small bits of gum galbanum or ammoniacum, which must be rubbed or ground till they are dissolved. Then mix the whole with a sufficient heat. Keep the glue in a phial closely stopped, and when it is to be used, set the phial in boiling water.' This cement has a great reputation, but our experience does not confirm it. We have tried the above, and several other receipts, with very little success. We doubt whether the true method of preparing it is known in this country, and suspect that it still remains one of the oriental trade-secrets. White of egg, thickened with finely powdered quicklime, forms a useful cement, especially if the cemented article is warmed for a short time in a slow oven.

Cutlery's Cement, used for fixing knives and forks in handles, is made of equal weights of rosin and brick-dust melted together; or, for a superior quality, 4 parts of rosin, 1 of bees-wax, and 1 of brick-dust.

Mahogany Cement, used for stopping cracks and holes in mahogany, may be prepared by melting 4 parts of bees-wax with 1 of Indian red, and as much yellow ochre as is found requisite to give the colour. If shell-lac be substituted for the bees-wax, and less red used, a much harder cement is made.

For *French Cement*, *Rice Glue*, and other light C. for joining paper articles and artificial flowers, see *GLUE* and *PASTE*.

CEMETERY, from the Greek, may mean any grave-yard, or other place of deposit for the dead; but it has lately acquired a special meaning, applicable to those extensive ornamental burial-grounds which have recently come into use in this and other European countries, as the practice of burying within and around churches was gradually abandoned (see *BURIAL*). The fine burial-grounds of the Turks, extending over large tracts adorned by cedars and other trees, may have suggested the plan to Europeans. It was first exemplified on a great scale in Paris, in which, as the largest walled town in Europe, the disposal of the dead was long a matter of extreme anxiety and difficulty. There are few considerable towns in Britain near which there is not at least one C., and the legislation mentioned under the head of *BURIAL*, has rendered their establishment to a certain extent, a legal necessity. There was at first a natural feeling of regret at the prospect of deserting places of deposit for the dead so hallowed by ancient use and recent associations as the church and the churchyard. In many instances, however, the places thus professedly hallowed were in reality surrounded by degrading and disgusting circumstances. On the other hand, the new places of interment began to develop humanising and elevating influences, in beautiful trees and flowers, natural scenery, and works of monumental art. The new cemeteries are in many instances cheerful open places of recreation, and in them the place of rest for the dead has rather tended to improve than to undermine the health of the living. One of the oldest established and most celebrated of the European cemeteries, is that of Père la Chaise (q. v.), near Paris, the arrangements of which have been generally followed in the cemeteries of London and other English cities; with, however, this distinct difference, that the English cemeteries are divided into two portions—one consecrated for the burials of members of the Established Church, over whose remains the funeral service is read, and one unconsecrated for the burials of dissenters. In the Scottish cemeteries, of which there are good specimens at Edinburgh and Glasgow, no such distinctions exist. In the United States, as at Philadelphia and New York, there are cemeteries equal in point of arrangement to any in Europe.

CENCI, BEATRICE, called 'the beautiful parricide,' was the daughter of Francesco Cenci, a wealthy Roman nobleman. According to Muratori (*Annales*, lib. x.), Francesco was twice married, Beatrice being his daughter by the first wife. After his second marriage, he treated the children of his first wife in a revolting manner, and was even accused of hiring bandits to murder two of his sons on their return from Spain. The beauty of Beatrice inspired him with the horrible and incestuous desire to possess her person; with mingled lust and hate, he persecuted her from day to day, until circumstances enabled him to consummate his brutality. The unfortunate girl besought the help of her relatives, and of Pope Clement VII. (Aldobrandini), but did not receive it; whereupon, in company with her step-mother, and her brother, Giacomo, she planned and executed the murder of her unnatural parent. The crime was discovered, and both she and Giacomo were put to the torture; Giacomo confessed, but Beatrice persisted in the declaration that she was innocent. All, however, were condemned, and put to death, August 1599, in spite of the efforts of the learned Farinaceus, who wrote out and presented to the pope an account of the crimes and infamous life of Francesco. Such is Muratori's narrative. Other historians allege that neither Beatrice, her step-mother, nor her brother, had any part in the murder of Francesco, but that their condemnation was the result of an infernal plot hatched by two robbers, or by unknown persons whose instruments these were. It has also been stated, that the principal reason for refusing clemency was the avaricious desire, on the part of the pope, to confiscate the estates and possessions of the murdered man to the papal see; a statement in itself not improbable. In the Colonna Palace at Rome, there is still shewn an excellent painting of Beatrice, attributed to Guido. The story of Beatrice has been made the subject of a powerful tragedy by the poet Shelley.

CENIS, MONT, or MONTE CENISIO, a mountain-pass of the Alps, between Savoy and Piedmont, forming part of the water-shed between the valleys of the Doire and the Arc. The culminating point of the pass reaches an elevation of 6775 feet above the sea. Schist, limestone, and gypsum, in alternate beds, compose the strata of the mountain, the vegetation of which is rich in the rarer kinds of Alpine plants. Over the pass, a road was constructed (1803—1810) by the Chevalier Fabbioni, under Napoleon's orders, at an expense of £300,000. This is the safest, most practicable, and most frequented road across the Alps. The French troops entered Italy by this pass in 1859.

CEN'NOBITES. See **MONACHISM.**

CENO'MYCE. See **REINDEER MOSS.**

CEN'NOTAPH (Gr. *kenotaphion*, from *kenos*, empty, and *tafos*, a tomb), a monument which does not contain the remains of the deceased. They were originally erected for those whose bones could not be found, e. g., for those who had perished at sea. Latterly, the name was applied to tombs built by a man during his lifetime, for himself and the members of his family.

CEN'SER (Fr. *encensoir*, from Lat. *incendo*, to burn), a vase, or other sacred vessel, used for burning perfumes. See **INCENSE.** Censers were much used in the Hebrew service of the temple, but their form is not accurately ascertained, and it is probable that they varied in this respect, according to the occasions on which they were used. The C., called also a *thurible* (Lat. *thuribulum*, from *thus*, frankincense), is used in the Roman Catholic Church at

mass, vespers, and other offices. It is suspended by chains, which are held in the hand, and is tossed in the air, so as to throw the smoke of the incense in all directions. It varies very much in form, from a simple vase, or chafing-dish, covered by a perforated dome, to the ornamented structure represented in the woodcut.



Thurible.

CENSORS, the name of two Roman officers of state. The office was established by Servius Tullius, the fifth king of Rome. After the expulsion of the kings, it was held by the consuls, special magistrates not being appointed till 443 B. C. It continued to be filled by patricians till 351 B. C., when C. Marcius Rutilus, a plebeian, was elected. Twelve years later, it was enacted that one of the C. (there were always two) must be a plebeian. In 131 B. C., both C. for the first time were plebeians. The C. were elected in the *comitia centuriata*, presided over by a consul. The term of office at first lasted five years, but was shortly afterwards limited to eighteen months. The censorship was regarded as the highest dignity in the state, except the dictatorship. It was a sacred and irresponsible magistracy, whose powers were vast and undefined, and whose decisions were received with solemn reverence. The duties of the C. were threefold. 1. The taking of the census, or register of the citizens and of their property. 2. The *regimen morum* (regulation of morals). 3. The administration of the finances of the state. The taking of the census (Lat. *censeo*, to value, to take an account of) was originally their sole function (hence their name), and was held in the Campus Martius, in a building called *Villa Publica*. The *regimen morum* was the most dreaded and absolute of their powers. It grew naturally out of the exercise of the previous duty, which compelled them to exclude unworthy persons from the lists of citizens. Gradually, the superintendence of the C. extended from the public to the private life of citizens. They could inflict disgrace (*ignominia*) on any one whose conduct did not square with their notions of rectitude or duty. For instance, if a man neglected the cultivation of his fields, or carried on a disreputable trade, or refused to marry, or treated his family either too kindly or too harshly, or was extravagant, or guilty of bribery, cowardice, &c., he might be degraded, according to his rank, or otherwise punished. The administration of the finances of the state included the regulation of the *tributum*, or property-tax; of the *vectigalia*, such as the tithes paid for the public lands, salt-works, mines, customs, &c., which were usually leased out to speculators for five years; the preparation of the state budget, &c.—See Rovers, *De Censorum apud Romanos Auctoritate et Existimatione* (Utrecht, 1825).

CENSORSHIP OF THE PRESS, the term generally applied to the arrangements for regulating what may be printed, in countries where the press is not free. The simplest form of C. is when a public officer—the censor, or licenser, as he is sometimes called—reads over the MS. to be printed, and after striking out any objectionable passages, certifies that the work may be printed. Hence it is common in old books to see the word *imprimatur*—let it be printed, followed by one or more signatures.

Though it has its name from an analogy with the functions of the Roman censor, the C. did not come into operation until the invention of printing. It was common to all European countries, Great Britain included. The C. was established by act of parliament in 1662, 13 Char. II., c. 33: 'An act for preventing the frequent abuses in printing seditious, treasonable, and unlicensed books and pamphlets, and for regulating of printing and printing-presses.' This was a temporary act, renewed from time to time; and its renewal was refused in 1693, owing to a quarrel between the House of Commons and the licenser. Since that time there has been, generally speaking, no restriction in this country on what any man may publish; and he is merely responsible to the law, if in his publication he should commit any public or private wrong. See LIBEL, LAW OF; see also PRESS, FREEDOM OF THE; BOOK-TRADE; and COPYRIGHT.

CENSUS means, in this country, the periodical counting of the people. It is a Latin word applied by the Romans to one of the functions of their censors (q. v.). They had to enumerate the people, but only for immediate purposes of taxation, so that no accounts of the results of such enumerations has been preserved. The idea of ascertaining the numbers of the people, and the proportions in which they are divided according to sex, age, profession, rank, and the like, as statistical information, is of late origin. The first C. of Britain was taken in the first year of the present century—1801. From that time it has been taken at each period of ten years. An attempt, but a rather unsuccessful one, was made to take the statistics of Ireland in 1811. Ten years after, the attempt was repeated, but the accuracy of the bare enumeration it furnished was doubtful. That of 1831, which was an improvement, was corrected three years after, in order that it might form the basis of a new system of education. The two subsequent enumerations have been very trustworthy, and have furnished besides valuable statistics regarding the agricultural condition of the country. The system of registration under a registrar-general, established in England in 1836, gave considerable assistance in taking the C. of 1841 and of 1851, by supplying a staff for carrying out the enumeration, and also by affording the means of checking it, since, making allowances for migrations, the births and deaths recorded should balance the changes in the population between one C. and another. A similar registration system was extended to Scotland in 1854, of which the C. of 1861 will have the advantage. A C. must be taken for the whole empire simultaneously, otherwise it cannot be accurate. The practice is for the enumerating officer in each petty district to leave a schedule at each house, which he receives filled up, aiding, when necessary, in the filling up. The C. of 1851 was taken for the night of the 31st March. This C. supplied important, but not altogether satisfactory information, as to the educational and ecclesiastical condition of the country, elements which are to be left out in the enumeration of 1861. By the act for taking a C. in 1861, it is provided that a schedule shall be left in each house on Saturday the 6th of April, to be called for on the ensuing Monday. The schedule is to contain compartments for 'particulars of the name, sex, age, rank, profession or occupation, condition, relation to head of family, and birthplace of every living person' who passed the night of Sunday in the house. Almost all civilised nations now take a census at regular intervals. In France, it is taken every five years, the last being in 1856. In Belgium, it is every three years, the last being in 1858. In Austria, the same, the last being in 1857. In the

United States, it is every ten years; this year (1860) being that in which it falls to be taken.

CENT, and CENTIME (Lat. *centum*, a hundred), names of coins. The Dutch cent is a copper coin = $\frac{1}{100}$ th of the guilder, which is equal to 1s. 8d. sterling. In the United States of America, the cent is a copper coin = $\frac{1}{100}$ th part of the dollar, or nearly one halfpenny English. The Centime is the 100th of the French franc (q. v.), and is of the value of $\frac{1}{10}$ th of an English penny.

CENTAUR'ÉA, a genus of plants of the natural order *Compositæ*, sub-order *Cymaraceæ*, containing many species of annual and perennial herbaceous plants, chiefly natives of the temperate and cold regions of the eastern hemisphere. Six or seven species are natives of Britain, some of them common weeds, whilst some species appear among the frequent ornaments of flower-gardens.—The BLUE-BOTTLE, or CORN BLUE-BOTTLE (*C. cyanus*), is common in cornfields in Britain and other parts of Europe, and has now become frequent also in similar situations in America, and indeed over the greater part of the world. It is an annual, growing to the height of about two feet, and producing its flowers in July and August. The florets of the disk are small and purple; those of the ray are few, comparatively large, and of a bright blue. Its flowers have long been much used in wreaths and garlands. It is common in gardens, with flowers variously modified by cultivation. Water distilled from the flowers of the blue-bottle was at one time in high repute as a remedy for weak eyes. The juice of the florets of the disk, with a little alum, dyes a beautiful and permanent blue.—The large Blue-bottle (*C. montana*), a native of Central Europe, is still more frequently cultivated in flower-gardens. Its flowers are considerably larger, and it is a perennial.—SWEET SULTAN (*C. moschata*), a native of the Levant, with fragrant flowers, is also common in flower-gardens. It is an annual or biennial.—Several species, having the involucre spiny, bear the name of STAR-THISTLE. The common STAR-THISTLE (*C. calcitrapa*) is a native of the southern parts of Britain and of Europe.—The Common or Black KNAWPWEED, called in Scotland *Horse Knot* (*C. nigra*), is abundant in the meadows and pastures of most parts of Britain, and is a troublesome perennial weed, difficult of extirpation. *C. Jacea*, also called KNAWPWEED, more rare in Britain, is very common in some parts of Europe, and its bitter astringent root, and indeed the whole plant, were formerly used in medicine. It affords a beautiful bright yellow dye, almost as good as Saw-wort.—The name C. has its origin in an ancient legend concerning the cure of a centaur by one of the species.



Blue-bottle (*Centaurea cyanus*).

The juice of the florets of the disk, with a little alum, dyes a beautiful and permanent blue.—The large Blue-bottle (*C. montana*), a native of Central Europe, is still more frequently cultivated in flower-gardens. Its flowers are considerably larger, and it is a perennial.—SWEET SULTAN (*C. moschata*), a native of the Levant, with fragrant flowers, is also common in flower-gardens. It is an annual or biennial.—Several species, having the involucre spiny, bear the name of STAR-THISTLE. The common STAR-THISTLE (*C. calcitrapa*) is a native of the southern parts of Britain and of Europe.—The Common or Black KNAWPWEED, called in Scotland *Horse Knot* (*C. nigra*), is abundant in the meadows and pastures of most parts of Britain, and is a troublesome perennial weed, difficult of extirpation. *C. Jacea*, also called KNAWPWEED, more rare in Britain, is very common in some parts of Europe, and its bitter astringent root, and indeed the whole plant, were formerly used in medicine. It affords a beautiful bright yellow dye, almost as good as Saw-wort.—The name C. has its origin in an ancient legend concerning the cure of a centaur by one of the species.

CENTAURS ('bull-killers'), a wild race of men who inhabited, in early times, the forests and mountains of Thessaly, and whose chief occupation was bull-hunting. Homer, the first who mentions them, describes them merely as savage, gigantic, and

covered with hair. They do not appear as monsters, half-man and half-horse, until the age of Pindar. The C. are celebrated in Greek mythology on



Centaur.—From the Elgin Marbles.

account of their war with the *Lapithæ* (q. v.), and their contest with Hercules. The fact lying at the bottom of Pindar's myth may refer to the impression which the old bull-hunters of Thessaly, who spent almost their whole life, it is said, on horseback, first made on some of the neighbouring tribes—viz., that the man and the horse were one creature, which, at least, we know was the opinion entertained by the Mexicans of the Spanish cavalry. On account of their resemblance to the Satyrs, the C. were at a later period introduced into the artistic representations of the Bacchic worship.

CENTAURUS, the *Centaur*, one of the constellations in the southern hemisphere, represented on the celestial globe by a form half-man and half-horse. The stars in this constellation are, according to Ptolemy's catalogue, 37 in number; according to the Britannic catalogue, 35. It contains the stars α Centauri and β Centauri, both of the first magnitude.

CENTAURY (*Erythraea*), a genus of plants of the natural order *Gentianeæ*, having a funnel-shaped regular 5-partite corolla. The species are pretty little annuals, natives chiefly of the temperate parts of Europe and Asia, with pink or rose coloured flowers. They possess the tonic and other medicinal virtues of gentian, and although not frequently administered by physicians, are an important domestic medicine; and the tops are collected when the plant is in flower, by the country people both in England and on the continent of Europe, to be employed in cases of dyspepsia, in intermittent fevers, and as a vermifuge. They contain a substance called *Centaurine*, the hydrochlorate of which is said to be an excellent febrifuge.—The Common C.

(*E. Centaurium*) is the species most frequent in Britain; a plant of eight inches to a foot in height, with flowers collected in loose heads, growing in dry pastures. Two or three other species are found on sandy sea-shores. Nearly allied to these is the AMERICAN C. (*Sabbatia angularis*), an annual plant with an erect quadrangular stem, extensively distributed throughout the United States and Canada, and much used in the domestic practice of America, as a prophylactic against autumnal fevers, in strong infusions and large and repeated

doses. The name C. owes its origin to the same legend with the name *Centaurea*, although appropriated to plants so different.

CENTE'NES. See TENREC.

CENTERING, the framework upon which an arch or vault of stone, brick, or iron is supported during its construction. The simplest form of C. is that used by masons and bricklayers for the arches of common windows and doors. This is merely a deal-board of the required shape, upon the curved edge of which the bricks or stones of the arch are supported until they are keyed in. In building bridges or other structures where arches of great span are to be constructed, the C. is usually made of framed timbers, or timbers and iron combined. The arrangement of the timbers should be such, that the strain upon each shall be mainly a thrust in the direction of its length, for if the strain were transverse, a comparatively slight force would snap it, and if a longitudinal pull, the whole structure would be no stronger than the joints holding the pieces of timber together. In arches of great span, such as that of Waterloo Bridge, London, a longitudinal pulling strain is almost inevitable in some parts, as a beam of great length would bend to some extent under a thrusting strain. In such cases great skill and care are demanded in the designing and construction of the joints. As an arch is built from the piers towards the keystone, the weight upon the haunches during construction tends to push the crown upwards, and therefore the problem of designing a framed C. involves the resistance of this tendency, as well as the supporting of the weight of the materials.

The annexed figure of the C. of Waterloo Bridge, designed by Rennie, presents a fine example of the fulfilment of these requirements. It will be easily seen that a weight upon *np* and *ce* will be resisted by direct thrust upon the beams passing obliquely downwards from these parts; one of each pair of these oblique beams thrusts outwards, and is directly supported by the abutments; the other thrusts inwards towards *k*, the yielding of which is prevented by the longitudinal pull of the lower and longer oblique beams *kg*, *kr*, *kd*, *ka*, &c. In this, and other modern structures, cast-iron shoes

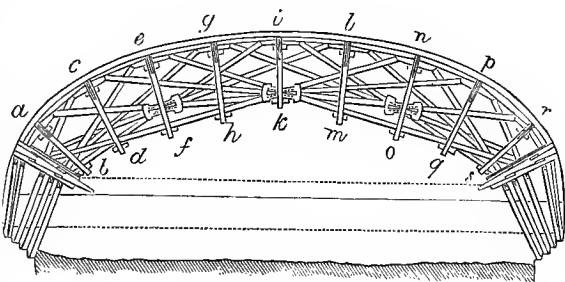

Centering of Waterloo Bridge.

have been successfully used for the tying joints subject to the longitudinal pulling strain. The flexible C., so called from its yielding at the joints, and varying its form with the load put upon it, is now abandoned. It was chiefly used by French engineers. That of Perronet for the bridge of Neuilly is a celebrated example.

Occasionally, when a very great span is required, and the navigation will permit, piers are built, or piles are driven, to support the C., and the design is much simplified thereby.

Cupolas like the Pantheon and St Peter's at Rome, St Paul's in London, or the flat domes of the Turkish mosques, require very effective centerings.

CENTIGRADE. See **THERMOMETER.**

CENTIPEDE (*Scolopendra*), a genus of *Myriapoda* (q. v.), having a long slender depressed body, protected by coriaceous plates, 21 pair of legs, distinct eyes, four on each side, and antennæ with 17 joints. The name is, however, popularly extended to species of nearly allied genera. Centipedes run nimbly, feed on insects, and pursue them into their lurking-places. They have not only a pair of horny jaws, like those of insects, but also another pair of organs closely connected with the mouth, and which are regarded as transformed legs, dilated and united at the base, terminated by a strong hook, and pierced beneath the extremity for the emission of a venomous fluid, which makes their bite quickly fatal to insects, and in the case of the larger species, very painful and even dangerous

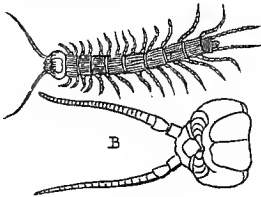

Centipede :
B, head, magnified.

to the larger animals and to man. The common C. of tropical America (*S. morsitans*) is often nine inches or a foot in length. A species found in the south of Europe (*S. cingulata*) is nearly as large, but its bite does not seem to be equally venomous. It may seem strange that creatures of such aspect as centipedes should ever have been thought of as human food, but Humboldt, in his Personal Narrative, tells us that he has seen Indian children of the tribe of the Chymnas draw large centipedes out of the earth and eat them.—The most common British C. is not a true *Scolopendra*, as that genus is now restricted, but is very nearly allied to it. It is known to naturalists as *Lithobius forficatus*. It is very plentiful under stones, &c., in summer. Another allied genus, *Geophilus*, of more numerous joints and slender form, contains some species which are occasionally phosphorescent, one of which, *G. longicornis*, yellow, with a rust-coloured head, is very abundant at the roots of turnips, &c. It is supposed, however, to be rather useful than injurious, preying on the destructive larvæ of insects.

CENTLIVRE, SUSANNA, an English dramatic authoress, was the daughter of a Lincolnshire gentleman, named Freeman, born (most probably) in Ireland, about 1680. Her early history is obscure; but such were her wit and beauty, that on her arrival in London, though a destitute orphan, and only 16 years of age, she won the heart of a nephew of Sir Stephen Fox, who, however, died shortly after their marriage. Her second husband, an officer named Carrol, lost his life in a duel. Left in extreme poverty, his widow endeavoured to support herself by writing for the stage, and after producing a tragedy called *The Perjured Husband* (performed first in 1700), made her appearance on the stage. She afterwards married (1706) Joseph Centlivre, principal cook to Queen Anne, with whom she lived happily until the time of her death, December 1, 1723. Her plays—*The Busibody* (of which the leading character, 'Marplot,' is highly amusing), *A Bold Stroke for a Wife* (1717), and *The*

Wonder (1714)—though not distinguished by purity of style or truthfulness of portraiture, are lively in their plots, and have kept their place on the stage.

CENTO (from Gr. *κεντῶν*, patchwork), a name applied to literary trivalities in the form of poems manufactured by putting together distinct verses or passages of one author, or of several authors, so as to make a new meaning. After the decay of genuine poetry among the Greeks, this worthless verse-manufacture came into vogue, as is proved by the *Homero-centones*, a patchwork of lines taken from Homer (edited by Teucher at Leipsic, 1793); but it was much more common among the Romans in the later times of the Empire, when Virgil was frequently abused in this fashion, as in the *C. Nuptialis* of Ausonius (who gives rules for the composition of the C.), and especially in the *C. Virgilianus*, constructed in the 4th c. by Proba Falconia, wife of the Proconsul Adelfius, and giving, in Virgil's misplaced words, an epitome of sacred history! The C. was a favourite recreation in the middle ages. In the 12th c., a monk named Metellus contrived to make a *cento* of spiritual hymns out of Horace and Virgil.

CENTO, a town of Central Italy, 16 miles north-west of Bologna, is pleasantly situated on a fertile plain near the Reno. It is celebrated as the birth-place of the famous painter Guercino, whose house, adorned with paintings, is still preserved; and in the church of C. are many of his works. Pop. about 5000.

CENTRAL FORCES are those which cause a moving body to tend towards some point of centre, called the centre of force or motion. The doctrine of C. F. has for its starting-point the first law of motion—viz., that a body not acted on by any external force will remain at rest, or move uniformly in a straight line. It follows from this law, that if a body in motion either changes its velocity or direction, some external force is acting upon it. The doctrine of C. F. considers the paths which bodies will describe round centres of force, and the varying velocity with which they will pass along in these paths. It investigates the law of the force round which a body describes a known curve, and solves the inverse problem, and many others, the general statement of which could convey no clear idea to the unmathematical reader. As gravity is a force which acts on all bodies from the earth's centre, it affords the simplest general illustration of the action of a central force. If a stone be slung from a string, gravity deflects it from the linear path which it would otherwise pursue, and makes it describe a curved line which we know would, in vacuo, be a parabola. Again, the moon is held in her orbit round the earth by the action of gravity, which is constantly preventing her from going off in the line of the tangent to her path at any instant, which she would do, according to the first law of motion, if not deflected therefrom by any external force. To that property of matter by which it maintains its state of rest or motion, unless acted upon by other matter, has been given the name *inertia*.

We will now explain how, through the action of a central force, a body is made to describe a curved path. Suppose it to have moved for a finite time, and conceive the time divided into very small equal parts; and instead of the central force acting constantly, conceive a series of sudden impulses to be given to the body in the direction of the centre, at the end of each of the equal intervals, and then observe what, on these suppositions, will happen. Let S (see fig. 1) be the centre, and let the original motion be from A, on the line AB, which does not

pass through S. In the first interval, the body will move with a uniform velocity, say from A to B. In the second, if acted on by no force, it would move

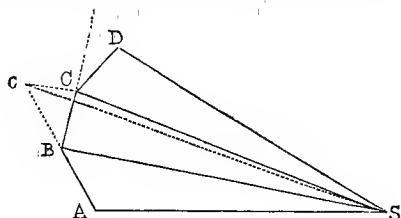

Fig. 1.

on in AB produced to c , Bc being = AB. But when it arrives at B, it receives the first sudden impulse towards S. By the composition of velocities (q. v.), it will move now with a new but still uniform velocity in BC instead of Bc, BC being the diagonal of the parallelogram of which the sides represent its impressed and original velocity. Having reached C at the end of the second interval, it receives the second impulse towards S. It will now move in CD instead of in BC produced. If, then, we suppose the periods of time to be indefinitely diminished in length, and increased in number, the broken line ABCD will become ultimately a continuous curve and the series of impulses a continuous force. This completes the explanation.

Going back, however, on our suppositions, we may here establish Newton's leading law of central forces. That the body must always move in the same plane, results from the absence of any force to remove it from the plane in which at any time it may be moving. The triangles ASB and BSC are clearly in the same plane, as the latter is on that in which lie the lines Bc and BS. Also, since the triangles ASB, BSc are equal, being on equal bases, AB, Bc, and triangle BSC = triangle BSc, as they are between the same parallels, cC and BS, it follows (by Euclid I. 37) that ASB = BSC. So BSC = CSC; and so on. In other words, the areas, described in equal times by the line (called the radius vector) joining the centre of force and the body, are equal. As this is true in the limit, we arrive, by the composition of the small equal areas, at the law: That the areas described by the lines drawn from the moving body to the fixed centre of force, are all in one plane, and proportional to the times of describing them. Very few of the laws of C. F. are capable of being proved like the preceding, without drawing largely on Newton's lemmas, with which we shall not suppose the reader to be acquainted.

Centrifugal and Centripetal Force.—We have shewn that a body continually drawn to a centre, if it has an original motion in a line that does not pass through the centre, will describe a curve. At each point in the curve, it tends, through its inertia, to recede from the curve, and proceed in the tangent to it at that point. It always tends to move in a straight line in the direction in which it may at

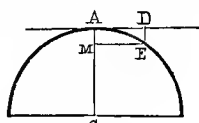

Fig. 2.

any time be moving, and that line, by the definitions of a tangent and of curvature, is the tangent to the curve at the point. At the point A (see fig. 2), it will endeavour to proceed in AD: if nothing hindered it, it would actually proceed in that line,

curve AE, to reach the point D, and thus recede the length DE from the curve; but being continually drawn out of its direction into a curve by a force to a centre, it falls below the point D by the distance DE. The force which draws it through this distance is called the centripetal force, and that which would make it recede in the same time through the distance DE from the curve is called the centrifugal force. It may be remarked that the centrifugal force is not, like the centripetal, an impressed or external force acting on the body. It is simply the assertion of the body's inertia under the circumstances produced by the centripetal force.

Many familiar illustrations will occur to the reader of the action of what is called the centrifugal force. A ball fastened to the end of a string, and whirled round, will, if the motion is made sufficiently rapid, at last break the string, and fly off. A glass of water may be whirled so rapidly that, even when the mouth is presented downwards, the water will still be retained in it, by the centrifugal force pressing it up against the bottom of the glass. The centrifugal action will be found to increase with the velocity. In all cases of a body moving in a circle, the force, it can be proved, varies as the square of the velocity of the body at the moment, and in the inverse ratio of the radius. As in this case the velocity varies as the radius inversely, it follows that the force is as the inverse cube of the radius. As in the case of circular motion the body always is at the same distance from the centre, it follows that the centrifugal and centripetal forces are equal at all points of a circular orbit. The general law for all orbits is, that the centrifugal force varies as the inverse cube of the distance from the centre. As the attractive force of gravitation varies as the inverse square of the distance, it may hence be shewn that the centrifugal force gives perfect security, notwithstanding the constant attraction of the sun, that the planets, so far as that attraction is concerned, will never fall into the sun.

The doctrine of C. F. owes more to Kepler and Sir Isaac Newton, of whose philosophy it makes a considerable branch, than to all the rest of the philosophers, though almost all the leading mathematicians have contributed to it. The doctrine of centrifugal forces was first mentioned by Huygens, at the end of his *Horologium Oscillatorium*, published in 1673; but Newton was the first who fully handled the doctrine, at least so far as regards the conic sections.

CENTRALISATION, a term which has lately come into general use for expressing a tendency to administer, by the sovereign or the central government, matters which had been previously under local management. We cannot properly use the term towards an established despotism, for there everything is already directed from the centre. The legitimate application is to a state of change from local to central management—a change in the opposite direction would, on the same principle, be called localisation. Of this latter change, however, it can scarcely be said that we have any recent example, unless it may be found in the systems of self-government lately communicated to some of the British colonies. Ever since the existing European states began to grow out of the chaos of the fall of the Roman empire, there has been a continued progress in centralisation. That empire itself was, however, the greatest instance of C. which the world has yet seen. In it the numerous municipalities and other local organisations originally existing in Italy, and communicated to the colonies, were entirely centralised. The empire, such as it had been in the days of Constantine, was the type after

so as, in the time in which it describes the arc of the

which the European monarchs, such of them especially as became more powerful than their neighbours, were ever striving; and a few of them, such as Charlemagne, and, long afterwards, Charles V., seemed to have almost restored it. In this country, we trace C. from the time when there were about a dozen kings in Britain, and perhaps as many in Ireland, till the united kingdom came under the rule of one monarch. A subsidiary C. at the same time made silent progress, absorbing the feudal power of the aristocracy and the municipal privileges of the corporations. In other countries—as, for instance, in France, notwithstanding her desperate struggles for freedom, this process of C. has tended to a pure irresponsible despotism. With so sad a result before their eyes, a distrust of C. has not unnaturally been felt by some inhabitants of Great Britain. But the British constitution possesses a grand remedy, which turns the process to good use instead of mischief. While administrative authority has been centralising in the crown, the controlling power of parliament has been increasing at a more rapid ratio, so that the vesting of a function in the crown or central government, means the putting it under the control of parliament, and especially of the peoples' representatives in the House of Commons. There is nothing done in any of the offices under the government for which a secretary of state, or some other member of the ministry, may not at any time be called to account in parliament. The efficiency of this control was in a manner proved by one or two instances in which offices with central powers were created, without being connected with any of the great state departments. There were, for instance, the English Poor-law Board, and the Board of Health. Both created much discontent and outcry about C., and it was found necessary to transfer their functions to the great government departments, the heads of which are immediately responsible to parliament. It is not the policy of this country in any case to abolish local management, but rather to aid and direct it from the central authority. The constituents of local bodies are often disinclined to watch or control them, and the business falls into the hands of incapable or designing men, or is otherwise mismanaged. A very little central help—especially from a quarter where the proceedings of other bodies of the same kind are known—remedies such defects. One of the methods in which the government has of late been in use to exercise its central power, has been by the appointment of inspectors, who make reports which are laid before parliament. This is, in reality, nothing more than a method of concentrating public opinion on the proceedings inspected and reported on, and as such it is very efficacious.

CENTRE OF GRAVITY is that point in a body or system of bodies rigidly connected, upon which the body or system acted upon only by the force of gravity, will balance itself in all positions. Though the action of gravity enters this definition, many of the properties of the point are independent of that force, and might be enunciated and proved without conceiving it to exist. By some, accordingly, the point has been called the *centre of magnitude*, and by others, the *centre of parallel forces*. Such a point exists in every body and system, and only one such point. Every body may be supposed to be made up of a multitude of minute particles connected by cohesion, and so far as its balance under gravity is concerned, each of these may be supposed to be removed, and its place occupied by a force proportioned to its weight. Instead of the body, on these suppositions, we should then have a system of parallel forces, the lines from the various particles to the earth's centre being regarded

as parallel. But a system of parallel forces (see PARALLEL FORCES) has a single resultant acting through a fixed point, whose position is independent of the position in space of the points of application of the component forces, provided their relative positions in the system continue unchanged. This point is the C. of G.; and if it be supported, it is clear that the body will balance itself upon it in all positions. The same reasoning obviously applies to any system of bodies rigidly connected. It is usual to demonstrate this and the general rule for finding the C. of G. by proving it first in the case of two heavy particles forming a body or system, and then extending the proof to the case of any number of particles. Let P and Q (see fig. 1) be two heavy particles. Join P and Q, and divide the line PQ in C, so that weight of P : weight of Q :: CQ : CP. Then C will be the C. of G. of P and Q. Draw ACB horizontal, and PM, QN vertical, meeting AB in M and N. Then if P and Q represent the weights of P and Q, we have P : Q :: CQ : CP. But CQ : CP :: CN : CM by similar triangles.

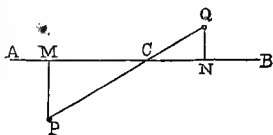

Fig. 1.

Therefore P : Q :: CN : CM, and P.CM = Q.CN. P and Q, therefore, are balanced about C. See BALANCE and LEVER. This is true in all positions of P and Q, for no assumption was made as to their positions. C, therefore, is their centre of gravity. Also, we may conceive P and Q to be removed (see PARALLEL FORCES), and in their stead a particle at C equal to them taken together in weight. If, now, the system contained three, it is clear how we should proceed to find its centre of gravity; having found the C. of G. of two, we should consider the system as formed of two—viz., the equivalent of the first two at their C. of G., and the third, when the case would fall under that already treated; and so on, extending the rule to a system containing any number of particles. Apart from this rule, however, it is possible, in the case of most regular homogeneous bodies, to fix upon their centres of gravity from general considerations. The C. of G. of a straight line, for instance, must clearly be in its middle point. So the C. of G. of a uniform homogeneous cylinder must be in the middle point of its axis. It must be in the axis, for the cylinder clearly is equally balanced about its axis. It must also be somewhere in its middle circular section, for it will balance itself on a knife-edge under that section. It must, therefore, be in the point where that section cuts the axis, or in the middle of the axis. The C. of G. of a uniform material plane triangle may be found from similar considerations. The triangle ABC (see fig. 2) may be supposed to be made up of uniform material lines parallel to its base AB; each of these will balance upon its middle point. The whole triangle, therefore, will balance upon the line CD, which bisects the base AB and all lines parallel to it. In the same way, the triangle will balance upon the line AE, bisecting BC. But if a figure balances itself upon a line, its C. of G. must lie in that line. The C. of G. of the triangle is therefore in CD, and also in CB. It must therefore be at g where these lines intersect, g being the

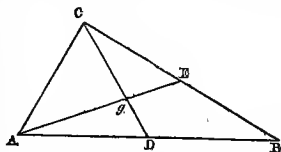

Fig. 2.

only point they have in common. Now, by geometry, we know that g divides CD , so that $Cg = \frac{2}{3} CD$. Hence the rule for finding the C. of G. of a triangle: Draw a line from the vertex, bisecting the base, and measure off Cg , two-thirds of the line. g is the centre of gravity. By a similar method, the C. of G. of a great number of figures may be determined.

The above method applies only where the figure of the body is regular, and its mass homogeneous. But many bodies, besides being irregular, are formed by the agglomeration of particles of different specific gravities. Of these, the C. of G. can be found only by experiment, though not always satisfactorily. Let the body be suspended by a string, and allowed to find its position of equilibrium. The equilibrium being due to the tension of the string counterbalancing gravity, it follows that the tension is in the same line with that on which gravity acts on the body. But the tension acts on the line of the string, which therefore passes through the centre of gravity. Mark its direction through the body. Suspending it then by another point, we should ascertain a second line in which lies the centre of gravity. The C. of G., then, must be where these lines intersect.—For the effect on the stability of bodies of the position of the C. of G., see STABILITY.

CENTRE OF GYRATION is the point at which, if the whole mass of a body rotating round an axis or point of suspension were collected, a given force applied would produce the same angular velocity as it would if applied at the same point to the body itself. The C. of G. bears a strong analogy to the centre of oscillation. The cases differ only in this, that in the latter the operating forces are supposed to act at every point of the moving body, while in the former there is only one force acting upon one point. The C. of G. is found by the following rule: Divide the moment of inertia of the rotating mass by the mass of the body, and extract the square root of the quotient. The result is the distance of the point from the axis of rotation. The moment of inertia, it may be stated, is the sum of the products of the weight of each point of the mass by the square of the perpendicular distance of that point from the axis.

CENTRE OF MAGNITUDE or **FIGURE** (see **CENTRE OF GRAVITY**). C. of M. is the point on which plane figures and curved surfaces would balance themselves, supposing their areas to have weight. Thus, the centre of a circle is its centre of magnitude. Otherwise, C. of M. or F. is a point so situated that all straight lines passing through it, and terminated by the circumference or superficies of the figure or surface are bisected in it.

CENTRE OF OSCILLATION. Referring to the article **PENDULUM**, the reader will see that the time of a pendulum's vibration increases with its length, being always proportioned to the square root of its length. This is strictly true only of the simple pendulum, in which the pendulous body is supposed to have no determinate magnitude, and to be connected with the point of suspension by an inflexible wire without weight. If, however, the vibrating body have a determinate magnitude, then the time of vibration will vary, not with the square root of its length, but with the square root of the distance from the axis of suspension of a point in the body called its centre of oscillation.

If each part of the vibrating body were separately connected with the axis of suspension by a fine thread, and entirely disconnected from the rest of the body, it would form an independent simple pendulum, and oscillate as such—the time of each vibration being as the square root of the length of its thread. It follows that those particles of the

body which are nearest to the axis of suspension would, as simple pendulums, vibrate more rapidly than those more remote. Being connected, however, as parts of the solid body, they vibrate all in the same time. But this connection does not affect their tendencies to vibrate as simple pendulums, and the motion of the body which they compose is a compromise of these tendencies of its particles. Those nearest the axis are retarded by the more remote, while the more remote are urged on by the nearer. Among these particles there is always one to be found in which the accelerating and retarding effects of the rest are mutually neutralised, and which vibrates in the same time as it would if it were unconnected with the other parts of the body, and simply connected by a fine thread to the axis of suspension. The point in the body occupied by this particle is its centre of oscillation. By this C. of O. the calculations respecting the vibration of a solid body are rendered as simple as those of a molecule of inconsiderable magnitude. All the properties which belong to a simple pendulum may be transferred to a vibrating body of any magnitude and figure, by considering it as equivalent to a single particle of matter vibrating at its centre of oscillation.

The determination of the position of the C. of O. of a body usually requires the aid of the calculus. It is always further from the axis of suspension than the centre of gravity is, and always in the line joining the centre of gravity and the point of suspension, when the body is suspended from a point. The rule for finding it in such a case is: If S be the point of suspension, and O the C. of O., $SO = \frac{\Sigma (ma^2)}{M.Sg}$; or it is the quotient obtained by dividing the moment of inertia of the body by the product of its mass into the distance of its centre of gravity from the point of suspension.

CENTRE OF PERCUSSION. The C. of P. of a body or a system of bodies revolving about a point or axis, is that point in it, which striking an immovable object, the whole mass shall not incline to either side, but rest, as it were, in equilibrio, without acting on the centre or axis of suspension. If the body be moving freely, then the C. of P. is that point in it at which its whole impetus is supposed to be concentrated. In this case, if the body struck with its C. of P. an immovable obstacle, and if it were perfectly rigid and inelastic, it would come to perfect repose; whereas, if it struck the obstacle with any other point, a rotatory motion would be produced in it. When the body is moving freely, and there is no rotatory motion, the C. of P. coincides with the centre of gravity. If the body be moving round a point or axis of suspension, the C. of P. coincides with the centre of oscillation. The more complicated case of a body rotating round an axis within it, would require, for its explanation, analytical formulæ which cannot conveniently be translated into ordinary language. There are many positions which the axis may have in which there will be no C. of P.—i. e., there will be no direction in which an impulse could be applied without producing a shock upon the axis. One case of this sort is that of the axis being a principal axis through the centre of gravity.

CENTRE OF PRESSURE. The C. of P. of any surface immersed in a fluid is the point in which the resultant of the pressures of the fluid on the several points meets the surface. When the bottom of a vessel containing fluid, or when a plane immersed in fluid, is horizontal, the pressure on every point of it is the same, being that due

to the weight of the column of fluid standing above the bottom or plane. In either case, the pressures at the different points obviously form a system of equal parallel forces, whose centre will be the centre of gravity of the bottom or plane, their resultant passing through this point being the sum of all their forces. But when the plane is inclined at any angle to the surface of the fluid, the pressure is not the same at all points, but is obviously greater at the lower than at the upper points, for the lower have to support taller columns of the fluid. The resultant of these forces, then, will not pass through the centre of gravity of the surface, but through a point below it. This point is the C. of P., and evidently will lie below the centre of gravity for all fluids in which the pressure increases with the depth. If the surface pressed upon form part of the containing vessel, and be supposed movable, it will be kept at rest by a pressure equal to the sum of the fluid pressures applied at the C. of P., and acting in the opposite direction. In the case of a vessel with a parallelogram for one side, the C. of P. is at the distance of one-third of the height from the bottom. In the case of a triangular vessel whose base is at the bottom, it is one-fourth of the height only.

CENTRIFUGAL AND CENTRIPETAL are terms used in Botany to designate two different kinds of inflorescence, or modes of flowering of plants. When the flower-bud which terminates the floral axis, and is central in the inflorescence, is the first to expand—in which case the others are developed in succession from the centre outwards—the inflorescence is said to be *centrifugal*. When the outermost flowers expand first, the inflorescence is *centripetal*, as is the case in catkins, spikes, and racemes, in which the flowers nearest the base are the first to expand, and those nearest the apex the last. These modes of inflorescence are very characteristic of different plants, of genera, and of orders.

CENTRIFUGAL FORCE. See **CENTRAL FORCES.**

CENTRIPETAL FORCE. See **CENTRAL FORCES.**

CEPHAËLIS. See **IPECACUANHA.**

CEPHALA'SPIS, a genus of fossil Ganoid fishes, of which six species have been described, two belonging to the Upper Silurian, and four to the Devonian measures. The head was protected by a large ganoid plate, sculptured externally with circular radiating markings. Agassiz gave the name C. (buckler-headed) from this extraordinary covering, which has very much the appearance of, and was formerly supposed to be, the cephalic shield of an *Asaphus*. The body was covered with rhomboidal enamelled scales, and furnished with dorsal and pectoral fins: it terminated in a large heterocercal tail. In a graphic description of this fossil in his *Old Red Sandstone*, Miller thus sketches the general appearance of the animal: 'Has the reader ever seen a saddler's cutting-knife—a tool with a crescent-shaped blade, and the handle fixed transversely in the centre of its concave side? In general outline, the C. resembled this tool; the crescent-shaped blade representing the head, the transverse handle the body.' The endo-skeleton was cartilaginous, retaining the notochord through life. The flexible body, assisted by the large tail and the fins, would give the C. the power of moving rapidly through the water. Being a predaceous fish, it must have been a formidable enemy to its associates in the Palaeozoic seas, for, besides its power of rapid motion, the sharp margin of its shield probably did the work of a vigorously hurled javelin, as in the sword-fish. This genus was originally named

Asterolepis (star-scale), from the circular markings on its cephalic shield.

CEPHALONIA, or **CEFALONIA**, the largest of the seven Ionian Islands (q. v.), is situated at the entrance of the Gulf of Lepanto or Corinth, in lat. 38° 3'—38° 30' N., and long. 20° 21'—20° 49' E. It is irregular in shape. Its greatest length is about 30 miles, and its total area 348 square miles. Its surface is mountainous, the soil, for the most part thin, and water very scarce. The inhabitants, however, are industrious and enterprising, and have planted vineyards wherever the grape will grow, and currants and olive-oil are also produced for export. The climate is warm and agreeable. The population in 1858 amounted to 72,534. The numbers who are brought up to the medical profession are remarkable; it is said that there is hardly a town in the Levant which has not a practitioner from Cephalonia. The inhabitants are also much more disposed to engage in foreign trade than their brethren of Corfu or Zante, and own more vessels. The island is subject to frequent, but slight earthquakes. There is always a small English garrison kept at C., and steamers ply weekly between it and Malta and Greece (Patras). The language spoken is a Greek dialect. The chief towns are Argostoli (q. v.) and Lixuri.

C. is called by Homer Same or Samos, and during the heroic ages was subject to Ulysses, whose residence was in the neighbouring isle of Ithaca (q. v.). Later, C. appears under the name of Cephallenia. It successively fell into the hands of the Athenians, Romans, Byzantines, and Venetians, from the last of whom it was several times wrested by the Turks. On the ruin of the Venetian Republic in 1797, it was seized by the French, who were in their turn dislodged by the Russians. In 1809, it finally came into the possession of England.

CEPHALOPODA (Gr. head-footed), a class of mollusks, the highest in organisation of that division of the animal kingdom. To this class belong the Nautili, Spirulae, Argonauts, Poulpes, Squids or Calamaries, Cuttle-fish, &c., of the present time, and the Ammonites, Belemnites, &c., of former geological periods. The C. are all marine, and only a few of them are capable of leaving the water, and moving about in search of food on the shore.

The C. receive their name from having organs of prehension and locomotion attached to the head, an arrangement towards which a gradual approach may be traced in the highest gasteropod (q. v.) mollusks. These organs have been variously designated *arms*, *feet*, and *tentacula*. They 'have no true homology' with the limbs of vertebrate animals, but are only analogous to them in respect of the purposes which they serve.—The body of the C. is a bag, formed of the *mantle* (see **MOLLUSCA**), open only at the end to which the head is attached. In some, this bag is almost spherical, and locomotion is accomplished only by the appendages of the head; in others, the body is elongated, and furnished with two fin-like expansions, which are the principal instruments of locomotion. In locomotion by the fins, a cephalopod swims like a fish, with the head first, and often very rapidly; in locomotion by the arms, it drags itself along, laying hold of any object within reach by means of suckers, with which the arms are furnished. Some C. are capable also of moving backwards through the water by alternate contractions and expansions of a muscular web which unites the bases of the arms; some appear to depend for a similar power of swimming backwards upon the forcible ejection of water from the cavity which contains the gills.

CEPHALOPODA.

The head of a cephalopod is roundish, generally furnished with two large and prominent eyes, very similar in structure to those of vertebrate animals. There are also ears, but they consist merely of little cavities, one on each side of the brain, in each of which is suspended a membranous sac containing a small stone. The organs of smell are not very certainly known, but it appears that the C. possess this sense, as well as that of taste, of which the character of the tongue is much more indicative than in many vertebrate animals.—The brain forms a ring around the gullet. The whole nervous system

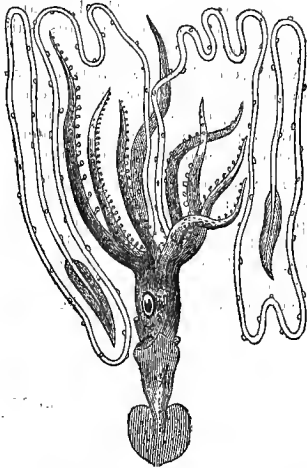

Cephalopoda Lologopsis.

is more complex than in the lower mollusks.—The mouth opens in the midst of the circle of arms. It is furnished with a strong horny beak of two mandibles, moving vertically, not unlike the bill of a parrot, but the upper mandible the shorter of the two.—The digestive apparatus is very complicated. The gullet swells out into a crop, and there is a gizzard as muscular as that of a bird. The intestine, after a few convolutions, terminates in the cavity which contains the gills, at the base of the funnel by which the water is ejected after having supplied air for respiration. This cavity is situated within the mantle or bag, and separated from the other viscera by a membranous partition. Into it the water is freely admitted by means of a slit or valvular opening, being drawn in by muscular action, and again expelled with considerable force through the funnel, which opens at the neck, and with its current all secretions, eggs, and excrements are carried forth. There are only two gills in the greater number of existing C., the only exceptions being the two or three known species of *Nautilus*, which have four gills; and two-gilled C.—the order *Dibranchiata*—are in many respects of higher organisation than the four-gilled—the order *Tetrabranchiata*—which, although containing so few recent, contains a vast number of fossil species. Each gill consists of many membranous plates, fixed to two sides of a stalk.—The heart in the *Tetrabranchiata* consists of a single ventricle only; but besides this systemic heart, the *Dibranchiata* have two branchial or respiratory hearts, contractile reservoirs, one for each gill, by which the blood is forced into these organs.

The 'arms' or 'feet' are very numerous in the *Tetrabranchiata*, not provided with suckers, but hollow, and with long retractile tentacula; in

the *Dibranchiata* they are only eight or ten in number, furnished with suckers (*acetabula*); two of them, when they are ten in number, being much longer than the rest, and differing from them in form. The suckers are very admirably constructed—an adhesive disk of muscular membrane, often having a cartilaginous circlet, capable of most exact application to any object, with an aperture in the centre leading into a cavity, the bottom of which can be retracted like a piston so as to form a vacuum, and render the adhesion of the sucker close and firm, whilst on the muscular action being interrupted or reversed, it immediately lets go its hold. The Poulpe has each of its eight flexible arms crowded with 120 pair of such suckers, and as an animal of this kind exists on some tropical shores, with arms about two feet long, it is not wonderful that it is reckoned dangerous. Still more formidable, however, are the Hook-squids of the South Seas, the two long arms of which have suckers furnished in the centre with a hook to enter into the flesh of any creature of which they may lay hold, and so more effectually to secure their prey.

The sexes are distinct in all the cephalopoda. The eggs have a horny covering, and after their extrusion from the parent, become agglutinated into masses of various forms. The young, from the first, very much resemble the mature animals except in size.

All the *Dibranchiata* are provided with a peculiar organ of defence, called an 'ink-bag,' which is wanting in the *Tetrabranchiata*. This ink-bag is filled with a peculiar secretion, capable of being expelled at will to darken the water, and facilitate the escape of the cephalopod.

The *Tetrabranchiate* C. have a chambered shell. See NAUTILUS. The *Dibranchiate* C. have no external shell—the shell of the female Argonaut (q. v.) being scarcely an exception—but they have an internal shell (cuttle-fish bone, &c.), sometimes merely rudimentary, included between two folds of the mantle, and apparently intended to give support to the soft body of the animal.

The C. are all very voracious, feeding on fish, mollusks, crustaceans, &c. Even a powerful crab is not safe from the attacks of a *Dibranchiate* cephalopod little bigger than itself; the arms, so abundantly provided with suckers, seize it, and trammel every movement, whilst the parrot-like beak is strong enough to break the hard shell. Cuttle-fish and squids are often very troublesome to fishermen, following shoals of fish, and devouring great numbers of them after they are entangled in the net.

Fossil C. exist in all the strata which form the earth's crust. The order *Tetrabranchiata* is almost exclusively a fossil order, being represented by not more than four recent species. With the exception of two genera, *Nautilus* and *Aturia*, this order is confined to primary and secondary rocks. The two groups into which it is divided are also characteristic of geological epochs. The *Nautilidae*, with simple or gently undulating septa, and siphuncle central or in the inner margin, belong, with the exception of the two genera just referred

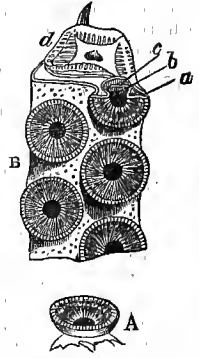

Cephalopoda, suckers of :
A, a single sucker, side view :
B, a portion of one of the
tentacula, with several
suckers, front view; a,
cartilaginous circlet; b,
central cavity; c, piston;
d, section of the tentacle.

to, to the Paleozoic rocks. Including a small group, which, while it has the siphon on the external margin, has yet simple septa, the *Nautilidae* are represented by 145 Silurian, 158 Devonian, and 91 Carboniferous species. The *Ammonitidae* have the siphuncle always on the outer margin of the shell, and the septa with corrugated or lobed margins. This group, with the exception of *Goniatites*, a Palæozoic genus, is peculiar to, and co-extensive with, the secondary strata. Of the 930 species that have been described, more than the half belong to the genus *Ammonites* (q. v.).

The order *Dibranchiata* is, found first in the Lias, and extends through the more recent strata, receiving its full development in our present seas. Scarcely 90 fossil species have been described, while more than double that number are known as recent animals. See AMMONITES, ARGOONAUT, BELEMNITES, CALAMARY, CUTTLE-FISH, GONIAITES, HAMITES, HOOK-SQUID, NAUTILUS, ORTHOCERAS, POULPE, SPIRULA, &c.

CEPHALOPTERA (Gr. head-wing), a genus of cartilaginous fishes of the ray family, the type of a sub-family, *Cephalopteridae*. The pectoral fins are very much elongated, so as to give great breadth to the fish. The tail is slender and without fin, but armed near its origin with a great spine. The head is terminated in front by a straight line, and on each side of it there projects a membrane (*precephalic fin*) rolled upon itself, and resembling in shape a pointed horn. The name **HORNED RAY** has therefore sometimes been given to these creatures, of which only one species, *C. Giorna*, has ever been found on the British coasts. It is not uncommon in the Mediterranean, and there acquires a great size: one is mentioned as having been taken off Messina, which weighed 1250 lbs.—more than half a ton. But this is small in comparison with the size of some of the *Cephalopteridae* which occur in tropical seas: one taken at Barbadoes required seven yoke of oxen to draw it. They are very dangerous to swimmers and bathers.

CEPHEUS, a constellation of the northern hemisphere, containing, according to the Britannic catalogue, 35 stars. Its principal star is Alderamin, of the third magnitude.

CEPOLA. See **BANDFISH**.

CERAM, a long and narrow island of the Asiatic Archipelago, running nearly 200 miles in the parallel of about 3° S., long 128—131° E., between Booro on the W., and Papua or New Guinea on the E. With an area of nearly 6000 square miles, it has about 27,000 inhabitants. From east to west it is traversed by mountains rising at some points 8000 feet above the sea. While the high grounds yield abundance of fine timber, the valleys are fertile in tropical productions. The natives, chiefly negroes of the Papuan type, excel in the manufacture of arms. The Dutch claim the sovereignty, and hold several establishments on the coast.

CERAMBYX, a Linnæan genus of coleopterous insects, included among those which, on account of the length of their antennæ, are usually known as **LONG-HORNED BEETLES**, and now generally regarded as the type of a tribe or family. To this tribe belongs the Musk Beetle of England (*Callichroma moschata*), remarkable for its strong and agreeable odour, which, however, is rather that of roses than of musk. Some foreign species have the odour of musk in great perfection. *C. heros*, one of the largest European beetles, extremely rare in Britain, deposits its eggs in a hole which it excavates for that purpose in the wood of the oak; and the grub feeds upon the wood, excavating long passages through it.

CERAMIA'CEÆ, a sub-order of *Algae* (q. v.), also called **FLORIDÆ**, and consisting of sea-weeds of a rose or purplish colour, with fronds formed of cells arranged in rows, sometimes in a single row; the *sporocarps* containing cells or *spores*, often in fours (*tetraspores*), with a transparent *perispore*, and enclosed in receptacles of very various form and structure. They are most abundant in the seas of the northern temperate zone. Many of them are very delicate and beautiful. A considerable number furnish agreeable articles of food of a gelatinous nature, as **DULSE** (q. v.), **CARRAGEEN** (q. v.) or **IRISH MOSS**, and certain species of **FLOCIARIA** (q. v.), which are much used on the sea-coasts of the East Indies. The edible swallows' nests of the East are supposed to be formed of a sea-weed of this sub-order, a species of *Gelidium*.

CERAMIC (Gr. *keramos*, potter's clay, from *kairo*, to burn, and *era*, earth), a term used to designate the department of plastic art which comprises all objects made of clay, such as vases, cups, bassi-rilievi, cornices, and the like.

CERASTES, or **HORNED VIPER**, a genus of serpents of the family *Viperidae*, distinguished by a broad depressed heart-shaped head, the scales of which are similar to those of the back, and particularly remarkable for the development of one of the scales of each eyelid into a spine or horn, often of considerable length. The tail is very

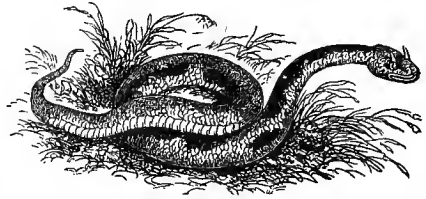

Horned Viper (*Cerastes vulgaris*).

distinct from the body. This genus is exclusively African, and very venomous. The best known species, *C. vulgaris*, the Horned Viper of the north of Africa, was called *C.* by the ancients, the name being derived from the Greek *keras*, a horn. It was correctly described by the traveller Bruce, but his description was for some time regarded with incredulity. Other species of the same genus are *C. nasicornis* of the western coast of Africa, and *C. caudalis* of the Cape of Good Hope.

CERATE (Lat. *cera*, wax), a compound of wax with other oily and medicinal substances in such proportions as to have the consistence of an Ointment (q. v.). Simple *C.* is made by melting together equal parts of white wax and olive-oil; they are to be heated together, and carefully stirred into a uniform substance while cooling.

CERATITES, a genus of Ammonitidae, peculiar to, and characteristic of, the Trias. They are distinguished from the other members of the family by having the lobes of the sutures serrated, while the intervening curves, directed towards the aperture, are simple. Twenty-six species have been described.

CERBERUS (Gr. *kerberos*), in Greek mythology, was the name of the many-headed dog—the offspring (according to Hesiod) of Typhon and Echidna—who guarded the portal of the infernal regions. Later writers describe *C.* as only three-headed, with the tail and mane composed of serpents, though the poets sometimes encumber him with a hundred heads.—A northern constellation,

near the hand of Hercules, was named Cerberus, by Hevelius.

CERCA'RIA, a name formerly given to a supposed genus of *Entozoa*, at first, from their minute size, mistaken for *Infusoria*, but now known to be the young of *Trematode Worms*. In the form to which the name *C.* was given, these creatures consist of an oval body with a thread-like tail; and swim about with great activity in water, but exhibit a strong instinctive propensity to penetrate into the soft bodies of insect larvæ, which they do by means of a spine-like weapon projecting from

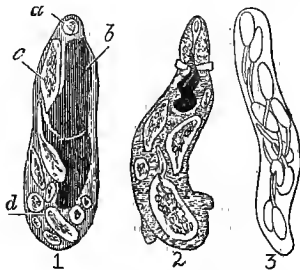

Cercaria Sacs :

1. A sac two lines long; *a*, oral cavity; *b*, alimentary canal; *c*, a cercaria developed within the sac; *d*, sporula not yet developed into cercaria.
2. The sac of a different species remarkable for its abdominal processes.
3. Another species, more simple in form and structure.

their head. The tail, as no longer needed, is now left behind, the closing of the wound through which the *C.* enters apparently nipping it off. Within the body which it enters, the *C.* loses also its spine, becomes encysted, and awaits its passive migration into an animal of higher kind, there to become a trematode worm. When it does not succeed in finding, in due time, a larva into which to enter, the *C.* gathers itself up into a ball; emits a mucous secretion, which soon hardens; and incessantly turning round within this mucous mass, becomes invested with a sort of shell, in which form it is not unlikely to be swallowed by some vertebrate animal. The *C.* is not the immediate offspring of a parent like itself. It is generated in a curious little animated sac (see figure, taken from Von Siebold's work on Tape and Cystic Worms), which is to be found buried among the organs of fresh-water mollusks, and within which this development of young takes place by gemmation. See **GENERATIONS, ALTERNATION OF.**

CERCELÉE, or **RECERCELÉE**, in Heraldry, is a cross circling, or curling at the ends, like a ram's horn.

CERCIS. See **JUDAS' TREE.**

CERCOCEBUS (Gr. tail-ape), a genus of monkeys, natives of Asia and Africa, included by some naturalists in the large genus *Cercopithecus*. These monkeys have large cheek-pouches, large callosities, and long tails. The species commonly called **MANGABEYS**, or **WHITE EYELID MONKEYS**, are commonly referred to this genus, besides the **CALLITHRIX**, or **GREEN MONKEY**, and the **MALBROUK**, or **DOG-TAILED BABOON**.

CERCOPITHECUS (Gr. tail-ape), a genus of monkeys, containing a large number of species, natives of Asia and Africa, but chiefly of Africa. They are called *Guenons* by French naturalists, but they have no common English name more distinctive than **Monkey**. They have cheek-pouches and callosities, and a long but not prehensile tail. A **MONA**, or **VARIED MONKEY** (*C. Mona*)—an African

species—in the Parisian menagerie, was remarkable not only for the cunning and adroitness with which it searched and rifled the pockets of visitors, but also for the readiness with which it applied a key to the opening of a lock, untied knots, undid the rings of a chain, and performed other similar feats.

CERDO'CYON (Gr. cunning-dog), a genus of *Canidae*, apparently intermediate between true dogs and foxes, natives of South America. They are sometimes called **Aguara Foxes**. Their aspect is thoroughly vulpine, as are also their manners. Some of them add to the dispositions of ordinary foxes a singular propensity to steal and secrete brilliant or gaudy objects. A Brazilian species has been known to carry pocket-handkerchiefs into the woods. Some are natives of the coldest parts of South America, and have a rich fur.

CERE. See **BILL.**

CERE'A, a town of Lombardy, about 19 miles south-south-east of Verona. It is a straggling place, with the remains of an old castle, and a population of 6000.

CEREA'LIA, or **CE'REAL GRASSES**, so named from *Ceres* (q. v.), are the plants which produce grain or corn; in other words, all the species of grass (*Graminæ*) cultivated for the sake of their seed as an article of food. They are also called **CORN-PLANTS** or **BREAD-PLANTS**. They do not belong to any particular tribes of the great order of grasses, but differ from each other botanically, perhaps as much as any plants within the limits of that order. The seeds of the grasses in general being indeed farinaceous and wholesome, the employment of particular species as bread-plants seems to have been determined chiefly by the superior size of the seed, or by the facility of procuring it in sufficient quantity, and of freeing it from its unedible envelopes. Some of the grains, as wheat and barley, are produced in ears or close-set spikes; some, as a few of those called millet, in spike-like panicles; others, as oats and rice, in very loose panicles. The form and size of the grains vary not a little, some being roundish, and some elongated; maize is the largest; many of the millets are very small. The plants themselves vary in size almost as much as their seeds, the millets being the smallest, and maize the largest of ordinary corn-plants.—Buckwheat and Spurry are sometimes ranked with the *C.*, but incorrectly, if the term is regarded as having any botanical limits, for they are not grasses; but their seeds are used in the same way. The Quinoa of South America, and the Kiery (*Amaranthus*) of India, with other plants of different orders, might be added to the list on the same account; even the Lotus of the Nile, the *Victoria regia*, and other species of water-lilies might thus be reckoned as cereal plants. The most extensively cultivated grains are Wheat (*Triticum*), Barley (*Hordeum*), Rye (*Secale*), Oats (*Avena*), Rice (*Oryza*), Maize or Indian Corn (*Zea*), different kinds of Millet (*Setaria*, *Panicum*, *Paspalum*, *Pennisetum*, and *Penicillaria*), and Durra or Guinea Corn (*Sorghum* or *Andropogon*). These have all been cultivated from time immemorial, and there is great uncertainty as to the number of species to which the many existing varieties belong; their original forms and native countries cannot confidently be determined. Barley, oats, and rye are the grains of the coldest regions, the cultivation of the two former extending even within the arctic circle. Wheat is next to these, and in the warmer regions of the temperate zone its cultivation is associated with that of maize and rice, which are extensively cultivated within the tropics. The millets belong to warm climates, and durra is tropical or sub-tropical. Rice is the food of a greater number of the human race than any other kind of grain.

CEREBELLUM—CEREBRUM.

Maize has the greatest range of temperature.— Besides these, other grasses are cultivated to some extent, in different parts of the world, for the grain they yield: a species of *Eleusine* (Mand) in India, and another (Toccusso) in Abyssinia; a species of *Poa* (Teff) in Abyssinia, and a species of *Coix* (Job's Tears) in India. Canary Grass (*Phalaris*) may also be named. Canadian Rice (*Zizania*) is used as a grain, but is scarcely cultivated, and the same remark applies to the Manna Grass (*Glyceria*) of the north of Europe, to some species of Bamboo (*Bambusa*), and to the Sea Lyme Grass (*Elymus*), which affords an esteemed article of food, in small quantity, to the inhabitants of Iceland.

Of all the C., wheat is by common consent admitted to be that of which the grain is best fitted for the making of bread, although others are to some extent employed for this purpose. But some, as rice and maize, are scarcely suited for it, and other methods are chiefly employed of preparing them for food. All the grains are also used to produce some kind of fermented liquor or beer, and spirituous liquors are obtained from them by distillation.

CEREBELLUM. See CEREBRUM.

CEREBRINE, or **CEREBRIC ACID**, is an organic acid of very complex composition, found in the liver, blood, and nerves, but especially the brain of animals.

CEREBRO-SPINAL FLUID. There is an interval, termed the *Sub-arachnoid Space*, lying between the two innermost of the membranes of the brain and spinal cord—viz., the arachnoid and the pia mater. This space, which is narrow on the surface of the cerebral hemispheres, but is comparatively wide at the base of the brain between the two middle lobes of the cerebrum, and, posteriorly, between the hemispheres of the cerebellum and the medulla oblongata, is occupied by the C. F., which fills up the interval between the arachnoid and pia mater, and keeps the opposed surfaces of the former membrane (which is a closed serous sac) in contact. The C. F. is a clear, limpid, slightly albuminous fluid, having a saltish taste, and a faintly alkaline reaction, and not containing more than 1.5 per cent. of solid matters. It varies in quantity from two to ten ounces, and is said to be most abundant in aged persons. Its chief use is to afford mechanical protection to the nervous centres, and to prevent the effects of external shocks or concussions.

CEREBRUM, CEREBELLUM. Cerebrum (Lat. the brain) is sometimes applied to the whole contents of the cranium or skull; but more usually it denotes the upper portion, while the under and posterior portion is called the CEREBELLUM, or little brain. In this article we shall briefly notice the chief results which have as yet been obtained regarding the uses of the various parts of the mass, referring to the article BRAIN for the necessary anatomical details.

The *crura cerebri* appear as the principal conductors of impressions to and from the cerebrum. When one is divided, the animal moves round and round, from the injured towards the sound side, as if from a partial paralysis of the latter side. The effect may be referred to the interruption of the voluntary impulses from the C., for although the cerebellum seems to have the office of combining the muscles, whose co-operation is necessary for each action, the effort of the will must proceed from the cerebrum.

The *corpora quadrigemina* are, as stated in the article BRAIN, 'analogues of the optic ganglia of the lower animals.' Their removal wholly destroys the power of seeing, and diseases by which they are seriously affected are usually accompanied with

blindness. Disease or destruction of one *corpus quad.* produces blindness of the opposite eye. Probably their connection with vision is not their only function.

The *optic thalami* probably participate slightly in the visual function of the *corpora quadrigemina*; but we have no definite evidence on this point. They are intimately connected with the power of movement. Destruction of one of them causes rotation of the animal, similarly to division of one of the *crura cerebri*. Longet has shewn, that after removing all the cerebral hemispheres and the *corpora striata*, the animal can still stand and walk, but that on removing one of the *optic thalami*, it falls down paralysed on the opposite side, or commences rotatory motion.

The function of the *corpora striata* is very uncertain; they have probably some connection with sensation and volition, the precise nature of which is at present unknown.

The parts hitherto considered—including the cerebellum—appear to comprise the apparatus (1.) For the direction and government of all the unfelt and involuntary movements of the parts which they supply; (2.) For the perception of sensations; and (3.) For the direction of such instinctive and habitual movements as do not require the exercise of any reasoning or intellectual act. They cannot be regarded as organs of the higher faculties of the mind.

The functions of the *cerebral hemispheres* are, in the words of Dr Kirkes (*Handbook of Physiology*), those of organs by which the mind, 1st, perceives those clear and more impressive sensations which it can retain and judge according to; 2d, performs those acts of will, each of which requires a deliberate, however quick, determination; 3d, retains impressions of sensible things, and reproduces them in subjective sensations and ideas; 4th, manifests itself in its higher and peculiarly human emotions and feelings, and in its faculties of judgment, understanding, memory, reflection, induction, and imagination, and others of the like class.

The evidences that the cerebral hemispheres are, in the sense and degree indicated above, the organs of the mind, are chiefly these: 1. That any severe injury of them, such as a general concussion, or sudden pressure by apoplexy, may instantly deprive a man of all power of manifesting externally any mental faculty; 2. That in the same general proportion as the higher mental faculties are developed in the vertebrate animals, and in man at different ages, the more is the size of the cerebral hemispheres developed in comparison with the rest of the cerebro-spinal system; 3. That no other part of the nervous system bears a corresponding proportion to the development of the mental faculties; 4. That congenital and other morbid defects of the cerebral hemispheres are, in general, accompanied with corresponding deficiency in the range or power of the intellectual faculties and the higher instincts.' See MIND, THE HUMAN.

Cerebellum.—The functions of this organ have been made the subject of much discussion and investigation. It is itself insensible to irritation, and has been cut away in various animals (by Longet and other French physiologists), without eliciting signs of pain; moreover its removal or disorganisation by disease is generally unaccompanied with loss or disorder of sensibility, animals from whom it has been removed being apparently able to smell, see, hear, and feel, as perfectly as before. Flourens seems by his vivisections to have arrived at the correct view regarding the functions of this organ, and his results have been fully confirmed by Longet and others. He extirpated the C. in birds by successive layers. Feebleness and want of harmony

of the movements resulted from the removal of the superficial layers; when he reached the middle layers, the animals became restless; their movements were violent and irregular; but they were not convulsed, and their sight and hearing were perfect. By the time that the organ was entirely removed, the animals had completely lost the power of flying, walking, standing, and preserving their equilibrium. When a pigeon in this state was laid upon its back, it could not recover its former position; but fluttered its wings, and saw and tried to avoid a threatened blow. Hence volition, sensation, and memory were not lost, but merely the faculty of combining the actions of the muscles. From a large series of experiments of this kind, subsequently made on all classes of animals, Flourens infers that the C. belongs neither to the sensitive nor to the intellectual apparatus; and that it is not the source of voluntary movements, although it belongs to the motor apparatus; but that it is the organ for the co-ordination of the voluntary movements, or for the excitement of the combined and harmonious action of the muscles.

This view is confirmed by the phenomena observed in certain cases of disease, and to a certain extent by comparative anatomy, for to each of the four classes of vertebrata—if we reckon amphibians and reptiles as a single class—the species whose natural movements require the most rapid and exact combinations of muscular actions are those in which the C. is most developed in proportion to the spinal cord; and if we compare different species of the same class, we usually find the development of the C. to correspond very closely with the perfection and variety of the muscular movements. For example, in the frog the movements are exceedingly simple in character, consisting of little else than flexion and extension of the posterior limbs; and the C. of this animal is extremely small compared with the rest of the brain, being merely a thin narrow band of nervous matter. In the common sea-turtles, the movements of the body are of a more varied character, and the motions of the head and neck are more extensive; and here we have a much more highly developed cerebellum. In the alligator, again, a reptile whose motions closely resemble those of quadrupeds, the C. is still more fully developed.

The influence of each half of the C. is directed to the muscles of the opposite side of the body, and for the right ordering of the movements, the actions of its two halves must be mutually balanced and adjusted; for if the nervous structures uniting one of the halves of the C. with the medulla oblongata and spinal cord be divided, strangely disordered movements occur, the animal falling down on the side opposite to that which has been injured, and continually rotating round the long axis of its body, sometimes for several days, at the rate of fifty or sixty times in a minute. Similar movements have been observed in men, in whom one of the crura of the C. has been diseased.

Phrenologists are of opinion, in accordance with the view originally propounded by Gall, that the C. is the seat of the sexual impulse and instincts; but this view has been long abandoned by almost all physiologists, for the reason that it has not been found to be sufficiently supported by anatomical and experimental facts, many of which are indeed directly opposed to it.

Our limited space compels us to leave altogether untouched many most interesting topics in Cerebral Physiology, as, for instance, the duality of the brain, the plurality of the cerebral organs, &c. The reader who wishes for further information, is referred to Kirkes's *Physiology* (from which we have freely

quoted), Carpenter's *Human Physiology*, Noble On the *Brain*, Holland's *Chapters on Mental Physiology*, and Brodie's *Psychological Inquiries*.

CEREMONY (Fr. *cérémonie*; Lat. *cærimonia*, a sacred rite). Almost any act, when performed in a regular, orderly, and formal manner, and when viewed, not with reference to its object, but the mode of its performance, becomes a C.; and the more entirely the attention of the performers is withdrawn from the object of the act, and fixed upon the manner of its performance, the more *ceremonious* does it become. The purely formal character of C. is thus illustrated by Hooker: 'The name ceremony,' he says, 'we do not use in so large a meaning as to bring sacraments within the compass and reach thereof, although things belonging to the outward form and seemly administration of them are contained in that name.' The remark is applicable to the most trivial ceremonies of social life and of state pageantry, as well as to the most sacred rites of religion, for a C. which is its own object would scarcely be entitled to be regarded even as a ceremony. The most empty display has always the ulterior object of imposing on somebody.

Ceremonies may be divided into four classes: 1. Religious ceremonies; 2. Social ceremonies; 3. State ceremonies; 4. International ceremonies.

Religious and state ceremonies will be treated of respectively under their various denominations; see, for the first, RITES, LITURGY, MASS, PROCESSIONS, &c.; and for the second, CORONATION, COURT, PRESENTATION AT COURT, OPENING OF PARLIAMENT, &c. Social C. will in a great measure fall under the heads, ETIQUETTE, PRECEDENCY, COURTESY, FORMS OF ADDRESS, &c.; and international C. under DIPLOMACY, CONSUL, AMBASSADOR, &c.

CEREO'PSIS (Gr. wax-face), a genus of birds of the family *Anatidae*, to which the New Holland goose (*C. Nova Hollandiæ*) belongs. This bird has been known since the southern shores of that country were first visited by navigators. There, and on the adjacent islands, it is found in great abundance; and the earlier navigators easily supplied themselves with fresh provisions by knocking them down with sticks, so little were they acquainted with the danger to be apprehended from man. The cere is remarkably large, whence the name.

CER'ÈS, among the Greeks named *Dēmèter*, daughter of *Chronos* (Saturn), by *Rhea* (Ops), sister of Jupiter, Neptune, Juno, &c. She had the misfortune, along with her other brothers and sister, to be devoured by her father, who, however, vomited her forth again after taking the emetic which Metis gave him. By her brother Jupiter she became the mother of Persephone or Proserpina (q. v.). The chief myth relating to C. tells how her daughter Proserpina was stolen by Pluto, and how the mother wandered far in quest of the maiden. After travelling in human form nine days, and everywhere distributing her gifts to mankind, she excited the pity of Jupiter, by whom Mercury was despatched to bring back Proserpina from the infernal world, but on the condition that she must spend there a third part (or, as others say, one-half) of every year. The myth of C. was symbolical of the growth of grain; some consider that this is intimated in the name Demeter, which is thought to be equivalent to *ge meter*, 'Mother Earth.' The relations of the worship of C. with agriculture, social order, &c., were expressed in her two great festivals—the *Eleusinia* (q. v.) and *Thesmophoria* (q. v.). C. was especially worshipped in Crete, Delos, Sicily, Asia Minor, Arcadia, Argolis, and Attica. Bulls, cows, pigs, honey-cakes, and fruits

were offered to her. Among the Romans, her festivals were styled *CEREALIA*; and of these, the most interesting was the feast celebrated by the rural population shortly before harvest, when the country people, dressed in white, and crowned with oak-leaves, danced and sang harvest-songs in honour of the goddess. The feast in April lasted several days, and was celebrated by games of the circus. C. was represented, most commonly, in a chariot drawn by dragons, having her head crowned with a garland of corn-ears, and holding a torch, a basket, or a poppy in her hand.

CERES, one of the Planetoids (q. v.), and the first of them that was discovered. It was first seen by Piazzi at Palermo, January 1, 1801. He continued to observe its motion till the 13th of February, when illness obliged him to discontinue his observations, which, however, sufficed to enable astronomers approximately to calculate its orbit. It was nearly a year after before it again became visible, owing to its approach to the sun. C.'s magnitude is less than that of the moon; and it looks like a star between the seventh and eighth magnitudes.

CEREUS, a genus of plants of the natural order *Cactaceæ* (q. v.), containing about 100 known species, among which are some of the most splendid flowers of that order. One of these is *C. speciosissimus*, now one of the most common green-house plants in Britain, and sometimes cultivated even in windows. Its large flowers are of a fine scarlet colour, the inner petals with a violet tinge: they spring singly from the younger branches. The fruit, when well ripened, is of a delicious flavour. The plant is a native of Mexico.

CERIGNOLA, a town of Naples, in the province of Capitanata, 23 miles south-east of Foggia. It is divided into two parts—the old and new town, in the former of which a portion of the ancient walls still remain—and is celebrated for the decisive victory obtained over the French by the Spaniards in 1503, and which established the supremacy of Spain in Naples. C. has manufactures of linen, and a trade in cotton and fruits. Pop. between 10,000 and 11,000.

CERIGO, one of the smaller of the seven Ionian Islands, was anciently called Cythera; is situated in the Mediterranean, and is separated from the coast of Morea by a narrow strait; lat. 36° 28' N., long. 23° E. It has an area of about 120 square miles, with a population of 13,000. With the exception of a few tracts of land, it is a very barren, dry, and mountainous island. In some parts, however, corn, wine, and olive-oil are raised. There are two great caverns in the island—one in the sea-cliff at the termination of the wild glen of Milopotamos; the other, known by the name of the Cavern of St Sophia, from a small chapel at its mouth dedicated to this saint, is situated at about one and a half hour's ride from Capsali (q. v.), the capital of the island. The former cavern is said to be three miles in length, and so low that it is necessary to creep, in many places, on hands and knees to explore it. The latter—that of St Sophia—is a very remarkable one, and possesses singular beauty; it abounds in enormous stalactites of various shapes and great beauty. In ancient times, C. was sacred to Venus, being, according to the old mythology, the island that received this goddess when she arose from the sea.

CERINTHUS (abusively named *MERINTHUS*, i. e., a halter), a heretic who lived at the close of the apostolic age, but of whom we have nothing better than uncertain and confused accounts. It is said that he was a Jew by birth, and studied philosophy in Alexandria. From Egypt he passed

into Asia Minor, and lived in Ephesus contemporaneously (according to the belief of the church) with the aged apostle John. Tradition tells us that John held the heretic in such detestation, that, on a certain occasion, when he encountered C. in the baths of Ephesus, he immediately left the place, saying to those about him: 'Let us flee home, lest the bath should fall while Cerinthus is within.' It was believed in the ancient church, that the Gospel by St John was written in opposition to the tenets of C.; and the Roman presbyter Caius (about the close of the 2d c.) supposed that C. had revenged himself by falsely ascribing the authorship of the Apocalypse to St John—it being in reality his own work! The Fathers contradict one another in their accounts of Cerinthus. Some describe him as a complete Gnostic, in which case he would be the earliest recorded teacher of that sect; others say that he held coarse and sensual millenarian views, making the *millennium* (q. v.), with the licentious fancy of an Arab, consist chiefly in 'nuptial delights;' and that he believed the Jewish ceremonial law to be in part binding upon Christians. There can be no doubt that C. made use of the Jewish law at least as a symbol for his Gnostic doctrines, and also employed millenarian terms in a symbolical manner; a very natural thing for him to do, on the hypothesis which Neander and others have suggested—that Gnosticism originated, not among the minds which had received a true Hellenic culture, but among the Judaizing sects, whose theosophy was a jumble of the spiritual and the material. C. being the oldest teacher of Judaic-Gnostic principles, there would naturally be a greater incongruity and want of harmony in his language and ideas than characterised Gnosticism at a later period of its development; and subsequent ecclesiastical writers, destitute as all of them were of precise historical knowledge and sound principles of criticism, could hardly avoid misunderstanding a system which is not consistent throughout, but bears evident marks of being formed in a transition epoch.—Paulus, *Historia Cerinthi* (Jena, 1799); Neander, *Kirchengeschichte*, vol. i., part 2.

CERITE, or **OCHRÖITE**, is the *Silicate of Cerium*. It is found as a mineral in gneiss, at Westmånland, Redderhyttan, and Bastnäs. It contains in 100 parts—silica, 16; peroxide of cerium, 26.55; oxide of lanthanum, 33.38; carbonic acid, 4.62; alumina, 1.68; peroxide of iron, 3.53; lime, 3.56; oxide of manganese, 0.27; and water, 9.1. It occurs in granular pieces of a clove-brown, cherry-red, or gray colour, with a white streak, a splintery fracture, an adamantine lustre, and is translucent at the edges.

CERITHIUM, a genus and the type of a family, *Cerithiadae*, of gasteropodous mollusca of the order *Pectinibranchiata* of Cuvier. The shell is spiral, elongated, and many-whirled, with an oval oblique aperture which has a short canal in front. The species of this family are numerous, most of them marine, but many inhabiting estuaries and brackish rather than salt water; some are found in lakes and rivers. A few belong to temperate climates, but most of them are tropical, and in mangrove swamps they particularly abound. The fossil species are very numerous, almost all limited to the tertiary formations. See *BACSHOT BEDS*.

CERIUM is a rare metal found native in Cerite (q. v.) and a few other minerals. It is a white metal, has not been obtained in any quantity, is not therefore employed in any manufacture, and forms two oxides and a numerous class of salts.

CEROPLASTIC (Lat. *cera*, wax), the art of modelling in wax. See *WAX-WORK*.

CEROSTROTUM, or **CESTROTUM** (Lat.), a species of encaustic painting upon horn or ivory, the lines of the design being burned in with the *cestrum* or burning needle, and wax introduced in the furrows thus made.

CEROXYLON. See **WAX PALM**.

CERRETO, a town of Naples, in the province of Terra di Lavoro, situated on a slope of the Apennines, about 22 miles north-east of Capua. It is a well-built town, with a cathedral, and manufactures of coarse cloth. The district produces good wine. Pop. 6000.

CERRO GO' RDA, the name of several localities of Spanish America.—1. A plateau in Mexico, the most easterly on the route from Vera Cruz to the capital. Here, on 18th April 1847, the Americans totally defeated the Mexicans.—2. A city of Peru, the capital of the province of Pasco, in the department of Junin. It is in the vicinity of the richest silver-mines in the republic; and standing at an elevation of 14,100 feet, it has, all the year round, the temperature of an English winter. The estimates of the population range from 7000 to 16,000. C. G. is 140 miles to the north-east of Lima.

CERTALDO, a town of Tuscany, Northern Italy, is picturesquely situated on the Elsa, about 18 miles south-west of Florence. It is noteworthy as the residence of Boccaccio, as well as the scene of his death. His house, surmounted with a tower, is still standing, and contains the articles of furniture belonging to the poet's time, and a fresco painting of him by Benvenuto Cellini. Pop. 2100.

CERTHIADÆ, a family of birds, generally placed in the great order *Insectores* or *Passerina*, and tribe *Tenuirostres*, although some naturalists have ranked them in the order *Scansores*. They mostly live on the trunks and branches of trees, feeding on insects which they find in the crevices of the bark; and many of them aid themselves by their stiff tail-feathers in retaining their position as they search for their food on the perpendicular stem. Their claws are long and sharp; the hind-toe is also elongated, so that they can take firm hold of the bark or of a small branch; and many of them can pass round a horizontal branch, clinging to its under-surface with their backs to the ground. The bill of many is slender and curved; others, however, have a comparatively short and straight bill. The tongue is cartilaginous at the extremity, and so fitted to aid in seizing insect prey. The plumage is usually dull and uniform; but the birds are lively and active in their habits. The species are numerous and widely diffused; they are divided into a number of genera. All of them are small birds. The Creepers (q. v.), forming the genus *Certhia*, are regarded as exhibiting the type of the family. Wrens and Nut-hatches, although referred to it, depart very considerably from this type. Many small tropical and subtropical birds, which live by sucking honey from flowers, formerly referred to this family, are now separated from it.

CERTIFICATE, a written testimony to the truth of a certain fact or facts. The law of England recognises certificates for various purposes. 1. Annual C. of attorneys. See **ATTORNEY**. 2. C. of appointment of the creditors' assignees to a bankrupt's estate and effects. 3. C. of conformity of a bankrupt. 4. C. of counsel, to enable a pauper to litigate *in forma pauperis*. 5. C. of the judges of the superior common-law courts at Westminster, which are of various kinds and for various purposes. 6. C. of registry of a ship; which is a copy of what is entered in the register of the ship in the books of the Custom-house. This C. is granted by the collector, comptroller, or principal officer of

the Customs at the port of registry, and delivered to the captain as a voucher of the character and privileges of the vessel as a British ship.

CERTIFICATION, in the law of Scotland, signifies the judicial assurance given to a party of the course to be followed by the judge in case he disobeys the will of a summons, or other writ or order of the court. Reiterated contumacy on the part of the defender was at one time punished with confiscation of his property (1449, c. 29), but now C. amounts to nothing beyond an intimation that if he fails to appear in the usual manner, the judge will decern, or pronounce judgment against him. The most important C. is in the process of Reduction-improbation (q. v.). In this action, two terms are allowed for the production of the deed called for, and sought to be reduced. Thereafter, an additional ten days are given; but should production not be satisfied on their expiry, decree of C. will be pronounced, and this decree has the effect of declaring the deed to be forged and fabricated. Such a decree, even though pronounced in absence, can hardly be recalled. In simple reduction (see **REDUCTION**), the C. is only to the effect that the deed shall be void and null, till produced.

CERTIFIED COPY. See **EVIDENCE**.

CERTIORARI (Lat. to be certiorated, or more fully and accurately informed of), in English law, is an original writ issuing, in civil cases, out of the common-law jurisdiction of the Court of Chancery, and in criminal, from the criminal side of the Court of Queen's Bench. This writ, which runs in the Queen's name, is addressed to judges or officers of an inferior court, commanding them to certify or to return the records of a cause depending before them, in order that the party may obtain more sure and speedy justice, from such justices as shall be assigned to determine the cause. A writ of C. may be granted at the instance either of the prosecutor or defender; but, to prevent its being used as an instrument of oppression by the one party against the other, it is provided (5 and 6 Will. IV. c. 33, and 16 and 17 Vict. c. 30) that either party, before applying for it, must obtain the leave of the court, and enter into recognisances.

The writ passes on a *Bill of C.*, which states the proceedings in the inferior court, so far as they have gone; sets forth the alleged ground of incompetency, by suggesting that the cause is beyond the jurisdiction of the court, that the defendant or witnesses live beyond it, or the like reason why substantial justice cannot be done; and then prays the writ to certify and remove the cause into the superior court. When the bill is filed, the writ of C. is obtained on motion.

CERTOSA DI PAVIA, LA, one of the most celebrated monasteries in the world, is situated in the neighbourhood of Pavia, and was founded, 1396, by Giovanni Galeazzo Visconti, first Duke of Milan, to appease his conscience for the murder of his uncle. The church is a splendid structure in the form of a Latin cross, the ground-plan being 249 feet long by 173 feet broad. It has altogether 12 chapels, 7 in the whole length of the church, and 5 in the transept, some of which are decorated with fine frescoes and paintings. The richly sculptured façade, designed by Ambrogio da Fossano, named Borgognone, was commenced in 1473. The building is made up of various styles, but the pointed prevails in the interior, which is decorated with frescoes, paintings, &c., by Dan Crespi, Andrea Solari, Campi, and Ambrogio Fossano, and contains a gorgeous high-altar, the mausoleum of the founder, and several monuments.

CERUMEN. This term is applied to yellow waxy matter which is secreted by certain glands lying in the external auditory canal, or the passage that leads from the external opening of the ear to the membrane of the tympanum. Its main use, doubtless, is to lubricate this passage. It possesses a peculiarly bitter taste, and some physiologists have believed that in consequence of this property it prevents insects from entering the auditory canal. It is popularly known as ear-wax.

CERUSE, or WHITE-LEAD, the basis of white oil-paint, is a *carbonate of lead*. It has several other names—krems, Nottingham white, flake-white, &c. Like all other preparations of lead, C. is liable to be acted upon by exhalations from sewers, or by anything which contains sulphuretted hydrogen, in which case it is changed to a dull and leaden hue. Neither will it bear to be mixed with any pigment containing sulphur, such as vermilion. It is supposed that the white oxide of zinc might be substituted for C. as a white pigment with advantage.

CERVANTES SAAVEDRA, MIGUEL DE, one of the greatest imaginative writers of Spain, was born of an old Galician family, at Alcalá de Henares, October 9, 1547. He studied at Salamanca, and afterwards at Madrid, where he was placed under the care of a learned theologian, Juan Lopez de Hoyos, who was then professor of belles-lettres in the university. But his natural love of poetry led him to spend most of his time in writing elegies, ballads, sonnets, and a pastoral romance entitled *Filena*. When 22 years old, C. served for some time as valet-de-chambre to Cardinal Giulio Aquaviva of Rome. In 1570 he served as a volunteer under the command of the papal admiral, Marco Antonio Colonna, and fought gallantly against the Turks. At the battle of Lepanto, he was maimed for life by a gunshot wound in the left hand. He afterwards took part in various campaigns. Captured by an Algerine squadron, he was made a slave, but was ransomed in 1580, after a four years' captivity. On his return to Spain, he rejoined his regiment in the army sent by Philip II. to support his claims in Portugal, and distinguished himself in the expedition to the Azores. In 1584, he returned to Spain, and retired into private life, to devote his attention to literature. Soon after his publication of the pastoral romance, *Galatea* (1584), he married, commenced writing for the stage, and produced, in the course of a few years, as many as thirty dramatic pieces, of which the tragedy *Numancia* is the most remarkable. During the years 1588—1599 he lived in straitened circumstances in Seville. In 1605 he once more appeared as an author, and now in a sphere exactly suited to his genius. In his immortal work, *Don Quixote*, C. intended to put an end to that taste for extravagant romances of chivalry which had so long prevailed. The first part of this great satirical work appeared in Madrid, and was received at first coolly, but soon afterwards with loud applause, which, at a later period, was echoed from all parts of educated Europe. *Don Quixote*, though written with a satirical purpose, is throughout pervaded by the true spirit of poetry. With that universality which belongs to the highest genius, C. connected a universal human interest with descriptions of local and temporary characteristics. He did not intend by his *Don Quixote* to burlesque the old Spanish knight-errantry, for, as Mr Ford remarks (see *Handbook of Spain*, part i., p. 238), 'the thing had expired a century before his birth;' but to put an end to the absurd and affected romances which it was then the fashion to read, and which were believed to be

true pictures of chivalry. He had also, it is quite clear, another object in view—viz., to shew that the deeper and truer and more guileless a nature is, the more will it become the jest and butt of real life; but he likewise teaches us that the pure heart and the high soul obtain a triumph which misfortunes and blunders cannot tarnish; for the knight, always 'disinterested, generous, elevated, and beneficent,' though 'the sweet bells of his intellect are jangled and out of tune,' maintains throughout a firm hold on our affections and esteem. Charles Lamb has truly said, that readers who see nothing more than a burlesque in *Don Quixote*, have but a shallow appreciation of the work.

Though received with enthusiasm, *Don Quixote* brought no pecuniary reward to the author. He was left in the obscurity and poverty in which he had passed so many years, and vainly endeavoured to improve his circumstances. After silence during several years, C. published his twelve *Novelas Ejemplares* (Exemplary Tales), 1613; his *Viage al Parnaso* (Journey to Parnassus), 1614—his next best production to *Don Quixote*; and in the following year he produced eight new dramas, but these were indifferently received. In 1614, a certain Alonso Fernandez de Avellaneda published at Tarragona, in 1614, a so-called continuation of *Don Quixote*, which was made a vehicle of abuse lavished on Cervantes. It appears that C. suffered considerably under these despicable attacks; but he revenged himself in noble style by publishing (1615) the true continuation of *Don Quixote*. Near the close of his career, C. found a patron in the Count of Lemos, who relieved his poverty. During the last few years of his life, he resided in Madrid, where he died, April 23, 1616. No stone marks the spot where his remains were interred. His novel, *The Sorrows of Persiles and Sigismunda*, was posthumously published. In 1835, when the house in which the poet had lived in Madrid was rebuilt, a bust of C., by the sculptor Don Antonio Solá, was placed in the front.

Among the several editions of *Don Quixote*, we may mention the splendid one in 4 vols. (Madrid, 1780); that by Pellicer (5 vols., Madrid, 1798); the fourth published by the Madrid Academy, with an admirable life of C. by Navarrete (5 vols., Madrid, 1819); Diego Clemencin's edition, with the most complete commentary (6 vols., Madrid, 1833—1839); and a good pocket-edition, published at Leipsic (6 vols., 1800—1807). Of the collected works of C., an edition, not containing the comedies, appeared at Madrid (16 vols., 1803—1805); and another, without the *Journey to Parnassus*, was published in the same city (11 vols., 1829). Don Aug. Garcia de Arrieta published a selection from the works of C. (10 vols., Paris, 1826—1832); and a reprint of the collected works is included in Baudry's *Coleccion de los Mejores Autores Españoles* (Paris, 1840—1841). England has been fertile in translations of C.'s immortal work. The first is that of Thomas Skelton (1612—1620), in addition to which may be mentioned those of Philips, Motteux, Smollett, Duffey, Jarvis, and Wilmot. The two best are those of Skelton and Jarvis.

CERVERA, a town of Spain, in the province of Lérida, 28 miles east of the city of that name. It is situated on an eminence, is surrounded by old walls pierced with nine gates, and the west approach is commanded by a castle, which is now in a ruinous condition. The university of Lérida was removed here by Philip V., but it was afterwards transferred to Barcelona. The university building, a massive but unsightly edifice, is still standing. C. has manufactures of linen, woollen, and cotton fabrics. Pop. 5300.

CERVETERÉ, or **CERVETRI**, (ancient Cære or Agylla), a town of Central Italy, 27 miles west of Rome. Though now a place of some 700 or 800 inhabitants, it was formerly one of the most important cities of Etruria, possessing, it is said, a famous collection of paintings before even Rome was founded. Many Etruscan remains of value have been found here.

CERVIA, a town of Central Italy, situated on the Adriatic, 13 miles south-south-east of Ravenna. It is regularly built, has a cathedral and several convents; and from a marsh in the neighbourhood about 50,000 tons of salt are annually obtained, the salt-works employing a considerable number of the population, which is about 5000.

CERVIDÆ AND **CERVUS**. See **DEER**.

CERVIN, **MONT** (Ger. *Matterhorn*; Ital. *Monte Silvio*), a mountain of the Pennine Alps, about 40 miles east-north-east of Mont Blanc, and between the Valais in Switzerland and the Val d'Aosta in Piedmont. Above an unbroken glacier line of 11,000 feet high, it rises in an inaccessible obelisk of rock, more than 3000 feet higher—and is described by the late Professor Forbes as the most striking natural object he had ever seen. The total elevation of the mountain is 14,836 feet. The Col of Mont C., used as a passage for horses and mules in summer, has an elevation of 10,938 feet.

CERVINARA, a town of Naples, in the province of Principato Ultra, 12 miles north-west of Avellino. It has a convent and several churches, and a trade in the produce of the district. Pop. 6000.

CESARI, **GIUSEPPE** (sometimes called **GIUSEPPINO**, or **IL CAVALIERE D'ARFINO**), an Italian painter, was born at Rome, 1570, and died there in 1640 (or 1642). He was greatly honoured by no less than five popes, and his paintings were always highly popular. His works—in fresco and oil—display lively imagination, gay colouring, and great tact in execution; but are deficient in natural simplicity, correctness of design, symmetry of arrangement, and dignity of style. As he was the most brilliant of the mannerists, he was the chief object of the attacks made by the artistic reformers, Caravaggio, the Caracci, and their followers—who constituted the *naturalisti*—on the conventional or pseudo-idealistic style of painting.

CESAROTTI, **MELCHIORE**, an excellent Italian poet, was born at Padua, 15th May 1730, and died 3d November 1808. He gained a reputation by the vigour and originality of his style, especially in his translation of Macpherson's *Ossian* (2 vols., Padua, 1763). The versification of this work, like that of C.'s free translation of the *Iliad*, under the title of *La Morte di Ettore*, was admired by Alfieri. C. unquestionably threw fresh life into Italian literature, but few in this country will consider his enthusiasm very rational, when it could induce him to think poor Macpherson a better poet than Homer. C.'s best work was his *Saggio sulla Filosofia delle Lingue* (Padua, 1785), written in opposition to the academical pedantry of La Crusca. His prose style is vigorous, but full of innovations, especially Gallicisms.

CESENA, a town of Central Italy, about 12 miles south-east of Forlì, on the Emilian Way. It is pleasantly situated on a hill-slope, washed by the Savio. Its principal buildings are the *Palazzo Pubblico*, the Capuchin church, and the library founded by Domenico Malatesta Novello, in 1452, with a rich collection of MSS. There are many monasteries and nunneries, as befits a place that gave birth to two popes—Pius VI. and VII. It has some silk factories, with a trade in wine and silk;

and in the vicinity are productive sulphur-mines. Pop. about 10,000.

CESS, probably a corruption for *asses*, from the Ital. *assessare*, to impose a tax. It has long been used in England as synonymous with the more modern noun *assessment*. Camden, in the time of Elizabeth, speaks of every man being 'cessed by the pole, man by man, according to the valuation of their goods and lands.' See **LAND-TAX**.

CESSIO BONORUM (Lat. *cession* or *surrender* of goods), a process which the law of Scotland has borrowed from that of Rome, and which, like many others, is common to it with most of the continental systems. A C. B. may be defined to be an equitable relief from the severity of the earlier laws of imprisonment for debt, granted to a debtor in consideration of a cession of his goods to his creditors. The jurisdiction in *cessio* formerly belonged exclusively to the Court of Session, but by 6 and 7 Will. IV. c. 56, it was extended to sheriffs. The principal regulations, with reference to this process, at present in force, are the following: Any debtor in prison, or who has been in prison, or even against whom a warrant of imprisonment has been issued, may apply for a *Cessio Bonorum*. In his petition, he sets forth his inability to pay his debts, and his willingness to surrender his estates, and prays for interim protection. This petition must be intimated in the *Gazette*. The bankrupt then lodges with the sheriff-clerk a state of his affairs, subscribed by himself, with all the relative books and papers. On a day appointed for the purpose, he is examined before the sheriff on oath; and if his creditors object to the petition, they are heard, and a proof, if necessary, allowed them. Whatever order the sheriff may pronounce is subject to review by the Court of Session, or a Lord Ordinary in vacation. *Cessio* originating in the Court of Session are sued out in the form of a summons, by which all the creditors are called as defenders to the action. Any one or more of them may appear; and the pursuer will not be allowed the benefit of the process, till he has satisfied the court that his insolvency has arisen from misfortune, and that his disclosure of the state of his affairs is full and honest. The burden of proving objections to his statements, and to the evidence which he may produce, will be laid on the creditors. If the debtor can find caution (q. v.) to attend all diets when called on, the sheriff or the Court of Session may grant him liberation or protection whilst the process is pending. A decree of C. B. operates as an assignation of the debtor's movable estate in favour of a trustee for behoof of the creditors. These trustees, like those in sequestrations, are now placed under the supervision of the Accountant in Bankruptcy. A C. B. differs from a Sequestration (q. v.) in this, that it confers no power on the bankrupt to insist on his discharge, and affords no protection against the attachment of his subsequent acquisitions by his creditors. The debtor has the privilege of retaining his working tools; but nothing beyond what is necessary for mere aliment will be allowed, even to half-pay officers and clergymen.

CESTIUS, **PYRAMID** OF, a Roman monument of the Augustan age, situated close to the Porta San Paolo, partly without and partly within the walls of Aurelian. It is known to every English traveller, being in the immediate vicinity of the cemetery where Protestants dying in Rome are buried. The exterior form is perfectly preserved; but of the paintings which formerly decorated the internal walls, only a few traces remain. Several copies of these paintings have been made, of which we may mention those edited by Falconieri, 1661. The

CESTIUS—CESTOID WORMS.

pyramid is 125 feet high, 100 feet in width at the base; the walls 25 feet thick. It is built of brick and tufa, faced with slabs of Carrara marble, now perfectly black with age, and rests on a base of travertine 3 feet high. The interior contains burial-chambers of considerable extent. The inner walls are covered with hard stucco, and the roof is vaulted. Both the walls and the roof were covered with paintings of female figures. The memory of the Caius Cestius for whom this pyramid was built has perished, but it has been supposed that he was the Cestius whom Cicero—in the oration *pro Flacco*—mentions as a rich man of business, who, having no children, left a large sum of money for the erection of a monument to himself. Two fluted columns of white marble, now standing before the pyramid of C., with their bases and two other bases, were discovered in the excavations of 1663, at the foot of the pyramid. In the cemetery, the remains of several celebrated men have their resting-place, among whom are the poets Keats and Shelley, Wyatt the sculptor, and Bell the anatomist.

CESTOID WORMS (Lat. *cestus*, a band or thong), a family of *Entozoa*, or intestinal worms, of the order *Colelmintha* (q. v.), consisting of tape-worms and other creatures which resemble them in structure and habits. The number of different kinds of C. W. is great. Their natural history is important in reference to the health of human beings and of the most valuable domesticated animals; and although the subject is not in all respects an agreeable one, it presents much that is interesting and wonderful. Recent discoveries have given it an entirely new character.

C. W., in their most perfect state, when alone they possess the form from which their name is derived, are in reality compound animals, like many zoophytes and ascidians. They do not, however, like these, subsist by food entering the system through mouths with which the individuals composing it are furnished; for the joints of a cestoid worm, the individuals composing the system or 'colony,' have no mouth; nor is there any mouth in what is, on various accounts, quite properly regarded as the head, but nutriment is obtained from the surrounding medium by *endosmose* (q. v.); nourishing juices entering everywhere through the skin, as in the spongioles of the roots of plants, into the cellular tissue or *parenchyma* of which the whole body consists. The head of a cestoid worm is furnished with organs—different in different kinds—by which it affixes itself to the inner surface of the intestine of a vertebrate animal. When first it gets into this situation, the body is very short, and has no joints; but they soon begin to appear as transverse striæ, and gradually increasing in size, become in most of the kinds very distinct, and at last separate from the system in which they were produced, and are carried away out of the intestines of the animal which contained them. This does not take place, however, till they have not only become mature in the development of the sexual organs—the principal organs to be observed in them—but until they are full of what are called eggs, which, indeed, are rather young ones ready for a separate existence, and each enveloped in a sort of protective shell. Each joint of a cestoid worm is androgynous. Whilst the most matured joints are thrown off from the posterior end, new joints are continually formed, as at first, in the part nearest to the head. The number of joints thus formed from a single individual is very great, as will appear when it is considered that tape-worms have been found 20 feet long or upwards, and that these have probably been throwing off joints in large numbers before opportunity has been obtained of measuring them.

As the C. W. have no mouth, so they have no alimentary canal. Some of them, as the true tape-worms, have been supposed to imbibe nourishment by the sucking disks of the head; but these are more probably mere organs of attachment, and the canals which are seen to arise behind them, apparently belong, not to the digestive, but to the vascular system, and are united by transverse vessels or vascular rings in the head and in each of the segments. The only trace of a nervous system hitherto observed is a single ganglion in the head, which in some is seen to send off nerves to the suckers.

The division into segments remains imperfect in some cestoid worms. Those of the genus *Ligula*—chiefly found in birds and fishes—resemble a long flat ribbon, not even notched along the edge, and containing a mere series of hermaphrodite brood-places. When segmentation is perfect, the segments (*proglottides*), on separating from the parent system

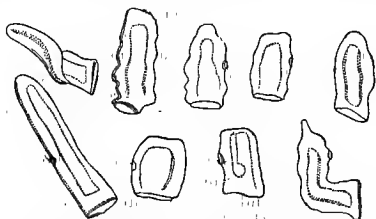

Segments (*Proglottides*) of Common Tape-worm :
In different States of Expansion and Contraction.
(From Von Siebold's work on Tape-worms.)

(*strobila*), possess life and a little power of independent motion, creeping away on moist ground, plants, &c. Their period of separate existence, however, is brief; they burst or decay, and the numerous minute embryos which they contain are ready to commence their career, if in any way transferred into the stomach of an animal of proper kind, which is generally different from that whose intestine their parent inhabited. This may happen by their being swallowed—or even the *proglottis* itself—along with water, grass, &c. Some of the C. W. in this embryonic state find their appropriate place in the stomachs of vertebrate, and others in those of invertebrate animals.

The shell being broken or digested, the young cestoid worm is set free. It is extremely unlike the proglottis by which it was generated. It presents the appearance of a vesicle furnished with a few microscopic hooks. It possesses, however, a power of active migration by means of these hooks, and is able to perforate the stomach of the animal which contains it. To this its instinct seems immediately to prompt it, and it is so minute that it passes through the stomach without any serious inconvenience to the animal. It now probably gets into the blood, and is lodged in some of the capillaries, from which it makes its way again by perforation, until it finds a suitable place in some of the tissues or of the serous cavities, in the flesh, or in such organs as the liver or the brain; and here relinquishing all active migration, it rapidly increases in size, at the same time developing a head, which is in fact that of a cestoid worm, and generally either encysts itself or is encysted—enclosed in a cyst (q. v.)—according to circumstances, or according to its species. Great numbers of such parasites are sometimes present in a single animal, causing disease and even death. Until recently, they were regarded by naturalists as constituting species and genera

quite distinct from the C. W., of which they are really the young; and the name *scolex*, formerly given to one of these supposed genera, has now become a common name for the young of all C. W. in this stage, as *larva* is the common name for the young of insects in their first stage after being hatched from the egg. Those scolices which inhabit vertebrate animals very generally become distended with a watery fluid, and in this state were formerly regarded as Hydatids (q. v.); little else, indeed, appearing without very careful examination, but a small bag filled with fluid, the scolex head being formed within the bag, although capable of being everted from it, as the finger of a glove which has been drawn in at the end is turned out. Such is the young of the common tape-worm (*Tenia solium*),

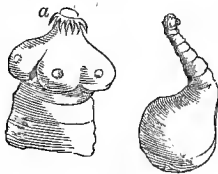

Cysticercus Cellulosa
(magnified):
a, the head, much magnified.

formerly known to naturalists as *Cysticercus cellulosa*, and found in the flesh of the pig and of some other animals, and sometimes of man. It is this scolex, existing in great numbers, which produces in the pig the diseased state commonly known as *measly*; and it is very unsafe even to handle measly pork in a raw state, because a scolex accidentally getting into the mouth, and thence into the stomach, is likely to become a formidable inmate of the intestinal canal. It does not appear that this particular species has the power of multiplying in its scolex state, or the circumstances in which it exists in the flesh of the pig may be unfavourable to its so doing, and, the prodigious numbers sometimes existing in a single animal have probably all entered by the mouth in the way already described, the contents of a single proglottis or joint of a tape-worm being perhaps sufficient to account for them; but some scolices, as that called *Cenurus cerebralis*, found in the brain of sheep, and the cause of the disease called *staggers*—now known to be the scolex of a *Tenia* of the dog—are prolific by a sort of pullulation, so that clusters of scolices cover the same parental vesicle. Until, however, the scolex reaches the intestine of an animal suited to it, its propagation is entirely unsexual, and no organs of sex exist; but no sooner is it there, than it begins to develop itself into a cestoid worm, and to produce androgynous joints, fertile of new embryos, as already described. Thus we have in these creatures an instance, in its relations the most important known, of the recently discovered alternation of generations. See GENERATIONS, ALTERNATION OF. The transference of the scolex from its place of growth to that in which it becomes a cestoid worm, usually if not always takes place by the animal which contains it being eaten by that whose intestine is suitable to its perfect development. Each kind of cestoid worm is limited to certain kinds of vertebrate animals, and it has been proved by experiment that if introduced into the stomach of other kinds, the scolices soon die. The only C. W. which infest the human species are *Bothriocephalus* (q. v.) *latus*, and Tape-worms (q. v.). See Von Siebold's interesting work on Tape and Cystic Worms, printed for the Sydenham Society (London, 1857).

CESTRACION, a genus of sharks, regarded as constituting a distinct family, *Cestraciontidae*, although not more than two species are known as now existing. It is characterised by having two dorsal fins and one anal, the first dorsal situated over the space between the pectorals and ventrals; a spine forming the front of each dorsal; a short

wide tail, with its upper lobe strongly notched beneath; the mouth at the fore-end of the snout; spout-holes distinctly visible, rather behind the eyes; eyes destitute of nictitating membrane; small gill-openings; and the front of the mouth armed with sharp angular teeth, whilst the margins and inner surface of the jaws are covered with pavement-like teeth, presenting a general continuity of surface, as in skates, and disposed in rounded oblique scrolls—the former evidently adapted to the seizing of food, the latter to the crushing and bruising of it. The Port-Jackson Shark or 'Nurse' (*C. Philippi*) of the Australian seas, and the Cat Shark of Japan and China (*C. Zebra*), seem to differ chiefly in the patterns of colour. The *Cestraciontidae* are particularly interesting to geologists; for the oldest fossil sharks belong in great part to this family, of which remains are found even in the Palaeozoic strata; they become more numerous in the Carboniferous series; they are very numerous in the Lias and Chalk formations; but there they cease almost entirely, the strata of the Tertiary series scarcely containing any of them; whilst now the species are reduced, as we have seen, to one or two, and other types of shark have become more prevalent.

CESTRUM, the style or spatula used by the ancients in encaustic painting in wax and ivory. See ENCAUSTIC.

CESTUI QUE TRUST, a person who possesses the equitable right to deal with property, the legal estate in which is vested in a trustee. There is such a confidence between the cestui que trust and his trustee, that no action at law will lie between them, but they must settle their differences and arrange their disputes in a court of equity. 'The phrase cestui que trust is a barbarous Norman law French phrase, and is so ungainly and ill adapted to the English idiom, that it is surprising that the good sense of the English legal profession has not long banished it, and substituted some phrase in the English idiom, furnishing an analogous meaning.' —Wharton's *Law Lexicon*, p. 130.

CESTUS (Gr. *kestos*, embroidered), a girdle worn by Greek and Roman women close under the breasts, and so distinguished from the *zone*, worn round the loins. The C. of Venus was covered with alluring representations, so that Juno borrowed it when she desired to win the love of Jupiter. —CESTUS—or, more correctly, CÆSTUS, from the Lat. *cædere*, to slay—is also the name of the covering for the hands worn by Roman pugilists. It was at first nothing more than a leathern thong or bandage to strengthen the fist; but afterwards it was covered with knots and nails, and loaded with lead and iron, &c., to increase the force of the blow. It was not uncommon for a pugilist armed with the C. to dash out the brains or break the limbs of his antagonist. The Roman pugilist (*castuarius*) was often represented in sculpture.



Roman Cestus.

CETA/CEA (Gr. *ketos*, a whale), an order of Mammalia (q. v.) greatly differing in general form and habits from the rest of that class, so as indeed to be popularly reckoned among fishes. The C. have a fish-like form, terminating in a fish-like tail or tail-fin, which, however, is not vertical, as in fishes, but horizontal, and is the great instrument of progression; being moved by very powerful muscles,

commonly with an oblique downward and lateral movement, like that by which a boat is propelled in sculling, but sometimes by direct upward and downward strokes, when greater velocity is requisite.

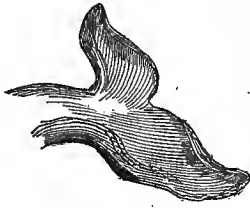

Tail-fin of Whale.

There are no hinder limbs, and even the pelvis is represented only by two small rudimentary bones, suspended in the soft parts, so that the body tapers gradually and uninterruptedly towards the tail. The fore-limbs are exclusively, or almost exclusively, adapted for swimming; their bones,



Bones of Fore-limb of Whale.

however, appearing in the skeleton as those of a hand, placed at the extremity of an arm, of which the bones are much abbreviated and consolidated, with little power of motion except at the shoulder-joint, and are entirely concealed in the soft parts of the animal. The head is connected with the body

without any apparent neck, and the vertebrae of the neck are partly ankylosed or soldered together. The skin is naked, having no general covering of hair, although some of the species possess conspicuous whiskers. The C. agree with quadrupeds, notwithstanding

the great differences already indicated, in the most important parts of their organisation. They are viviparous, and suckle their young, for which they exhibit great affection; they are also warm-blooded, breathe by lungs, and not by gills, and come to the surface of the water for the purpose of inhaling air. An approach to their fish-like form is to be seen in Seals (q. v.) and other *Phocidae* (q. v.); in which, however, the hinder limbs are largely, although peculiarly developed, whilst the fish-like tail-fin is wanting; the skin has a covering of hair; and the head and fore-limbs more resemble those of ordinary quadrupeds.

The C. are usually divided into two sections—the *Herbivorous* and the *Ordinary C.*; but the former, constituting the family of *Manatidae* (q. v.), have recently, by some systematic naturalists, been rejected from this order altogether, and associated with the *Pachydermata*. They differ very widely from the ordinary or true C., not only in their adaptation for the use of vegetable instead of animal food, which appears both in their dentition and in their digestive apparatus, but also in their pectoral instead of abdominal teats, and in their want of *blow-holes* and of any provision for retiring to great depths of the ocean, and remaining there for a considerable time, without returning to the surface to breathe.

The ordinary or true C. are divided into the families of *Delphinidae* (Dolphin, Porpoise, Beluga, Bottlenose, Narwhal, &c.), *Physeteridae* or *Catodontidae* (Cacholot, or Spermaceti Whale, &c.), and *Balaenidae* (Greenland Whale, Rorqual, &c.), the distinguishing characters of which are given under separate heads. They all feed on animal food, some of them pursuing and devouring fishes; others, and these the largest, subsisting chiefly on smaller prey, mollusks, small crustaceans, and even zoophytes, which they strain out of the water by a peculiar apparatus in their mouths. None of the

true C. have molar teeth or grinders like the *Manatidae*; all the teeth which any of them have are conical; but some of the largest are entirely destitute of teeth. The females of all of them have the teats situated far back on the abdomen. The fore-limbs of the true C. are mere fins, the slight power of grasping with them, which the *Manatidae* possess, having entirely disappeared. The resemblance to fishes is increased in many of them by the presence of a dorsal fin. There is a wonderful provision to enable them to spend some time under water, before returning again to the surface to breathe—an arterial plexus or prodigious intertwining of branches of arteries, under the pleura and between the ribs, on each side of the spine. This being filled with oxygenated blood, after the animal has spent some time at the surface breathing, the wants of the system are supplied from it, whilst breathing is suspended, so that some whales can remain below even for an hour. The position of the nostrils is remarkable, almost on the very top of the head, so that the animal can breathe as soon as the head comes to the surface of the water; and the nostrils are furnished with a valve of singular but very perfect construction, a sort of conical stopper of fibrous substance, preventing the ingress of water even under the pressure of the greatest depths. The nostrils appear to be little used for the purpose of smelling, the sense of smell being one which these animals either do not possess at all, or in a very imperfect degree; but they are much used, not only for breathing, but also for *spouting*, or the ejection of water from the mouth, for which reason they are generally called *blow-holes*—the water being forced through them by the compression of two large pouches or reservoirs which are situated beneath them. This compression is accomplished by an action similar to that of swallowing; the throat, however, not being open, but closed. The height to which the water is thrown into the air is extraordinary, and the spouting of the whale is one of those wonders of the ocean never to be forgotten by those who have seen it.

A peculiarity in the skin of the true C. adapts them for their manner of life. The skin is extremely thick, the inner part of it consisting of elastic fibres interlacing each other in every direction, the interstices of which are filled with oil, forming the substance usually called *blubber*. The oil deposited in this unusual situation, not only serves the ordinary purposes of fat, but that also of keeping the body warm, which to a warm-blooded animal, continually surrounded with water, is of great importance; whilst the elasticity of this extraordinary skin affords protection in the great depths to which some of the whales descend, and in which the pressure must sometimes amount to a ton on every square inch.

The number of known species of C. is not great, but their natural history has as yet been very imperfectly studied. All of them are large animals, some of them by far the largest that now exist. Almost all of them—both herbivorous and ordinary—are marine, but some of the smaller species ascend large rivers to a great distance from the sea; and one, of the family *Delphinidae*, belongs exclusively to fresh waters, being found only in the upper tributaries of the Amazon and the elevated lakes of Peru.

Fossil Cetacea have been hitherto discovered only in the Tertiary formation. Their remains represent species not only belonging to each of the recent families of true C., but have supplied materials for forming a new family intermediate between the true whales and the herbivorous cetacea. These fossils were originally described as reptiles; but they have been satisfactorily shewn to be carnivorous C. by Owen, who, from their remarkable conjugate

teeth, has given the typical genus the name of *Zeuglodon* (q. v.), and the family that of *Zeuglodontidae*. In all, six or seven species have been described belonging to this family, from the Eocene and Miocene beds of Europe and America. The *Delphinidae* appear first in the Miocene strata, and continue through the newer beds. The remains of a Narwhal, which cannot be distinguished from the living species, have been found in several places in England. Of *Physeteridae*, three species have been noticed in Pleiocene and Pleistocene strata, belonging to the recent genus *Physeter*. Fossil *Balaenidae* occur in the Miocene and newer beds. Only four species have been described, if we exclude *Cetotolithes* (q. v.), a name given to teeth and ear-bones, belonging to animals of this family, which occur in great numbers in the Suffolk Crag.

CETOTOLITES, a name given by Owen to fossil cetacean teeth and ear-bones, which occur in great abundance in the Red Crag of Suffolk, a member of the Pleiocene period. They are rubbed and water-worn, and have evidently been washed out of some earlier strata, which remain yet unrecognised. The extent of these earlier strata must have been very great, seeing that the remains now extend over a large district in Essex and Suffolk, and attain a thickness, in some places, of not less than 40 feet. Professor Henslow, in 1843, drew the attention of agricultural chemists to this deposit, as a source of materials for manure, and since then superphosphate manures have been manufactured from it to the value of many thousand pounds annually; a striking example of the valuable practical results which frequently flow from a purely scientific discovery.

CETRA'RO, a town of Naples, in the province of Calabria Citra, situated on the Mediterranean, 24 miles north-west of Cosenza. It has anchovy fisheries, and a population of about 6000.

CETTE, a seaport town of France, in the department of Hérault, is built on a neck of land between the lagoon of Thau and the Mediterranean, in lat. 43° 24' N., long. 3° 42' E. The town, which is entered by a causeway raised above the Thau lagoon, and a bridge of 52 arches, is fortified, and the harbour is defended by a citadel and forts. The space enclosed by the piers and breakwater forming the harbour is about 30 acres, and has a depth of from 16 to 19 feet. A broad deep canal, lined with excellent quays, connects the port with the Lake of Thau, and so with the Canal du Midi and the Rhoue, thus giving to C. an extensive inland traffic; it has likewise an active foreign commerce. The principal trade is in wine, brandy, salt, dye-stuffs, perfumery, and verdigris. Other chief imports are wool, cotton, grain, oil, and colonial produce. C. has ship-building yards, and fisheries of oysters and anchovies. Pop. 19,000.

CEUTA, a town belonging to Spain, situated in the kingdom of Fez, on the north coast of Africa, and opposite to Gibraltar, in lat. 35° 54' N., and long. 5° 16' W. It is strongly fortified, and defended by a citadel and forts erected on Mount Hacho, the ancient *Abyla*, or South Pillar of Hercules. It is the most important of the four Spanish *presidios*, or convict establishments, on this coast. The harbour is small and not very safe; and the population, stated at 8000 or 10,000, is composed of Spaniards, Moors, Negroes, Mulattoes, and Jews, mostly very poor, and employed in trade and fisheries. Many of the Spaniards living here are state-prisoners, and even the garrison is partly manned by convicts. C., formerly called *Septa* or *Septum*, was taken from the Vandals in 534 by Justinian, who fortified the place anew. In 618, it fell into the hands of the Western Goths; afterwards it was taken by the

Moors, who held it until 1415, when it was captured by the Portuguese. It was annexed, with Portugal, to the crown of Spain in 1580, and was the only place on the African coast retained by Spain when Portugal was restored to its independence in 1640.

CEVADILLA. See **SABADILLA**.

CEVENNES (ancient *Cebenna*), the chief mountain-range in the south of France. With its continuations and offsets, it forms the watershed between the river-systems of the Rhone and the Garonne. Its general direction is from north-east to south-west, commencing at the southern extremity of the Lyonnais mountains, and extending under different local names as far as the Canal du Midi, which divides it from the northern slopes of the Pyrenees. The central mass of the C. lies in the departments Lozère and Ardèche, Mont Lozère reaching an elevation of 4884 feet, and Mont Mézen (the culminating point of the chain) an elevation of 5794 feet. The average height is from 3000 to 4000 feet. Their masses consist chiefly of amphibolic rocks, granwacke, and limestone, covered with tertiary formations, which in many places are interrupted by volcanic rocks.

The C. has been celebrated as the arena of religious warfare. As early as the 12th c., the several sects known by the names, the 'Poor of Lyon,' the *Albigenses* (q. v.), and the *Waldenses* (q. v.), were known and persecuted in this district. After the revocation of the Edict of Nantes by Louis XIV. in 1685, a series of cruel persecutions of the Protestants in the C. began, especially in 1697, after the Peace of Ryswick. 'Dragonnades' (q. v.) were employed to enforce the doctrines of the monks sent as missionaries into the heretical district. All persons suspected of Protestantism met with the most harsh and cruel treatment. Some of the inhabitants emigrated, others fled into the fastnesses of the mountains. Driven to desperation, the persecuted people at length rose to arms, and the murder of the Abbé du Chaila, who was at the head of the dragonnades, gave the signal of a general insurrection in 1702. The insurgent peasants were styled *Camisards*—possibly from *camise*, a smock worn by the peasantry. Headed by bold leaders, the most famous of whom were Cavalier and Roland, they defeated the troops sent against them by Louis again and again, until that king thought the insurrection of sufficient importance to require the presence of the distinguished general, Marshal Villars; but he was recalled before the revolt had been put down, and it was left to the Duke of Berwick to extinguish it in blood; the contest terminating in an entire desolation of the province, and the destruction or banishment of a great portion of the inhabitants. The embers of religious hatred still remained glimmering through the following century, and, after the restoration of the Bourbons in 1815, burst out into flames in the terrible persecution of the Protestants in Nîmes (q. v.) and other places in the south of France. See *Histoire des Troubles des Cévennes, ou de la Guerre des Camisards* (Villefranche, 1760), and Schulz's *Geschichte der Camisarden* (Weimar, 1790).

CEYLANITE. See **SINEL**.

CEYLO'N (the *Taprobane* of the Greeks and Romans, and the *Serendib* of the *Arabian Nights*), a valuable island and British colony in the Indian Ocean, to the south-east of the peninsula of Hindustan, from which it is separated by the Gulf of Manaar and Palk's Strait. Recent observations have shewn its true place to be between 5° 55' and 9° 51' N. lat., and 79° 42' and 81° 55' E. long. Extreme length from north to south, from Point

Palmyra to Dondera Head, 271½ miles; greatest width, from Colombo to Sangemankande, 137½ miles. Area, including dependent islands, 25,742 square miles.

Physical Features.—In natural scenery, C. can vie with any part of the world; and as it rises from the ocean, clothed with the rich luxuriance of a tropical vegetation, it seems to the voyager like some enchanted island of Eastern story. Its hills, 'draped with forests of perennial green, tower grandly from height to height, till they are lost in clouds and mist. Near at hand, a sea of sapphire blue dashes against the battlemented rocks that occur at isolated points, and the yellow strands are shaded by groves of noble palms. In shape, C. resembles a pear, but its inhabitants more poetically compare it to one of their elongated pearls. Undulating plains cover about four parts of the island, and the fifth is occupied by the mountain-zone of the central south, which has an elevation of from 6000 to 8000 feet above the sea-level. Pedrotallagalla, the highest mountain in the range, attains the height of 8280 feet; the celebrated mountain of Adam's Peak, 7420 feet; and the table-land of Neuera Ellia, 6210 feet.

Geology.—The mountain system is mainly composed of metamorphic rocks, chiefly gneiss, frequently broken up by intruded granite. With the exception of some local beds of dolomitic limestone, the gneiss is everywhere the surface rock, and the soil is composed of its disintegrated materials. No fossils, as was to be expected, have been noticed in C., if we except the semi-fossil remains of mollusca, crustacea, and corals, belonging to living species, which occur in the rude breccias of the north in the neighbourhood of the sea. The northern part of the island is rising, and there also the land is making encroachments on the sea from another agency. The immense masses of corals continually increasing, retain the débris brought from the Indian continent by the currents of the sea, and thus form a flat, ever-increasing madreporic plain.

Of *metals and minerals*, iron, in the form of a carbonate, can be obtained in great quantities, and of such purity as to resemble silver. Tin is found in the alluvium at the base of the mountains, and on the heights the rare metal tellurium has been discovered. Nickel and cobalt are scarce. Anthracite and rich veins of plumbago exist on the southern range of hills. The *gems* of C. have been celebrated from time immemorial, and they are most plentiful in the alluvial plains at the foot of the hills of Saffragam. Sapphires, rubies, the oriental topaz, garnets, amethysts, cinnamon stone, and cat's-eye, are the principal gems and precious stones of the island. The most valuable is the sapphire; and one of these, found in the year 1853, was worth more than £4000. The value of the precious stones annually found in the island has been estimated at £10,000. The pearl-fishery in the Gulf of Manaar has long been celebrated, and the revenue derived from it by government for the year ending 31st December 1857 was £20,550, 15s. 6d. Eighty-seven seconds is about the longest time the best divers can remain under water, and 13 fathoms is the greatest depth to which they descend.

Rivers.—The most important river in C. is the Mahawelli-ganga. It has its source in the vicinity of Adam's Peak, and after draining more than 4000 square miles, it separates into several branches, and enters the ocean near Trincomalee. The south side of the island is watered by ten rivers of considerable size, which flow into the sea between Point de Galle and Manaar. On the east coast, the rivers are smaller, but still more numerous, and many others traverse the northern and eastern provinces.

Harbours.—Point de Galle (q. v.) and Trincomalee (q. v.) are the two harbours of Ceylon. The former is small and dangerous, but the latter is unsurpassed as a safe and commodious port. The variation of the tides is very trifling; the rise and fall not generally exceeding 18 to 24 inches, with a third of increase at spring-tides.

In *climate*, C. has a great advantage over the mainland of India, and as an island, enjoys a more equable temperature. The average for the year in Colombo (q. v.) is 80° in ordinary seasons. April is the hottest month; and in May the south-west monsoon commences amid a deluge of rain, and continues the prevailing wind till October, when the north-east monsoon sets in: 80 inches is the average annual fall of rain, though in an exceptional year, 120 inches have been registered. The beautiful table-land of Neuera Ellia was first visited by Europeans in 1826, and is now used as a sanitarium. Here the thermometer in the shade never rises above 70°, while the average is 62°; the nights are cool and refreshing. The north of the island, including the peninsula of Jaffna, the plains of Neuera Kalawa, and the Wannu, may be reckoned as a third climatic division. Here the annual fall of rain does not exceed 30 inches, and irrigation is largely employed in agriculture.

Flora.—The general botanical features of C., especially of the lowlands, are nearly identical with those of Southern India and the Deccan, although it possesses a few genera of plants not to be found in those regions. Its phænogamic plants are limited to about 3000. The beautiful ixoras, erythrinæ, buteas, Jonesias, and other flowering shrubs bloom in the forests. At an elevation of 6500 feet, the acanthaceæ cover large tracts of ground, and the tree-fern reaches the height of 20 feet. On the highest ground, rhododendrons attain to the size of timber-trees. The Coral-tree (*Eurythrina Indica*), the Murutu (*Lagerstræmia Regiæ*), and the *Jonesia asoca* are amongst the most magnificent of the flowering trees. The fig tribe are planted in the vicinity of the temples. In the forests, climbing-plants and epiphytes of prodigious size and striking appearance cover the trees with a mass of parasitical foliage of extraordinary growth. The Palmaceæ are very conspicuous in the vegetation of C., although not more than 10 or 12 species are indigenous: the cocoa-palm—of which it is estimated there are not less than 20 millions of trees—the talipot, the palmyra—which forms extensive forests in the north of the island—and the jaggery palm, are the most noteworthy. Of timber-trees, 90 species are known, and amongst these the satin-wood holds the first rank. The flora of the highlands, above 2000 feet, and up to 6000 or 7000, though much resembling that of the Neigherries, has a marked affinity to the vegetation of the highlands of Malacca and Java, especially the latter.

Fauna.—A knowledge of the fauna of C. has been greatly advanced by the labours of Drs Templeton and Kelaart and Mr Edgar Layard. *Quadrumanous* animals are represented by the *Loris gracilis*, and five species of monkeys. Sixteen species of the *Cheiroptera* or bat tribe, exist in C.; and what is very remarkable, many of these rival the birds in the brilliancy of their colours. The *Pteropus Edwardsii* (the flying-fox of Europeans) measures from 4 to 5 feet from tip to tip of its extended wings. Of the larger *Carnivora*, the bear and leopard; and of the smaller, the palm-cat and the glossy genetive (the civet of Europeans) may be mentioned. The dreaded tiger of India, the cheeta, the wolf, and the hyæna, are happily not met with in Ceylon. Deer, buffaloes, and the humped ox of India are amongst the *Ruminantia*; the little musk-deer (*Moschus meminna*)

is less than two feet in length. The *Pachydermata* are represented by the elephant and the wild boar; the former, which is for the most part tuskless, is emphatically lord of the forests of Ceylon. The most remarkable of the *Cetacea* is the dugong. Whales are captured off the coast. 320 species of *Birds* have been ascertained by Drs Templeton and Kelaart and Mr Layard. The song of the robin and long-tailed thrush, and the flute-like voice of the oriole, are heard over the whole mountain zone, and far down into the neighbouring plains. Eagles, the beautiful peregrine falcon, owls, swallows, kingfishers, sun-birds, bulbuls, crows, parroquets, pigeons, pea-fowl, jungle-fowl, and many others of the feathered tribe might be mentioned did space permit. Myriads of aquatic birds and waders, amongst which the flamingo is conspicuous, cover the lakes and lagoons. The crocodile is the largest reptile in the island; tortoises and lizards are also found. There are a few species of venomous snakes, and of these the tipolonga and the cobra da capello are the most deadly.

Inhabitants.—The Singhalese, the most numerous of the natives of C., are the descendants of those colonists from the valley of the Ganges who first settled in the island 543 B. C. In their customs, costume, and general appearance, they have remained unchanged since the days of Ptolemy. The dress of the men, who have delicate features and slender limbs, is singularly effeminate, and consists of a *comboy* or waist-cloth, very much resembling a petticoat; their long hair, turned back from the forehead, is confined with combs, and earrings are worn by way of ornament. The women, in addition to the comboy, cover the upper part of the figure with a white muslin jacket, and adorn themselves with necklaces, bangles, rings, and jewellery. The Singhalese are false and cowardly, but manifest a strong affection for their relatives, and a reverence for old age. Polyandry still lingers in the interior of C., and was formerly universal; it is now, however, chiefly confined to the wealthier classes, amongst whom one woman has often three or four husbands. The Kandjans, or Highlanders, are a more sturdy race, and maintained their independence for three centuries after the conquest of the low country by European settlers. The Malabars, or Tamils, have sprung from those early invaders of C., who from time to time swept across from Southern Hindustan, and contended with the Singhalese kings for the sovereignty of the island. They have formed the chief population of Jaffna for full 2000 years, and constitutionally excel the Singhalese and Kandjans. The Moormen, who are the most energetic and intelligent of the native communities, are met with in every province as enterprising traders. They are a very distinct race from the Singhalese, but have no tradition of their origin. Europeans generally believe them to be of Arab descent, but Tennent is of opinion that 'they may be a remnant of the Persians, by whom the island was frequented in the fourth and fifth centuries.'

The 'burghers' of C. are a people of European descent, who have become naturalised. Those of Portuguese extraction hold the lowest place, and are mostly tradesmen and artisans; but the Dutch burghers frequently fill responsible posts, and are employed in the government offices.

Besides the races already alluded to, there is a remarkable tribe of outcasts—the Veddahs—hardly removed from the wild animals of the forest, and believed to be descended from the Yakkhos, the aboriginal inhabitants of the country. They occupy a district in the eastern part of the island, and have there preserved their ancient customs and

manner of living unaltered for more than 2000 years. They appear to be without the instinct of worship, and have no knowledge of a God. The tribe is divided into the *Rock Veddahs* and the *Village Veddahs*. The former hide themselves in the jungle, live by the chase, and sleep in trees or caves. They use fire to cook their meat, and their greatest gastronomic treats are the iguana lizard and roasted monkey. Their language—if the few words they make use of can be called by that name—is a dialect of the Singhalese. The Village Veddahs locate themselves in the vicinity of the European settlements, on the eastern coast, living in rude huts of mud and bark, and are hardly more civilised than their brethren of the jungles. The exertions of government to reclaim this harmless but degraded people have in some degree succeeded, and a promising colony has been formed.

The native population of C. in 1857 was 1,697,975. The European and other inhabitants, including the military, amount to about 25,000. Sir J. E. Tennent is of opinion that C., when in the height of its prosperity, must have been ten times as densely populated as at the present day.

Religion.—The Singhalese are devoted to Buddhism (q. v.), which is the prevailing religion of the island. It does not exist, however, in that state of purity in which it is still found in the Indo-Chinese peninsula. Its sacred books are identical with those of Burmah and Siam, and both record the doctrines of Gautama in the Pali language; the deviations are in matters of practice. The Malabar kings adulterated Buddhism to a considerable extent with Brahmanism, introducing the worship of Hindu deities into the Buddhist temples, and this continues more or less to be the case. More than once have the Buddhists of C. sought to restore the purity of their faith—at one time sending deputies to Siam, at another to Burmah, with this object in view. The Burman or Amarapura sect have long been the reformers of Singhalese Buddhism, and maintain no very friendly relations with the party, who, supported by the priests of Siam, acknowledge the civil power in matters of religion, sanction the worship of Hindu deities and the employment of the priesthood in secular occupations, uphold caste, and restrict the sacred books. Caste was acknowledged by the Singhalese prior to the introduction of Buddhism, which in principle is opposed to it; but so firmly was it rooted, that it still endures, though more as a social than a sacred institution. Gautama Buddha is said to have visited C. three different times to preach his doctrine, and his *Sri-pada*, or sacred footstep, on the summit of Adam's Peak (q. v.), still commands the homage of the faithful. Buddhism was not, however, permanently introduced into C. till 307 B. C., when Mahindo, obtaining the support of the king, established it as the national faith. The influence of the priests gradually increased, and, by the piety of the Singhalese kings, monasteries were richly endowed; for though the Buddhist monk is individually forbidden to possess goods, a community may own property to any extent; and it is a remarkable fact that, at the present day, no less than one-third of the cultivated land of the island is computed to belong to the priesthood, and is exempt from taxation. The priests of C. are divided into two orders—the *Samanaravos*, and those who, after a time of probation, receive the higher grade of *Upasampada*. The fraternity are not raised by education above their countrymen, and the respect paid them is directed more to the dress than to the person of the individual. Any member is at liberty to lay aside his ascetic character, and return to a secular

life. The most celebrated Buddhistic relic in C. is the *Dalada*, or sacred tooth of Gautama, at Kandy, which is guarded with jealous care, and preserved in an elegant shrine; but it is well known that the original relic was destroyed by the Portuguese, and the present substitute is a piece of discoloured ivory, bearing no resemblance to a human tooth. In all Buddhist countries, the sacred buildings present, with certain modifications, the same general character (see articles BUDDHISM, BURMAH, &c.); and in C. we find the three classes represented by the dagoba, or relic-shrine (*datu*, a relic, and *gabbhan*, a shrine), the temple proper, and the vihara or monastery. The labour bestowed on these edifices in the early ages of the Singhalese monarchy is truly astonishing.



The Gal-wihara at Pollanarua.

In the north of the island, ruined cities—buried for ages in the depths of the forest—have been discovered, revealing monuments that in dimensions may almost compare with the pyramids of Egypt. The most remarkable of these vestiges of an early civilisation is Pollanarua, the ancient capital of C.; and here is the celebrated *Gal-wihara*, a rock-hewn temple, supposed to be 'the only example in Ceylon of an attempt to fashion an architectural design out of the rock, after the manner of the cave-temples of Ajunta and Ellora.' The reclining figure of Gautama on the right (see cut, which with the other illustra-

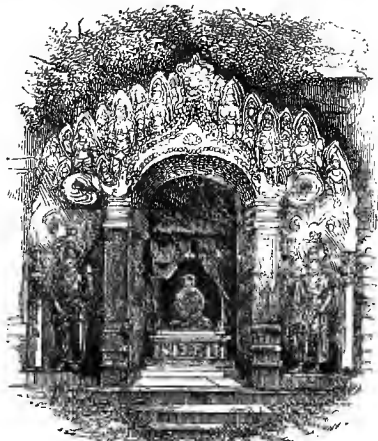

Entrance to the Temple of Dambool.

tions are reduced from Sir J. E. Tennent's *Ceylon*) is 45 feet in length; the upright one measures 23 feet; and the sitting image on the left is 16 feet from

the altar to the top of the head. The cave-temple of Dambool was built 100 B. C., and is the most celebrated in the island. The bell-shaped tapering dagobas of C., as relic shrines, answer to the pagodas of Burmah—which they very much resemble—and the topes of Afghanistan. The ruins of the Jaytawanarama dagoba still reach the height of 249 feet; its diameter is 360 feet; and from base to pinnacle it is covered with trees of the largest size. This enormous structure contains 20 millions of cubical feet; and Sir J. E. Tennent concludes that to erect such a mass of masonry, even in the present day, 'would occupy 500 bricklayers from six to seven years,' at the cost of a million sterling. The Ambustella of Mihintala is another remarkable dagoba. A very famous object in connection with Buddhism in C. is the sacred Bo-tree of Anarajapoorra (*Peepul*, *Ficus religiosa*), which was planted there 288 years B. C., and is by far the oldest tree in the world of which an authentic history exists. See BO-TREE. Amongst the antiquities of C. must be mentioned those wonderful monuments of the former greatness of the Singhalese people—the ruined tanks; with

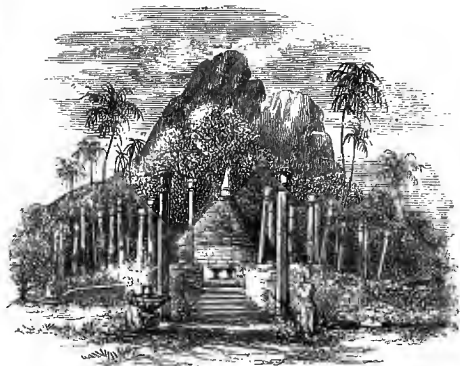

The Ambustella Dagoba, Mihintala.

which almost nothing of a similar kind, whether ancient or modern, can be compared: 30 colossal reservoirs, and about 700 smaller tanks, still exist, though for the most part in ruins. The restoration of these magnificent works of irrigation has recently been begun. Brahmanism or Hinduism (q. v.) is the faith of the Tamils or Malabars, but the Moormen are Mohammedans. After the expulsion of the Dutch Christians, Protestant missions to the natives of C. were commenced by the Baptists in 1813. The Wesleyan Methodists followed in 1814, the Americans in 1816, the Church of England in 1818, and Christian instruction has made some progress amongst the native populations. Of these the peasantry of the Kandyan hills have proved the least accessible to its influence. Schools, collegiate institutions, and female seminaries, under the direction of the missionaries, are in successful operation.

The government of C. is administered by a governor appointed by the crown, and he is assisted by a cabinet council, composed of his principal officers. There is also a legislative council, to which all measures are submitted; but its decisions are still subject to the veto of the governor. The revenue for the year ending 31st December 1857 was £569,047, 6s. 10½d., and the expenditure for the same time amounted to only £228,820, 4s. 8½d. C. possesses that great test of a prosperous colony—an increasing revenue; in the year 1859 it amounted to £747,000. The colony made great

progress under the able administration of Sir H. Ward. An objectionable tax, however, on the import of grain, and also on its home cultivation, still exists.

Imports and Exports.—The imports are miscellaneous: the principal exports consist of coffee, coir in fibre and manufactured, cinnamon, cocoa-nuts, cocoa-nut oil—of which, in 1857, the enormous quantity of 1,767,413 gallons, valued at £212,184, was exported—araca-nuts, cardamons, béche-de-mer, arrow-root, curry stuffs, ghee, dried and salted fish, hides, elephants, plumbago, pearls, &c. In the year 1859, 411,342 cwt. 1 qr. 11 lbs. of plantation coffee, value £1,110,624, 6s. 10d.; and 178,436 cwt. 23 lbs. native coffee, value £356,872, 8s. 3d., were exported; also, 116 elephants, value £2619, 10s., and pearls to the value of £25,525, 19s. 6d.

The following official returns are taken from the C. government *Gazette* of May 19, 1860. Total value in sterling of the imports and exports of C., from and to each country in the year 1859:

Countries.	Imports therefrom.			Exports thereto.		
	£	s.	d.	£	s.	d.
United Kingdom,	938,491	9	3	1,434,620	0	5
British Possessions in India,	1,754,231	12	1	767,435	2	10
Other British Colonies,	377,234	18	4	71,256	3	4
Foreign Countries,	404,529	7	5	251,240	6	7
Total,	3,474,487	7	1	2,524,751	13	2
Deduct Specie,	1,159,780	7	0	364,249	0	0
	2,314,707	0	1	2,160,502	13	2

The number of ships entered at ports in C. in the year 1859 were 2960, of which 292 were from the United Kingdom, and 2573 colonial; total tonnage, 388,731. The number of ships cleared at ports in C. for the same year were 2962, of which 291 were from the United Kingdom, and 2578 colonial; total tonnage, 392,661. To the ancient world C. was famous as a place of traffic. Egyptians, Greeks, Romans, Persians, and Arabians traded to its ports, and many particulars, such as geographical position and natural productions, seem to identify Point de Galle with the Tarshish of the Hebrew historians.

The history of C., of which the limits of this article will only allow the briefest possible outline, may be conveniently divided into ancient and modern, and the latter into the Portuguese, Dutch, and British periods.

The records of its early history came to light in 1826, and Mr Turnour, devoting himself to their study, composed an *Epitome of the History of C.*, from the year 543 B.C. to 1798 A.D.; and he records the reigns of 165 kings, who reigned during this space of 2341 years. The most famous of the Singhalese books is the *Mahawanso*, a metrical chronicle, in the Pali language, which gives an account of the island during the above 23 centuries. The story begins with the invasion of Wijayo (543 B.C.), son of a petty Indian sovereign in the country watered by the Ganges. He subdued the Yakkhos, the aboriginal inhabitants; married a daughter of one of the native chiefs, whom he subsequently repudiated for an Indian princess; and founded a dynasty that held undivided sovereignty in C. for nearly eight centuries. He bestowed on his kingdom his patrimonial name of Sihala (whence Singhalese, Ceylon), and promoted the settlement of colonists from the mainland. In the reign of king Deveni-piatissa (307 B.C.), Buddhism was established as the national religion, and his reign was further remarkable by the planting of the sacred Bo-tree, 288 B.C.; and now commenced the erection of those stupendous buildings already noticed. The next important epoch in Singhalese history is the

usurpation of the Malabars (237 B.C.), foreign mercenaries from the Coromandel coast, to whom the native sovereigns had intrusted the defence of the island. Several Malabar invasions are chronicled in the history of C., and these foreigners long contended with the native princes for supreme authority. Passing on to 1071 A.D., a native dynasty was then re-established in the person of Wijayo Bahu, which, for 100 years, delivered the country from the dominion of the Malabars. Prakrama Bahu commenced a reign, in 1153, the most renowned in the records of Ceylon. He devoted himself to religion and agriculture, and besides many notable religious edifices, he caused no less than 1470 tanks to be constructed, subsequently known as the 'seas of Prakrama.' Thirty years after the death of this monarch, the Malabars landed with a large army, and speedily conquered the whole island. In 1235, a native dynasty recovered a part of the kingdom. During the reign of Dharma Prakrama IX. the Portuguese first visited C., 1505; but it was in 1517 that they first formed a permanent settlement at Colombo for trading purposes. Their encroachments soon raised the patriotic Kandians, and it is a remarkable fact, that though at the first visit of the Portuguese in 1505 they were even ignorant of the use of gunpowder, they, after a while, excelled their enemies as musketeers, and were finally able to bring 20,000 stand of arms to bear against them. 'Amity, commerce, and religion,' was the Portuguese motto; but their rule in C. is a sad story of rapacity, bigotry, and cruelty. They were at last driven from the island by the Dutch in 1658, after a contest of twenty years, when, as Sir J. E. Tennent remarks, 'the fanatical zeal of the Roman Catholic sovereign for the propagation of the faith, was replaced by the earnest toil of the Dutch traders to intrrench their trading monopolies; and the almost chivalrous energy with which the soldiers of Portugal resisted the attacks of the native princes, was exchanged for the subdued humbleness with which the merchants of Holland endured the insults and outrages perpetrated by the tyrants of Kandy upon their envoys and officers.' But the purely military tenure of the Dutch was destined to give place to the colonisation of the British. It was during the great European war succeeding the French Revolution, that the English gained possession of the island. On the 1st August 1795, an expedition under Colonel James Stuart landed at Trincomalee, which was speedily captured, and finally the garrison of Colombo surrendered on the 16th February 1796. By this capitulation, all the Dutch settlements and strongholds in C. were ceded to the English; though the island was not formally annexed to the British crown till the Peace of Amiens, 27th March 1802. The native sovereigns, however, continued in the possession of their mountain territory; but at length the Kandyan king, Wikrama Raja Singha, after perpetrating the most frightful atrocities on his own people, seized and murdered certain native merchants, British subjects, trading to Kandy. War followed, January 1815; Kandy was taken, and the tyrant sent a captive to the fortress of Vellore. On the 2d March 1815, a treaty was concluded with the native chiefs, by which the king was formally deposed, and his territories annexed to the British crown.

Since then, the island has made rapid strides in material prosperity. The mountain-forests have been replaced by plantations of coffee, of which, in the year 1857, there were 403 under cultivation, giving an average crop of 347,100 cwt. per annum. Many important public works have been completed, and others are still in progress. A magnificent mountain-road now connects Colombo with Kandy.

CEYX—CHAFFINCH.

A legislative council has been formed, and a charter of justice promulgated; while trading monopolies, slavery, and religious disqualifications have been entirely abolished.—See *Ceylon, Physical, Historical, and Topographical, &c.*, by Sir James Emerson Tennent (Lond. 1859); a very complete and learned work on the island, written in popular and eloquent language; and *Christianity in Ceylon*, by the same author (Lond. 1850).

CEYX. See **KINGFISHER.**

CEZI'MBRA, a town of Portugal, in the province of Estremadura, on a bay of the Atlantic, about 18 miles south of Lisbon. Here the Moorish king of Badajoz, who had advanced to succour the place, was defeated in 1165 by Affonso Henriques. C. has active fisheries, and a population of 5000.

CHA'CMA. See **BABOON.**

CHA'DDA. See **BENUWE.**

CHADWICK, EDWIN, a distinguished social and sanitary reformer of the present day, was born in the vicinity of Manchester, 24th January 1801. He studied law, but early devoting his attention to questions of social, sanitary, and political science, he attracted the notice of Lord Grey's government, by whom he was appointed an assistant-commissioner to inquire into the operation of the poor-laws in England and Wales. His report, published with others in 1833, commanded most attention, being remarkable alike for the wide and searching character of its investigations, the happiness of its illustrations, and the convincing proofs it furnished as to the necessity of reform in the system of administration. Its merit was recognised by those who had the power to reward him; and on the organisation of the new Poor-law Board, C. was appointed secretary. In connection with this Board, and the General Board of Health, C. for twenty years was energetic in the origination and administration of remedial measures relative to the distribution of poor-law funds and to the sanitary condition of the country. And not content with investigating these great subjects, his indefatigable mind sought further exercise in inquiring into the constitution of the constabulary force, with a view to the better prevention of offences and the readier detection of criminals. On a change being made in the Board of Health in 1854, C. retired with a pension. He has since taken great interest in promoting competitive examinations for government offices; and indeed in almost all questions of social economy, being an active member of the Association for the Promotion of Social Science.

CHÆRONI'EA, a city of Bœotia, in ancient Greece, near the Cephissus, on the borders of Phocis. It is celebrated on account of several important battles fought in the neighbourhood. In 447 B. C., the Bœotians here obtained a victory over the Athenians; and in 338 B. C., Philip of Macedon signally defeated the united forces of the Athenians and Bœotians, and so crushed the liberties of Greece. A mound of earth, about a mile from the modern village of Kapurna, which occupies the site of the old city, still marks the place where the Thebans who fell in the battle were buried; and a magnificent lion, which Colonel Mure pronounced to be 'the most interesting sepulchral monument in Greece,' was excavated from this tumulus some years ago. At C., also, 86 B. C., Sulla defeated the generals of Mithridates. Plutarch was a native of this town. A few ancient remains yet exist.

CHÆTODONTIDÆ, a family of acanthopterous fishes, nearly corresponding to the genus *Chætodon* (Gr. hair-tooth) of Linnæus; and also named **SQUAMPENNÆ** (Lat. scaly-finned), because of the most distinctive character of the family, the

incrustation of the soft portions of the dorsal and anal fins, and often of the spinous parts also, with scales, the fins appearing to taper gradually out of the thickness of the body, which is in general remarkably compressed, so that, without dissection, it is impossible to tell where they begin. The scales are strongly ctenoid (q. v.). The typical genus *Chætodon*,

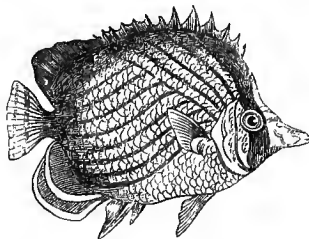

Chætodon.

and those most nearly allied to it, have hair-like teeth, so that their jaws resemble brushes; some fishes of the family, however, have trenchant teeth on the jaws, and some, as *Brama* (q. v.), have card-like teeth both on the jaws and palate. Most of the C. are tropical; only one species, *Brama Rasi*, is ever found in the British seas. They generally frequent rocky shores. Their colours are often extremely gay, and usually disposed rather in stripes or bands than in spots. 'The eye of man receives the greater pleasure from their contemplation, in that, being of moderate or small size, and haunting habitually the coral basins of the transparent tropical seas, they disport themselves in the beams of a vertical sun, as if desirous of exhibiting their splendid liveries to the greatest advantage in the blaze of day.' Many singularities of form occur in this family, as the long slender snout of the *Chelmons*, the whip-thong-like prolongation of some of the rays of the dorsal fins in *Heniochus* and *Zanclus*, the wing-like dorsal and anal fins of *Platax*, the sharp recurved horns of the Buffalo-fish (*Taurichthys*), &c. To this family belong the Archer-fishes (q. v.), whose singular habits have been already noticed.—The flesh of most of the C. is of very fine flavour.

CHA'FER, a common name of those beetles or coleopterous insects, which either in the perfect or larva state, are destructive to plants; particularly those which devour the wood, bark, or roots of trees. From these, however, it is sometimes extended to some coleopterous insects which have no such habit. The word C. is seldom used alone, but generally as part of a name, with some prefix; thus, we have *Cock-chaffer*, *Rose-chaffer*, *Bark-chaffer*, &c.

CHA'FF-CUTTER, a name commonly given to an implement now much used by farmers for cutting hay and straw into half-inch lengths. The advantage of this consists not so much in facilitating mastication or digestion, as in preventing animals from wasting their food. No small amount of mechanical ingenuity has been applied to the construction of chaff-cutters, the simplest and oldest kinds of which are mere hand-machines with a single large knife, the hay or straw being pushed forward in a trough or box, whilst others are driven by horse, steam, or water power, and are not a little complicated.

CHA'FFINCH (*Fringilla cœlebs*), one of the most common British birds, a species of Finch (q. v.), and probably that to which the name Finch, now so extended in its signification, originally belonged; *finke*, the German form of the name, and *pink* and *twink*, English provincial forms still appropriated to

the C., having some resemblance of sound to its common call-note. The whole length of the C. is about six inches. The tail is very slightly forked. The male, in summer, has the top of the head and nape of the neck bluish-gray; the back, chestnut; the wings almost black, with two conspicuous white bars; the tail, nearly black. The colours of the female are much duller than those of the male. The C. is a very widely distributed species, being found in almost all parts of Europe, in some parts of Asia, in the north of Africa, and as far west as the Azores. In the colder northern countries, it is migratory; in more southern regions, it is stationary. Linnaeus gave it the specific name *caelebs*, from observing that the flocks congregated in winter in Sweden consisted chiefly of males, the females having, as he supposed, sought a milder climate. A partial separation of the sexes is observed also in the great winter-flocks in Britain, but it is only partial; and Yarrell thinks that the young males of the previous season, which resemble the females in plumage, are associated with them, and have been mistaken for them. The flocks seen in Britain in winter are believed to be augmented by migration from Scandinavia. The eggs are usually four or five in number, of pale purplish buff colour, sparingly streaked and spotted with reddish brown. The C. feeds chiefly on insects, and does much service in summer by destroying aphides and caterpillars; but eats also seeds, and is sometimes persecuted, because in spring it pulls up and eats young turnips and radishes when in the seed-leaf. Great numbers of chaffinches are killed for the table in Italy. In Germany, this bird is in the highest esteem as a song-bird. Its notes are very clear and loud, but some individuals greatly excel the ordinary multitude of their species; and their superior notes, if heard on the Thuringian hills, speedily attract bird-catchers. Bechstein says that, in Thuringia, a cow has been given for a C. with a fine voice; and the Germans have taken the trouble to classify the different strains of chaffinches, giving them distinct names, and regarding those birds as particularly valuable by which certain of these strains are produced.—The common Scotch name of the C. is *Shilfa*.

CHAGRES, a river entering the Gulf of Darien on the north side of the Isthmus of Panama, near lat. 9° 18' N. Though, towards its mouth, it varies in depth from 16 to 30 feet, it is yet, by reason at once of its rapidity and its falls, but little available for navigation. At its entrance is a port of its own name. Both the town, however, and the stream have recently lost nearly all the advantages of their position, through the establishment of an inter-oceanic railway, which, on the Atlantic side, commences at Aspiuwall, about 8 miles to the north.

CHAIN, in Surveying (called Gunter's Chain, from its inventor), is a measure of 22 yards long, composed of 100 iron links, each of which is thus 7·92 inches long. As an acre contains 4840 square yards, 10 square chains ($22 \times 22 \times 10 = 4840$ square yards), or 100,000 square links, make an acre.

CHAIN-BRIDGE. See **SUSPENSION BRIDGE**.

CHAIN-CABLE. See **CABLE**.

CHAIN-MAIL, or **CHAIN-ARMOUR**, much used in the 12th and 13th centuries, consisted of hammered iron links, connected one to another into the form of a garment. Such armour was much more flexible and convenient to the wearer than that which was formed of steel or brass plates, but was less fitted to bear the thrust of a lance.

CHAIN-SHOT, chiefly used in naval warfare, are very destructive missiles, consisting of two balls connected by a piece of chain eight or ten inches in

length. All is fired collectively from the gun, and the chain enables the balls to catch and destroy objects which otherwise might possibly escape.

CHAINS, on shipboard, are strong iron links or plates, bolted at the lower end to the ship-timbers, and having a block or *dead-eye* at the upper end. Their purpose is to fasten down the shrouds tightly. They are brought out laterally at the top by resting in the middle against the channels, which are broad thick planks, very strongly fixed, and projecting horizontally from the side of the ship, one pair for each mast.

CHAINS, HANGING IN. In atrocious cases, it was usual for courts of justice, in former times, to direct the bodies of malefactors, after execution, to be hung in C. upon a gibbet near the spot where the crime was committed; but this, says Blackstone, 'was no part of the legal judgment.' The reasons commonly assigned for the practice are two: first, that it might strike terror into other offenders; and second, that it might afford 'a comfortable sight to the relations and friends of the deceased.' This barbarous adjunct to capital punishment was not finally abolished till a very recent period, and it may surprise our readers to learn that, two years after the passing of the Reform Bill, it was still in accordance with the law, if not with the custom of England. The act 'to abolish the practice of hanging the bodies of criminals in chains' (4 and 5 Will. IV. c. 26), was passed on 25th July 1834. The last case of hanging in C. mentioned as having occurred in Scotland, is that of Andrew Wilson, who poisoned his wife in 1755 (Hume, vol. ii, p. 482). See **PUNISHMENTS** and **DISSECTION**.

CHALA'ZA, in Botany, a membrane which unites the nucleus and integuments at the base of an ovule. It is traversed by vessels which supply nourishment to the ovule. It is often of a different colour from the rest of the integuments, and is conspicuous in the ripened seed; but it is sometimes difficult to distinguish it, particularly in *orthotropal* seeds, when it is in contact with the *hilum*, the *foramen* or *micropyle* being at the opposite extremity of the seed. See **OVULE** and **SEED**.

The cords which bind the yolk-bag of an egg to the lining membrane at the two ends of the shell, and keep it near the middle as it floats in the albumen, are also called *chalazae*. They appear to be formed of a peculiarly viscid albumen.

CHALCEDON, a city of ancient Bithynia, at the entrance of the Buxine, opposite to Byzantium. It was founded 684 B.C. by a colony from Megara, and soon became a place of considerable trade and importance. It contained several temples, one of which, dedicated to Apollo, had an oracle. C. was taken by the Persians, suffered the vicissitudes of war during the strife for Grecian supremacy between the Athenians and Lacedæmonians, and finally merged into the Roman empire. During the Mithridatic war, it was the scene of a bold exploit of the Pontic sovereign. Having invaded Bithynia, all the wealthy Romans in the district fled for refuge to C., whereupon he broke the chains that protected the port, burned four ships, and towed away the remaining sixty. Under the empire it was made a free city, and was the scene of a general council, held 451 A.D. Chosroes the Persian captured it 616 A.D., after which it declined, until it was finally demolished by the Turks, who used its ruins to build mosques and other edifices at Constantinople. C. was the birthplace of the philosopher Xenocrates.

The *council* of C., to which allusion has been made, was the fourth universal council, and was assembled by the emperor Marcian for the purpose of drawing up a form of doctrine in regard to the nature of

CHALCEDONY—CHALEUR BAY.

Christ, which should equally avoid the errors of the Nestorians (q. v.) and Monophysites (q. v.). Six hundred bishops, almost all of the Eastern or Greek Church, were present. The doctrine declared to be orthodox was, that in Christ there were two natures, which could not be intermixed (this clause was directed against the Monophysites), and which also were not in entire separation (this was directed against the Nestorians), but which were so conjoined, that their union destroyed neither the peculiarity of each nature, nor the oneness of Christ's person.

CHALCEDONY (often misspelled *Calcedony*), a beautiful mineral of the quartz family, or rather a variety of quartz, from which it does not differ in chemical composition or in any essential character. It derives its name from Chalcedon in Bithynia, near which it is found in considerable abundance, and has been known by the same name from ancient times. It occurs in different kinds of rock, but most frequently in old lavas and trap-rocks, and is found in almost all parts of the world where these exist, or where there are boulders derived from them. It is common in Scotland, and specimens of great beauty are brought from Iceland and the Farøe Islands. It never occurs in crystals. It constitutes the whole or the principal part of many agates. It is generally translucent, sometimes semi-transparent, has not much lustre, and is in colour generally white or bluish white, sometimes reddish white, sometimes milk-white, less frequently gray, blue, green, yellow, brown, or even black. Its fracture is even, or very slightly conchoidal.—C. is much used in jewellery, for brooches, necklaces, and ornaments of all sorts, the largest pieces being sometimes made into little boxes, cups, &c. It was much used by the ancients, and many beautiful engraved specimens appear in antiquarian collections. Chalcedonies with disseminated spots of brown and red, were once very highly prized, and were called *Stigmities* or *St Stephen's-stones*. Petrified plants are sometimes found in C., in which they appear to have been encased whilst it was in course of formation. Specimens of C. are sometimes found enclosing a little water in the interior, which gives them a very beautiful appearance; but the water easily escapes, to prevent which, rings or other ornaments made of such stones are kept in distilled water, when not worn. The ancients set a very high value on these *emhydrites* (Gr. *en*, in, and *hydor*, water). The Vicentin was celebrated for producing them.

CHALCEDONYX (or, erroneously, *Calcedonyx*), a name given to agates formed of cacholong, or a white opaque chalcedony, alternating with a grayish translucent chalcedony.

CHALCIS, the capital town of the island and government of Eubœa, Greece, situated on the Euripus, a strait separating the island from Bœotia, and which at this point is only 120 feet wide. The Euripus is divided into two channels, of unequal breadth and depth, by a rock, which is surmounted by a castle, partly of Venetian and partly of Turkish construction. A stone bridge, of some 70 feet in length, connects the rock with the Bœotian shore, while a wooden and movable bridge, of about 35 feet, unites it with Chalcis. C. is a place of very great antiquity, having been founded, as tradition asserts, before the Trojan war, by an Ionian colony from Athens. Its rise was rapid. It sent out numerous colonies, and was the centre of the trade of the western Mediterranean. Governed at first by an aristocracy, it fell into the hands of the Athenians, who in 506 B. C. divided the lands of C. amongst some of their own number. It subsequently fell under the power of the Macedonians

and Romans, and was at this time a place of great military importance, nearly 9 miles in circumference, and had many fine temples, theatres, and other public buildings. Aristotle died at Chalcis. In the middle ages, it was prosperous under the Venetians, who held it for nearly three centuries, until its conquest by the Turks in 1470. The Lion of St Mark is, or was until within recent years, still to be seen over the gateway between the bridge and the citadel. Not many ancient remains now exist at Chalcis. The streets are narrow, but the houses, many of which owe their origin to the Venetians, are substantial and spacious. Pop. 5000.

CHALCIS, a genus of Saurian reptiles, the type of a family called *Chalcidæ*, some of which are popularly termed snake-lizards, because of the resemblance to snakes in the elongated form of the body, the limbs being also remarkably small, so that this family forms one of the transition links between the Saurian and the Ophidian reptiles. The scales are rectangular, and arranged in transverse bands, without being imbricated or disposed like tiles. The *Chalcidæ* are natives of warm climates, both in the old and new worlds.

The name C. has also been bestowed on a genus of the order *Hymenoptera*, allied to the Ichneumons, which has become the type of a tribe or family, containing a vast number of species—1500 being supposed to exist in Britain—all of them of small size, many very minute, many of them very brilliant in their colours, and the larvæ of all of them parasitic in the larvæ or pupæ, some even in the

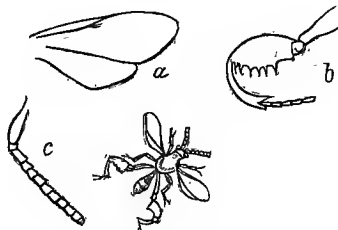

Chalcis Claripes,

One of the largest British species:

a, the wings of one side, magnified (very destitute of nervures);
b, hind-leg, magnified; *c*, antenna, magnified.

eggs, of other insects. The chrysalis of a butterfly or moth often nourishes a great number of these parasites; and they become useful in preventing the excessive multiplication of species which destroy valuable plants.

CHALCOGRAPHY, a pedantic term used to signify engraving on copper, compounded of the Greek words *chalkos*, brass or copper, and *grapho*, I write. The term is inaccurate when applied, as it often is, to engraving on other metals, such as steel and zinc. For zinc-engraving, the still more objectionable word *Zincography* has been invented.

CHALDÆA. See **BABYLON**, **BABYLONIA**.

CHALDEE. See **ARAMÆA**.

CHALDER, an old Scotch dry measure, containing 16 bolls. See **BOLL**.

CHALDRON (Lat. *caldarium*, a vessel for warm water), an old dry measure used in selling coal, and containing 36 heaped bushels. Coal is now sold by weight.

CHALEUR BAY, an inlet of the Gulf of St Lawrence, between Gaspé, a district of Lower Canada, and New Brunswick, having a depth of 90 miles from east to west, and a width varying from

12 to 20. The Ristigouche, which enters the gulf from New Brunswick at its very head, marks, at its mouth, the inter-provincial boundary.



Chalice :

Found in a Stone Coffin of the 12th century in Winchester Cathedral.—Copied from Parker's *Glossary of Architecture*.

CHALICE (Lat. *calix*, a cup). This ancient name for an ordinary drinking-cup has been retained for the vessels used for the wine in the holy sacrament. Chalices are commonly made of silver, but it was not unusual for them to be of gold, or gilt and jewelled. Chalices were also made of glass, crystal, and agate; but these substances have been abandoned, in consequence of their fragile nature. The C. is the attribute of St John the Evangelist.

CHALK, a soft earthy variety of limestone or carbonate of lime, forming great strata, and claiming the attention of the geologist even more than of the mineralogist. It is generally of a yellowish-white colour, but sometimes snow-white. It is easily broken, and has an earthy fracture, is rough and very meagre to the touch, and adheres slightly to the tongue. It generally contains a little silica, alumina, or magnesia, sometimes all of these. Although often very soft and earthy, it is sometimes so compact that it can be used as a building-stone; and it is used for this purpose either in a rough state, or sawn into blocks of proper shape and size. It is burned into quicklime, and nearly all the houses in London are cemented with mortar so procured. The silicious particles being separated by pounding and diffusing in water, it becomes whiting, of which the domestic uses are familiar to every one. Carpenters and others use it for making marks, which are easily effaced: the *black-board* and piece of C. are now common equally in the lecture-rooms of universities and in the humblest village-schools. C., perfectly purified, is mixed with vegetable colouring matters, such as turmeric, litmus, saffron, and sap-green, to form pastil colours; but vegetable colours which contain an acid are changed by it. See **CRAYON**. The *Vienna white* of artists is simply purified chalk. In a perfectly purified state, it is administered as a medicine, to correct acidity in the stomach. C. is also extensively used as a manure. See **LIME**, as a manure.

CHALK, BLACK, is a mineral quite different from common chalk, and apparently receives its name from resembling it in meagreness to the touch, in soiling the fingers, and in being used for drawing, writing, &c. It is also called **DRAWING-SLATE**. It is of a slaty structure, of a bluish or grayish-black colour, easily cut and broken, and makes a perfectly black mark on paper. It is used for drawing, and as a black colour in painting. It becomes red by exposure to heat. It is essentially a kind of clay (q. v.), and derives its colour from carbon, which it contains. It is found in primitive mountains, in Spain, France, Italy, &c., also in the coal formation in Scotland.—**BRIANÇON CHALK** and **FRENCH CHALK** are popular names for Soapstone (q. v.).—**RED CHALK** is *Ochry Red Clay-iron-ore*, consisting of clay and much peroxide of iron. It is of a brownish-red colour, and a somewhat slaty structure, the cross fracture earthy. The coarser varieties are used chiefly by carpenters for making marks on wood; the finer, by painters. It occurs in thin beds in clay-slate and grauwacke-slate in some parts of Germany.

CHALK-BEDS. See **CRETACEOUS SYSTEM**.

CHALKING THE DOOR, a mode of warning tenants to remove from burghal tenements, long known and still in use in Scotland. The practice is thus described by Mr Hunter in his valuable work on Landlord and Tenant: 'A burgh-officer, in presence of witnesses, chalks the most patent door forty days before Whitsunday, which is held to be a legal warning. There is no execution at the parish church, but the officer makes out an execution of 'chalking,' in which his name must be inserted, and which must be subscribed by himself and two witnesses. This ceremony now proceeds simply on the verbal order of the proprietor, but anciently the interposition of a judge was requisite. In such a case, authority was given by one of the magistrates to the burgh-officer.' That judicial authority is still assumed to lie at the root of the proceeding, is apparent from the fact, that the execution bears that the warning has been executed in her Majesty's name and authority, and that of the magistrates of the burgh. The officer ought to notify to the tenant the object of his visit, though it is not perhaps indispensable that he should do so. The execution of chalking is a warrant under which decree of removal will be pronounced by the burgh-court, in virtue of which the tenant may be ejected on the expiration of a charge of six days. See **EJECTMENT**.

CHALKY ISLAND, in New Zealand, near the south-west extremity of Middle Island, about lat. 46° S., and long. 166° 20' E. It takes its name from being composed of a mass of white limestone, and imparts the same to the adjacent bay of 16 miles in length, and also to one of the harbours of the inlet.

CHALLENGE. See **DUEL**.

CHALLENGE. See **JURY**.

CHALMERS, GEORGE, an eminent historical antiquary, was born at Fochabers, Morayshire, Scotland, in 1742. Having attended King's College, Aberdeen, and afterwards studied law at Edinburgh, he went in 1763 to North America, where he practised as a lawyer till the breaking out of the war of independence. Being a keen loyalist, he returned to Britain, where he was appointed clerk to the Board of Trade in 1786. The duties of this office he continued to discharge with diligence and ability till his death in 1825. Before his appointment, he had distinguished himself by various publications in political economy; and for some time after he devoted himself chiefly to editing the works of various authors and writing biographies. His great work is his *Caledonia; an Account, Historical and Topographical, of North Britain*; a production displaying profound research into the history of Scotland, and abounding in varied erudition. It was intended to be completed in 4 vols. 4to. The first volume, containing the historical part, appeared in 1807; of the other three, which were destined to give an account of the several counties, the second, embracing Roxburghshire, Berwickshire, Haddingtonshire, Edinburghshire, Linlithgowshire, Peeblesshire, and Selkirkshire, appeared in 1810; the third, containing the counties of Dumfries, Kirkcudbright, Wigton, Ayr, Lanark, Renfrew, and Dumbarton, appeared in 1824. A fourth volume is understood to have been left at his death, ready for the press.

Among his other publications are: *Political Annals of the United Colonies* (Lond. 1780); *On the Comparative Strength of Great Britain, during the present and the four preceding Reigns* (Lond. 1782, 1786, 1794, 1802, 1812); *A Collection of Treaties between Great Britain and other Powers* (2 vols., Lond. 1790); *Life of Daniel Defoe* (Lond. 1786);

Life of Thomas Ruddiman (1794); *Life of Mary Queen of Scots* (Lond. 1818); editions of the works of Allan Ramsay (1800), and of Sir David Lindsay (1806), with memoirs; also various pamphlets apologising for those, himself included, who had believed in the authenticity of the Shakspeare manuscripts forged by Mr Ireland.

CHALMERS, THOMAS, D.D., LL.D., was born at Anstruther, in Fifeshire, 17th March 1780, educated at the university of St Andrews, and in his 19th year licensed to preach the gospel. In 1803 he was ordained minister of the parish of Kilmarnock, in Fifeshire, about 9 miles from St Andrews. At this period, his attention was entirely absorbed by mathematics and natural philosophy, to the neglect of the studies appertaining to his profession. To gratify his love of scientific pursuits, he even formed mathematical and chemistry classes in St Andrews during the winter of 1803—1804, and by his wonderful enthusiasm and lucidity of exposition excited intense interest, and obtained for himself a great reputation. In 1808 he published an *Inquiry into the Extent and Stability of National Resources*, which proved his capacity for dealing with questions of political economy. Shortly after this, certain domestic calamities, and a severe illness of his own, opened up the fountains of his soul, and rendered him keenly susceptible to religious impressions. Having to prepare an article on Christianity for Brewster's *Edinburgh Encyclopædia*, he commenced an extensive study of the evidences, and rose from his investigations convinced that Christianity was a fact, and the Bible the veritable 'word of God.' Then the great genius of the man broke forth like sunshine. He grew earnest, eloquent, devout, and faithful to his pastoral duties. In July 1815, he was translated to the Tron Church and parish, Glasgow, where his magnificent oratory took the city by storm. His *Astronomical Discourses* were probably the most sublimely intellectual and imaginative that had ever been preached in a Scottish pulpit. They were published in 1817, and had a prodigious popularity. During the same year he visited London, where his preaching excited as great a sensation as at home. But C.'s energies could not be exhausted by mere oratory. Discovering that his parish was in a state of great ignorance and immorality, he began to devise a scheme for overtaking and checking the alarming evil. It seemed to him that the only means by which this could be accomplished was by 'revivifying, remodelling, and extending the old parochial economy of Scotland,' which had proved so fruitful of good in the rural parishes. In order to wrestle more closely with the ignorance and vice of Glasgow, C., in 1819, became minister of St John's parish, 'the population of which was made up principally of weavers, labourers, factory-workers, and other operatives.' 'Of its 2000 families,' says Dr Hanna, 'more than 800 had no connection with any Christian church, while the number of its uneducated children was countless.' We have not space to narrate at length how vast and successful were the labours of Chalmers. It is sufficient to say, that in pursuance of his favourite plan, he broke up his parish into 25 districts, each of which he placed under separate management, and established two week-day schools, and between 40 and 50 local Sabbath schools, for the instruction of the children of the 'poorer and neglected classes,' more than 1000 of whom attended. In a multitude of other ways he sought to elevate and purify the lives of his parishioners. While in Glasgow, C. had matured his opinions relative to the best method of providing for the poor. He disliked the English system of a 'compulsory assessment,' and preferred the old Scotch method of

voluntary contributions at the church-door, administered by elders. The management of the poor in the parish of St John's was intrusted to his care by the authorities, as an experiment, and in four years he reduced the pauper expenditure from £1400 to £280 per annum.

But such herculean toils began to undermine his constitution, and in 1823 he accepted the offer of the Moral Philosophy chair in St Andrews, where he wrote his treatise on the *Use and Abuse of Literary and Ecclesiastical Endowments* (1827). In the following year, he was transferred to the chair of Theology in Edinburgh, and in 1832 published a work on political economy. In 1833 appeared his Bridgewater treatise, *On the Adaptation of External Nature to the Moral and Intellectual Constitution of Man*. It was received with great favour, and obtained for the author many literary honours; the Royal Society of Edinburgh electing him a fellow, and the French Institute a corresponding member, while the University of Oxford conferred on him the degree of D.C.L. In 1834, he was appointed convener of the Church-extension Committee; and after seven years of enthusiastic labour, announced that upwards of £300,000 had been collected from the nation, and 220 new churches built. Meanwhile, however, troubles were springing up in the bosom of the church itself. The Evangelical party had become predominant in the General Assembly, and came forward as the vindicators of popular rights; the struggles in regard to patronage between them and the 'Moderate' or 'Erastian' party became keener and more frequent, until the decision of the civil courts in the famous 'Auchterarder and Strathbogie' cases brought matters to a crisis; and on the 18th of May 1843, C., followed by 470 clergymen, left the church of his fathers, rather than sacrifice those principles which he believed essential to the purity, honour, and independence of the church. See articles DISRUPTION and FREE CHURCH. The rapid formation and organisation of the Free Church were greatly owing to his indefatigable exertions, in consequence of which he was elected Principal of the Free Church College, and spent the close of his life in the zealous performance of his learned duties, and in perfecting his *Institutes of Theology*. He died suddenly at Morningside, Edinburgh, May 30, 1847.

This is not the place for a criticism on the works of C., which extend to more than 30 vols. It is sufficient to say, that they contain valuable and, in some cases, original contributions to the sciences of natural theology, Christian apologetics, and political economy; while on minor topics, such as the church-establishment question, they exhibit both novelty and ingenuity of argument. As an orator, C. was unique and unrivalled. We read of men, in the history of the Christian church, whom we can believe to have been as eloquent, impassioned, and earnest, but nowhere do we encounter a man in whom intellect, feeling, and imagination were so harmoniously combined—a nature so 'nobly planned, to warn, to comfort, and command.' Scotland never produced a greater or more lovable soul, one more gentle, guileless, genial-hearted, or yet more fervid, from the strength of a resolute and irresistible will, before whose impetuous difficulties were dashed aside as by a torrent. There have been some loftier and more purely original minds in Scotland than C.'s, but there has never been a truer one, nor a heart whose Christian faith and piety were more intense, sincere, and humane.

CHALON-SUR-SAONE, a town of France, in the department of Saone-et-Loire, about 33 miles north of Mâcon. It is situated on the right bank of the

Saone, at the point where that river is joined by the Canal-du-Centre, which unites the Saone with the Loire, and secures C. an extensive traffic with the central districts of France, as well as with the Mediterranean and Atlantic. The town is generally well built, good quays line the river, along which also the finest houses extend. Vineyards, wood, meadows, and cultivated fields surround and add variety and beauty to the situation. Its manufactures include hats, hosiery, vinegar, oil, pottery, jewellery, and imitation pearls; and it has a large trade in the agricultural and other produce of the district. Steam-boats navigate the Saone from C. downwards. Pop. 18,666. C. occupies the site of the ancient *Cabillonum* or *Caballinum*.

CHALONS-SUR-MARNE, a town of France, in the department of Marne, 107 miles east of Paris by railway. It stands on the right bank of the river Marne, which is here crossed by a handsome stone bridge. C. is old; and the houses consist chiefly of timber, lath, and plaster. The situation, however, is agreeable, and the town contains some fine public buildings, the principal of which is the cathedral, in the sanctuary of which there is one of the finest grand altars in France. On the east side of the town there is the splendid *Promenade du Jard*, or park, which covers 19 acres, and the walks of which are shaded by noble trees. In the outskirts of the town are the very extensive Champagne cellars of M. Jaqueson, whose ordinary stock of bottles amounts to between 4,000,000 and 5,000,000, and whose corks alone cost £6000 per annum. C. has manufactures of woollen, cotton, leather, &c., and a considerable trade in grain, hemp, rape-seed oil, and Champagne wine. Pop. 14,000. Previous to the union of Champagne with France in 1284, C. enjoyed a much larger measure of commercial prosperity, and its population numbered about 60,000.

CHALYBÆUS, a genus of birds very closely allied to the Baritahs (q. v.), but having a rather thicker bill, and the nostrils pierced in a broad membranous space. The species are natives of New Guinea, and are birds of the most beautiful plumage, remarkable for the brilliancy of their metallic tints, and particularly for the resemblance to burnished steel, to which they owe their name (Gr. *chalybe*, -ybos, steel). On this account, they are sometimes included under the name of Birds of Paradise; and the skin of *C. paradiscæus*, deprived of its feet, is sold as that of a Bird of Paradise.

CHALYBÆUS, HEINRICH MORITZ, a German philosopher, was born 3d July 1796, at Pfaffroda in Saxony, and educated at the university of Leipsic. After spending some years in teaching, he was appointed in 1839 professor of philosophy in the university of Kiel. His chief works are the *Historische Entwicklung der speculativen Philosophie von Kant bis Hegel* (Dresden, 1836—a translation of this work into English has been executed by the Rev. Alfred Edersheim of Aberdeen), and the *System der speculativen Ethik* (Leip. 1850).

CHALYBÆATE WATERS are those which contain a considerable proportion of iron in solution. They are of two kinds, *Carbonated* and *Sulphated*. The *Carbonated C. W.* contain carbonate of iron (FeO_2CO_2) dissolved in excess of carbonic acid, and may be recognised by forming an ochry deposit of red oxide of iron (Fe_2O_3) on the surface of the stones near the mouths of the springs, owing to the escape of the carbonic acid on exposure to the air. Islington Spa near London, Tunbridge Wells, and Oddy's Saline C. W. at Harrogate, are examples of this class. Where an excess of carbonic acid is present, communicating a sparkling aspect to the water and an acidulous taste, as at Pyrmont, and other places,

the term *acidulo-chalybeate* or *acidulo-ferruginous* is applied. The *Sulphated C. W.* contain sulphate of iron (FeO_2SO_2) dissolved in them, and examples of this class are afforded at the Isle of Wight (the Sand Rock Spring), Vicars Bridge, Moffat, &c. C. W. are characterised by a more or less inky or styptic taste; by becoming of a purplish black tint when infusion of galls or tea, and some varieties of wine, are added; and by giving a pale-blue colour on the addition of a few drops of ferrocyanide of potassium (yellow prussiate of potash). C. W. are of great service in cases of debility, and the *acidulo-carbonated* kind being lighter on the stomach, is generally preferred; but all C. W. are to be avoided in plethoric, febrile, and inflammatory conditions of the system.

CHA'MA, a genus of lamellibranchiate mollusks. The shell consists of two unequal valves, having two hinge-teeth in the one valve, and one in the other. The general form of the shell approaches to orbicular. The shell is generally thick, and is foliated with leaf-like projections, which arise in a somewhat regular manner from its surface; these and the colours of some of the species combining to make them very beautiful. The shells of the *Chamæ* are often called *Clams* or *Clamp*-shells, a name which they share with some of the *Pectens*, *Spondylii*, &c. They are found only in the seas of warm climates, none further north than the Mediterranean. The Linnæan genus *C.* contained many species now removed to other families, but the restricted genus *C.* is the type of a family *Chamæidæ*. Thirty fossil species have been referred to *C.*, four from the Cretaceous period, and twenty-six from the Tertiary.

CHAMADE. See PARLEY.

CHAMÆROPS, a genus of palms, with fan-shaped leaves, less exclusively tropical than palms are in general, and of which one species, *C. humilis*, is the only palm truly indigenous to Europe. It



Chamærops Humilis.

extends as far north as to the neighbourhood of Nice. It is sometimes called the PALMETTO. The flowers are in spathes about 6—8 inches long; the fruit is a triple blackish spongy drupe, which is eaten, as are also the young shoots. This palm is so tolerant of a cold climate, that a specimen has lived in the open air in the Botanic Garden of Edinburgh for more than forty years, with the protection of matting in winter. In its native regions, the leaves are much

CHAMALARI—CHAMBER OF COMMERCE.

used for thatching, and for making brooms, hats, chair-bottoms, &c. They abound in an excellent fibre, which the Arabs mix with camel's hair, and make into tent covers: cordage, and sometimes sailcloth, are made of it in Spain; it is imported into France, and used for making carpets, under the name of *African Hair*. The French in Algeria make paper and pasteboard of it; and it is supposed that it may prove a valuable commercial commodity, as a material for paper-making.—Other species of the genus abundant in India, China, &c., serve similar purposes, and deserve attention in connection with paper.—To this genus belongs also the West Indian palm, which yields the material for chip-hats (see *BRAZILLIAN GRASS*); and the Palmetto (q. v.) of North America is by some botanists referred to it.

CHAMALARI, a peak of the Himalaya between Tibet and Bhotan, in lat. 28° 4' N., and long. 90° E., said to have an elevation of 27,200 feet, or more than 5 miles and a furlong.

CHAMBER, of a piece of artillery, or small arm, is a contracted part of the bore, at the breech end. The C. contains the charge of powder, but is too small to contain the shot or shell. Some of these cavities are spherical, some cylindrical, some conical with a hemispherical termination, and some pear-shaped. Carronades and shell-guns are usually chambered. The charge just fits the C., and the ball or shell comes in contact with it. Chambered guns are more slow to load and fire than those which are not chambered; and therefore the adoption of this form depends very much on the kind of service in which the weapon is to be employed. Its primary use is in kinds of ordnance in which the charge is small compared with the calibre, and in which, consequently, there would be great loss of power unless the charge were confined within a comparatively limited space at the time of the explosion.

CHAMBER-COUNSEL, a barrister or advocate who gives opinions in his own chambers, but does not, or rarely does, plead in court.

CHAMBER OF COMMERCE, a body of merchants and traders, associated for the purpose of promoting the interests of its own members, of the town or district to which the society belongs, and of the community generally, in so far as these have reference to trade and merchandise. Of the means by which these objects are sought to be accomplished, the following may be mentioned as the most prominent: 1. By representing and urging on the legislature the views of their members in mercantile affairs; 2. By aiding in the preparation of legislative measures having reference to trade, such, for example, as the Bankrupt Acts; 3. By collecting statistics bearing upon the staple trade of the district; 4. In some places, by acting as a sort of court of arbitration in mercantile questions; 5. By attaining by combination advantages in trade which might be beyond the reach of individual enterprise.

These institutions are of continental origin, and, like so many others which England has borrowed from that source, were first introduced into Scotland. The oldest C. of C. in France is that of Marseille, which dates from the end of the 14th or commencement of the 15th century. This chamber was invested with very remarkable powers. It shared in the municipal jurisdiction, and in the administration of justice in mercantile questions. It was several times suppressed and re-established, and it was not till 1650 that its powers were fixed, and that it received its ultimate organisation. The second chamber in France was that of Dunkerque, which was established in 1700. The same year a council-general of commerce was instituted at Paris,

which, in addition to six councillors of state, consisted of twelve merchants or traders, delegated by the principal commercial towns of the kingdom, an arrangement which led within the next few years to the formation of chambers of commerce everywhere in France. We thus find that the chamber at Lyon was instituted in 1702, those of Rouen and Toulouse in 1703, of Montpellier in 1704, of Bordeaux in 1705, &c. By an order of council of 30th August 1702, a direct relation was established between these various chambers and the central Council of Commerce. They were authorised to transmit to the Controller-general of Finances memoirs setting forth their views on commercial subjects, and on contemplated measures of the central government which were submitted to them for their opinion. No uniform legislation regulated the election of the members of these chambers or their internal organisation, but it is certain that the agents of the central government possessed the power of entering them and taking part in their deliberations, and it is probable that municipal authorities of the place were usually numbered amongst their members. These chambers were all suppressed by a decree of the National Assembly in 1791, but they were re-established by a consular edict in 1802, which fixed the population of the towns in which they might be established, and the number of their members, who were to be chosen from amongst the merchants who had carried on trade in person for a period of not less than ten years. Sixty of the best known merchants, presided over by the prefect or the maire, were charged to elect the members of these new chambers. They then presented to the government two candidates for the office of member of the general council of commerce, instituted at Paris under the Minister of the Interior. This organisation was again modified in 1832, and still later by the ordonnances of September 1851 and August 1852, by which these bodies are now regulated. In accordance with that decree, the members of these bodies are now elected by the chief merchants of each town chosen for that purpose by the prefect. Their number cannot be less than 9, nor more than 21. They hold office for six years, one-third of their number being renewed every two years, but the members resigning being re-eligible. The functions now assigned to these chambers in France are—to give to the government advice and information on industrial and commercial subjects; to suggest the means of increasing the industry and commerce of their respective districts, or of improving commercial legislation and taxation; to suggest the execution of works requisite for the public service, or which may tend to the increase of trade or commerce, such as the construction of harbours, the deepening of rivers, the formation of railways, and the like. On these and similar subjects, the advice of the chambers, when not volunteered, is demanded by the government. There exist at this moment 47 chambers of commerce in France of the kind which we have described, and in most of the other countries of continental Europe there are similar institutions for the purpose of conveying information and advice to the central government, and making it acquainted with local feelings and interests in commercial matters.

The oldest C. of C. in Great Britain is believed to be that of Glasgow, which was instituted 1st January 1783, and obtained a royal charter, which was registered at Edinburgh on the 31st of the same year. That of Edinburgh was instituted in 1785, and incorporated by royal charter in 1786. The Manchester chamber, since so famous for its exertions in the cause of free-trade, was not established till 1820, and for many years it

continued to be the only institution of the kind in England. In Hull there has been a C. of C. since 1837, but those of Liverpool, Leeds, and Bradford, notwithstanding the great trading and manufacturing interests of these towns, were not established till 1850, in which year, strangely enough, a similar institution was established in South Australia. The annual income of the Manchester chamber is upwards of £600, that of Liverpool about £800, contributed entirely by the subscriptions of members, amounting generally to £1, 1s. a year. The Edinburgh C. of C. now consists of 300 members, comprising a large portion of the bankers, merchants, and manufacturers of Edinburgh and Leith. The fees for admission have been commuted to an entrance-fee of £5, 5s.

CHAMBERLAIN, LORD, or King's C., as he was formerly called, has been one of the principal officers of state from very early times, and for centuries he was an influential member of the government. He has the function of endorsing the king's answer on petitions presented to him, and very often of communicating his majesty's pleasure to parliament and to the council. He was always a member of the council himself, *ex officio*. Though he has long ceased to have any share in the responsibilities of government, the C. is still an officer of very high standing in the royal household. He has control over all the officers and servants of the royal chambers, except those of the bedchamber, over the establishment attached to the Chapel Royal, the physicians, surgeons, and apothecaries of the household. The C. has further the oversight of the Queen's musicians, comedians, trumpeters, messengers, &c.; and all tradesmen and artificers in her service are appointed by him. When the office of Keeper of the Great Wardrobe was abolished in 1782, the duties of providing the state-ropes of the royal family, the household, and officers of state, devolved on the lord chamberlain. All theatres in towns in which a royal palace is situated, require to be licensed by the Lord C., and no new play can be performed anywhere without his licence. All persons desiring to be presented at levees or drawing-rooms, require to send their cards to the Lord C., and it is his duty to see that the persons thus applying are entitled by station and character to be presented to the Queen. The C. also issues her Majesty's invitations to balls, parties, &c. In accordance with ancient custom, the Lord C. is still a member of the Privy Council. His salary is £2000 a year, but his tenure of office depends on that of the political party to which he belongs.

The Vice-chamberlain is the deputy and assistant of the Lord C., and in his absence exercises the full authority which belongs to his principal. His office existed in the time of Richard II. He is also dependent on the administration, and is usually a member of the Privy Council. His salary is £924 per annum.

CHAMBERLAIN, THE LORD GREAT, is quite a different officer from the Lord Chamberlain (q. v.). The Lord Great C. is a hereditary officer of great antiquity, and formerly of great importance. He has the government of the palace at Westminster, and, upon solemn occasions, the keys of Westminster Hall and of the Court of Requests are delivered to him. At these times, the Gentleman Usher of the Black Rod, the Yeoman Usher, and the door-keepers, are under his orders. At coronations, state trials, banquets, and the like, the fitting-up of the Hall devolves on him. When the Queen goes to parliament, he delivers the sword of state to any member of the administration whom he chooses, to be borne before her Majesty, he himself walking

on her right hand. During the sitting of parliament, he has charge of the House of Lords, and issues tickets of admission on the opening or prorogation of parliament. Some fees and perquisites belong to him.

Lord Willoughby d'Eresby and the Marquis of Cholmondeley, are joint-holders of the office, in right of their mothers, the ladies Priscilla Barbara, and Georgiana Charlotte Bertie, sisters and co-heirs of Robert, fourth Duke of Ancaster; and the representatives of the families discharge the duties alternately in each succeeding reign.

CHAMBERS, EPHRAIM, deserves mention here as the compiler of the first English cyclopædia. He was born at Kendal in the latter part of the 17th c., and was an apprentice to a globe-maker in London, when he conceived the idea of his cyclopædia. The first edition of the work, in 2 vols., appeared in 1728; ten years later, the 2d appeared; and in the year following, the 3d. The 4th was issued in 1741, a year after the editor's death. A 5th appeared in 1746, and a 6th, with new matter, in 1750. This work forms the basis of Dr Rees's Cyclopædia in 45 quarto vols., and may be considered as the forerunner of the now countless publications of an encyclopedic character (see *ENCYCLOPÆDIA*). C. was an indefatigable worker, but a man of only very moderate attainments.

CHAMBERS, WILLIAM and ROBERT, the editors and publishers of this *Encyclopædia* and other works; born at Peebles, W. in 1800, R. in 1802. W. C. began business as a bookseller in Edinburgh, 1819. Between 1825 and 1830, he wrote the *Gazetteer of Scotland*, 1 vol.; and the *Book of Scotland*, 1 vol. R. C. also began business as a bookseller in Edinburgh, and from 1823 to 1830, wrote successively the *Traditions of Edinburgh*, 2 vols.; *Popular Rhymes of Scotland*, 1 vol.; *Picture of Scotland*, 2 vols.; and *Histories of Rebellions in Scotland, and Life of James I.*, 5 vols. Next, he edited *Scottish Ballads and Songs*, 3 vols.; and *Biography of Distinguished Scotchmen*, 4 vols. W. C. projected *Chambers's Edinburgh Journal*, and having gained the assistance of his brother, that cheap periodical was commenced on the 4th of February 1832, about six weeks in advance of the *Penny Magazine*. United from this period in the business of publishing, W. and R. C. have issued a series of works designed for popular instruction, and, like the *Journal* (now amounting, in its different series, to 40 vols.), free of any sectarian or political bias. Among these works are *Chambers's Information for the People*, 2 vols.; *Chambers's Educational Course*, about 70 vols.; *Cyclopædia of English Literature*, 2 vols.; *Miscellany of Useful and Entertaining Tracts*, 20 vols.; *Papers for the People*, 12 vols.; and the present *Encyclopædia*. It is proper to say that in conducting these laborious undertakings, they have necessarily depended on a number of accomplished literary assistants. The later productions of W. C. are *Things as they are in America*, 1 vol.; *Slavery and Colour in America*, 1 vol. (both works the result of a visit to the United States in 1853); the *Youth's Companion and Counsellor*, 1 vol.; and pamphlets on *Improved Dwellings and Co-operation among the Working Classes*. R. C. has latterly written a work on *Ancient Sea Margins*, 1 vol., and edited the *Life and Works of Robert Burns*, 4 vols. A collection of his historical works and miscellaneous papers has been issued under the title of *Select Writings of Robert Chambers*, 7 vols. His latest production is *Domestic Annals of Scotland*, 3 vols. The works written or edited by W. and R. C. are printed in connection with their publishing establishment in Edinburgh; their establishment in London, for publishing alone, is conducted by

David N. Chambers, a younger brother, and member of the firm.

CHAMBERS, PRACTICE BEFORE A JUDGE OR VICE-CHANCELLOR AT. It is to applications to the court in *banc* alone that the name of motions is properly given. But there are certain matters of subordinate importance, regarding which applications are made to a single judge at chambers. Practice at C. is of a more summary nature than that in court; but its importance has been increased by the Common-law Procedure Acts, and particularly by 15 and 16 Vict. c. 76, s. 52, authorising a judge at C. to decide upon the sufficiency of pleadings in certain cases.

In the Courts of Equity, incidental matters requiring to be cleared up in order to the completion of decrees, are investigated either by the Master of the Rolls, or by one of the vice-chancellors, sitting at C., or by their clerks as their representatives. By 15 and 16 Vict. c. 18, ss. 28—30, it is provided that this course may be adopted with all such matters as may be more conveniently disposed of at C. than in open court.

CHAMBERS OF AGRICULTURE. The benefits derived from the Chambers of Commerce (q. v.) in France has led to the establishment in that country of similar institutions for the promotion of agriculture. By a law of 20th March 1851, they were placed in most respects on the same footing as the Chambers of Commerce, but a subsequent decree (25th March 1852) deprived them of many of their privileges. At present, each *arrondissement* has a chamber of agriculture, of which the members are named by the prefect, who alone can convoke them, and determine the sphere of their labours. The government is no longer bound, as formerly, to consult them; and having lost the right of communicating directly with the ministry, they stand, for the present, at a great disadvantage as compared with the chambers of commerce. No such institutions exist in this country, though in some respects their functions are performed, in an irregular manner, by our agricultural societies.

CHAMBERY, a town of Savoy, of which it is the capital, beautifully situated in a rich vine-clad valley, between two ridges of hills, about 45 miles west-south-west of Geneva. Though situated at an elevation of nearly 1000 feet above the sea, the climate of C. is mild; the scenery around, with the river Lysse flowing through the valley, is exceedingly fine. The town itself, however, is dull and uninteresting. Some towers and other fragments of the old castle of the Dukes of Savoy, which dates from the 13th c., still remain. C. is celebrated for its manufacture of silk-gauze. It has also manufactures of soap, leather, hats, lace, and a trade in metals and wines. Pop. about 20,000. St Réal and Comte Xavier le Maître were natives of Chambery. From the middle of the 16th c. to the peace of Utrecht, 1713, C. was under the dominion of France; and again from the Revolution to the Congress of Vienna, 1815, when it was restored to the House of Savoy; but in 1860, by the cession of Savoy, it has again come under the rule of France.

CHAMBORD, a celebrated royal castle of France, in the department of Loir-et-Cher, situated in the midst of a vast walled park 21 miles in circumference, about 12 miles east of Blois. Its foundation was laid in 1526, by Francis I., who employed 1800 men constantly in its erection until his death. The work was continued with less zeal by his successors, Henri II., Henri III., Charles IX.; and Louis XIV. and Louis XV. also made some additions to it. The building, which marks the transition between the fortified castle and Italian palace, is

surmounted by a vast number of turrets, minarets, and cones; its most prominent features, however, being six enormous round towers, each 60 feet in diameter. The double spiral staircase in the central tower is of great architectural interest, being so contrived that parties pass up and down without meeting each other. The castle has no less than 440 chambers. C. was the scene of the gallantries of Francis I. Here Henri II., Louis XIII., and Louis XIV. resided; and at one of the brilliant fêtes given at the castle by the latter, Molière performed, for the first time, his play of the *Bourgeois Gentilhomme*. Among the other occupants of C. were Marshal Saxe, Stanislaus, king of Poland, and Marshal Berthier, upon whom it was bestowed by Napoleon I. After his death, it was purchased from his widow by a number of legitimists, and presented to the Duc de Bordeaux.

CHAMBORD (HENRI CHARLES FERDINAND MARIE DIEUDONNÉ D'ARNOIS, DUC DE BORDEAUX), COMTE DE, the representative of the elder branch of the House of Bourbon, and of its claims to the French throne, was born in Paris, September 29, 1820. He is the grandson of Charles X., and the son of the Duke of Berri, who was murdered by Louvel, February 14, 1820. The Duke of Angoulême, Charles X.'s eldest son, being childless, the Duke of Berri was heir-presumptive; and as, at his death, he left only a daughter, the joy was great when, seven months after, his widow gave birth to a prince, who received the title of Duke of Bordeaux—that of Comte de C., by which he has latterly been known, being derived from the Castle of C. (q. v.), presented to him at his baptism. He was baptized amid circumstances of great pomp with water brought by M. de Châteaubriand from the river Jordan, and received the appellation of *l'Enfant du Miracle* ('the Miraculous Child'). When Charles X. abdicated the crown at the revolution in 1830, he did so in favour of his grandson, the Duke of Bordeaux. The people, however, insisted on the 'Citizen King,' and the elder Bourbons were banished. On the death of Charles X., the Duke of Angoulême assumed the title of Louis XIX., and another party proclaimed the Duke of Bordeaux king; but at last a reconciliation was brought about by Prince Metternich. In 1839, the prince visited Italy, accompanied by his mother, and was received by the petty courts with great distinction. After the death of the Duke of Angoulême in 1844, the heads of the different fractions of legitimists met to pay their united homage, and the Duke of Bordeaux made a 'pilgrimage to Belgrave Square' to receive it. In 1846, he married the eldest daughter of the Duke of Modena, who had never acknowledged the monarchy of July. After the revolution of 1848, many legitimists were returned to the National Assembly. In 1850, the Duke of Bordeaux, or Count of C. as he now styles himself, appeared at Wiesbaden, where a congress of his adherents assembled to consult as to their future policy. Here the prince still declared for peace. In truth, all his 'appearances' in public have been weak and effeminate, consisting wholly of pompous drawing-room levees, where those present attempt to forget the 'logic of facts,' and persuade themselves that the Count of C. is a king, and themselves the ornaments of a resuscitated court. As the Count of C. is without heirs, a union, or 'fusion,' as it is called, of the partisans of the elder Bourbons with the Orleanists, came to be much talked of, and was at last effected.

CHAMBRE ARDENTE ('the Fiery Chamber'), a name given at different times in France to an

extraordinary court of justice, probably on account of the severity of the punishments which it awarded, the most common being that of death by fire. In the year 1535, Francis I. established an Inquisitorial Tribunal, and a *Chambre Ardente*. Both were intended for the extirpation of heresy. The former, of which the pope was a corresponding member, searched out, by means of spies, cases of heresy, and instructed the processes; while the latter both pronounced and executed the final judgment. Under Henri II., the activity of the C. A. received a new impulse, the entrance of that monarch into Paris on the 4th July 1549 being signalised by the burning of several heretics. But Francis himself, gallant and gay, as courtly history represents him, also seemed to relish a spectacle of this kind, for on various occasions he and his mistress presided at a burning. By and by, the C. A. relaxed in its penalties, and a cry was got up among the more bigoted Roman Catholics that it was conniving at heresy. This seems to have roused the 'lurking devil' in its members, and in order to wipe away the reproach, they commenced a series of unheard-of cruelties, which, along with other events, contributed to originate the religious war of 1560. In 1679, Louis XIV. employed it for a new and more praiseworthy purpose—viz., to investigate the numerous reports of poisoning cases which the trial of the Marchioness Brinvilliers (q. v.) caused to be circulated. Many persons of the first rank, such as the *Maréchal de Luxembourg*, and the Princess Louise of Savoy, were examined on suspicion, but no one was executed except the pretended sorcerer, Voisin (1680), after whose time the C. A. ended its activity.

CHAMELEON, a southern constellation within the antarctic polar circle, and containing nine stars.

CHAMELEON (*Chamaleo*), a genus of saurian reptiles, constituting a distinct family, of very peculiar form and structure, and on various accounts highly interesting. The body is much compressed; the dorsal line sharp, in some of the species rising into an elevated crest; the back of the head is also elevated into a sort of cone. The neck is very short, and does not admit of the head being turned, for which, however, compensation is found in the remarkable powers of motion possessed by the large prominent eyes, which move independently of one another, and are covered with a membrane pierced only with a small hole for the pupil to look through. There are no external ears. The skin is not covered with scales, but, like shagreen, rough with granules. The legs raise the body rather higher than in most of the saurians; the toes, both of the fore and hind feet, are divided into two sets, one directed forward, and the other backward, so that each foot has the power of grasping like a hand. The tail is long and prehensile. The lungs are very large, and are connected with air-cells that lie among the muscles and beneath the skin, so that the animal has a remarkable power of inflating itself with air. The tongue is remarkably extensible, and is the organ by which the animal seizes the insects which constitute its food, being darted at them with unerring aim, whilst a viscid saliva causes them to adhere to it, and they are carried with it into the mouth. Chameleons are slow in their movements, except those of the eyes and tongue, and remain long fixed in one spot, awaiting the approach of insects, which they seize on their coming within reach. They all live among the branches of trees. Their power of fasting is great, and along with their gulping of air in respiration, and their habit of inflating themselves with air, gave rise to the

fable, current among the ancients and until recent times, of their living on air. Their celebrated power of changing colour is not equally fabulous, and perhaps it would be rash in the present state of knowledge on the subject to assert how far it has been exaggerated. It is probably in part under the control of volition, and may be used, as



Chameleon.

has been asserted, to render the animal less easy of observation, by assimilating it to the colour of surrounding objects; it may depend in part on the action of light; it is certainly connected with the fear and other passions of the creature. Milne Edwards has discovered that it depends upon the presence of two differently coloured layers of pigment in the skin.

Chameleons are natives of the warm parts of the Old World, but are most abundant in Africa. One species is found in some parts of the south of Europe, as near Cadiz. The whole number of known species is small.—When brought, as they frequently are, to Britain, they soon die, apparently because of the coldness of the climate.

The fables which, in former times, were current regarding the C. were extremely numerous and ridiculous. It supplied not a few of those medicines to which absurd credulity ascribed the most marvellous powers.

CHAMFERING. In Architecture, an angle which is slightly pared off, is said to be chamfered. The chamfer is sometimes made slightly concave, in which case it is called a *hollow chamfer*. Chamfers, in Gothic architecture, have frequently ornamental terminations of various kinds. The term C. is applied to wood-work as well as stone.

CHAMIER, FREDERIC, an English novelist, was born in London, 1796. He entered the navy as a midshipman in 1809, and distinguished himself in the American war. He left the service in 1833. The success of *Marryat* in depicting sea-life led C. to try the same field, in which he has not been without success, though in invention and humour he falls short of his model. His best romances are—*Life of a Sailor* (3 vols., Lond. 1834), *Ben Brace* (3 vols., Lond. 1835), *The Arcthusa* (3 vols., Lond. 1836), *Trevor Hastings* (3 vols., 1841), *Passion and Principle* (3 vols., 1843), *Tom Bowline* (3 vols., 1839), *Jack Adams* (3 vols., 1838), &c. All his works have been translated into German. Having been in Paris in February 1848, C. wrote a *Review of the French Revolution of 1848* (Lond. 1849), in which he gives a rather prejudiced view of some of the prominent actors.

CHAMISSO, ADELBERT VON, one of the most celebrated of German lyric poets, was born in 1781,

at the castle of Boncourt, in Champagne. His parents settling in Prussia in 1790, he became a page of the queen, and entered upon a military career. But when the campaign of 1806 broke out, he returned to France, for though no admirer of Napoleon, he was unwilling to fight against his native land. At this time, he was thrown into the circle of Madame de Staël at Coppet, and there began that study of natural philosophy which he afterwards pursued at Berlin. In 1814, Count Rumjanzow, chancellor of the Russian empire, prepared an exploring expedition round the world at his own expense; C. accompanied it as naturalist. He embarked at Cronstadt under Captain Otto von Kotzebue, chief of the expedition, which, however, failed in its main object—that of discovering a *north-east* passage. Subsequently, he obtained a situation in the Botanical Garden of Berlin, was made a member of the Academy of Science; and after a happy domestic life, died there in 1838, universally loved and honoured. He wrote several works on natural history, but his fame rests chiefly on his poetical productions. As early as 1804—1806, he, together with Varnhagen von Ense, published a *Musen Almanach*. In 1813, he wrote his original and amusing fiction called *Peter Schlemihl*, the story of the man who loses his shadow, which has been translated into almost all the languages of Europe. The character of his poetry is wild and gloomy, and he is fond of rugged and horrible subjects. In his political songs, he succeeds well in humour and irony; nor is he deficient in deep and genuine feeling. Indeed, several of his ballads and romances are master-pieces in their way. We may instance one of his longest poems, *Salas y Gomez*, written in terza rima, as a proof how peculiarly German the cast of C.'s mind was, despite his French origin. His collected works, in six volumes, appeared at Leipsic in 1836—1839.

CHA'MOIS (*Antelope rupicapra*, Ger. *Gemse*), a species of antelope (q. v.) inhabiting the Alps and other high mountains of Central and Southern Europe, as the Pyrenees, the Carpathians, and the mountains



Chamois.

of Greece; also those of some of the Mediterranean islands, Caucasus, Taurus, and other mountains of the west of Asia. It is one of the antelopes sometimes designated *capriform* or goatlike, because of their departure from the typical or true antelope form, and approach to that of the goats. The C. is about the size of a large goat, but the neck is longer in proportion, and the body shorter; the horns seldom more than six or seven inches long, black, rising nearly straight up from the forehead,

and so bent back at the tip as to form a hook. The colour is brown, deeper in winter than in summer; the tail is black; the head is of a pale-yellow colour, with a dark-brown band along each cheek.

The usual summer resort of the C. is in the higher regions of the mountains which it inhabits, not far from the snow-line, and it is often to be seen lying on the snow. In winter, it descends to the higher forests. The aromatic and bitter plants of the mountain-pastures are its favourite food. It is—like the ruminants generally—very fond of salt; and many stones are met with in the Alps, hollowed out by the continual licking of the C., on account of the saltpetre with which they abound.' It is gregarious: flocks of one hundred are sometimes seen; but in the Swiss Alps, where the numbers have been much reduced by hunting, the flocks are generally very small, and often consist only of a few individuals. Old males often live solitarily. The C. produces one or two young at a birth, in the month of March or April.

It is an animal of extraordinary agility, and flocks may often be observed sporting in a remarkable manner among the rocky heights. It can leap over ravines of 16 to 18 feet wide; a wall of 14 feet high presents no obstacle to it; and it passes readily up or down precipices which almost no other quadruped could attempt. It is said to descend obliquely almost perpendicular precipices of more than 20 feet, striking its feet once or twice against the rock, as if to stay and guide its descent, and alighting securely, often on a very narrow ridge of rock, with its hind feet first, and bringing the fore feet almost into contact with them.

The hunting of the C. is an occupation attended with great hardships and much danger, but of which, nevertheless, some of the Swiss peasants become passionately fond. The hunter sometimes goes out on the adventurous chase alone; but more frequently several go out together, dividing into parties; and whilst the flock of C. flee from those whose approach they first desery, an opportunity of using the rifle is obtained by their comrades. The scent of the C. is extremely keen; and when by this sense it is apprised of the approach of the hunter, it becomes alarmed and restless until it sees him, upon which it rushes hastily in an opposite direction, and so falls into the ambushade. When a flock of C. is feeding, one is always on the watch, and by a sort of whistle, announces apprehended danger.—The flesh of the C. is highly esteemed. Its skin is made into leather, and from it the original *shammoy*, or *shammey* leather, so much prized for softness and warmth, was obtained, although the name has now become common also to leather prepared from the skins of other animals. See SHAMMOY.—When taken young, the C. is easily tamed.—The C. of the Persian mountains is smaller and of a paler colour than the European variety, and its horns bend from the base.

CHA'MOMILE, or **CA'MOMILE** (*Anthemis*), a genus of plants of the natural order *Compositæ*, sub-order *Corymbifera*, distinguished by imbricated bracts, a scaly conical receptacle, a ray of one row of female florets, those of the disk hermaphrodite, the achenia obscurely four-cornered, and destitute of pappus. The species are annual and perennial herbaceous plants, chiefly natives of Europe and other temperate parts of the world. Several are found in Britain, amongst which is the **COMMON C.** (*A. nobilis*), the most important species of the genus, well known for its medicinal virtues, a perennial plant with a stem about a foot long, procumbent and much branched, each branch terminated by a flower (head of flowers) more than an inch broad, with yellow disk and white ray, the whole

plant intensely bitter and highly aromatic. Its medicinal virtues are ascribed to the essential oil which it contains, *Oil of Chamomile*, which abounds most of all in the involucre. This oil is of a greenish-yellow colour, and is used in the preparation of some medicines. The dried flowers are often administered in the form of an infusion, as a stimulant of the nerves of the abdomen, an alterative and antispasmodic; or are applied to the skin as an anodyne, and on account of their power of promoting absorption and suppuration. The infusion also acts as an emetic, and is often used to assist the action of other emetics. C. flowers find



Chamomile (*Anthemis nobilis*).

a place in the pharmacopœia, and are also amongst the most esteemed of domestic medicines, the plant being extensively cultivated for their sake, and very generally finding a place even in cottage-gardens. Yet they ought to be used with caution, as they have been known to produce congestion in the brain, and are very apt to aggravate any malady of this kind already existing. A double-flowering variety of C. is more generally cultivated than the single, to supply the C. flowers of the shops, the flowers being whiter and more bulky, but it is otherwise rather inferior. C. is easily propagated by parting the roots. It delights in a dry and rather poor soil.—The name WILD C. is given to a very similar plant, also a native of Britain (*Matricaria Chamomilla*), an annual belonging to a genus closely allied to *Anthemis*. It may readily be distinguished by the want of scales on the receptacle. Its medicinal virtues resemble those of common C., and although now disused in Britain, it is in some parts of Europe preferred for internal use, because it is less bitter, less nauseous, and generally milder and more agreeable in its operation.—No small quantity of common C. is illegally used in the manufacture of beer in England, and is imported from Germany for this purpose. Yet this plant is so abundant in some parts of the south of England as to form a principal part of the pasture in sheep-walks, and to fill the whole air with its scent. The other British species of C. (*Anthemis*) are mere weeds; one of them, called Stinking C. (*A. Cotula*), is so acrid as to blister the fingers, if much handled. But the flowers of the Ox-BYE C., or DYER'S C. (*A. tinctoria*), a native of many parts of the continent of Europe, yield a beautiful yellow dye, on account of which the plant is often cultivated.

CHAMOND, St, a town of France, in the department of Loire, situated at the confluence of the Gier and the Ban, about 7 miles north-east of St Etienne, on the railway between that place and Lyon. It is a flourishing well-built town, with extensive manufactures of ribbons and stay-laces. C. has also several silk-mills and numerous iron furnaces and foundries; and extensive coal-mines exist in the vicinity. Pop. 10,100.

CHAMORERIL, a lake of Ladakh or Middle Tibet, in lat. 32° 55' N., and long. 78° 15' E. It lies at a height of 15,000 feet above the sea, on the plateau between the upper waters of the Sutlej and of the Indus, girt by mountains which rise, at some points, 5000 feet above its own level. Though it is beyond the recognised limits of perpetual congelation, yet it freezes only in winter, and is hence supposed to be of great depth. Necessarily receiving much water from the surrounding mountains, it is without any visible outlet—evaporation alone, even at this elevation, appearing to maintain one uniform surface on a length of 15 miles, and a width of 2½.

CHAMOUNI, or CHAMONIX (Lat. *Campus munitus*), is the name of a wild and romantic valley and village among the Alps in Savoy. It lies at a distance from all the high roads, at an elevation of about 3400 feet above the level of the sea, and more than 2000 feet above that of the Lake of Geneva. The valley is about 13 miles long, and about 2 broad, and is traversed by the Arve. It is bounded at the east end by the Col de Balme, over which there is a mule-path to Martigny, in the upper valley of the Rhone, and from the other end issues the road to Geneva, which lies at a distance of 53½ miles from Chamouni. On the north side lies Mont Breven and the chain of the Aiguilles Rouges, and on the south, the giant group of Mont Blanc, from which enormous glaciers or rivers of ice slide down, even in summer, almost to the bottom of the valley. The chief of these glaciers are—the Glacier des Bossons, des Bois, d'Argentière, and du Tour. By ascending to a point called Montanvert, we come upon the upper course of a glacier, where it expands into a great mountain-lake of ice called the Mer de Glace, in which there is a solitary rock or oasis called Le Jardin, about seven acres in extent, and covered with the most beautiful herbage. The excursion to the Jardin is one of the most striking excursions within the range of Chamouni. Until 1741, the valley was almost unknown; the region was considered a wilderness, and known by the name of Les Montagnes Maudites, or 'accursed mountains.' In the above year, it was visited by two Englishmen, Pocock and Wyndham, who ascended as far as Montanvert; and a granite block there still bears the name of the Englishmen's Stone. It was only, however, in 1775 that the attention of travellers was effectually called to it by Saussure and Bourrit. The valley is rich in peculiar plants, and furnishes an aromatic and perfectly white honey. The village of C. owes its origin to the Benedictine convent founded between 1088 and 1099. The population of the village is about 2000, who depend partly upon the strangers who visit the valley, and partly upon the pastures and upon hunting. There are several good hotels, and the best guides are to be found here for the neighbouring Alps. It is from C. that Mont Blanc is usually ascended.

CHAMPAC (*Michelia Champaca*), an Indian tree, possessing great beauty both of foliage and flowers, and much venerated both by Brahmanists and Buddhists. Images of Buddha are made of its wood. Its flowers have a pale-yellow tint, and a

CHAMPAGNE—CHAMPION.

sweet oppressive perfume, much celebrated in the poetry of the Hindus.

CHAMPAGNE, formerly a province of France, now forming the departments of Seine-et-Marne, Aube, Yonne, Haute-Saone, and Ardennes. The province was about 180 miles long by 150 broad, its surface presenting extensive plains with ranges of hills, especially in the north and east. Upon these hills is grown the famous Champagne wine.

In ancient times, C. was known as a part of Gallia, was subjugated by Cæsar, and afterwards was annexed to the kingdom established by the Franks. After the 11th c., it had its own dukes, who were vassals of the French kings. By the marriage of Philippe IV. with Joanna, heiress to the kingdom of Navarre, Champagne, and Brie, C., in 1284, came to the French crown, and was incorporated by Philippe VI. in 1328. During the campaign of 1792, the eastern part, and, in the campaign of 1814, the western part, of C. was the chief arena of warfare.

CHAMPAGNE WINE is the produce of vineyards in the above-mentioned province of Champagne. There are white and red Champagnes; the white is either sparkling or still. Sparkling or effervescent (*mousseux*) C. is the result of a peculiar treatment during fermentation. In December, the wine is racked off, and fined with isinglass, and in March it is bottled and tightly corked. The fermentation being incomplete when the wine is bottled, the carbonic acid gas generated in a confined space dissolves in the wine, and communicates the sparkling property to Champagne. To clear the wine of sediment, the bottles are first placed in a sloping position with the necks downward, so that the sediment may be deposited in the necks of the bottles. When this sediment has been poured off, some portion of a *liqueur* (a solution of sugar-candy in cognac) is added to the wine, and every bottle is filled up with bright clarified wine, and securely re-corked. The effervescence of the wine thus prepared bursts many bottles, in some cases 10 per cent.; and in seasons of early and sudden heat, as many as 20 and 25 per cent. have been burst. Wine-buyers estimate the value of wine according to the breakage, that which breaks most bottles being considered best. Still or non-effervescent C. is first racked off in the March after the vintage. Creaming or slightly effervescent C. (*demi-mousseux*) has more alcohol, but less carbonic acid gas than sparkling Champagne.

The best varieties of this wine are produced at Rheims and Epernay, and generally on a chalky soil. Among white Champagnes of the first class, the best are those of Sillery, which are of a fine amber hue, dry spirituous, and possessing a superior *bouquet*; those of Ay and Mareuil are less spirituous, but are sparkling, with a pleasant bouquet. Other white wines of first class are those of Hautvilliers, Dizy, Epernay, and Pierry.

In the first class of red C., or Montagne, we have the varieties of Verzy, Verzenay, Mailly, St Basle, Bouzy, and Thierry; all having fine colour, clearness, good body, sufficient spirit, and a pleasant *bouquet*. The trade in Champagne wines is chiefly carried on in Rheims, Avise, Epernay, and Chalons-sur-Marne. The cellars in which the vintages are stored are cut out of the calcareous rock. The fact that the sale of C. is very extensive and lucrative, has naturally given rise to adulterations. Sugar, and the juices of pears or gooseberries, or birch-juice, &c., have been used for making spurious Champagne. It may fairly be reckoned that not even a third part of the wine sold for C. in Paris is genuine. The greater part of it is readily manufactured by

simply charging other light wines with carbonic acid gas. Recently, the German purveyors have succeeded in preparing light wines—such as Rhenish, Main, Neckar, Meissner, and Naumburg—so much like genuine C., as to deceive even the connoisseur. Altogether, it is estimated that the district produces 1,100,000 hectolitres (24,200,000 gallons) of genuine C., of which, however, the finest growths make but a small part.

CHAMPARTY, or **CHAMPERTY** (Fr., from Lat. *campi partitio*, a division of lands), an offence known to the law of England, which consists in a bargain between the plaintiff or defendant in a suit, and a third party, generally a lawyer, that the latter shall have part of the land, debt, or other thing sued for, in the event of success, and that in the meantime he shall carry on the suit at his own expense. This practice has been strictly forbidden by statute in England from very early times (3 Edward I., c. 25; 13 Edward I., c. 49; &c.); and in Scotland, the rule of the civil law by which the *pactum de quotâ litis* (q. v.) was held to be a *pactum illicitum* (q. v.), and as such void, has all along been part of the common law. Such practices were also forbidden by statute to members of the College of Justice (1594, c. 216). There is this difference between the laws of the two countries, however, that whereas in England the offence has always been punished criminally, in Scotland, the only penalty which it entails beyond nullity of the bargain, is deprivation of office. In former times, the evil chiefly apprehended from C. probably was, that the honesty of judges might be tampered with by advocates who were generally their friends, and not unfrequently their very near relatives, if permitted to be personally interested in the issue of the causes in which they were professionally employed. In our own day, the chief danger consists in the encouragement which might thus be given to dishonest and oppressive litigation, and the facilities which would be afforded for nefarious transactions between the agents on the opposite sides. That practices closely analogous to C., though unnamed, are not unknown in the lower strata of the legal profession in all countries, is but too probable. The necessities of trade have further introduced considerable equitable modifications into the law of C., which will be explained under **CHOSE IN ACTION**.

CHAMPION (from a Gothic root signifying to contend, fight; Ang.-Sax. *camp*, fight). In the judicial combats of the middle ages, it was allowed to women, children, and aged persons, except in cases of high treason or of parricide, to appear in the lists by a representative. Such a hired combatant was called a champion. Those who followed this profession were generally of the lowest class, and were held disreputable; for besides the perils of the combat, they were liable to be executed as well as their clients. They were obliged to wear a peculiar dress of leather, and peculiar armour, which was also held disreputable. They were not allowed to fight on horseback, and appeared in the lists with their hair and nails cut short. Champions are mentioned as early as in the time of Charlemagne; and Otto I. employed them in deciding the succession to the empire. At a later period, in the age of Chivalry, the word C. came to have a more dignified acceptation, and signified a knight who entered the lists on behalf of an injured lady, of a child, or of any one incapable of self-defence. In England, the crown even had its C., who, mounted on horseback and armed to the teeth, challenged, at every coronation at Westminster, all who should deny the king to be the lawful sovereign of the three realms. This practice is understood to have been

first introduced under Richard II., and it continues to make a part of the ceremonial of an English coronation to this day. The name of C. was also given to the knight who, during a tournament, had charge to see that no injury or insult should be offered to the assembled ladies.

CHAMPLAIN, a lake separating the states of New York and Vermont, and penetrating, at its north end, about six miles into Lower Canada. It empties itself into the St Lawrence, about 45 miles below Montreal, by the Sorel or Richelieu. It is navigable throughout for vessels of about 100 tons, having its communications improved by one canal on its own river, and by another to the Hudson. It stretches in lat. from 43° 30' to 45° 6' N., and in long. from 73° to 73° 30' W.; its extreme breadth, however, never exceeding 15 miles. Its principal towns are Whitehall at the south, Plattsburg on the west, and Burlington on the east. Both Lake C., and its tributary, Lake George, have been prominent in the history of the country—during the rivalry of France and England before the conquest of 1759—1760; during the revolutionary struggle of 1775—1782; and lastly, during the war of 1812—1814, between Great Britain and the United States.

CHAMPOLLION, JEAN FRANÇOIS, an illustrious name in modern Egyptian archæology, was born, December 23, 1790, at Figeac, in the department of Lot, France. In 1801, he was introduced to Baron Fourier, secretary to the *Institut d'Égypte*, who initiated him into the science of Egyptian antiquities. In 1807, C. went to Paris, in order to pursue, with more advantage, his oriental studies; and, in 1809, was appointed professor of history in the Lyceum of Grenoble. In 1811, he published his work, *L'Égypte sous les Pharaons*, intended as the forerunner of a more elaborate work on Egypt, of which only the geographical section appeared, in 1814. In his endeavour to decipher the Rosetta Stone, C. laboured under the error of supposing that in this inscription the hieroglyphics were wholly ideographic, and the demotic and hieratic characters wholly phonetic. Afterwards, he was led to believe that the hieratic characters were of the same nature as the hieroglyphic, and this conviction he expressed in a communication made to the *Académie des Inscriptions*, in August 1821. In the same year he published his essay, *Sur l'Écriture Hiératique des Anciens Égyptiens* (Grenoble), a work which is now scarce. In this essay he continued to assert the common ideographic nature of both hieroglyphic and hieratic characters. Meanwhile C. had been made acquainted with the conclusions of the acute mathematician, Dr Thomas Young (q. v.), respecting the phonetic use of hieroglyphic signs. Without doubt, it was this important discovery, of which Dr Young, however, made no great use, that set C. on the right track of investigation, and led to those brilliant results which were regarded by Niebuhr as constituting the greatest discovery of the century. By a comparison of the name of Ptolemy on the Rosetta Stone with that of Cleopatra on the Philensian obelisk, he was enabled to lay the foundation of an alphabet, which he continued to elaborate until it now forms the basis of modern Egyptian archæology. His first decisive discoveries were made known in his celebrated *Lettre à Mons. Dacier* (Par. 1822), which was followed by the *Précis du Système Hiéroglyphique* (Paris, 1824; second ed. 1828); but his principal work, the *Grammaire Égyptienne*, was posthumously published in 1836.

In 1824, appeared his *Panithéon Égyptien*; and, in 1825, his celebrated letters to the Duc de Blacas,

in which he explains the names and titles of many of the Pharaohs, written on the monuments in Drovetti's Egyptian Collection at Turin, and attempts to class them into dynasties. His theory of *interpretation* was much controverted at first, but its importance was recognised by such distinguished scholars as Rosellini, Bunsen, Sir William Gell, and others.

In 1828 he was appointed by Charles X. to accompany a scientific expedition to Egypt, of which the results were given by Rosellini in the *Monumens de l'Égypte et de la Nubie* (Par. 1835—1845). On his return to Paris, 1830, C. was made a member of the *Académie des Inscriptions*, &c.; and, in the following year, was appointed to the new chair of Egyptian Antiquities in the College of France; but soon after the commencement of his intended course of lectures, in May 1831, he fell ill, and died, March 4, 1832. According to Silvestre de Sacy, 'few men, since the birth of letters, have rendered to erudition services equal to those which have consecrated to immortality the name of Champollion.'

CHAMPOLLION-FIGEAC, JEAN JACQUES, a distinguished French archæologist, was born, 1778, at Figeac, in the department of Lot. After holding in Grenoble the offices of librarian and professor of Greek literature, he was appointed, in 1828, conservator of MSS. in the Imperial Library in Paris; but, after the February revolution, was deposed from office by Carnot. In 1849, he was appointed, by Louis Napoleon, librarian of the palace of Fontainebleau. Beside the *Antiquités de Grenoble* (1807), his chief works include the *Annales des Lagides* and *Égypte Ancienne* (forming a part of *L'Univers Pittoresque*); *Les Tournois du Roi René*, a splendid work, with lithographs by Motte; and several publications of old French documents. Since the death of his younger and more celebrated brother, C. has been employed in editing the MSS. left by that distinguished scholar, and has given an account of them in the *Notice sur les Manuscrits Autographes de Champollion le Jeune* (Par. 1842).

His son, **AIMÉ CHAMPOLLION-FIGEAC**, follows the same path of historical antiquarianism, and has published several interesting useful works.

CHANAK-KALESSI' (Turkish, 'Pot Castle'), a town of Anatolia, deriving its name from its manufactures of crockery, is situated on the Dardanelles, about 28 miles south-west of Gallipoli. Its castle is the most important on the Dardanelles, which name is sometimes given to the town itself. Pop. some 3000 or 4000.

CHANCE, in its original and strict meaning, may be defined as that which determines the course of events, in the absence of law, ordinary causation, or providence. Strictly speaking, it is an idea which few would now be disposed to admit as corresponding to anything which really exists; the religious mind excluding it as inconsistent with the belief in the Divine government, and the philosophical mind rejecting it as inconsistent with a recognition of universal laws of causation. As a word, however, it has always been, and always will be popularly accepted; and its use is correct so far as we overlook, or choose for the moment to throw out of view, the more universal connection of events, and regard them as their emergence, on a superficial view, appears to be determined. The idea of C., as referring to some apparently capricious or at least inexplicable cause of an event, distinguishes it from the word probability, or the degree with which the expectation of an event approves itself to a particular mind, the first expressing what metaphysicians would call an objective, and the second a subjective idea. It is clear that C., being

only legitimate as an expression in popular parlance—or if admitted as a term in philosophy, one that would at once lead into the most inextricable problems—is a term which is much too indefinite to admit of any kind of measurement; while what we call probability, or the degree with which an expectation approves itself, owing to certain data presented to the mind, does, as we shall hereafter see, admit of a kind of measurement which leads to very important consequences. For these reasons, the consideration of what is sometimes called the *Doctrinè of Chances*, but what is more properly the *Theory of Probabilities*, will be found under the head of PROBABILITY.

CHA'NCEL (Fr. ; Lat. *cancellus*, a screen). The C. was, and in some churches is still, separated from the nave by a screen of lattice-work, so as to prevent general access thereto, though not to interrupt either sight or sound. As it was in this part of the C. that the service was always performed previous to the Reformation, the clergy were held to have a special right to it, in return for which its repairs in general still fall on the impropriator, rector, or vicar, and not on the parish. The chief pew in the C. belongs to the rector or impropriator, but the disposal of the seats in the church, with this exception, belongs to the ordinary, or, practically, to the churchwardens, to whom the authority of the ordinary is delegated. No monument, moreover, can be set up without the ordinary's consent. The term C. is usually confined to parish churches which have no aisles around the choir, or chapels behind it or around it; and in this case the C. and the choir have the same signification. But in larger churches there are sometimes chancels at the ends of the side aisles, and this whether the choir has the character of a choir in the larger sense, or of a chancel. See CHURCH.

CHA'NCELLOR (Lat. *cancellarius*). It is said that the chief notary or scribe of the Roman emperor was called C., either because he was intrusted with the power of obliterating, *cancelling*, or *crossing out* (*cancellare*, to make lattice-work) such expressions in the edicts of the prince as seemed to him to be at variance with the laws, or otherwise erroneous; or because he sat *intra cancellos*, within the lattice-work or railings (*cancelli*) which were erected to protect the emperor from the crowding of the people when he sat in judgment. Neither the title nor the office of C. is at all peculiar to England. The C. of France (Chancelier de France), from a very early time, was an officer of state of great power and dignity, under whom several other officers, bearing also the title of C., were employed in the administration of justice and in the defence of the public order. The C. of France was the constitutional interpreter of the will of the sovereign; his functions being, on the whole, analogous to those exercised by the C. of England. As an instance in the change of the value of money, not more remarkable than many which could be cited in our own country, it may be mentioned that, in 1290, the salary of this high official was six sous a day, with the privilege, to him and his, of eating at the court. When he was at Paris, and ate at his own lodgings, he had twenty sous a day. The office was abolished at the Revolution; and though it was restored by the Bourbons, and even under the first Napoleon the higher-sounding title of Archi-chancelier was revived, many of the functions of the old C. were transferred to the minister of justice, and have ever since been held by him.

In most of the other countries of Europe there are officers of state who bear this, or analogous titles,

though their powers and duties are very various. In Austria, Prince Metternich was 'C. of the House, of the Court, and of the State;' and in Prussia, Prince Hardenberg enjoyed a similar title. In Russia, the title of Vice-C. of the Empire is often given to the minister of foreign affairs. Besides these state-chancellors, there were officers in many other capacities to whom the title was given. Every bishop has his C. in the Church of Rome, and there are still Law C. of cathedrals, dioceses, universities, &c.

CHANCELLOR, LORD. There can be no doubt that the existence of the office in England, as in the other states of Europe, is to be ascribed to the influence which the constitution of the Roman empire had on the constitutions of the modern nations. This influence was exercised in no small measure through the medium of the church, the profession of the law being generally exercised by ecclesiastics; and it is for this reason, probably, that the bishop and the king are furnished with officers bearing the same title, and exercising analogous functions. The C. is always the confidential adviser of the sovereign in state affairs. It is for this reason that he has been called the keeper of his conscience, and that in England it is to him alone that can be constitutionally confided the most special function of sovereignty—that, namely, of modifying legal by equitable considerations. It is in this latter prerogative that the chief distinction exists between the C. and all other judges; for, whilst they are held by the letter of the law, he, in theory at all events, is entitled to modify it *juxta bonum et æquum*. In certain more special points of view, there is a similarity between the functions of the chancellors in different states. 'In all of them he seems to have had the supervision of all charters, letters, and such other public instruments of the crown as were authenticated in the most solemn manner; and therefore, when seals came into use, he had always the custody of the sovereign's great seal.'—Stephen's *Commentaries*, vol. iii. p. 398. It is from this last-mentioned circumstance that the office of C., or Keeper (q. v.), which, by 5 Elizabeth, c. 18, is declared to be exactly the same, is created without writ or patent, by the mere delivery of the great seal, and that the C., if a baron, takes precedence of every temporal lord not a member of the royal family, and of all bishops except the Archbishop of Canterbury. The C. is a privy-councillor by his office, a member of the cabinet, and prolocutor, or speaker of the House of Lords, by prescription. Though the form in which his tenure of office is terminated, is by the resumption of the great seal by the sovereign, the C. practically resigns office with the party to which he is attached. He has the appointment of all justices of the peace throughout the kingdom, but this privilege he exercises generally on the recommendation of the lord-lieutenants. But the most important, and, as it now seems, somewhat anomalous branch of his patronage, arises out of his having been originally an ecclesiastic. Though the last bishop who held the office was John Williams, Archbishop of York, who was Lord Keeper from July 10, 1621, to November 1, 1625, the C. still continues to be patron of all the crown livings of the value of £20 per annum, or under, in the King's Books—i. e., according to a valuation made in the time of Henry VIII., and confirmed in that of Elizabeth—and visitor of all hospitals and colleges of the king's foundation. As representing the paternal character of the sovereign, again, the C. is the general guardian of all infants, idiots, and lunatics, and has the supervision of all charitable uses in the kingdom. As regards his judicial patronage, the arrangement is, that the C. appoints in general all the judges of the superior courts, except the two chief-justices, who are

nominated by the prime-minister of the day. Of inferior appointments, the latter also has reserved to him the commissioners of bankruptcy and the judges of the county-courts. All these functions the C. performs in addition to his extensive duties as the supreme judge of the Court of Chancery, both as an ordinary court of common law and of record, and as an extraordinary court of equity. Much inconvenience has arisen from the accumulation of duties in the single person of this high dignity, and various expedients have been devised for lessening the evil. Vice-chancellors have been appointed, and the duties of the Master of the Rolls have been extended. The appointment of a Minister of Justice to share the C.'s duties has often been discussed, but the change is too fundamental to find favour in England; and temporary alleviations of the evil alone are likely to be considered practicable, till it assumes dimensions which render it absolutely intolerable. The salary of the C. is £10,000 a year, and he has an annuity of £5000 on his retirement from office. The style of the C., since the union with Scotland, has been Lord High Chancellor of Great Britain; but he has scarcely any jurisdiction in Scotland, and in Ireland there is a separate C., having powers in most respects the same as those of the C. of Great Britain. To slay the C. is treason under 25 Edward III. c. 2.

CHANCELLOR OF A CATHEDRAL is an officer who superintends the arrangements for the celebration of the religious services. His office is quite distinct from that of the

CHANCELLOR OF A DIOCESE, who, as vicar-general to the bishop, is an ecclesiastical judge, appointed to assist the bishop in questions of ecclesiastical law, and hold his courts for him. By 37 Hen. VIII. c. 17, it is provided that the C. of a diocese may be a layman, whether married or single, provided he be doctor of the civil law, lawfully create and made in some university. By the canons of 1603, he must be a bachelor of law, at the least, or a master of arts. There are certain cases, however, in which the bishop must sit in person. In case of complaint against a clerk in holy orders, for any ecclesiastical offence against the Church Discipline Act (3 and 4 Vict. c. 86), the bishop is to hear the cause, assisted by three assessors; of whom the dean of his cathedral, or one of his archdeacons, or his chancellor, must be one; and a serjeant-at-law, or an advocate who has practised five years in the court of the archbishop of the province, or a barrister of seven years' standing, another.

CHANCELLOR OF A UNIVERSITY. The highest honorary office connected with a university is generally that of chancellor. See UNIVERSITY.

CHANCELLOR OF SCOTLAND. Previous to the union of the two kingdoms in 1707, when the office was abolished, the C. of S. performed functions in many respects analogous to those which belong to the Lord High Chancellor of Great Britain. He presided in parliament, and was the head of all the courts of judicature; he was the chief counsellor of the king, and keeper of the great seal. From the fact of the distinction between law and equity in the English sense never having been recognised in Scotland, the C. had no judicial functions separate from those of the ordinary courts of law, but he had the principal direction of the Chancery, the constitution of which is described below. In early times, the C. of S., as of England, was very frequently an ecclesiastic; but the first, Constantine, Earl of Fife, in the reign of Alexander I., and the last, the Earl of Seafield, who held the office at the Union, were both laymen; and many other nobles, Earls of Argyle, Angus, Huntly, &c., appear

in the lists given in Crawford's *Officers of State*, and Chalmers's *Caledonia*. On the abolition of the office, a Keeper of the Great Seal was appointed, who acts merely ministerially in affixing it to the writs which pass under it. See GREAT SEAL.

CHANCELLOR OF THE EXCHEQUER. See EXCHEQUER.

CHANCE-MEDLEY, AND CHAND-MEDLEY, OR MELLE (Fr. *chaud*, hot; and *mêlée*, a fray), as it is called in Scotland, are French expressions borrowed by our law. Though often spoken of as synonymous, they are, in reality, distinct in meaning—the one signifying a casual affray; the other, an affray in the heat of blood or passion. Both are in this country, and in most others, recognised as pleas in mitigation of the offence of homicide (q. v.). See also SANCTUARY.

CHA'NCERY (Lat. *cancellaria*). As the Roman emperors, and after them the various sovereigns who divided the vast inheritance of the empire, had each a Chancellor (q. v.), so in every European kingdom there was an establishment called a C., where these officers performed their functions. If we imagine a large chamber divided by lattice-work (*cancelli*), the outer half devoted to the people, the inner occupied by the chancellor and his subordinates, engaged in framing edicts, letters of nobility, and the like, and engrossing them on parchment, and sealing them with the king's own seal in proof of their authenticity, and then handing them through the railings to the people without, we shall have a pretty good conception of the C. in its earliest form.

In France, as there were subordinate chancellors attached to the parliaments of the respective provinces, so there were subordinate chanceries; but the grand C. of France, which followed the person of the king, was alone, in strictness, entitled to the name.

The apostolic C. at Rome, in which, in addition to the documents pertaining to his temporal sovereignty, the bulls and briefs of the pope are authenticated, is presided over by a cardinal, with the title of Vice-chancellor.

CHANCERY, OR CHA'NCELLARY, of Scotland, is a public office in the General Register House, at Edinburgh, managed by the director of C. and his deputies, in which all charters, patents of dignities, gifts of offices, remissions, legitimations, presentations, commissions, brieves, retours, and other writs appointed to pass the great and quarter seals, are recorded. See GREAT SEAL.

CHANCERY, COURT OF, IN ENGLAND. Besides the functions pertaining to the chancellor in other countries, the Chancellor of England had early assigned to him the office of a judge; and the English C. consequently became a court of law, the peculiar character of which will be rendered intelligible by the following considerations: In assigning judicial functions to the chancellor's department, it was not intended that it should interfere with that other department of government which has everywhere been distinguished both from the legislative and the executive—viz., the judicial. But in all departments, according to the imperial theory from which the idea of the C. at least was derived, the sovereign was supreme, and to his will, or to his sense of justice, there was consequently an appeal in judicial, as in other matters. His chancellor, however, was his adviser in all matters whatsoever; and thus, though not a judge in the stricter sense, it is manifest that his counsel, in judicial matters of the highest importance, would constantly be called in. But further, the king governed by laws, even before he was governed by them; and for the sake of order and his own convenience, he would naturally depart

from the letter of the law which he had established, only where it could be shewn to him that it did not meet the substantial justice of the particular case. He would consequently be a judge, not of the interpretation or application of the law, which he would leave to his ordinary judges, but of its adequacy to circumstances which had changed, or had not been anticipated; and when he interfered, it would be to some extent in the character of a legislator, as well as of a judge. The king would thus be a judge in equity, in the popular and intelligible sense of that word; and acting in this capacity himself, it would be in this capacity that he would call in the aid of his chancellor. It is not mysterious, then, how in early times the Court of C. came to be a court of equity; and the chief difficulty regarding its origin seems to attach to the other of the two great departments into which it is divided, and in which it exercises jurisdiction as a court of common law. But as the free constitution of England developed itself, it soon became apparent that equity, in the old despotic or patriarchal sense—in which it was not so much the administration as the making or modifying of law—was inconsistent with its principles, whether it proceeded from a judge or from the monarch himself. The popular sense of equity was consequently abandoned; and a technical sense, unknown to the jurisprudence of every other nation, was given to it. The proceedings of the Court of C. 'on its equity side,' which had hitherto been a mere interference with law, came now to be hedged in, by rules and precedents as closely as those of any court of common law. What henceforth continued to be the distinction *in principle* between law and equity, or between the functions of the courts of common law and the Court of C., or even of the two great departments of this court itself, it is perhaps impossible to state. The arbitrary line which has been drawn between the class of cases assigned to the one set of courts and to the other, will be considered under EQUITY.

The judicial duties of the chancellor have long been shared by the Master of the Rolls, an officer of high rank, who was originally appointed only for the superintendence of the writs and records appertaining to the common-law departments of the court, but who was accustomed also to sit as a separate though subordinate judge on the equity side. The disputes which had arisen regarding his powers were set at rest by 3 Geo. II. c. 30, which declares that all orders made by him, except such as by the course of the court are appropriated to the great seal alone, shall be valid, subject nevertheless to be discharged or altered by the Lord Chancellor, and so as that they shall not be enrolled till they are signed by his lordship. By 3 and 4 Will. IV. c. 94, the master's powers are further increased, and he may now hear motions, pleas, and demurrers, as well as causes generally. The salary of the Master of the Rolls (q. v.) is £6000 a year. The vast increase of business, and the still greater increase of arrears, during the previous half-century, rendered it necessary, in 1813 (53 Geo. III. c. 24), to appoint another assistant to the chancellor, under the title of the Vice-chancellor of England; and in 1841, when the equity business of the Exchequer was transferred to the C., two more vice-chancellors were added. Each of these judges sits separately from the Lord Chancellor, and their functions extend to both departments of the court. Their salaries are £5000 a year. The last important addition (14 and 15 Vict. c. 83) has been that of the lords justices of the Court of Appeal in Chancery. This court consists of the Lord Chancellor, together with these judges; but the lords justices, when sitting without the chancellor, possess the same jurisdiction which

belongs to him, and their existence does not prejudice his right to sit alone. The lords justices possess the same authority in matters of lunacy as the chancellor; and they, sitting together, constitute, without the chancellor, the Court of Appeal in Bankruptcy. An appeal, which may also be entertained by the Lord Chancellor sitting alone, lies to this court, from the Master of the Rolls, and from each of the vice-chancellors; and from these appellate jurisdictions there is an appeal in turn to the House of Lords. The lords justices may also take up original causes, though these, in practice, are mainly confined to the vice-chancellors and the Master of the Rolls. Till recently, certain parts of the equitable jurisdiction of the Court of C. were confided to the Masters in Ordinary (see MASTERS IN CHANCERY) and the Accountant-general. The office of the masters has been abolished, but that of the accountant continues to be one of the most important connected with the court. Besides these more important officers, the Court of C. has always had a large body of subordinates, registrars, taxing-masters, and a staff of record and writ clerks attached to it.

To the common-law jurisdiction of the Court of C. belong all matters by and against the crown, which are not, as matters of revenue, cognizable in the Court of Exchequer; and from it issue all writs of *habeas corpus*, *certiorari*, *prohibition*, and also the commissions of the peace. The Courts of C. have no fixed situation. On the first day of term, they meet at Westminster; and afterwards the courts of the chancellor, the lords justices, and the vice-chancellors, meet in Lincoln's Inn; that of the Master of the Rolls at the Rolls in Chancery Lane.

The Courts of C. of the counties palatine of Lancaster and Durham, and the Court of C. in Ireland, dispense the same equity, within the limits of their respective jurisdictions, as the High Court of Chancery. The appeal from the Lancaster Court is to the lords justices. From the chancellor's decree, or that of the lords justices, it is immediate to the House of Lords.

In various colonies of the British empire, local courts have been established in imitation of the High Court of C., an institution which, from its cumbersome, anomalous, and unscientific character, scarcely merited imitation; but in America, though the distinction between law and equity was at first adopted and long adhered to with the tenacity with which Englishmen cling to their native customs, it has been abolished in the state of New York, and law and equity there, as elsewhere in the world, now constitute one system, administered in one series of tribunals of original and appellate jurisdiction. On the continent, the English Court of C. has always been a subject of ridicule; and a recent French writer, in speaking of it, says: 'Nothing ever comes to an end in it; and the unhappy man who has a process there, can be sure of but one thing—viz., that whether he gains it or loses it, his ruin is certain.' The acts by which evils which are inseparable from the constitution of the Court of C.—and which spring from the distinction between law and equity, on which its very existence depends—have been mitigated, are the following—15 and 16 Vict. c. 80, 86, and 87, November 1, 1852; and 21 and 22 Vict. c. 27.

CHANCERY. See SYPHILIS.

CHANDERNAGORE, a French city, with a scanty territory of about 2000 acres, on the right or west bank of the Hoogly, 21 miles above Calcutta by railway, on the opposite shore, in lat. 22° 50' N., and long. 88° 23' E. The population, estimated at

32,670, consists of 218 Europeans, 435 Eurasians (q. v.), and 32,017 natives of unmixed blood. Independently of political considerations, the place has, through the gradual silting up of the river, lost some of its commercial advantages. Within 100 years back, ships of the line ascended to C.; now, however, vessels even of far inferior burden seldom get above Diamond Harbour, which is nearly 50 miles further down. C. was established in 1676, and for awhile rivalled Calcutta. It was captured by Clive in 1757, but finally restored to the French in 1816.

CHANDLER, DR RICHARD, a scholar and antiquary of considerable eminence of the last century, was born at Elson, in Hampshire, in 1738, and educated at Oxford. He first became known as the editor of the magnificent work, *Marmora Oxoniensia*, published by the Oxford University in 1763. He afterwards travelled through Greece and Asia Minor, with Revett, an architect, and Pars, a painter, at the instance of the then flourishing Dilettanti Society, with a view to collect information regarding the former state of these countries, and to procure exact descriptions of the ruins. The result of their united labours appeared in 1769, in 2 vols., entitled *Ionian Antiquities*. C. also published a valuable account of the ancient inscriptions of Asia Minor and Greece; and his account of his travels in these countries, issued in 1775—1776, is still a standard work. He also published a *History of Troy*. He died in February 1810.

CHANDORE, a town and fort in the district of Ahmednuggar, presidency of Bombay, the lat. and long. being 20° 20' N. and 74° 14' E. The town is a flourishing place, with a population of 7000. The fort, which commands an important pass on the route between Candesh and Bombay, is situated on the summit of a hill naturally inaccessible everywhere but at the gateway. It surrendered to the British in 1804; and being subsequently restored to Holkar, was finally ceded by him in 1818.

CHANDOS CLAUSE. During the discussion of the clauses of the Reform Bill (q. v.) in 1831, the Marquis of Chandos (Tory), afterwards Duke of Buckingham, proposed the insertion of a clause giving the county franchise to *tenants at will* paying an annual rent of £50. This was opposed by the ministers on the ground that the class proposed to be enfranchised would be subject to the coercion of the landowners, who would thus virtually determine the elections. The amendment, however, was supported by many of the Radicals, who at that time regarded any extension of the suffrage as a boon, and was carried by a majority of 84. The clause was incorporated in the bill of the following year, and was finally carried by a majority of 272 to 32. The result has been as was then predicted. In the parliament that passed the Reform Bill, almost all the English county members, elected by the old freeholders, were 'Reformers'; ever since, owing to the operation of this clause, the English county members have been mostly Conservative.

CHANFRON. See **CHARGER**.

CHANGARNIER, NICOLAS ANNE THÉODULE, a French general, was born at Autun in 1793—and received his education at the military school of Saint-Cyr. In 1830, he went as lieutenant to Algeria, where he distinguished himself, and rose to the rank of general of division. After the proclamation of the Republic in 1848, he was appointed governor-general of Algeria, in the room of Cavaignac; but being chosen a member of the National Assembly, he returned to Paris, when he was appointed commander-in-chief of the garrisons

of Paris and of the National Guard. He held this double office till the middle of May 1849, and again for some time after the insurrectionary movements of June of that year. C. was a member of the Legislative Assembly, where he held a sort of neutral position between the Orleanists and Legitimists, at the same time that he was decidedly opposed to the Bonapartists. At the *coup d'état* in December 1851, he was one of the generals arrested and sent to the fortress of Ham. He continues to live in exile, having refused to take the oath of allegiance to the emperor, and is now considered one of the chiefs of the Legitimists.

CHANG-CHOW-FOO, or **CHAOU-CHOW**, a city of China, and capital of a department of the same name, in the province of Keang-su, in 31° 50' N. lat., and 3° 24' long. E. of Peking.

CHANG-CHOW-FOO, a city of China, and capital of a department of the same name, in the province of Fuh-keen, in 24° 31' N. lat., and 1° 24' long. E. of Peking.

CH'ANGELING. It was at one time a common superstition, that infants were taken from their cradles by fairies, who left instead their own weakly and starveling elves. The children so left were called *changelings*, and were known by their peevishness, and their backwardness in walking and speaking. As it was supposed that the fairies had no power to change children that had been christened, infants were carefully watched until such time as that ceremony had been performed. This superstition is alluded to by Shakspeare, Spenser, and other poets; and it has not yet quite died out of some of the rural districts in Britain.

CHANG-SHA-FOO, a city of China, capital of the province of Hoo-nan, in 28° 20' N. lat.

CHANNEL, ENGLISH—the *Mare Britannicum* of the ancients—is that arm of the Atlantic Ocean which divides England from France, gradually narrowing to the Strait of Dover. It is often called simply the Channel; and the fleet stationed in it for the protection of the English coast, the Channel Fleet. The greatest river which falls into it is the Seine. It forms bays both on the English and on the French coast; but the larger ones are those on the French coast, whilst the best harbours are on the English.

CHANNEL ISLANDS, a group of islands belonging to Great Britain, lying off the north-west coast of France, between Normandy and Brittany. They are about 120 miles south-west of Southampton, and the nearest distance from the French coast is about 10 miles. The C. I. are the only parts of the dukedom of Normandy now belonging to the English crown, to which they have been attached since the Conquest. King John, about the year 1200, lost all Normandy, except these isles. The chief islands of the group are Jersey, Guernsey, Alderney, and Sark. The area of the whole is 112 square miles, and the population in 1851 was 90,739. They are more particularly described under **JERSEY**.

CHANNING, WILLIAM ELLERY, D. D., a celebrated Unitarian preacher and author, was born 7th April 1780, at Newport, Rhode Island, in the United States, entered Harvard University at the age of 14, and took his degree in 1798. In 1803, he was ordained minister of a church in Boston. During the earlier years of his ministry, his theological peculiarities had little prominence in his discourses, and in consequence he stood upon friendly terms with his brethren in more orthodox churches. In 1819, however, he preached a sermon at the ordination of the Rev. Jared Sparks, in which he

advocated the Unitarian doctrine with so much zeal and ability, that he was termed the 'Apostle of Unitarianism.' This involved him in controversy, a thing which he naturally loathed. Nevertheless, to the end of his life, he preserved a devoutly Christian heart, shrinking with the delicate instinct of a pious nature from everything cold, one-sided, and dogmatic, whether Unitarian or Trinitarian. As late as 1841, he wrote: 'I am little of a Unitarian, have little sympathy with the system of Priestley and Belsham, and stand aloof from all but those who strive and pray for clearer light.' In 1821, he received the title of D.D., from Harvard University, on account of the high talent he had exhibited in his tractate on the Evidences of Christianity, his Address on War, and his Sermons. In 1822, he visited Europe, and made the acquaintance of several great English authors, such as Wordsworth and Coleridge, both of whom were strongly impressed in his favour. Coleridge said of him: 'He has the love of wisdom and the wisdom of love.' In 1823, he published an *Essay on National Literature*; in 1826, *Remarks on the Character and Writings of John Milton*; in 1829, the *Character and Writings of Fénelon*; in 1835, a work in opposition to *Negro Slavery*; and in 1838, an essay on *Self-culture*. Besides these, he wrote a variety of other essays and treatises, all characterised by vigour, eloquence, pure taste, and a lofty tone of moral earnestness. He died October 2, 1842, at Bennington, Vermont. An interesting memoir of him has been published by his nephew, William Henry Channing (3 vols., London, 1848).

CHANTILLY, a town of France, in the department of Oise, about 23 miles north-north-east of Paris. Being one of the most beautiful places in the vicinity of the metropolis, it attracts immense numbers of visitors from thence. Apart from its natural beauty, it is interesting as the place where the great Condé spent the latter years of his life in the society of such men as Boileau, Racine, and Bossuet. The magnificent château, in which he resided was pulled down at the revolution of 1793; but a lesser château, one of the finest specimens of the renaissance in France, still remains. The park and grounds are very charming. C. is also noted for its extensive manufacture of the lace called *blonde*. Pop. 2500. ☐

CHANTREY, SIR FRANCIS, an eminent English sculptor, was born at Jordanthorpe, in Derbyshire, on 7th April 1781, not 1782, as has been generally said. His father, who was a carpenter, and rented a small farm, died when C. was only 12 years of age, leaving his mother in narrow circumstances. It is said that she gave him 'as liberal an education as her limited means would admit;' but much cannot be meant by the phrase, if it be true, as asserted by Holland in his *Memorials*, that his attendance at the little lane-side school was very irregular, and that 'for awhile he certainly drove an ass daily, with milk-barrels, between Norton and Sheffield.' C.'s mother married a second time, and the boy was, in 1797, apprenticed for 7 years to a carver and gilder in Sheffield called Ramsay. It was in this humble department that C. acquired the rudiments of his future art. It was during this period that his first attempts at modelling in clay were made, and that by the help of casts taken from the faces of his fellow-apprentices and his own, he began the work of portraiture, in which his great eminence ultimately consisted. C.'s apprenticeship was cancelled two years before its expiry; but his subsequent career is not very accurately known. It is certain that he visited both London and Dublin in 1802, probably in the capacity of a journeyman carver and gilder; and in that year he seems to have received

instruction as a pupil of the Royal Academy. It was probably then that he commenced seriously to prepare himself for the work of his future life. In the earlier part of his career as an artist, C. is said to have been under great obligations to Nollekens, who had the shrewdness to see, and the generosity to see without envy, his great promise in the branch in which he himself was eminent. In 1816, C. was elected an Associate, and in 1818 a Member of the Royal Academy; and in 1819 he visited Italy for the first time. Like the lives of many other eminent men, that of C. presents few claims on our interest after his early struggles were ended. As an ideal artist, he never attained a high rank, and, in comparison with Flaxman, he possessed little reputation in this country and none abroad. But he executed, with much truth to nature, as it presented itself to his eye, an endless variety and almost countless number of works of individual portraiture; so much so, that there is scarcely any town of importance in Great Britain which cannot shew specimens of his skill. As a consequence of the department of art to which he chiefly devoted himself, C. accumulated a very considerable fortune, the greater part of which, after providing for his widow, he bequeathed for artistic purposes. In this respect, he formed a remarkable contrast to Flaxman, whose modest savings were sworn under £4000; whilst Nollekens, whose name, at the distance of less than half a century, is almost forgotten, and who, in his own day, was a sort of humbler C., realised the enormous sum of £150,000, or it is even said £200,000. Sir Francis died childless on the 25th November 1841, and was buried in a tomb prepared by himself in the churchyard at Norton.

CHA'NTRY (Fr. *chantererie*, from *chanter*, to sing). The term C. is applied alike to endowments or benefices, to provide for the chanting of masses, and to the chapels in which the chanting takes place. These endowments were commonly made in the form of testamentary bequests, the object being to insure the erection of a chapel near, or over the spot where the testator was buried, and to remunerate the priests for saying masses in it for the benefit of his soul, or of the souls of others named in his will. Many such chantry chapels are still to be seen in English parish churches; but they were more common in abbeys and monastic establishments, in which it was considered a privilege to be buried, and where some such offering to the brotherhood was in a measure the price of sepulture. These chapels, which have generally the tomb of the founder in the middle of them, are separated from the aisles or nave of the church by open screen-work, a circumstance which has sometimes led to their being called Chancels (q.v.). Sometimes, again, they are separate erections, projecting from the church externally; but in cathedrals and the larger churches they are generally constructed within the church, often between the piers. Many chantries are lavishly enriched with sculpture and tracery of all descriptions, and some of them are adorned with gilding and painting.

CHA'OS signified, in the ancient cosmogonies, that vacant infinite space out of which sprang all things that exist. Some poets make it the single original source of all; others mention along with it Gæa, Tartaros, and Eros. By some also only the rough outlines of heaven and earth were supposed to have proceeded from C., while the organisation and perfecting of all things was the work of Eros. Still later cosmogonists, such as Ovid, represent it as that confused, shapeless mass out of which the universe was formed into a *kosmos*, or harmonious

order. Hesiod makes C. the mother of Erebus and Nox.

CHAOS, or BIRD ISLANDS, is the name given to several rocky islets situated at the entrance of Algoa Bay, South Africa, about 35 miles east of Port Elizabeth. It was on one of these islands that Bartholomew Diaz, the navigator, died in 1500.

CHA'OU-CHOW-FOO, a city of China, and capital of a department of the same name, in the province of Kwang-tung, in 23° 36' 6" N. lat., and 0° 46' 40" long. W. of Peking.

CHAOU-KING-FOO, a city and capital of a department of the same name, in the province of Kwang-tung, 50 miles west of Canton, in 23° 4' 48" N. lat., and 4° 24' 30" long. W. of Peking.

CHAP BOOKS, the name given to a variety of old and scarce tracts of a homely kind, which at one time formed the only popular literature. In the trade of the bookseller, they are distinguishable from the ordinary products of the press by their inferior paper and typography, and are reputed to have been sold by chapmen (see CHAP-MAN) or peddlers; hence their designation. The older C. B. issued in the early part of the 17th c. are printed in black letter, and are in the form of small volumes. Those of a later date are in the type now in use, but are equally plain in appearance. Of either variety, they were mostly printed in London; many being without dates. They were of a miscellaneous kind, including theological tracts, lives of heroes, martyrs, and wonderful personages, interpretations of dreams, fortune-telling, prognostications of the weather, stories of giants, ghosts, hobgoblins, and witches, histories in verse, and songs and ballads. See *Notices of Fugitive Tracts and Chap Books*, also *Descriptive Notices of Popular English Histories*; both by J. O. Halliwell, printed for the Percy Society. An inferior class of tracts succeeded these books for the common people, and are best known as *Penny Chap Books*. For the most part they consisted of a single sheet, duodecimo, or 24 pages. Besides the title, the first page usually contained a coarse wood-cut embellishment. The paper was of the coarsest kind adapted for printing, and the price, as the name imports, was a penny each. The subjects, besides being of a similar nature to the above, included stories of roguery and broad humour. These penny C. B. were issued by an obscure class of publishers in London and several English provincial towns, of which we might particularise Newcastle-on-Tyne. They were also issued from the presses of Edinburgh, Glasgow, Falkirk, and Paisley. It is a curious fact, that nearly all the penny C. B. of this very homely kind which were latterly popular, were written by Dougald Graham, who, previous to his death in 1789, filled the office of bellman or town-crier of Glasgow. The most reputable production of this humble genius was a *History of the Rebellion* in a Hudibrastic metre, which was a great favourite with Sir Walter Scott, and is now scarce; see *Chambers's Journal*, First Series, vol. x. p. 84; also the *Paisley Magazine* (1828), an extinct publication of great rarity, in which is given a biographic sketch of Dougald Graham, with a list of his productions. In some parts of Scotland and the north of England, Graham's penny C. B. are still seen on stalls at markets; but the general advances in taste, along with the diffusion of an improved literature, have displaced them in almost all other quarters. Collections of the older C. B. are now found only in the libraries of bibliomaniacs, by whom they have been picked up at extravagant prices from dealers in second-hand books. In various continental countries, there are

numerous varieties of C. B. at exceedingly small prices. The French government being desirous to substitute a wholesome class of tracts of this kind for what are generally objectionable on the score of taste and morality, have lately, through commissioners, taken some steps on the subject. See *Histoire des Livres Populaires, ou de la Littérature du Colportage*, by M. Nizard. w. c.

CHAPA'LA, the largest lake in Mexico, containing about 1300 square miles. It is about lat. 20° 20' N., and ranges in W. long. from 102° to 103° 25'. It is merely an expansion of the Rio Grande de Lerma, which enters the Pacific at San Blax. C. lies on the table-land of Anahuac, and has many islands.

CHA'PEL (Fr. *chapelle*), a word derived from *capa*, which originally signified a case, or chest in which were contained the relics of a saint, and afterwards the place where the chest was kept. The term now signifies a building erected for the purposes of public worship, but not possessing the full privileges and characteristics of a church. In this sense, all places of worship erected by dissenters are now called chapels in England, and the term is also applied to supplementary places of worship, even though in connection with the established church—such as parochial chapels, chapels of ease, free chapels, and the like. In former times, it was applied either to a domestic oratory, or to a place of worship erected by a private individual, or a body corporate. In the latter sense, we speak of chapels in universities and colleges. But its earliest signification was that of a separate erection, either within or attached to a large church or cathedral, separately dedicated, and devoted to special services. See CHANTRY. Chapels had no burying-ground attached to them, and the sacrament of baptism was not usually administered in them.

CHAPELLE, LA, the name of several places in France, the most important of which forms a northern suburb of Paris. Chemicals, salt, starch, liqueurs, &c. are manufactured. Pop. 33,346.

CHAPELLE DE FER. See HELMET.

CHA'PERON, a hood or cap worn by knights of the Garter. Such a hood was at one time in general use, but was latterly appropriated to doctors and licentiates in colleges. A person who acts as a guide and protector to a lady at public places, is called a C., probably from this particular piece of dress having been used on such occasions. The name was also applied to devices which were placed on the heads of horses at pompous funerals.

CHA'PLAIN, was originally the title of the ecclesiastic who accompanied an army, and carried the relics of the patron saint. See CHAPEL. It has now come to signify a clergyman not having charge of a parish, but employed to officiate at court, in the household of a nobleman, or in an army, garrison, ship, &c. Such officials began early to be appointed in the palace of the Byzantine emperors. The practice afterwards extended to the western empire, and to the courts of petty princes and even of knights, and continued to subsist after the Reformation. Forty-eight clergymen of the Church of England hold office as chaplains of the Queen in England, four of whom are in attendance each month. Six clergymen of the Church of Scotland have a similar title in Scotland; but their only duty is to conduct prayer at the elections of Scottish representative peers. A statute of Henry VIII. limits the right of nominating private chaplains in England: thus, an archbishop may have eight, a duke six, a baron three; and chaplains so appointed

have certain privileges, and may hold two benefices with cure of souls.

An **ARMY CHAPLAIN** is a clergyman whose services are retained especially by the government for the soldiery of the army. There have been such chaplains for many generations, and the office was at one time regarded as a saleable perquisite; but the system was reorganised and improved in 1795. In recent years, Roman Catholic and Presbyterian chaplains have also been appointed—a degree of tolerance not known in continental armies. The chaplains belong, not to *regiments*, but to *brigades*, or other groups of regiments. At home, they are attached to the military stations; but in the field they are located at head-quarters, at the hospitals, and with the brigades. The officers at the stations usually arrange for the men to attend divine service at the nearest parish-church; but this still leaves the chaplains many duties to fulfil. Where, as sometimes happens, there is no regular church or chapel near at hand, the C. reads and preaches to as many men as can conveniently group themselves around him at one time, and thus serves many different congregations at different times of the Sunday. He visits the sick at the hospitals, and examines and encourages the regimental schools. Among the wooden huts at Aldershot Camp, a church has been built, which is rendered available for chaplains of different religious denominations in succession.

When the system of army-chaplains was remodelled in 1796, a *chaplain-general* was appointed; this office was abolished by the Duke of Wellington soon after the termination of the great war, but revived by Mr Sidney Herbert in 1846. The C.-general, who receives £1000 per annum, has duties partaking somewhat of those of an arch-deacon. He assists the War Office in selecting chaplains, and in regulating the religious matters of the army. His office forms one of the 17 departments under the new organisation of the War Office. There are about 80 chaplains on the staff, besides assistant-clergymen and chapel-clerks. The commissioned chaplains receive from 16s. to 23s. per day; and there are always some on half-pay; while the assistant-clergymen receive from £200 to £400 a year. The whole expenditure for commissioned chaplains, assistant-clergymen, chapel-clerks, and church and chapel-books, figures in the Army Estimates for 1860—1861 at about £45,000.

NAVY CHAPLAIN. Every ship in commission, down to, and including fifth-rates, has a chaplain. The Navy Estimates (1860—1861) provide for 99 commissioned chaplains, at stipends varying from £160 to £255 per annum; 9 others in district guard-ships, at average stipends of about £175; and 66 on half-pay, at 5s. to 10s. per day. The chaplains perform divine service at stated times on shipboard, visit the sick sailors, and assist in maintaining moral discipline among the crew.

CHAPLET, a garland or head-band of leaves and flowers. In heraldry, a C. is always composed of four roses, the other parts being leaves.

CHAPMAN, a trader, but popularly applied in a more limited sense to a dealer in small articles, who travels as a pedler or attends markets. C. is from *chap*, equivalent to *cheap*, a word which in its origin signified a market or place for trading; hence *Cheapside*, *Eastcheap*. See **CHAF BOOKS**.

CHAPMAN, GEORGE, dramatist and translator, was born in 1557, educated at Cambridge and Oxford, and was the contemporary and friend of Spenser, Johnson, and Shakspeare. His first play, entitled *The Blind Beggar of Alexandria*, was printed in 1598. Up to 1620, he supplied the

theatre with tragedies and comedies, and some of these, after the fashion of the time, were written in conjunction with other dramatists. As a writer for the stage, C. does not rank high. Despite many nervous passages, his plays want the irradiation of a constant genius, and his characters are unnatural. As a translator, he has no equal. His translation of the *Iliad* is the finest that has yet been executed in England, and in reading it, many have felt with Keats—

Like some watcher of the skies
When a new planet swims into his ken.

C. seems to have led a long, temperate, and happy life, unblasted by poetic fire. He closed his career in 1634, at the age of 77.

CHAPPED HANDS AND CHILBLAINS, a lesser and a greater form of disease of the skin, produced by undue exposure to extremes of cold and heat, and affecting chiefly the most exposed joints, the skin over which swells and cracks, with itching, pain, and heat; in the most severe cases there is ulceration, which is difficult to heal in proportion to the length of time the disease has been neglected. Chilblains may generally be avoided if the hands are washed always with tepid water, and not habitually exposed to great cold, or when cold, to the heat of a fire. When formed, they may be treated with oxide of zinc ointment; or with a dilute solution of borax in glycerine and water; or with glycerine alone, slightly diluted with water; the hands being in any case habitually covered with woollen gloves in cold weather.

CHAPTER-HOUSE (Fr. *chapitre*), the building in which the monks and canons of monastic establishments, and the dean and prebendaries of cathedral and collegiate churches, meet for the management of the affairs of their order or society. See **CATHEDRAL**. Chapter-houses frequently exhibit the most elaborate architectural adornment, as, for example, those at York, Southwell, and Wells. The original stained-glass windows remain at York, and are of exquisite beauty. On the walls of that at Westminster, the original painting has been discovered. Chapter-houses are of various forms: those at York and Westminster are octagonal; those at Oxford, Exeter, Canterbury, Gloucester, &c., are parallelograms; Lichfield is an oblong octagon; Lincoln, a decagon; and Worcester, a circle. They are always contiguous to the church, and are generally placed to the west of the transepts. They generally either open into the church, or are entered by a passage. Chapter-houses were often used as places of sepulture, and have sometimes crypts under them, as at Wells and Westminster.

CHARACEÆ, aquatic plants, forming, according to some botanists, a distinct natural order of acotyledonous plants; according to others, a sub-order of *Algae*. Their stems are tubular, consisting either of a single tube, or of parallel tubes, a central one with smaller ones applied to its surface; they are either pellucid or incrustated with carbonate of lime, which is not to be regarded as a mere accidental incrustation, but belongs to their proper structure; and they have whorls of symmetrical tubular branches. They grow in stagnant waters; both fresh and salt, are always submersed, and often completely conceal muddy bottoms. A number of species are natives of Britain, all belonging to the genus *Chara*. The organs of reproduction are of two kinds—lateral *globules*, and axillary *nucules*. These organs have caused no little difficulty to botanists; the nature and use of the globules in particular being by no means well understood. The simple cellular structure of the C., apart from

all consideration of their reproductive organs, associates them with the lower Algae, rather than with

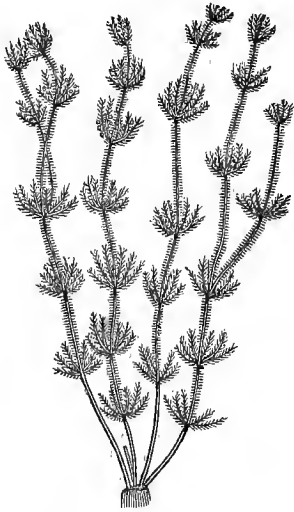

Chara Vulgaris.

phanerogamous plants. None of them is of any known use. It was in the C. that the beautiful phenomena of *Cyclois* (q. v.) were first observed. Sir David Brewster discovered that each of the minute calcareous particles incrusting the C. possesses double refraction, and has regular neutral and depolarising axes.

Fossil Characeæ.—The calcareous incrustation which covers the organs of reproduction, as well as the stems of some C., has, from its power of resisting decomposition, caused the abundant preservation of this order in the Tertiary fresh-water strata. The nucules originally described under the name of *gyrogonites*, and supposed to be foraminiferous shells, have been noticed by E. Forbes in strata as old as the Middle Purbeck beds. No remains of these have been observed in newer deposits, until we find them in the Tertiaries. The nucules, associated with *Lymnæa* and *Planorbis*, are very abundant in the Eocene Bembridge beds (q. v.).

CHARACINIDÆ. See SALMONIDÆ.

CHARACTER (Gr. *charasso* or *charatto*, which signifies to scrape, cut, or engrave), means what is engraven on an object, either physically by the action of another external object or objects, or morally by the passions, the affections, by good or evil fortune, and by what we designate generally as 'circumstances.' In art, the expression of C., either in animate or inanimate objects, is, after correct delineation, the most important matter to be attended to. Though, properly speaking, all distinguishing marks are included under it, it is more generally used to designate those which mark individual from individual, than species from species, or genus from genus.

CHARACTER TO SERVANT. The master is under no legal obligation, either in England or in Scotland, to give a character to his servant, however long, faithfully, or efficiently he may have served him; the duty of bearing testimony in his favour being one which, however binding in morality, it has not been found convenient to enforce by positive law; but, if given, the character must be strictly true, or, at all events, in accordance with the master's belief, otherwise he may be exposed to

an action of damages, either by the servant whom he has calumniated, or by a subsequent employer, whom he has deceived. If true, however, the fact of its being prejudicial will expose the master to no risk. In order to justify the giving of a bad character, however, it must, in general, be asked for by the servant, as the master is not entitled needlessly to publish the servant's defects. In that case, it will lie with the servant to prove its falsehood, not with the master to prove its truth. The case of the servant being known by the master to have committed a felony while in his service, is, however, an exception to this rule, as, in a case so extreme, the master is at liberty to warn others against taking him into their employment. Even though strictly true, the character, if prejudicial, must not be more so than the circumstances render necessary. Acts of petty dishonesty, such as are too common amongst servants, will not warrant the master in branding him as a thief. The safe course, in such a case, is to state the offence, and not to describe it by a general epithet, which may convey an erroneous impression of its magnitude.

It is probable that, partly from thoughtless good-nature, and partly from a selfish desire to get rid of a bad servant in the most comfortable manner, false characters are given in favour of servants very much more frequently than to their prejudice. It is desirable that masters and mistresses should have in view that they may render themselves liable in reparation of any damage which can be shewn to be the direct result of thus inflicting on a stranger a wrong which is unquestionably within the reach of the law.

By 32 George III. c. 56, personating a master, and thus giving a false character to a servant, or asserting in writing that a servant has been hired for a period of time, or in a station, &c., contrary to truth; and any person offering himself as a servant, pretending to have served where he has not served, or producing a false certificate, or altering a certificate, or pretending not to have been in any former service, &c., are offences at common law, punishable on conviction before two justices with a fine of £20. This statute does not extend to Scotland.

CHARACTERISTIC. See LOGARITHMS.

CHARADE, or 'syllable-puzzle' as the Germans call it, is an amusement which consists in dividing a word of one or more syllables into its component syllables, or into its component letters, predicating something of each; and then, having reunited the whole, and predicated something of that also, the reader or listener is asked to guess the word. As a specimen of the C. depending upon syllables, we adduce the following:

'My *first* is ploughed for various reasons, and grain is frequently buried in it to little purpose. My *second* is neither riches nor honours, yet the former would generally be given for it, and the latter is often tasteless without it. My *whole* applies equally to spring, summer, autumn, and winter; and both fish and flesh, praise and censure, mirth and melancholy, are the better for being in it. Ans. *Sea-son*.'

As a specimen of the second class of charades, we take the following happy example from the French:

'Quatre membres font tout mon bien,
Mon dernier vaut mon tout, et mon tout ne vaut rien.'

The word is *zero*. It is composed of four letters, of which the last—viz., *o*, is equal to *zero*; the whole, *zero* itself, being equal to nothing.

But besides charades of this nature, there is another kind rather popular at evening-parties—the *acted C.*: the character of which is entirely dramatic. Half a dozen or so of the company

retire to a private apartment, and there agree to select a certain word, as the subject of the C.; let us suppose **INNKEEPER**. The next thing done is to take the first syllable, **INN**, and arrange a little scene and dialogue, each member taking a certain part. This being accomplished, the amateur actors return to the drawing-room, and commence their performance, the rest of the company constituting the spectators. Care is taken to mention conspicuously, and yet not obtrusively, in the course of the dialogue, the word **INN**, which is the subject of the scene. On its conclusion, they again retire, and devise a new series of incidents for the word **KEEPER**, generally something in connection with a menagerie or a madhouse. This being also represented, they retire for a third time, to contrive the final scene, into which both words, or rather the whole word, **Innkeeper**, must be dexterously introduced at an odd moment when the spectators are thought to be off the scent. The company are then asked to guess the word. In order to the effective performance of a C. of this sort, the actors must possess a good share of inventiveness, self-possession, and ready talk, as the greater portion of the dialogue has to be extemporised.

CHARADRIADÆ, a large family of birds, of the order *Grallatores*, and tribe *Presivirostres*, chiefly abounding in the temperate parts of the Old World, and generally frequenting sandy unsheltered shores and open moors and downs. They have a short bill, generally soft at the base, hard and often a little inflated towards the tip; long and powerful wings; long legs; and short toes, generally only three in number, and all directed forward, but sometimes they have also a very small hinder toe. They run with great swiftness: they generally congregate in flocks, at least during certain parts of the year; many of them are nocturnal in their habits; many are migratory. The Plovers (*Charadrius*) have given their name to the family, which includes also Lapwings, Pratincoles, Oyster-catchers, Turnstones, Sanderlings, &c.

CHARBON ROUGE, or **RED CHARCOAL**, is a variety of charcoal obtained by subjecting wood to the action of heated air from furnaces, or of steam, which has been raised to a temperature of 572° F. Air-dried wood, by the ordinary process of charring, yields at the best 21 to 26 per cent. of black charcoal; but when acted on by heated air or steam, as mentioned above, 36 or 42 per cent. of C. R. is obtained. It is now prepared largely in France and Belgium, and is used in stoves for heating, and in the preparation of gunpowder. It has a dark-red colour, and consists of about 75 per cent. pure carbon, and 25 per cent. hydrogen and oxygen.

CHARCOAL is a popular term applied to charred wood, or coal produced by charring wood. There are several other varieties of C., however, for which see **CARBON**, **ANIMAL CHARCOAL**, **WOOD CHARCOAL**, **COKE**, **BLACK-LEAD**, &c.

CHARCOAL BLACKS are made both from animal and vegetable substances—e. g., burnt ivory, bones, vine-twigs, peach-stones, nut and other shells, the smoke of rosin condensed, &c. Those which are derived from vegetable substances, when mixed with white, are usually of a blue tint. See **LAMP BLACK**.

CHARENTE, a considerable river in the west of France, rises in the department of Haute-Vienne, about 14 miles north-west of Chalus. It first flows north-west to Civray, where it turns southward into the department of Charente to Angoulême, thence it flows westward past Châteauneuf, Jarnac, and Cognac, and entering Charente-Inférieure, it

runs north-west past Saintes, and falls into the Atlantic below Rochefort, and opposite the islands Oléron and Aix. This river gives its name to two departments, both remarkable for the productiveness of their vineyards; but the wines are mostly used in the preparation of brandy and liqueurs.

CHARENTE, a department of France, formed chiefly out of the old provinces of Angoumois, and situated in lat. 45° 10'—46° 8' N., and long. 0° 50' E. and 0° 30' W. Area, about 2200 square miles. Pop. 378,721. It is generally hilly, and is watered by the river Charente, above noticed, and its tributaries, the Tardouère and the Bandiat, with the rivers Vienne and Dronne. The highest chain of hills in the north of C. is a continuation of the heights of Limousin, forming the watershed towards the Loire. Remains of marine productions shew that the basin of the C. was once filled by the ocean. The soil is mostly limestone, here and there interrupted by banks of clay and gravel. Only a portion of the arrondissement Confolens has a rich vegetable clay-mould. The clay-soil is cool and moist, while the limestone district is dry and hot. The hills are in many places clad with chestnut forests. The climate is generally mild and healthy. The wines grown are spirituous and fiery in flavour, and are chiefly used in the manufacture of Cognac, which forms the most important of the exports. Truffles grow abundantly in several parts. Industry is in rather a backward condition. C. is divided into the five arrondissements of Angoulême, Cognac, Ruffec, Barbezieux, and Confolens.

CHARENTE-INFÉRIEURE, a maritime department of France, which includes the former province of Angoumois, with the greater part of Saintonge, and a small portion of Poitou. It lies in lat. 45° 5'—46° 19' N., and long. 0° 7' E.—1° 13' W. The Bay of Biscay washes its western boundary—the coast-line, which is very broken, measuring about 100 miles. Area, 2740 miles. Pop. 474,828. It is watered on its boundaries by the Sèvre-Niortaise and the Gironde, and in the centre by the navigable Charente and the coast-stream Sendre. The surface is level; and the soil—near the coast, intersected by ridges of rock and sand-banks, and protected from the sea by dikes—is mostly chalky and sandy, but very fertile, producing hemp, flax, saffron, and wine in great quantities. The commerce, facilitated by the structure of the coast, and by canals in the interior, is considerable, consisting chiefly of brandy and sea-salt, which is found in the department in great abundance. The oyster and pilchard fisheries are important. The chief harbours are those of Rochefort, and La Rochelle, the latter of which is the chief town. C. is divided into the six arrondissements of La Rochelle, Rochefort, Marennes, Saintes, Jonzac, and St Jean-d'Angely.

CHARENTON-LE-PONT, a town of France, in the department of Seine, situated on the right bank of the Marne, 5 miles south-east of Paris. The bridge over the river, which is important, from a military point of view, being considered one of the keys of the capital, and which has frequently been the scene of conflicts, is defended by two forts, forming a part of the fortifications of Paris. At the other side of the river is the National Lunatic Asylum, formerly called Charenton St Maurice, and now St Maurice simply. Pop. 3700.

CHARGE, in Heraldry. The figures represented on a shield are called charges, and a shield with figures upon it is said to be charged (Fr. *chargé*). The charges in a shield ought to be few in number, and strongly marked, both as regards their character and the mode of their representation. The family shield, belonging to the head of the house,

almost always is simpler, i. e., has fewer charges than the shields of collaterals, or even of junior members.

CHARGE, in Military Warfare, is a sudden and impetuous attack on the enemy, by horse or foot, or both. Its object usually is to drive the enemy from a particular position; but if made with a much stronger force, it may result in his actual destruction.

CHARGE, in Military Pyrotechny, is sufficient combustible material for one firing or discharge. It is applicable to all kinds of firings, fireworks, and explosions; but the name is generally given to the quantity of gunpowder requisite for firing off a gun, &c. In cannon, this varies greatly, from $\frac{1}{2}$ to $\frac{1}{10}$ of the weight of the shot; some of the rifled ordnance now coming into use are remarkable for the smallness of the C. with which they are fired. The quota of C. will be mentioned in connection with the various kinds of firearms described in the *Encyclopædia*. In breaching a wall, a greater C. is necessary than in attacking a ship or a column of troops, even with the same kind of gun and projectile.

CHARGE. In the law of Scotland, a C. is a command to perform an act, conveyed in the letters of the sovereign. The same term is applied to a messenger's copy for service, requiring the person to obey the order contained in the letters—e. g., a C. on letters of homing, or a C. against a superior.

CHARGER is a name sometimes given to a war-horse, accustomed to the din of battles, and reliable under circumstances of confusion and danger. In the middle ages, when armour was used, and gunpowder unknown, the military horses were *barbed* or *barded* when ridden by men-at-arms—that is, they were nearly covered with armour. The face, the head, and the ears were covered with a mask called a *chanfron*, to prevent fright when charging the enemy; and an iron spike projected from the middle of the forehead. The neck was defended by small plates called *crinières*; the breast by a *poitrinal*; and the buttocks and haunches by *croupières*. These various pieces of armour were mostly made of metal, but sometimes of tough leather. The horse was occasionally covered with chain-mail; and in other instances with a *gambeson*, of stuffed and quilted cloth. The man-at-arms generally rode another horse when not charging, to relieve the C. from his great burden. The barbed or *bardé* horse received its name from an old French word implying covered, clothed, or armed. A war-horse is still called a C., though not armed as in ancient times.

CHARGÉS D'AFFAIRES are fourth-class diplomatic agents, accredited, not to the sovereign, but to the department for foreign affairs; they also hold their credentials only from the minister, and are sometimes only empowered by an ambassador to act in his absence.

CHA'RIOT, in ancient times, was a kind of carriage used either for pleasure or in war. According to the Greeks, it was invented by Minerva; while Virgil ascribes the honour to Erichthonius, a mythical king of Athens, who is said to have appeared at the Panathenaic festival founded by him, in a car drawn by four horses. The ancient C. had only two wheels, which revolved upon the axle, as in modern carriages. The pole was fixed at its lower extremity to the axle, and at the other end was attached to the yoke, either by a pin or by ropes. The Greeks and Romans seem never to have used more than one pole, but the Lydians had carriages with two or three. In general, the C. was drawn by two horses. Such was the Roman *Biga* (q. v.), but we also read of a *triga*, or three-horse C., and a *quadriga*, or four-horse one. The last was that in which the Roman

generals rode during their triumphal entrance into the city, and was often adorned with splendid art. The war-C. held two persons—the soldier himself and the driver, the latter of whom usually occupied the front; but the chariots used by the Romans in their public games held only the charioteer.

The oldest war-chariots of which we read are those of Pharaoh (Exodus xiv. 7). All the eastern nations used them, while we learn from Cæsar (*De Bell. Gall.*, v. 19) that the Britons also were familiar with their use.

CHARITABLE USES AND LAW OF CHARITIES. The law of England has always anxiously, though too often ineffectually, sought to provide for the preservation and proper application of the munificent private endowments in that country for charitable purposes. The preceding efforts of the legislature in this direction may now be said to have been superseded by the Charitable Trusts Act of 1853 (16 and 17 Vict. c. 137; amended by 18 and 19 Vict. c. 124, and 20 and 21 Vict. c. 76). See **CHARITY COMMISSIONERS**. As these statutes now contain a species of code of charity-law, it will here only be necessary to mention certain general principles which govern the law of England in its relation to charities. The courts of equity are those which in general take cognizance of all charitable uses, or trusts of a public description. Under the authority of these tribunals—or, in cases in which the annual income does not exceed £30, in accordance with the act just quoted, under that of the county courts of the district—trustees may be called to account for the funds committed to their charge, or new trustees may be appointed, improvident alienations may be rescinded, schemes for carrying the donor's object into effect may be judicially considered and adopted, and every species of relief afforded which such institutions require. Where the management of the charity has been confided by the donor to governors and other functionaries, the law will not interfere with their proceedings unless they can be shewn to be squandering the revenues or otherwise abusing the trust. Where the crown is founder, the Lord Chancellor is visitor, but in his personal character only, and not as judge of the Court of Chancery. As regards the nature of the trusts to which the equitable jurisdiction of the Chancery extends, it is necessary to remark that the word *charitable* here includes institutions for the advancement of learning, science, and art, and, indeed, for all useful public purposes, as well as for the support of the poor. It also comprises all donations for pious and religious objects, under which are included all those which tend to the benefit of the Church of England, or of any body of dissenters sanctioned by law. Roman Catholics were admitted into this category by 2 and 3 Will. c. 115, and Jews by 9 and 10 Vict. c. 59, s. 2. The charity, or other benevolent purpose, however, must be public; 'for if a sum of money be bequeathed, with direction to apply it to such purposes of benevolence and liberality as the executor shall approve,' or even 'in private charity,' the law will take no notice of such a trust.

Legacies to pious or charitable uses are not by the law of England entitled to a preference, though such was the doctrine of the civilians; but where a deficiency of assets arises, they are abated in proportion with the others.

CHARITY, SISTERS OF. See **SISTERS OF CHARITY**.
CHARITY COMMISSIONERS. A body of commissioners was created in 1853, by the Charitable Trusts Act, 16 and 17 Vict. c. 137 (see **CHARITABLE USES**), with power to inquire into all charities in England and Wales, with reference to their

nature, objects, and administration, and the amount and condition of the property belonging to them. The commissioners have power to call for the production of accounts and documents from trustees, and to appoint inspectors to visit and report on their management. The statute does not extend to Scotland or Ireland, to the English universities, or to the city of London. An annual report of their proceedings must be laid before parliament by the commissioners.

CHARIVARI is a French term used to designate a wild tumult and uproar, produced by the beating of pans, kettles, and dishes, mingled with whistling, hawling, groans, and hisses, and got up for the purpose of expressing a general dislike to the person against whom it is directed. The etymology of C. is obscure; the Germans translate it by *Katzenmusik*, the English of which is *caterwauling*. In France, during the middle ages, a C. was generally raised against persons contracting second nuptials, in which case the widow was specially assailed. On these occasions, the participants in it, who were masked, accompanied their hubbub by the singing of satirical and indecent verses, and would not cease till the wedding couple had purchased their peace by ransom. C. answers to the English concert upon 'marrow-bones and cleavers,' with which it was customary to attack a married couple who lived in notorious discord. It was also got up against an unequal match, such as where there was great disparity in age between the bride and bridegroom.

Similar customs seem to have existed under different names in all parts of Europe, and sometimes they were of such a licentious and violent character as to require military interference to put them down. Even as early as the 14th c., the church found itself forced to threaten punishment, and even excommunication, against those who participated in them. In more recent times, the C. has taken a purely political colouring; as, for example, during the Restoration in France, at which time, however, the popular voice began to seek vent by casting its satirical darts against public men through the press. The papers published for this purpose were called C., the most famous among which is *the CHARIVARI*, which was established in Paris, December 2, 1832, corresponding to the English publication, *Punch*.

CHARKOV. See **KHARKOV**.

CHARLATAN, a mountebank, quack-doctor, or empiric, and hence any one who makes loud pretensions to knowledge or skill that he does not possess. The word seems to be derived from the Ital. *ciarlarre*, to babble or talk, the chief art of the C. consisting in talk. Charlatanism abounds in all departments of life, and manifests itself in various ways according to the subject and character of the person. It changes also in form with the spirit of the time. The medical C. no longer appears on a stage in the guise of Doctor Ironbeard, but, as a fine-dressed gentleman, receiving grateful acknowledgments through the newspapers, and publishing popular medical books, with the address of the author, and recommendations to apply to him. It has not unfrequently happened, however, that extraordinary men who were so far before their age as not to be understood by it, such as Paracelsus, have passed for charlatans until more justly estimated by later times. Several books have been written on the charlatanism of scholars. J. B. Mencke's satire, *De Charlataneria Eruditorum* (Leip. 1715), is a classical work, which has been continued by Büschel in his book, *Über die Charlatanerie der Gelehrten seit Mencke*.

CHARLEMAGNE, i. e., Charles the Great, king of the Franks (768—814 A. D.), and Roman emperor (800—814 A. D.), was born on 2d April 742, probably at Aix-la-Chapelle, and was the son of Pepin the Short, the first Carolingian (q. v.) king of the Franks, and grandson of Charles Martel (q. v.). On Pepin's death in 768, he and his brother Carloman jointly succeeded to the throne. By Carloman's death, and the exclusion of both his sons from the throne, C. became sole king. In 772, it was resolved in the Diet at Worms to make war against the Saxons, for the security of the frontiers, which they continually threatened, and for the extension of the Christian religion. C. advanced as far as the Weser in 772, securing his conquests by castles and garrisons. Pope Adrian I. now called him to his aid against Desiderius, king of the Lombards. C. had married the daughter of Desiderius, and had sent her back to her father because she bore him no children, and married Hildegard, daughter of the Swabian duke, Godfrey. Desiderius had sought revenge by urging the pope to crown the sons of Carloman, and on the pope's refusal, had laid waste the papal territory. C. crossed the Alps from Geneva, with two armies, by the Great St Bernard and Mont Cenis, in 773, and overthrew the kingdom of the Lombards in 774. The Lombard dukes acknowledged him as their king, and he secured the pope's favour by confirming the gift which Pepin had made to the papal see, of the exarchate of Ravenna. In 775, he was again employed in the most northerly part of his dominions, reducing the Saxons to subjection; in 776, he suppressed an insurrection in Italy; in 777, he so completed his victory over the Saxons, that their nobles generally acknowledged him as their sovereign in an assembly at Paderborn. Being now invited to interpose in the wars of the Arabs and Moors in Spain, he hastened to that country in 778, and added to his dominions the regions between the Pyrenees and the Ebro. From Spain he was summoned in haste by a new insurrection of part of the Saxons, who had advanced almost to Cologne, but whom he drove back to the Elbe. In 781, he went to Italy, where the pope crowned his second son, Pepin, king of Italy, and his third son, Louis, an infant of three years old, king of Aquitaine. The Saxons once more rising in arms, defeated and destroyed a Frankish army on the Süntel in 782, which C., after a new victory, fearfully revenged by causing no fewer than 4500 prisoners to be executed as rebels in one day. A more general rising of the Saxons followed, but in 783—785, the Frankish monarch succeeded in reducing them completely to subjection, and in persuading their principal chiefs to submit to baptism, and to become his faithful vassals. Subsequent insurrections and wars in Germany, between this year and 800, resulted in victories over the Bulgarians and Huns, and in the further consolidation and extension of his empire, the eastern boundary of which now reached to the Raah.

In 800, C. undertook an Italian campaign, which was attended with the most important consequences. Its immediate purpose was to support Pope Leo III. against the rebellious Romans. When C., on Christmas Day, 800, was worshipping in St Peter's Church, the pope unexpectedly, as it appeared, set a crown upon his head, and, amidst the acclamations of the people, saluted him as Carolus Augustus, emperor of the Romans. Although this added nothing directly to his power, yet it greatly confirmed and increased the respect entertained for him, such was still the lustre of a title with which were associated recollections of all the greatness of the Roman empire. A scheme for the union of the newly revived

Western Empire with the Empire of the East, by C.'s marriage with Irene (q. v.), the Byzantine empress, failed by reason of Irene's overthrow. After this, C. still extended and confirmed his conquests both in Spain and in Germany. He laboured to bring the Saxons to a general reception of Christianity, and founded bishoprics for this purpose. To the end of his reign, he was incessantly engaged in wars, and insurrections were always apt to break out in the frontier parts of his dominions; which he endeavoured to secure, however, not only by military power and arrangements, but by improvements in political and social institutions. His views were liberal and enlightened to a degree rare for many subsequent ages. Whilst he made the power of the central government to be felt to the utmost extremities of his empire, he recognised in his subjects civil rights, and a limitation of monarchic power by their assemblies. He zealously endeavoured to promote education, agriculture, arts, manufactures, and commerce. He projected great national works, one of which was a canal to connect the Rhine and the Danube; but he deemed nothing beneath his attention which concerned the interests of his empire or of his subjects. He required his subjects to plant certain kinds of fruit-trees, the cultivation of which was thus extended northward in Europe. His own domains were an example of superior cultivation. He had a school in his palace for the sons of his servants. He built sumptuous palaces, particularly at his favourite residences, Aix-la-Chapelle and Ingelheim—for he had no fixed capital—and many churches. Learned men were encouraged to come to his court. He himself possessed an amount of learning unusual in his age; he could speak Latin and read Greek. He attempted to draw up a grammar of his own language. C. was of more than ordinary stature, and of a noble and commanding appearance. He was fond of manly exercises, particularly of hunting. He was too amorous, but in eating and drinking he

was very moderate. His fame spread to all parts of the world; in 768, Harun-al-Raschid sent ambassadors to salute him. He enjoyed good health till shortly before his death, 28th January 814. He was buried at Aix-la-Chapelle (q. v.), in a church which he had built there. He was succeeded by his son Louis, styled Louis le Débonnaire, the only one of

Crown of C., now at Vienna.



his sons who survived him; but the greatness of his dynasty terminated with his own life. C. is styled Charles I. in the enumeration both of the French kings and of the German or Roman emperors. Besides his *capitularies* (q. v.), there are extant letters and Latin poems ascribed to him. His life was written by his secretary, Eginhard.

CHARLEROI, a Belgian town and fortress in the province of Hainaut, stands on the Sambre, between Mons and Namur, on the line of the Brussels and Namur railway. The population is about 6500, who carry on considerable manufactures in hardware, glass, woollen-yarn, &c. The district is rich in coal, and the number of smelting-furnaces and nail-factories in the neighbourhood is very great. The ironworks of Couliers, which yield a third of all the cast iron produced in Belgium, lie within a mile or two of the town. C. possesses considerable historical and political interest as a fortress. The fortifications were begun by the Spaniards in 1686, but falling into the hands of the French next year, they were completed by Vauban. After six exchanges of masters between the French and Spaniards, the Peace of Aix-la-Chapelle, 1748, left C. in the possession of Austria. In 1794, after

a protracted and desperate resistance, it was surrendered to the French by capitulation, when the fortifications were demolished. The importance of the place in a strategic point of view having become apparent during the campaign of 1815, the fortifications have been since restored.

CHARLES, surnamed **MARTEL**—i. e., the Hammer—was the son of Pepin of Heristal, mayor of the palace under the last Merovingian kings, and was born about 690 A. D. After his father's death in 714, he was proclaimed mayor of the palace by the Austrasian party. King Chilperic and he now quarrelled, and a civil war arose, which ended in C. becoming undisputed mayor of the palace and ruler of the Franks. During the latter years of his life, he indeed allowed the nominal throne to remain occupied—the titular kings being mere puppets in his hands. He was much engaged in wars against the revolted Alemanni and Bavarians, the Saxons, &c., but his importance as a historic personage is chiefly due to his wars against the Saracens, who, having conquered Septimania from the Western Goths in 720, advanced thence into Aquitaine, conquered Bordeaux, defeated the Duke of Aquitaine, crossed the Garonne, advanced to the Loire, and threatened Tours. C. defeated them between Tours and Poitiers in 732, in a great battle, in which their leader, Abd-ur-Rahmān, fell, and a stop was put to their progress in Europe, which had filled all Christendom with alarm. He defeated them again in 738, when they had advanced in the Burgundian territories as far as Lyon; deprived them of Languedoc, which he added to the kingdom of the Franks; and left them nothing of their possessions north of the Pyrenees beyond the river Aude. He died on 22d October 741, at Quiercy on the Oise, in the midst of his victories, his projects, and his greatness, leaving the government of the kingdom to be divided between his two sons—Carloman, and Pepin the Short.

CHARLES, Archduke of Austria, third son of the Emperor Leopold II., was born at Florence, 5th September 1771. Whilst yet a youth, he pursued military studies with much ardour; and after having greatly distinguished himself as a general in inferior commands, he was intrusted, in 1796, with the chief command of the Austrian army on the Rhine. He fought with great success against Moreau at Rastadt, defeated Jourdan in several battles, drove the French over the Rhine, and concluded his victories by taking Kehl in the winter. In 1799, he was again at the head of the army on the Rhine, was several times victorious over Jourdan, protected Swabia, and successfully opposed Massena. In 1800, bad health compelled him to retire from active service; but being appointed governor-general of Bohemia, he formed a new army there. After the battle of Hohenlinden, he was again called to the chief command, and succeeded in staying the rapid progress of Moreau, but almost immediately entered into an armistice with him, which was followed by the peace of Luneville. In 1805, he commanded the army opposed to Massena in Italy, and fought the hard battle of Caldiero; but upon bad tidings from Germany, retreated from the left bank of the Adige to Croatia. This retreat was one of his greatest military achievements. In 1809, he won the great battle of Aspern, which first shewed to Europe that Napoleon was not invincible; but he did not promptly enough follow up his victory, and Napoleon, who hastened to reinforce his army, retrieved his fortunes at Wagram, and the archduke was now compelled to give way before the enemy, till he reached Znaim, where an armistice was concluded on 12th July. In the campaigns of 1813 and 1814

he had no part; and lived in retirement till his death, 30th April 1847.

CHARLES I., king of England, Scotland, and Ireland (1625—1649), was born at Dunfermline, 19th November 1600, and was the second son of James I. of England (VI. of Scotland). On the death of his elder brother, Henry, in 1612, he became Prince of Wales, and heir-apparent to his father's throne; to which he succeeded in 1625, but found both in England and Scotland a contest in progress between king and people. He had inherited from his father the most extreme notions of kingly prerogative, and he mistook the general movement in the public mind for an agitation amongst a few disaffected persons. He had deeply imbibed his father's notion, that an Episcopal church was the most consistent with the proper authority of kings; and he adopted severe and persecuting measures against the Puritans in England and the Presbyterians in Scotland. He married a Roman Catholic, Maria Henrietta of France, a marriage most displeasing to the nation; and even so far despised public opinion as to make his father's favourite, the Duke of Buckingham, his prime minister and chief adviser. The English parliament, which he assembled in 1625, was resolved upon the vindication of the national liberties, and was therefore very sparing in its grants of subsidies, while that of 1626, instead of freely granting supplies, resolved upon the impeachment of Buckingham; whereupon the king threw into prison two of the boldest members, Elliot and Digges; dissolved parliament; and, to procure money, had recourse to the arbitrary measures of forced loans, and a tax upon the seaports (*ship-money*), imposed by the mere exercise of royal authority. By all this, public feeling was more and more embittered. In 1628, C. found it necessary again to summon a parliament; and the parliament, very resolute to maintain the liberties of the nation, presented the petition known in history as the *Petition of Right* (q. v.). C. temporised, conceded, and finally, although the assassination of Buckingham had removed one cause of strife, assumed a threatening tone, and dissolved the parliament, 10th March 1629. He even caused some of the leading members of the House of Commons to be imprisoned. He now governed for eleven years without a parliament, having Laud (q. v.) and Strafford (q. v.) for his chief advisers, and obtaining for his edicts the semblance of a legal sanction by means of the Star Chamber (q. v.). All this while, the storm was gathering, the love of liberty increased, and republican principles were developed and extended. The policy which C. adopted was that of more severe repression. At length, in 1638, Scotland assumed an attitude of determined resistance to the imposition of a liturgy and of Episcopal church-government. The National Covenant (q. v.) was subscribed, Presbyterianism was completely restored; and in 1639, the king having assembled an army for the purpose of reducing Scotland to subjection, the Scottish Covenanters also took up arms, and advanced to the English border, many of the English regarding their approach with joy. Civil war was, however, prevented for the time, by concessions on the part of the king. Unable to do without supplies any longer, C. summoned an English parliament in 1640, which, instead of listening to his demands, began to draw up a statement of public grievances. C. soon dissolved the parliament, and assembled an army to resist the Scots, who had again taken up arms and entered England; but his army was defeated by them at Newburn-upon-Tyne, and they advanced southward, with the sympathy and good-wishes of no small part of the king's English subjects. Much against his will, C. was now compelled again to

call a parliament, whose memorable sittings began on 3d November 1640. Both Houses were resolute in their opposition to his despotism. They began by the impeachment of the ministers and high officers of state, and declared the decrees of the Star Chamber and Court of High Commission to be null and void. They passed a bill in favour of triennial parliaments; and the king, in trepidation, gave it his assent. He also consented, although against his own convictions, to the execution of Strafford; and even gave his assent to an act which provided that the present parliament should not be dissolved, prorogued, or adjourned, without its own consent. Hoping to win the favour of the Scots, he now visited Scotland; but whilst he was there, a rebellion broke out in Ireland, accompanied with a fearful massacre of Protestants. The prospect of a peaceful accommodation was now almost destroyed; the English parliament enlarged its demands; the king, after seeming to yield, took the extraordinary step of suddenly, on 4th January 1642, appearing in the House of Commons, accusing five members—Pym, Hampden, Hollis, Hazelrig, and Stroud—of high treason, and demanding that they should be delivered up to him. Both Houses of parliament espoused their cause, and the city of London shewed a determination to defend them by arms. C. left London with his family, and the parliament declared the kingdom in danger. Civil war began; the royalists had at first the advantage, but the national feeling was with the parliament. Negotiations were from time to time opened or renewed, but always in vain. After the battle of Naseby, on 15th June 1645, in which his army was almost annihilated by the parliamentary troops under Fairfax and Cromwell, C. was compelled to seek refuge in the Scottish camp. Negotiations still proving fruitless, he was delivered up to the English parliamentary army. Negotiations were still attempted with C. in his captivity; but resulted in nothing. Finally, C. fled, was taken, refused the ultimatum of the army, and so enraged Cromwell and the Independents, that parliament was obliged to pass an act declaring all negotiation with the king to be treason. The Presbyterians of England and the Scots, who were always haunted by the idea that there was something sacred and inviolable in monarchy, thought to rescue the king from the hands of the Independents, but were defeated, and all the Presbyterians were forcibly expelled from the English House of Commons, which now consisting only of about 60 members—the *Rump parliament*—appointed a court composed of persons from the army, the House of Commons, and the city of London, to try the king. The court was opened with great solemnity in Westminster Hall on 20th January 1649. About 70 members took part in its proceedings. On the 27th of January, C. was condemned to death as a tyrant, murderer, and enemy of the nation. The Scots protested, the royal family entreated, and the court of France and States-General of the Netherlands interceded, but in vain. On 30th January 1649, he was beheaded in front of the palace of Whitehall. In his last hours he shewed great calmness and presence of mind. In his private character, C. was a man of cultivated mind, kind, and of irreproachable life; but in political affairs he was unscrupulous, and had recourse to dissimulation and falsehood for the accomplishment of his purposes. In the estimation of many who do not condemn it on moral grounds, his execution was a great political blunder. From the restoration of Charles II., the 30th of January, was observed in the Church of England with special religious services, as the day of *King Charles the Martyr*. This commemoration,

offensive to great part of the community, and of the members of the Established Church itself, was abolished by act of parliament in 1859.

CHARLES II., king of England, Scotland, and Ireland (1649—1685), the eldest son of Charles I., was born 29th May 1630, and went with his mother to France during the civil war. He was at the Hague at the time of his father's execution, and immediately assumed the title of king. He meditated an expedition to Ireland for the assertion of his claims, when the Scots offered him their crown in 1650, and proceeding to Scotland, he was crowned at Scone in the beginning of 1651. The limitations, however, under which he received the crown, were disagreeable to him, and he hated the restraint put upon his inclinations by the Presbyterian clergy. After the defeat of the Scots at Dunbar, he put himself at the head of their army, in hope of rousing the royalists of England to his support; but was completely defeated by Cromwell, at Worcester, on 3d September 1651. He made his escape, amidst many dangers, to France, where his situation was by no means agreeable, and from which he went to Cologne, and afterwards to the Netherlands. After Cromwell's death, the desire of the English for a settled government leading to the restoration of the House of Stuart, he landed at Dover, on 26th May 1660, was received with acclamation by the people, and ascended the throne almost untrammelled by a single condition. He was surrounded by men of extreme party-feeling, among whom the most influential was the chancellor, Clarendon (q. v.). The persons immediately concerned in the death of Charles I. were brought to the scaffold; Episcopacy was restored; and the Presbyterians and other Nonconformists, both in England and Scotland, were subjected to great hardship and persecution. The king was extravagant, and soon found himself in want of money; he married the Princess Catharine of Portugal, for the sake of her large dowry; he shamefully sold Dunkirk and Mardyke to the French; and for a pecuniary consideration, agreed to make war against the United Provinces, although such a war was contrary to all the feelings of the English people and the interests of English commerce. The Dutch fleet, under De Ruyter, entered the Thames, and C. was compelled to make an ignominious peace. After the fall of Clarendon, the ministry known as the Cabal (q. v.) ministry came into power—a ministry hateful to the country, composed of unprincipled men, and bent upon the restoration of Popery and absolute monarchy. C. sought to conciliate the people by the *Triple Alliance*, in May 1668, with Sweden and the States-General; but the French court soon found means to persuade him again to make war against the United Provinces. He basely accepted pecuniary gifts and a pension from the French government; and, as even this, with all that he could get from his parliament, was insufficient for his expenses, he had recourse to illegal means of raising money. The story of the *Popish Plot* (q. v.) against the life of the king caused prodigious excitement amongst the people, and Lord Stafford and many other persons were most unjustly brought to the scaffold. The parliament of 1679, very much against the will of the court, enacted the celebrated *Habeas Corpus Act* (q. v.); and a bill was under consideration for the exclusion of the king's brother, the Duke of York, from the throne, on account of his avowal of the Roman Catholic religion. The king, at this period of his reign, had, however, completely crushed the Presbyterians of Scotland, and was more absolute than any of his predecessors had been on either of the British thrones. Most arbitrary measures were adopted. The city of London was deprived of its privileges, because of the election

of a sheriff disagreeable to the court. The *Rye-House Plot* (q. v.), a widely extended conspiracy, and in which the king's natural son, the Duke of Monmouth (q. v.), was concerned, was discovered in 1683, and cost the lives of a number of persons, amongst whom were Lord Russell and Algernon Sidney. C., however, appears to have recognised the necessity of a more liberal policy, when he was unexpectedly carried off by death, on 6th February 1685. In his dying hours, he called in the assistance of a Roman Catholic priest, although he had not previously avowed his attachment to that religion. His reign was full of events dishonourable to his country, and of which he himself was generally the cause. His life was most dissolute; his adulteries, and the profligacy of his court, scarcely paralleled in British history. He had an affability, however, which won for him a certain sort of popularity.

CHARLES V., surnamed the Wise, king of France (1364—1380), was the son of King John, and was born on 21st January 1337. His father being made prisoner by the English at the battle of Poitiers, on 19th September 1356, he assumed the regency. The most significant events which occurred under his rule, were the vigorous efforts of the *bourgeoisie* to deliver themselves from the tyranny of the nobles and the court, and the peasant war called the *Jacquerie* (q. v.). His father dying, 8th April 1364, C. ascended the throne, and by his cautious policy rescued the kingdom from some of its troubles, and re-established the power of the crown, which had been much shaken. War with England raged for a number of years, but with results highly favourable to C., who stripped his enemies of all their conquests in France, except a few fortified places. He died 16th September 1380. C. was fond of books and the company of learned men, but was not above the natural weakness of kings for outward pomp and magnificence.

CHARLES VI., king of France (1380—1422), born at Paris, 3d December 1368, was the son and successor of Charles V. He was only 13 years of age when his father died. For several years, his uncle, the Duke of Anjou, acted as regent. In 1388, C. took the reins of government into his own hand, but during his lifetime was so often afflicted with insanity, that party-strife raged without much check. The two great families whose influence divided the nation, were those of Orleans and Burgundy. It was the Orleans party which called in the assistance of the English, and brought about the battle of Agincourt, so disastrous to the French nation. Subsequently the Burgundians allied themselves to the English, who laid waste the whole of northern France. In the midst of these calamities, C. died 21st October 1422.

CHARLES VII., king of France (1422—1461), the son and successor of Charles VI., was born on 22d February 1403. On his father's death he was at the head of an army, with which he held possession of the southern provinces of the kingdom; Paris and the north being in the hands of the English, who proclaimed Henry VI. of England king of France, and appointed the Duke of Bedford regent. For some time the events of war were unfavourable to C., who was compelled, in 1424, to evacuate Champagne, and, in 1425, Maine. In 1426, the Count Dunois gained the first victory over the English at Montargis; but in the year following they besieged Orleans, a place of great importance to C., as securing a connection with the north, and he was roused to fresh energy. At this time, also, Joan of Arc (q. v.), the Maid of Orleans, by her wonderful courage and confidence of a heavenly mission, roused the fervour both of nobles and people. The siege of

Orleans was raised in May 1429; the English retired disheartened, and gradually lost their acquisitions in France. A treaty between the French king and the Duke of Burgundy greatly advanced the French cause. In 1436, C. entered Paris; and during the further progress of the war, the English lost all their strongholds except Calais. In 1452, they were finally defeated at Castillon. After he was established on his throne, C. devoted himself to the reorganisation of the government, in which everything had fallen into confusion, but shewed a strong anxiety to frame it according to a scheme of perfect despotism, and for this purpose to provide himself with a powerful and well-disciplined standing army, which caused some discontentment among the nobles of his kingdom. His government, however, was mild, and under it France recovered in some measure from the effects of the terrible calamities which it had endured. His last years were embittered by the conduct of his son, the Dauphin, afterwards Louis XI.; and his apprehension that his son would poison him was so strong, that his consequent abstinence from food is supposed to have hastened his death, which took place at Melun on 22d July 1461.

CHARLES VIII., king of France (1483—1498), was born at Amboise on 30th June 1470, and succeeded to the throne on the death of his father, Louis XI. For some time the government was carried on under the regency of his sister, Anne of Beaujeu. When C. attained his twenty-first year, he took the royal power into his own hand, and soon developed a bold and ambitious spirit. The most important incident of his career was his conquest of Naples in 1495, to the throne of which he believed he had a claim. The Italian princes and other European potentates were alarmed by his success. A league was hastily formed between the pope, the emperor of Germany, Ferdinand of Spain, the republic of Venice, and Sforza, Duke of Milan, to oppose his return to France. C., however, gallantly broke through the allied forces near Piacenza, and effected a retreat to his own country. It was with difficulty he was hindered by his councillors from resuming his warlike designs on Italy. C. is also said to have meditated the expulsion of the Turks from Europe, and making himself emperor of Constantinople; having received from Andreas Palæologus, the grandson of the last Grecian emperor, a transference of his claims to the Byzantine throne. He died 7th April 1498.

CHARLES IX., king of France (1560—1574), the second son of Henry II. and of Catharine de' Medici (q. v.), was born at St Germain-en-Laye on 27th June 1550, and on 5th December 1560 succeeded to the throne on the death of his brother, Francis II. His character was a compound of passion, acuteness, heartlessness, and cunning. Although only 24 years of age when he died, so well had his detestable mother trained him to a love of perfidy and cruelty, that he found time, with her assistance and that of the Guises, to perpetrate an act so hideously diabolical, that all civilised Europe still shudders at the recollection. The massacre of St Bartholomew's (q. v.), 24th August 1572, was the culmination of a series of treacheries towards the Huguenots, which disgraced his reign. The result was, that civil war broke out anew, and assumed a very threatening character, as political malcontents associated themselves with the Protestants. C. died May 30, 1574.

CHARLES X., king of France (1824—1830), third son of the Dauphin Louis, and grandson of Louis XV., was born at Versailles, 9th October 1757. He received the title of Count d'Artois, and in 1773 married Maria Theresa of Savoy. After

the events of 14th July 1789, he and the Prince of Condé took the lead in the emigration. In 1796, he sailed from England with a squadron under Commodore Warren, on an expedition to the western coasts of France, whereupon twenty departments rose in insurrection; but he had not courage to land and place himself at the head of the insurgents, whom he basely left to the vengeance of the republicans. Detested now by the royalists of France, and despised by the British, he lived in obscurity until the allies entered Paris in 1814, when he appeared in France as lieutenant-general of the kingdom, and issued a proclamation announcing the end of despotism, of conscriptions, and of oppressive taxes. After the second restoration, he took little open part in politics, but lived surrounded with priests, Jesuits, and nobles of the old school; and in this circle originated the tyrannical and unconstitutional measures to which even Louis XVIII. made considerable opposition, but which at this time disgraced the government of France. The death of Louis, on 16th September 1824, brought C. to the throne. He took the oath of adherence to the charter, but soon displayed his intention of restoring as much as possible the absolutism of the old French monarchy. Popular discontent rapidly increased. A royal speech, of a threatening character, on 2d March 1830, was followed by an address of remonstrance, signed by 221 deputies, upon which the king dissolved the chambers. The deputies who signed the address were all re-elected, but the court taking fresh courage from the success of the expedition to Algiers, the celebrated ordinances of 25th July were signed by the king, putting an end to the freedom of the press, already largely curtailed, appointing a new mode of election, and dissolving the recently elected chamber. The capital took up arms, the guards refused to act, and the king soon found himself compelled to flee. As a last resource, he abdicated the throne, on 2d August 1830, in favour of his grandson, Henry, Duke of Bordeaux; the Dauphin also consenting to this act. But it was too late; the revolution was accomplished, and Louis Philippe, Duke of Orleans, was chosen king of the French. C. made his escape to England, resided for some time at Holyrood, and afterwards at Prague. He took no part in the political intrigues and attempts of the Duchess de Berri. He died of cholera at Görz, on 6th November 1836. His only surviving descendant, in the male line, is his grandson, the Count of Chambord (q. v.).

CHARLES IV., German emperor (1346—1378), was born at Prague in 1316, and was the son of King John of Bohemia, of the House of Luxembourgh, who fell in the battle of Crecy. At the instigation of Pope Clement VI., to whom he had previously taken an oath of humiliating submission at Avignon, he was elected emperor by a portion of the electors on 11th July 1346, although Louis IV. then actually filled the imperial throne. But even after the death of Louis, it was not without difficulty that he obtained secure possession of it. He was crowned king of Italy at Milan in 1354, and emperor at Rome in 1355. In 1356, he issued the Golden Bull (q. v.), the fundamental law concerning the election of German emperors; in defiance of the very letter of which he afterwards, by large bribes, secured for his own son, Wenceslaus, the succession to the empire. He died at Prague, 29th November 1378. C. was an artful politician, but destitute of true greatness. He sought the support of the clergy by undue concessions, sold rights and privileges in Italy and other parts of the empire for money, and cared chiefly for the prosperity of his hereditary kingdom of Bohemia.

CHARLES V., German emperor, was born at Ghent on 24th February 1500. He was the eldest son of Philip, Archduke of Austria, and of Joanna, the daughter of Ferdinand and Isabella of Spain. Philip's parents were the Emperor Maximilian and Maria, daughter and heiress of Charles the Bold, Duke of Burgundy. On the death of his grandfather, Ferdinand, in 1516, C. took possession of the throne of Spain by the title of Charles I., his mother Joanna being of disordered intellect and incapable of reigning. He was not, however, very favourably received by the Spanish nobles, who were doubtful of his right, and jealous of the followers whom he brought from the Low Countries, where he had been educated. All the abilities of his famous minister Ximenes (q. v.) were requisite to prevent an open revolt. On the death of Maximilian in 1519, C. was elected German emperor from amongst a number of competitors, chiefly through the influence of the Elector Frederic of Saxony. In his earlier years he had been frivolous and dissolute, but he now became mindful of the duties and dignity of his high position. On 22d October 1520, he was crowned at Aix-la-Chapelle, and received from the pope the title of Roman emperor. He ascended the imperial throne at a time when Germany was in a state of unprecedented agitation concerning the doctrines proclaimed by Luther. To restore tranquillity, a great diet was held at Worms in 1521, Luther's declaration of his principles before which forms a well-known and important passage in the history of the Reformation. In 1522 he reduced to subjection the towns of Castile, which had leagued themselves together for the maintenance of their ancient liberties. He was likewise successful in his war against the Turks under Solymán the Great. C. was involved also in a struggle of long duration with France, in which, after many alternations of fortune, his armies at last drove the French from the greater part of their conquests in Italy; and Francis I. of France fell into his hands as a prisoner, after a battle by which the siege of Pavia was raised on 24th February 1525.

The pope, however, began to grow alarmed at his victories, and therefore allied himself with France and the principal Italian states, and released the king of France from the obligations under which he had come by his treaty with Charles. It was the pope's object to exclude C. from all dominion in Italy; but the emperor's forces under Charles of Bourbon, the former Constable of France, took Rome itself by storm, plundered it, and made the pope prisoner. C. pretended great regret for this, went into mourning with all his court, and caused prayers to be said for the pope's liberation, whilst by his own directions the pope was kept for seven months a captive. Peace was concluded in 1529, on terms most favourable for the emperor. He now thought to put an end to the religious differences in Germany, and to repel the Turks, who had overrun Hungary and laid siege to Vienna. But the Diet at Augsburg in 1530, proved how vain was the hope of restoring the former state of things in Germany; and the emperor refusing to recognise the confession of the Protestants, they refused to help him against the Turks. In 1531, the Protestant princes formed the League of Smalcald (q. v.), and allied themselves with France and England for their own protection. This, and the continued assaults of the Turks, compelled the emperor to yield in some measure to the demands of the Protestants. In 1535, C. undertook an expedition from Spain against the pirate Barbarossa, who had established himself in Tunis, and whose vessels did prodigious injury to the commerce of Spain

and Italy. In this expedition he was completely successful, and set free no fewer than 22,000 Christians, who had been held as slaves. War again broke out with France; an armistice for ten years was concluded in 1538; and C. even visited Paris, where he was magnificently entertained. But the war broke out afresh in 1542, and terminated in favour of the emperor; who also triumphed in the battle of Mühlberg, 25th April 1547, over the Protestant princes of Germany, and deprived the Elector John Frederic of Saxony of his territories. But he shewed so plainly his intention of converting the German empire into a hereditary possession of his family, that new opposition arose, and C. was compelled to flee before the arms of Duke Maurice of Saxony and the Protestants, and in 1552 to promise them the peaceful exercise of their religion, which was confirmed by the Diet at Augsburg in 1555. Henry II. of France also took from C. some parts of Lorraine. His health failing, C. now declared, in an assembly of the States at Louvaine, his resolution to seek repose, and devote the remainder of his days to God. He resigned the government of his dominions to his son, for whom, however, he vainly sought to secure the imperial throne; and having relinquished to him the crown of Spain on 15th January 1556, he retired to the monastery of Yuste, in Estremadura, where he spent two years partly in mechanical amusements, partly in religious exercises, which are said to have assumed a character of the most gloomy asceticism, and died on 21st September 1558. By his wife Isabella, daughter of King Emmanuel of Portugal, he had one son, his successor, Philip II. of Spain, and two daughters. His brother Ferdinand succeeded him in the empire.

CHARLES VI., German emperor (1711—1740), the last of the proper male line of the House of Hapsburg, was the second son of the Emperor Leopold I., and born 1685. His father intended for him the crown of Spain; but Charles II. of Spain, yielding to French intrigues, assigned it by testament to Philip of Anjou, whereupon arose the great war of the Spanish succession—Britain and Holland taking part with the emperor against France, for the maintenance of the balance of power in Europe. C. was acknowledged by the allies as Charles III. of Spain, but had not succeeded in obtaining permanent possession of the kingdom, when the death of his brother, the Emperor Joseph I., recalled him to Germany in 1711; and as he now became emperor of Germany, Britain and Holland concluded the Peace of Utrecht with France in 1713. C. continued the war for some time longer; but was at last obliged to give up his claim to Spain, being confirmed, however, in possession of the Spanish Netherlands and of the Spanish possessions in Italy. Success attended his arms in a war against the Turks, and in a war with Spain, which arose out of the projects of the Spanish minister Alberoni, and in which the *Quadruple Alliance* was formed—France, Britain, and Holland joining the emperor against Spain. But C., having lost his only son, and being very anxious to secure the throne to his own descendants, named his daughter, Maria Theresa (q. v.), as his heiress, by a *Pragmatic Sanction* (q. v.), to which he had much difficulty in obtaining the consent of some of the German states and some foreign powers; and to accomplish this object he gave up Tuscany, Parma, and Piacenza, and afterwards Naples, Sicily, Lorraine, and some parts of Milan. Meanwhile, he was unsuccessful in wars with France and Spain, and with the Turks, who compelled him, in 1739, to resign his former conquests. He died 20th October 1740. He was of a

CHARLES VII.—CHARLES XIV.

mild and benevolent disposition, but full of superstition and of prejudices in favour of feudalism and ecclesiastical domination.

CHARLES VII., German emperor (1742—1745), was born at Brussels in 1697, and was the son of Maximilian Emmanuel, Elector of Bavaria, and for some time governor of the Spanish Netherlands. After the conquest of the Bavarian territories, and the pronouncement of the ban of the empire against his father by the Emperor Joseph I., he was for some time the emperor's prisoner; but after the decease of Joseph, he married his youngest daughter; and having, in 1726, succeeded his father as Elector of Bavaria, refused his consent to the Pragmatic Sanction (see preceding article); and on the death of Charles VI. in 1740, advanced a claim to the Austrian dominions in right of his wife, and upon the further ground of a testament of Ferdinand I. Success at first attended his arms; he was acknowledged as Archduke of Austria, and then as king of Bohemia, upon which he was also, in 1742, elected emperor. But the tide of fortune now turned against him. The Hungarians rose in favour of Maria Thérèse, and he was driven from Austria and from Bohemia, and for a time even from his Bavarian capital, Munich. Disease and calamities combined to cause his death, 20th January 1745, shortly before which he said, 'Misfortune will never leave me, till I leave it.'

CHARLES XII., king of Sweden (1697—1718), was the son of Charles XI., and was born at Stockholm on 27th June 1682. On the death of his father in 1697, he ascended the throne, and notwithstanding his youth, the States declared him of age to assume the reins of government. The neighbouring powers thought this a favourable time to humble Sweden, then the great power of the north; and Frederick IV. of Denmark, Augustus II. of Poland, and the Czar Peter I. concluded a league for this object. The Danes began by invading the territory of the Duke of Holstein Gottorp, who had married C.'s eldest sister, and who applied to him for assistance. The young king immediately resolved on the most active measures, and approached Copenhagen with such a force as presently compelled the Danes to make peace. C. now hastened to meet the Russians; and although they lay in an intrenched camp beneath the walls of Narva, 50,000 strong, he stormed their camp on 30th November 1700, with 8000 Swedes, and defeated them with great slaughter. He next dethroned Augustus II., and procured the election of Stanislaus Leszcynski as king of Poland. Augustus supposed himself safe at least in Saxony, his hereditary dominion, but was followed thither, and humbling terms of peace were dictated at Altranstädt in 1706. C. obtained from the emperor liberty of conscience for the Protestants of Silesia. Leaving Saxony with an army of 43,000 men in September 1707, he proposed to advance direct upon Moscow; but at Smolensk he was induced, by the representations of the Cossack *hetman*, Mazzeppa, to change his plan and proceed to the Ukraine, in hope of being joined by the Cossacks. In this hope, however, he was disappointed, and after enduring many hardships, he was defeated by the Russians at Pultowa, on the 27th June 1709, and fled to Bender in the Turkish dominions.

Augustus II. now revoked the treaty of Altranstädt, and the czar and the king of Denmark assailed the Swedish territories. But the regency in Stockholm adopted measures of effective and successful resistance, and C. prevailed with the Porte to declare war against Russia, in which Peter seemed at first likely to have suffered a severe

defeat. But Russian agents succeeded in inspiring the Turks with suspicions concerning the ultimate designs of C., who was conveyed to Adrianople, but after some time escaped, and made his way through Hungary and Germany, pressing on by day and night with extraordinary speed, till he reached Stralsund, where he was received with great joy, on 11th (22d) November 1714. He was soon, however, deprived of Stralsund by the allied Danes, Saxons, Prussians, and Russians. After he had adopted measures for the security of the Swedish coasts, his passion for war led him to attack Norway. Success appeared again to attend his arms, when, in the siege of Friedrichshall, on 30th November 1718, he was killed by a musket-bullet. On his death, Sweden—exhausted by his wars—ceased to be numbered among the great powers. He was a man capable of comprehensive designs, and of great energy in prosecuting them. His abilities appeared not merely in military affairs, but in his schemes for the promotion of trade and manufactures. His self-willed obstinacy, however, amounted almost to insanity; in fact, he has been termed 'a brilliant madman.' His habits were exceedingly simple: in eating and drinking, he was abstemious; and in the camp, he sought no luxuries beyond the fare of the common soldier.

CHARLES XIII., king of Sweden (1809—1818), born October 7, 1748, was the second son of King Adolphus Frederic, and of the sister of Frederic the Great of Prussia. He was trained for naval command, and was long the High Admiral of Sweden, in which capacity he distinguished himself by a great victory over the Russians in the Gulf of Finland in 1788, and by bringing back his fleet safe to Carlscrona in the most perilous season of the year. He was on several very important occasions called to an active part in political affairs—in the revolution of 1772, when he was made governor-general of Stockholm and Duke of Södermanland; after the assassination of his brother Gustavus III. in 1792, when he was placed at the head of the regency; and after the revolution of 1809, when he became administrator of the kingdom, and subsequently king. The Swedish monarchy now became limited instead of despotic. Having no child, C. concurred with the States of the kingdom in choosing as his successor the French general, Bernadotte, who became crown-prince of Sweden, and ascended the throne on the death of C., February 5, 1818. The prudence of the king and crown-prince secured the union of Norway with Sweden in 1814, as a compensation for Finland.

CHARLES XIV., king of Sweden and Norway (1818—1844), originally JEAN BAPTISTE JULES BERNADOTTE, was born at Pau, in the south of France, January 26, 1764. He was the son of a lawyer. He entered the French army as a common soldier, became an ardent partisan of the revolution; greatly distinguished himself in the wars of Napoleon, and soon attained the highest military rank. But he was distrusted by Bonaparte, whose ambitious schemes he took no part in promoting; and Napoleon having taken offence at his conduct after the battle of Wagram, Bernadotte left the army in disgust, and returned to Paris. He was afterwards sent by the ministerial council to oppose the British, who had landed at Walcheren, but the breach between the emperor and him grew wider. In 1810, he was elected crown-prince, and heir to the throne of Sweden. Almost the only condition imposed on him was that of joining the Protestant church. He changed his name to Charles John; and the health of the Swedish king, Charles XIII., failing in the following year, the

reins of government came almost entirely into his hands. He refused to comply with the demands of Napoleon, which were opposed to the interests of Sweden, particularly as to trade with Britain, and was soon involved in war with him. He commanded the army of the allies in the north of Germany, and defeated Oudinot at Grossbeeren, and Ney at Dennewitz. He shewed great reluctance, however, to join in the invasion of France, and was tardy in his progress southward.—He became king of Sweden on the death of Charles XIII., February 5, 1818. He won for himself the character of a wise and good king. Education, agriculture, manufactures, commerce, and great public works, as well as the military strength of the kingdom, were promoted by his care. He died March 8, 1844, and was succeeded by his son Oscar.

CHARLES ALBERT, king of Sardinia (1831—1849), born 2d October 1793, was the son of the Prince Charles Emmanuel of Savoy-Carignan, and in 1800, succeeded to his father's title and estates in France and Piedmont. In 1817, he married Maria Theresa, daughter of the Archduke Ferdinand of Tuscany. When the revolutionary movement took place in Piedmont in 1821, he was made regent, upon the abdication of Victor Emmanuel, until Charles Felix, the brother of the late king, should arrive to assume the sovereignty. He displeased both the liberal party and their opponents, and Charles Felix disallowed all his acts, and for some time forbade his appearance at court. In 1829, he was appointed viceroy of Sardinia. On the death of Charles Felix, 27th April 1831, he ascended the throne. The liberals had great expectations from him, but were for a long time disappointed; his government much resembled the other Jesuitic and despotic Italian governments, except that he sought to promote the interests of the country, and to restrict the influence of the clergy in political affairs. It was not till after the elevation of Pius IX. to the papedom, when a new impulse was given to the cause of reform, that the Sardinian government adopted the constitutional and liberal policy to which it has since adhered. C. A. entered warmly into the project of Italian unity, and evidently expected to place himself at the head of the whole movement and of the new kingdom of Italy. When the Lombards and Venetians rose against the Austrian government, he declared war against Austria, 23d March 1848, and at first was exceedingly successful, but was insufficiently supported by the Lombards, and finally defeated by the Austrians; so that after the fatal battle of Novara, 23d March 1849, he was obliged, for the preservation of the integrity of his kingdom, to resign the crown in favour of his son, the present king, Victor Emmanuel. Retiring to Portugal, he died at Oporto on 28th July of the same year.

CHARLES EMMA NÜEL I., Duke of Savoy (1580—1630), called the Great, was born at the castle of Rivoli, 12th January 1562, and succeeded his father Emmanuel Philibert in 1580. He married a daughter of Philip II. of Spain, and at first allied himself politically with Spain, and made war against France for the marquise of Saluzzo (or Saluces), which he obtained in 1601, upon the cession of some other territories to France. But he afterwards joined France and Venice to oppose the preponderant power of Spain in Italy; then allied himself with the House of Hapsburg, and set up a claim to Montserrat, but suffered, in consequence, the direst calamities, great part of his dominions being conquered by the French, and in their hands when he died, 26th July 1630. He was a prince of vast ambition, and for whom no enterprise was too bold.

CHARLES THE BOLD, Duke of Burgundy (1467—1477), son of Philip the Good, of the House of Valois, and of Isabella of Portugal, was born at Dijon on 10th November 1435, and bore, during his father's life, the title of Count of Charolais. He was of a fiery, ambitious, and violent disposition. From an early period to the end of his life he was a declared enemy of Louis XI. of France, the nominal feudal superior of Burgundy. Louis having caused Philip to deliver up some towns on the Somme, C. left his father's court, and formed an alliance with the Duke of Bretagne and some of the great nobles of France for the maintenance of feudal rights against the crown. Their forces ravaged Picardy and Isle-de-France, they threatened Paris, and defeated the king at Monthéry. The result was a treaty by which the Count of Charolais obtained the towns on the Somme and the counties of Boulogne, Guines, and Ponthieu for himself. In 1467, he succeeded his father as Duke of Burgundy. Richer and more powerful than any prince of that time, he conceived the design of restoring the old kingdom of Burgundy, and for this purpose of conquering Lorraine, Provence, Dauphiny, and Switzerland. Whilst he was making preparations for war, Louis invited him to a conference; he hesitated, and Louis by his agents stirred up the citizens of Liege to revolt. Meanwhile C. consented to the conference, and the news coming of what had taken place at Liege, he seized the king, and if he had not been withheld by his councillor Comines, would have put him to death. He compelled Louis, however, to accompany him to Liege, and apparently to sanction the cruelties which he inflicted on the citizens. War raged between them afterwards with little intermission, till 1475. In September of that year, C. found himself at leisure to attempt the prosecution of his favourite scheme of conquest, and soon made himself master of Lorraine. In the following year he invaded Switzerland, stormed Grandson, and hanged and drowned the garrison; but was soon after terribly defeated by the Swiss near that place, and lost his baggage and much treasure. Three months after, he appeared again in Switzerland with a new army of 60,000 men, and laid siege to Morat, where he sustained, on June 22, 1476, another and more terrible defeat. After this he sank into despondency, and let his nails and beard grow. But the news that the young Duke René of Lorraine was attempting to recover his territories, roused him, and he laid siege to Nancy. His army was small; Italian auxiliaries, whom he had hired, went over to the enemy; and in the battle which he too rashly fought, he lost his life, January 5, 1477. His daughter and heiress, Maria, married the Emperor Maximilian I. With his life ended the long successful resistance of the great French vassals to the central power of the monarchy.

CHARLES'S WAIN, a common name for the constellation of Ursa Major (q. v.).

CHARLESTON, the chief city of a district of its own name in South Carolina, and the commercial capital of the state, is situated in lat. 32° 46' N., and long. 79° 57' W. With straight and regular streets, it occupies the fork of the Cooper and the Ashley, which, as deep tideways of the respective widths of 1400 and 2100 yards, here unite with their common estuary of 7 miles in length to form Charleston harbour. This haven is beset to seaward by a sand-bar, which has its uses, however, as a breakwater and a bulwark. The more practicable of its two passages—shewing 16 feet at ebb and 22 at flood—is commanded by Fort Moultrie on Sullivan's Island; while, moreover, two inner islets, which divide the

CHARLESTOWN—CHARON.

distance towards the city into three nearly equal reaches, have been strengthened into successive positions of defence. A fourth island contains, in lat. 32° 42' N., and long. 79° 54' W., a revolving light 125 feet high. In 1858, the exports were valued at 16,924,436, and the imports at 2,071,519 dollars. The great disproportion between the value of the export and import trade, to whatever extent it may be produced by extraneous causes, is normal among the Slave States—their average ratio of imports and exports being, in 1857, as 1 to 4. At the one extreme of the scale, Alabama gave 1 to 29; while, at the other, Maryland stood as 3 to 4, being still a striking contrast to conterminous Pennsylvania, with its corresponding results of 5 and 2. While the exports, chiefly cotton and rice, have leaped up 44 per cent. between 1854 and 1856—a once flourishing branch of industry has dwindled away to nothing. In 1853, 1854, 1855, 1856, and 1857 respectively, the vessels built at C. were 38, 23, 1, 4, and 6—the lumber shipped having meanwhile been not less than 20,000,000 feet a year. In 1850, the population was 42,985, having since 1840 increased nearly 14,000. The last census gave only 14,692 slaves. C. was founded in 1672, receiving from France, about 1685, a considerable influx of Protestant refugees. It was prominent for zeal and gallantry in the revolutionary war.

CHARLESTOWN, a seaport of Massachusetts, in lat. 42° 2' N., and long. 71° 3' W. It occupies a peninsula about 2 miles long, immediately to the north of Boston, the capital of the state; of which, connected as the two are by bridges, it is virtually a suburb. Its population, when last reckoned, was 17,126. In common with the rest of the neighbourhood, the peninsula displays an unevenness of surface which renders the streets, otherwise handsome, somewhat irregular. Its most prominent height is Bunker's Hill, celebrated as the first battle-field in the revolutionary war, and surmounted, in 1825—1843, by a granite monument of 220 feet in height. Besides a state-prison on a large scale, the city possesses one of the principal navy-yards of the general government. This establishment, covering 70 or 80 acres, contains a magnificent rope-walk 1300 feet long, and a dry-dock of chiseled granite measuring 80 feet in breadth by 30 in depth, which cost fully 670,000 dollars.

CHARLET, NICOLAS TOUSSAINT, a French painter and engraver, born in Paris 1792, was for some years employed as a clerk in a government office, but lost his place at the restoration, 1815, on account of his Bonapartism, and in consequence betook himself to art. After studying awhile under Gros, he gradually formed for himself a style in which he had no rival. C. is the Béranger of caricature, but without the political bitterness and sarcasm sometimes found in the poet. His genial sketches of French life and manners were studied with equal admiration in the salons of the aristocracy and in the ateliers, barracks, taverns, &c., of the lower classes. C. was especially successful in his sketches of soldiers and children. His designs are free from exaggeration, while full of spirit, interest, and naïveté; and his titles or mottoes were often so witty and suggestive, that dramatic writers have founded pieces upon them. His sketches and lithographs are very numerous, and are widely distributed. Among his paintings, the most remarkable are—'An Episode in the Russian Campaign' (in the Museum at Versailles); 'Moreau's Crossing of the Rhine' (at Lyon); and a 'Procession of the Wounded' (at Bordeaux). C. died in 1845.

CHARLEVILLE, a town of France, in the

department of Ardennes, about a mile from Mezières, with which it communicates by a suspension-bridge over the Meuse. It is a thriving place, well built, with clean spacious streets. It has manufactures of hardware, leather, and beer, and the Meuse affords facilities for considerable trade in coal, iron, slate, wine, and nails. Pop. 8268.

CHA'RLOCK. See **MUSTARD**.

CHARLOIS, a village of the Netherlands, situated on the Maas, about two miles south-south-west of Rotterdam. It is memorable on account of a terrible accident which occurred here in 1512, when a religious procession crossing the ice in defiance of magisterial prohibition, 8000 of them were precipitated into the Maas. Pop. 2000.

CHARLOTTE AMALIE, chief, or rather only, town of St Thomas, one of the Virgin group of the Antilles, in lat. 18° 20' N., long. 64° 55' W. It contains 10,100 inhabitants, nearly three-fourths of the entire population of the colony. It has a spacious harbour, which, besides being largely visited by European ships in general, is a principal station for the mail-packets between Southampton and the West Indies.

CHARLOTTE TOWN, the capital of Prince Edward Island, in the Gulf of St Lawrence, in lat. 46° 15' N., and long. 63° 7' W. It contains within its royalty, about 5000 inhabitants. Its port is the best in a colony which, in proportion to its size, is remarkable for its navigable facilities. The town stands on the south-east coast at the bottom of Hillsborough Bay, and at the confluence of three rivers, which each admit the largest vessels for several miles, so as to secure them from all weather. The harbour is rendered still more commodious through the strength of the tides, which enable ships to work out and in against the wind. C. T. has an iron foundry and a woollen factory, and is largely engaged in ship-building.

CHARLOTTENBURG, a town of Prussia, in the province of Brandenburg, is situated on the Spree, 3 miles west of Berlin, with which it is connected by a road leading through the *Thiergarten*, and affording a favourite promenade to the Berliners. C. contains a royal palace, with a fine garden and splendid orangery, and an interesting collection of antiquities and works of art. In a beautiful part of the park a mausoleum, designed by Schinkel, contains the remains of Frederick William III. and his wife, the Queen Luise, with their statues by Rauch. C. has manufactures of cotton and hosiery, and a population of about 8000.

CHARM (Lat. *carmen*, a song), properly, a form of words, generally in verse, supposed to possess some occult power of a hurtful, a healing, or a protective kind. Charms exert their influence either by being recited, or by being written and worn on the person; and, in this latter case, they may be classed with Amulets (q. v.). The nature of this superstition will be more fully considered under **INCANTATION**; see also **MAGIC**.

CHARNEL-HOUSE (Fr. *charnier*; Lat. *caro*, flesh), a chamber situated in a churchyard or other burying-place, in which the bones of the dead which were thrown up by the grave-diggers were reverently deposited. The C. was generally vaulted in the roof, and was often a building complete in itself, having a chapel or chantry attached to it. In such cases, the charnel-vault was commonly a crypt under the chapel; and even in churches, it was not uncommon for the vault or crypt to be employed as a charnel-house.

CHA'RON, in classical mythology, the son of Erebus and Nox, is first mentioned by the later

writers of Greece. His duty was to ferry the shades of the buried dead across the rivers of the under-world. For this service, he exacted an *obolus* from each, and in consequence, a coin of this kind was placed in the mouth of the dead. If this rite was neglected, C. refused to convey the unhappy shade across, and it was doomed to wander restlessly along the shores of Acheron. C. is generally represented as a gloomy old man, with a rough beard and wretched clothes. In the Etruscan monuments, he holds a hammer.

CHARR (*Salmo umbla*), a fish of the same genus with the salmon, occurring in the lakes of Britain and of the continent of Europe. It is abundant in the lakes of Cumberland and Westmoreland, and in some of those of Ireland, of the north of Scotland, and of Orkney, but in the greater number of the Scottish lakes it is not found. It is the celebrated *ombre chevalier* of the Lake of Geneva. It is sometimes found weighing more than 2 lbs., but is generally under 1 lb. in weight. It has only the anterior part of the *vomer* (the middle line of the palate) furnished with the teeth, agreeing in this with the salmon and bull-trout, and differing from the common trout, salmon-trout, &c. The form is elongated, the greatest depth of the fish about one-fifth of the entire length; the fins are rather small; the tail deeply forked; the colour of the back dark olive, the sides lighter and spotted with either red or white, according to the condition in which the fish is at the time, the belly also being sometimes deep orange, and sometimes of a pale colour; these, and other accidental variations, causing the fish to receive different names, such as *Case C.*, *Red C.*, *Gilt C.*, *Silver C.*, and having led some naturalists to believe in the existence of different species. It is not yet quite certain whether the *Torgoch* or *Red-belly* of Wales (*Salmo salvelinus* of some authors) ought to be regarded as distinct or as a mere accidental variety. Whilst it is the most delicious perhaps of the *Salmonida*, the C. is also the most beautiful; its rich purple, rosy, and crimson tints and white spots rendering it indeed a brilliant and striking object. During summer, the C. haunts chiefly deep cool water, and is seldom seen at the surface till late in autumn. It feeds on insects and minute crustaceans. In the end of autumn or beginning of winter, it ascends rivers to spawn, always choosing those which have a rocky bottom. Whether in lake or stream, it is only to be found in clear waters. Unfortunately, the C. of the English

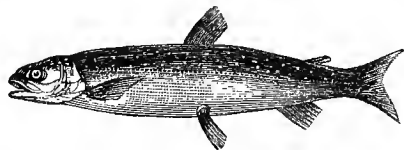

Charr (*Salmo umbla*).

lakes is taken in great numbers, by nets, at the mouths of streams, when about to ascend them in order to spawn, and when not in the best condition for the table.

On some lakes, vast quantities are then caught for the table, particularly for the purpose of potting. A C. is now and then taken with fly when the angler may be whipping a lake, which perhaps abounds with them, for trout; but this occurs but seldom. The C. will, too, occasionally take a minnow, if sunk deep and trailed slowly; but the sport it affords is of the most precarious nature. C. are fast diminishing in those of our English lakes which they still inhabit, owing to the wholesale

and indiscriminate slaughter which occurs at the spawning season. A large kind of C., sometimes reaching 4 lbs. in weight, is found in some of the more northern Swedish lakes.

CHART, a marine or hydrographical map, exhibiting a portion of a sea or other water, with the islands, coasts of contiguous land, soundings, currents, &c. See **MAP**. In the English service, when coasts have been surveyed by the Admiralty, charts are engraved, and are sold at various prices, from 3s. down to 6d. each. This price is below their cost, the object being to encourage their general use as much as possible. Men-of-war are supplied with copies of every available C. published, relating to the regions likely to be visited. There is a printed list for every station. At Gibraltar and the Cape of Good Hope, there are depôts of charts to supply ships whose destination undergoes a change. All the charts are brought home again, and none are re-issued until revised and corrected. The navigating charts, shewing the dangers of coasts, with sufficient clearness to enable mariners to avoid them, are generally on the scale of half an inch to a mile; those of larger size shew all the intricacies of the coast. The merchant-service is supplied with charts by agents, who receive a stock from the Admiralty, and keep them on sale. The preparation of charts is part of the duty of the hydrographical department at the Admiralty. In the financial year 1860—1861, a sum of no less than £11,000 was provided for this branch, quite irrespective of the surveying that preceded the engraving of the charts, which always costs a much larger sum. In the five years ending with 1859, the Admiralty sold 290,000 charts, besides supplying the Queen's ships.

CHARTA, MAGNA. See **MAGNA CHARTA**.

CHARTE (Fr. a charter; Lat. *charta*, paper). In the sense in which we have adopted this word from the French, and in which it may be now said to form part of our language, it signifies a system of constitutional law, embodied in a single document. Whether any system of positive public law existed in ancient France is, in that country, a subject of keen dispute amongst constitutional antiquaries. If any such there was, there seems little doubt that it was the mere embodiment of traditions, and not the result of any single act of the national will. Whilst France was divided into provinces and communes, local liberties and privileges unquestionably existed; but where the nation constituted no single body, a constitutional charter was impossible. The first traces of such a C. appear in the 14th c.; and it is known in the history of the public law of France as the *Grand Charter*, or the charter of King John. Up to this time, the kings had called together only partial assemblies, but in 1355 deputies from the whole kingdom were assembled in the hall of the Parliament of Paris. The nobility and clergy, secular and regular, were represented by 400 deputies, the commons or third estate by a like number. This body assumed to itself the initiative, and prepared a species of constitution, which was accepted by the king. The chief triumph of the third estate on this occasion consisted in carrying through the doctrine, that the decision of any two estates should be invalid without the concurrence of the third. The three orders, who seem to have composed but one assembly, then proceeded to impose a series of restrictions on the power of the monarch, which, confirmed by the dauphin two years later, formed the foundation for the liberties subsequently asserted at the Revolution.

But the constitution to which the term C. is most frequently applied by the French and by

us, is that in which Louis XVIII. solemnly acknowledged the rights of the nation on his restoration in 1814. This C. has ever since been considered the fundamental law of constitutional monarchy when that form of government has existed in France. In some of its provisions, however, and still more in the mode of its acceptance by the monarch, as 'a voluntary and free act of our royal authority,' and as a 'concession made to,' not a contract entered into with, his subjects, it was open to the misconstructions which eventually led to the revolution of 1830. The 'charte' sworn to on the 29th August of that year by King Louis Philippe modified this and some of the other provisions of that of 1814. On that occasion, the king explicitly recognised the sovereignty of the people. This document, which, with some modifications, remained in force till the revolution of 1848, is of so much importance, not only from its bearing on the past history, and possibly on the future destiny of France, but from the analogies which it presents to our own constitution, that we shall endeavour to present a condensed view of its leading provisions.

It consisted of 67 articles, divided into 7 heads. Of these, the 1st head, containing 11 articles, treated of the public rights of the French people. It provided for the equality of all Frenchmen—a doctrine which it inherited from the Revolution, and which it unfortunately left to be understood in a sense inconsistent with monarchy, and indeed with any other form of government than pure democracy (see EQUALITY)—for their equal admissibility to all employments, civil and military, and for their freedom from arrest, otherwise than by legal process. It guaranteed the enjoyment of religious liberty, and the payment of the ministers of all Christian denominations—a privilege which in 1831 was extended even to Jews. The liberty of printing and publishing was insured, the censorship of the press and conscription were abolished, an amnesty for all political offences was proclaimed, and the security of property guaranteed, except when its sacrifice should be requisite for the public good, in which case it was declared that the owner must be indemnified. The 2d head set forth the nature and limitations of the kingly power in 8 articles. The supreme executive power, the command of the army and navy, and the right of making war, and treaties of peace, alliance, and commerce, were reserved to the monarch. To him, also, it belonged to nominate to all offices of public administration, to make all necessary regulations for the execution of the laws, but in no case to suspend them or dispense with them. The high duties of legislation were shared between the king, the Chamber of Peers, and the Chamber of Deputies; it being provided that every law should be agreed to by a majority of each chamber, and sanctioned by the king. Any one of the three branches of the legislature might originate any bill, except a money-bill, which was reserved for the Chamber of Deputies, as for the House of Commons in England. The 3d head contained ten articles regarding the Chamber of Peers, the nomination of whom was vested in the king (the princes of the blood being peers by right of birth). No limit was set to their number; but by the law of 9th December 1831, incorporated in the C., it was declared that their dignity should be for life only. The Chancellor of France was president. The Chamber of Peers assembled simultaneously with that of the Deputies, and its sittings were public. The personal privileges of the peerage, as they exist in England, were introduced. The 4th head concerning the Chamber of Deputies contains 16 articles. It provides for the election of the deputies and the sittings of the chamber. The electoral qualification is declared to be the payment of 200

francs of direct taxes, whilst that of a deputy is the payment of 500. The voting is by ballot, both at elections and in the chambers. The number of deputies, which at first was 430, was afterwards raised to 459. Each deputy was elected for five years, and one half of those for each department were required to have their political domicile within it. The C. became a nullity by the revolution of February 1848; and by the new constitution promulgated on the 4th of November of that year, the monarchy of France was converted into a democracy. By chapter 4 of that document, the legislative power was vested in a single assembly of 950 members, including the representatives of Algeria and the other colonies. The property electoral qualification was abolished, and the age reduced for electors to 21, and for delegates to 25. The period of three years was fixed for the continuance of the national assembly. By chapter 5, the executive power was intrusted to a citizen, who was to bear the title of President. He was not to be less than 30 years of age, his tenure of office was to be 4 years, and he was not to be re-eligible until after an interval of 4 years. For an account of the subsequent changes by which these and the other arrangements adopted at the revolution of 1848 have since been superseded, see FRANCE.

CHARTER (Lat. *charta*; Gr. *chartes*, paper, or anything written upon, from *charasso*, to scratch or write). In its most general signification, C. is nearly synonymous with *deed* and *instrument*, and is applied to almost any formal writing, in evidence of a grant, contract, or other transaction between man and man. In private law, its most important use is in the alienation of real estates, the writing given to the new proprietor by the old, in proof of the transference title, being usually called a charter. In public law, the name is given to those formal deeds by which sovereigns guarantee the rights and privileges of their subjects, or by which a sovereign state guarantees those of a colony or other dependency. See CHARTER, MAGNA CHARTA. There is another sense of the term, in which it is in a measure intermediate between the two we have mentioned—viz., where we speak of the C. of a bank or other company or association. In this latter sense it signifies an instrument by which powers and privileges are conferred by the state on a select body of persons for a special object. See BANK, CORPORATION, JOINT-STOCK COMPANY, &c. The requisites of a C., when used in the first of these significations, according to the law of England, will be pointed out under DEED.

ROYAL CHARTERS, generally written in Latin, are of two kinds: I. Grants of lands, houses, honours, or liberties to persons who did not previously possess them; II. Charters confirming grants previously made, and therefore called 'Charters of Confirmation.' Confirmation charters are of three kinds: 1. Charters confirming previous grants, without reciting them; 2. Charters of simple confirmation, without addition of anything new; 3. Charters reciting previous charters and confirming them, with addition of something new. These last two classes of charters are called charters of 'Inspecimus,' or 'Vidimus,' from the word used by the grantor in saying that he has seen the C. which he confirms. Royal charters generally contain seven clauses: 1. The 'Premises,' i. e., the name and style of the grantor, the persons to whom the C. is addressed, the name and style of the grantee, the reason why the grant is made, and the description of the thing granted; 2. The 'Tenendum et Habendum,' i. e., the way in which the thing granted was to be held and had; 3. The 'Reddendo,' the return of rent or service which was to be made to the grantor by the grantee;

4. The 'Quare Volumus,' or order that the grantee should have the thing granted, under certain penalties; 5. The 'Sealing' or 'Signature' clause, setting forth the seal, signature, or subscription by which the C. was authenticated; 6. The 'Huis Testibus,' or testing-clause, enumerating the persons who were present as witnesses when the C. was granted; 7. The 'Date,' setting forth the time when, and the place where, the C. was granted.

CHARTER, in the law of Scotland, is the written evidence of a grant of heritable property, under the conditions imposed by the feudal law—viz., that the grantee, or person obtaining, shall pay at stated periods a sum of money, or perform certain services to the grantor, or person conferring the property. A C. must be in the form of a written deed. The grantor of a C., in virtue of the power which he thus retains over the property and its proprietor, is called the superior; and the grantee, in consequence of the services which he undertakes to render, the vassal; whilst the stipulated sum to be paid, or service to be rendered, is called the duty.

Charters are either blench or feu, from the nature of the service stipulated—a *me* or *de me*, from the kind of holding or relation between the grantor and grantee; and original or by progress, from being first, or renewed, grants of the subjects in question.

Blench and Feu Charters.—The duty which the superior required of his vassal in former times was almost always military service, and the vassal was then technically said 'to hold ward'—to hold on condition of warding or defending his superior. But subsequent to the rebellion of 1745, in which the dangerous tendencies of the feudal relation were experienced, this holding was abolished (20 Geo. III. c. 50), and the only duties which it has since been lawful to insert in C. are *blench* and *feu duties*. The former is a merely nominal payment—a penny Scots, a red rose, or the like, *si petatur tantum* (should it be asked); the latter is a consideration of some real value. Original blench C. having lost all object, and having no other effect but that of subjecting superiors to considerable expense in keeping up their titles, have become rare in modern practice. The forms of charters varying according to the circumstances in which they are granted, and the relations established between the grantor and grantee, are of too technical a nature to admit of explanation in this work. They will be found very clearly and shortly stated in Bell's *Law Dictionary*, voce 'Charter.'

CHARTER-HOUSE (a corruption of *Chartreuse*, i. e., Carthusian) is a hospital, chapel, and school-house, in London, instituted in 1611 by Sir Thomas Sutton, of Camps Castle, in the county of Cambridge. It had originally been a Carthusian monastery (founded in 1371 by a Sir Walter Mauny and the Bishop of Sudbury), but on the dissolution of monastic establishments by Henry VIII., it was made a place of deposit for his nets and pavilions. After undergoing many alterations, and passing into the possession of various distinguished persons, it was finally purchased from Lord Suffolk, for £13,000, by Sir Thomas Sutton, who endowed it with the revenues of upwards of 20 manors, lordships, and other estates, in various parts of England. This 'masterpiece of Protestant English charity,' as old Fuller calls it, serves three uses—it is an asylum for poor brethren, an educational and a religious institution; hence Bacon terms it a 'triple good.' The *poor brethren* are 80 in number. None are admitted under 50 years of age, and only those who have been housekeepers are eligible. Each brother has a separate apartment, a share of attendance from domestics, an ample, though plain diet, and an allowance of about £26 a year for clothes and other

matters, and four weeks' holiday every autumn. The brethren must be bachelors and members of the Church of England. Among the poor brethren in bygone years were Elkanah Settle, the antagonist of Dryden; John Bagford, the antiquary; Isaac de Groot, a descendant of Grotius; and Alexander Macbean, who assisted Johnson in the preparation of his Dictionary. The *scholars* are 44 in number, admissible between the ages of 10 and 14. They are understood to be 'the sons of poor gentlemen to whom the charge of education is too onerous;' but, as in the case of the *poor brethren*, it is not always the proper parties who are chosen. There are exhibitions, scholarships, and medals competed for at certain times by the scholars. In addition to the scholars properly so called, i. e., such as receive a free board and education, a large number of youths are sent to the C. school because of its reputation. These either board with the masters, or simply attend during the day. At present, the number of extra boarders is between 60 and 70. The institution is under the direction of the Queen, Prince Albert, fifteen governors, selected from the great officers of state, and the master himself, whose salary from the foundation is £800 per annum. Among the eminent individuals educated in this establishment, are Dr Barrow, Judge Blackstone, Addison, Steele, John Wesley, Bishop Thirlwall, George Grote, W. M. Thackeray, and Sir Charles Eastlake.

The C., which is situated at the upper end of Aldersgate Street, is a quaint old building, interesting, though not very beautiful. The chapel contains Sutton's tomb, which was opened in 1842, when the body of the founder was discovered in a coffin of lead adapted to the shape of the body, like an Egyptian mummy-case.

CHARTER-PARTY (Fr. *chartre-partie*, so called from such documents being at one time divided—in Fr. *parti*—and one half given to each party concerned), the title given to a contract in which the owner, or master of a ship, with consent of the owner, lets the vessel, or a portion of her, to a second party, for the conveyance of goods from one port to another port; hence the vessel is said to be *chartered*. The document must be stamped. It must specify the voyage to be performed, and the terms on which the cargo is to be carried. On the part of the ship, it is covenanted that she shall be sea-worthy; well-found in rigging, furniture, and provisions; and that the crew be suitable in number and competency; that she shall be ready to receive the cargo on a given day, wait its complete delivery for a certain period; and sail for the stipulated port when laden, if the weather for the time permits. The freighter's portion of the contract obliges him to load and unload at suitable periods, under specified penalties, and to pay the freight as agreed on. The master must not take on board any contraband goods, or otherwise render the vessel liable to seizure. The owner is not responsible for losses caused by war, fire, or shipwreck, unless arising from negligence of the master or crew.

CHARTISM, a movement in Great Britain for the extension of political power to the great body of the people, arising in a great measure out of widespread national distress and popular disappointment at the results of the Reform Bill. Prior to 1831, the middle classes had sought popular aid towards obtaining their own enfranchisement. The assistance was given, the people expecting to receive help in their turn. After the passing of the Reform Bill, agitation ceased for a time, and the members returned to parliament were indifferent, or opposed, to any further change in the political arrangements

CHARTISM.

of the country. The middle classes were satisfied with their own success, and generally looked with small favour on projects for the further extension of political influence among the masses. A season of commercial depression set in about 1835, and failing harvests for several years terribly increased the sufferings of the people. Food became dear, wages fell, manufactories were closed, work became scarce. The people associated their sufferings with their want of direct influence upon the government, and agitation for an extended franchise began. In 1838, a committee of 6 members of parliament and 6 working-men prepared a bill, embodying their views as to what were just demands on the part of the people. This was the 'People's Charter.' It claimed—1. The extension of the right of voting to every (male) native of the United Kingdom, and every naturalised foreigner resident in the kingdom for more than two years, who should be 21 years of age, of sound mind, and unconvicted of crime; 2. Equal electoral districts; 3. Vote by ballot; 4. Annual parliaments; 5. No property qualification for members; and 6. Payment of members of parliament for their services. This programme was received with enthusiasm. Immense meetings were held all over the country, many of them being attended by two or three hundred thousand people. Fiery orators fanned the popular excitement, and under the guidance of the extreme party among their leaders, physical force was soon spoken of as the only means of obtaining justice. The more moderate and thoughtful of the Chartists were overruled by the fanatical and turbulent spirits, and the people, already aroused by suffering, were easily wrought into frenzy by those who assumed the direction of their movements. In the autumn of 1838, torchlight meetings began to be held. The danger of these meetings was obvious, and they were at once proclaimed illegal. Some of the more prominent leaders were arrested, amid intense popular excitement, and subjected to various terms of imprisonment. A body calling itself the National Convention, elected by the Chartists throughout the kingdom, commenced sitting in Birmingham in May 1839. It proposed to the people various means of coercing the legislature into submission, recommending, among other things, a run on the savings-banks for gold, abstinence from excisable articles, exclusive dealing, and in the last resort, universal cessation from labour. During its sittings, a collision took place with the military in Birmingham. Public meetings were forbidden, and alarming excesses were committed by the irritated mob. In June 1839, a petition in favour of the Charter was presented to the House of Commons, signed by 1,280,000 persons. The House refused to name a day for its consideration, and the National Convention retaliated by advising the people to cease from work throughout the country. Fortunately, this advice was not followed, but the disturbance in the public mind increased, and in November, an outbreak at Newport took place, which resulted in the death of 10 persons and the wounding of great numbers. For taking part in this wild insurrection, three of its leaders were sentenced to death, but their punishment was afterwards commuted to transportation. In 1842, great riots took place in the northern and midland districts, not directly caused by the Chartists, but encouraged and aided by them after the disturbances began. In the same year, an attempt was made by Joseph Sturge to unite all friends of popular enfranchisement in a Complete Suffrage Union, but he only succeeded in dividing their ranks. In 1848, the turmoil in France created great excitement in England, and much anxiety was felt lest an armed attempt should be

made to subvert the institutions of the country. Two hundred thousand special constables were enrolled in London alone. There were several local outbreaks, and much real danger, but the attempts at disorder were efficiently met, and, as usual, the only result was the punishment of the more prominent men, and the postponement of the desired reforms.

Since 1848, C. has gradually died out. Its principles were not new. The Duke of Richmond, in 1780, introduced a bill into the House of Lords to give universal suffrage and annual parliaments. In the same year, Charles James Fox declared himself in favour of the identical six points which were afterwards included in the Charter. And nearer our own time, Earl Grey, Mr Erskine, Sir James Mackintosh, and many others, formed a 'Society of Friends of the People,' which aimed at obtaining a very large extension of the suffrage.

The great body of Chartists were, however, not so much actuated by the weight of precedent or argument, as impelled by the pressure of actual want, and an indefinite feeling that the laws were somehow to blame for not providing them with the means of comfortable subsistence. But there were many among them who had studied the principles involved in their demands, and maintained them from an intelligent conviction of their truth. These men declared that all persons had an equal natural right to share in determining the laws under which they lived; and further, that as they were required to contribute to the taxation of the country, they were justly entitled to be heard as to the application of the public funds. Taxation and obedience being universal, representation ought to be so. This view being conceded, all the other points of the Charter naturally followed, they being merely arrangements for securing the free action of the right contended for. Some of the Chartist advocates went far beyond this. There were those among them whose aims included little less than the reorganisation of society. One of the ablest advocates of the cause wrote in favour of nationalising the land, and remodelling the currency; he also proposed a system of state loans for the assistance of labourers who desired to become capitalists, and national marts for the exchange of wealth on terms of equity and justice. Pressed a little further, these views would have developed into Communism; but so far as we are aware, most Chartists held so strongly the doctrine of *individual* rights, that they were not likely to subordinate *man to society*. See COMMUNISM, SOCIALISM. The object aimed at by the majority, was merely the extension of the franchise to the masses, in the belief that they would use it wisely and honestly, and put an end to what they considered the selfish and interested rule of classes who had long monopolised the control of the state. The opponents of C. answered, that if the question was argued as one of right, it would go far beyond the conclusions which the Chartists had reached. The *right* appertained to women as well as to men, and there was no just reason why sane persons under 21 should be deprived of it. It would also, they maintained, give all power to the most ignorant classes of the community, and thus subject intelligence to brute force. Government existed for the benefit of society, and ought, as far as possible, to depend on the wisdom, and not on the mere number of the people. Then if representation depended upon taxation, it should vary in proportion to the taxes paid. Finally, they denied that men *as such* had a right to vote; their right was to be well governed, and universal suffrage was more likely to destroy society than to confer happiness or insure justice.

The cause which put an end to C. as an organisation

was undoubtedly the improvement in the circumstances of the people which followed the repeal of the Corn Laws. A better period has begun. The different ranks of society are on better terms with each other; the opulent recognise and perform their duties better than they did; the poor interpret more genially than in the old time the actions of the rich. If this spirit continue—and we think it will—we may hope for reforms in the future without the convulsions which have hitherto accompanied them.

CHARTRES, a city of France, in the department of Eure-et-Loir, 47 miles south-west of Paris, is built partly at the base and partly on the declivity of a hill overlooking the river Eure, which is here divided into two channels, one flowing within, and the other without the ramparts, which are converted into agreeable promenades. C. consists of an upper and lower town, connected by streets almost inaccessible to carriages. The upper town has some good streets, but the lower is ill built. The houses are old, and many of them composed of wood, with their gables to the street. The cathedral, one of the largest and most imposing ecclesiastical structures in Europe, with its lofty spires, one of them towering to a height of more than 400 feet, crowns the top of the hill. It has no less than 130 painted-glass windows, the workmanship of which is unsurpassed, if indeed equalled elsewhere in France. The church of St Pierre, and the obelisk to the memory of General Marceau, are also objects of interest. The weekly corn-market of C. is one of the largest in France, and is remarkable as being under a corporation of women, who contrive to get through all the business most satisfactorily in less than an hour. It has manufactures of woollen, hosiery, and leather. Pop. 16,497.

C. is a very ancient city. Under the Roman rule it was called *Autricum*, and remains of Roman antiquity are still found.

CHARTREUSE, LA GRANDE, a celebrated monastery in France, in the department of Isère, situated 13 miles north-north-east of Grenoble, in the wild and romantic valley of the Guiers, nearly 4000 feet above the sea. It is surrounded by the mountain-forests of the Alps; and the route to it, through a mountain-gorge, down which a rapid river dashes far below the traveller, while above him rise precipitous and foliage-lined rocks, some hundreds of feet in height, is one of the most picturesque. The convent is a huge ungainly structure, dating mostly from the 17th c., earlier buildings having been destroyed several times by fire. The convent owes its origin to St Bruno, who settled a little higher up the mountain in 1084, giving the name of the place, C., to his order. The monks had at one time considerable property, but they were despoiled at the revolution of 1789.

CHARTULARY (Lat. *chartularia*, *chartologia*) is, as its name implies, a collection of charters. So soon as any body, ecclesiastical or secular, came to be possessed of a considerable number of charters, obvious considerations of convenience and safety would suggest the advantage of having them classified and copied into a book or roll. Such book or roll has generally received the name of a Chartulary. Mabillon traces chartularies in France as far back as the 10th c., and some antiquaries think that chartularies were compiled even still earlier. But it was not until the 12th and 13th centuries that chartularies became common. They were kept not only by all kinds of religious and civil corporations, but even by private families. Many of them have been printed, and their contents generally are of the

greatest value in all historical, archæological, and genealogical inquiries

CHARYBDIS. See **SOYLLA AND CHARYBDIS.**

CHA'SCHISH. See **HEMP, INDIAN.**

CHASE. When one vessel is pursuing another at sea, the pursued vessel is often called the *chase*, and the pursuer the *chaser*. The manoeuvre also gives name to certain guns on board ship: a *bow-chaser* being a gun pointing ahead, and a *stern-chaser* pointing astern.

CHASE, in a gun, is the name given to the greater portion of the length between the muzzle and the trunnions.

CHASIDIM ('Pietists'), this name anciently denoted a whole class of Jewish sects. After the Babylonish captivity, the Jews, with regard to their observance of the law of Moses, were divided into two classes—*Chasidim* and *Zadikim*. When the so-called Great Synagogue was commissioned by the Persian government to draw up a code of civil and religious laws for the emigrant Jews returning to settle in their native land, several innovations were made on the Mosaic law. Those who accepted these innovations were styled the C.; while those who rejected them were styled, or styled themselves, the *Zadikim*, or 'upright,' because they adhered strictly to the law given by Moses, without observing any of the additions made to it. The C. branched forth into several sects, all holding traditions in connection with the written law, which they believed to possess a divine sanction equally with that law. The Pharisees, so often mentioned in the New Testament, formed an early sect among the C., while from the *Zadikim* sprang forth the Hellenistic Samaritans, Essenes, Sadducees, &c. Afterwards, the C., or Pharisees, split into Talmudists, Rabbinites, and Cabbalists, some of whom underwent still further subdivision.—The modern C. are not, like those in the times of the Maccabees, marked by any peculiar spiritualistic tendency in religion, but rather by a strict observance of certain traditional forms, and a blind subservience to their teachers. Their doctrine was promulgated in the middle of the 18th c. by Israel of Podolia, called *Baal-Shem* ('Lord of the Name,' so called because he professed to perform miracles by using the great cabalistic name of the Supreme Being). Though condemned by the orthodox rabbis, this new teacher had great success in Galicia, and when he died (1760) left 40,000 converts. They are now broken into several petty sects; their religion is utterly formal, and its ceremonies are coarse and noisy.

CHASING, the art of working raised or half-raised figures in gold, silver, bronze, or other metal. It was called *calatura* by the Romans; and the term is expressly limited by Quintilian to working in metal. The same art when exercised on wood, ivory, marble, precious stones, or glass, was called *sculptura*. See **CARVING**. Iron was sometimes, though rarely used, silver having been always the favourite metal for this purpose. Closely connected with, but still distinguished from C., is the art of stamping with the punch, which the Romans designated by *excudere*. The Greek *torcutike* is usually supposed to correspond to C., but the point is by no means free from dispute. The art was known at a very early period, as may be inferred from the shield of Achilles, the ark of Cypselus, and other productions of the kind. Such portions of the colossal statues made by Phidias and Polycletus, as were not of ivory, were produced by the toreutic art. The statue of Minerva was richly adorned in this manner. Besides Phidias and Polycletus, Myron, Mys, and Mentor were celebrated toreutic artists in antiquity,

and amongst many moderns the most famous is Benvenuto Cellini (q. v.). -

CHASSE, music composed in imitation of the chase, and performed chiefly by horns, occasionally combined with other wind-instruments. Its movement is in $\frac{3}{8}$ time. The best specimens of this kind of music are an overture by Mehul, and a C. for the pianoforte by Kreutzer.

CHASSÉ, DAVID HENDRIK, BARON, was born in Thiel, March 18, 1765, began his military career when but ten years of age, became a lieutenant in 1781, and captain in 1787. After the revolution of that year, C., as siding with the humbled Dutch patriots, took French service; was appointed lieutenant-colonel in 1793; and, two years later, found himself marching towards the Netherlands under the command of Pichegru. He afterwards fought with the French in Germany and Spain, gaining great distinction and the appellation of *Général Bayonnette*. As lieutenant-general of the Dutch forces in 1815, C. added to his laurels on the field of Waterloo. After the peace he was made governor of Antwerp in 1830, and bravely defended it against the united Belgians and French from November 29 till December 23, 1832, when he was forced to surrender. He died in May 1849.

CHASSEURS (Fr. hunters) is a name, either in this form or in some other equivalent to it, given to some of the light troops in several of the European armies. A Tyrolese corps in the Austrian army took the name of *Jägers*, from being chiefly formed of chamois hunters (*Jägers*), and consequently good marksmen; and, in imitation of these *Jägers*, other European corps have been established, always understood to be good shots. Battalions of C. were enrolled in the French army in 1815; but the organisation soon afterwards underwent a change. Concerning a more recent French corps, see the next article. There are C.-à-Cheval as well as C.-à-Pied in the French army; and equivalent corps in other armies. Some of the most trustworthy troops under Garibaldi, in the Italian wars of 1859 and 1860, were the *Cacciatori dei Alpi*, or Hunters of the Alps, a counterpart to the Tyrolese *Jägers* in origin and name.

CHASSEURS DE VINCENNES is one of the names given to a famous corps in the French army. About the year 1835, when certain improvements had been made in the French rifle, the Duke of Orleans ordered the formation of a company of riflemen, armed with the new rifle; they were garrisoned at Vincennes. They proved so efficient that in 1838 a whole battalion was organised, which was called indifferently the *Tirailleurs* (sharpshooters) or *Chasseurs de Vincennes*.

CHASTE TREE. See **VITEX**.

CHASUBLE (Lat. *casula*, *casubula*, and *casibula*), the uppermost garment worn by priests in the Roman Catholic Church, when robed for

Reformation. Originally it covered the priest from head to foot, like a little house, whence some writers think it had its name of *casula*. In more recent times, at least, it was made of velvet. It was of an elliptical shape, like a *vesica piscis*, with a hole in the middle for the head; it had no sleeves. When put on, it shewed two peaks, one hanging down before; another, on which a cross was embroidered, hanging down behind. According to Hildebert, the C. signified good works; according to Alcuin, charity; according to another writer, the unity of the faith. Durand makes one peak the symbol of love to God, the other peak the symbol of love to our neighbour. In France, the press or wardrobe in which chasubles were kept was called the *chasublier*.



Chasuble.

CHAT (*Saxicola*), a genus of small birds of the very numerous family *Sylviidae* (q. v.), distinguished by a bill slightly depressed, and widened at the base. They have rather longer legs than most of the family. They are lively birds, flitting about with incessant and rapid motion in pursuit of the insects on which they chiefly feed. They are found in Europe, Asia, Africa, and New Holland. Three species are British—the stonechat, whinchat, and wheatear.—The yellow-breasted C. of the United States (*Icteria polyglotta*) is a larger bird, and belongs to the family *Turdidae* or *Merulidae*.

CHAT MOSS, a bog in Lancashire, the largest in England, about 7000 acres in extent, and celebrated as having been the scene of the first great and successful efforts for the reclaiming of bogs, by Mr Roscoe of Liverpool, in the end of the 18th and beginning of the 19th c., and of one of the great engineering triumphs of George Stephenson in the construction of the Liverpool and Manchester Railway. It is situated between Liverpool and Manchester, at no great elevation above the sea. It is from 20 to 30 feet in depth, and of such consistence that when an attempt was first made to survey it for the Liverpool and Manchester Railway, the attempt was relinquished because of the impossibility of obtaining a sufficiently solid stand for the theodolite. Drains are filled up almost as fast as they are cut, by a pulpy stuff flowing into them, and affect only a few feet on either side. Great danger is experienced by any person stepping unwarily on the surface of the bog; and when he begins to sink, his struggles to extricate himself only cause him to sink faster and deeper. Mr Roscoe's agricultural improvements were effected by numerous parallel drains in the parts on which he operated. The use of *patterns* by his workmen, and the adaptation of them to the feet of the horses employed, have been mentioned in the article Bog. The enlargement of the circle upon which a horse's foot rests from 5 inches diameter to 7, nearly doubles it, and consequently diminishes nearly by one-half the pressure on each unit of surface. Mr Stephenson, when he could find no one to countenance him in his views, calculated with confidence on the application of this principle to the railway, so that even the ponderous locomotive and train might be supported by a sufficient extension of the bearing surface; and this he accomplished by spreading



Chasseur de Vincennes.

the celebration of the mass. It was called also 'the Vestment,' and under that name seems occasionally to have been used in the English Church after the

branches of trees and hedge-cuttings, and in the softest places rude hurdles interwoven with heather, on the natural surface of the ground, containing intertwined roots of heather and long grass; a thin layer of gravel being spread above all, on which the sleepers, chairs, and rails were laid in the usual manner. Drains were at the same time cut on both sides of the line, and in the central part of the moss a conduit was formed beneath the line of railway, of old tar-barrels placed end to end. Notwithstanding difficulties which every one but himself deemed insuperable, Mr Stephenson constructed the portion of the line through C. M. at a smaller expense than any other part of the railway. There still is 'a sort of springiness in the road over the moss, such as is felt when passing along a suspension-bridge;' and 'those who looked along the moss as a train passed over it, said they could observe a waviness, such as precedes and follows a skater upon ice.'

The complete reclaiming of C. M. for agricultural purposes can be only a question of time and expense. It seems capable of becoming one of the most productive tracts of land in England.

CHÂTEAU, CHÂTEL, or CASTEL, from the Lat. *castellum*, a fort, enters as a component part into many names of places in France.

CHATEAUBRIAND, FRANÇOIS AUGUSTE, VICOMTE DE, one of the most distinguished of French authors, was born September 4, 1769, at St Malo, in Bretagne, and received his early education in the college at Rennes. While travelling in North America in 1790, he accidentally read in an English newspaper the account of the flight and arrest of Louis XVI. He immediately returned to France, intending to fight against the republic; but being seriously wounded at the siege of Thionville, in September 1792, he escaped to England, where he lived in such poverty that he was compelled to make translations for the booksellers, and to give lessons in French. In 1797, he published his first political essay, *Sur les Révolutions Anciennes et Modernes, considérées dans leurs Rapports avec la Révolution Française* (2 vols., London), a republican and sceptical work, the outcome of hardship, poverty, and sorrow. His scepticism soon vanished, but republican impulses continued to flash out at intervals during the whole of his strangely checkered, inexplicable, and inconsistent career. In 1800, C. returned to Paris, and wrote for the *Mercur de France*. In this journal, he first printed his tale of *Atala* (1801), with a preface lauding the First Consul, Bonaparte. Its success was remarkable, but nothing to the miraculous enthusiasm excited by his *Génie du Christianisme* (1802), a work exactly suited to the jaded scepticism of the age, and also in accordance with the policy of the First Consul, who was then concluding the concordat with the pope, and wished to make the Roman Catholic priesthood subservient to his measures. Bonaparte, therefore, appointed C. secretary to the embassy in Rome, and, in 1803, sent him as ambassador to the little republic of Valais. On the execution of the Duke d'Enghien, March 21, 1804, C. resigned in disgust. In 1806, he commenced his pilgrimage to the Holy Land, visited Greece, Palestine, Alexandria, and Carthage, and returned through Spain to France in May 1807. From this period to the fall of Napoleon, he lived privately, publishing only two works of any value—*Les Martyrs*, and the *Itinéraire de Paris à Jérusalem*. In 1814, his eloquent brochure, *De Bonaparte et des Bourbons*, excited such attention, that Louis XVIII. declared it was worth an army of 100,000 men in favour of legitimacy.

After the battle of Waterloo, C. returned to Paris, where he was made peer and minister of state. Gradually his monarchical zeal subsided, and, in his address, *De la Monarchie selon la Charte*, delivered in the Chamber of Peers, he gave expression to such liberal tendencies as offended the king, who erased his name from the list of his counsellors. Soon, however, he appeared again as an ultra-royalist; and at the baptism of the infant Duke de Bordeaux, C. presented to the Duchess of Berry a flask filled with water from the Jordan. In 1822, he was appointed ambassador-extraordinary to the British court, but was rather rudely dismissed from office in 1824.

In 1826, C. prepared the first edition of his collected works, for the copyright of which the publisher gave the large sum of 600,000 francs, of which C. returned 100,000. During the days of July 1830, he was staying with his friend Madame Récamier at Dieppe; but as soon as he heard tidings of the revolution, he hastened to Paris. He refused to take the oath of fealty to Louis Philippe. This political crotchettiness, which always rendered it impossible to know beforehand what course of conduct C. would adopt, is perhaps best explained by the following passage from his *De la Restauration et de la Monarchie Elective* (Paris, 1831): 'I am a Bourbonist in honour, a Monarchist on grounds of rational conviction; but in natural character and disposition, I am still a Republican.' In 1832, he revised a new edition of his works, and, after visiting the court of the expelled Bourbons, devoted his attention to the preparation of his memoirs, intended to be published posthumously (*Mémoires d'outre Tombe*), though considerable extracts were printed during his lifetime. He also found leisure to write several other works. He died July 4, 1848.

C. wrote with warmth, energy, and a rich supply of imagery. Many of his descriptive passages are excellent, but his ideas want depth and coherency.—Marin, *Histoire de la Vie et des Ouvrages de M. de Chateaubriand* (2 vols., Paris, 1832).

CHÂTEAUBRIANDUN, a town of France, in the department of Eure-et-Loir, is situated on the Loir, a tributary of the Loire, about 26 miles south-south-west of Chartres. The streets are straight and well built, and an old castle, with an enormous tower, overlooks the town. C. has manufactures of blankets and leather. Pop. 5659.

CHÂTEAU-GONTIER, a town of France, in the department of Mayenne, situated on the river of that name, here crossed by a stone bridge, 18 miles south-south-east of Laval. C. has some good houses, but the streets are not well laid out. It has manufactures of linen and woollen. Pop. 6635.

CHÂTEAUNEUF DE RANDON, a village of France, in the department of Lozère, 12 miles north-east of Mende. A pretty historical incident connected with the place, which was formerly fortified, makes it interesting. In 1380, the fortress, then held by the English, was besieged by the troops of Charles V., under the command of the gallant Du Guesclin. The English governor, sore pressed, promised to yield in fifteen days if no succour arrived. In the meantime, Du Guesclin died, and his successor was appointed, who, at the expiry of the fifteen days, summoned the governor to surrender. He refused to yield up the keys to any but Du Guesclin; and when informed of his death, marched out, and on bended knee laid the keys and his sword on the dead hero's bier.

CHÂTEAUROUX, a town of France in the department of Indre, situated on a rising ground in

CHÂTELET-LOMONT—CHATHAM ISLANDS.

the midst of an extensive plain, on the left bank of the river Indre, 166 miles south of Paris by railway. The town, which was formerly dirty and ill built, has been greatly improved within the last quarter of a century. C. does not possess much interest for the traveller. It is a busy place, with extensive woollen factories, besides manufactures of cotton, hosiery, yarn, hats, paper, parchment, hardware, leather, &c. Some of the best iron in France is found in the vicinity. The town owes its origin to a castle built here in the 10th century. Pop. 12,462.

CHÂTELET-LOMONT, GABRIELLE EMILIE, MARQUISE DU, a very learned French woman, notorious for her intimacy with Voltaire, was born at Paris, 17th December 1706. At an early period she displayed a great aptitude for the acquisition of knowledge. She studied Latin and Italian with her father the Baron de Breteuil, and subsequently betook herself with zeal to mathematics and the physical sciences. Distinguished alike for her beauty and talent, she soon found a host of suitors for her hand. Her choice fell on the Marquis du Châtelet-Lomont, but her marriage did not hinder her from forming a *tendresse* for Voltaire, who came to reside with her at Cirey, a château on the borders of Champagne and Lorraine, belonging to her husband. Here they studied, loved, quarrelled, and loved again, for several years. In 1747, however, poor Madame C. became 'not insensible to the brilliant qualities' of a certain M. Saint-Lambert, a captain of the Lorraine Guards; and the result was, that the philosopher had to make room for the soldier, and content himself for the future with being the 'devoted and indulgent friend' of his former mistress. This new intimacy became fatal to Madame Châtelet. She died at Luneville, 10th September 1749, a few days after having given birth to a child. Her first writing was a treatise on the philosophy of Leibnitz. She also translated the *Principia* of Newton into French, accompanying it with algebraic elucidations. It did not, however, appear till 1756, some years after her death. Her correspondence with Voltaire is interesting; but the fact that a woman so highly gifted as Madame C., and possessing so many amiable qualities, should never have dreamed that there was anything wrong in her *liaisons*, proves with terrible conclusiveness how corrupt was that philosophic society which, in the 18th c., professed to explode superstition and enlighten France and the world.

CHÂTELLERAULT, a town of France, in the department of Vienne, situated on the river of that name, 18 miles north-north-east of Poitiers. A handsome stone bridge, with a massive castellated gateway, built by Sully, at one end, connects it with a suburb on the other side of the river. C., which is an ill-built, mean-looking town, is one of the chief seats of the manufacture of cutlery in France, and since 1820 has had a royal manufactory of swords and bayonets. Its river-port makes it the entrepôt for the produce of an extensive district. The Duke of Hamilton derives his title of Duke of Châtellerault from this place. Pop. 11,815.

CHA'THAM (Saxon, *Ceteham* or *Cetham*, understood to signify the 'village of cottages'), a parliamentary borough, river-port, fortified town, and naval arsenal, in the county of Kent, situated on the right bank of the Medway, at the upper part of its estuary, 30 miles east-south-east of London. Much of C. is ill built and irregular. The High Street is $1\frac{1}{2}$ mile long, parallel to the river, and swarms with soldiers and Jews. The refuse timber of the dock-yard is much used in building the

house-walls. C. owes its importance to its naval and military establishments situated at Brompton village (on a height half a mile north of C.), and on the Medway estuary. The C. fortified lines are the frequent scenes of field-operations, imitation battles, and grand reviews. Pop. 28,424. The borough, which sends one member to parliament, is governed by a head-constable under the magistrates of Rochester. The Romans seem to have once had a cemetery here. Traces of Roman villas have been found, with Roman bricks, tiles, coins, and weapons. The dock-yard was founded by Elizabeth before the threatened invasion of the Spanish Armada. In 1662, it was removed to its present site. In 1667, the Dutch, under De Ruyter, sailed up the estuary of the Medway, and, in spite of the fire from the castle, destroyed much shipping and stores.

In a military point of view, C. lines are considered the best fortifications in England, after those of Portsmouth. The place is also defended by Upnor Castle and Gillingham Castle; and, in accordance with the recommendations of a commission appointed in 1859, money was granted by parliament in 1860 for constructing additional fortifications. In and near C. are Fort Pitt, a military hospital and strong fort; barracks for infantry, marines, artillery, and engineers; a park of artillery; and magazines, storehouses, and depôts on a large scale.

In a naval sense, C. is one of the principal royal ship-building establishments in the kingdom. The dock-yard is nearly a mile in length, containing several building-slips, and wet docks sufficiently capacious for the largest ships. The slips have been provided with iron roofs, at a cost of about £10,000 per roof. One peculiar establishment in this dock-yard is a metal mill, which supplies all the royal dock-yards with copper sheets, copper bolts, and other articles in copper and mixed metal. The saw-mills at C. are so extensive, that it is said that, if fully employed, they could cut up timber enough for all the dock-yards. A duplicate of Brunel's block-making machinery is kept at C., ready to supplement the operations of that at Portsmouth. The dock-yard is under the control of a captain-superintendent, and other officers, whose annual salaries vary from £700 to £200 each. Under them are clerks receiving from £450 to £80 each. The actual workmen, artizans and labourers, vary in number according to the amount of ship-building and repairing going on. In the estimates for 1860—1861, provision was made for about 1800 shipwrights, calkers, joiners, sawyers, mill-wrights, smiths, block-makers, sail-makers, rope-makers, riggers, labourers, &c., at an average wage of about 2s. per man, per week. Further extensions are to be commenced in 1861.

CHATHAM ISLANDS, a small group in the Pacific, lying about 400 miles due east of the Canterbury settlement, on the Middle Island of New Zealand, in lat. $43^{\circ} 38' - 44^{\circ} 40'$ S., long. $177^{\circ} - 179^{\circ}$ W., being thus almost precisely the antipodes of Toulouse, in France. They were discovered in 1791 by Lieutenant Broughton, both the cluster and its chief member taking the name of his ship. Chatham Island is computed to contain 600,000 acres; a salt or brackish lake, however, of 20 miles in length, occupying the interior. The soil and climate of the archipelago, in general, are said to be good. Wheat yields abundantly; and the horses, cattle, and pigs which have been introduced thrive well. Timber of any size is unknown, so that the native canoe, instead of being cut out of a single tree, is merely wicker-work bound together by cordage of indigenous flax. The

CHATHAM—CHATSWORTH.

aborigines have two missions among them—one from Germany, and the other from New Zealand.

CHATHAM, WILLIAM PITT, EARL OF, sometimes styled **PITT THE ELDER**, one of the greatest English orators and statesmen of the 18th c., was the son of a country gentleman, Robert Pitt of Bocomoc, in Cornwall; and was born November 15, 1708. After an education at Eton and Oxford, he travelled on the continent, and on his return obtained a cornetcy in the Blues. In 1735, he entered parliament for Old Sarum—that synonym for electoral corruption—a borough then belonging to his family. He espoused the side of Frederick Prince of Wales, then at deadly feud with the king, and offered a determined opposition to Walpole, who was at the head of affairs. He was deprived of his commission in consequence—an insult and injury which only increased the vehemence of his denunciations of the court and the government. His influence, both in and out of the House of Commons, increased rapidly; and Walpole being driven from power, the king, notwithstanding his hatred of Pitt, found it necessary to allow of his admission to a subordinate place in the Broad Bottom administration; subsequently he was appointed to the lucrative office of paymaster-general. The Duchess of Marlborough, pleased with his patriotism and powers of oratory, left him £10,000; and later, Sir William Pynsent, struck with similar admiration, left him his whole property. In 1755, when Henry Fox (afterwards Lord Holland) was made secretary of state, finding himself opposed to the foreign policy of the new minister, Pitt resigned office as paymaster. In the following year, when the king, unwillingly acceding to popular demands, had to dismiss Fox, Pitt became nominally secretary of state, but was virtually premier. He immediately began to put into execution his own plan of carrying on the war with France. He raised the militia, and strengthened the naval power; but the king's old enmity, and German predilections, led him to oppose Pitt's policy, who thereupon resigned office in April 1757, but was recalled in June, in obedience to the loud demands of the people.

Now firmly established in power, Pitt's war policy was characterised by unusual vigour and sagacity. Success returned to the British arms. French armies were beaten everywhere by Britain and her allies—in India, in Africa, in Canada, on the Rhine—and British fleets drove the few French ships they did not capture or destroy from almost every sea. But the prime mover of all these brilliant victories found himself compelled to resign (1761), when, on the accession of George III., and owing to the influence of Lord Bute, it was attempted to introduce a vacillating policy into the government; his immediate cause of resignation being the refusal of the majority of the cabinet to declare war with Spain, which Pitt foreseeing as imminent, wished to commence before the Spaniards were thoroughly prepared. As some recompense for his important services, Pitt received a pension of £3000 a year; and his wife, sister of George Grenville, was created Baroness Chatham. Until 1766, Pitt remained out of office, not offering a factious opposition to government, but employing all his eloquence to defeat some of its most obnoxious measures. In that year he received the royal commands to form a ministry. He undertook the task, choosing for himself—to the astonishment of the public, and the sacrifice, to a considerable extent, of his popularity—the almost sinecure office of Privy Seal, with a seat in the House of Lords as Viscount Pitt and Earl of Chatham. Ill health prevented C. from taking any active part in this ministry, of which he was nominally the head, and

which was weak and embarrassed throughout, and he resigned in 1768, to hold office no more. He did not, however, cease to take an interest in public affairs. He spoke strongly against the arbitrary and harsh policy of government towards the American colonies, and warmly urged an amicable settlement of the differences. But when, America having entered into treaty with France, it was proposed by the Duke of Richmond to remove the ministers, and make peace on any terms, C., though much debilitated, came down to the House of Lords, and in a powerful address protested against the implied prostration of Britain before the throne of the Bourbons, and declared war, with whatever issue, preferable to the proposed terms of peace. This address secured a majority against the motion, and the war was continued. But it was the orator's last effort; for, exhausted by speaking, on rising again to reply to a query addressed to him by the Duke of Richmond, his physical powers suddenly failed, he fell back into the arms of his friends, and was carried from the House. He died May 11, 1778. He was honoured with a public funeral in Westminster Abbey, where a statue was also erected to his memory at the public expense; and in addition, government voted £20,000, to pay his debts, and conferred a pension of £4000 a year on his descendants. C.'s personal appearance was dignified and imposing, and added greatly to the attractions of his oratory, which was of the most powerful kind. His upright and irreproachable character demanded the admiration of his enemies; but his affectedness and haughtiness not unfrequently disgusted his friends, and pride rather than principle seems to have actuated his course at some important conjunctures of his life. He had, however, an intense love of country; the grand object of his ambition being to make his native land safe against all contingencies, and powerful among nations.

CHÂTILLON, a town of France in the department of Cote d'Or, on the Seine, about 45 miles north-north-west of Dijon. Pop. 4653. C. is chiefly famous on account of the congress of allied sovereigns held here in 1814, from February 5 to March 19, for the purpose of negotiation with Napoleon respecting conditions of peace. Several of the conditions proposed by the allies Napoleon could not bring himself to submit to, and the negotiations broke up, March 19. On the 25th, when their armies were, in fact, marching on Paris, the allies from Vitry issued their declaration justifying a continuation of the war.

CHATSWORTH, the magnificent mansion of the Duke of Devonshire, and one of the most splendid private seats in England, is situated in Derbyshire, on the Derwent, 12 miles north-by-west of Matlock. William the Conqueror gave the domain to his natural son William Peveril. It was purchased by Sir W. Cavendish in Queen Elizabeth's time. Sir W., in 1570, began the old mansion, which was finished by his widow, afterwards Countess of Shrewsbury. In this building Mary Queen of Scots was imprisoned for 13 years. The present edifice, called a palace from its grandeur, includes the old Ionic pile, 183 by 172 feet, built 1687—1706, by the first Duke of Devonshire, after designs by Talman and Wren. The great stables were built about 1706, and the north wing since 1720. The façade is 720 feet long, or with the terraces, 1200 feet. The building is nearly a square, with an interior court. C. is famed for its pictures, sculptures, hangings, carvings, and bas-reliefs. There are some exquisite sculptures by Canova, Thorwaldsen, Chantrey, &c. The grounds around are 9 miles in circuit, including

hill and dale, and fine prospects. They were laid out by Loudon and Paxton, and are celebrated for their trees, shrubs, rock-work, deer, and water-works—only surpassed by those at Versailles. The conservatory, unrivalled in Europe, covers nearly an acre, measures 300 by 145 feet, and 65 feet high, has 70,000 square feet of glass, and a carriage-road through it. Hobbes, the philosopher, lived long at Chatsworth.

CHATTAHOOCHEE, a river of the United States, rises on the eastern declivity of the Blue Ridge of the Alleghanies, in the north of Georgia; traverses that state in a south-west direction; becomes the boundary between it and Alabama; and finally, after receiving the Flint from the left, crosses Florida, under the name of Appalachicola, into the Gulf of Mexico. With an entire course of 550 miles, it is navigable upwards as far as Columbus, at a distance of 350 miles from the sea. It forms the principal outlet for the cotton crops of its basin.

CHATEL (Fr. *chatel*, Old Fr. *chapel*, from Lat. *capitale*, corrupted into *captale* and *catalium*, meaning the capital or principal sum in a loan; hence goods in general, especially cattle, as distinguished from land), in the law of England, is a term used to designate any kind of property which, with reference either to the nature of the subject or the character of the interest possessed in it, is *not freehold*. Regarded from a positive point of view, C. included not only all movable property, but all property which, though immovable, was not held on a feudal tenure. Any estate, then, or interest in lands and tenements not amounting to freehold, is a chattel. But as, between property thus 'savouring of reality' and mere personal movables—money, plate, cattle, and the like—there was a manifest distinction, chattels were, consequently, distinguished into *chattels-real* and *chattels-personal*. Both descriptions of C., in the eye of the ancient law of England, were regarded as inferior to freehold, and formed a subordinate class of property. As distinguished from estates of inheritance, or for life in things immovable, such estate is called *personal*, the others being *real* estate. Till the passing of 8 and 9 Vict. c. 106, livery of seizin was required to pass an estate of inheritance, or for life in corporal hereditaments of feu tenure, but such was no more required for the transfer of a C. real than of a C. personal. A C. *real* is also transmitted on the owner's death to his executor or administrator, like a C. personal, and does not descend to his heir like a freehold of inheritance. There is an exception to this rule, however, in the case of chattels which, owing to their intimate connection with property of a freehold nature, cannot be separated from it without injury. Such, for instance, are the muniments of title to an estate, growing grass, deer in a park, and actual fixtures, all of which go to the heir, and not the executor. The tenant of a C. real, like the tenant of a C. personal, is, moreover, said not to be *seized*, like the tenant of a freehold, but to be *possessed*. Lastly, there can be no estate tail in a C. real more than in a C. personal, except in the case in which either of them can be regarded as an heir-loom. Formerly, C. might be disposed of by will at an earlier age than real estates, but this was altered by 1 Vict. c. 26.

CHATTERER, a significant popular name, often applied to the birds of the family *Ampelidae*, a family of the order *Insectores* and tribe *Dentirostres*, having a depressed bill like that of the Fly-catchers (*Muscicapidae*), but somewhat shorter and broader in proportion, and slightly arched. To this family

belong the cotingas, wax-wings, piauhaus, caterpillar-hunters, &c. They are found chiefly in the warmer parts of the old world, although America also produces some. They inhabit low grounds or forests, feeding chiefly on insects and their larvæ. Some of them possess powers of song almost equal to those of the nightingale. Many of them are birds of gorgeous plumage.—Only one species is British, sometimes called simply the C., sometimes the Bohemian C. or Wax-wing (q. v.).

CHATTERTON, THOMAS, an English poet, whose youth, genius, and tragical death have made him one of the wonders of English literature, was born at Bristol, November 20, 1732. His father, who had once been a chanter in the Bristol cathedral, and also master of a kind of free-school, died two or three months before the poet's birth. C. was educated at a parish-school, was considered a dull child, but making acquaintance with a black-letter Bible which his mother often used, the dormant spirit flashed up. From early years, he was fond of all kinds of antiquities; he clung around old walls like the ivy, and haunted twilight ruins like the bat. At the age of 14, he was apprenticed to Mr Lambert, an attorney. His situation here was uncomfortable, he took his meals in the kitchen with the footboy, and when refractory, was chastised with a ruler. In October 1768, the new bridge at Bristol was opened, and C. sent to a newspaper an account, in antique phraseology and spelling, of the ceremonies attending the opening of the old one several centuries before—the whole purporting to be taken from an ancient MS. To a certain Bristol pewterer, Burgum by name, he presented himself, and astonished the craftsman by the sight of a parchment, in which his pedigree was traced back to the Norman Conquest, adorned by many a splendid marriage, and many a knightly name. He also exhibited to his friends copies of old poems, which he said were composed by one Thomas Rowley, a monk of the 15th century. These matters made some stir in his native city, but not enough to satisfy C., who resolved to fly at higher game. Accordingly, Horace Walpole, at that time collecting additional materials for his *Anecdotes of Painting in England*, received from C. several pages of antique writing, accompanied by a short note. The pretended MS. gave biographical sketches of celebrated painters who had flourished in England several centuries ago, and of whose existence Walpole had never dreamed. Walpole, put off his guard, answered his unknown correspondent at once; expressed his delight at receiving the MS.; and desired, as a personal favour, that all the other antique writings, poems included, mentioned in the note, should be forwarded. C., highly elated, immediately sent accounts of a great many more painters and poets, and also gave some slight sketch of his personal history. On receipt of this second communication, Walpole suspected a trick. The poems he shewed to Mason and Gray, who at once pronounced them forgeries; he then wrote C., expressing his suspicions as to the genuineness of the MS., and administering at the same time a great deal of excellent advice. C. replied, desiring that the MS. should be returned at once; but by the time the letter reached London, Walpole was about to start for Paris, and it was allowed to remain unanswered. On Walpole's return some six weeks thereafter, a fierce note from C. waited him, the contents of which must have brought the blood to his polished and urbane brow; indignant, he bundled up the MS., and returned it without a word of explanation.

From his earliest youth, C. had a ghastly familiarity with the idea of suicide. Among his papers preserved in the British Museum, is a last will and

testament, 'executed in the presence of Omniscience, the 14th of April 1770,' full of the wildest wit and profanity. Another document of similar purport, falling into the hands of his friends, led to his dismissal from Mr Lambert's office. Released from what he considered the slavery of law, C.'s eyes turned to London, and in that city he arrived, carrying with him all his Rowley MS. and several modern poems, on Tuesday the 24th April 1770, and took up his abode with one Walmsley, a plasterer, in Shoreditch. No sooner had he settled there, than he began to work as with a hundred hands. During the last few months of his life, he poured forth squibs, satiric poems, political essays, burlettas, letters in the style of Junius, and meditated writing a history of England, to appear in parts. For a time, his prospects seemed golden enough. He obtained an introduction to Lord Mayor Beckford; he sent glowing letters home, accompanied by presents to his mother and sisters. Ultimately, he left the plasterer's in Shoreditch, and took lodgings in Brooke Street, adjoining Holborn. Unhappily for C., editors of opposition papers were willing enough to insert and praise his articles, but were disinclined or unable to render an equivalent in cash. Possibly they conceived that a patriotism so ardent must be its own reward. The means of life were now fast failing. In desperation, he attempted to procure an appointment of surgeon's mate in a vessel going to Africa, but failed. This was the last drop that made the cup overflow. On Saturday the 25th August, his landlady, alarmed that her lodger did not make his appearance, had the door of his room broken open; saw the floor littered with small pieces of paper, and C. 'lying on the bed with his legs hanging over, quite dead.' Just at this time, Dr Fry of Oxford, who had seen or heard something of the Rowley poems, was on the eve of starting for Bristol to make inquiry into the matter. Sad enough to think on now: a little more promptitude on the one hand, a little more patience on the other, and the whole catastrophe might have been averted.

C. died before he reached his 18th year, and takes his place as the greatest prodigy in literature. Indeed, in our judgment of him, age cannot be taken into account. He never seems to have been young. His intellect was born fully matured. He was equally precocious in other respects. In his letters, he speaks of the relation of the sexes in the tone of a sated *roué*. He never seems to have felt the delicious shame and ingenuousness of youth; over his heart never was outspread 'the bloom of young desire and purple light of love.' *The Kew Gardens* is written in the style of Churchill, and it possesses all that master's vigour, and every now and then we come on a couplet turned with the felicity of Pope. His genius, however, is in its greatest perfection in the ancient poems. No poet, before or since, has written a tenderer strain than the lament in *Ælla*, or conceived a bolder image than the personification of Freedom in the ode to Liberty in his *Tragedy of Godwin*. C.'s life has been written by many hands, but the best and most sympathetic is that contributed by Professor D. Masson of University College, London, and published in his *Collected Essays*.

CHAUCER, GEOFFREY, the father of English poetry, was born, if we may credit tradition, in 1328, and, from a passage in the *Testament of Love*, his birthplace seems to have been London. The deepest obscurity rests on his early history. It has been said that he studied at Cambridge, and afterwards removed to Oxford. While at the university, he wrote *The Court of Love*, and *The Book of Troilus and Cresseide*. At one period he seems

to have turned his attention to law, and to have become a member of the Inner Temple. About these matters his biographers, knowing little, have conjectured much. The only particular of C.'s youth of which an anxious posterity can be certified is, that he one day thrashed a Franciscan friar in Fleet Street, and was fined two shillings for the exploit on the next. History has preserved this for us, but has forgotten all the rest of his early life, and the chronology of all his poems.

In 1359, C. assures us, on his own authority, that he served under Edward III. in his French campaign, and was therein made prisoner. The date of his return from captivity, and of his subsequent marriage, cannot now be ascertained. He espoused Philippa, youngest daughter of Sir Payns Roet, whose estates lay in Hainault. His wife's sister, Katherine, ultimately became the wife of John of Gaunt, Duke of Lancaster; and it may be presumed that the high connection thus established aided, in no inconsiderable degree, the poet's advancement in life. After his marriage, he began to mix in public affairs. He was sent on an embassy to Genoa in 1372, and, on that occasion, has been supposed by some to have had an interview with Petrarch, then residing at Padua, and to have heard from his lips the story of *Griselda*. On his return, he was appointed comptroller of the customs for wools, and in the same year the king granted him a pitcher of wine daily for life. In 1377, C. proceeded to Flanders in the retinue of Sir Thomas Percy, afterwards Earl of Worcester; and for several years thereafter he was employed assiduously in embassies and other business connected with the public service. In 1386, a commission was issued to inquire into alleged abuses in the department of the customs, and C. was dismissed from his comptrollership in the December of that year. On meeting this fact, one cannot help remembering that Edward made the writing out of the accounts in C.'s own hand the condition of his holding office. Had the great poet neglected his duties? It has been conjectured by some, that after his disgrace C. became embarrassed in circumstances, and apparently with reason, for about this time he cancelled both his pensions, and consigned them to one John Scalby, 'to whom they were probably sold under pressure of distress,' says his latest biographer. In 1387, C. lost his wife. Where he spent his closing years, cannot now be ascertained. Godwin surmises that in his distress he retired to Woodstock, and composed there *The Canterbury Tales*. It seems, however, to be tolerably certain that during the last years of his life he was resident in London. There he died on the 25th October 1400, aged 74, and was buried in Westminster Abbey, the first of the long line of poets whose ashes make that pile so venerable.

C. was a worthy representative of the splendid 14th century. He was a master of the science, the theology, and the literature of his time. He had seen many men and cities, and had formed no inconsiderable unit in imposing ceremonies of state. His poems are numerous, and exhibit every variety of poetical excellence. His earlier performances, such as *The Flower and the Leaf*, *The Romannt of the Rose*, are, after the French fashion then prevalent, gorgeous allegories full of queens and kings, hovers, beves of beautiful ladies, brave knights, and pious nightingales that sing the praises of God. They appeal potentially enough to the eye, but they do not in the slightest degree touch the heart, or relate themselves to human concerns. Quite different *The Canterbury Tales*, so full of humour, pathos, and shrewd observation. In these Tales, English life, as it then existed, is wonderfully reflected—when the king tilted in tournament, when the knight and the

lady rode over the down with falcon on wrist, when pilgrimages bound for the tomb of St Thomas passed on from village to village, when friars sitting in tavern over wine sang songs that formed a remarkable contrast with the services they so piously and sweetly intoned. All that stirring and gaily apparelled time—so different from our own—is seen in C.'s work, as in some magic mirror; and in his case, as in every other, when the superficial tumults and noises that so stun the contemporary ear have faded away, leaving behind that which is elemental and eternal, the poet is found to be the truest historian. Among C.'s other writings may be mentioned, *The Court of Love*, *The Book of Troilus and Cresseide*, *Parliament of Birds*, and the *Book of the Duchess*. The *Canterbury Tales* were printed by Caxton, but the first edition of his complete works did not appear, till 1542.

CHAUDES-AIGUES, a town of France, in the department of Cantal, about 12 miles south-south-west of St Flour. It is celebrated on account of its hot mineral springs, which have the property of discharging grease from sheep's wool, and vast numbers of fleeces are sent hither annually to be washed. The waters are also taken for rheumatism and cutaneous diseases. Pop. 1350.

CHAUDFONTAINE, a village charmingly situated in the valley of the Vesdre, a few miles from Liège, in Belgium, and celebrated for a hot spring which supplies water for hot-baths. There are hotels and lodging-houses for the accommodation of visitors. The place is a favourite resort of the Liégeois. There is here a station on the railway from Liège to Aix-la-Chapelle.

CHAUDIÈRE, the name of a river and of a lake of Canada. The river joins the St Lawrence from the south, about 7 miles above Quebec, forming the celebrated falls of its own name, about 2½ miles from its mouth. The lake—merely one of the many expansions of the Ottawa—has on its right the city of that name, the metropolis of the united colony.

CHAUMETTE, PIERRE GASPARD, one of the most extravagant characters of the French Revolution, was born, 1763, at Nevers, and made his first public appearance at the Cordeliers Club, where he was introduced by Camille Desmoulins. His 'sans-culottism' gained for him such popularity, that he was appointed procurator of the community of Paris, in the place of Manuel. C. was very enthusiastic in favour of the 'worship of reason.' In his zeal, he rejected his own Christian name, Pierre, as having been sullied by saintly associations, and styled himself 'Anaxagoras.' The institution of the tribunal of the revolution, the decree for a revolutionary army, and the law against suspected aristocrats, were carried into effect by C. along with others. He also proposed that the whole French nation should be made to wear wooden shoes, and to subsist on potatoes; but this was too much even for the chimerical enthusiasm of his compatriots. His antics, however, in connection with the 'worship of reason' excited the disgust of Robespierre, who devised measures for bringing the whole company of actors under Hébert to the scaffold. C. was arrested and imprisoned on a charge of having been implicated in a plot against the Convention, and was executed, April 13, 1794.

CHAUMONT, a town of France, in the department of Haute-Marne, on an elevation between the rivers Marne and Suize, about 140 miles south-east of Paris. It is generally well built, with clean, spacious streets, and fine promenades round the upper part of the town. There are considerable

manufactures, including hosiery, cotton yarn, gloves, &c. On the 1st of March 1814, the allied powers here bound themselves by treaty against Napoleon, in the event of the negotiations at Châtillon ending unsatisfactorily. Pop. 5911.

CHAUNY, a town of France in the department of Aisne, about 18 miles west-north-west of Laon. It is built partly on the right bank of, and partly on an island in the river Oise, which is here navigable. It is an old, rather uninteresting place, with manufactures of sacking, hosiery, chemicals, and leather, and an active trade. Pop. 7000.

CHAUSSES, in the armour of the middle ages, were defence-pieces for the legs. Some were made of padded and quilted cloth, with metal studs; some of chain-mail; some of riveted plates; and some of banded mail. It was not unusual to fasten them by lacing behind the leg.

CHAUX DE FONDS, a town of Switzerland, in the canton of Neuchâtel, 9 miles north-west of the city of that name. It is situated in a bleak valley, at an elevation of 3070 feet above the sea, and is scattered over a large area, almost every cottage being surrounded by a garden or croft. It is one of the chief seats of the manufacture of clocks and watches in the canton. The mechanists work chiefly at home, each devoting himself to a particular portion of machinery. In 1851, the number of watches made was 156,000. Population about 15,000.

CHAY ROOT, **CHOYA**, or **SAYAN** (*Oldenlandia umbellata*), a perennial herbaceous plant of the natural order *Cinchonaceae*, said to be a native both of India and of Mexico. It is cultivated on the coast of Coromandel for the sake of its long, orange-coloured roots, the bark of which affords a beautiful red dye. The quality of the bark is said to be improved by keeping it for some years. It is the colouring matter obtained from C. R. which is used to paint the red figures on chintz. C. R. is the Indian madder, and in it some tribes in Ceylon formerly paid their tribute.

CHAYENPUR, a fortified town of Nepal, in the north of India, about 120 miles to the east of Khatmandu, the capital of the state, being in lat. 27° 20' N., and long. 87° 3' E. It is the chief town of a district which yields rice, wheat, cotton, ghes or butter, timber, spices, sugar, tobacco, and pearls.

CHEATING. In the technical language of the English law, C. means the offence of fraudulently obtaining the property of another by any deceitful or illegal practice short of felony, but in such a way as that the public interest may possibly be affected. In order to constitute C., the fraud must be of such a kind as that it could not be guarded against by common prudence. C., in this sense, is an offence at common law, and indictable, which is not the case with imposition in a private transaction. The law of Scotland has no such distinction. See **WEIGHTS AND MEASURES**, **FALSE PRETENCES**, **CHARACTER TO SERVANT**.

CHECK, a variegated cloth, the pattern of which consists of rectangular spaces like a chess-board (Fr. *écheq*, chess), either in black and white, or of various colours.

CHE'CKY (Fr. *échiqueté*). In Heraldry, when the field or any charge is composed of small squares of different tinctures, generally metal and colour, it is said to be checky.

CHE'DDAR, a village in Somersetshire, on the south side of the Mendip Hills, 2 miles south-east of Axbridge, with a level country to the south. It lies at the entrance of a deep rocky gorge, nearly 1 mile long, overhung by stupendous mural limestone

precipices, containing caverns—one being 300 feet long—filled with fantastic stalactites and stalagmites. The celebrated C. cheeses are produced on the rich grass-farms around. The church is supposed to have been built about 1400, and has a sculptured stone pulpit. Population of parish, 2185.

CHEDUBA, an island off Aracan, in the Bay of Bengal, stretching from lat. 18° 40' to 18° 56' N., and from long. 93° 31' to 93° 50' E. Its area is about 250 square miles, and its population 9000. Along with the adjacent mainland, it was ceded to the British at the close of the first Burmese war. The soil is fertile, yielding rice, tobacco, sugar, indigo, cotton, hemp, and large quantities of a vegetable oil, equally fitted for burning and for varnishing. The principal mineral is petroleum. The coast presents earthy cones, which emit mud and gas, and about 100 years ago a severe earthquake is believed to have extended the limits of the island.

CHEESE is the common form in which the Caseine (q. v.) of milk is used in a separate state as an article of food. In new milk, the C. is present in a condition soluble in water, and is generally separated therefrom in a coagulated or clotted form, on the addition of a little rennet (q. v.). In the preparation of C., the milk is gently heated to a temperature of 110°—112° F., and placed in a large wooden tub, where the rennet is added, and the operation of *earning* goes on. In about half an hour, the curd is sufficiently formed. The liquid whey being pressed out, the curd is chopped into small pieces of the size of a walnut by a knife, called a curd-cutter, salt is added, and the fragments of curd introduced into a cloth placed in a cheese-vat or chesart, which is a wooden tub of varying size and shape, perforated at the sides and bottom. The whole is then put under a cheese-press (q. v.), and subjected to great pressure, which consolidates the curd or caseine, and at the same time squeezes out the remaining portions of whey. After two or three hours, the half-formed C. is turned and re-turned, each time being subjected to renewed pressure, till in about two days it is sufficiently compacted. It is then removed from the cheese-vat, and placed on a shelf in a dry airy room, where, being repeatedly turned, it gradually dries, and gets aged or seasoned sufficiently for market in about six months.

There are many varieties of C., which partly owe their difference to the food of the cows, but in greater part to differences in the mode of treating the milk. *Skimmed-milk C.* is prepared from milk from which the cream has been removed, and a rich colour is communicated by adding a little Annatto (q. v.) to the milk before coagulation. *Sweet-milk C.* is procured in a similar manner from the whole milk, and contains much of the butter along with the caseine. *Stilton C.* is made in Leicestershire, by adding the cream of the evening's milk to the new milk of next morning; and as there is always more trouble in expelling the whey from curd containing butter, there is a difficulty in preparing this variety of C., from its liability to fermentation and bursting. *Cheddar C.* is made in Somersetshire, from the whole milk, and the whey is several times skimmed off, heated, and added to the curd to scald it. *Cheshire* and *Double Gloucester* are made from the whole milk; *Single Gloucester*, from half new milk and half skimmed milk. *Gouda C.* is prepared in Holland from skimmed milk curdled by muriatic acid instead of rennet, and for this reason it is not infested with mites. *Suffolk C.* is made from skimmed milk, and so is *Parmesan C.*, obtained from Parma in Italy, which owes its fine rich flavour to the superior

herbage on the banks of the river Po. *Swiss C.* is flavoured with herbs, and especially that of Gruyère, which is very pleasant to the taste. *Cream C.* is prepared from cream curd which has been placed in a cloth, and allowed to drain without the assistance of pressure. Bath and York supply C. of this description. In the fabrication of C., minium or red-lead has occasionally been employed as a cheap colouring substance, and cases of poisoning have resulted therefrom. Carrots, saffron, and marigold flowers have also been used for imparting colour as well as flavour.

When sufficiently dry for use, C. still retains from 35 to 44 per cent. water, and besides the caseine contains a greater or less proportion of oil or fat and saline matter—the latter mainly consisting of common salt, originally present in the milk, and added during the manufacture of the cheese. As an article of diet, C. is highly nutritious; but from its costive properties, it is mainly used as a condiment in small quantity after an ordinary meal, and is then serviceable in giving an impetus to the process of digestion. To serve the purpose of a digester, C. must be old and partially decayed, or mouldy. It then acts as leaven, and causes chemical changes gradually to commence among the particles of the food which has previously been eaten, and thus facilitates the dissolution which necessarily precedes digestion.

CHEESE PRESS—The old method of compressing curd and expelling the whey from it is still employed in many places, the mere piling of weights on the cheese-vat; or the cheese-vat is subjected to the weight of a large stone or box-full of stones, lifted and let down by rope and pulley, or by a windlass. Sometimes the action of a screw is

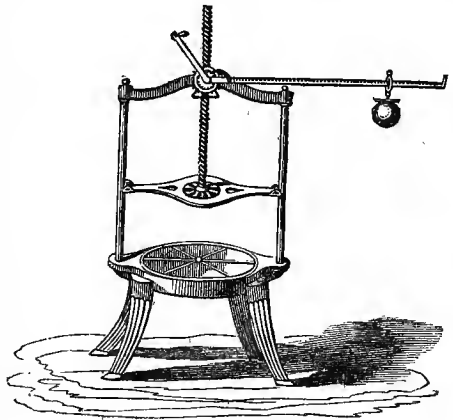

Cheese Press.

employed. Among improved dairy implements are now reckoned, however, many ingenious and elegant forms of cheese press, generally depending on the action of a lever. They are much more convenient than the clumsy contrivances which they have superseded, and admit of the most perfect regulation of the pressure, but no essential change has been introduced by them in the art of cheese-making.

CHEESE-HOPPER, the larva of *Piophilæ casei* or *Tyrophaga casei*, a small dipterous (two-winged) fly, of the large family *Muscidae*, the same to which the house-fly, blow-fly, &c., belong. The perfect insect is about a line and a half in length, mostly of a shining black colour; antennæ, forehead, and some

CHEETAH—CHEKE.

parts of the legs rufous. It is a pest of dairies and store-closets, laying its eggs in cracks or crevices of cheese, the destined food of its larvæ. To preserve cheeses from this pest, it is of advantage to brush or rub them frequently, and to remove all

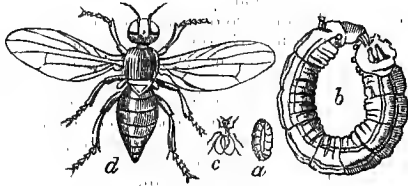

Cheese-hopper:

a, larva, natural size; b, larva, magnified, preparing to spring; c, perfect insect, natural size; d, magnified.

cracked or injured cheeses from large stores, besides keeping them dry and in a well-aired place. The same rules are applicable to their preservation from the other insect larvæ by which they are sometimes infested, of which the most notable are those of the Bacon Beetle (see *DERMESTES*), and of another species of dipterous fly, *Musca corvina*.

CHEETAH, CHITTAH, or HUNTING LEOPARD (*Felis jubata* or *Cynailurus jubatus*), an animal of the feline family, but differing from all the



Cheetah.

rest of that family in its longer and narrower feet and less retractile claws, which are also more blunt and less curved. With these peculiarities are associated a greater length of limbs than is usual in feline animals, adapting it to take its prey by running rather than by leaping, and an intelligent and tractable disposition, constituting an additional point of resemblance to dogs; with which, however, the form of the head and the internal anatomy have nothing in common, but are entirely feline. The C. is in size about equal to a leopard, but the body and limbs are longer. It is very widely distributed, being found in Senegal, South Africa, Persia, India, Sumatra, &c. Its geographic range extends as far north as the Caspian Sea, and the steppes of the Kirghiz Tartars. The Asiatic species described as *Felis venatica* appears to have been fully identified with *F. jubata*; and differences in the quantity of mane, and other unimportant particulars, may probably sometimes have resulted from domestication; for this animal has been long domesticated and employed in the chase, both in Persia, where it is called *Youze*, and in India. Deer and antelopes are the game principally hunted with the C., and packs are kept by Indian princes. The

head of the C. is kept covered with a leather-hood till the game is discovered, when the hunting party, advancing cautiously to within 200 yards of it, the hood is taken off, and the C. stealthily creeps towards the herd, taking advantage of every bush and inequality for concealment, till, on their shewing alarm, he is amongst them at a few bounds, and striking down his victim with a blow of his paw, instantly tears open its throat, and begins to suck the blood. It is then somewhat difficult to withdraw him from his prey, which is generally done by offering him meat. If unsuccessful, the C. does not attempt to follow the herd by running—nor does this animal seem to possess the power of maintaining speed through a lengthened chase—but slowly, and as if ashamed, creeps back to the hunters. The C. is not unfrequently to be seen in menageries in Britain. In a domesticated state, it is extremely fond of attention, and seems to repay kindness with affection. The skin is frequently imported from Africa.

CHEIRA'NTHUS. See WALLFLOWER.

CHEIRO'LEPIS, a genus of fossil ganoid fish, peculiar to the Devonian measures, in which eight species have been found. They had large heads, the spine continued in a rudimentary condition, and the body was completely covered with small lozenge-shaped ganoid scales. The first ray of each fin was converted into a strong spine, whose base was loosely imbedded in the flesh. The pectorals and ventrals were largely developed, while the dorsal was small, and situated behind the anal fin. The generic name, meaning 'scaly-hand,' was given in allusion to the large scaly pectorals.

CHEI'ROMANCY (Gr. *cheir*, the hand; *manteia*, prophecy), or **PALMISTRY**, a form of divination that professes to read the destiny of an individual by the lineaments of the hand. In the middle ages, C. occupied the attention of Cardan, Paracelsus, and other eminent men, who elaborated it into a system. It is now, however, the exclusive property of the gipsies, who still find among maid-servants sufficient credulity to make its practice profitable.

CHEI'ROMYS. See AYE-AYE.

CHEIRONO'COTES, a genus of marsupial quadrupeds, differing from the opossums chiefly in having webbed-feet and aquatic habits. *C. palmatus* or *C. Yapock*, sometimes called the Yapock Opossum, or simply the Yapock, from the South American river of that name, is common in many rivers of Brazil and Guiana. It has a soft woolly fur, the colour of the upper parts of the body is gray, with large transverse patches of black, connected with a dorsal black line, the breast and belly white; the tail is long, very thick at the base, tapering to the tip, and, except at the base, covered with scales. The cheek-pouches are very large. Crustaceans are said to form the chief food of this animal, which is interesting as a sort of marsupial representative of the otter.

CHEIRO'PTERA. See BAT.

CHEIRO'THERIUM, the name given by Dr Kaup to the animal which produced the peculiar hand-like impressions (hence the name, 'hand-beast') on the Triassic rocks of this country and Germany. The remains of the animal having been found, and its structure made out, this name has given place to the more characteristic one of *Labyrinthodon* (q. v.).

CHEKE, SIR JOHN, who deserves to be remembered as one of the revivers of classical literature in England during the 16th c., was born at Cambridge, June 16, 1514. Entering the university of Cambridge,

he devoted himself assiduously to the study of Latin and Greek, particularly the latter language, then much neglected in England. He laboured earnestly to advance the study of the Greek language and literature; and when the first professorship of Greek was founded in Cambridge by King Henry VIII., about 1540, C. was appointed professor. A new mode of pronouncing Greek which he introduced was assailed by Bishop Gardiner, the chancellor of the university; but notwithstanding, C.'s system prevailed. C. was for a time preceptor of the Prince, afterwards Edward VI., whose elevation to the throne secured him rank, wealth, and honour. But being a Protestant, he was stripped of everything when Mary came to the throne, although other lands were given to him on his returning to the Roman Catholic Church, which he did to escape burning, the only alternative offered him by Cardinal Pole. His recantation preyed on his mind so much, that he died in the course of the following year, September 1557. He left several works in Latin, and a pamphlet in English; and among his MSS. was a translation of the Gospel by Matthew, exemplifying a plan for reforming the English language by eradicating all words save those derived from Saxon roots.

CHE-KEANG, one of the eastern and maritime provinces of China, the smallest of the eighteen. Situated in the southern portion of the great plain, it is possessed of great fertility, and produces silk, tea, and rice in abundance. Its capital, Hang-chow, an important and populous city, is the metropolis of the silk districts. 'Above is Paradise,' say the Chinese; 'below are Soo-chow and Hang-chow.' Both these places have this year (1860) been taken by the Tae-ping rebels. Ning-po is the principal port of the province. Pop. in 1812, 26,256,784. Area, 39,150 square miles.

CHELI' CERÆ, or antennal claws, modified antennæ, which, in some of the Crustaceans, and in most of the Arachnida, serve a purpose corresponding with that of the mandibles of insects in the cutting, tearing, or bruising of food. They move, however, up and down, in a direction contrary to that of the mandibles of insects.

CHELMSFORD, the county town of Essex, near the centre of the county, at the confluence of the Chelmer and the Cann, 29 miles north-east of London. The industry of C. is chiefly agricultural. The town is the seat of assizes and local courts, and has a grammar-school founded by Edward VI. Pop. 6033. On a small island called Mesopotamia, in the Chelmer, there has long been a ludicrous mock-election of a member of parliament during the county elections.

CHELO'NIA (Gr. *chelōne*, a tortoise), an order of Reptiles, corresponding in extent with the genus *Testudo* of Linnæus, and of which the most obvious distinguishing character is the enclosure of the whole body in a protective covering connected with the skeleton, so that only the head, the tail, and the limbs are protruded; the limbs being four in number, and all formed on the same plan, in some as feet for walking on dry ground, in others as paddles for swimming. The bony covering consists of two principal parts, called the *carapace* and the *plastron*; the carapace serving as a buckler for the upper parts, and the plastron for the under parts of the body. The carapace is formed from the ribs, of which there are eight pair, and from the annular parts of the dorsal vertebræ, expanded into plates, which are joined to each other by dented sutures, so that the whole acquires great firmness, and the dorsal vertebræ are rendered immovable. The plastron is formed of pieces which represent the sternum

or breast-bone, and which are ordinarily nine in number. So compact and strong is the case of some of the tortoises, that it will bear immense pressure without injury, the arched form of the carapace adding to its strength; whilst the creature, destitute of other means of defence, and incapable of flight, finds safety, at least in its mature state, from all enemies but man, by drawing its head, tail, and limbs within the protecting case, which in some, called Box-tortoises, has certain plates movable, so as more completely to enclose them. The turtles and other aquatic chelonians cannot thus withdraw their head, tail, and limbs from danger, but the greater activity of their movements compensates for this.

The firmly fixed ribs not admitting of the movements by which respiration ordinarily takes place in other vertebrate animals, the C. gulp down air, which they inhale entirely through the nostrils; first filling the cavity of the mouth by elevating the hyoid bone, and then, by depressing it, forcing the air into the lungs, whilst the inner aperture of the nostrils is closed by the tongue. In other respects, as to aëration and circulation of blood, they resemble other reptiles.

The jaws are not furnished with teeth, but act in a manner more resembling that of the mandibles of birds, being like them hard, sharp, and horny. The food of the C. is various. Some of them, among which are all the land-tortoises, subsist exclusively on vegetable food; some of the aquatic C. pursue and eat other aquatic animals.

All the C. are strictly oviparous. Their eggs are hatched by the heat of the sun alone; they lay a great number at a time, which are covered with a calcareous shell, like those of birds. The eggs of fresh-water tortoises are in some places a lucrative article of commerce, from the quantity of oil which is obtained from them.

The C. are found only in the warmer parts of the world, but their numbers in some places are astonishingly great. None of them can properly be reckoned British, although stray turtles have, in a few instances, been found on the British shores. A few species occur in the southern parts of Europe, and some are found in the temperate parts of North America.

All the species are extremely tenacious of life; they are capable of extraordinary abstinence, and of living long after having sustained injuries which would have been immediately destructive to almost any other animal. They are also remarkable for their longevity.

The flesh of some kinds of turtle is well known as an excellent article of food. The eggs of some are equally an esteemed delicacy. Tortoise-shell (q. v.), and the oil already mentioned, are the only other valuable products of the order.

Further information concerning the C. will be found in particular articles devoted to some of the different genera and species. See also REPTILES.

Fossil Chelonia.—Foot-tracks on the Triassic sandstone of Dumfriesshire were referred by their discoverer, Dr Duncan, to tortoises. Similar tracks have been noticed in Devonian and Oolite strata. Their vagueness, however, does not indicate with any certainty the animals which produced them. The first indisputable evidence of chelonian life occurs in the Upper Oolite, where the remains of several pond-tortoises and two or three turtles have been observed. In the newer deposits, they increase in number, so that between 70 and 80 species have been described from the Tertiary strata. In the Eocene deposits of the London Clay, at the mouth of the Thames, there occur the remains of more species of true turtles than are now known to exist

in the whole world. Some of these fossil C. were of a size proportioned to their colossal companions; as, for instance, the gigantic Land Tortoise (*Colosochelys*) of the Sewalik Hills, whose carapace was as much as 20 feet in length.

CHELSEA, a suburb of London, in Middlesex, on the left bank of the Thames, $4\frac{1}{2}$ miles west-south-west of St Paul's. The river is here crossed by a fine iron bridge. Pop. 56,538. Many of the nobility and gentry formerly resided at C., and some of its coffee-houses were much resorted to by pleasure-parties in the 17th and 18th centuries. C. has water-works to supply London, a chain-pier, and floor-cloth factories, besides a training-college for male, and another for female teachers, and the Cremorne House Gardens, now a place of public amusement.

CHELSEA HOSPITAL is an asylum for disabled or superannuated soldiers. The building was commenced in 1609, as a Protestant theological seminary, by Dr Matthew Sutcliffe, Dean of Exeter; and James I. gave it a charter in 1610, as *King James's College*. When Sutcliffe died, in 1629, the building was less than half finished, and the students were only 15 in number. Shortly after this, the scheme was abandoned, and the building used for various purposes. It was then rebuilt, and made into an hospital for disabled soldiers by Charles II. By a warrant issued in 1684, one day's pay per year, and two in leap-years, was deducted from soldiers' pay, for supporting Chelsea Hospital. The hospital has accommodation for about 600 persons besides officers. Attached to it are about 40 acres of land, used as garden and exercise ground. It is governed by a Board of Commissioners, comprising *ex officio* the Lord President of the Council, the First Lord of the Treasury, and the Secretaries of State; but the more immediate management is in the hands of about 120 persons, of whom 20 are military officers, 20 civil officers, and the rest subordinates.

The establishment is maintained for the *in-pensioners* of the British army, who, in the Army Estimates for 1860—1861, are set down at 538. These in-pensioners, besides board, lodging, clothing, washing, medical aid, &c., receive a small sum in money, varying from 5s. 3d. per week for a colour-sergeant, down to 7d. per week for a private soldier. They are all dressed in uniform—red, with blue facings—and are treated as a garrison, in respect to guards, sentinels, &c. Most of the pensioners have belonged to the household troops, or Guards. There is a certain degree of choice open to the men, as to whether they will be *in* or *out* pensioners. The out-pensioners, who are more than a hundredfold as numerous as the others, receive sums of money, varying from 1½d. to 3s. 7½d. per day for life, as a reward for past services. Vacancies in the hospital are filled up once a quarter; and every person admitted must give up his out-pension before he can become an in-pensioner. The cost for in-pensioners is about £15,000 a year; to which is added no less than £10,000 for management. This total of about £25,000 is annually provided by parliament. Doubts have frequently been expressed as to the usefulness of this expenditure; it is exceptional in its character, and the arrangement to which it refers is not in much favour among the soldiery.

CHELTENHAM, a town, parliamentary borough, and fashionable watering-place, in the county of Gloucester, eight miles north-east of Gloucester. It lies in a picturesque and healthy valley on the Chelt, a small stream which rises in the adjacent hills, and flows into the Severn. It is sheltered on the east and south-east by a semi-circle of the Cotswolds. It owes its celebrity and

rapid increase to its mineral springs, of which there are several varieties. The chief street is upwards of a mile long, right and left of which are spacious and elegant squares and crescents, and innumerable villas lately erected for the accommodation of the numerous visitors. Attached to the spas are handsome pump-rooms—with tasteful grounds, avenues, saloons—lodging-houses, and public promenades among the finest in England, besides many fine mansions in and around the town. It has 10 churches and a number of dissenting chapels. Of late years, C. has become famous for its public schools, the oldest of which is its endowed grammar-school, capable of educating 300 scholars; but the largest, and now the most celebrated, is its Proprietary College, for the sons of gentlemen, a noble institution, educating, upon an average, 600 pupils. There are also a Ladies' College, a Junior Proprietary School, and a number of private scholastic establishments. There are public assembly-rooms in the town; which is also much resorted to in winter for its hunting. It has two clubs, and five or six weekly newspapers. Pop. 35,051. C. was enfranchised in 1832, and returns one member to parliament. Its affairs are managed by a board of elected commissioners, who exercise their authority under the powers of a special act of parliament. It has no manufactures of any importance. British and Roman remains have been found here. C. was only a village, in 1716, when the first spring was discovered. It gradually increased till 1785, when the benefit received by George III. from its waters suddenly made it a resort of fashion.

CHEMICO is the common name given to BLEACHING POWDER by workmen and others engaged in chemical works.

CHEMICAL AFFINITY. See AFFINITY, CHEMICAL.

CHEMICAL FOCUS, in Light. See LIGHT.

CHEMICAL NOMENCLATURE AND NOTATION. In early times, chemical substances were named according to the fanciful theories of alchemy (q. v.). Thus the name *flowers of sulphur* was applied to the sublimed sulphur, which grew or sprang like a flower from sulphur when heated; *spirit of salt*, to hydrochloric acid, the corrosive acid or spirit obtained from common salt; and a multitude of other names had a like fanciful origin. In 1787, Lavoisier founded the system of nomenclature which is followed still by chemists. At first, it was intended that the names of simple as well as compound substances should be regulated by system. Hence such terms as oxygen (from *oxus*, acid, and *gennao*, to produce), the *acid-producer*, given from the notion then held that no acid was without oxygen; and hydrogen (from *hydor*, water, and *gennao*), the *water-producer*, from the supposition that hydrogen had more to do with the formation of water than any other element. The advance of chemistry, however, has so completely changed the opinion of chemists regarding the simpler bodies, that such names are now found to mislead; and thereafter, though such as had been given on this system were retained, their meaning has been discarded, and the systematised nomenclature restricted to compound substances. A remnant of the system, however, still subsists at the present time, in making the scientific names of all the metals end in *um*. In the non-metallic elements, a close analogy exists between chlorine, bromine, iodine, and fluorine; and to indicate this, the common termination *ine* has been given; and for a similar reason, carbon, silicon, and boron, end in *on*. As a general rule, however, the chemical name of an elementary substance does not convey

CHEMICAL NOMENCLATURE.

any scientific meaning, and must be regarded as a simple mark or designation, analogous to the names of persons, which give no notion regarding their moral character or physical development. The ancient and more common metals retain their popular titles, such as gold, silver, and copper; but the more recently discovered metals have names given which end in *um*. The symbol of an element is obtained from the first letter of its Latin name, as O for oxygen; Pl for lead (*Lat. plumbum*). When the names of two or more elements commence with the same letter, a smaller letter or satellite is attached to one or more of these; such as S for sulphur, Se for selenium, and Si for silicon. For a complete table of the symbols of the elementary substances, see **ATOMIC WEIGHTS**.

The name of a compound substance generally indicates the elements of which it is composed. Thus the name oxide of iron indicates that the red powder (rust) is made up of oxygen and iron; the sulphuret of lead (*galena*), that it is composed of sulphur and lead. In all similar combinations—

Oxygen forms	Oxides.
Chlorine	" Chlorides.
Bromine	" Bromides.
Iodine	" Iodides.
Fluorine	" Fluorides.
Nitrogen	" Nitrides.
Carbon	" Carbides or Carburets.
Sulphur	" Sulphides or Sulphurets.
Selenium	" Selenides or Seleniurets.
Phosphorus	" Phosphides or Phosphurets.

When two elements combine with each other in more than one proportion or equivalent (see **ATOMIC THEORY** and **ATOMIC WEIGHTS**), the names of the compound bodies are contrived so as to express this. The term *protoxide* is applied to a compound of one equivalent of oxygen with one equivalent of another element; *deutoxide* to a compound containing a larger proportion of oxygen than the protoxide; and *tritoxide* when the oxygen is still further increased. The term *binoxide* is used when oxygen is present in the proportion of two equivalents to one equivalent of the other element; and *teroxide* when the proportion is as three to one. A *suboxide* contains less than one equivalent of oxygen; and a *peroxide* is the highest oxide not possessing acid properties. The same prefixes are applied to the compounds of chlorine, sulphur, &c.

When one element combines with another to produce several compounds possessing acid properties, various terminations are employed to distinguish the compounds. Thus, oxygen combines with a number of the elements to produce with each a series of acid compounds, the more *highly* oxidised of which receive the termination *ic*, whilst those containing *less* oxygen end in *ous*. Thus, sulphuric acid contains three equivalents of oxygen to one equivalent of sulphur; and sulphurous acid, two equivalents of oxygen with one equivalent of sulphur. These terminations are qualified by the use of the prefixes *hypo* (under) and *hyper* (over). Thus *hyposulphuric* acid is applied to a compound containing less oxygen than the sulphuric acid, and *hyposulphurous* to one with less oxygen than sulphurous acid.

When acids combine with bases or metallic oxides to form salts, they produce compounds, the names of which are influenced by the terminations of the acids. Thus, sulphuric acid and soda form the *sulphate* of soda; sulphurous acid and soda, the *sulphite* of soda; and *hyposulphurous* acid and soda, the *hyposulphite* of soda. In the same manner, nitric acid with potash forms the *nitrate* of potash, whilst nitrous acid and potash produce the *nitrite* of potash.

If a symbol be employed alone, it represents one

equivalent of the element. Thus, O signifies one equivalent, or eight parts by weight, of oxygen; C, one equivalent, or six parts by weight, of carbon; H, one equivalent, or one part by weight, of hydrogen. The combination of two elements is represented by placing the symbols for those elements side by side; thus, HO signifies one equivalent of hydrogen and one equivalent of oxygen in a state of chemical combination (*viz.*, water); and NaCl is one equivalent of sodium (*Lat. natron*) united with one equivalent of chlorine (*viz.*, common salt).

When two or more equivalents of one element unite with one or more equivalents of another element, the number of such equivalents is signified by a small figure being placed immediately after the symbol of the element so multiplied. Thus, HO₂ represents one equivalent of hydrogen in combination with two equivalents of oxygen (peroxide of hydrogen); MnO₂ is one equivalent of manganese with two of oxygen (black oxide of manganese); Fe₂O₃ is two equivalents of iron with three equivalents of oxygen (rust); and Pb₃O₄ is three equivalents of lead with four equivalents of oxygen (red lead).

In expressing the formula of a compound substance, the symbol of the metal or its analogue is placed first in order, and is succeeded by the oxygen, chlorine, or similar element. Thus, the symbol for the chloride of mercury is always written HgCl, never ClHg. The same order is carried out in the construction of the formula of more complex substances; the metallic half is placed first. Thus, sulphate of iron—containing sulphuric acid and the oxide of iron—is always expressed as FeO,SO₃, never SO₃FeO. In other words, the symbols are written in the order in which the substances would be named in Latin.

In the construction of the formulas of complex substances, the comma (,) and *plus* sign (+) are often introduced; the former to separate the symbols of substances which are closely united together, and the latter to form a line of demarcation where the components are less intimately combined. Thus, FeO,SO₃+KO,SO₃ represents the compound of the sulphate of iron with the sulphate of potash; KCl+PtCl₂ is the double chloride of potassium and platinum.

Large figures placed at the left hand of a formula multiply all the symbols till a comma or plus sign appears. Thus, 3SO₃ represents three equivalents of sulphuric acid; 3PbO,Ā is three equivalents of oxide of lead, and one equivalent of acetic acid; and KO,SO₃+Al₂O₃,3SO₃+24HO (alum) is one equivalent of the sulphate of potash, with one equivalent of the sulphate of alumina, and 24 equivalents of water. When a compound substance requires to be multiplied, it is enclosed within parentheses, and a large figure placed immediately before it; thus, 3(KO,C₂O₃)†Fe₂O₃,3C₂O₃+6HO represents three equivalents of oxalate of potash, one equivalent of oxalate of iron, and six equivalents of water.

In expressing the formulas of organic compounds, the symbols are written in the following order: CHNO. Thus, turpentine is C₈H₈, alcohol is C₄H₆O₂, and morphia is C₁₄H₁₂N₂O₆.

Arbitrary symbols are occasionally used to represent important complex substances. Cyanogen is known as Cy; the organic acids are recognised by their initial letter with the sign (—) drawn above, as \bar{T} for tartaric acid, C₄H₄O₁₀; \bar{A} for acetic acid, C₄H₃O₃; and \bar{O} for oxalic acid, C₂O₃; while the alkaloids are represented by their initial letter or letters with the sign (+) above; thus, Sr

for strychnine, $C_{12}H_{21}N_2O_4$; \dagger Mo for morphia, $C_{16}H_{17}NO_5$; and Q for quinine, $C_{20}H_{24}N_2O_4$.

Occasionally, in treatises on mineralogical chemistry, arbitrary modes of expressing the composition of minerals are resorted to, which it is not necessary here to explain.

CHEMISTRY is that branch of natural science which takes cognizance of the changes that bodies undergo when they are influenced by affinity (q. v.). Changes that do not alter the nature and properties of substances—such as the falling of a body by gravity, or its expansion by heat—belong to Physics or Natural Philosophy. In chemical changes, again, the properties of the substances are permanently altered. Thus, when a piece of iron is left exposed to damp air, it is after a while converted into a reddish brittle substance (rust), owing to the union with it of the oxygen of the air. Chemistry, then, may be most simply defined as that branch of natural science which considers (1.) The combination of two or more substances to form a third body, with properties unlike either of its components; and (2.) The separation from a compound substance of the more simple bodies present in it: and considering that the steps of the combination and decomposition of substances can never be correctly understood without an intimate knowledge of the properties of substances, it follows that the science of C. must likewise take into notice the description of all the simplest as well as the most complex bodies.

When the science of C. is considered as a whole, including the properties of all the elements or substances, and the combinations and changes which they can under all circumstances undergo, it is distinguished by the title of *Pure, Theoretical, or Philosophical C.* Particular departments of C., where the science is confined to the examination of special objects, receive distinctive names; as *Physical C.*, or *Chemical Physics*, which considers phenomena bordering on natural philosophy and C.; *Mineralogical C.*, which takes cognizance of the composition of minerals; *Physiological C.*, which includes the changes which food undergoes in its transit through the animal economy, and the transformations that take place in organic substances generally; *Medical C.*, which considers the composition and compounding of medicines; *Agricultural C.*, which relates to the composition of soils and manures, the ingredients in plants, and the best modes of supplying the food they require, &c. *Inorganic C.* takes cognizance of dead matter, and the changes it undergoes, whilst *Organic C.* considers the substances obtained from plants and animals.

C. ranks as one of the arts as well as one of the sciences, and the division of *Practical C.* comprehends the rules and processes which must be followed, and the mechanical means which must be resorted to, for the successful prosecution of the art. *Practical C.* is subdivided into *Analytical C.* (q. v.), which is occupied with the separation of simple substances from more complex—as chlorine (Cl) and sodium (Na) from the chloride of sodium or common salt (NaCl)—and to the estimation of the quantities of the several ingredients; and *Synthetical C.*, which has for its object the union of simpler bodies to form more complex—as hydrogen (H) and oxygen (O) to form water (HO). The art of *Assaying* (q. v.) is a department of analytical chemistry. *Applied C.* includes the art of manufacturing the various substances employed in commerce and in domestic life, so far as chemical processes and application are required. It is subdivided into *Technical C.*, which relates to everything connected with the arts and

manufactures; and *Pharmaceutical C.*, which takes cognizance of the substances used in medicine.

History.—The Egyptians appear to have possessed the greatest amount of chemical knowledge of all the nations of antiquity. They preserved dead bodies from decay (see Mummy), fixed colours in silk by means of mordants, prepared many medicines and pigments, as also soap, beer, vinegar, metals and metallic alloys, common salt, vitriol, soda, sal-ammoniac, glass, enamel, tiles, and painted earthenware. The Chinese were very early acquainted with the processes for dyeing, and the preparation of metallic alloys, the fabrication of nitre, sulphur, gunpowder, borax, alum, porcelain, verdigris, paper, &c. From the Egyptians, the Greeks and Romans derived what chemical knowledge they possessed; but they added little or nothing; and when the migration of the northern tribes, and overthrow of the Roman empire, took place, a stop was put for a time to the advancement of all science in Europe. The prosecution of chemical knowledge was taken up by the Arabs before the 8th c., and was carried on by them and by their European scholars the alchemists with the results described under ALCHEMY. The first germs of a real science of C. seem to appear about the end of the 17th and beginning of the 18th c., in the speculations of Becher (q. v.) and the Phlogistic theory of Stahl (q. v.). After this, C. rapidly advanced. In 1718, Geoffrey brought out the first table of *Affinities*; in 1732, Boerhaave published many original experiments on the chemical relations of heat and light; in 1724 Hales, and in 1756 Black, published researches on the air and æiform bodies, shewing that the carbonic acid evolved during fermentation, respiration, and by the action of acids on chalk, was different from atmospheric air. In 1754—1759, Margraff added to the then known earths—lime and silica—two others, alumina and magnesia; he also extracted sugar from plants. In 1770, Priestley began to announce his discoveries of oxygen, ammoniacal, hydrochloric, and sulphurous acid gases, &c. In 1773—1786, Scheels contributed chlorine, hydrofluoric, prussic, tartaric, and gallic acids; also baryta, phosphoric acid from bones, &c., and gave the first hints regarding a new doctrine of combustion. About the same time Bergman and Cavendish enlarged our knowledge of the gases. Lavoisier, between 1770 and 1794, re-organised much of the then known C., and founded a system of C. which still remains as the skeleton of the science. Berthollet, in 1787, contributed much to the doctrine of affinity, and made researches in chlorine, &c. Fourcroy and Vauquelin advanced organic C.; Klaproth gave many contributions to mineral C. Richter devoted himself to the doctrine of combining proportion, which was afterwards perfected by Dalton, as noticed under ATOMIC THEORY (q. v.). The discovery of galvanic electricity by Galvani, and its advancement by Volta, led Sir Humphry Davy, and others, to important researches in the metals and gases. Gay Lussac and Thenard advanced our knowledge regarding organic substances and the chemical relations of heat. Berzelius made laborious researches in mineral C., and gave an exactness to this department which is matter of astonishment to the chemists of the present day. He was also the author of the electro-chemical theory, which has been almost perfected by the labours of Faraday, De la Rive, Becquerel, &c. Organic C. has latterly advanced most rapidly under the researches of Liebig, Wohler, Mitscherlich, Mulder, Laurent, and others. See ATOM, ATOMIC THEORY, ATOMIC VOLUME, ATOMIC WEIGHTS, AFFINITY, ANALYSIS, ELEMENT, &c.

CHEMISTS AND DRUGGISTS, LAWS RELATING TO. Under the head APOTHECARIES is

given some account of the Pharmaceutical Society of Great Britain; of its origin, in 1843, and of the modification of its constitution by the act of 1852. By that act it is provided that the Society shall have the right to examine candidates, and to confer on such as are found worthy the title 'Pharmaceutical Chemist.' As in the case of the medical practitioner, so also in that of the chemist and druggist, there is no penalty for mere practice; but the assumption of the title, which is characteristic of those qualified under the act, is punishable by fine. The legislature proceeds on the principle, that qualifications obtained by examination, are to be regarded as certificates of a regular education, but that the freedom of engaging in business ought not on this ground to be interfered with; and that the right of the subject to consult whom he will in the one case, and to buy drugs from whom he will in the other, is one which must be respected. This seems a sound view. Serious mistakes, such as the substitution of one medicine for another, to the injury of the purchaser, are punishable by law, both in the unqualified and in the case of those qualified under the act. The public also derives great and increasing security in this and in all other departments of human enterprise, from the improving effect of free competition. The operation of the act is simply that of indicating to the public, by a name or title, a class of druggists possessing a higher education; and there cannot be any reasonable doubt that the qualifications given by the Pharmaceutical Society, like those given by professional bodies, will be a just object of ambition to scientific and educated men, in exact proportion to the strictness and discrimination with which they are conferred. The rejection of men of inferior attainments is a duty which the society owes to itself, and which, it is to be presumed, will be the more willingly performed, because it does not necessarily take away the bread of the rejected candidate, though it deprives him of a public sanction which he has not earned by his talents and education.

CHEMITYPE is the name given by its inventor, C. Pül, a Dane, to the art of producing on a metal plate, by a chemical process, an engraving in relief. The outline of the process is this: On a polished plate of zinc an etching or an engraving is made in the usual way. The depressions of this design are then filled up with a melted metal—the nature of which is not revealed—and this super-added metal is then reduced to the exact level of the zinc, so that the design now appears as if inlaid. An acid is next applied to the surface, which attacks the zinc, without affecting the inlaid metal; and thus there results an exact copy in relief of the original intaglio engraving. In competition with wood-cuts, relief-lithographs, and copperplates, C. does not seem as yet to evince any great superiority; it fails especially in that character of strength and softness which wood-cuts express so well. The prints produced by this art look more like engravings than like wood-cuts. They have this advantage, however, that they give an exact copy of the original design made by the artists on the metal; whereas in wood-cutting the drawing made on the block may be impaired in its effect by the engraver. C. is particularly adapted for producing maps by the common printing-press. Pül practised his invention at first on a small scale in Copenhagen, from 1843 to 1846, and then extensively in Leipsic; since 1850, he has been employed in the imperial printing-establishment at Vienna.

CHEMNITZ, a town of Saxony, is situated at the base of the Erzgebirge, and at the confluence of

the river Chemnitz with three other rivers, in lat. 50° 50' N., and long. 17° 55' E. It is the principal manufacturing town of Saxony—its industry consisting in weaving cottons, woollens, and silks, and in printing calicoes, chiefly for German consumption. Cotton stockings are a most extensive manufacture, and rival the British in quality and cheapness. The American markets are chiefly supplied from this place. It has several extensive machine-factories, sending forth spinning machinery to all parts of the continent. For four centuries, C. was a free imperial city. It was fortified, but the walls have now been converted into promenades. Marks of the town's antiquity, however, are still seen in many of its buildings. Pop. about 35,000.

CHEMNITZ, MARTIN, next to Luther and Melancthon the most distinguished German Protestant theologian of the 16th c., was born at Treuenbrietzen, in Brandenburg, 9th November 1522; studied at Frankfurt and Wittenberg; and, in 1548, became rector of the cathedral-school of Königsberg. About 1550, he began to devote himself seriously to theology, and in 1553 went back to Wittenberg, where he delivered prelections on Melancthon's *Loci Communes*, from which sprang his own *Loci Theologici*, which, for method and learning, excels all similar books of the same age. In 1554, he was made a preacher in Brunswick, where he wrote his *Repetitio Sanæ Doctrinæ de Vera Presentia Corporis et Sanguinis Domini in Cena Sacra* (Leip. 1561), in which he defended Luther's view of the Lord's Supper against that of the Swiss reformers; the *Theologia Jesuitarum Præcipua Capita* (Leip. 1562); and the *Examen Concilii Tridentini* (Leip. 1565), a work in which he has argued with remarkable acuteness and learning against the dogmas of the Church of Rome. His *Corpus Doctrinæ Prutenicæ* (1566), written in conjunction with Mürlin, became a standard work of divinity among the Prussian Protestants. But his greatest ecclesiastical achievement was inducing the Saxon and Swabian churches to adopt as their confession of faith the *Concordienformel*, and thus extending and consolidating the creed of Luther. He died at Brunswick, 8th April 1586.

CHEMNITZIA, a genus of gasteropodous mollusca. It has a slender, elongated, many-whorled shell; the whorls striated; a simple semi-oval aperture; and a horny operculum. There are many recent species scattered all over the world. The discriminating characters of the fossil species being taken from the form of the shell, it is more than probable that the remains of very different animals are classed under this generic name. No less than 180 species have been described, occurring throughout all the divisions of the fossiliferous strata from the Lower Silurian upwards.

CHENA'B, the largest, according to general opinion, of the five rivers which give name to the Punjab. Like most of the principal streams of India, it rises to the north of the Himalayas, making its way through the Ritanka Pass at the height of 13,000 feet above the sea, and having its source about lat. 32° 48' N., and long. 77° 27' E. After a descent of 300 miles, the C. reaches the level country. At the close of a course of the same length, it receives, on its right, the Jhelum in lat. 31° 12' N., and long. 72° 12' E.; 50 miles further down, it is joined, on its left, by the Ravee; and 110 miles lower, it absorbs, through the Ghara on its left, the mingled waters of the Beas and the Sutlej. Lastly, at a distance of 60 miles, the accumulated floods, under the designation of Punjnad, lose themselves in the Indus in lat. 28° 55' N., and long. 70° 28' E.—being still 470 miles from the ocean.

CHENOPODIA'CEÆ, or SALSOLA'CEÆ, a natural order of exogenous plants, consisting of herbaceous and half-shrubby plants, with leaves entire or divided, and destitute of stipules. The flowers are inconspicuous, hermaphrodite, or unisexual; the perianth deeply divided, persistent; the stamens inserted into its base, opposite to its segments, and equal to them in number, or fewer; the ovary single, free, or occasionally adhering to the tube of the perianth, with a single ovule attached to the base of the cavity; the style generally with 2—4 divisions. The fruit is membranous, enclosed in the perianth, which sometimes becomes fleshy. The seed has a curved or spiral embryo.—There are about 360 known species, most of which have a



Blitum Capitatum :

a, whole plant, reduced; b, a single flower; c, the same, after flowering.

weed-like appearance, and grow in waste places. They are widely diffused over the world, but are particularly abundant in the northern parts of Europe and Asia. Beet and spinach are among the best known and most useful plants of the order. Many are occasionally used as pot-herbs, as some species of *Chenopodium* and of orache. The fruit of Strawberry Blite (*Blitum capitatum* and *B. virgatum*), a common weed in the south of Europe, has some resemblance in appearance to a strawberry, from the coherence of the fleshy perianths of a whole spike or head of flowers, and a sweetish, insipid taste. The seed of Quinoa (q. v.) is used for food as a kind of grain. Some of the C. are aromatic (see CHENOPODIUM). Some inhabit salt-marshes, and abound in soda, as the Saltworts (q. v.).

CHENOPODIUM, a genus of plants of the natural order *Chenopodiaceæ*, of which some of the native British species are well known by the name of GOOSEFOOT, as weeds growing in gardens, on heaps of rubbish, and in waste places. The species are mostly annuals, with entire or toothed leaves, which, in some of them, have a sort of mealy hoariness. They are mostly natives of Europe, and of the temperate parts of Asia; but some are natives of America, into which, however, some of the common European species have found their way, and are naturalised as weeds. The genus has hermaphrodite

flowers, with perianth of five small green scales, five stamens, and solitary flat seeds. The leaves of many species are used as a substitute for spinach, particularly those of the GOOD HENRY, WILD SPINAGE, or ENGLISH MERCURY (*C. Bonus Henricus*); a perennial plant, native of Britain and other parts of Europe, often found growing by waysides, with stem more than a foot high, powdered with minute transparent globules, and large, alternate, triangular, arrow-shaped, entire leaves. It is cultivated in some places, particularly in Lincolnshire, chiefly for the leaves, but the young shoots are also used as asparagus. *C. intermedium*, *C. album*, &c., annuals, common in waste places, are also excellent substitutes for spinach. *C. obidum* or *vulvaria* (STINKING GOOSEFOOT), an annual with an extremely nauseous odour, growing in waste places in Britain, &c., especially near the sea, is a popular medicine, in much repute as an antispasmodic and emmenagogue. *C. Botrys*, a native of the south of Europe, with pinnatifid leaves resembling those of the oak, and hence called JERUSALEM OAK, is in use as an expectorant and anthelmintic. It is not fetid like



Chenopodium Bonus Henricus :

a, upper part of stem, with flowers, reduced; b, c, d, separate flowers, with two, three, and four stamens.

the species last named, but agreeably fragrant. *C. Ambrosioides* has a strong aromatic odour, is used in Mexico instead of tea, and is much cultivated in France, an infusion of it being deemed useful in nervous disorders. *C. anthelminticum*, the WORM-SEED of the United States, has a strong and somewhat aromatic odour, and a high reputation as a vermifuge. Its seeds are chiefly used, or the essential oil extracted from them, called *Oil of Wormseed*. More important than any of these species, as affording a principal article of food in the countries of which it is a native, is QUINOA (q. v.).

CHEPSTOW, a river-port in the south-east of Monmouthshire, on the right bank of the Wye, 2½ miles from its junction with the estuary of the Severn, and 14½ miles east-north-east of Newport. It lies between bold cliffs, on a slope rising from the river, in the midst of beautiful and grand scenery. There is a fine view from a rock called Windcliff, 970 feet high, three miles and a half up the river. The streets are broad. Here occurs the highest tide in Europe, rising suddenly, with a fierce current, often 50, and on rare occasions even 70 feet. Large vessels reach the town. One of the wells of the town ebbs and flows with the tide. Over

the Wye here is a railway bridge by Brunel, combining the principles of Telford's suspension and Stephenson's tubular bridges. C. has no important manufactures. It exports corn, cider, bark, iron, millstones, timber, and salmon. Pop. (1851) 4295. In 1859, 967 vessels of 35,099 tons entered and cleared the port.

CHEQUE, an order on a banker, or other party, for the payment of money. In all cases, the document must be on a penny-stamp, and it must not be for less than 20s. It is obligatory on the banker to honour the C. if he have funds belonging to the drawer. It must be presented within a reasonable time, otherwise the holder will have no recourse against the drawer should the banker fail. A C. is to be regarded as payment of a debt until dishonoured on presentation. It is not payable after the date of the drawer's death. The banker is liable for forgeries unless caused by carelessness in drawing.

CROSS-CHEQUE. An ordinary C. is payable to a certain party, or alternatively to 'bearer.' To prevent misappropriation when sent by post or otherwise, cross-cheques have been introduced. Two transverse lines are drawn across the cheque. If the words '& Co.' or 'and Company' are written within the lines, payment can be obtained only through a banker. If the name of a particular bank be specified, as 'National Bank, Glasgow,' it must be presented at that bank only.

CHER, a tributary on the left side of the river Loire, rising near Crocq, in the department of Creuse; flows first north by Auzances, Évaux, Montluçon, and St Amand; then north-west through the department of Cher by Vierzon; then westward by Selles, Montrichard, and Bléré, to the Loire, which it joins below Tours. Its whole length is about 200 miles; and it is navigable for the last 47 of its course.—**CHER**, the central department of France, to which the above river gives its name, is situated in lat. 46° 25'—47° 39' N., and in long. 1° 55'—3° 10' E. The surface is mostly level, traversed by well-wooded elevations, and produces corn, fruits, wine, hemp, flax, &c. The climate is mild and pleasant. Agriculture and pasturage of cattle are both capable of improvement. Area, upwards of 2800 square miles. Pop. 314,844. C. is divided into the three arrondissements—Bourges, St Amand, and Sancerre. Bourges is the chief town.

CHERASCO, a town of Piedmont, situated on the Tanaro, 30 miles south-east of Turin. It has manufactures of silk, and a population of 9900. A peace was concluded here between Louis XIII. of France and the Duke of Savoy in 1631. On April 26, 1796, the place was taken by the French; and here, three days after, the 'Armistice of Cherasco' was concluded between the Sardinian commissioners and Napoleon, by which the latter obtained the right of free passage for his troops through the Sardinian States; and the treaty that followed gave to the French republic Savoy, Nice, and the possessions of Piedmont to the westward of the Alps' highest ridge.

CHERBOURG, a fortified seaport town and arsenal of France in the department of Manche, is situated at the head of a deep bay on the northern extremity of the peninsula of Cotentin, on the English Channel, and opposite the west coast of the Isle of Wight, in lat. 49° 40' N., and long. 1° 35' W. Perhaps there is no city in the world that has entered so largely into the history of the last two or three years as C., or one that possesses so much interest for the inhabitants of the British Isles. Occupying a prominent position on the French coast, only some 60 miles removed from the south shore

of England, the harbour-works have been extended, strengthened, fortified, and provisioned with cannon—the dock-yards improved, and facilities of embarkation afforded, to a degree that, as it is unparalleled in ancient or modern times, not unnaturally excites the lively apprehension of Englishmen. A description of the stupendous breakwater of C., enclosing a space of nearly 2000 acres, will be found in the article **BREAKWATER**. In connection with its fortifications, this breakwater assumes an importance that attaches to no other work of the kind in existence. At the apex of the angle formed by the meeting of the two branches of the breakwater or *digue*, there is a centre fort or battery, measuring 509 feet on the inner line of the parapet, which forms a flat semi-ellipse. This work is finished, but the circular forts at the extremities of the breakwater are not yet (1860) complete. Behind the centre battery there is to be an elliptical tower, measuring 225 feet on the major, and 123 feet on the minor axis. Altogether there are six large batteries on the mole. The entrances to the harbour are round the ends of the mole; and the passages are further defended by the fortifications of the Ile Pélée, and by the batteries of La Roche Chavaignac and Fort Querqueville. A series of coast redoubts, and the two large fortifications of Les Roches des Flamands and du Homet, are situated behind this outer zone of defence. 'The arsenal,' says Mr W. H. Russell, who visited C. during the summer of 1860, 'is enclosed by a continuous line of bastion and curtain of a very elevated profile, defended by outworks, wet and dry ditches, and by profuse batteries of the heaviest guns, either in casement or *en barbette*. Wherever you look, you fancy that on the spot you occupy are specially pointed dozens of the dull black eyes from their rigid lids of stone.' Altogether, besides the batteries on the mole, C. is defended by 24 regular forts and redoubts. The town itself is commanded by La Roule (an exceedingly strong fort) and Fort d'Octeville on the heights behind. The military port of C. consists of an outer harbour of 776 feet in length by 663 feet wide, its minimum depth being 58 feet, and the entrance to which is 206 feet wide at its narrowest point. This harbour communicates by means of a lock with a floating basin, 957 feet long by 712 wide. The outer harbour has four building-slips for 120-gun ships, besides some smaller slips, and a fine graving-dock. In August 1858, an inner floating-harbour was inaugurated by the Emperor of the French, in presence of the Queen and many of the Lords and Commons of Great Britain. This harbour, entirely cut out of the solid rock, has a length of about 930 yards, and a breadth of 437 yards, and is surrounded by beautiful building-slips and capacious graving-docks. It is calculated that the roads of C. cannot, on account of the small depth of the greater portion, shelter more than 25 or 30 sail of the line, and about as many frigates, at one time. C. has a commercial port quite distinct from the other, situated on the south-east; but it displays little activity, the principal exports being eggs, butter, and cattle. The town itself is insignificant, the streets being narrow and dirty; and there are no public buildings of note. There are some manufactures of hosiery, chemicals, lace, and leather, and sugar and salt refineries; but the industrial energies of the great bulk of the population are absorbed in the arsenal and dock-yards. C. is a very ancient place; in the 10th c. it was known under the name of *Carusburg*. In 1758, C. was taken by the English, who destroyed the naval and military works, and levied a contribution on the town. Pop., exclusive of naval and military forces, 26,534.

CHERIBON—CHERRY.

CHERIBON, or **SHERIBON**, a seaport town of Java, situated on the north coast, 125 miles east-south-east of Batavia. It has a considerable trade in coffee, indigo, and teak-wood, and is the residence of a Dutch governor. Pop. 11,000.

CHERIMOYER, or **CHIRIMOYA** (*Anona Cherimolia*), the most esteemed fruit of Brazil and Peru, now common, and even naturalised in some parts of the East Indies, and other tropical countries of the Old World. It is a fruit of most delicious flavour, is sometimes described as the finest of all fruits, and sometimes as inferior only to the mangosteen. It belongs to the same genus with the Custard Apple (q. v.). Both flowers and fruit emit a pleasant fragrance, but when the tree is covered with blossom, the odour is so strong as to be almost overpowering. The fruit varies from the size of an orange to 16 lbs. or upwards in weight. It is roundish, or heart-shaped.



Cherimoyer:

Branchlet with leaves, and section of fruit.

Externally, it is greenish, covered with small knobs and scales. The skin is rather thick and tough. Internally, the fruit is snow-white and juicy, and contains a number of small brown seeds. The eatable part is soft like a custard, and forms almost the entire mass of the fruit. The C. attains its highest excellence only in particular soils and situations, and some varieties are much finer than others. No tropical fruit seems better to deserve a higher degree of attention than it has yet received in our hot-houses.

CHERKA'SK. See **TCHERKASK.**

CHERRY (*Cerasus*), a genus or sub-genus of plants, of which the best known yields one of our most esteemed stone-fruits. This is usually regarded as a sub-genus of *Prunus* (see **PLUM**), but is erected by some botanists into a distinct genus on very slender grounds, the most obvious distinction between the species of *Cerasus* and the true species of *Prunus* being that, in the former, the young leaves are conduplicate, or folded up, and in the latter they are convolute, or rolled together. Two species are pretty generally regarded as the parents of the garden cherries usually cultivated, *Prunus* or *Cerasus Avium*, and *P. cerasus* or *C. vulgaris*—the former having the underside of the leaves hairy and a small

austere fruit; the latter having smooth shining leaves and a more juicy fruit. *C. Avium* attains a height of 40—50 feet. *C. vulgaris* is a smaller tree.

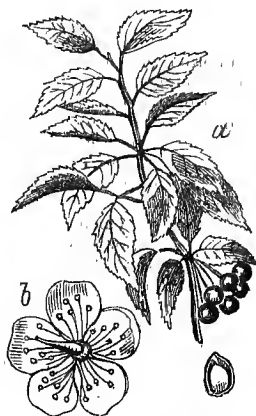

Common Cherry (*Cerasus dura'cina*):

a, branchlet with leaves and fruit; b, flower.

Both have white flowers in clusters or nearly sessile umbels, and both are generally regarded as natives of Britain, and of the middle and south of Europe. In a wild state, they are usually called **GEAN** (*guigne*), and *C. Avium* is frequently planted—not only because it is exceedingly ornamental when in flower, but also as a timber-tree, being of rapid growth, with firm, strong, close-grained wood, suitable for the purposes of cabinet-makers, turners, and musical-instrument makers. But according to some botanists, there is only one species, of which these are varieties; and according to others, *C. vulgaris* is a native of Syria and other parts of Western Asia, and is only naturalised in Europe, having been first brought to Italy by Lucullus, after his victory over Mithridates (74 B.C.), from Kerasunt, on the coast of the Black Sea, from whence it derives its name. The cultivated varieties of the C. are very numerous, and differ very considerably in size, colour, and flavour. The fruit of the C. supplies the inhabitants of some parts of France with a principal article of food, especially the wood-cutters and charcoal-burners of the forests; and among their modes of preparing it is that of making it a principal ingredient in soups. It ripens in Norway and East Bothnia as far north as lat. 63°. In some parts of Germany, the public roads are lined for many miles together with avenues of C. trees. Besides its use for the dessert and for preserves, the C. is extensively used for making liqueurs. See **KIRSCHWASSER** and **MARASCHINO**. Varieties of C. with double flowers, and with pendulous branches, are frequently planted for ornament in shrubberies, and few trees or shrubs are more beautiful. The *Al-saints* C. produces flowers almost all summer, and even in autumn. Its fruit is small and rather acid.—The other species of C. are numerous. Some species are low, or even prostrate shrubs, as *C.* or *P. chama-cerasus*, the **GROUND C.** of the south of Europe and of Siberia; and *C.* or *P. pumila*, the **SAND C.** of North America.—The genus or sub-genus *Cerasus* contains also the different kinds of **Bird C.** (q. v.) and **Choke C.** (q. v.), including the **AMERICAN WILD C.**, famous for its medicinal bark; the **MAHALEB** (*C.* or *P. Mahaleb*) of the south of Europe, and the **CAPOLLIM** (*C.* or *P. capollim*) of Mexico and Peru—the first famous for the fragrance of its flowers, and

the second for the fragrance of its fruit; and the CHERRY-LAUREL (q. v.).

CHERRY-LAUREL, or **LAUREL-CHERRY**, a name given to those species of *Prunus* or *Cerasus* (see **CHERRY**) which have evergreen leaves. They are also often called **LAUREL**. They have small flowers in long racemes, and small fruit; the fruit of a nauseous taste; and most parts of the plant, but particularly the leaves and kernels, remarkably abounding in hydrocyanic (prussic) acid, and therefore very poisonous.—The **COMMON C.**, sometimes called the **BAY-LAUREL**, or **LAUREL-BAY**, very often spoken of simply as the **LAUREL** or **COMMON LAUREL** (*Prunus* or *Cerasus Laurus-cerasus*), is a shrub, sometimes of very large size, with ovato-lanceolate, convex, smooth, remotely serrated, shining, yellowish green leaves, and erect racemes of flowers. It is originally from Asia, but is now naturalised throughout the south of Europe, and is one of the most common ornamental shrubs in Britain, where it suffers only from such severe frosts as are of rare occurrence. It is propagated by seeds, layers, and cuttings. Its leaves resemble bitter almonds in smell and taste, and contain in great abundance the same essential oil (see **ALMONDS**, **VOLATILE OIL OF**), rich in hydrocyanic acid. From these leaves, by maceration in water for 24 hours, and subsequent distillation, is obtained the *Laurel-water* (q. v.), or *Cherry-laurel water*, sometimes employed in medicine as a substitute for hydrocyanic acid, and which formerly was so much used as a poison. The leaves are sometimes employed also for flavouring puddings, sauces, &c., and are safer for such purposes than oil of bitter almonds, but ought to be used with caution.—Another species, also very common as an ornamental shrub in Britain, but not quite so hardy as the common C., is the **PORTUGAL LAUREL** (*Prunus* or *Cerasus Lusitanica*), a native of Portugal, a large shrub—sometimes a tree—with dark-green leaves and lateral racemes. It does not grow so well under the shade of trees as the common cherry-laurel. From the dissimilarity of form and colour of their leaves, these species present a pleasant appearance when mixed, as they usually are, in the shrubbery.

CHERSO, an island of Illyria, belonging to Austria, in the Adriatic, 12 miles south-south-west of Fiume. A bridge unites it with the adjoining isle of Lossini. It has an area of about 105 square miles, with a population of some 14,000. Its surface is generally hilly and rugged, with forests in the north. The chief town is Cherso, at the head of a bay on the west side. Pop. 3500.

CHERSON. See **KHERSON**.

CHERSONESUS, the ancient name of several peninsulas and promontories in Europe, the most important of which are the Crimea (q. v.), *C. Taurica*; Gallipoli (q. v.), *C. Thracia*; and Jutland (q. v.), *C. Cimbrica*.

CHERT, or **HORNSTONE**, a variety of quartz, always massive, and having a kind of granular appearance and structure. It is common in the Mountain Limestone, Oolite, and Green-sand formations; sometimes forms rocks; and often contains petrifications. It passes into common quartz and chalcedony, also into flint and flinty slate. Its colours are gray, white, red, yellow, green, or brown. The name C. is sometimes limited to the finer varieties, and the coarser are called Hornstone.—The name C. is very commonly given to the silicious concretions which occur as nodules and layers in limestone rocks, like flints in the chalk. When these materials exist to such an extent as to render the limestone useless for economical purposes, it is said to be 'cherty.'

CHERTSEY (Anglo-Saxon, Ceort's Eye or Island), a town in the county of Surrey, on a low strip of land between the right bank of the Thames, here crossed by a stone bridge, and the brook from Virginia Water, 20 miles west-south-west of London. It is irregularly built, chiefly consisting of two long cross-streets, and is surrounded by villas. The chief trade is in malt and flour. Many vegetables are raised around for the London market. Pop. 2743. C. arose in a monastery founded in 666, and rebuilt in 964 by Edgar and the Benedictine monks. The South Saxon kings had a seat here during the heptarchy. Charles James Fox lived on St Anne's Hill, an abrupt elevation about a mile from the town. Cowley the poet resided in Chertsey.

CHERUB, in the plural *Cherubim* or *Cherubs*, is the Hebrew name of a winged creature with a human countenance, which in the Scriptures is almost always represented in connection with Jehovah, and especially as drawing his chariot-throne. Cherubim are first mentioned in the Old Testament as guards of paradise; a C. with a flaming sword hindered the return of the expelled human pair. In the Holy of Holies in the tabernacle, and afterwards in the temple, cherubim wrought in embossed metal were represented above the mercy-seat, or covering of the Ark of the Covenant, so that they appeared to rise out of it. Figures of cherubim were also wrought into the hangings of the Holy of Holies. The cherubim that appear in the visions of Ezekiel and the revelations of John depart much from the early representations. In

Ezekiel they have the head of a man, whose body, besides a human countenance, has also that of a lion, an ox, and an eagle; they are provided with four wings, two of which support the chariot of Jehovah, and serve to fly, while the other two cover the body; the hands are under the wings, and the whole body is spangled with innumerable eyes. In the Revelation, four cherubim, covered with eyes, and having six wings, surround the throne of Jehovah; the first has the face of a lion, the second of an ox, the third of a man, and the fourth



Cherub.

of an eagle. This gave rise at a very early period to the symbolical figures of the four evangelists, the human countenance being associated with Matthew, that of the lion with Mark, of the ox with Luke, and of the eagle with John. Most Jewish writers and Christian Fathers conceived the cherubim as angels; and Dionysius the Areopagite, in his *Celestial Hierarchy*, makes them a separate class in the first hierarchy. Most theologians also considered them as angels, until Michaelis shewed them to be a poetical creation; and Herder, in his *Spirit of Hebrew Poetry*, compared them to the griffins that watch treasures and other fabulous figures. In Christian art, they are generally represented as sexless figures, with wings from the shoulders, the legs also being either covered by wings, or having wings substituted for them. Very often they have also a glory round the head.

CHERUBINI, MARIA LUIGI CARLO ZENOBI SALVADOR, one of the best Italian composers, was born September 8, 1760, at Florence, and died March 15, 1842, in Paris, where he was director of the Conservatoire. In his thirteenth year, by his early compositions—a mass and an intermezzo—he attracted the attention of Sarti, who received him as a pupil. In the interval from 1780 to 1788, he composed eleven Italian operas, including *Ifigenia in Aulide*, the most successful of the series. In 1784 he visited London. After 1786, C. resided chiefly in Paris, whence his fame rapidly extended over Europe. Besides the *Ifigenia*, his chief pieces are *Demophon* (1788); *Lodoiska* (1791), *Elisa* (1794), *Médée* (1797), the *Portuguese Inn* (1798), *Les Deux Journées*, and *Anacreon*. C. also composed church music, chamber music, &c., with singular beauty and success. It is worthy of remark that the richness of his instrumental music, which was once made a ground of objection, now appears moderate as contrasted with the monstrous prodigalities of the modern orchestra. See Picchianti, *Notizie sulla Vita e sulle Opere di Cherubini* (Milan, 1843).

CHERUSCI, a German tribe first mentioned by Cæsar. They dwelt north of the Silva Bacensis, or Harz Forest, but the exact boundaries of their territory cannot be ascertained. They are chiefly memorable in connection with their great leader Arminius, or Hermann, who, having formed an alliance with other German tribes, attacked and annihilated the Roman legions under Varus, in the forest of Teutoburg, 9 A. D. After the death of Arminius, internal strifes broke out among the C., and Tacitus says that they were subjugated by the Chatti, a neighbouring tribe. Notwithstanding this they again appear as the chief tribe in the military league of the Saxons about the end of the 3d century. In the beginning of the 4th c., they are included among the peoples who had leagued against Constantine, and towards the close of the same are still mentioned distinctively by Claudian.

CHERVIL (*Anthriscus Cerefolium*), an umbelliferous plant, which has been long cultivated as a pot-herb, and used in soups and for a garnish, &c., in the same manner as parsley. It is much more used in some parts of the continent of Europe than in Britain. It is a native of Europe, naturalised in some parts of England. The leaves have a peculiar, somewhat sweetish, pleasantly aromatic smell and taste, by which the plant may be known from its congener *Anthriscus vulgaris* or *Scandiac Anthriscus*, a poisonous weed, whose leaves have a disagreeable smell, and which is also distinguished by its hispid fruit. There is a variety of C. with large roots, for the sake of which it is cultivated.—The umbelliferous plant called **VENUS' COMB** or **SHEPHERD'S NEEDLE** (*Scandix pecten* or *S. Pecten Veneris*), a native of Britain and of the continent of Europe, often found in cornfields, and remarkable for the appearance and large size of its fruit, and another species (*S. australis*) which grows in the south of Europe, have a taste and smell resembling C., and are used in the same way on the continent. **SWEET C.** or **SWEET CICELY** (*Myrrhis odorata*; *Scandix odorata* of the older botanists), a native of the south of Europe and of some parts of Asia, common in the neighbourhood of houses in Britain, although probably not a true native, is frequently cultivated in Germany under the name of *Spanish C.* or *Anise Chervil*. In Scotland, the plant is commonly called *Myrrh* by the peasantry. Its smell is peculiarly attractive to bees; and the insides of empty hives are sometimes rubbed with its leaves, to induce swarms to enter.—The species of *Cheerophyllum*, coarse weeds, are also called chervil.

CHESAPEAKE BAY, the largest inlet on the Atlantic coast of the United States, being 200 miles long, and from 4 to 40 broad. Its entrance, 12 miles wide, has, on the north, Cape Charles, in lat. 37° 3' N., and long. 76° 2' W.; and on the south, Cape Henry, in lat. 36° 56' N., and long. 76° 4' W., both promontories being in Virginia. C. B. has numerous arms, which receive many navigable rivers, such as the Susquehanna and the Patapsco, on the north, through Maryland; the James on the south-west, from Virginia; and the Potomac on the west, between these two states. Unlike the shallow sounds towards the south (see CAROLINA), this network of gulfs and estuaries, to say nothing of its noble feeders, affords depth of water for ships of any burden, virtually carrying the ocean up to the wharves of Baltimore and the arsenals of Washington.

CHESLDEN, WILLIAM, an English surgeon and anatomist, was born in 1688, at Barrow-on-the-Hill, in Leicestershire. He commenced his medical studies at fifteen, at twenty-three established himself as a lecturer on anatomy, and in the following year was elected a fellow of the Royal Society. He was afterwards appointed surgeon to St Thomas's, St George's, and Westminster hospitals, where he acquired great reputation as an operator. In this respect, few surgeons, if any, ever surpassed him. He died at Bath, 11th April 1752. C.'s principal works are—the *Anatomy of the Human Body* (1713), long a text-book on the subject in England; a *Treatise on the Operation for the Stone* (1723); and *Osteology, or Anatomy of the Bones* (1733). He also contributed several valuable papers to the Philosophical Transactions of the Royal Society.

CHESHIRE, a maritime county in the west of England, bounded north by the river Mersey, and partly also by the Irish Sea, in lat. 52° 56'—53° 54' N., long. 1° 47'—3° 11' W. Its greatest length from north-south to south-west is 58 miles; greatest breadth, 32; area, 1052 square miles, of which only $\frac{1}{5}$ is uncultivated; circuit, 200 miles, of which 8 are coast. The surface forms an extensive nearly level plain between the Derbyshire and Welsh mountains, well wooded, and studded with small lakes or meres, and chiefly occupied by grazing and dairy tracts, which are among the most important in England. This plain, comprising four-fifths of the surface, rests on new red sandstone, and is crossed, near the middle, by a tract of high ground running south-west from a promontory overlooking the Mersey, near the mouth of the Weaver, to Beeston Castle rock, 366 feet high. On the east border of the county is a line of new red sandstone hills. In the north-east is part of the Lancashire coal-field. In the east, are large tracts of peat, and much of the county is wet and rushy. The north-west part of C. forms a hammer-headed peninsula called Wirral, about 8 miles broad, between the estuaries of the Dee and Mersey. Coal measures appear on the west side of this peninsula, as well as on the west border of the main part of the county. The chief rivers are the Dee, Mersey, and Weaver, which are navigable. The Dee skirts the county on the west 55 miles, and the Mersey on the north for 40 miles. The Weaver rises in the east part of the county, and runs 40 miles west-north-west into the Mersey. The county contains an almost unrivalled system of canals, including the celebrated Bridgewater Canal, and is traversed by the main line of the London and Liverpool Railway, and the Crewe, Chester, and Holyhead Railway. The chief mineral products are rock-salt and coal. The rock-salt, discovered in 1670, and mined by gunpowder, is found near the Weaver and its branches, especially

near Northwich, at the depth of 28 to 48 yards, in two beds, the upper one being 15 to 25 yards, and the lower one above 40 yards thick, under a stratum of hard rock, 25 to 35 yards thick. The mines, one occupying 35 acres, when lighted up, resemble a fairy palace sparkling with gems and crystal. Much salt is also made from brine-springs 20 to 40 yards deep. Coal is worked in the north-east part of the county. There are also lead (with cobalt) and copper-mines, and in almost every part of the county freestone, limestone, millstone, and marl are found. The climate is moist. The soil is mostly a clayey or sandy loam, with marl and peat, and very fertile. The soil and climate are well fitted for pasturing, dairy-farming, and cheese-making, which are the chief agricultural occupations. About 100,000 cows are kept in C., and the quantity of cheese annually produced is estimated at from 11,000 to 15,000 tons—the best being made on the strongest lands. The hedgerows abound in oaks. C. is a manufacturing as well as an agricultural county. Pop. in 1851, 455,725. The chief towns are Chester (the county-town), Macclesfield, Stockport, Congleton, Knutsford, and Birkenhead. The county of C. returns 4 members to parliament. C. has some Roman roads, tumuli, barrows, remains of religious houses, and many old castles and halls. The 12th Roman legion occupied Chester till the 3d century. Egbert, in 828, added C. to the Anglo-Saxon kingdom of Mercia. William the Conqueror erected C. into a county palatine, under Hugh Lupus, with an independent parliament and 8 barons. Henry VIII. subordinated it to the English crown; but C. did not send representatives to the English parliament till 1549, and the last remnant of the separate jurisdiction of the palatinate ceased only in 1831.

CHESNUT, or CHESTNUT (*Castanea*), a genus of plants of the natural order *Cupulifera*, closely allied to the Beech (*Fagus*), and distinguished from it by long male catkins, longitudinally set with groups of flowers, a 5–8-celled ovary, and compressed rounded nuts. The name is derived from the town

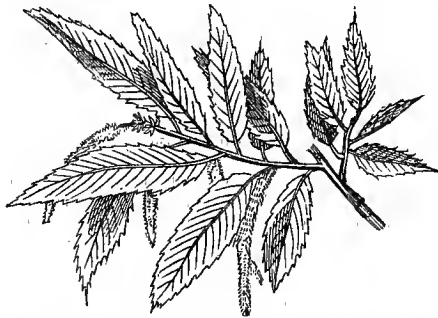

Branchlet, Leaves and Catkins of Sweet Chestnut.

of Castanum, near Magnesia, in Asia Minor. The COMMON C., SPANISH C., or SWEET C. (*C. vulgaris*), is said to have been first brought from Asia Minor to Sardinia, and from thence to have gradually extended over the south of Europe, where it has long been naturalised, and forms extensive woods. It is an ornamental, stately, or, in exposed situations, a very spreading tree, of great size and longevity; the still surviving C. of Totworth in England was known as a boundary-mark in the reign of King John. A celebrated C. tree on Mount Etna measured 204 feet in circumference of trunk. The C. has oblongo-lanceolate, acuminate, serrated, smooth leaves. The timber is durable and hard,

and is used in house-building, for making furniture, and for many other purposes. The timber of the C. so much resembles that of the oak, as in old buildings to be distinguished with difficulty. The bark is used for tanning, but is worth only about half the price of oak-bark. Young C. trees are much esteemed for hop and espalier poles. The C. is therefore frequently grown in England as coppice-wood; but it succeeds well as a timber-tree even in Scotland, although it does not generally ripen its fruit. In Devonshire, however, and in some other parts of England, it is planted to a considerable extent as a fruit-tree. It succeeds throughout all the middle latitudes of Germany, but dislikes a damp foggy atmosphere. It prefers a dry light soil, and succeeds only where there is a dry subsoil. The nuts are generally two in each husk. They form a principal part of the food of the poor in the south of Europe, being used either roasted or boiled, and often ground into flour, and made into a kind of bread. They contain 15 per cent. of sugar, and by pressure yield a sugary juice, which readily undergoes the vinous fermentation, and from which a crumb-like kind of sugar may be obtained. The best kinds of chestnuts are called by the French *Marrons*. When cultivated as a fruit-tree, the C. is generally grafted, by which means the better varieties are secured.—Other species of C. also bear eatable fruits: those of the AMERICAN C. (*C. Americana*), a tree much resembling the common C., and of the DWARF C., or CHINQUAPIN (*C. pumila*), a low tree, or more generally a shrub of 7–8 feet high, are used in America. The fruit of the Dwarf C. is of the size of a common hazel-nut; the nut is convex on both sides. The plant reaches its southern limit on the banks of the Delaware.—A number of species are natives of the East. The inhabitants of the mountains of Java eat the fruit of the SILVERY C. (*C. argentea*), and the TUNGURRUT (*C. Tungurrut*), boiled or roasted, like the common chestnut. Both of these are large trees, the Tungurrut reaching a height of 150 feet.—The HORSE C. (q. v.) is entirely different from the true chestnut.

CHESS (Fr. *échech*, Ger. *schach*). The origin of this, the most purely intellectual of all games of skill, has been much disputed; thus much may now be considered as certain, that, under the Sanscrit name of *Chaturanga*, a game, essentially the same as modern C., was played in Hindustan nearly 5000 years ago. In its gradual diffusion through the world in succeeding ages, the game has undergone many alterations and modifications, both in nature and in name; but marked traces of its early Asiatic origin and descent are still discerned by the learned in its nomenclature and other characteristics. From Hindustan, C. spread into Persia, and thence into Arabia. The Arabs, it would appear, in the 8th c., introduced the game into Spain and the rest of Western Europe; and in England, chess-play seems to have been known prior to the Norman Conquest. Into Constantinople, and probably some other cities of Eastern Europe, the game may have been imported from Persia at a period earlier than its Moorish conveyance into Spain.

The original Hindu game was played on a board of sixty-four squares, as now, but by *four persons*, two being allied against two, as in whist. Hence the name *Chaturanga*, from *chatur*, 'four,' and *anga*, 'a member' or 'component part.' The name *Shatranj*, used by the Persians and Arabs, is a corruption of the Sanscrit. The English, French, and other European names are derived from the Persian term *shah*, 'king.' *Check*, the warning when the king is in danger, is but another form of *shah*; in fact, 'king' is sometimes used for 'check,' and in German

CHESS.

sach is both the name of the game and the term of warning. The term *rook* is from the Sans. *roka*, Pers. *rukli*, meaning a ship or chariot; *pawn* is said to be from *peon*, an attendant, or foot-soldier.

The books written upon C. 'would form a tolerably large library.' Of works on the antiquities of the subject, we may mention Dr D. Forbes's *History of Chess* (Lond. 1860). The best modern practical works on the art of chess-play are the *Chess-player's Hand-book*, and *C. Praxis*, by Staunton; Morphy's *Games at C.*, edited by Lowenthal; Jaenisch's *Treatise on the Openings*, translated by Walker; and Horwitz and Kling's *Collection of End-games*. The subject is also pretty fully treated in Chambers's *Information for the People*, 'In-door Amusements.'

The game of C. is played upon a square board marked out into sixty-four square divisions, which are coloured alternately black and white, in order the more clearly to determine and denote the respective movements of the several pieces. In placing the board for play, each player must always have a *white* corner square at his right hand. There are two sets of pieces, of opposite colours, of sixteen men each, and of various powers according to their rank. These sets of men are arrayed opposite to each other, and attack, defend, and capture, like hostile armies. The accompanying diagram will best explain the name, form, and place of each man at the commencement of the game:

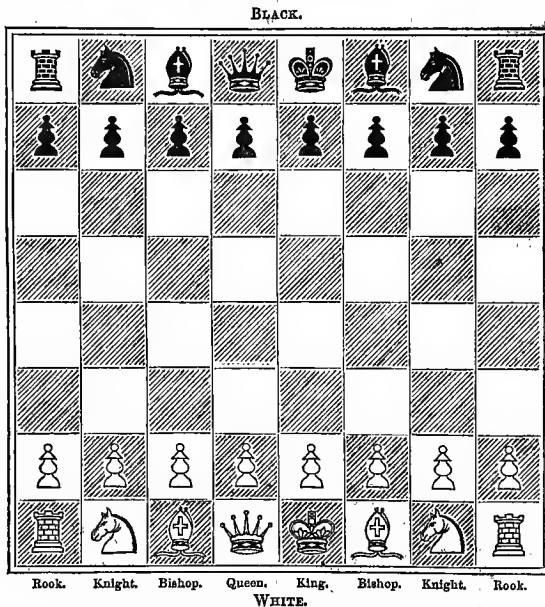

The superior officers occupying the first row on each side are called *pieces*; the inferior men, all alike, standing on the row immediately in front of the pieces, are called *awns*. Their moves and powers, along with the peculiar terms used in C., may be briefly described as follows:

A *Pawn*, at his *first* move, may advance either one or two squares, straightforward; but after having once moved, he can only advance a single square at a time. In capturing* an adverse piece, however,

* Taking is always performed by lifting the captured man from the board, and placing the captor on his square. The pawn is the only man whose mode of taking differs from his ordinary move.

a pawn moves one square diagonally either right or left; but the pawn never moves backward. On arriving at an 8th square, or the extreme line of the board, a pawn may be exchanged for any piece his owner chooses to call for, except a king; so that a player may have several queens on the board at once. If, on moving two squares, a pawn pass by an adverse pawn which has arrived at the 5th line, the advanced adverse pawn may take the other *in passing* in exactly the same manner as if the latter had moved but one square.

A Bishop moves any number of squares diagonally, but diagonally only; therefore a bishop can never change the colour of his square.

A Knight moves two squares, so as always to change colour—that is, he moves one square forward or backward, and one diagonally. On account of this crooked movement, he can leap over or between any surrounding pieces; and therefore a knight's check—unless he can be taken—always compels the king to move.

The Rook, or Castle, moves any number of squares forward, backward, or sidewise, but not diagonally.

The Queen is by far the most powerful of the pieces, and moves over any number of squares, either in straight lines or diagonals, forward, backward, or sidewise; so that her action is a union of that of the rook and bishop. At starting, the queen always stands on a square of her own colour.

The King is the most important piece on the board, as the game depends upon his safety. He moves only one square at once, in any direction, except when he *castles*—a term to be explained presently. The king cannot be taken; but when any other piece attacks him, he is said to be in *check*, and must either move out of check or interpose some one of his subjects, unless the checking piece can be captured. When there is no means of rescuing the king from check, he is said to be checkmated, and the game is over. Of course, the two kings can never meet, as they would be in check to each other. *Double-check* is when a piece, by being moved, not only gives check itself, but also discovers a previously masked attack from another.

Castling is a privilege allowed to the king once in a game. The move is performed either with the king's rook or queen's rook—in the former case, the king is moved to the king's knight's square, and the king's rook is placed on the king's bishop's square: in the latter case, the king is played to the queen's bishop's square, and the queen's rook is played to the queen's square. But the king cannot castle after having once moved, nor at a moment when he is actually in check, nor with a rook that has moved, nor when he passes over a square attacked

or checked by an adverse piece, nor when any piece stands between him and the rook with which he would castle, nor when in the act of castling either the king or rook would have to capture an adverse piece.

A *drawn* game results from neither player being able to checkmate the other: thus, a king left alone on each side must of course produce a draw, as do also a king with a bishop, or a knight, against a king.

Stalemate, or the not being able to move either the king or any other piece, also constitutes a drawn game.

Odds is a term applied to the advantage which a

CHESS.

stronger player should give to a weaker: thus, the removal of a rook or knight from the better player's forces may be fair odds; or if the players are more nearly matched, the one may give a pawn. When the odds of a pawn are given, it is always understood to be the king's bishop's pawn.

Gambit is a technical word implying the sacrifice of a pawn early in the game, for the purpose of taking up an attacking position with the pieces.

Supposing the worth of a pawn to be represented by unity, the following is a tolerable average estimate of the comparative value of the pieces: Pawn 1, bishop 3, knight 3, king 4, rook 5, queen 9.

The chess-men being placed, the players begin the engagement by moving alternately; each aiming to gain a numerical superiority by capturing his opponent's men, as well as such advantages of position as may conduce to victory.

The rows of squares running straight up and down the board are called *files*, those running from side to side are called *lines*, and those running obliquely across are termed *diagonals*.

remember the gaining or losing of time in your measures is the element of winning or losing the game.

Never touch a piece without moving it, nor suffer yourself or your opponent to infringe any other of the laws of the game.

You will find, when first player, that the opening, springing from your playing 1st King's pawn two, and then your King's Knight to the Bishop's 3d, is one of the best that you can adopt; but do not adhere to any one opening only.

If you wish to adopt a purely defensive opening, you may play 1st King's pawn one, and follow up with Q P 2, and Q B P 2.

Next to playing with good players, nothing will conduce to improvement more than looking on at two expert players whilst they play. Wanting these advantages, it is best to play over openings, and actual games, from books or journals.

To prevent blunders and oversights, always endeavour to perceive the motive of your adversary's move before you play; and look often round the board to see that you are not losing sight of any better move than the one you intended, or that you are not suffering yourself to be tempted by a bait.

When an onlooker, never interfere.

Always endeavour to lose with good temper, and to bear your adversary's faults with a good grace.

The Laws of Chess.

The laws of C. are at present in a somewhat unsettled, unsatisfactory condition; but the following are the principal prevailing regulations of the game:

1. If any error have been committed in the placing of the board or men, either player may claim that the game shall be finished as it stands, after four moves have been completed on each side, but not else.

2. A move once made, by your having moved a piece and left hold of it, cannot be retracted.

3. If you touch a piece, you must play that piece; but as long as you retain your hold, you can play it where you like. If you touch a piece that cannot move, your opponent may compel you to play your king, unless the king be unable to move. When you touch your pieces for the mere purpose of adjusting them, you are bound to say so.

4. If you make a false move, your opponent may either cause you to retract it and move your king, or he may claim that the false move shall stand, or that you shall make a legal move with the same piece, at his pleasure.

5. If you touch one of your opponent's men, he may compel you to take that man; or if that be impossible, to move your king, provided he can move without going into check.

6. If on the king being checked, due notice is not given, the player whose king is attacked is not bound to notice it.

7. In every fresh game, except when one is drawn, the first move alternates.

8. Drawn games counting as no games at all, the player who had the first move in a drawn game is also entitled to it in the next. (This absurd regulation is fast becoming obsolete; and it is now a common agreement in playing a series of games, that the move shall invariably alternate.)

9. A player who gives the odds of a piece, is entitled to the first move.

10. The time for consideration of a move is not limited; but a player leaving a game unfinished without his opponent's permission, loses such game.

11. When at the end of a game one player is left with just sufficient superiority of force to win—such as a king and rook against king, king and two

BLACK

QR	OB	Q	K	KB	KK	KR	
QR8	OB8	Q8	K8	KB8	KK8	KR8	
2R7	2K7	2B7	2Q7	2K7	2KB7	2KK7	2KR7
QR7	QB7	Q7	K7	KB7	KK7	KR7	
QR3	QB3	Q3	K3	KB3	KK3	KR3	
QR6	QB6	Q6	K6	KB6	KK6	KR6	
4R4	4K4	4B4	4Q4	4K4	4KB4	4KK4	4KR4
QR5	QB5	Q5	K5	KB5	KK5	KR5	
QR5	QB5	Q5	K5	KB5	KK5	KR5	
QR4	QB4	Q4	K4	KB4	KK4	KR4	
QR9	QB9	Q9	K9	KB9	KK9	KR9	
QR3	QB3	Q3	K3	KB3	KK3	KR3	
QR7	QB7	Q7	K7	KB7	KK7	KR7	
QR2	QB2	Q2	K2	KB2	KK2	KR2	
QR8	QB8	Q8	K8	KB8	KK8	KR8	
QR	QB	Q	K	KB	KK	KR	

WHITE

The accompanying diagram will shew at once to the learner how each square is named; and by its aid he will speedily be enabled either to play over printed games, or to record his own. The playing over the following short game will serve him as a little initiatory practice.

WHITE.

1. King's Pawn two.
2. King's Bishop to Queen's Bishop's 4th.
3. Queen to King's Rook's 5th.
4. Queen takes King's Bishop's Pawn, giving Black check-mate.

BLACK.

1. King's Pawn two.
2. King's Bishop to Q Bp's 4th.
3. King's Knight to K Bp's 3d.

The foregoing brief mode of giving a checkmate is called the *Scholar's mate*, and is often practised upon young and unwary players. Any contractions used, such as 'K' for king, 'B' for bishop, &c., will readily be understood by the use of the diagrams.

In the conduct of the game, and in the practice of C., the following rules, precepts, and hints will be found very generally useful:

Play forth your minor pieces early, and castle your king in good time. You may sometimes delay castling with advantage, but not often.

Do not expect to be able to establish an enduring attack with half your forces at home.

Seek to let your style of play be attacking; and

bishops, or king, knight, and bishop against king—he who has the greater force must give checkmate within fifty moves on each side, or else the game is adjudged to be drawn. This law is framed to prevent unskilful players from wearying their opponents by persisting in the attempt to accomplish what they are too untutored to effect; and it is perfectly just, since the allotted number of moves is amply large enough and to spare.

12. In case of any dispute about the laws, both players are to agree as to an umpire, whose decision is to be considered final.

As there is no branch of chess-study better calculated to advance the skill of a learner than the attentively playing over recorded games between first-rate players, we have given an example of a game played blindfold, simultaneously with five other games, by the celebrated American chess-player, Paul Morphy. This gentleman visited England and the continent of Europe in 1858, and in his contests with the best players fairly carried all before him; so that he now ranks as the greatest chess-player living.

White—Mr Morphy;

1. P to K 4.
2. K Kt to B 3.
3. K B to Q B 4.
4. P to Q Kt 4.
5. P to Q B 3.
6. P to Q 4.
7. Castles.
8. Q B to R 3.
9. Q to Q Kt 3.
10. Q Kt takes P.
11. Q takes B.
12. Q R to Q.
13. P to K R 3.
14. Kt takes Kt.
15. B to K 2.
16. P to K B 4.
17. K B to B 4, ch.
18. Q B to Kt 2.
19. Q R to K.
20. P takes P.
21. R to K 8.
22. Q takes R.
23. Q takes Kt P, ch.
24. P to K B 6.
25. K takes Q.
26. K takes B.
27. R to K Kt, and wins.

Black—Mr C—

1. P to K 4.
2. Q Kt to B 3.
3. K B to Q B 4.
4. B takes Kt P.
5. B to Q R 4.
6. P takes P.
7. P takes P.
8. P to Q 3.
9. K Kt to R 3.
10. K B takes Kt.
11. Castles.
12. Kt to K Kt 5.
13. K Kt to K 4.
14. Kt takes Kt.
15. P to K B 4.
16. Kt to Q B 3.
17. K to R.
18. Q to K 2.
19. R to B 3.
20. Q to K B squ.
21. Q takes R.
22. Q to K 2.
23. Q takes Q.
24. Q takes Kt P, ch.
25. B takes P, ch.
26. P to K R 4.

CHEST, MILITARY, is a technical name for the money and negotiable securities carried with an army, and intended to defray the current expenses. In the English military system, this department is managed by the commissariat.

CHEST, NAVAL. The name of C. has been given to certain funds, maintained for the benefit of seamen belonging to the royal navy. A fund, called the *Chest at Chatham*, was suggested so long ago as the days of Drake and Hawkins, for the relief of wounded and superannuated seamen. In 1590, all seafaring men in Queen Elizabeth's service consented to a stoppage out of their pay of 2*l.* to 6*d.* per month, to support this fund. The money was not in those days, as it would be now, put out to interest; it was kept in a C., and hence the name given to the fund itself. During the 18th c., the system became organised in a better manner; but still the fund retained the name of C.; inasmuch that when the office was removed from Chatham to Greenwich, in 1803, it became the *Chest at Greenwich*. The C. is managed *ex officio*, and the accounts are annually laid before parliament. Handsome gifts

are occasionally made to the fund by individuals. Disabled sailors receive a present sum of money, if not deprived of the power of earning a living; but if their injuries are more permanent, they receive a pension from the C., for one year, or for several years, or for life, paid half-yearly.

CHEST, or THORAX, in Anatomy, is the part of the body which lies beneath the neck and above the Abdomen (q. v.), constituting the uppermost of the two divisions of the trunk, or that which contains the heart and lungs, and is bounded externally by the ribs. The C. is somewhat conical in form, the broad or lower end of the cone being shut in by the diaphragm, a large muscular partition which projects upwards from the lower ribs, being convex towards the C., and concave towards the abdomen. In Respiration (q. v.), the diaphragm descends by its own muscular contraction, while at the same time the ribs are drawn upwards and outwards by the intercostal muscles. The cavity of the C. is thus enlarged, the lungs are expanded, and air is drawn into them through the trachea or windpipe and bronchi. See LUNGS. The combination of bone, cartilage, muscle, and tendon entering into the composition of the C. is such as to permit of expansion-movement to the extent required, and yet to guard against over-expansion, which would be fatal to the delicate textures within. The bones of the C. are at the same time a powerful protection against external injury.

The structures forming the walls of the C. are: 1. The backbone or spinal column, AA, divided into 24 vertebræ, 12 of which, called the dorsal

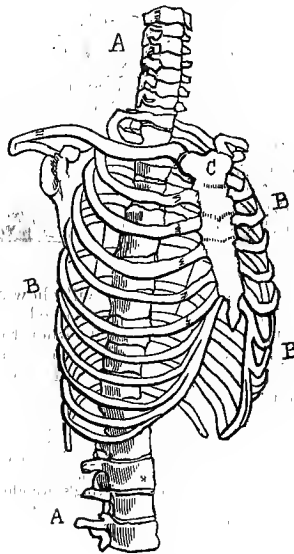

Chest.

vertebræ, form the thoracic portion. 2. Twelve ribs, B, B, B, attached to the transverse processes or projecting portions of the dorsal vertebræ, and ending in front in the costal cartilages, by which the ribs are connected with 3. The sternum or breast-bone, C, which occupies the middle line. 4. The Diaphragm (q. v.). See also SKELETON.

The contents of the C. are the heart, the great arteries and veins, the lungs, the trachea or windpipe, the bronchi or branches of the trachea, leading to the lungs, the œsophagus or gullet, and the Thoracic Duct (q. v.), or general terminus

of the lymphatic system of vessels, by which the chyle and lymph are discharged into the blood. The very great importance of these parts to life, and their great liability to deranged action, renders the C. the seat of a large proportion of the diseases which afflict humanity, and especially of those which end in death. Indeed, of the three organs which the great physiologist, Bichat, called the 'tripod of life'—viz., the brain, heart, and lungs—the C. contains two; hence its condition in almost all diseases, and especially in fatal diseases, is an object of the utmost solicitude to the physician.

The diseases of the C. depend in some cases on alterations in its form, as by Rickets (q. v.) and other diseases affecting the bones in early childhood or in youth, as by too tight lacing in girls. The lungs and air-tubes are subject to a great variety of diseases, among which the principal are consumption or phthisis pulmonalis, pneumonia, pleurisy, bronchitis or pulmonary catarrh. The heart is subject to pericarditis, endocarditis, and chronic organic disease of the valves, as well as to enlargement (hypertrophy), dilatation, and degenerations of its muscular texture. The aorta, or great artery, is often affected with degeneration of its walls, and occasionally with aneurism. The great veins are liable to over-distension, and to obstruction by tumours or by coagulation of the contained blood. The thoracic duct is also sometimes obstructed by external pressure; and the œsophagus has a number of diseases usually described in connection with the alimentary canal. Most of the diseases here referred to are described either under special articles, or under LUNGS and HEART.

The examination of the C. by physicians is now conducted not only by an investigation of the symptoms or obvious characters of the disease, but by a minute and elaborate examination into the physical condition of the contained organs by means of Auscultation (q. v.), Percussion (q. v.), Measurement, &c. The application of these methods is too complicated and technical for explanation in detail, but their results will be shortly alluded to incidentally in the articles above referred to on the diseases of the chest. The name of Laennec (q. v.) will be long remembered in medicine as that of a great original observer, who has contributed more than any other to the progress of knowledge in this department.

CHESTER, an ancient and episcopal city, municipal and parliamentary borough, and river-port, the capital of Cheshire, on the right bank of the Dee, 22 miles from the mouth of its estuary, 16 miles south-east of Liverpool. It stands on a rocky sandstone height, and is mostly enclosed in an oblong quadrangle of ancient walls, 7 or 8 feet thick, nearly 2 miles in circuit, and with 4 gates, and now forming a promenade with parapets, where two persons can walk abreast. The two main streets cross each other at right angles, and were cut out of the rock by the Romans 4 to 10 feet below the level of the houses. The houses in these streets are curiously arranged: the front parts of their second stories, as far back as 16 feet, form a continuous paved promenade or covered gallery, open in front where there are pillars and steps up from the street below, with private houses above, inferior shops and warehouses below, and the chief shops of the town within. This arrangement, called the 'rows,' together with the ancient walls, and the half-timbered construction of many of the houses, with quaintly carved ornamented gables of the 16th c., render C. perhaps the most picturesque city in England. C. cathedral is an irregular massive structure of

crumbling sandstone, 375 by 200 feet, with a tower of 127 feet. It was formerly the church of the abbey of St Werburgh, and for 650 years was one of the richest in England. St John's Church, now partially in ruins, is supposed to have been founded by Ethelred in 698. The Dee is crossed by a stone arch of 200 feet span, the largest stone arch that has been built. The barracks contain nearly 30,000 stand of arms. The C. railway station is the centre of six important railways, and is one of the largest and finest in the kingdom. C. has manufactures of white-lead, sheet-lead, lead-pipes, and patent-shot. The chief exports are cheese, copper, cast iron, and coal. C. has many charitable and religious institutions, is the abode of many wealthy families, and has long been noted for its races. Pop. 27,756. C. returns two members to parliament. In 1859, 3090 vessels, of 157,834 tons, entered and cleared the port, but the silting up of the mouth of the Dee is against the shipping trade.

C. was *Devana Castra*, or Colonia Devana, an important Roman station, and has yielded many Roman remains—as masonry, coins, inscriptions, fibulæ, altars, a hypocaust, and a statue of Pallas. C. was only in 828 taken by the Saxons from the Britons. Its strength made it a refuge against the descents of the Danes and Northmen, but the Danes took it in 894. Ethelfrida retook it in 904, and rebuilt the walls. From the Norman Conquest to the time of Henry III., the Earls of Chester had their own courts and parliaments at C., with 8 subfeudatories and the superiors of the great religious houses, Cheshire being then a county palatine. Henry III. made his eldest son Earl of Chester, a title held since by the Prince of Wales. Llewelyn ravaged C. in 1255. The 25 famous C. mysteries or religious plays by Randle a monk (1250—1260), were acted in the church. After a long siege, the parliamentary forces defeated those of Charles I. at C., and took the city. Pearson and Porteus were bishops of Chester. Trinity Church contains the remains of Matthew Henry, the biblical commentator. The commerce of C. has steadily declined since the rise of Liverpool.

CHESTERFIELD, a municipal borough in Derbyshire, near the Hipper and Rother rivulets, 24 miles north-north-east of Derby by rail. There are manufactures of leather, silk, lace, earthenware, and machinery; and there are several blasting-furnaces in the neighbourhood. The manufactures are increasing rapidly, and the minerals in the neighbourhood, including coal, iron, potters' and brick clay, slates, and lead, are being greatly developed. The population, which in 1851 was 7100, is growing fast. Trade is facilitated by a canal connecting C. with the Trent, and by the main line of the Midland Railway.

CHESTERFIELD, EARL OF (PHILIP DORMER STANHOPE), an English statesman and author, eldest son of the third Earl of Chesterfield, was born in London, September 22, 1694, and studied at Cambridge. In 1714, he made the tour of Europe, and the following year was appointed a gentleman of the bedchamber to the Prince of Wales. About the same time, he was elected M.P. for St Germans, in Cornwall. In 1726, on his father's death, he became Earl of C., and in 1727 was sworn a privy councillor. In 1728, he was appointed ambassador extraordinary to Holland, and in 1730 was made a knight of the Garter and Lord Steward of the Household, but soon resigned that office. An eloquent and frequent speaker, he took an active part in all the important business in the House of Lords, and was for several

years the strenuous opponent of Sir Robert Walpole, then premier. In 1744, he connected himself with the administration, and in 1745 was re-appointed ambassador to the Hague, but was soon nominated Lord-lieutenant of Ireland, where he rendered himself exceedingly popular. In October 1746, he became one of the principal secretaries of state, but, two years after, declining health caused him to resign office, and in 1752 he was seized with deafness. Distinguished by brilliancy of wit, polished grace of manners, and elegance of conversation, he lived in intimacy with Pope, Swift, Bolingbroke, and other eminent men of the day. Dr Johnson, whose Dictionary, on its appearance, he affected to recommend, called him 'a wit among lords, and a lord among wits.' He wrote several papers, on temporary subjects, in *The Craftsman*, *The World*, periodicals of the time; but he is now best known by his *Letters to his Son*, Philip Dormer, written for the improvement of his manners. These letters have been often republished, and they afford a good idea of the mental and moral calibre of the author. Lord C. died March 24, 1773.

CHESTERFIELD INLET, a long and narrow gulf, penetrating to the westward from the north-west of Hudson's Bay. Its extreme dimensions are 250 and 25 miles; and the lat. and long. of its mouth are 63° 30' N., and 90° 40' W. C. I. is studded nearly throughout with islands.

CHEVALIE'R (Fr. *cheval*, a horse), in Heraldry, a horseman armed at all points. In its more general acceptation it signifies a Knight (q. v.). See also **BANNERET** and **CHIVALRY**.

CHEVALIER, MICHEL, an eminent French economist, born at Limoges, January 13, 1806, was, at the age of 18, admitted a pupil of the Polytechnic School. Thence he went to the School of Mines, and some days before the revolution of July, he was attached as an engineer to the department du Nord. Led away by the theories of the St Simonians, he was for two years editor of the *Globe*, the organ of that sect. Joining the schism of M. Enfantin, he took an active part in the compilation of the *Livre Nouveau*, the standard of their doctrines, and in 1832 suffered six months' imprisonment, on account of his free speculations in regard to religious and social questions, being regarded as an outrage on public morals. On his liberation, he at once retracted all that he had written in the *Globe* contrary to Christianity, and against marriage, and obtained from M. Thiers a special mission to the United States, to inquire into the systems of water and railway communication there. The results were published in his *Letters from North America* (1836, 2 vols. 8vo). After a visit to England, he issued a work, entitled *Material Interests in France: Public Works, Roads, Canals, Railways* (1838, 8vo). He was named, successively, Chevalier of the Legion of Honour, Councillor of State (1838), a member of the Superior Council of Commerce, and of the Royal Council of the University; and, in 1840, Professor of Political Economy in the College of France. In 1840, he was re-established in the Corps of Mines as engineer of the first-class; and in 1845—1846, was elected a member of the Chamber of Deputies. Under the Republic, he lost his various employments, and was thrown into the ranks of the counter-revolutionists. In opposition to the different Socialist writers of the day, he published, in 1848, *Letters on the Organisation of Labour and the Question of the Labourers*; and after the *coup d'état* of December 2, was restored to his professorship, and named councillor of state. He is the author of various works on industrial policy and political economy, and is a prominent

figure in the gradually increasing band of French Free-traders, who are attempting to indoctrinate the national mind with sound principles of economy.

CHEVAUX-DE-FRISE, in Fortification, is a hastily constructed substitute for a regular abattis, to stay the progress of an advancing enemy. It may be constructed in any way of wood or iron, provided it presents an array of sharp or ragged points towards the enemy. Sometimes it is made of barrels or centres of timber, with spears springing out from all sides, in such a way as to constitute both a support and a defence. Among

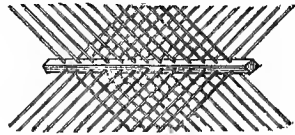

Cheval-de-Frise.

the *matériel* of an army under the care of the engineers, are sometimes comprised C. formed of cylindrical iron barrels, about 6 feet long, each having 12 holes to receive as many spears; the spears can be packed away in the barrel, when not in use. Each such piece constitutes a *cheval*; and many such, ranged end to end, form *chevaux*, to be used in ditches around a fortification, on the berme beneath the parapet, behind the glacis, across a breach in the rampart, or in any spot where a check to the storming-party is needed. At Badajoz, during the Peninsular war, great service was rendered by a C. formed of sword-blades fixed into beams of wood. The name is said to have been derived from 'Friesland horse,' and to have been first applied by the French during the wars of the 17th century.

CHEVIOT HILLS, a mountain-range occupying contiguous parts of the counties of Northumberland and Roxburgh, on the English and Scotch borders, and running 35 miles from near the junction of the Till and Tweed, in the north-east, to the sources of the Liddel, in the south-west. The highest points are C. Hill, 2684 feet, and Carter Fell, 2020. West of Carter Fell, these hills chiefly consist of carboniferous sandstone and limestone, with protrusions of trap. The east portion of the range is porphyritic, and includes higher and more or less conical hills. In the C. H. are the sources of the Liddel, Tyne, Coquet, and some of the branches of the Tweed. Grouse abound, and the golden eagle is seen. These hills afford pasture for the Cheviots, a superior breed of sheep. They have been the scene of many bloody contests between the English and Scotch.

CHEVRE'TTE. See GYN.

CHEVREUIL, MICHEL EUGÈNE, a distinguished French chemist, born August 31, 1786, at Angers, in the department of Maine-et-Loire. In 1820, he was made an examiner in the Polytechnic School; and in 1824, director of the dyeing department in the manufactory of the Gobelins. This last position led him to institute a series of accurate researches on colours, the results of which he made known in a series of *Mémoires* of the Academy of Sciences. Previous to this, C. had made himself known in the scientific world by a variety of researches and writings. In 1826, he was made a member of the Academy; and in 1830, Professor of Applied Chemistry in the Museum of Natural History. Besides a great number of articles in the *Journal des Savants*, beginning with 1820, the

following works of C. deserve mention: *Leçons de Chimie appliquée à la Teinture* (2 vols., Par. 1828—1831); *De la Loi du Contraste simultané des Couleurs et de l'Assortiment des Objets colorés* (Par. 1839); and his *Théorie des Effets Optiques que présentent les Etoffes de Soie* (Lyon, 1846). The last work contains the lectures delivered by C. at Lyon in 1842 and 1843, at the request of the ministry of trade and agriculture. He is also the author of *Lettres adressées à M. Villemain sur la Méthode en Général* (1855).

CHEVRON, in Heraldry, an ordinary representing the couples or rafters of a house, and supposed to betoken the accomplishment of some memorable work, or the completion of some business of importance, generally the foundation of his own family by the bearer. The C. is formed of two lines placed



Chevron. Chevronel. Per Chevron.

pyramidically, i. e., joined together at the top, and descending to the extremities of the shield in the form of a pair of compasses. *Chevronel*, a diminutive—half the size—of the chevron. *Per chevron*, or *party per chevron*, is where the shield is divided by a line in the form of the chevron.

CHEVRON, in Architecture, a moulding in the form of a succession of chevrons, otherwise called a zigzag moulding. In general, it is characteristic of

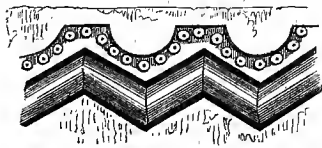

Chevron, or Zigzag:
Andover, Hants.

Norman architecture, but is also found with the pointed arch, during the transition period from Norman to Early English.

CHEVRONS are braids or bands of lace, worn as distinguishing marks by the non-commissioned officers of regiments. The corporals, and the various grades of sergeant, have C. varying from one to four in number, either of white or of gold lace. In most corps, they are worn on the right arm only; but in the Guards, the Fusiliers, the Light Infantry, and the Grenadier and Light Infantry companies of the ordinary regiments, on both arms.

CHEVY CHASE, the name of perhaps the most famous of British ballads. In its present form, the piece does not seem to be older than about the beginning of the 17th century. But more ancient versions, doubtless, existed; and Bishop Percy has published a poem of the 16th c., which has obviously suggested passages in the more recent composition. It is impossible to reconcile its incidents with history, but the event which is meant to be commemorated appears to have been the battle of Otterburn, in August 1388—a fight which Froissart declares to have been the bravest and most chivalrous which was fought in his day. According to the ballad, Percy vowed that he would enter Scotland, and take his pleasure for three days in the woods of his rival, and slay the deer therein at will. Douglas, when he heard the vaunt,

exclaimed: 'Tell him he will find one day more than enough.' Accordingly, at the time of the hay-harvest, Percy, with stag-hounds and archers, passed into the domains of his foe, and slew a 'hundred fallow-deer and harts of grace.' When the English had hastily cooked their game, and were about to retire, Earl Douglas, clad in armour, and heading his Scottish spears, came on the scene. Haughty challenge and defiance passed between the potentates, and the battle joined. In the centre of the fray the two leaders met: 'Yield thee, Percy!' cried Douglas. 'I will yield to no Scot that ever was born of woman!' cried Percy. During this colloquy, an English arrow struck Douglas to the heart. 'Fight on, my merry men!' cried he, as he died. Percy, with all the chivalrous feeling of his race, took the dead man by the hand, and vowed that he would have given all his lands to save him, for a braver knight never fell by such a chance. Sir Hugh Montgomery, having seen the fall of Douglas, clapped spurs to his horse, dashed on Percy, and struck his spear through his body a long cloth-yard and more. Although the leaders on both sides had fallen, the battle, which had begun at break of day, continued till the ringing of the curfew-bell. Scotsmen and Englishmen claim the victory. When the battle ended, representatives of every noble family on either side of the border lay on the bloody greensward.

CHEYNE, GEORGE, an eminent Scottish physician, born in Aberdeenshire in 1671, was at first intended for the church, but preferring the medical profession, studied at Edinburgh, under the celebrated Dr Pitcairn. In 1700, after taking the degree of M.D., he repaired to London, where he practised in winter, and in Bath in summer. From full living he became enormously fat, as well as asthmatic, and resolved on strictly adhering to a milk and vegetable diet, from which he derived so much benefit that he recommended it in all his principal medical treatises. In 1702, he published *A New Theory of Fevers*, and, in 1703, a work *On Fluxions*, which procured him admission into the Royal Society. Among his other works are: *Philosophical Principles of Natural Religion*, 1705; *Observations on Gout*, 1722; *Essay on Health and Long Life*, 1725; *The English Malady, a Treatise on Nervous Disorders*, 1733; *Essay on Regimen*, 1739; *Account of Himself and of his various Cures*, 1743. Dr C. died at Bath, April 12, 1743.

CHIABRERA, GABRIELLO, an Italian poet, born at Savona, 8th June 1552. He was educated at Rome under the care of his uncle, after whose death he entered the service of Cardinal Cornaro, but was obliged to leave it in consequence of the revenge he had taken on an Italian nobleman who had done him an injury. In his 50th year he married, and remained independent for the rest of his life. He died 14th October 1637. C.'s poetical faculty developed itself late. Having commenced to read the Greek writers at home, he conceived a great admiration of Pindar, and strove successfully to imitate him. He was not less happy in catching the naive and pleasant spirit of Anacreon; his canzonetti being distinguished for their ease and elegance, while his *Lettere Famigliari* was the first attempt to introduce the poetical epistle into Italian literature. C. also wrote several epics, bucolics, and dramatic poems. His *Opere* appeared at Venice, in 6 vols., 1768.

CHIANA (in ancient times, *Clanis*), a river in Tuscany, formed by several streams from the Apennines, and falling into the Arno a few miles below Arezzo. Along with another river of the same name, which, flowing in the opposite direction,

enters the Paglia at Orvieto, it waters the perfectly level Val di Chiana, which its overflow rendered once the most pestilential district of Italy. Ferdinand III. and his minister, Fossombroni, undertook extensive hydraulic works for improving the bed of the river, which they led through the lakes of Montepulciano and Chiusi, and employed for the artificial irrigation of the whole valley. The district has since become the most fruitful, perhaps, of all Italy—a perfect garden, supporting a population of more than 100,000.

CHIAPA, or **CHIAPAS**, a state in the south-east of the Mexican confederation, lying to the south-west of Yucatan, and extending in lat. between 16° and 18° N., and in long. between 90° 30' and 94° W. It contains about 19,000 square miles, and about 44,000 inhabitants, chiefly aborigines. Near Palenque, one of the towns of C., are some of the most extensive and magnificent ruins in Central America.

CHIARAMONTE, a town of Sicily, about 32 miles west-south-west of Syracuse. It is situated on a hill, and has well-built, regular streets. Wine of good quality is produced in the district. Pop. about 8000.

CHIARI, a town of Lombardy, 14 miles west of Brescia, on the railway between that place and Milan. It is an ancient place, many Roman remains being still found here; and at one time it was strongly fortified, but its walls are now ruinous. Silk is the staple manufacture. Pop. 10,000.

CHIAR-OSCURO (Ital.), an artistic term, composed of two Italian words, the one of which signifies light, the other darkness or shadow. But C. signifies neither light nor shadow; neither is it adequately described by saying that it is the art of disposing of both the lights and shadows in a picture, so long as either is regarded apart from the other. It is rather the art of representing light in shadow and shadow in light, so that the parts represented in shadow shall still have the clearness and warmth of those in light, and those in light the depth and softness of those in shadow. It is not the making of the one die softly and gradually away into the other, but the preservation of both in combination, as we constantly see it in nature, when the light is not the mere glare of the sun striking on a particular object, nor the shadow the entire absence of the influence of light. That the skilful treatment of C. is a matter of extreme difficulty, is plain enough from the very small number of artists who ever attain to it. Still, it is a branch of art without the mastery of which no painting can be successful in any department. It is as indispensable in portrait-painting as in the highest departments of ideal art; and though a just and even a lofty conception of the subject may be distinctly indicated by attention to form alone, it is impossible that its realisation can ever be satisfactorily accomplished by any one who has not mastered this most subtle mode of handling colours. The only mode by which a knowledge of C. can be attained, so as to apply it to practice, is by studying it as exhibited by such painters as Titian, Rubens, Rembrandt, and, above all, Correggio.

CHIAVARI, a maritime town of Piedmont, situated on the Gulf of Rapallo, at the mouth of the Sturla, 21 miles east-south-east of Genoa. The houses in general are well built, with open arcades skirting the narrow streets. C. has several fine churches, the principal of which is the *Madonna del Orto*. Numerous picturesque old towers, one of them of considerable size, are scattered over the town. Lace and silk are manufactured here; and

the place is also noted for its light, handsome, cheap furniture, made chiefly of cherry-wood. The anchovy fishery is important; and in the vicinity are extensive slate-quarries. Pop. 10,900.—The province of C., of which the above town is the capital, has an area of 155 square miles, with a population in 1857 of 109,212. Its surface is generally mountainous, but it has valleys of great fertility, yielding grain, grapes, olives, &c. Cattle, sheep, goats, and silk-worms are reared.

CHIAVE'NNA, a town of Lombardy, beautifully situated in the midst of vineyards, at the junction of the valley of St Giacomo and Val Bregaglia, 38 miles north-north-west of Bergamo. It is overlooked by the Rhetian Alps; and its position on the Splügen road secures it considerable traffic. Silk, cotton, and a coarse ware cut out of a soft stone found in the neighbourhood, are the chief manufactures. Pop. about 4000.

CHICA, a red feculent substance, valuable as a dye-stuff, giving an orange-red colour to cotton. It is obtained by boiling the leaves of a species of *Bignonia* (*B. Chica*), a native of the banks of the Cassiquiare and the Orinoco. The Indians use it for painting their bodies. The C. plant is a climber, with abruptly bipinnate leaves, smooth heart-shaped leaflets, and flowers in pendulous axillary panicles. See **BIGNONIACEÆ**.

CHICA, PITO, POSO, or MAIZE BEER, is a fermented liquor made from maize or Indian corn. It is much used in some parts of South America, and is made in a similar manner to ordinary beer; but the Indians sometimes prepare it by chewing instead of crushing the grains; and that which is so prepared (*Chicha mascada*, or chewed C.) is most highly esteemed by them. When they wish to make this liquor particularly strong and well flavoured, they have also a practice of pouring it into an earthen jar, which contains some pounds of beef; and having made the jar perfectly air-tight, they bury it several feet deep in the ground, where it is left for several years. On the birth of a child, it is their custom thus to bury a jar of C. to be drunk at the same child's marriage. C. has an agreeable flavour, and is very strong and intoxicating. A spirituous liquor is obtained from it by distillation; vinegar is also made from it.

CHICACOLE, a town of the district of Ganjam, in the presidency of Madras, being in lat. 18° 18' N., and long. 83° 58' E., and lying 415 miles to the south-west of Calcutta, and 435 to the north-east of Madras. It stands on the left or north bank of the Naglaudee, not far from the Bay of Bengal. It is a military station, and contains, besides its garrison, about 50,000 native inhabitants. The place has a reputation for its richly worked muslins.

CHICAGO (pronounced *She-kaw-go*), the principal city of Illinois, is situated on the south-western shore of Lake Michigan, at the mouth of the Chicago River, lat. 41° 52' N., long. 87° 35' W. The name is of Indian origin, and is first mentioned by Perrot, a Frenchman, by whom it was visited in 1671. In 1803, a stockade-fort was erected by the United States government near the mouth of the river, and named Fort Dearborn. When the war with Great Britain broke out in 1812, the government, apprehensive that a post among the Indians so far from the frontiers could not be successfully maintained, ordered the commander to abandon it. The Indians destroyed the fort, which was rebuilt in 1816.

C. was first settled in 1831, previous to which time it was a mere frontier-post; in 1832, it contained about a dozen families, besides the officers and soldiers in Fort Dearborn. The town was

CHICHEN—CHICK PEA.

organised by the election of a Board of Trustees, August 10, 1833. There were then 28 voters, of whom 7 are now living in the city. September 26 of the same year, a treaty was made for all their lands with the Pottawatomies, 7000 of the tribe being present, after which they were removed west of the Mississippi River. The first charter of the city was passed by the legislature March 4, 1837. The following table exhibits the rapid increase of Chicago. The estimated number of the population in 1835 was 1000, and the exact number, according to the census returns, was, in

1840,	4,470	1850,	28,260
1843,	7,580	1852,	38,733
1845,	12,080	1853,	60,652
1847,	18,859	1854,	65,472
1848,	20,035	1855,	83,509
1849,	23,047	1860,	estimated, 150,000

C., perhaps the most remarkable city in the world for its rapid growth, is built upon a plain sufficiently elevated to prevent inundation. The site of the city appears to the eye to be a perfectly flat prairie; the level of the engineer, however, shews that the height of the ground within the limits varies from 5 to 24 feet above the lake. Within the past four years, the elevation of the principal streets, also the buildings, have been raised from 4 to 10 feet, the object of this gigantic undertaking being to admit of a thorough system of sewerage. The Chicago River and its branches, which unite about three-quarters of a mile from the lake, separate the city into three divisions, connected by bridges, placed upon a turntable or pivot, so that little if any inconvenience is experienced in passing from one part of the city to another. The main stream, flowing directly west, is about 100 yards wide, and forms one of the best harbours on the lakes. Vessels ascend the river and its branches a distance of 4 miles from its mouth, thus affording nearly 18 miles of wharfage.

The Illinois and Michigan Canal, completed in 1848, connects the Chicago and Illinois rivers, thus affording communication between the lakes and Mississippi to the coal-fields of Illinois, and to the vast quarries of so-called Athens marble, regarded as the finest building-material in the country. It is found on the banks of the canal, about 20 miles from C.; is easily worked when first quarried, like the Caen stone; and, like it, becomes exceedingly hard when exposed.

The ten public schools of C.—some capable of holding 1000 children—afford the means of educating, free of charge, every child in the city. At the head of the system is the High School, the pupils of which are the graduates of the other ten. Here the sons and daughters of the poorest man may aspire to the highest honours in the classics and modern languages. There are also 54 private schools and seminaries, besides several universities, medical colleges, theological, literary, and scientific institutions located in Chicago.

Since 1854, C. has been the largest primary grain-dépot in the world—that is, a larger amount of grain is collected there directly from the producers than at any other point. Reducing flour to bushels, the total receipts of grain from January 1, 1860, to November 1, amounted to 33,266,409 bushels. The tonnage of the great chain of lakes, covering an area of nearly 100,000 square miles, of which C. is the emporium, is about 450,000 tons, valued at above £4,000,000.

More than 150 trains of cars arrive and depart daily to accommodate travel and commerce. In February 1852, there were 47 miles of railway completed, centering in C.; now, there are 4736 miles, and above 3000 miles to be completed during the next five years.

CHICHE'N, a town of Central America, in the north-east of the peninsula of Yucatan, which separates the Gulf of Mexico from the Caribbean Sea, 18 miles to the south-west of Valladolid. It is one of the principal towns of the state, and is worthy of notice chiefly for the remains of an ancient city, comprising a ruined temple 450 feet long, a pyramid with a base of 550 feet square, and a domed edifice ornamented with sculpture.

CHICHESTER, a municipal and parliamentary borough and episcopal city in Sussex, 17½ miles east-north-east of Portsmouth. It stands on a plain between an arm of the sea and the South Downs, which rise gently on the north. It is well built, and has wide streets. The two main streets cross at right angles, and meet in an elaborately worked eight-sided cross. Within the suburbs the city is surrounded by an ancient wall, 1½ mile in circuit, with some semicircular bastions, and now a promenade under the shade of elms. The cathedral, erected in the 12th and 13th centuries, on the site of a wooden one founded 1108, and burned 1114, measures 410 by 227 feet, with a spire 300 feet high. The aisles are double—a mode of construction to be seen nowhere else in Britain. The cathedral has a rich choir, and portraits of the English sovereigns from the Conquest to George I., and of the bishops down to the Reformation. The chief trade is in agricultural produce and live-stock. There are malting, brewing, and tanning establishments. Pop. 8662. C. returns two members to parliament. The harbour, 2 miles to the south-west of the city, is a deep inlet of the English Channel, of about 8 square miles; has several creeks and Thorney Isle; and is connected with C. by a canal. C. was the Roman *Regnum*, and has afforded Roman remains—as a mosaic pavement, coins, urns, and an inscription of the dedication of a temple to Neptune and Minerva. C. was taken and partly destroyed, in 491, by the South Saxons. It was soon after rebuilt by Cissa, their king, and called Cissan-caster, or Cissa's Camp. It was for some time the capital of the kingdom of Sussex. In 1642, the royalists of C. surrendered to the parliamentarians, after a siege of ten days.

CHICK PEA (*Cicer*), a genus of plants of the natural order *Leguminosæ*, sub-order *Papilionaceæ*,

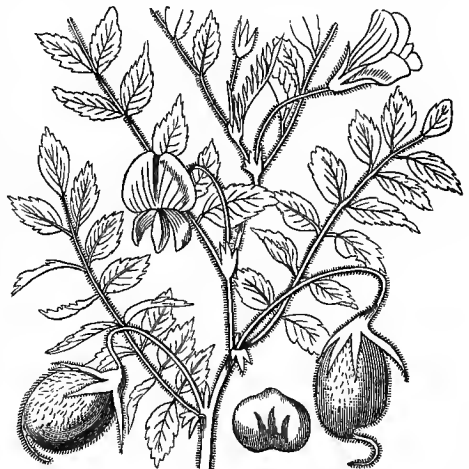

Chick Pea.

having pinnate leaves; solitary, axillary, stalked

flowers; and two-seeded pods, inflated like bladders. The common C. P. (*C. arvense*) grows wild in the cornfields of the countries around the Mediterranean Sea, and in many parts of the east. It is an annual, 1½—2 feet high, of a stiff upright habit, covered with glandular hairs. The seeds abound in farina, and have a slightly bitterish taste. They are about the size of common peas, curiously wrinkled, so that they have been thought to resemble a ram's (*arietis*) head. They are used as food, either boiled or roasted, and are the most common *parched pulse* of the East. They are an important article of French cookery. They have been in general use from the earliest times, and the plant is extensively cultivated in Egypt, Syria, India, the south of Europe, &c. Its cultivation extends as far north as the southern parts of Germany; but in the climate of Britain it is found too tender to be a profitable crop. It is the *Gram* of India, and the *Garvance* of the French, whence the English name *Caravances*. The herbage affords a nutritious food for cattle, and the seeds are one of the occasional substitutes for coffee. In great summer heats, drops exude from this plant, which, on drying, leave crystals of almost pure oxalic acid.

CHICKEN-POX, a contagious febrile disease, chiefly of children, and bearing some resemblance to a very mild form of small-pox (q. v.). C. is distinguished by an eruption of vesicles or blebs, which rarely become pustular or yellow, and leave only a very slight incrustation, which falls off in a few days, without any permanent mark or pit, as in small-pox. From its vesicular character, it has been called the *crystal pox*. It has been argued that C. is, in fact, only small-pox modified by previous vaccination; but this opinion, though maintained on good authority, is not generally received by medical men. It is a disease of little or no danger, the fever being often hardly perceptible, and never lasting long.

CHICKWEED (*Stellaria media*), one of the most common weeds of gardens and cultivated



Chickweed (*Stellaria media*):

a, branch with leaves and flowers, reduced; b, a flower; c, parts of fructification.

fields, is a species of **STITCHWORT** (q. v.). It is a native of most parts of Europe and of Asia, appearing during the colder months even on the plains of India; an annual, with a weak procumbent stem and ovate leaves, very variable; some of the smaller

varieties in dry sunny situations sometimes puzzling young botanists, from having only five or three instead of ten stamens; but always characterised by having the stem curiously marked with a line of hairs, which at each pair of leaves changes from one side to another, and in four changes completes the circuit of the stem. The leaves of C. afford a fine instance of the *sleep of plants*, closing up on the young shoots at night. C. is a good substitute for spinach or greens, although generally little regarded except as a troublesome weed, or gathered only by the poor to make poultices, for which it is very useful, or for feeding cage-birds, which are very fond both of its leaves and seeds. A number of species of a nearly allied genus, *Cerastium*, natives of Britain, also bear the name of C., or **MOUSE-EAR C.**, and the name is occasionally given to other plants, either botanically allied, or of somewhat similar appearance.

CHICLA'NA, a town of Andalusia, Spain, about 12 miles south-east of Cadiz. It is pleasantly situated on a plain between two hills, and its houses being all built of white stone, present a cheerful appearance. It has a splendid hospital. The manufactures are linen, earthenware, and brandy. Its mineral baths are much frequented by the inhabitants of Cadiz. Population variously estimated, but probably about 5000.

CHICORY, or **SUCCORY** (*Cichorium*), a genus of plants of the natural order *Compositae*, sub-order *Cichoraceae*, distinguished by bracts in two unequal rows, the outer always reflexed, the inner latterly becoming so, a nearly naked receptacle, obovate striated achenia, and a pappus of two rows of minute scales. The species are few in number, herbaceous plants, full of milky juice, natives chiefly of the warmer temperate regions of the eastern hemisphere. The common C. or **SUCCORY** (*C.*

Intybus) is a perennial plant, found wild in England and most parts of Europe, growing in waysides, borders of fields, &c. It has a long carrot-like root, externally of a dirty or brownish yellow colour, and white within. The stem rises to the height of 2—5 feet, branching, the leaves are *runcinate*, resembling those of the dandelion; the flowers sessile, axillary, in pairs, rather large, beautiful, generally blue, more rarely pink or white. C. is pretty extensively cultivated, both in England and on the continent of Europe, for its roots. It is also cultivated for feeding cattle with its leaves. The blanched leaves are sometimes used as a salad, and they are readily procured in winter by placing the roots in a box with a little earth in a cellar.—To this genus belongs also the **ENDIVE** (q. v.).



Chicory Root.

C. has been used as a substitute for coffee, or to mix with coffee, for at least 80 years. The roots are pulled up, washed, cut into small pieces, and dried on a kiln, which leaves a shrivelled mass not more than one-fourth the weight of the original root. It is then roasted in heated iron cylinders, which are kept revolving as in coffee-roasting, during which it loses about 25 to 30 per cent. of its weight, and evolves at the same time a disagreeable odour, resembling burned gingerbread. An improvement to the C. during roasting is the addition of 2 lbs. of lard or butter for every cwt. of C., which communicates to it much of the lustre and general appearance of coffee. It is then hand-picked, to remove chips of wood, stones, &c., and is reduced to powder, and sold separately as *C. powder* or *C. coffee*, or is added to ordinary ground-coffee, and is sold as a mixture. C. contains a good deal of sugar, but otherwise does not serve to supply the animal economy with any useful ingredient. It gives off a deep brown colour to water, when an infusion is made, and hence its main use in coffee. Some people dislike the taste of C., and when largely

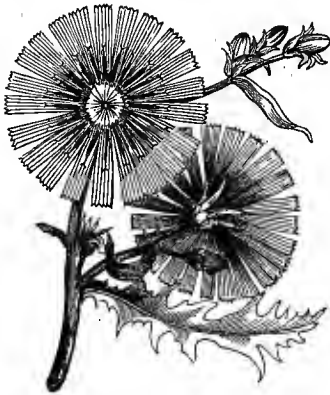

Chicory.

used, it has a tendency to produce diarrhoea; but many people prefer to use coffee mixed with C. owing partly to the taste it communicates, but mainly to the appearance of strength which it gives to the coffee. The C. is liable to adulteration; and roasted beans, pease, carrots, parsnips, mangold-wurzel, acorns, horse-chestnuts, biscuit, oak-bark tan, logwood and mahogany dust, and even the livers of horses and bullocks, are said to be employed in its adulteration.

CHIEF, in Heraldry, an ordinary formed by a horizontal line, and occupying the upper part of the escutcheon. Like the other honourable ordinaries, the C. ought properly to take up a third part of the shield; but when the other charges are numerous, the C. is frequently diminished in size.

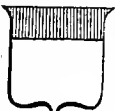

In Chief.

—Any object borne in the upper or chief part of the shield is said to be *in chief*, though the C. be not divided off from the rest of the field, as a separate portion.—*On a Chief*: Is when the object is represented on the C., divided off as above described.

CHIEF-JUSTICE. See JUSTICE COURTS.

CHIEF-M-SEE, a lake of Upper Bavaria, the largest in the country, lies about 42 miles south-east of Munich. It is situated at an elevation of more than 1500 feet above the sea; its length is 12 miles,

with a breadth of 9, and its greatest depth 480 feet. Its shape is irregular, and its coast much indented. It has three islands; the Achen and Prien flow into it, and its surplus water is discharged by the Alz into the Inn. The C. is famous for its fish; and a small steamer which plies on it, enables travellers to view its fine scenery.

CHIERI, a town of Piedmont, Northern Italy, situated on the slope of a hill 9 miles south-east of Turin. C. is an ancient place. By the later Romans it was called Carpa. The church of St Dominico, built in 1260, has some good paintings; and that of Santa Maria della Scala, built in 1405, is one of the largest Gothic structures in Piedmont. C. is one of the oldest manufacturing towns in Europe, its manufacture of fustians and cotton stuffs dating from 1422. Silk, cotton, and linen are still important manufactures. Pop. 13,000.

CHIENTI, an archiepiscopal city of Naples, capital of the province of Abruzzo Citra, is situated on a hill near the Pescara, about 100 miles north of Naples. It is a well-built and flourishing place, with some imposing public edifices, including a cathedral, lyceum, and theatre; and its agreeable situation has made it the residence of numerous wealthy families. The district around is fertile and well cultivated, and in the city, the cloth and silk manufactures afford employment for a considerable number of people. Pop. 16,000. C. is a very old place, being built on the site of the ancient *Teate* of the Romans, many of the remains of which are still visible. In the year 1524, St Gaetano founded here the order of the Theatines.

CHIGNECTO BAY, the more westerly of the two inlets at the head or north end of the Bay of Fundy, in British North America. It separates Nova Scotia from New Brunswick, is 30 miles long and 8 broad, and has an isthmus of only 14 miles in width between it and Northumberland Strait, in the Gulf of St Lawrence.

CHIGOE, or *JIGGER* (*Pulex*, or *Sarcopsylla penetrans*), a species of Flea (q. v.), rather smaller than the common flea, and with less powerful limbs, found in the West Indies and South America, where it is excessively troublesome, attacking any exposed part of the human body, and effecting a lodgment between the skin and flesh, often under the skin of the foot or the nails of the toes. At first, its

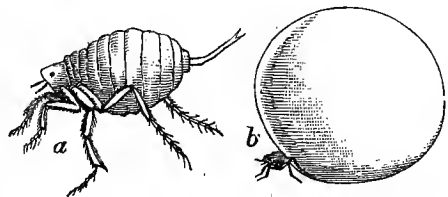

Chigoe (*Pulex penetrans*):
a, male; b, gravid female.

presence is indicated only by a slight itching or tingling; but an ulceration is likely soon to be the result, which is not only very painful, but even dangerous, when the female C. is allowed to remain and to deposit her numerous eggs. Before these are deposited, her abdomen becomes distended in an extraordinary manner, as a membranous bag, to the size of a pea. The ulcer speedily contains a great colony of chigoes. The negroes of the West Indies are very expert in extracting the C., which is also removed by washing with tobacco-juice. Rubbing with tobacco-leaves is also employed as a preventive of its attacks.

CHIH-LE, or **PECHIH-LE**, one of the northern provinces of China, and the most important of the 18, as being the centre of government, and containing Peking, the imperial capital, the residence of the emperor and court. Pop., in 1812, 27,990,871; area, 58,949 square miles.

CHIHUAHUA, a city of the Mexican confederation, with 12,000 inhabitants, and a considerable trade between Santa Fé, in New Mexico, and the United States. It is in lat. 28° 40' N., and long. 105° 33' W., and has a cathedral, convents, and an aqueduct 3 miles long, besides appropriate buildings, as the capital of the state of its own name. The territory in question, stretching in lat. from 27° to 32° N., and in long. from 104° to 108° 40' W., is divided from Texas, in the United States, by the Rio Bravo del Norte. It is a table-land, more remarkable for mineral resources than for agricultural productions. It abounds in nitre and other salts, and is rich in mines of gold and silver.

CHILBLAINS. See **CHAPPED HANDS.**

CHILD, SIR JOSIAH, an eminent London merchant, and one of the ablest of the earlier English writers on commerce and political economy, born in 1630, was the second son of Richard Child, a merchant of London. His principal work is entitled, *Brief Observations concerning Trade and the Interest of Money* (Lond. 1668, 4to); a 2d edition, much enlarged, entitled *A New Discourse of Trade*, was published in 1690. In this work he explains his plans for the relief and employment of the poor, including the substitution of districts or unions for parishes, and the compulsory transportation of paupers to the colonies. He was one of the directors, and for some time chairman of the East India Company, and is said to have written several tracts in defence of the trade to the East Indies, which were published anonymously. In 1678 he was created a baronet, and died in 1699.

CHILDERMAS, or **HOLY INNOCENTS' DAY** (28th December), is observed by the Church of Rome with masses for the children killed by Herod. It was considered unlucky to marry or to begin any work on this day. From Fenn's *Letters* (vol. i. p. 234) we learn that the coronation of King Edward IV. was put off till the Monday, because the preceding Sunday was Childermas Day. The learned Gregory says: 'It hath been a custom and yet is elsewhere, to whip up the children upon Innocents' Day morning, that the memory of Herod's murder might stick the closer, and in a moderate proportion to act over the cruelty again in kinde.' C. is also a holiday of the Church of England.

CHILD-KILLING. See **INFANTICIDE.**

CHILDREN, LEGAL CAPACITY OF. See **INFANT, MINOR, PUPIL, GUARDIAN, TUTOR, CURATOR.**

CHILD-STEALING. See **ABDUCTION.**

CHILI, a republic of Spanish origin, in South America, is the most southerly state on the west side of that continent. It lies wholly between the water-shed of the Andes and the shores of the Pacific, stretching coastwise from Bolivia to Patagonia, in lat. 25° 30'—43° 20' S., and in long. 69°—74° W., having an extreme breadth of about 1240 miles, and an average breadth of fully 120. Within these limits, however, lies the virtually independent Araucania (q. v.), comprising most of the mainland to the left of the Biobío; while the southern portion is confined chiefly to Chiloe (q. v.) and its archipelago. C. is divided into 13 provinces, of which, including certain outlying dependencies in Patagonia,

the aggregate area has officially been stated at 139,335 square miles; and the population, in 1858, at 1,558,319. The capital is Santiago, situated pretty nearly in the heart of the country, and connected with Valparaiso, the principal port, by a railway of 90 miles in length, and also by telegraphic wires. The other towns are on or near the ocean; and, to arrange them according to the relative amounts of their trade, they are Valparaiso, Copiapo and Caldera, Coquimbo, Talcahuano and Concepcion, Huasco, Constitution, and Valdivia. In 1857, the tons entered and cleared respectively at the whole of them were 876,668 and 837,459; having, in 1851, been only 686,185 and 647,793. In 1857, the imports amounted to 20,196,968 dollars, having been, in 1847, only 10,068,849; and the corresponding values of exports were 21,326,461 and 7,021,334 dollars. Of the exports, more than half go to Great Britain, the countries next in order being the United States, Peru, and France. Of the imports, again, of 1856, Great Britain supplied 35 per cent., the countries next in order being France, the United States, and Germany. The chief articles of export, taken in priority of value, are copper, wheat, and silver. In 1856, the ordinary revenue was 6,509,867 dollars, the customs alone yielding 4,157,299 dollars, and the next most productive heads being tobacco monopoly, commutation for tithes, and conveyance of real estates. During that same year, the ordinary expenditure was 5,589,346 dollars. The debt is stated at 8,279,375. The army, reckoning all descriptions of force, has been said to muster 50,000 men—the regular troops bearing but a small, and by no means uniform proportion to the whole. The navy, at this time (1860), consists of 2 sailing-vessels and 6 steamers, with an aggregate of 66 guns, and somewhat more than 600 men.

The Roman Catholic Church is established, and that practically to the exclusion of every other denomination. Of mixed marriages, the offspring, whether male or female, must be educated in the national faith. In its political constitution, C. appears to be the least democratic republic in the New World. The legislature is composed of two houses. The deputies sit for three years; and the senators are chosen for nine, retiring in thirds at the end of every third year. The voters for a deputy—to say nothing of the still more select voters for a senator—must possess either £100 in real property, or £200 in personal effects, or £20 of income; a pecuniary qualification which is exceptionally doubled for the wealthier localities of Valparaiso and Santiago. In 1848, attempts were made, but in vain, to abolish or modify these restrictions on the suffrage. Under this form of government, C. has maintained a degree of peace and prosperity utterly unknown to the other transatlantic commonwealths of kindred race. In this respect, however, the character of the people has doubtless co-operated with the tendency of the institutions. As contrasted with Spanish America in general, C. contains an unusually large proportion of European blood.

Immediately after the conquest of Peru, C. was seized by Almagro, a companion of Pizarro, subsequently becoming the seat of a captain-generalship, which held sway as far as Cape Horn. In 1810, commenced the war of independence, which, at the close of eight years, was decided against Spain by the victory of Maypo.

Geology.—The predominant rocks of C. are crystalline and metamorphic. They form the range of the Andes, except in those districts in which active volcanoes exist, where they are covered with recent volcanic rocks. They occupy also the whole of the level ground between the mountain-range and the

shores of the Pacific, with the exception of a narrow stretch of palaeozoic fossiliferous strata which run along the coast south from Santiago for a distance of 300 miles. The coast-line of C. is being continually altered from the elevation of the whole country to an extent of at least 1200 miles along the Pacific shores, produced by volcanic agency. In 1822, the coast was raised 4 feet at Quintero, and 3 feet at Valparaiso. Oysters and other mollusks were left dry, and perished, becoming offensive as they decomposed. The change of level was permanent, over an area of 100,000 square miles, nearly as large as the whole extent of Great Britain and Ireland. A similar extensive elevation was noticed in 1835 by Captain Fitzroy.

Physically, the continental portion of the republic—for its insular section will, in this respect, be noticed under the head of CHILOË—presents many singularities. Of all the maritime regions on the globe, it is perhaps the most isolated. On every side but the sea—and that sea very remote from the main thoroughfares of commerce—it is beset by difficulties of communication. With the lonely wilderness of Patagonia to the south, and the dreary desert of Atacama on the north, it is bounded on the east by a mountain-chain which, altogether impracticable in winter, can be crossed, even in summer, only by a few passes ranging between 12,450 feet and 14,370 in elevation. Moreover, this strip between the Andes and the Pacific is broken into plateaus in the interior, and valleys on the coast, by two longitudinal ranges, with numerous lateral spurs; while, throughout the length and breadth, the general level gradually descends, as well to the south as to the west. In point of mere temperature, so rugged a surface—covering fully 15° of latitude, and attaining an altitude of more than 4 miles within about 2° of longitude—must present nearly every possible variety. Through the reciprocal action of the Andes (q. v.) and the prevailing winds, the rain-fall graduates itself, with something of mathematical regularity, from the parching skies of the north to the drenching clouds of the south—a graduation which, disturbed merely by the melting of the mountain-snows, is, in a great measure, necessarily reflected in the condition and magnitude of the countless water-courses. Hence the rivers to the north of the Maypo, which enters the Pacific near latitude 34°, are but inconsiderable streams; while, further to the south, the Maule, the Biobio, and the Calacalla are all to some extent navigable.

From the cause last mentioned, different districts vary remarkably in their productions. To the north of the Coquimbo, about lat. 30°, is chiefly an arid waste, redeemed, however, from being valueless by its mines; and to the south of the Biobio, about lat. 37°, timber and pasturage divide the soil between them. The intermediate centre alone is fitted for agriculture, yielding, besides maize and hemp, European grains and fruits in abundance. Notwithstanding all the varieties and vicissitudes of climate, the country may claim to be, on the whole, extremely healthy. The manufactures are earthen-ware, copper-wares, linens, cordage, soap, leather, and brandy; and, in addition to the wheat and metals already specified, the exports, especially from the south, embrace tallow, hides, jerked beef, and live-stock. Besides the railway already mentioned between Valparaiso and Santiago, another of 54 miles in length runs from Caldera to Copiapo. There are also common roads; but they are neither numerous nor good. In fact, the want of highways and bridges is a serious obstacle to the progress of trade and cultivation. In the basin of the Lower Biobio, coal is plentiful.

CHILI, or CHILLI. See CAPSICUM.

CHILI NETTLE. See LOASACEÆ.

CHILI SALTPETRE is a commercial name applied to the nitrate of soda. See SODA, NITRATE.

CHILLIANWALLA, a village of the Punjab, being 5 miles from the left or east bank of the Jhelum, the most westerly of the five rivers which give name to the country. It is in lat. 32° 40' N., and long. 73° 39' E., being 85 miles to the north-west of Lahore. C. claims notice as the scene of Lord Gough's dearly won victory, over the Sikhs, of January 1849, and also as the site of an obelisk erected to the memory of those who fell in the two Sikh wars.

CHILLINGWORTH, WILLIAM, a famous theologian of the Church of England, was born at Oxford in 1602, and educated at Trinity College in that university, where the arguments of a Jesuit named Fisher induced him to become a Roman Catholic. He withdrew to Douay; but was induced by his godfather, Dr Laud, then Bishop of London, to re-examine the whole controversy between Catholics and Protestants, and in 1631, he returned to the bosom of the Anglican Church. Four years later, he published a work, entitled *The Religion of Protestants a Safe Way to Salvation*. It was exceedingly keen, ingenious, and conclusive in point of argument. C. was perhaps the ablest disputant of his age; and had there not been a certain fickleness and want of solidity about his intellect, and a nervous suspicion that all human reasoning might be vitiated by undiscovered fallacies, he might have produced a really great work. *The Religion of Protestants* acquired a wide popularity. C. was offered church preferment, which he at first refused—having certain scruples in regard to the subscription of the 39 Articles—but afterwards accepted. He became Chancellor of the Church of Sarum, and prebendary of Brixworth, in Northamptonshire. He was a strong royalist, and on the breaking out of the civil war, accompanied the king's forces. He died January 1644. The best edition of *The Religion of Protestants* appeared in 1742, with sermons, &c., and a life of the author, by Dr Birch.

CHILLON, a celebrated castle and fortress of Switzerland, in the canton of Vaud, 6 miles south-east of Vevey. It is situated at the east end of the Lake of Geneva, on an isolated rock, almost entirely surrounded by deep water, and is connected with the shore by a wooden bridge. The castle is said to have been built in 1238, by Amadeus IV. of Savoy, and it long served as a state prison. It is famous as the prison of Bonnivard, the prior of St Victor, who having, by his efforts to free the Genevese, rendered himself obnoxious to the Duke of Savoy, was carried off by emissaries of that potentate, and confined here for six years, at the end of which time the castle had to surrender to the Bernese and Genevese, when Bonnivard was liberated. C. has been immortalised by Byron's *Prisoner of Chillon*. The castle is now used as a magazine for military stores.

CHILOË, the insular province of Chili (q. v.), is an archipelago on the west side of South America, which takes its name from its principal island. It is separated from the rest of the republic, or rather from Patagonia, by the Gulf of Ancud, extending in S. lat. from 41° 40' to 43° 20', and in W. long. from 73° to 74°. The province—which, in 1858, numbered 65,743 inhabitants—contains, in addition to C. Proper, about 60 islets, of which about 30 are uninhabited. In the archipelago are two towns, both of them seaports of C. Proper—Castro, the ancient capital, on the east coast; and San Carlos, the modern seat of government, towards the

north-west extremity. The atmosphere, like that of the mainland opposite, is excessively moist; the westerly winds, more particularly in winter, bringing almost constant rains. The climate, however, is on the whole healthy. This fact is the more remarkable, inasmuch as C. Proper is one natural forest, measuring 100 miles by 40, with a partially cleared and cultivated margin on the sea. The chief products are wheat, barley, potatoes, apples, and strawberries; and cattle, sheep, and pigs are reared in considerable numbers. Agriculture, however, is in a very primitive state; and the staple food of many consists of mussels and oysters. The population, equally indolent and poor, differs from that of the rest of Chili in the great preponderance of aboriginal blood. Schools are numerous; but, from the ignorance of the teachers, education has not made satisfactory progress. The principal manufacture is a coarse woollen cloth, dyed blue. This archipelago was discovered by the Spaniards as late as 1558; and as it was the last integral portion of Spanish America to be colonised, so also was it the last to throw off the mother-country's yoke.

CHILOGNATHA AND CHILOPODA. See MYRIAPODA.

CHILTERN HILLS, the south part of the low chalk range which runs north-east, about 70 miles, from the north bend of the Thames, in Oxfordshire, through Bucks and the borders of Herts and Beds, and ends in Norfolk and Suffolk. In Oxford, Herts, and Beds, the C. H. are 15 to 20 miles broad, and the highest points are Wendover, 905 feet; and Whitehouse, 893.

CHILTERN HUNDREDS. In former times, the beech-forests which covered the Chiltern Hills, in Buckinghamshire, were infested with robbers, and in order to restrain them, and protect the peaceable inhabitants of the neighbourhood from their inroads, it was usual for the crown to appoint an officer, who was called the Steward of the Chiltern Hundreds. The office, which has long ceased to serve its primary, now serves a secondary purpose. A member of the House of Commons cannot resign his seat unless disqualified either by the acceptance of a place of honour and profit under the crown, or by some other cause. Now, the stewardship of the C. H. is held to be such a place, and it is consequently applied for by, and granted, in the general case as a matter of course, to any member who wishes to resign. As soon as it is obtained, it is again resigned, and is thus generally vacant when required for the purpose in question. When the C. H. are not vacant, however, the same purpose is served by the stewardship of the manors of East Hendred, Northhead, and Hempholme. As to the offices which are held to vacate seats, see ELECTRON. 'The practice of granting the Chiltern Hundreds for the purpose above described began only about the year 1750, and its strict legality has been doubted, on the ground that the stewardship is not an office of the kind requisite to vacate a seat. The gift of the Chiltern Hundreds lies with the Chancellor of the Exchequer, and there is at least one instance of its being refused. In 1842, after very awkward disclosures had been made before a committee of the House of Commons, as to corrupt compromises, which had been entered into for the purpose of avoiding investigation into gross bribery in the election to certain boroughs, of which Reading was one, the member for Reading applied for the stewardship of the Chiltern Hundreds, and was refused—the Chancellor of the Exchequer being of opinion that, by granting it, he would in some sort have made himself a party to

transactions which he did not approve, and of which the House of Commons had implied its condemnation.—*Standard Library of Political Knowledge*, p. 500.

CHIMÆ'RA, a genus of cartilaginous fishes, ranked by Cuvier with the Sturgeons (*Sturionidae*), but now generally regarded as the type of a distinct family, of which only two or three species are known. The gills have a single wide opening, as in the sturgeons; but the gill lid or *operculum* is merely rudimental, and concealed in the skin, whilst there is an approach to sharks in the structure of the gills. The only known species of C. is *C. monstrosa*,

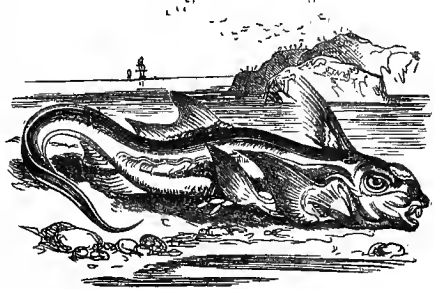

Chimæra Monstrosa.

occasionally found in the British seas, and more common in more northern latitudes. It is sometimes called the *King of the Herrings*. It pursues the shoals of herrings, and is consequently sometimes taken in herring-nets. It is seldom more than three feet long. Its general colour is silvery white, the upper parts mottled with brown. It produces very large leathery eggs.

CHIMÆ'RA, a mythical monster, described by Homer as having a lion's head, a goat's body, and the tail of a dragon. The rationalistic account of C. is, that it represented a mountain in Lycia whose top was the resort of lions, its middle of goats, and the marshy ground at the bottom of which abounded with serpents. In the same manner, Bellerophon's (q. v.) victory over the C. is explained by saying, that he first made his residence on this mountain. The myth seems, at all events, to have belonged to Asia Minor, as gigantic carvings of the C. on rocks are there found. It is usually represented as a lion, out of the back of which grows the head and neck of a goat.—C. is used figuratively to denote any monstrous or impossible conception, the unnatural birth of the fancy. It is frequently depicted on shields, as a heraldic charge.

CHIMA'PHILA. See WINTER-GREEN.

CHIMBORA'CO, a conical peak of the Andes, in Quito, 21,424 feet above the sea, but only about 12,000 above the level of its own tableland. It is capped with perpetual snow, and was long regarded as the loftiest mountain in the world. Latterly, however, it has been ascertained to be overtopped by some peaks, not merely of the Himalayas, but even of the central division of its own chain. Its lat. and long. are 1° 30' S., and 79° W. Though the summit of C. has never been reached, yet Humboldt ascended within 2138 feet of it, and Boussingault and Hall within 1729.

CHIMERE, 'the upper robe worn by a bishop, to which the lawn-sleeves are now generally attached.' Since the time of Queen Elizabeth, it has been of black satin, but previously it was of a scarlet

colour, like that worn by the bishops when assembled in convocation, and when the sovereign attends parliament.

CHIMES, music performed on bells in a church tower, either by the hands of a performer or by mechanism. The most perfect C. are to be found in Holland and Belgium.

CHIMNEY (Fr. *cheminée*, Lat. *caminus*). There seems reason to believe that the C., in its present sense of a funnel from the hearth or fireplace to the roof of the house, is a modern invention. In Greek houses it is supposed that there were no chimneys, and that the smoke escaped through a hole in the roof. What the arrangement was in houses in which there was an upper story, is not known; perhaps the smoke was conveyed by a short funnel through the side-wall of the house, which seems to have been the first form of C. invented in the middle ages. The Roman *caminus*, again, was not a C., but a sort of stove; and it has been a subject of much dispute, whether the Romans had any artificial mode of carrying off the smoke, or whether it was allowed to escape through the doors, windows, and openings in the roof. As the climate and the habits of the people both led to the houses of the ancients being very much more open than ours are, it is probable that the occasional fires which they had of wood or charcoal may have given them no great inconvenience. It is known, besides, that the rooms in Roman houses were frequently heated by means of hot air, which was brought in pipes from a furnace below. In England, there is no evidence of the use of C.-shafts earlier than the 12th century. In Rochester Castle (*circa* 1130), complete fireplaces appear; but the flues go only a few feet up in the thickness of the wall, and are then turned out through the wall to the back of the fireplace, the openings being small oblong holes. The earliest C.-shafts are circular, and of considerable height. Afterwards, chimneys are found in a great variety of forms. Previous to the 16th c., many of

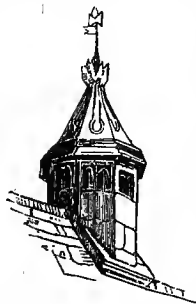

Tisbury, Wilts:

From Parker's Glossary.

them are short, and terminated by a spire or pinnacle, having apertures of various shapes. These apertures are sometimes in the pinnacle, sometimes under it, the smoke escaping as from some modern manufacturing C.-stalks which are built in the form of an Egyptian obelisk. Clustered C.-stalks do not appear until late in the 15th c., when they seem to have been introduced simultaneously with the use of brick for this purpose. Each of the earlier clustered chimneys consists of two flues which adhere to each other, and are not set separate,

as afterwards was the practice. Long after they were invented, and in use for other rooms, our ancestors did not generally introduce them into their halls, which, till the end of the 15th, or beginning of the 16th c., continued as formerly to be heated by a fire on an open hearth in the centre of the hall, the smoke escaping through an opening in the roof known by the name of *louvre*. In many of the older halls in which chimneys exist, they have evidently been inserted about this period.

The action of a C. depends upon the simple principle, that a column of heated air is lighter than a cooler column of equal height; when therefore a flue full of heated air communicates freely

by the lower part with the cooler air around it, the greater weight of the latter pushes the warm air upwards, and thus an ascending current is produced. Other conditions being equal, the draught of a C. will thus be proportional to its perpendicular height, and the difference between the temperature within and without it. The straighter and more perpendicular the C., the stronger will be the draught, because the friction of the ascending current will be less, and the cooling effect of a long or tortuous course will be saved. The maximum efficiency of a given C. is attained when all the air that passes up it enters by the bottom of the fire. In this case, its temperature is raised to the uttermost by passing through the whole of the fire, and the fire is at the same time urged to vivid combustion by the blast thus obtained. A powerful furnace may be constructed by connecting a suitable fireplace, capable of being closed all round excepting at the bottom, with a tall C.; and the amount of draught may be regulated by increasing or diminishing the aperture through which the air is admitted to the bottom of the fireplace, or by an adjustable opening above the fireplace, which will diminish the effective draught as its size is increased, or by a combination of both of these contrivances.

When the fireplace can be enclosed thus, there is little liability to descending currents or 'smoky chimneys,' as they are called, even when the C. is very short, or has a tortuous course. It is chiefly with open fireplaces that this defect occurs, and the means of prevention and cure is a subject of some interest and importance. As with most other evils, the prevention is far easier than the cure; for by properly constructing the C. in accordance with the principles above stated—by placing the opening of the C. as nearly over the fire, and contracting the open space above the fire, as much as possible—downward smoking may in most cases be easily prevented. When a C. is in the neighbourhood of a wall or building nearly as high as itself, or—what is still worse—higher, it is apt to smoke on account of the eddies and other complex currents in the air, caused by the interference which such an obstacle presents to the regular movement of the wind. In towns, such tortuous movements of the atmosphere are very common, and the contrivances for preventing the wind from blowing down the chimneys are very numerous, and often grotesque. Revolving cowls of various forms, but alike in having a nearly horizontal outlet, which is so turned by the wind that the mouth shall always present itself in the direction in which the wind is blowing, are the most common, and usually the most effectual. They are generally constructed of sheet-zinc, with an arrow, a flattened pigeon, or other device, as a vane, to determine the rotation of the cowl. The curing of smoky chimneys, in conjunction with the economising of fuel, was one of the favourite subjects of investigation of that very practical philosopher, Count Rumford. He says: 'Those who will take the trouble to consider the nature and properties of elastic fluids—of air, smoke, and vapour—and to examine the laws of their motions, and the necessary consequences of their being rarefied by heat, will perceive that it would be as much a miracle if smoke should not rise in a chimney—all hindrances to its ascent being removed—as that water should refuse to run in a siphon, or to descend a river. The whole mystery, therefore, of curing smoky chimneys is comprised in this simple direction: find out and remove those local hindrances which forcibly prevent the smoke from following its natural tendency to go up the chimney; or rather, to speak more accurately, which prevent its being forced up by the pressure of the heavier

air of the room.* He then goes on to speak of above 500 smoking chimneys that he has had under his hands, and which were supposed incurable; and states that he was never obliged, 'except in one single instance, to have recourse to any other method of cure than merely reducing the fireplace and throat of the chimney, or that part of it which lies immediately above the fireplace, to a proper form and just dimensions.'

The figures illustrate his method of proceeding. Fig. 1 is a side view of a vertical section of a C. and fireplace before alteration; fig. 2, the same after

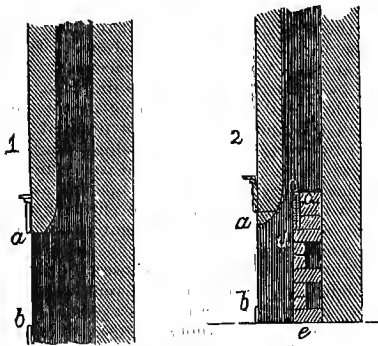

the reduction of the fireplace and throat of chimney. *ab* is the opening of the fireplace in both; this is lowered by the piece at *a*, fig. 2, and the depth diminished by the brickwork, *ce*, behind; *cd* is a movable tile, to make room for the C.-sweeper.

Figs. 3 and 4 are plans of the fireplace, looking down upon the hearth: the original opening of the fireplace is shewn by *ACDB*, fig. 3; the contracted opening, by *acdb*, in fig. 4. The dark space is filled with rubbish and faced with brickwork.

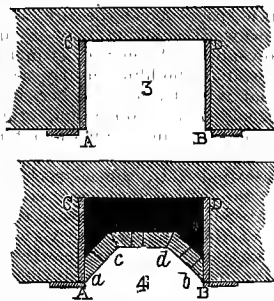

The slope of *ac* and *bd*, fig. 4, is better adapted for radiation into the room than the square opening of fig. 3: the fire being brought further forward, has also more heating effect; the space of the fireplace being smaller, the air within it will with a given sized fire become hotter, and therefore have more ascending power; while in the contracted throat widening downwards, and having its sides strongly heated, there is a rapid rush of heated air, which carries the smoke upwards, and resists the passage of temporary down-draughts. Most modern chimneys and fireplaces are now constructed in accordance with Count Rumford's suggestions. See GRATE.

One frequent cause of smoky chimneys is the want of sufficient inlet for air to the room. Sand-bags placed under doors, and other devices for preventing ventilation, may cause a well-constructed C. to smoke. Openings must exist somewhere, of sufficient capacity to supply the air which is to ascend the chimney. If the air enters the room on the same side as the fireplace, and sudden gusts of air pass across the front of the fireplace, a temporary

descending current is likely to be produced. The openings are best opposite the fire. For the methods of arranging and regulating such openings for the admission of air, see VENTILATION.

Tall factory-chimneys, usually built of brick, are very costly structures, many of them rivalling in height our loftiest cathedral spires. Their construction has been considerably economised by building from the inside, and thus saving the expensive scaffolding. Their walls are built very thick at the base, and gradually thinner upwards: recesses are left at regular intervals in the inside, and stout wooden or iron bars rest upon these to form a sort of temporary ladder for the workmen to ascend; the materials are hoisted by ropes and pulleys.

Sheet-iron chimneys are largely used in Belgium. They are much cheaper but less durable than brick, and are objectionable on account of their rapid cooling by the action of the external air.

CHIMPA'NZEE (*Troglodytes niger*), a species of ape; one of those which in form and structure exhibit the greatest resemblance to man. It is a native of the warmest parts of Africa; to which also the Gorilla (q. v.), a larger species of the same genus, belongs. The C. is sometimes called the Black Orang; but differs from the Orang (q. v.) (*Pithecus*) of Asia in the proportionally shorter arms, which, however, are much longer than those of man; in the possession of an additional dorsal vertebra, and an additional or thirteenth pair of ribs; and in other particulars, in some of which it more nearly resembles, and in others more widely differs, from the human species. In both, the difference from man is very wide in the general adaptation of the structure for movement on all-fours and for climbing and moving about among branches, rather than for erect walking, although the C. is able to move in an erect posture more easily than any other ape, usually, however, when so doing, holding its thighs with its hands; and still more in the form of the skull, and consequent aspect of the countenance, the facial angle being as low as 35° in the C. when it is measured without regard to the high bony ridges which project above the eyes; the jaws excessively projecting, and the outline of the face rather concave. There is also an important difference from the human species in the dentition; although the number of teeth of each kind is the same, the canine teeth of the apes is elongated, so as to pass each other, and corresponding intervals are provided for them in the opposite jaw. An interesting point of difference of the anatomy of the C. and Orang from that of man, is in the muscle which in man terminates in a single tendon, and concentrates its action on the great toe, terminating in the apes in three tendons, none of which is connected with the great toe or hinder thumb, but which flex the three middle toes; part of the adaptation of the foot for clasping as a hand. The great toe both of the C. and Orang is shorter than the other toes, and opposed to them as a thumb.

The C. does not seem to attain a height of quite four feet when in an erect posture. Its skin is thinly covered with long black hair in front; the hair is thicker on the head, back, and limbs. The ears are remarkably prominent, thin, and naked, not unlike human ears in shape. The nose appears as little more than a mere wrinkle of the skin. The thumb of the hand is small and weak, that of the foot comparatively large and powerful. In a wild state, the animal appears to be gregarious, but its habits are not well known. Truth and fable have been so mixed up in the accounts of it, that new information must be obtained from reliable

* *Essays: Political, Economical, and Philosophical*, by Benjamin Count Rumford, vol. i. p. 299.

sources, before even things not in themselves very improbable can be believed. In a state of confinement, it exhibits, at least when young, considerable



Chimpanzee.

gentleness and docility, and readily learns to imitate human actions, in eating with a spoon, drinking out of a glass, and the like; but its intelligence does not appear to be superior to that of many other monkeys, or indeed of many kinds of brutes. Its natural food consists chiefly of fruit and other vegetable substances; in confinement, it exhibits a great fondness for sweetmeats and for wine. The C. is impatient of cold, and the climate of Britain soon proves fatal to it.

CHINA. See CHINESE EMPIRE.

CHINA, or CHINA-WARE. See PORCELAIN.

CHINA BARK, a name of *Cinchona* (q. v.) Bark, often to be met in books, and in common use on the continent. It is derived, not from the empire of China, but from *Kina* or *Quina*, the Peruvian name of cinchona.

CHINA CLAY, or KA'OLIN. See CLAY.

CHINA GRASS, or CHINESE GRASS, the popular name of a fibre used in China for the manufacture of a beautiful fabric known as *Grass-cloth*. The name appears to have originated in the belief that the fibre was that of a grass; but this is not the case, it being chiefly obtained from *Behmeria* (q. v.) *nivea*, a plant allied to the nettle. Besides this and other species of the natural order *Urticaceæ*, other plants, as species of *Corchorus* (q. v.) and *Sida* (q. v.), are believed to yield fibres employed in the same manufacture. The fibres are said not to be spun after the European manner, but joined into long threads by twisting their ends together. Grass-cloth is now brought in considerable quantity to Europe, especially in the form of pocket-handkerchiefs. It has a fine glossy appearance and a peculiar transparency.

CHINA ROOT, the root, or rather the *rhizome* (root-stock) of *Smilax China*, a climbing shrubby plant, closely allied to sarsaparilla, and belonging to the same genus; a native of China, Cochin-China, and Japan. See SARSAPARILLA and SMILACEÆ. The stem is round and prickly, the leaves thin and roundish oblong; the rhizome tuberous and large; sub-astringent and diaphoretic. It is occasionally used in medicine, and is imported in a dry state into Europe; but it is also employed in the East as an article of food. It abounds in starch.

CHINCHILLA, a town of Spain, in the province of Albacete, 10 miles south-east of the city of that name. It is situated on an abrupt rocky hill, crowned by a castle, and is surrounded by walls. The town is in general well built, with good streets, and a fine parish church, containing some excellent works of art. It has manufactures of cloth, linen, leather, earthenware, and glass, and a trade in the agricultural produce of the district. Pop. 12,000.

CHINCHILLA (*Chinchilla*, *Eriomys*, or *Callomys*), a genus of South American quadrupeds, of the order *Rodentia*; the type of a family, *Chinchillidæ*, allied to *Cavies* (*Cavidae*), but differing from them in possessing clavicles. The general aspect is somewhat rabbit-like. There are several genera of *Chinchillidæ*, distinguished in part by the number of toes; the true chinchillas having four, with the rudiment of a fifth on the fore-feet, and four on the



Chinchilla.

hind-feet; whilst in the genus *Lagidium* or *Lagotis* there are four on each foot; and in *Lagostomus*, four on the fore-feet and three on the hind-feet. All the species of this family are gregarious; feed much on roots, for which their strong and sharp incisors are particularly adapted; and live either in holes, which they select for themselves in rocky districts, or in burrows, which they excavate. They are valued for their fur, particularly the CHINCHILLA of the Andes (*C. lanigera*), of which the fur constitutes an important article of commerce. Their numbers are said to be sensibly decreasing in consequence of the demand for the fur. The ancient Peruvians were accustomed to employ the wool of the C. for the manufacture of fine fabrics. Molina suggests, that it might easily and profitably be kept in a domesticated state.

CHINCHÓN, a town of Spain, in the province of Madrid, 25 miles south-south-east of the city of that name. It is pleasantly situated on a hill near the Tagus, and is well built, with wide, regular, and clean streets. Agriculture forms the chief occupation of the inhabitants, but leather, linen, and earthenware are manufactured to a small extent. Pop. 5400.

CHINDWARA, a town of Nagpore, in Hindustan, in lat. 22° 3' N., and long. 78° 58' E. It occupies a plateau amid the Deoghur Mountains, standing 2100 feet above the level of the sea. Its climate is consequently one of the most agreeable and salubrious in India, attracting many visitors in search of health or recreation.

CHINE, LA, a village of Lower or East Canada, on the south side of the island of Montreal, and about 7 miles to the west of the city of that name. Both the city and the village stand on the left bank of the St Lawrence, or rather, of a branch of the Ottawa; for here, and at least 10 or 12 miles further down, these united rivers keep their waters unmingled. As the intermediate portion of the





stream forms the Rapids of St Louis, the consequent interruption of the navigation naturally rendered La C. a turning-point between the maritime and the inland communications. Gradually, however, its importance in this respect has been diminished, if not extinguished, by works between it and Montreal—a canal, a railway, and even improvements in the rapids themselves.

CHINESE EMPIRE, a vast territory in Eastern Asia, comprehending five great divisions—viz, 1. Mantchuria (q. v.); 2. Mongolia (q. v.); 3. Turkestan (q. v.); 4. Tibet (q. v.); 5. China Proper, or the Eighteen Provinces (*Shih-pä-sang*), including the two large islands of Formosa and Haenan—the former being reckoned in the province of Fuh-keen, and the latter as a department of Kwang-tung.

China Proper occupies the eastern slope of the table-lands of Central Asia. In form it approaches to a square, and covers a surface eighteen times as large as Great Britain. It is inhabited by more than 360 millions of the human race, living under the same government, ruled by the same laws, speaking the same language, studying the same literature, possessing a greater homogeneity, a history extending over a longer period, and a more enduring national existence than any other people, whether of ancient or modern times; indeed, when we consider its high antiquity, its peculiar civilisation, its elaborate administrative machinery, its wondrous language, its philosophy and classic literature, its manufacturing industry and natural productions, giving rise to such a gigantic commerce with our own land, China is perhaps the most remarkable country in the world, and is worth a closer and more serious study than has yet been generally accorded to it. China Proper is included between 18° and 40° N. lat. (which takes in the island of Haenan), and 98°–124° E. long. Its coastline exceeds 2500 miles, and the land-frontier 4400 miles. A line running direct north and south would give a length of 1474 miles; and another at right angles to this, 1355 miles; but one drawn diagonally from its north-eastern extremity through Yun-nan would measure 1669 miles. The area of China Proper is usually given as 1,297,999 square miles; but Dr Williams considers that the entire dimensions of the 18 provinces, as the Chinese define them, cannot be much under 2,000,000 square miles. All these measurements, however, must be taken as mere approximations.

Physical Features.—China has a general slope from the mountains of Tibet to the shores of the Pacific. The two principal mountain-chains divide it into three longitudinal basins, drained by those great rivers for which China is famous. Within its provinces are found alluvial plains, fertile river-valleys, large populous towns, as well as thinly inhabited hilly and mountainous regions. To describe its surface more particularly, it may be viewed under its natural divisions of mountainous country, hilly country, and the Great Plain. The first comprehends more than half the region between the meridian 113° and Tibet. East of this meridian, and to the south of the Yang-tze-kiang river, is the hilly country, which includes the provinces of Fuh-keen, Keang-se, Kwang-tung, and a portion of Hu-nan and Hu-pih; while to the north-east stretches the Great Plain. This latter extends from the Great Wall to 30° N. lat.: a line drawn from King-chow in Hu-pih to Hwae-king on the Yellow River, may be considered its western limit; and the sea forms its boundary on the east. This vast and generally fertile tract has an area of 210,000 square miles, and supports a population of 177 millions.

From the mountains of Tibet two grand ranges stretch across China, having a general direction

from south-west to north-east. The more northerly of these—the Thsin-ling or Blue Mountains—are included between the parallels of 31° and 34°. The southern or Nan-ling chain is a spur of the Himalayas. Commencing in Yun-nan, it bounds Kwang-se, Kwang-tung, and Fuh-keen on the north, and passing through the province of Che-keang—where some of its peaks reach the height of 12,000 feet—enters the sea at Ning-po; thus forming a continuous barrier—penetrated only by a few steep passes, of which the Mei-kwan, or Mei Pass, is the best known—that separates the coast-land of South-eastern China from the rest of the country. This great chain throws off numerous spurs to the south and east, which, dipping into the sea, rise above it as a belt of rugged islands along the southern half of the Chinese sea-board. Of this belt, the Chusan Archipelago is the most northerly portion.

The magnificent *river-system* of China is represented by those noble twin streams, the Hoang-ho or Yellow River, and the Yang-tze-kiang, which, springing from the same water-shed, the eastern mountains of Tibet, are widely separated in their mid course, but enter the sea within 2° of each other. The former has its source in 35½° N. lat., and about 96° E. long.; and after a very tortuous course, empties itself into the ocean in lat. 34°.* It is a 'mighty, impracticable, turbid, furious stream' for the most part, and little adapted for Chinese navigation. But the river most beloved by the Chinese is the Yang-tze-kiang, or 'son of the ocean'—more correctly translated, 'the son that spreads'—which name is only applied to it by the natives below the commencement of the delta; for above that it is called simply Ta-kiang or Great River. The basin drained by it is estimated at 750,000 square miles. Of the other rivers that water the country, the Peiho in the north, and the Choo-keang in the south, are the most noteworthy.

The principal *lakes* of China are five in number—viz, the Tung-ting-hu, in 113° E. long, with a circumference of about 220 miles; the Poyang-hu, in 116° E. long., 90 miles in length by 20 in breadth; the Hung-tsin-hu, in Keang-su; the Tsau-hu, between Ngankin-fu and Nankin; and the Tai-hu, in 120° E. long. On these lakes, artificially constructed floating-islands, with houses, fields, and inhabitants, animals, and birds, are sometimes seen.

The *Grand Canal* has very greatly facilitated the internal navigation of the country. Until lately the great annual grain-fleet, with its 430,000 tons of rice for the use of the capital, passed from the south to the neighbourhood of Peking by this great water-way; thus avoiding the storms and pirates of the coast, but the alteration already mentioned in the course of the Hoang-ho, has rendered it comparatively useless. It connects Tien-tsin in Chih-le with Hang-chow in Che-keang; though the canal proper commences in Shan-tung, and its total length is about 650 miles.

Another world-famous structure is the *Great Wall*—called Wan-li-chang (myriad-mile-wall) by the Chinese—which was built by the first emperor of the Tsin dynasty about 220 B. C., as a protection against the Tartar tribes. It traverses the northern boundary of China, extending from 3½° E. to 15° W. of Peking, and is carried over the highest hills, through the deepest valleys, across rivers and every other natural obstacle. The length of this great barrier is, according to McCulloch, 1250 miles. Including a

* The Hoang-ho has recently altered its course, and now enters the sea in a somewhat higher latitude. Such changes, causing losses, and entailing expense, are not unusual; and hence this river has been called 'China's sorrow.'

parapet of 5 feet, the total height of the wall is 20 feet; thickness at the base, 25 feet; and at the top, 15 feet. Towers or bastions occur at intervals of about 100 yards. These are 40 feet square at the base, and 30 feet at the summit, which is 37 feet, and in some instances 48 or 50 feet, from the ground. Earth enclosed in brickwork forms the mass of the wall; but for more than half its length it is little else than a heap of gravel and rubbish.

Geology.—The high lands, where are the sources of the great rivers of China, consist of granitic and metamorphic rocks. These are continued round the south and south-east of the country, until they leave a huge basin, through which flow the Yang-tze-kiang and Hoang-ho, occupied by fossiliferous strata. The wild and rugged scenery of the larger portion of China is owing to the predominance of those crystalline and sub-crystalline rocks. The fossiliferous strata exhibit representatives of the various formations. The Palæozoic rocks are but sparingly developed in a narrow stripe which runs from near Pekin, in a south-westerly curve, to nearly the centre of the empire. Cretaceous rocks occur in the valley of the Yang-tze-kiang. Tertiary beds fill up the eastern portion of the immense basin; while extensive districts to the west of this region, extending to the crystalline rocks in the extreme west, are covered with modern detritus.

Though no active volcanoes are known to exist in the country, yet indications of volcanic action are not wanting. Salt and hot-water springs are found in Yun-nan, in lat. 25° 35'; and wells of petroleum in Shen-se, lat. 36° 40'. The most famous amongst the *minerals* of China is jade or the yu-stone, obtained chiefly in Yun-nan. Coal, limestone, and porcelain clays are abundant. Precious stones are said to be met with in some districts. In Yun-nan, gold is washed from the sands of the rivers, and in the same province silver-mines are worked; here, too, is obtained the celebrated pe-tung or white copper. All the commoner metals are likewise found in China. Near the city of Ning-po are extensive stone-quarries.

Vegetable Productions.—Our knowledge of the flora of China has been much advanced by the researches of Mr Fortune; and his works contain valuable notices of the geography, culture, and varieties of the tea-plant, and of the botany of the country generally. The tea-plant (*Thea viridis* and *Thea bohea*) is the most important vegetable production of China. See art. TEA. The tallow-tree (*Stillingia sebifera*), the *Dryandra cordata* or varnish-tree, the camphor-tree (*Laurus Camphora*), the Chinese pine (*Pinus Sinensis*), the Chinese banyan (*Ficus nitida*), the funeral cypress—introduced into this country by Mr Fortune—and the mulberry, are amongst the most important trees of China. The cocoa-nut and other palms flourish on the southern coast. Of the bamboo, which grows as far north as lat. 38°, there are 63 principal varieties; and it is said that the bamboos of China are more valuable than her mines, and, next to rice and silk, yield the greatest revenue. The various uses to which they are applied is truly astonishing; and, amongst others, the bamboo is famous as an instrument of punishment. The fruits of both the tropical and temperate zones—apples, grapes, pomegranates, mangoes, pine-apples, three species of orange, the lichi, &c.—are found in the country; and camellias, azaleas, and gardenias are natives of the 'Flowery Land.' The *nymphaea*, or water-lily, is greatly prized by the Chinese, both for ornament and in an economical point of view. *Agriculture* is held in higher estimation in China than, perhaps, any other country in the world. On the first day of each year, a

grand state-ceremony is performed in its honour. The emperor, accompanied by his great officers of state, repairs to the Sacred Field, and having offered sacrifices on an altar of earth, he traces a furrow with the plough, and his example is followed by princes and ministers. A like solemnity is celebrated by the governor of every province, who represents the emperor. The agricultural system of the Chinese is rude, but effective; and every inch of arable land is carefully cultivated. Spade-husbandry and irrigation are carried on to a great extent. The Chinese have a strong perception of the value of night-soil as a manure; for, whilst in this country thousands of pounds' worth are annually thrown into the Thames, in China it is everywhere saved, bears a high price, and is collected in a manner exceedingly offensive to European notions. In the northern provinces, the cereals are principally maize, barley, and wheat; but in the south, rice is raised in vast quantities, and forms the staple food of the people. Tobacco and the poppy are also raised in considerable quantities.

Animals.—Very little is really known of the zoology of China. Of the monkey-tribe the most remarkable is the Cochinchinese monkey. Some of the more ferocious of the carnivorous animals still linger in the jungles of Yun-nan, but are unknown in the cultivated districts. Wild cats are common in the forests of the south, and bears are still found in the hills of Shan-se. Of the ruminantia, there are the musk-deer (*Moschus moschiferus*), the moose-deer, and a few other species. The gold and silver pheasant, the argus pheasant, and other gallinaceous birds, hold a prominent place in the ornithology of China. Fly-catchers, thrushes, grackles, and goat-suckers have their representatives in China, and there are several species of crows, jays, and magpies. Water-fowl inhabit the lakes, rivers, and marshes. The larger reptiles are unknown; but tortoises and turtles abound on the coast, and lizards are plentiful in the south. The ichthyology of China is considered to be one of the richest in the world. Sharks, rays, sturgeons, and other cartilaginous fishes, are common on the coast; and the carp formerly was very plentiful in the lakes and rivers. The goldfish has been introduced into Europe from China. Of insects, the arachnidæ are large and numerous; indeed, a tree-spider is said to attack small birds. Locusts often commit extensive ravages. Silk-worms are highly valued, and reared in large numbers.

In a country of such vast extent—extending from 18° to 40° N. lat.—the *climate* must vary greatly. Indeed, as regards both climate and productions, China may be divided into three zones—the northern, the central, and the southern. The northern zone extends to the 35th parallel, and includes the fine provinces of Shang-tung, Chih-le, Shan-se, Shen-se, and Kan-su. It produces the grains, fruits, and animals of Northern Europe. Here the children are red-cheeked, and the extremes of heat and cold are great. In Chih-le, the winters are very severe; and at that season ice a foot thick renders the rivers unnavigable. The natural productions of this and the contiguous northern provinces are wheat, barley, oats, apples, the hazel-nut, and the potato; they are also rich in wood and minerals. The central zone, the richest portion of China, contains eight provinces—Sze-chuen, Kweichow, Hu-nan, Hu-pih, Keang-su—and is bounded by the 27th or 28th parallel; tea and silk are its characteristic products; the middle portion is the granary of China, and the eastern part is celebrated for its manufactures of silk and cotton. The southern

CHINESE EMPIRE.

zone embraces five provinces—Yun-nan, Kwang-tung, Kwang-se, Fuh-keen, and Che-keang. The exchange of its tropical productions for those of the northern zone is an important branch of the internal commerce of the country. Kwang-tung lies partly within the tropics; and the whole province is tropical, both in climate and productions. Its fruits are oranges, liches, mangoes, and bananas; rice is its staple grain, and it produces the ground-nut, the sweet potato, and the yam. The following table exhibits the situation, area, and population of the eighteen provinces into which China is divided for administrative purposes:

PROVINCES.	Population, Cens. of 1872	Square Miles.	Pop. per Square Mile.
<i>Northern Provinces—</i>			
Chi-hai	27,990,371	58,949	475
Shang-tung,	28,838,764	65,104	444
Shan-se,	14,004,210	56,268	253
Ho-nan,	23,037,171	65,104	420
<i>Eastern Provinces—</i>			
Keang-su,	37,848,501	44,500	850
Gen-hwuy,	34,188,059	48,461	705
Keang-se,	23,046,999	72,176	320
Che-keang,	26,256,784	39,150	671
Fuh-keen,	14,777,410	58,480	276
<i>Central Provinces—</i>			
Hu-pih,	27,370,098	70,450	389
Hu-nan,	18,652,507	74,820	251
<i>Southern Provinces—</i>			
Kwang-tung,	19,174,080	79,466	241
Kwang-se,	7,313,895	78,250	93
Yun-nan,	5,561,320	107,969	51
Kwei-chow,	5,288,219	64,554	82
<i>Western Provinces—</i>			
Shen-ai,	10,207,256	67,400	153
Kan-su,	15,193,125	86,608	175
Sze-chuen,	21,455,678	166,880	128
Totals,	360,379,897	1,298,079	277

It is evident from the above that the population is by no means equally distributed, and that it thins out very considerably towards the north-west and south-west; the central and maritime provinces are the most densely peopled.

Inhabitants.—Ethnologically, the Chinese belong to that variety of the human species distinguished by a Mongolian conformation of the head and face, and a monosyllabic language. See CHINESE LANGUAGE, WRITING, AND LITERATURE. A tawny or parchment-coloured skin, black hair, lank and coarse, a thin beard, oblique eyes, and high cheek-bones, are the principal characteristics of the race. The average height of the Chinaman is about equal to that of the European, though his muscular power is not so great; the women are disproportionately small, and have a broad upper face, low nose, and linear eyes. Of the general character of the Chinese, it is not easy to form a fair and impartial judgment; and those who have resided long in the country, and know them well, have arrived at very different conclusions. M. Huc asserts that they are 'destitute of religious feelings and beliefs,' 'sceptical and indifferent to everything that concerns the moral side of man,' 'their whole lives but materialism put in action;' but 'all this,' says Mr Meadows, 'is baseless calumny of the higher life of a great portion of the human race.' He admits, indeed, that these charges are true of the mass of the Chinese, just as they are true of the English, French, and Americans; but as amongst these there is a large amount of generosity and right feeling, and also 'a minority higher in nature, actuated by higher motives, aiming at higher aims,' so also, he maintains, is there amongst the Chinese a similar right feeling, and a like minority who live a higher life than the people generally. See HIOWEN-THSANG. As regards valour, their annals record 'deeds akin to the courage of antiquity;' they have no fear of death, commit suicide as the solution of a difficulty, and endure the most cruel tortures with a passive fortitude; but neither their arms nor disciplines enable them

to stand before European forces. The Chinese are, as a race, unwarlike, fond of peace and domestic order, capable of a high degree of organisation and local self-government, sober, industrious, practical, unimaginative, literary, and deeply imbued with the mercantile spirit. It is to be observed that the inhabitants of China Proper are essentially one people; the differences, except in dialect, being hardly more marked than between the Northumbrian peasant and the Cornish miner. The south-eastern Chinese—the people of Kwang-tung, Fuh-keen, and the south of Che-keang—are the most restless and enterprising in all the eighteen provinces, and may be regarded as the Anglo-Saxons of Asia. In the mountainous districts of the four south-eastern provinces of China, but principally in Kwang-se, are certain tribes who maintain a rude independence, wear a peculiar dress, and are descended from the aboriginal inhabitants of China. Of these, the Meaon-tze are the best known.

The *manners and customs* of the Chinese can only here be glanced at. The *worship of ancestors* is a remarkable and prominent feature in their social life, and is dictated by that principle of filial piety which forms the basis of Chinese society. The rich have in their houses a chamber—a kind of domestic sanctuary—dedicated to their forefathers. Tablets, representing the deceased persons, and inscribed with their names, are here carefully preserved; and at stated seasons, prostrations and ceremonies are performed before them according to the Book of Rites. All Chinese worship from time to time at the tombs of their parents. In everything that relates to death and sepulture, the customs of the Chinese are no less singular. They meet their last enemy with apparent unconcern; but whilst their future state troubles them little, they regard the quality of their coffins as of vital importance, and frequently provide them during their lifetime; indeed, a coffin is reckoned a most acceptable present, and is frequently given by children to their parents. 'To be happy on earth,' say the Chinese, 'one must be born in Su-chow, live in Canton, and die in Lianchau'—Su-chow being celebrated for the beauty of its women, Canton for its luxury, and Lianchau for furnishing the best wood for coffins. Yet death is never alluded to in direct terms, but indicated



Chinese Match-makers.

rather by periphrases, such as—the person 'exists no more,' 'he has saluted the age,' 'ascended to the sky,' &c. Banquets are offered to the dead, and pathetic speeches addressed to them. In China, marriage is universal, and within the reach of all;

but there is a strict separation of the sexes, and betrothal is undertaken by the parents or by professional match-makers. Minute ceremonial observances regulate every step, and frequently the bride and bridegroom see each other on the wedding-day for the first time. Women hold a very inferior position, and are little better than slaves. Polygamy is not recognised by law, but secondary wives are common, especially when the first proves barren. Infanticide, though regarded as a crime, is undoubtedly practised to some extent, as is proved by edicts issued against it; and parents possess almost unlimited authority over their children. The intercourse of the Chinese with each other, especially of the upper classes, is regulated by a tedious and elaborate etiquette; indeed, they are the slaves of custom, and everything is done by precedent. Many curious instances of Chinese politeness might be cited. The well-bred host presses many things on a visitor, which the latter must never dream of accepting. 'A Chinaman,' says Mr Oliphant, 'has wonderful command of feature; he generally looks most pleased when he has least reason to be so, and maintains an expression of imperturbable politeness and amiability, when he is secretly regretting devoutly that he cannot bastinate you to death.' The *Le-king*, or Book of Rites, regulates Chinese manners, and is one cause of their unchangeableness; for here they are stereotyped, and handed down from age to age. The ceremonial usages of China have been estimated at 3000; and one of the tribunals at Peking—the Board of Rites—is charged with their interpretation. Chinese cookery, in the use of made dishes, more nearly resembles the French than the English. Birds'-nests soup, sharks' fins, deer-sinews, and ducks' tongues, are amongst its delicacies. The wine, or weak spirit (*tsew*), more correctly speaking, used by the Chinese is made from rice; and from this, again, they distil a stronger spirit, the 'samshoo' of Canton. The former is drunk warm in minute cups at their meals; tea never appears during a repast, though it may be taken before or after. The Chinese have numerous *festivals*; and perhaps the most remarkable of these is that celebrated at the commencement of the new year, when unbounded festivity prevails. Preparatory to this, debts are settled, and the devout repair to the temples to gain the favour of the gods. The first day of the year may, in one sense, be reckoned the birthday of the whole people, for their ages are dated from it. Visiting is, at the same time, carried on to a great extent, whilst parents and teachers receive the prostrations and salutations of their children or pupils. The festival of the dragon-boats is held on the fifth day of the fifth month; and at the first full moon of the year, the feast of lanterns. In the manufacture of these the Chinese excel; and on the night of the festival, lanterns illuminate each door, wonderful in their variety of form and material.

In the matter of *dress*, the Chinaman exhibits his usual practical sense, and varies the material according to the season, from cotton-wadded or fur-lined coats to the lightest silk, gauze, or grass-cloth. On the approach of cold weather, he lights no fire in his dwelling, but puts on additional clothing until the desired temperature is attained. A tunic or kind of loose jacket fitting close round the neck, and a wide short trouser, are his principal garments. Shoes are made of silk or cotton, with thick felt soles. White is the colour of mourning. The Tartar tonsure and braided queue became general with the Manchou conquest of the country, since which 180 millions of men have the hair removed from their heads at short intervals; and

as no Chinaman is his own barber, a great number of this calling find employment. The Chinaman is very sparing in his ablutions, and appears to be afflicted with a strange hydrophobia; for cold water, either as a beverage or for washing his person, he holds in abomination. Long nails are fashionable. The costume of the women differs but little from that of the men, and their shoes are the most remarkable part of their toilet. A lady's shoe measures about $3\frac{1}{2}$ inches from the heel to the toe. The feet of the Tartar women are left as nature made them; but amongst the Chinese, all young girls of the better classes are crippled by a tyrant custom. In early infancy the feet are tightly bound, the four small toes being tucked under the sole, of which, after a time, they become a part, and the heel is brought forward. The process is at length complete; stumps have been substituted for the ordinary pedal extremities, and the Chinese lady totters on her goat's feet.

The principal *manufactures* of the Chinese are silk, cotton, linen, and pottery, for which latter they are especially celebrated. The finest porcelain is made in the province of Keang-se. The Chinese invented printing in the beginning of the 10th c., and in 932 A.D. a printed imperial edition of the sacred books was published. The skill of the Chinese in handicraft is astonishing. Their rich silks and satins, light gauzes, beautiful embroidery, elaborate engraving on wood and stone, delicate filigree-work in gold and silver, carvings on ivory, fine lacquered ware, antique vessels in bronze, and their brilliant colouring on the famous pith paper, command our admiration.

Of the grand modern discoveries in the *physical sciences* the Chinese are profoundly ignorant, and the study of nature is altogether neglected. The Chinaman objects to be wiser than his forefathers, but spends a lifetime in studying his classical literature and the sages of antiquity; and here is doubtless one great cause of the homogeneity of the race, and the stereotyped nature of the Chinese mind.

Of *animal physiology and medicine* the Chinese have very crude notions, as is shewn by their *scheme* of the human body, in which the heart is placed in the centre, with the other organs ranged round it, and their unphilosophical theory of the pulse, which plainly demonstrates that they are ignorant of the true circulation of the blood, and the vascular system in man; hence their practice of medicine must be empirical. Chinese physicians believe that man is composed of five elements; that so long as each maintains its due proportion, health is preserved; but should one gain the ascendancy, illness follows, and the equilibrium must be restored by proper remedies. Acupuncture is practised. The Chinese have had the opportunity of practically testing the superiority of Western medical science, by the establishment of English and American hospitals, the introduction of vaccination, and by the publication of popular treatises on Physiology and Practical Surgery, &c., by Dr Hobson, late of Canton. It is worthy of remark, that these books were eagerly sought after, and excited a deep interest amongst their *litterati*; indeed, the Physiology has been twice republished by persons holding high official situations at Canton, and in a preface to the Chinese edition, the publisher observes: 'Our science, indeed, cannot compete with that of the philanthropic author.'

Government.—In the centralised autocratic government of China, the emperor is absolute in the empire, the governor in the province, the magistrate in the district. The emperor claims no *hereditary* divine right, and is not always the eldest son of the

preceding monarch; the ablest son is nominated, but his right to the throne as the *Tien-tze*, or *Tien-tze*, 'son of heaven,' the *Fung-tien*, 'divinely appointed,' can only be established by good government, in accordance with the principles laid down in the national sacred books. If, on the contrary, he violates these principles, the people firmly believe that heaven signifies, by unmistakable signs, that their ruler is not its chosen representative. 'The rivers rise from their beds, the ground sullenly refuses its fruits, the plains tremble, the hills reel, and the typhoon rages over seas and coasts, all alike uttering a "Numbered, numbered, weighed and parted," that requires no interpretation, but is read in anxiety by the people, in dismay and terror by the prince,' who seeks by repentance, and a return to the true principles of the government, to avert his doom. The emperor is absolute as legislator and administrator; but he must legislate in accordance with the general principles acknowledged in the country. He also constitutes, in his own person, the highest criminal court. The Chinese possess a carefully digested code of laws, which is added to and modified from time to time by imperial edicts. Their penal code commenced 2000 years ago, and copies of it are sold at so cheap a rate as to be within reach of people of the humblest means. Death, which the Chinaman prefers to long confinement, is the penalty for a large number of offences, and in ordinary years about 10,000-criminals are executed. Several modes of torture are legal. The emperor is assisted in governing by two councils—1. *The Inner or Privy Council*, composed of six high officials, three of whom are Chinese and three Mantchus; also ten assistants. The four senior ministers exercise functions corresponding to those of an English prime-minister. 2. *The General or Strategical Council*, which closely resembles our cabinet; being composed of the most influential officers in the capital, who exercise high legislative and executive duties. The decisions of the emperor in council are regularly published in the *Pekin Gazette*. There are besides, in the capital, six *yamuns* or public offices, each charged with a distinct department of government; and over all is the Court of General Inspection, or the *Censorate*, as it is called by foreigners. The mandarins composing this are 'the eyes and ears of the emperor;' for it is their province to see that all officers of the government, provincial or metropolitan, are faithful in the discharge of their respective duties.

The *administrative machinery* of the Chinese is very perfect in its organisation, and demands an attentive consideration for the right understanding of the people and government. In each of the 18 provinces is an imperial delegate or governor, who, besides being at the head of the civil jurisdiction, is commander-in-chief, and possesses the power of life and death for certain capital offences. He is privileged to correspond with the cabinet-council and the emperor. Under the governor are the Superintendent of Provincial Finances, the Provincial Criminal Judge, and the Provincial Educational Examiner; each communicates with his especial board in Peking. The governor is also assisted by many other judicial and administrative officials. The governmental organisation of each province is complete in itself, but in a few instances two provinces—Kwang-tung and Kwang-se, for instance—form a vicerealty, over which a governor-general, in addition to the governors, exercises authority. Every province is again subdivided into districts, departments, and circuits. The average number of districts in a province is eighty, and each of these is about the size of an English county. A civil functionary, called sometimes the

district-magistrate, presides over this division, and is assisted by several subordinate officers. A group of districts—six is the average number for the whole 18 provinces—forms a department, and is ruled by a prefect, who resides in the *fu* or departmental city. Three departments, on an average, constitute a circuit, of which an intendant (*Taou-tae*) has the charge.

The several grades of mandarins, or Chinese government officials (Chinese name, *kuan-fu*), are distinguished chiefly by a different-coloured ball or button on the top of the cap. There are twelve orders of nobility confined to the imperial house and clan, and also five ancient orders of nobility open to the civil and military servants of the state. The normal government of China is less a despotism than a morally supported autocracy, and it is in principle paternal. What the father is to his family, that the governor, the prefect, and the magistrate are intended to be, each in his own sphere, to the people; whilst the emperor stands in the same relation to the myriad inhabitants of his vast dominions. In ordinary times, the Chinaman enjoys much practical freedom, and can travel through the country without passport, or follow any calling he likes.

The Chinese executive system is based on those noteworthy *competitive examinations*, which are intended to sift out from the millions of educated Chinese the best and ablest for the public service. The first examination takes place every three years in the capital of each department, when the lowest degree—that of bachelor—is conferred on a certain number of candidates from each district. Triennial examinations are held in the provincial capital, presided over by two examiners from Peking, at which sometimes as many as 10,000 bachelors present themselves, and compete for the degree of licentiate. Some 1200 obtain it, and these may attend the triennial metropolitan examination at Peking, when about 200 may hope for the coveted degree of doctor, which insures immediate preferment.

Mr Meadows, the most philosophical, perhaps, of our writers on China, and from whose works the foregoing sketch of the administrative system of the country has been chiefly derived, has entered very fully into what may be termed the *philosophy of Chinese government*, which he sums up in the following doctrines, and believes them to be deducible from the classic literature of the country, and the true causes of the wonderful duration of the Chinese empire. 1. That the nation must be governed by moral agency, in preference to physical force. 2. That the services of the wisest and ablest men in the nation are indispensable to its good government. 3. That the people have the right to depose a sovereign who, either from active wickedness or vicious indolence, gives cause to oppressive and tyrannical rule. And to these he adds an institution—the system of public-service competitive examinations. But, on the other hand, these examinations, by directing the attention of students solely to the ancient literature of the country, to the exclusion of the physical sciences and inductive philosophy, however efficient in producing that wonderful homogeneity for which the inhabitants of the Central Kingdom are famous, stunt and stereotype the national mind, which, like the dwarfed tree the Chinaman delights to raise in a flower-pot, or the feet of a Chinese girl, can never fully expand.

Education, as the high road to official employment, to rank, wealth, and influence, is eagerly sought by all classes. Literary proficiency commands everywhere respect and consideration, and primary instruction penetrates to the remotest

villages. Self-supporting day-schools are universal throughout the country, and the office of teacher is followed by a great number of the *literati*. Government provides state-examiners, but does not otherwise assist in the education of the people. The Chinese have a remarkable reverence for the written



Collectors of Paper Scraps.

character. Waste printed paper is collected from house to house and burned, to preserve it from profanation.

Army.—According to the *Pekin Gazette*, China has a prodigious army, but in reality nine-tenths figure only on paper. Each province is provided with a military force varying from 8000 to about 68,000 men. According to Mr Meadows, the average for each province is about 34,500 men, and 640 officers. The governor of a province is also commander-in-chief, and is assisted by a general-in-chief, as well as lieutenants and majors general. The Chinese and Tartar troops form two important divisions of the army. The Tartar garrisons are indeed the real strength of the Mantchu emperor. That at Peking is 150,000 strong; and 18 others, averaging each about 3000 men, are dotted about the provinces, forming, with their wives and children, military colonies. These troops, which are armed with good two-edged swords, and serviceable matchlocks, or the national bow, have alone been able to stand against the victorious Tae-ping rebels, and turn them from the capital. It is said, indeed, that Tartars, under their general, Sang-ko-lin-sin, composed the force that repulsed Admiral Hope's attack on the Taku Forts, June 25, 1859. The Chinese soldier is, or should be, provided with a shield and helmet, two swords, bow and arrows, matchlock and spear; in time of peace, he may hire himself out in various capacities. He is supposed to receive three taels a month (the tael being equal to 6s. or 7s.), but the greater part of his pay is pocketed by some greedy official. The Tartar infantry-soldier receives four taels a month, and the trooper four and a half. The Marquis de Moges (see Baron Gros's Embassy) thinks that 'two regiments of chasseurs and two regiments of Zouaves would suffice to conquer China.' 'There is not,' he says, 'a corps in the empire that could stand fast under a bayonet charge. The sight of a body of men marching coolly and resolutely up to them, is so alien to their nature, so utterly incomprehensible and terrible, that all courage deserts them, and it is ten to one if they do not immediately take to their heels.'

Navy.—The imperial navy is divided into river and sea-going vessels. The former amount, it is said, to 1036 ships; the latter, to 918—with an aggregate number of 107,921 sailors. This force, however,

is insufficient to extirpate or even keep in check the pirates who infest the whole coast of China, and the expedient is sometimes resorted to of promoting a pirate chief to some high civil employment. If ever Chinese piracy be put down, it will be by European cruisers.

Religion.—The Chinese, remarkable in so many ways, exhibit, in the matter of religion, their usual eccentricity. Three forms of belief—the Confucian, the Buddhist, and the Taouist—may be considered the national religions, as they are believed in, more or less, by the great mass of the people. Of these, the Confucian and the Taouist are indigenous, but Buddhism was introduced from India. A struggle for ascendancy was long maintained between these religions, but has now entirely ceased; indeed, it is no unusual thing for all three to be professed by the same person, and as they supplement each other, this is not altogether inconsistent. Confucianism is the basis of the social life and political system of the Chinese. It has been professed by all their greatest men, and is still the sole belief of the educated classes. It is, however, less a religion than a philosophy, and does not pretend to treat of spiritual things; hence room was left for other creeds to supply its deficiencies in this respect. The questions to which Confucius replied were: 'How shall I do my duty to my neighbour? How can I best discharge the duty of a virtuous citizen?' Funereal temples are erected to Confucius, and though his image is not used as an idol, his tablet is worshipped, and sacrifices of oxen and sheep are offered before it at the vernal and autumnal equinoxes. For an account of Confucius's philosophy, see CONFUCIUS.

Buddhism in China, though extending over the whole country, and influencing more or less the mass of the people, is fast losing its hold on them, and has very little of the power and authority it once possessed. Its edifices are going to decay, and no new ones rise upon their ruins. Its priests are illiterate, and together with their religion, are held in contempt by the philosophic Chinaman. Aged people and women are now its chief devotees. The accompanying sketch of the begging-monk (taken, as well as the other cuts, from Cobbold's *Pictures of the Chinese by Themselves*) is characteristic. He wears a loose yellow robe and large stockings; at his back is a wallet in which to receive the contributions of the faithful; and he gives notice of his approach by striking his *muh-yu*, as represented in the illustration. The northern form of Buddhism, which differs considerably from that of Ceylon and the Indo-Chinese Peninsula, prevails in China. Its sacred books, in common with those of Nepal and Tibet, are written in Sanscrit, or are translations from that language. Amongst other additions to the creed are the Western Paradise and the Goddess of Mercy.

Taouism has not more hold than Buddhism on the literate Chinese. Its priests are generally ignorant men, few of them teaching or understanding the real principles of their faith. They practise a mystic alchemy, prepare spells and incantations, and, like modern spiritualists, hold intercourse with the



Chinese Buddhist Monk.

dead. When all other remedies have failed with a sick person, the Taoist priests are sometimes



Chinese Taoist Priest exorcising.

sent for to exorcise the evil spirit that is supposed to afflict the patient; and they chant prayers from their mystic ritual, amid the din of gongs, drums, flutes, &c. These mystics worship certain stars, which are supposed to influence human life, and also genii, devils, and inferior spirits. They live in temples with their families, and are known by their slate-coloured robes. For a fuller account of Taoism and its doctrines and founder, see LAO-TSE.

Besides these three religions, which alone affect the bulk of the people, there is a *ritual state worship*, which regards the emperor and court alone—a kind of philosophic pantheism, an adoration of certain natural objects; but it is a mere ceremonial, and associated with no theological doctrines. Three classes of objects are distinguished, to which the great, medium, and lesser sacrifices are offered. The first class includes the heaven and the earth. Equal to these, and likewise restricted to the worship of the emperor, is the great Temple of Imperial Ancestors. The medium sacrifices are offered to the sun and moon, the gods of the land and grain, genii, and sages. In the third class are reckoned certain natural phenomena, as well as deceased statesmen and scholars. The emperor appears to acknowledge a Supreme Being as king of kings, the rewarder of virtue and the punisher of vice; but still, Chinese philosophy, as fixed by Chu-tze, is atheistical, and deduces 'the development of the universe from one unintelligent and will-less principle.' Hence all educated Chinese are atheists, at least theoretically, as will be found by arguing with them; but when they speak of human affairs generally, and their own particular lot in life, they exhibit a belief in *Teen* as a supreme, intelligent, rewarding, and punishing power.

Between the followers of the three national religions, there is not only a total absence of persecution and bitter feeling, but a very great indifference as to which of them a man may belong. It arises probably from religious apathy; yet still it is preferable to the fanatical zeal and cut-throat earnestness of the Moslem. Amongst the politer classes, when strangers meet, the question is asked: 'To what sublime religion do you belong?' and each one pronounces a eulogium, not on his own religion, but on that professed by the others, and concludes with the oft-repeated formula: 'Religions are many; reason is one; we are all brothers.' The government is equally tolerant of religious diversity, except where a political design is suspected.

Temples belonging to the three religions are very numerous. Those dedicated to Confucius are

funereal in character. The Buddhist temples are crowded with images, and Buddha is represented expounding his doctrine to attentive listeners. The many-storied tower takes the place of the bell-shaped dagoba or relic-shrine of other Buddhist countries.

History and British Intercourse.—The early annals of China, like those of most other countries, belong rather to mythology than to history. Beginning with Pan-ku, the first of all beings, the country was ruled over first by gods, and then god-descended personages, who revealed to men the essential arts of life. Of those mythical rulers the most famous is Fo-hi. The historical period may be said to commence with the Hia period or dynasty, begun by Yu the Great about 2200 B. C., although a great infusion of the fabulous still continues. Some date the real history of China from the Tchou or Chow dynasty, which began with Wu-wang about 1100 B. C. It was during the reign of Ling-wang (571—544), one of this dynasty, that Confucius was born. China would seem during this period to have been divided into a number of independent states. The kings of Tsin gradually gained the ascendancy, and at last one of them reduced the other states to subjection (247 B. C.), and assumed the title of Hoang, or emperor. It is from the Tsin dynasty that the country has taken its name, Tsina or China. This first emperor finished the Great Wall (see above), as a protection against the Tartars, who had all along, under the name of Hiong-nu (Huns), been a source of danger and annoyance to the richer and more pacific Chinese. We cannot enumerate the various dynasties that followed, nor the frequent divisions and reunions of the empire, varied by incursions and partial subjugations by the troublesome Tartars. At last, the Mongols or Western Tartars, being called in to aid the Chinese (1209), became finally (see KUBLAI KHAN) masters of the whole country (1279), and reigned over it till 1368, when they were expelled by the Chinese, and the Ming native dynasty succeeded, which lasted 276 years, and fell at length through its own misgovernment. A general of the last Ming emperor, who was employed in keeping the Mantchus (q. v.) in check, made peace with them, and obtained their assistance against the native usurper who had deposed his sovereign. The Mantchus established themselves in Pekin (1644), and finally, after a seven-years' struggle, acquired the sovereignty of the whole empire. Many of the conquering race now filled the highest offices of state, and owed their position to birth alone. In this and other ways, the Mantchus have violated the fundamental principles of Chinese government; tyranny and corruption are rife amongst those in authority; the prestige of the Tartar troops has been destroyed by contests with European forces; disaffection prevails amongst the people, and Mantchu power seems fast drawing to an end. More than one powerful emperor of the race has ably conducted the government of the country; but the present monarch, Hien Fung (i. e., perfect bliss), who was born in 1831, and succeeded Tao Kwang in 1850, is said to pass his time in a state of drunken imbecility.

Of recent events in Chinese history, the most remarkable is the rise and progress of the Tae-ping rebels. Their famous leader, Hung-sew-tseuen, was a man of humble origin, and an unsuccessful candidate for government employment. Some Christian tracts led him to renounce idolatry, and he founded a society of God-worshippers, which, in the autumn of 1850, was brought into collision with the imperial authorities, and immediately assumed a political character. Hung persuaded himself and his followers that he had received a divine commission

to uproot idolatry, extirpate the Tartar intruders in the country, and establish the new native dynasty of Tae-ping, or Universal Peace. He assumed the title of Heavenly or Divine Prince (Tae-ping-wang, sometimes called Tien-wang), and bestowed the titles of Eastern Prince, Western Prince, Southern Prince, Northern Prince, and Assistant Prince on five of his chosen leaders.* The fanatical principle of divine revelations and other extravagances followed. The course of this religio-political rebellion, the victorious march of the Tae-ping army from Kwang-se to Nankin in 1850—1853, and its subsequent career, cannot here be traced. Su-chow, and the great commercial mart of Hang-chow, have lately fallen into the hands of the rebels.†

In early times, the Chinese do not appear to have been opposed to intercourse with foreigners; but the conduct of the Spaniards and Portuguese between 1520 and 1570 excited their hostility. The Manchou government restricted British trade and intercourse to Canton, where it was carried on through the medium of the *hong* merchants on the one side, and the East India Company on the other. Differences arose, however, from time to time between these two commercial bodies, occasioned chiefly by the exactions of the mandarins on foreign trade. With a view to a better understanding, the British government despatched to Peking an embassy under Lord Macartney in 1792, and another under Lord Amherst in 1816. On the 22d April 1834, the monopoly of the East India Company ceased, and British imperial officers were appointed to carry out the new judicial and fiscal arrangements. Constant dissensions between these and the mandarins continued till the end of the year 1839, when the latter, under pretence of stopping the opium-trade, committed acts of open hostility. A war broke out the following year, at the commencement of which Chinese officials talked of invading England overland, by way of Russia. The imperial government was, however, sufficiently humbled by the middle of the year 1842, and on the 29th August, a treaty of peace was signed before Nankin, by which the ports of Amoy, Fu-chow, Ning-po, and Shang-hae were, in addition to Canton, thrown open to foreign trade. The other most important articles of the treaty provided that the island of Hong-kong should be ceded in perpetuity to her Britannic Majesty, her heirs and successors, and that the emperor of

China should pay 21,000 000 dollars towards the expenses of the war.

With five free ports, British trade with China soon assumed gigantic proportions; and though the Chinese evaded the treaty whenever practicable, no important event occurred to interrupt commercial intercourse till 8th October 1856, when the authorities at Canton seized the crew of the *lorcha Arrow*, a vessel registered at Hong-kong, and entitled, it was considered, to British protection. Under pressure from the British forces at hand, the imperial commissioner, Yeh, delivered up the men, but refused all apology. Yeh continuing obstinate, Canton was stormed (December 28, 1857) by the allied French and English forces, and the Chinese imperial commissioner captured (January 5, 1858). The government of the city was still carried on by Chinese officials, but under the authority of the plenipotentiaries and commander-in-chief. The former now proceeded to the north of China, to put themselves in more direct communication with the imperial government, which still continued obstinate. The forts at the mouth of the Peiho were taken (May 20, 1858), and at length an important treaty was signed at Tien-tsin, June 26, 1858, which stipulates that the queen of Great Britain may (Art. ii.) appoint diplomatic agents to the court of Peking, who (Art. iii.) shall be allowed to reside at the capital, where also her Majesty may acquire a building site. The Christian religion (Art. viii.) shall be protected by the Chinese authorities. British subjects (Art. ix.) shall be allowed to travel for pleasure or business to all parts of the interior, under passports issued by their consul. British merchant-ships shall trade (Art. x.) upon the Great River (Yang-tze); but as its lower valley is disturbed by outlaws, no port except Chin-keang shall be opened for the present. Chin-keang to be opened in a year from the date of the signing of the treaty. In addition to the cities opened by the treaty of Nankin (*see ante*), it is agreed (Art. xi.) that British subjects may frequent the cities and ports of New-chwang, Tang-chow, Tai-wan (Formosa), Chan-chow, and Kiung-chow (Haenan), with right of residence, building, &c.

By this treaty, the vexed question of transit-dues is settled, it being agreed that the British merchant may purchase at the rate of $2\frac{1}{2}$ per cent. *ad valorem*, in the case of imports at the port of entry; and in the case of exports, he may purchase a certificate enabling him to pass his goods, duty-free, to the port of shipment. By a separate clause, the Chinese government agreed to pay two million taels (about £650,000), as indemnity for losses sustained by British subjects at Canton, and a like sum towards the expenses of the war.

The repulse on the Peiho (June 1859), by a Tartar force concealed in the Taku forts, of the expedition forming the escort of the British and French ambassadors, who were on their way to Peking, to ratify with the emperor of China the treaty of Tien-tsin, has entailed another costly demonstration in the Chinese waters. The Taku forts were captured by the allied English and French forces, August 21, 1860, and by the last accounts that have reached us (December 1860), the troops had taken possession of Peking.

Commerce.—The rivers and numberless canals of China are covered with vessels of all sizes, employed in the internal commerce of the country, which consists chiefly in the exchange of the various products of the several provinces. The Chinese are devoted to traffic, and the Middle Kingdom is throughout its length and breadth a perpetual fair. *British trade* with China has from small beginnings assumed great importance. The annual value of

* The kings are now said to be eleven in number.

† The accounts given of the character of this movement are so conflicting, that it is difficult to form any judgment of it. An important communication from the Rev. J. L. Holmes, who visited Nankin, the Tae-ping capital, in August of the present year (1860), appeared in the *North China Herald* of September 1, 1860. He went predisposed to receive a favourable impression, but came away with his views greatly changed. Space will only allow us to give a few of the most noteworthy statements. 1. They speak of the wife of the Heavenly Father, whom they call Tien-ma (Heavenly Mother), and of the wife of Jesus, whom they call Tien-sau (Heavenly Sister-in-law); also the Senior Western King has married a sister of Jesus, the daughter of the Heavenly Father, and is hence called Te Sue (Supreme Son-in-law). 2. They hold that Tien-wang is the Son of God as really, and in the same manner, that Jesus is, and they worship him as such. The son of the chief is likewise a member of the divine family. He is the adopted son of Jesus, and is appointed to be the head of all nations. 3. Polygamy is another dark feature of their system. The Tien-wang has married about 30 wives, and has in his harem about 100 women. The other kings are limited to 30. 4. They have a new revelation, which is their criterion of truth, and are quite competent to instruct us. In fact, they have in their hands a divine decree, to which we are to submit.

CHINESE HEMP—CHINESE LANGUAGE, WRITING, AND LITERATURE.

the direct trade between Great Britain and China is about £12,000,000; but including India, it amounted in 1857 to £22,122,469. This, however, is nothing to what it will be when the treaty of Tien-tsin shall be fully carried out, and Northern China is accessible to our ships. Tea and silk are the great staple imports from China into Great Britain. The following commercial returns are taken from the *London and China Telegraph*:

Year.	Value of the Exports to China.	Value of the Imports from China.
1849	£1,537,100	\$6,170,672
1850	1,674,146	
1851	2,161,268	7,971,491
1852	2,508,599	7,712,771
1853	1,749,587	8,255,215
1854	1,000,716	9,125,040
1855	1,277,944	8,746,590
1856	2,218,128	8,421,648
1857	2,449,982	11,448,639
1858	2,876,447	7,048,000

INDIA TRADE WITH CHINA.

Year.	EXPORTS.				Silk, Drugs, & Sundries. Value.
	Opium. Value.	Cotton. Value.	Other Articles.	Total.	
1849	\$5,245,719	\$1,013,512	\$167,059	\$5,596,290	\$331,361
1850	5,543,588	741,504	116,754	8,401,846	809,801
1851	5,074,078	1,160,364	118,093	8,252,535	989,869
1852	8,082,307	2,291,926	148,784	8,523,017	924,159
1853	6,470,916	1,026,444	122,959	7,890,219	866,043
1854	5,802,489	808,570	98,695	6,704,784	810,887
1855	5,684,978	639,143	121,013	6,445,134	915,049
1856	5,592,532	810,628	189,798	6,592,953	787,717
1857	6,505,686	715,552	347,546	7,568,884	599,672
1858	8,241,082	892,493	732,312	8,866,887	915,858

There is no *coinage* in China except the copper *taeh*, or 'cash,' which is of less value than the tenth of a penny; and all but the most trifling payments are made by a certain weight of silver or in foreign money. Chinese accounts are kept in taels, mace, candareens, and cash. A tael is worth 5s. 6½d., British currency.

The following works (which have been used as authorities in the preparation of this article) may be consulted for further information on China. Meadows's *Chinese and their Rebellions* (Lond. 1856); Davis's (Sir J. F.) *China: a General Description of that Empire* (Lond. 1857); Davis's *China during the War and since the Peace* (Lond. 1852); Williams's *Middle Kingdom* (New York and Lond. 1848); Oliphant's *Narrative of the Earl of Elgin's Mission to China and Japan, in the years 1857, 1858, and 1859* (Edin. 1859); Marquis de Moges's *Recollections of Baron Gros's Embassy to China and Japan in 1857 and 1858* (Lond. 1860); Huc's *Chinese Empire* (Lond. 1858); Cooke's *China in 1857 and 1858*; Fortune's *Three Years' Wanderings in China* (Lond. 1847); Fortune's *Visit to the Tea Districts of China* (Lond. 1852); Edkin's *Religious Condition of the Chinese* (Lond. 1858); Cobbold's *Pictures of the Chinese by Themselves* (Lond. 1859); *Twelve Years in China, by a British Resident* (Edin. 1860).

CHINESE HEMP. See CORCHORUS.

CHINESE INK. See INDIAN INK.

CHINESE LANGUAGE, WRITING, AND LITERATURE. The Chinese language belongs to those Asiatic languages commonly called monosyllabic, because each word is uttered by a single movement of the organs of speech, and expresses in itself a complete idea or thing. All Chinese words end either in a vowel, a diphthong (in which, however, each vowel sound is distinctly pronounced, making the word often to appear of more than one syllable), or a nasal. Of such simple words or roots there are about 450. But the emphasis or accent of

many of these words may be varied by the speaker in four or five different ways, so as to produce a corresponding variety in their meaning, by which means the number of simple words or roots amounts to about 1200. There is no distinction of parts of speech in the Chinese language, and no recognition of the principle of inflection, Chinese words being incapable of any modification of *form*. The relations of words are ascertained by their position in a sentence. Hence Chinese grammar is *solely* syntax. Thus *ta*, according to its position in a sentence, at one time serves the purpose of an adjective, meaning 'great;' at another, a substantive, meaning 'greatness;' and again of a verb, meaning 'to enlarge' and 'to be great;' or of the adverb 'very.' There are certain words, however, which have at length lapsed into so vague and general a signification, that in conversation and literature they are now used in some cases as particles to determine the relations of other words; but in the older literature this is very rare, and is against the genius of the language. From what has been said, it will readily be inferred that the gender, number, and case of words are not determined by the *form* of the words themselves. They are, in fact, denoted by the addition of other words. Thus, *people* in Chinese is *multitude man*, *son* is *man child*, *daughter* is *woman child*. The relation of the *superlative* is also curiously expressed. *The best of men* is in Chinese a *hundred man good*. The purest Chinese is spoken at Nankin, but the same idiom, called 'the language of the mandarins,' is spoken by the educated in all parts of the empire. For a knowledge of Chinese grammar, see Prémare's *Notitia Lingue Sinicæ* (Malacca, 1831), Medhurst's *Chinese Grammar* (1842), and Medhurst's *Chinese and English Dictionary* (2 vols. Batavia, 1842).

In Chinese the written character, generally speaking, does not indicate the sound of the word, but gives a kind of hieroglyphic or pictorial representation of the idea or thing to be expressed. Hence there are required as many of these characters or symbols as there are ideas to be represented. Since many words similar in sound are different in signification, whilst in writing each idea has its peculiar symbol, the number of words represented by writing—without reckoning those peculiar to certain dialects—is perhaps ten times greater than those distinguished by the ear. The number, in fact, is reckoned at 50,000, but these are far from being all in general use. In writing and printing, the characters are arranged in perpendicular columns, which follow one another from right to left.

In its origin, Chinese writing is hieroglyphic or picture-writing, with the addition of a limited number of symbolical and conventional signs; the larger number of Chinese characters are formed by the combination of such hieroglyphs and signs. But as one such character by itself seldom determines the sound, an additional word is conjoined for this purpose; so that the great mass of Chinese written words consist of an ideographic and a phonetic element. Native grammarians divide their characters into six classes. The first class comprises simple pictorial representations of sensible objects, such as sun, moon, mountain, &c., and contains 608 characters. The second class includes such characters as are formed by the combination of two or more simple hieroglyphs, which together convey, in a more or less intelligible manner, some other idea; for example, the hieroglyph for sun, combined with that for moon, conveys the idea of light; mouth and bird, that of song, &c.; of these there are 740. The third class embraces those characters which indicate certain relations of position, as above, below, the numerals, &c.; of

these there are 107. The fourth class consists of characters which, by being inverted, acquire an opposite signification, as right, left, standing, lying, &c., and contains 372. The characters of the fifth class are termed derived characters; the meaning of the simple or compound characters used to express physical objects, is transferred to mental objects, or to other physical objects with which they are associated, e. g., the hieroglyph for a heart signifies the soul—that for a room, signifies the wife, &c.; of these there are 598. The characters of the sixth class include those which are composed, as above mentioned, of sign and sound. Almost all names of plants, fishes, birds, and many other objects which it would be difficult to represent hieroglyphically, are denoted by the compound characters of the sixth class, which amount to 21,810 in number. As this class, however, consists merely of repetitions of the other five classes, the immense number of Chinese characters may be reduced to 2425; and whoever learns these may be said to know them all.

The hieroglyphical characters in their oldest form were easily recognisable figures: thus, the hieroglyph for sun was as in the fig. at *a*; for moon, as at *b*; for light, a combination of sun and moon, as at *c*; for to listen, folding-doors and an ear, as at *d*; for white, a very squint eye, in which hardly anything but the white is seen, as at *e*; for friends,



Chinese Characters.

the two valves of a bivalve shell, as at *f*. In the course of time, through hasty and careless tracing, the objects denoted by the hieroglyphs have almost ceased to be recognisable. The modern hieroglyphs corresponding to the above are as represented at *a'*, *b'*, *c'*, &c. See Abel Rémusat's 'Mémoire sur l'Écriture Chinoise,' in the *Mémoires de l'Académie des Inscriptions*, vol. viii.; and for a view of the Chinese characters, both ancient and modern, Hager's *Monument de Yü* (Par. 1802).

The Chinese literature, in a geographical, ethnographical, and historical point of view, is unquestionably the most comprehensive and important of the whole of Asia. The printed catalogue of the Emperor Kien-long's library is composed of 122 volumes; and a selection of the Chinese classics, with commentaries and scholia, which was begun by the order of the same emperor, is said to comprise 180,000 volumes, of which, in the year 1818, 78,731 volumes had already appeared. In the five canonical or classical books, called *King*, are contained the oldest monuments of Chinese poetry, history, philosophy, and jurisprudence, some portions of which belong, perhaps, to the most ancient writings of the human race. Confucius (q. v.), in the 6th c. B. C., collected them from various sources, and in this collection they have been pretty faithfully handed down to us. Next to these in value are the *Sze-shu*, or the four books. These, as they were written by Confucius and his disciples, must be regarded as the most trustworthy source for information respecting that school of philosophy, the study of which gives such important insight into the intellectual and political life of the Chinese. Translations of these four books, which are generally known as the works of Confucius, have been

made into English by Collie (Malacca, 1828); into German, by Schott (2 vols., Halle, 1828); and into French, by Panthier (Par. 1841). Almost contemporary with Confucius lived Lao-tse (q. v.), who was born 604 B. C. He was the founder of a school of philosophy, more spiritual in its character than that of Confucius, but which has now degenerated into the lowest and most vulgar kind of demonology; see *Le Livre de la Voie de la Vertu*, Chinese and French, by Julien (Par. 1842). In mythology, the Chinese have *The Book of the Mountains and Seas*, *The History of the Gods and Spirits*, and some others. In jurisprudence may be mentioned the universal collection of laws, and the criminal code of the present dynasty; see *Ta-Tsing-lu-li*, being the *Fundamental Laws and Supplementary Statutes of the Penal Code of China*, by Staunton (Lond. 1810). The Chinese literature is also very rich in works on medicine, natural history, astronomy, agriculture, military science, music, and all branches of mechanics and industry; see *Résumé des principaux Traités Chinois, sur la Culture des Mûriers et l'Éducation des Vers-à-soie*, by Julien (Par. 1837). In philology, the most valuable works are the dictionaries, in which the Chinese characters have been collected and elucidated by examples from the whole treasury of Chinese literature; but the greatest of all works of this kind is the dictionary of the Emperor Kang-hi, which is now regarded as the highest authority for the pronunciation and meaning of the characters. Of the encyclopedias of the Chinese, the most conspicuous is that by Ma-tuan-lin (1300 A. D.), called *Wen-hien-thong-khao*—i. e., an accurate investigation of the ancient documents, with rich supplements. This is an inexhaustible mine of the best materials for a thorough knowledge of the Chinese empire and the neighbouring races, from the remotest periods to the present time. But the most valuable portions of the Chinese literature are, undoubtedly, their historical and geographical works, which are indispensable to a knowledge of Upper Asia. Sse-ma-thsian (100 B. C.) compiled, from every recognised authority, a work called *Sse-ki*, or historical memorials, which embraces the history of China from the year 2637 B. C. up to the commencement of the dynasty of Han in the 2d c. B. C. This work has been continued by the different dynasties, and forms a complete collection of the annals of the empire up to the termination of the Ming dynasty in 1643 A. D. It is known under the title of *Nian-er-see*, or the 22 histories. The entire collection of the official annals from 2698 B. C. to 1645 A. D., comprising a period of 4343 years, and consisting of 3706 books, is to be found in the library at Munich.

Amid all their scientific labours, the Chinese have not neglected the art of poetry, in which they possess voluminous collections that have yet to be made known to Europe. In lyrical poetry, the most distinguished names are Li-thai-pe and Tu-su, both of whom flourished at the beginning of the 8th c. A. D.; see Davis 'On the Poetry of the Chinese,' in the *Transactions of the Royal Asiatic Society*, vol. ii. The romantic poetry of the Chinese, although void of poetic beauty, is valuable for the insight it gives into their domestic life. Their dramatic poetry has laws peculiar to itself, and resembles partly the romantic drama of the Germans, and partly the *comedia delle arte* of the Italians. They have also a kind of novel in dialogues, which forms a subordinate species of drama. Besides the speaking persons or actors, there is what they call a singing person, who introduces into the piece songs which he sings to popular melodies, and appears to correspond in a rude way to the Greek chorus. The best collection of works in this species of

literature is the *Yuen-dschin-pe-tschong*, i. e., the hundred dramas from the Mongol dynasty (1260—1341), from which all the Chinese dramas known to Europeans have been taken. A Chinese novel, affording a graphic view of the tastes and literary views of that people, has recently been placed within the reach of European readers by the eminent Chinese scholar Stanislas Julien, under the title of *Les Deux Jeunes Filles Lettrées* (Par. 1860).

The richest collections of Chinese books in Europe are found in Paris, London, Berlin, Munich, and St Petersburg. A history of Chinese literature has never yet been written. The Chinese themselves possess numerous works on this subject, but they are very meagre, being confined chiefly to bibliographical and critical treatises.

CHINESE SEA, or CHINA SEA, that portion of the Pacific Ocean which has China and Siam on the west, the island of Formosa on the north, the Philippines on the east, and Borneo on the south, and which forms the great Gulfs of Tonquin and Siam.

CHINESE WHITE. The white oxide of zinc has recently been introduced into the arts, under this name, as a pigment in place of the preparations of white-lead. It changes very little either by atmospheric action, or by mixture with other pigments; but it has not the body of white-lead.

CHINGLEPUT.—1. A fort, with a town adjacent, in lat. $12^{\circ} 41' N.$, and long. $80^{\circ} 2' E.$, 36 miles to the south-west of Madras. It is accessible to an enemy only from the south, having a tank or artificial lake on the east and part of the north, and rice-fields, irrigated from the same, on the remainder of the north and on the west. In the dry season, the tank is nearly exhausted, the weeds and slime in its bed causing malaria. Notwithstanding this, however, the place is considered to be more than ordinarily healthy.—2. A district taking its name from the fort above mentioned, which is politically its capital. It stretches in N. lat. from $12^{\circ} 14'$ to 14° , and in E. long. from $79^{\circ} 35'$ to $80^{\circ} 25'$, and contains 2993 square miles, and 583,462 inhabitants. With about 120 miles of coast, it has not a single harbour or anything like shelter from the surf. Nor is its internal navigation of any value. The only considerable river, the Palar, is in most parts destitute of water during the dry season. Excepting in October, November, and December, comparatively little rain falls. From that circumstance, and perhaps also from an inferiority of soil, cultivation is said to be so much circumscribed, as to embrace only about 96,000 acres, or 1-20th part of the entire area.

CHINI, a village of the Punjab, about a mile from the right bank of the Sutlej, the most easterly of the five rivers which give name to the country. It is in lat. $31^{\circ} 31' N.$, and long. $78^{\circ} 19' E.$, and is 8770 feet above the sea. Notwithstanding this elevation, it is a delightful place of sojourn, and was a favourite residence of Lord Dalhousie. It occupies a slight depression on the southern slope of a lofty mountain, which fertilises the soil with a net-work of never-failing rills. The neighbourhood is remarkable for the size and flavour of its grapes, while the vines, trained over horizontal lattices, afford, while in foliage, a tolerably continuous shelter.

CHIN-KEANG-FOO, a fortified city of China, on the Yang-tze-kiang river, in N. lat. $32^{\circ} 14' 26''$, and long. $2^{\circ} 55' 43'' E.$ of Peking. As a stronghold and key of the Grand Canal, it was taken by the British forces, after a spirited resistance, July 21, 1842, when the Tartar general in charge 'deliberately burned himself to death on a pile of wood and

official papers, nothing being found of him but the skull and the bones of the legs and feet.' Suicides and domestic immolations were very numerous. C. was taken by the Tae-ping rebels, April 1, 1853, when the Tartar garrison were massacred without resistance. Provisions failing, the rebels evacuated the place in the beginning of the year 1857; but they have lately re-occupied it. The population formerly amounted to 500,000; but in 1859, after having been in the possession of the Tae-pings, Mr Oliphant supposed it not to exceed 500 souls.

CHINNOR, a musical instrument of the ancient Hebrews, with 32 strings.

CHINON, a town of France, in the department of Indre-et-Loire, beautifully situated on the Vienne, 25 miles south-west of Tours. It has the remains of a huge old castle, formerly the occasional residence of the Plantagenet kings of England, and also of some of the French sovereigns, and celebrated as the place where Joan of Arc commenced her historical career. C. has manufactures of druggets, serges, earthenware, &c. Pop. 5000.

CHINQUAPIN. See CHESNUT and OAK.

CHINSU'RA, a town on the right bank of the Hooghly, about 20 miles above Calcutta, in lat. $22^{\circ} 53' N.$, long. $88^{\circ} 23' E.$ Pop. 14,000. It contains the Hooghly College, and is considered one of the healthiest places in Bengal. It was originally a Dutch settlement, but was ceded in 1824 to the British, along with some other places on the mainland, in exchange for the English possessions in the island of Sumatra.

CHINTZ, a highly glazed printed calico, with a pattern in many colours on a white or light-coloured ground. It is chiefly used for bed-hangings, for covering furniture, and other purposes where gay colours are desired, and where there is much exposure to dust, which does not adhere to its highly calendered surface.

CH'IO. See SCIO.

CHIOCO'CCA, a genus of tropical and subtropical plants, of the natural order *Cinchonaceæ*, of which two species in particular, *C. anguifuga* and *C. densifolia*, the former a trailing herb, the latter a bushy shrub, enjoy a high reputation in their native country, Brazil, as cures for snake-bites. An infusion of the bark of the root is certainly one of the most violent emetic and drastic medicines known, its action being accompanied by spasmodic agitations of the whole frame and other symptoms, such as to preclude its use except in the most extreme cases. Yet it had at one time a high reputation in Europe, and was administered in small doses as a diuretic and purgative.

CHIOGGIA, or **CHIOZZA**, an important commercial town and seaport of Northern Italy in the Venetian district, stands on an island of the same name in the Adriatic, and is connected with the mainland by a stone bridge of 43 arches. The population, amounting to 26,000, are chiefly engaged in the coasting-trade, in lace-making, and in snip-building.

CHIO'NIS and **CHIO'NIDÆ**. See SHEATH-BILL.

CHIP HATS. See BRAZILIAN GRASS.

CHIPPENHAM, a parliamentary and municipal borough in Wiltshire, in a valley on the left bank of the upper part of the Bristol Avon, on the Great Western Railway, 22 miles east of Bristol. It consists chiefly of a well-built street above half a mile long. A bridge of 21 arches crosses the Avon here. C. is famed for its markets of cheese and corn, its cheese-market being one of the largest in Britain. There are silk and woollen manufactures;

and some mineral springs in the vicinity. Population of parliamentary borough, 6283; of municipal, 1707. It returns two members to parliament. C. was the seat of the Saxon kings of Wessex. About 880, the Danes took it from Alfred, and kept it two years.

CHIPPEWAYS. See INDIANS.

CHIQUICHIQUI PALM (*Leopoldinia Piassaba*), the PIASSABA of the north of Brazil, and one of the palms which yield the Piassaba (q. v.) fibre, now so much used for making brushes. The Piassaba fibre exported from Pará is all obtained from it. It grows in swampy or occasionally flooded lands on the banks of the Rio Negro and other rivers of Venezuela and the north of Brazil; and has a crown of very large, regularly pinnate leaves, with smooth slender stalks. The leaves, like those of many other palms, are much used for thatching. The commercial fibre is obtained from a remarkable covering of the stem; formed of marginal processes of the leaf-stalks, elongated into ribbon-like strips, and interlaced, finally splitting into fine fibres, hanging down five or six feet, and entirely concealing the stem, so as to give the tree a very extraordinary appearance. It twists readily into cordage, and the fibre has been long used for cables of canoes on the Amazon and other rivers. Before the independence of Brazil, the Portuguese government had a factory on the Rio Negro, for the manufacture of cables of this fibre. The export of the unmanufactured fibre from Pará to England began about ten or fifteen years before the present time (1860).

CHIQUIMU'LA, ISTHMUS OF, in Central America, to the south-east of the peninsula of Yucatan, in long. 89° W. Its breadth from the Caribbean Sea to the Pacific is about 150 miles—the greatest elevation not exceeding 2000 feet.

CHIRA'TA, CHIRE'TTA, or CHIREE'TA (*Agathotes Chirayta*, also known as *Ophelia Chirata*), an official plant belonging to the natural order *Gentianeæ*, and possessing properties similar to those of the common Gentian, the Centaury, and other plants of that order. It is a native of the mountains of the north of India. The whole plant is intensely bitter, and has been long used in its native country as a tonic and stomachic. It is also in high estimation with European practitioners in India as a febrifuge, and is often used by them as a substitute for cinchona. The medicinal virtues reside both in the herb and root. The whole plant is pulled up at the time when the flowers begin to fade, and is dried for use. It is now imported to some extent into Britain.

CHIRIQUI', a name of various application in Costa Rica, the most southerly state of Central America.—1. A river flowing towards the north—the lat. and long. of its mouth being about 9° N., and 82° 30' E.—2. A spacious lagoon with three entrances, and with a depth of water for the largest ships, which receives the river above mentioned. It measures 90 miles along the coast, and 40 or 50 in width.—3. An archipelago between the lagoon above mentioned and the Caribbean Sea.

CHIRON, or CHEIRON, the most famous of the Centaurs (q. v.). In the ancient works of art, C. of course appears as half-man, half-animal; but his features, instead of expressing mere savage and sensual strength, as those of the Centaurs generally do, are marked by a mild wisdom, in harmony with the character and deep knowledge attributed to him by the Greek mythologists.

CHIRRA POONJEE, a town in the north-east of India, in lat. 25° 14' N., long. 91° 45' E. It stands on the Cossya Hills, at the height of 4200

feet above the sea—and has a temperature during the hot months 20° F. lower than that of the plains of Bengal. Notwithstanding this, however, the place has proved unsuccessful as a sanitarium. The vicinity abounds in mines of coal and iron, which may be profitably worked.

CHIRU (*Antelope Hodgsoni*), a species of antelope, inhabiting the pine-forests and elevated open plains of Tibet, in regions bordering on the limits of perpetual snow. It is much larger than the chamois, being about five feet in length, and the height at the shoulder about three feet. The C. lives in great herds, and seems to exceed almost all the other gregarious ruminants in watchfulness against the approach of danger. Sentinels are constantly posted, to prevent surprise.

CHISWICK, a village in the centre of Middlesex, 7½ miles south-west of St Paul's, London, on the left bank of the Thames. Pop. of parish, 6303. Around C. are many fine villas, extensive market-gardens, to supply London, and the gardens of the London Horticultural Society.

CHITIN forms the skeleton of all insects and crustaceans. In insects, it constitutes not merely the external skeleton, the scales, &c., but also forms their tracheæ, and thus penetrates into the most remote portions of their organs; indeed, one of the layers of their intestinal canal consists of chitin. Hence, we can make good preparations of these parts by treating insects with a solution of potash, which dissolves all but the C.: in this way, we can microscopically examine the most delicate parts, as, for instance, the valves of the tracheal openings.

In a state of purity, it is a white amorphous body, which usually retains the form of the tissue from which it is prepared. It has been analysed by C. Schmidt, Lehmann, and other chemists. Schmidt considers that its composition is represented by the formula $C_{17}H_{14}NO_{11}$. The best method of obtaining C. is by boiling the elytra of the cockchafer with water, alcohol, ether, acetic acid, and alkalis. The substance left after these respective boilings is pure chitin. It seems to be identical with the substance termed by Lassaigne *Entomoderm*.

CHITON, a Linnæan genus of mollusks. Linnæus, regarding merely the shell, placed them in the class of Multivalves, a class entirely artificial. They are now regarded as constituting a family (*Chitonidae*) of gasteropodous mollusks, of the order *Cyclobranchiata* of Cuvier, and as occupying a

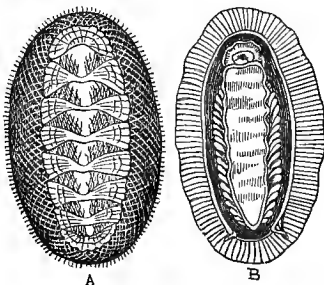

Chiton Squamosus :
A, animal and shell seen from above; B, animal seen from below.

place in systematic arrangement close to limpets. The shell is composed of eight narrow, transverse, calcareous pieces, overlapping each other in a row along the back, and strongly attached to the mantle, which is remarkably fleshy and fibrous.

They have the power of rolling themselves up into a ball. The organ of locomotion is an oval foot, more or less wide, according to the species, and extending the whole length of the animal. More than 200 species are known; they occur in all climates, most abundantly on rocks at low-water, but some of them at great depths. Some of them creep along the sand. All the British species are small; but some foreign ones grow to three or four inches in length. The fry of these mollusks swim about by means of long vibratile cilia.

CHITTAGO'NG, or ISLAMABA'D (the second name having been conferred by Aurungzbe, who captured it towards the close of the 17th c.), a city of India, standing on the Kurrumfuli, about 7 miles from its mouth, in lat. 22° 20' N., and long. 91° 54' E. It came into the possession of the British, along with Bengal Proper, in 1760—1765. But having originally formed part of Arracan, it was claimed, after a lapse of sixty years, by the Burmese emperor as a dependency of that territory—a claim which formed one of the grounds of the war of 1824. Through the results of that contest, C. has diminished in importance. Rice, which it once largely exported, is now got more cheaply in the ports of Arracan; and the ship-building business, in which it was once deeply engaged, is now transferred chiefly to Moulmein, in Tenasserim.

CHITTAGONG, a maritime district of the sub-presidency of Bengal, taking its name from its capital above mentioned. It is bounded on the S. by Arracan, and on the W. by the Bay of Bengal, and stretches from lat. 20° 45' to 23° 25' N., and from long. 91° 32' to 93° E. Independently of a wild and woody tract on its east frontier, it contains 2717 square miles, with about 1,000,000 inhabitants. In the forests of C., large numbers of elephants are annually caught for the use of government.

CHITTO'R, the name of two fortified towns in India.—1. C. in the district of Arcot, about 80 miles to the west of Madras, in lat. 13° 12' N., and long. 79° 9' E. It stands on the south or right bank of the Puni, an affluent of the Palar, and is about 1100 feet above the sea. Its river varies, according to the season, from a small rivulet to an expanse of 400 yards in width. When the stream is at its lowest, the very tanks, as well as the deserted channel, become little better than slime—the result being fever, ague, dysentery, and other diseases. The thermometer has occasionally reached 140° in the sun; but the annual range in the shade runs from 56° to 100°.—2. C. in Odeypoor, or Mewar, about 270 miles to the south-west of Agra, in lat. 24° 52' N., and long. 74° 41' E. The fortress occupies the summit of an isolated rock of nearly 6000 yards in length, and of 1200 in breadth, which is scarped all round to a depth of 80 or 100 feet, about a fourth part of its entire altitude. Within the enclosure are several antique structures—such as temples, tanks, a palace, commemorative pillars, and an inner citadel.

CHIU'SA, LA, a town of Piedmont, Northern Italy, situated on the left bank of the Pesio, 8 miles south-east of Coni. It has manufactures of silk and glass, and a population of 7000.

CHIU'SI, a town of Tuscany, Central Italy, 37 miles south-east of Siena, with a population of 3000, stands on an eminence in the Val di Chiana, not far from the lake of the same name. In ancient times, under the name of *Clusivum*, it was one of the twelve republics of Etruria, and the residence of Porsena (q. v.). When Italy was overrun by the barbarians, C. fell into decay, the whole valley was depopulated, and became the pestilential pool

described by Dante. Since the improvement of the course of the Chiana (q. v.), C. has begun to flourish again along with the whole district. But it is in connection with the discovery of Etruscan antiquities that C. is chiefly heard of. Within the last quarter of a century, immense quantities of these remains have been found in the neighbourhood in the grottos that served the ancient Etruscans as tombs. There are three museums in C. filled with them, and a great number are in the public gallery at Florence. They consist chiefly of sun-dried earthenware vases, black, and partly covered with mythological figures. Excavations still continue to be made, but discoveries have become rarer of late years.

CHIVALRY (Fr. *chevalerie*, from *chevalier*, a knight or horseman), the system of knighthood, together with the privileges, duties, and manners of knights. The social arrangement to which this term is applied seems first to have assumed the character of a positive institution during the 11th c.; but so far from being an invention of that period, it had its roots in the manners of the Germanic races, amongst whom it ultimately arose, at the earliest period at which they are historically traceable. In the description which Tacitus has given us of the manners of the Germans, we find the most unequivocal indications of the existence, not only of the general spirit, but, in a partially developed form, of many of the special arrangements of chivalry. But it was in connection with feudality that C. attained to its full proportions, and in many respects it must be regarded as the complement of that institution. See FEUDAL SYSTEM. Whilst feudality exhibits the political, in C. we see the moral and social side of the arrangements of medieval life. It was in the feudal mansions of the barons that the system was developed; and to the lay portion of the youth of the higher classes, the instruction which they there received in the usages of C. formed by far the most important part of education. In addition to the martial accomplishments, which corresponded to those of a modern cavalry-officer, they were instructed in the political relations which subsisted between the vassal and his lord, by which the whole body of society was then bound together; and in what might almost be called a system of ethics, strangely enough exhibiting unmistakable traces of the Stoic philosophy. The analogy between the severer virtues recommended to the special cultivation of their disciples by the followers of Zeno, and those inculcated on the novice in C., and practised by the knights of the middle ages, might be ascribed to other than historical causes, were it not that we are able to trace the connection between them with something approaching to certainty. If any one wishes to convince himself of the truth of our assertion, let him compare the last production of the intellectual life of antiquity with one of the earliest and most important of our own literature, the *Consolations of Philosophy* of Boethius with Chaucer's *Testament of Love*. The resemblance is so close, that the latter work has, not without reason, been regarded as an imitation of the former; but the main features which distinguish them, and mark Chaucer's work as belonging to the modern world, are more instructive than even their similarity. The place which Philosophy, the celestial consoler, occupies in the work of Boethius, in that of Chaucer is supplied by *Love*—a being whom we must in nowise confound either with the heathen goddess, or, as some have done, with the divine love of the Christian religion. She is neither more nor less than the embodiment of an abstract idea which formed the central point of the

whole system of C.; and her substitution for the Philosophy or Reason of Boethius is very characteristic of a state of society in which the affections and passions, rather than the intelligence, were the motive principles. The 'Love' of Chaucer is a complete generalisation, altogether independent of individual object, and the consolation which she proffers to her votary is that of enlisting in his favour the special guardian, the 'Margarite,' who is supposed to watch over his individual fortunes. The 'Margarite' seems to correspond to the chivalrous idea of the *Lady-love*, in its purest sense, when its reference to a person was by no means indispensable, but when it signified rather 'the love of woman,' the highest object of the knight's ambition. Under the protection of this guardian spirit, the lover is represented as altogether sheltered from the caprices of fortune, and in her name he has a dose of rather frigid comfort administered to him, greatly resembling that which Boethius receives at the hands of Philosophy. Such is the general idea of the book, and it is a noble idea, embracing the very essence of society as it existed then, and presenting a much deeper view of that singular institution C. than is usually to be met with in writers who have not been actually brought in contact with its influences. But to the two elements which we have mentioned as ingredients in the spiritual life of C., the Germanic traditions on the one hand, and those of classical antiquity on the other, a third falls to be mentioned, which was, perhaps, the most important of all—that of Christianity as represented by the church. The clergy were too fully aware of the importance of early impressions, not to seize on the imagination of the aspirant to C. at the all-important moment of his inauguration. The purifications, prayers, and vigils, the sacrament and the vows by which this solemn rite was accompanied, are detailed elsewhere (see KNIGHT, BANNERET, BATH, &c.); and their influence in casting a religious character over the whole institution of C., and occasionally in directing its energies specially to the propagation of Christianity, by means of the various religious orders of knighthood and the Crusades, is well known. Nor was the poet behind the priest in availing himself

628

of the influences of C., and developing them in the region of the imagination. What Chaucer has exhibited in the work to which we have referred, may be regarded rather as the philosophical than the poetical side of the institution. But to poets of a lighter and more imaginative cast of mind, C. has furnished, from the days of the troubadours down to the present poet-laureate, no insignificant portion of their subject-matter. King Arthur and his Knights of the Round Table, the traditions regarding whom had been taken from a period altogether mythical, and long anterior to the existence of C. as an institution, became to the poetry of the middle ages very much what the heroes of the Trojan War were to that of the whole ancient world. Much astonishment has often been expressed at the contrast between the lofty and ideal purity of the code of morals inculcated by C., and the grossness of the lives of the men who were trained under its influences. The case is one which in a remarkable degree proves the practical importance of the inculcation of sound doctrine, for the practice gradually, though slowly, conformed itself to the principles; and it is probably in no insignificant degree to the elevated tone of the latter that we owe the moral superiority of the modern over the ancient world.

CHIVALRY, COURT OF, a military court, established by Edward III., of which the Earl Marshal and the Lord High Constable were joint judges. When held before the Earl Marshal alone, it was merely a court of honour; but when both were present, it was also a criminal court. Having encroached on the common law, its jurisdiction was defined by 13 Rich. II. stat. i. Under this act, the court claimed power to give relief to such of the nobility and gentry as think themselves aggrieved in matters of honour, and to keep up the distinctions of degrees and quality. In criminal cases, a jury was sworn; but in general the proceedings of the court were summary matters, being brought under its cognizance by complaint or petition. An attempt was made to revive the functions of the court in Queen Anne's time; but, except as represented by the Earl Marshal's court (see COLLEGE OF ARMS), it has now gone into abeyance.

END OF VOL. II.

