

Construction of Plexiglas Book Cradles

Holding books open safely during an exhibit has been a long time concern of the library community. Although Plexiglas cradling techniques have been used for some time, the directions have only been given out more or less by word of mouth. While I was at the Library of Congress in the mid 1970's, I was lucky enough to be trained to construct Plexiglas cradles by Christopher Clarkson. The following is a description of drawing cradle patterns and using those patterns to construct the finished cradles.

The first thing to determine is the extent to which the book will open comfortably without putting a strain on the cover, endpapers, sewing or textblock paper. Open the book to the page to be displayed by allowing the book to fall open at this point in your hands without forcing the cover open. Once the cover has been opened to a comfortable point, double check the covers' hinges and the endpapers' joints to be certain they are not pulling and straining. This pulling and straining can cause these areas to split apart, especially if the book is to be left open in one position for an extended period while on exhibit. Also check that there are no weak areas in the paper of textblock which could give way to running tears while the book is open. And finally check to be certain the sewing structure is strong and unlikely to snap while the book is open (fig. 1).

Once you have determined the book's comfortable opening, hold that position and carefully stand the book on its tail edge. Sometimes a second person may assist with particularly large, heavy books by holding the book upright. The book should be placed on top of the paper to be used to draw the book and cradle's profile. Using a ruler and a pencil draw the profile of the cover in a linear fashion keeping the spine area angular. Keep the line drawing about 1/8" away from the book's cover to avoid damaging the cover (fig. 2).

Decide how the book is to look in the display case. Tilting a book to reveal an important page in a tight binding can be a convenient display technique. If the book opens widely or both pages are important, the two sides of the book can be opened with each side equidistant from

the floor of the exhibit case. With the book opened symmetrically, measure the same distance on each side of the book from the top of the textblock to an arbitrary point somewhere below the spine of the cover's profile drawing. Generally, I choose a point below the spine of the cradle which almost touches the spine. By choosing a point very close to the spine I can plan on having the spine of the cradle rest on the base of the case giving the cradle one more point of stability. Draw the base line by connecting these points (fig. 3).

The cradle's legs are drawn at right angles to the base line up to the cover. This line should hit the profile drawing just under the cover and come in 1/8" to 1/4" from the foreedges (fig. 4).

Label the left and right sides of the cradle. Beginning on the left side of the cradle label each angle A, B, C, etc. Note each angle as a mountain or valley fold. A mountain fold is one which is folded towards the cover and a valley fold is one which folds down or away from the cover (fig. 5).

Use a narrow strip of paper to expand the cradle's profile drawing and create the pattern. Begin with the end of the strip of paper at the base end of the left leg, measure the distance up to the first angle and mark that point on the strip of paper. Continue from that point measuring and marking the distance between the angles including the base end of the right leg. Label left and right legs on the paper strip as well as noting the proper angle designations (fig. 6).

Place the paper strip on a separate piece of paper, draw one straight line parallel to the top edge of the paper strip. This will represent the lower edge of the pattern. Next determine the height of the cradle by measuring the height of the book and subtract 1/8" from this measurement. Draw the upper edge parallel to the lower edge using this measurement. Mark the point of each angle on the lower edge, ignoring the legs at this time. Draw perpendicular lines from the lower edge to the upper edge at each of these points. Label each of these lines with their angle designation and mark the left and right sides of the pattern (fig. 7).

Determine the angle of the tilt at which the book is to be displayed. It may be helpful to have a second set of hands helping to hold the book on the desired tilt. Use the interior of the case to help choose the tilt of the book, thereby avoiding the problem of tilting the book to an unseeable angle or choosing an angle which projects the cradle beyond the interior size of the exhibit case. Once the angle has been determined, use a ruler to continue the line of the book's cover down to the table top. Then cut a piece of cardboard to this predetermined angle. Note the base side of the triangle (fig. 8a).

Place the base side of the cardboard triangle along any one of the drawing's spine lines. The legs are to be drawn at right angles to the cardboard triangle using a square. Draw the legs, beginning at the intersections of the upper and lower edges of the pattern at the lines for the outer most angles. On the example, the legs are drawn at the upper and lower edges of both Lines A(M) and E(M). Using the paper strip, mark the length of both the left and the right legs on the lower leg lines (fig. 8b).

The bottoms of the legs rest on the floor of the exhibit case and are drawn perpendicular to the lower edges of the legs. Begin drawing your line at the mark which designates the length the each leg and continue the line up to the upper line of the leg (fig. 9a).

The lower portion of each leg (see noted triangle on illustration) may be considered optional. These triangles tend to increase the difficulty of manufacturing the cradle. However, the importance of these triangles in certain instances needs to be noted. They can lend stability to any cradle which is on a steep angle or that houses a heavy book. Without these triangular extensions in these types of situations the cradles would tend to be top heavy and prone to falling forward (fig. 9b).

Ledges need to be added to any cradle which is be used to hold a book on a slant or to hang a book upright on a wall. This will keep gravity from pulling the book down this slick slide while it is on exhibit. Packing pieces are also recommended for books placed upright or on a slant to counteract the gravity force pulling down on the textblock. The weight of the textblock can place a strain on the cover's hinges and the endpaper joints. Place the opened book on top of the profile drawing. Mark the thickness of the textblock and the thickness of the cover on each side of the book. Roughly mark the angles at the textblock's foreedges (fig. 10).

To determine the thickness of the packing pieces, measure the size of the textblock's square (the portion of the cover which projects beyond the textblock). *If there are only a few leaves on one side of the book, the packing piece, but not the ledge, can be eliminated on that side.* At the marks for the cover and textblock thickness draw lines which are parallel to the cradle's profile drawing. At the spine ends of the ledges & packing pieces draw lines which are perpendicular to the

profile drawing and come out from the spine approximately 1/2". At the foreedge ends of the ledges and packing pieces draw lines which mimic the angle of the textblock's foreedges and come in from the cradle's legs about 1/2". Label the ledges as left and right sides and note the thickness of the packing pieces (fig. 11).

Cut out the drawing. If possible remove the triangle at the lower edges of the legs giving the pattern a straight lower edge. Refer to discussion for (fig. 9b). Trace the ledge and packing piece patterns onto another paper, label each appropriately and cut out the tracings. Place each pattern piece on a sheet of paper-covered Plexiglas and draw around the patterns. The size and weight of the book determine the thickness of the Plexiglas to be used for the main body and the ledges. Small books can be comfortably housed on 1/8" Plexiglas, while heavier books should be housed on thicker Plexiglas, up to 1/4" thick. Remember to cut the packing pieces out of Plexiglas which is the same thickness as the book's square (figs. 12a & 12b).

The edges of the Plexiglas can be sanded to a smooth frosted finish, at the same time make certain to remove the sharp edges. If desired the edges can be hand polished using rouge after sanding. *Stay away from flame polishing which can change the temper of the Plexiglas causing it to craze when folded.* Remember to sand but not to polish the bottom of the ledges to facilitate adhesion of the ledge to the body of the cradle. Remove the paper covering from the inside of the packing pieces and their corresponding ledges. Using 3M #415 double sided tape adhere the packing pieces to the ledges. Without removing the outer paper of the Plexiglas, the laminated pieces can be sanded to smooth their edges and guarantee they are the same size and to finish their edges (fig. 13).

Remove the paper backing from both sides of the main body of the cradle. Using felt tip markers, draw the fold lines on the Plexiglas. Note each angle's designation (i.e. A(M)). The folds are created by heating the Plexiglas along these lines. The preferred heater is made by Hydor Therme Corp., in Pennsauken, NJ. The model number is sixteen. This one has a slender rod which limits the heat to a narrow band of the Plexiglas. It is best to heat the fold on the side which needs to stretch rather than the side which will be shrinking as the fold is formed. Think of the mountain or outside of the fold enlarging as the fold is created and the valley or inside of each fold as shrinking when the fold is created. As the Plexiglas becomes ready to fold you can see a change in the refraction of the Plexiglas in the heated area. In other words visible objects below the Plexiglas will appear to bend unnaturally within the heated portion of the Plexiglas. When the Plexiglas is ready, slowly begin to fold it. If you notice some resistance, heat it a bit longer. Stand the heated Plexiglas on end over the cradle profile. Fold the angle in the Plexiglas to match the corresponding angle on the profile drawing. Hold the

Plexiglas in place until it has cooled. Cooling can be speeded up by sponging the heated area with water. Continue heating and folding until each angle has been done. (fig. 14).

The marker lines can be cleaned off of the cradle using ethanol. Once clean the book should be tried on the cradle. Adjustments should be done before adhering the ledges and packing pieces. Changes can be made by reheating existing folds. Once the folding has been satisfactorily completed, the ledges (with their packing pieces attached) can be adhered to the body of the cradle. Remove the paper backing from the outside of these pieces. Using a pressure sensitive tape on one side only, temporarily attach the ledges in their positions on the main body of the cradle. You may also want to use some pressure sensitive tape to mask out areas you want to remain clear because the solvent used to affix the Plexiglas, can create a frosty appearance. The next step should be done in a fume hood which provides good ventilation. Place the solvent, methylene chloride, in a needle type dispenser. Fold the ledge back to reveal its bottom, then generously dispense the solvent. Methylene chloride evaporates very quickly, so it is necessary to quickly fold the ledge back up against the main body of the cradle. Hold the ledge firmly in place for a few minutes. Then let the cradle sit for several hours to give the solvent area time to harden.

Remove the tape and clean the Plexiglas to remove finger prints and tape residue. Once the cradle is dry the book can be placed on the cradle and strapped in place using polyethylene strapping (fig. 15).

APPENDIX

There are some things which should be considered whenever working with Plexiglas. They include: where to purchase the material, how the work can be done and what the safety precautions are.

There are many places to purchase the supplies around the country. The best way to locate a local supplier is to contact the manufacturer and ask for Plexiglas MC Acrylic sheets. The Plexiglas comes in 4' by 8' sheets. The manufacturer is AtoHaas North America, Inc.; Philadelphia, PA 19105; Phone # (203)828-3593. Once a supplier has been located, you may want to check whether or not they can also manufacture all or part of the cradle using your drawn pattern. Unless you are fully equipped you may want to consider having them cut out the pieces and polish the edges. Control over the fit can still be attained by folding the cradle and making necessary adjustments in house.

Determine how much of the task you are willing to take on after completing the drawing. If you do decide to tackle the complete job, follow all of the manufacturer's safety precautions for using the equipment and working with the material.

Plexiglas can be cut using a table saw, jig saw or saber saw. As the Plexiglas is cut it heats up and may melt back

together. If this is the case simply recut. Another problem you may encounter is hot particles from the Plexiglas shooting back toward your arms. Protect your arms by wearing long sleeves. Be certain to wear a full face shield to prevent these hot particles from reaching your face or eyes. You should also wear a dust mask. Be careful to follow all of the manufacturer's safety precautions while using any cutting equipment.

Plexiglas can be sanded by hand or with an electric sander. Another item you could use to smooth the edges is a scraper. This task can become labor intensive if all of the smoothing is done by hand. Be certain to wear a full face shield and a dust mask. Also, follow all of the manufacturer's precautions for using any electrical equipment during this process. If you would like to take this one step further and polish the edges, you will need a buffing wheel and rouge. Use the rouge recommended by AtoHaas North America, Inc.

CAUTIONARY NOTE

The safety precautions for working with Plexiglas are clearly written on its masking paper by AtoHaas North America, Inc. A brief summary of those precautions can be helpful in choosing how much of the work you can handle in-house. The vapors produced while cutting, or sanding and polishing the edges can cause nausea, headaches, or dizziness. It can also irritate the eyes, skin and respiratory tract. Make sure the above processes are done in a well-ventilated area and wear a dust mask. If breathing troubles are experienced stop working and get some fresh air. Wash your skin thoroughly after contact with Plexiglas. Wear a full face shield while working with the Plexiglas to avoid having hot particles reaching your eyes. Should the Plexiglas irritate the eyes, flush them with plenty of water for at least 15 minutes.

BIOGRAPHY

In 1972 Linda A. Blaser began her career in a Library of Congress training program which existed at that time. Her instructors were Christopher Clarkson, Donald Etherington, Peter Waters, and Robert McComb. By 1976 Linda was working closely with Christopher Clarkson overseeing the preparation, installation and monitoring of rare book exhibitions. In 1978 Linda left the Library of Congress to begin a free-lance business. Along with the free-lance business, in 1992, Linda began working as a Senior Book Conservator at the Folger Shakespeare Library.

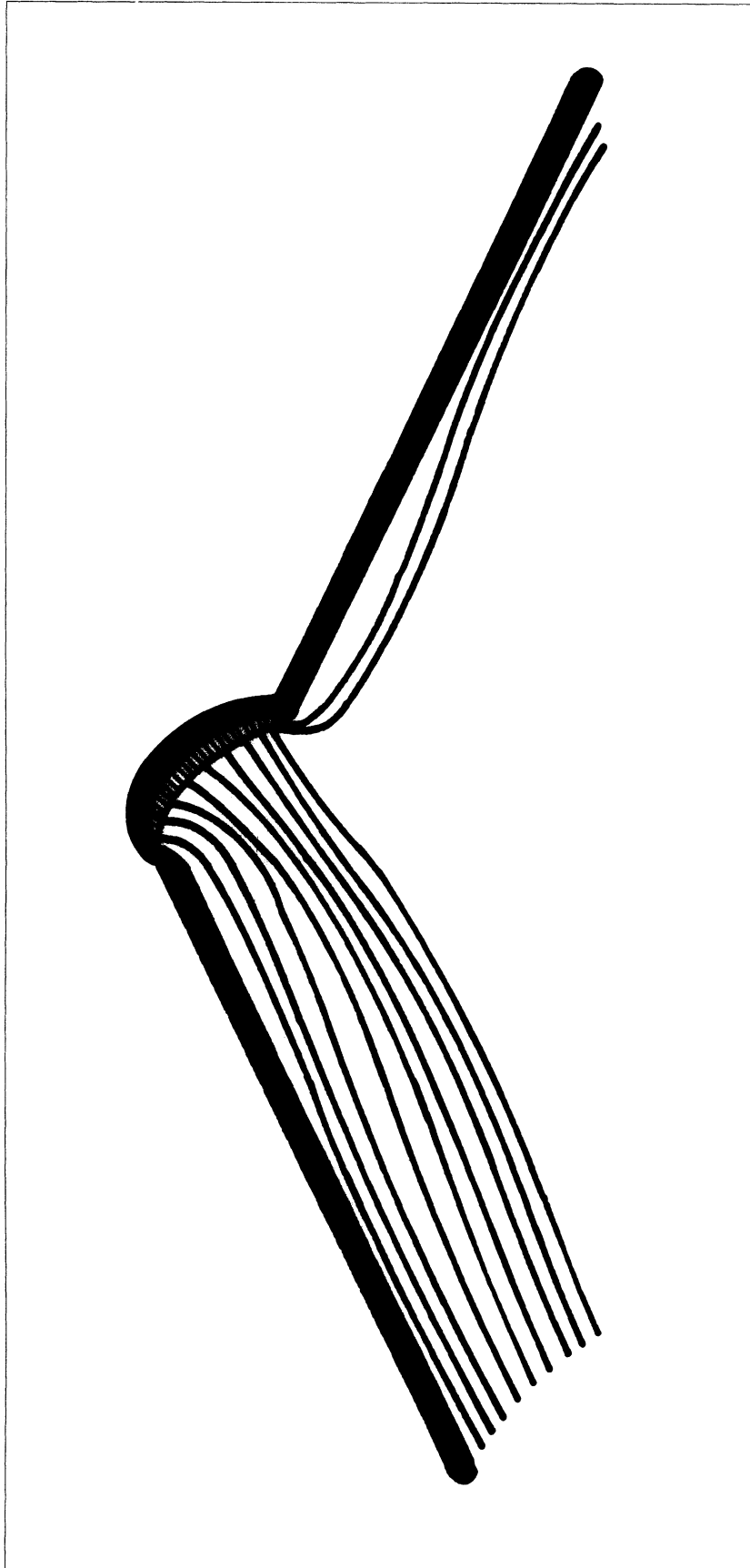

Fig. 1. Book opened to comfortable position

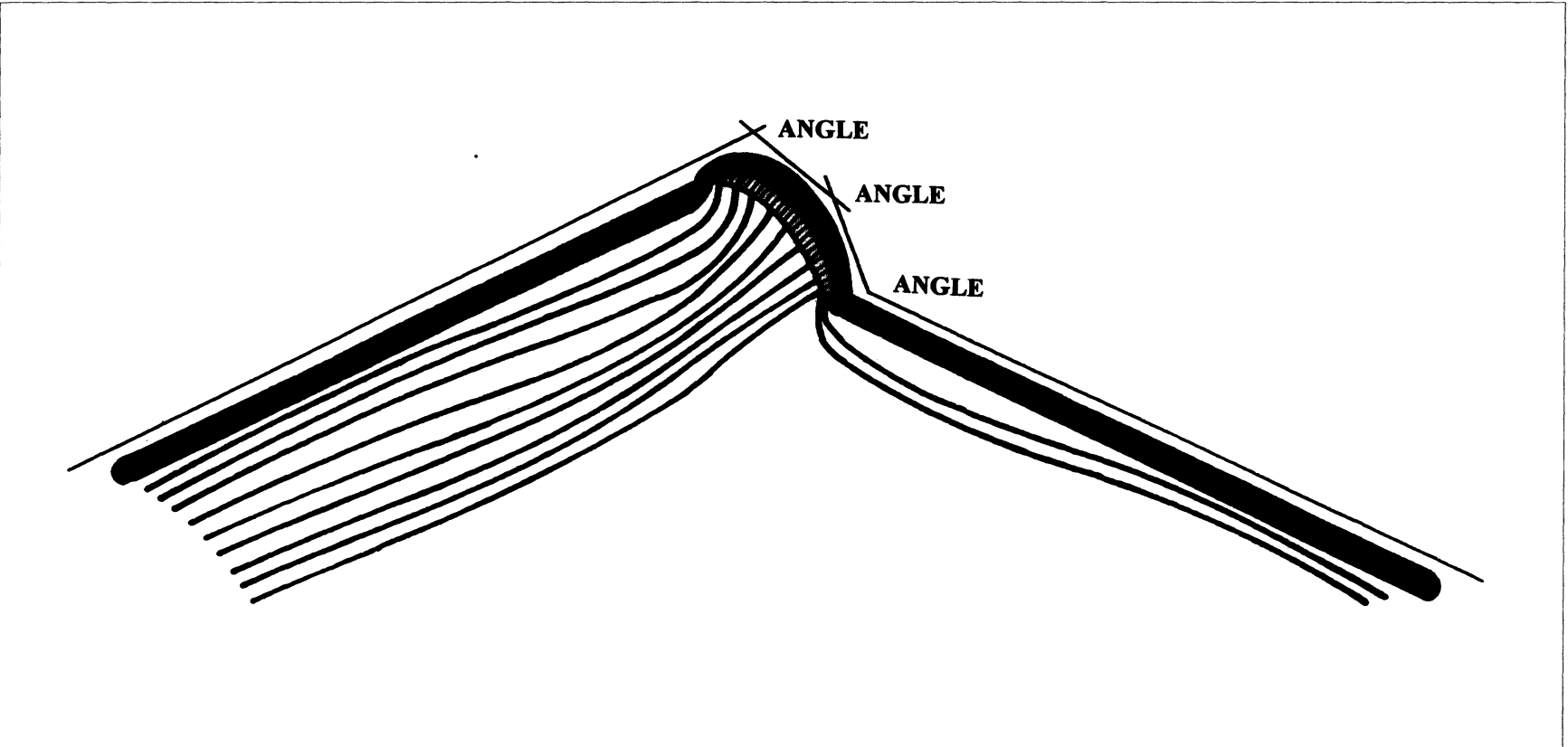

Fig. 2. Drawing of book cover's silhouette

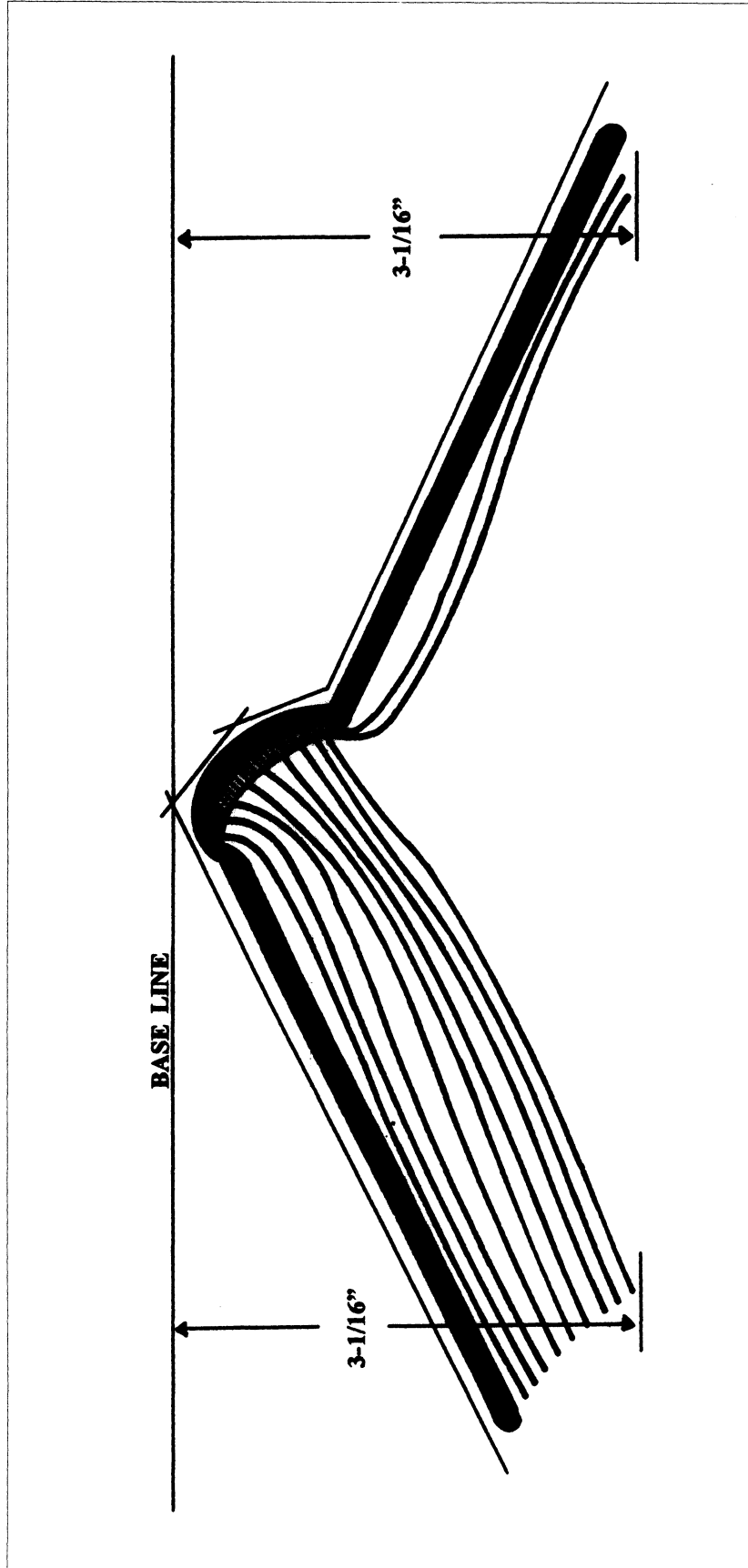

Fig. 3. Determining base line

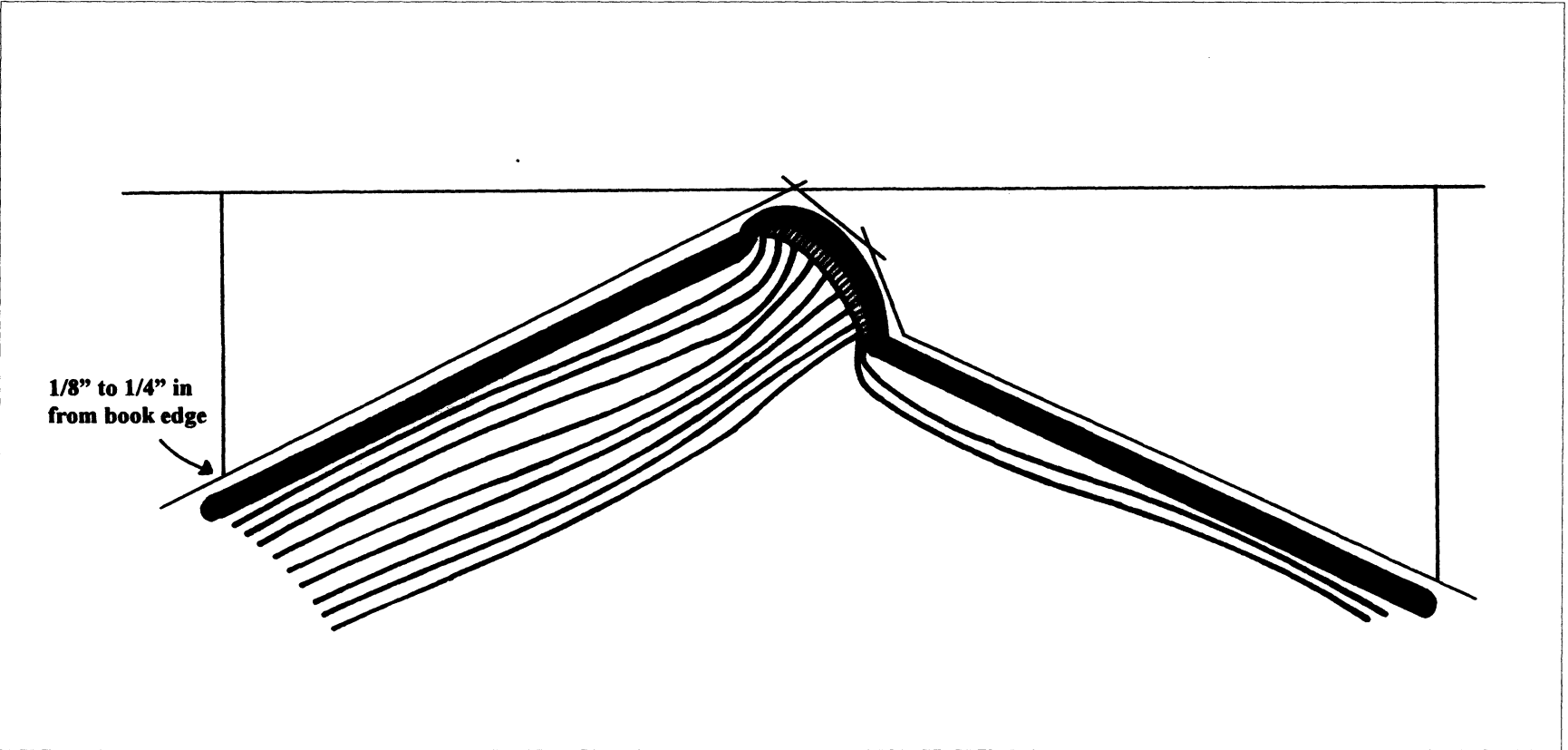

Fig. 4. Cradle's legs drawn at right angles to the base line

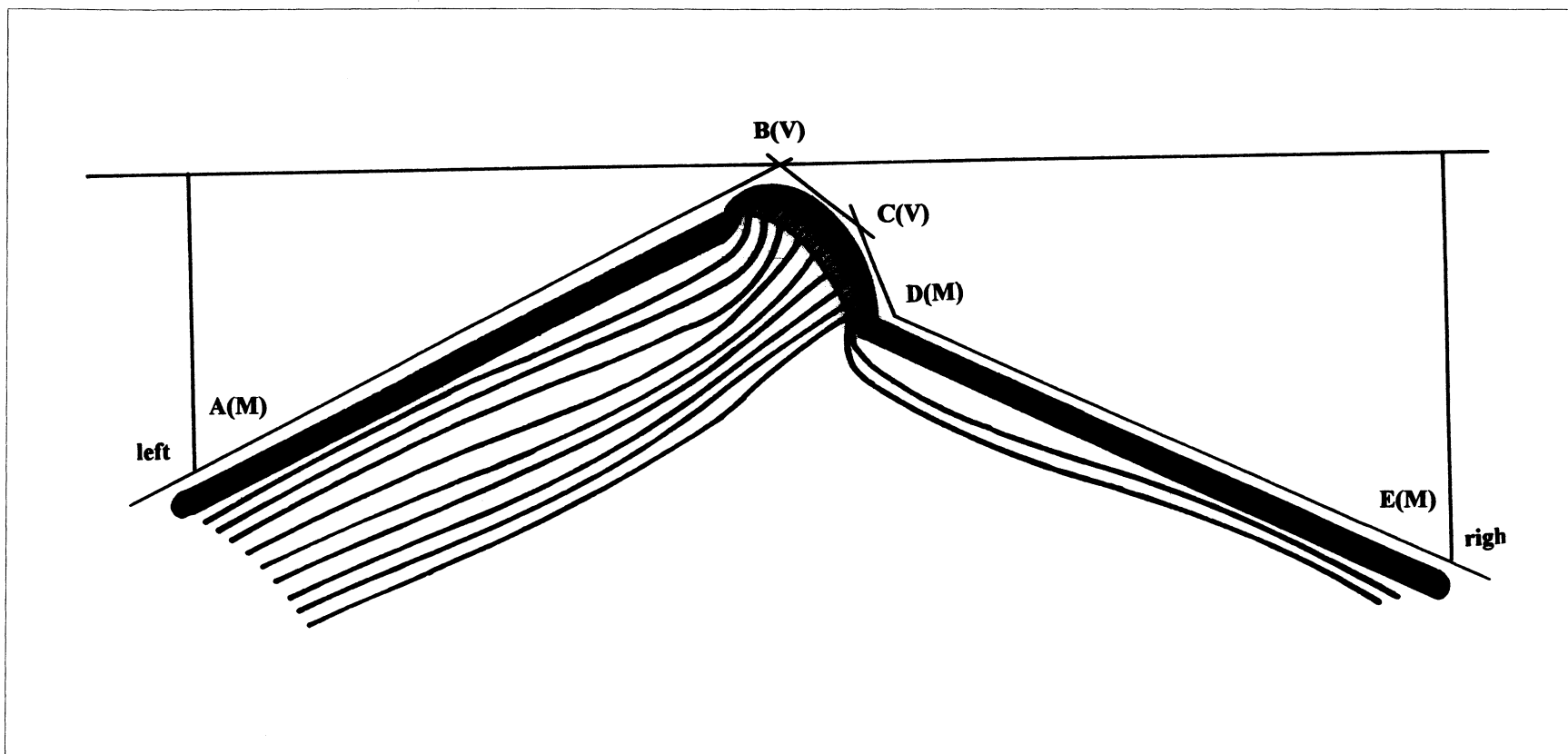

Fig. 5. Labeling cradle sides and angles

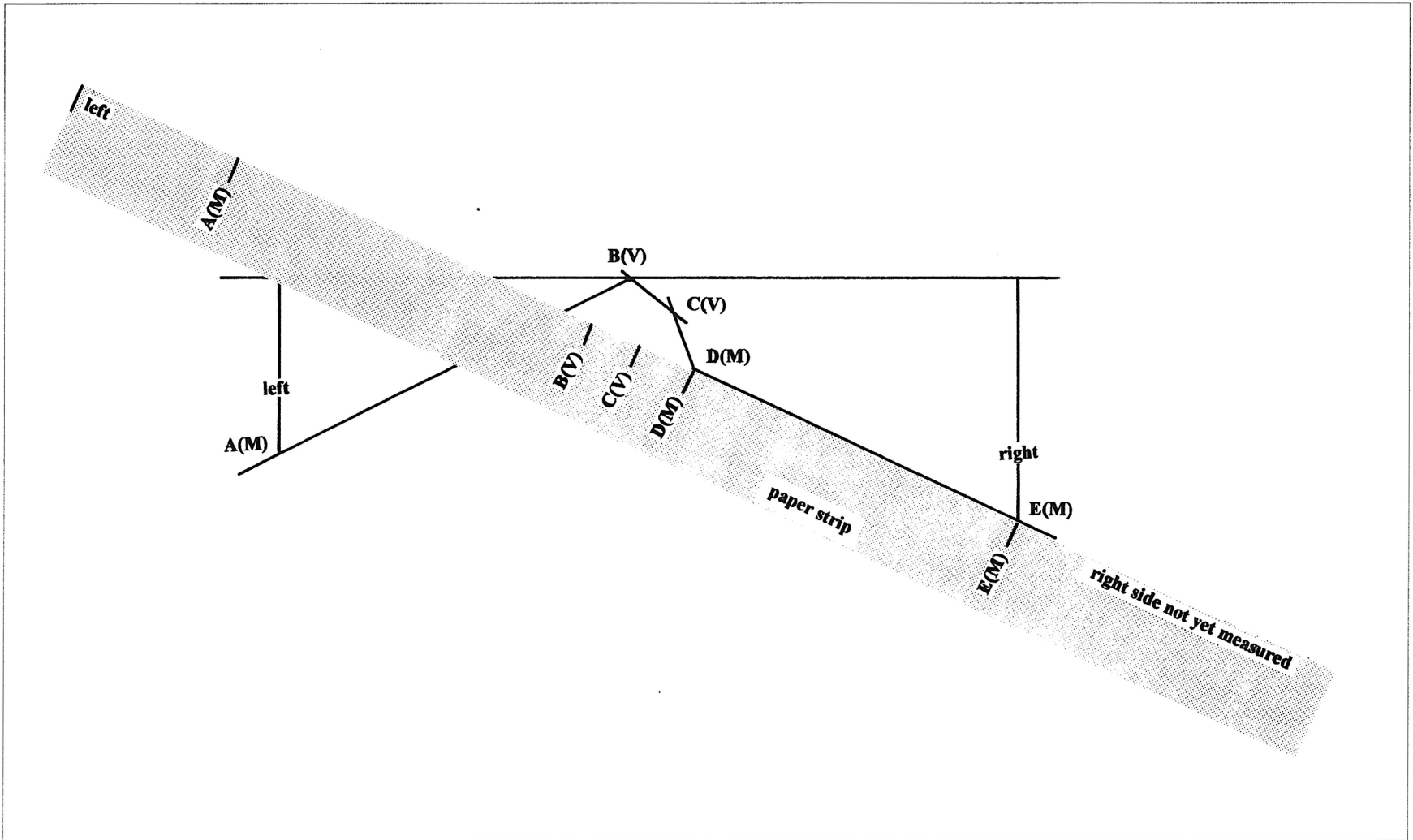

Fig. 6. Expansion of drawing using paper strip

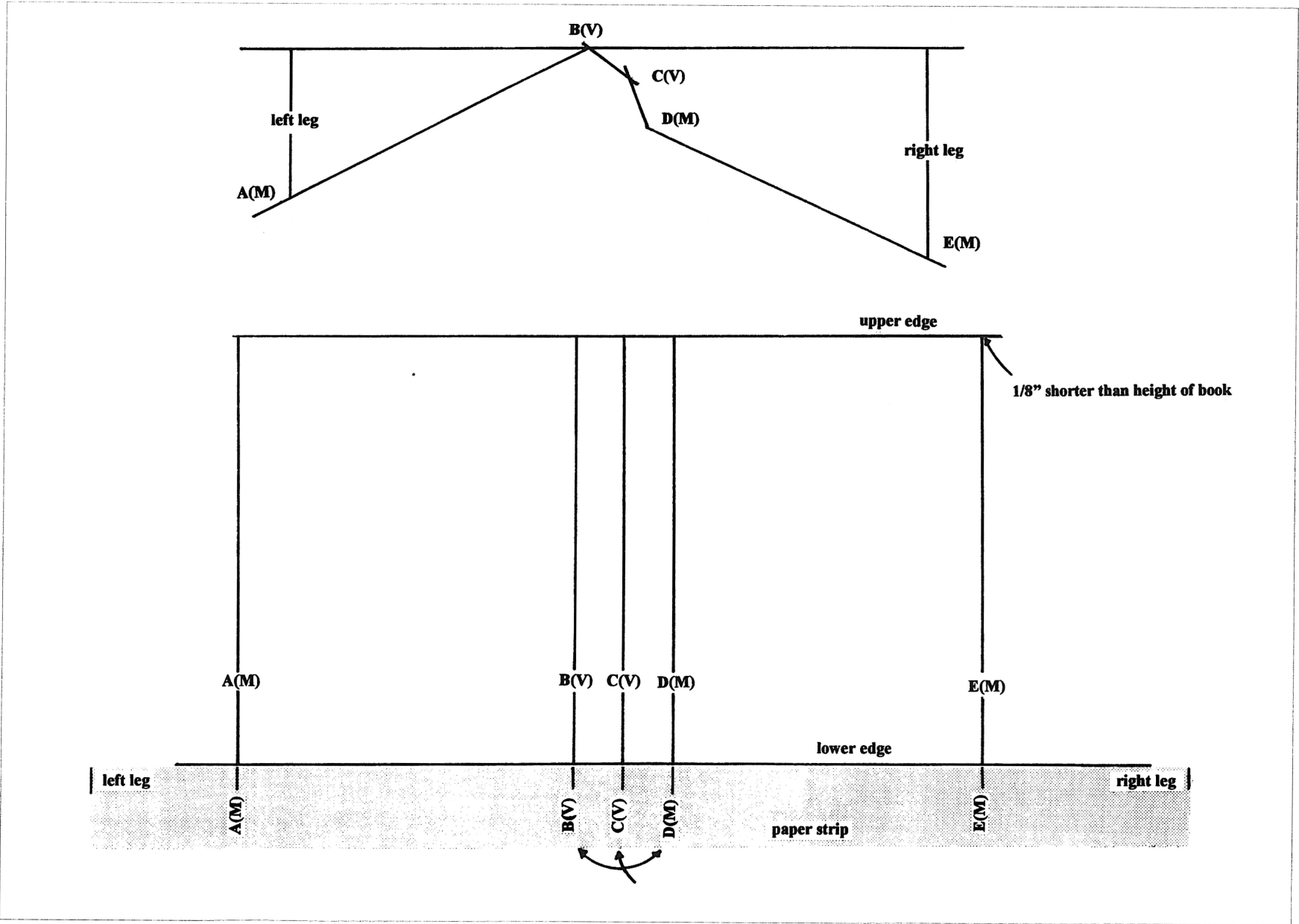

Fig. 7. Implementing drawing expansion

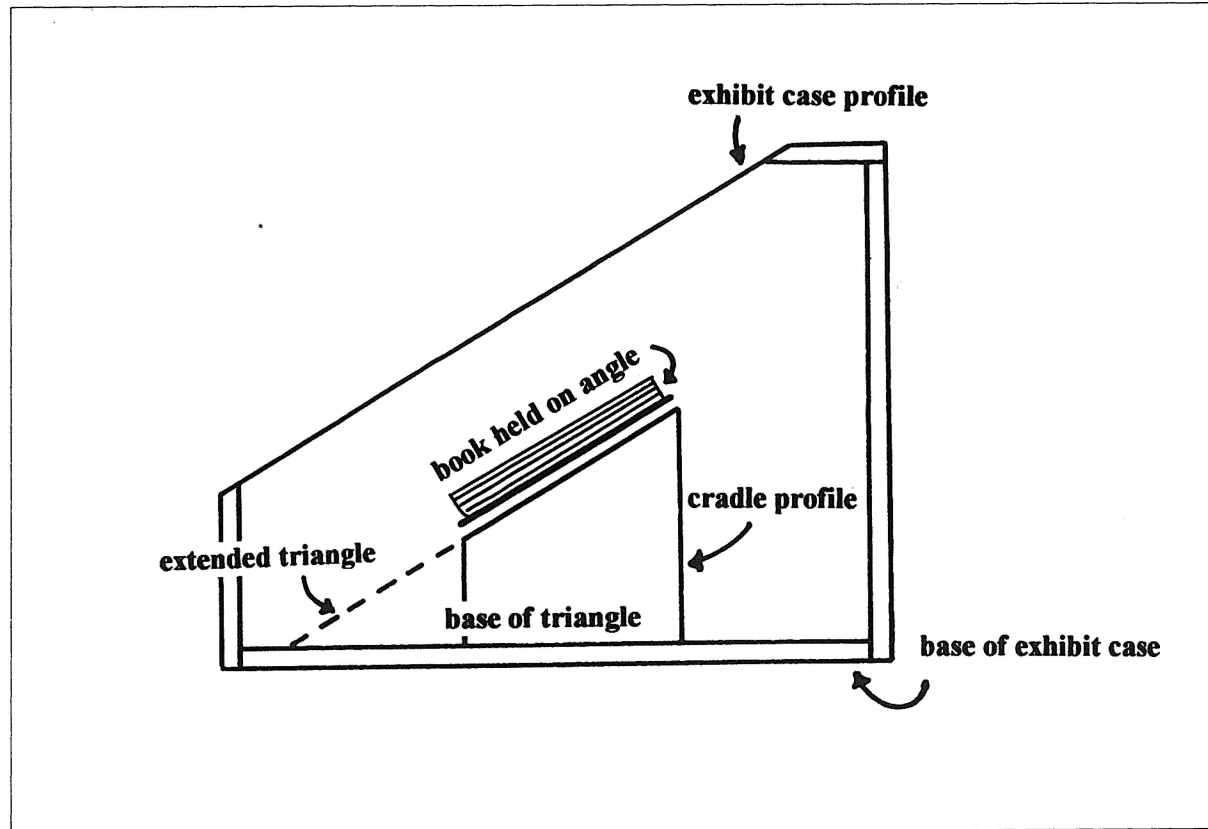

Fig. 8a. Determining of the cradle angle

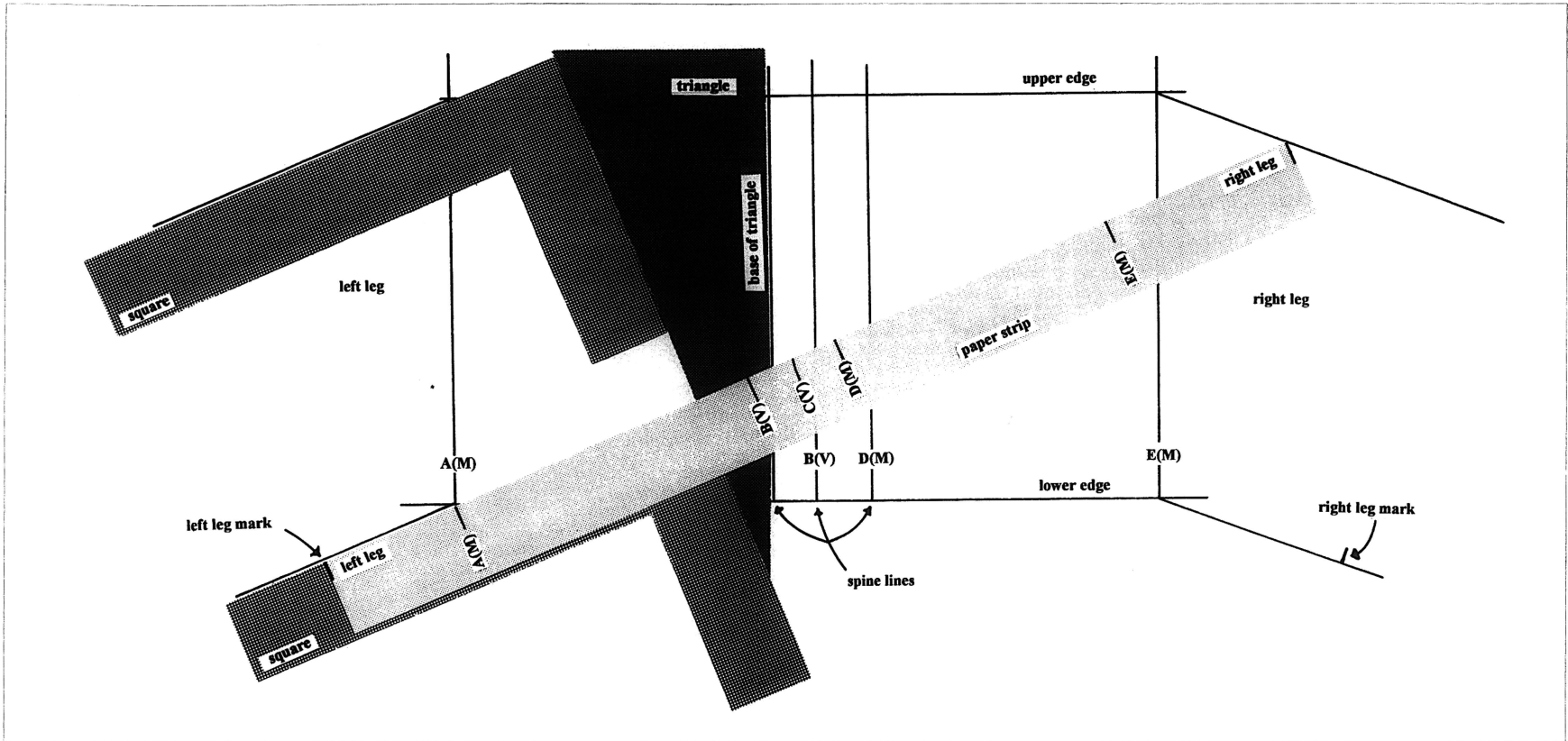

Fig. 8b. Translating predetermined angle to the leg drawing

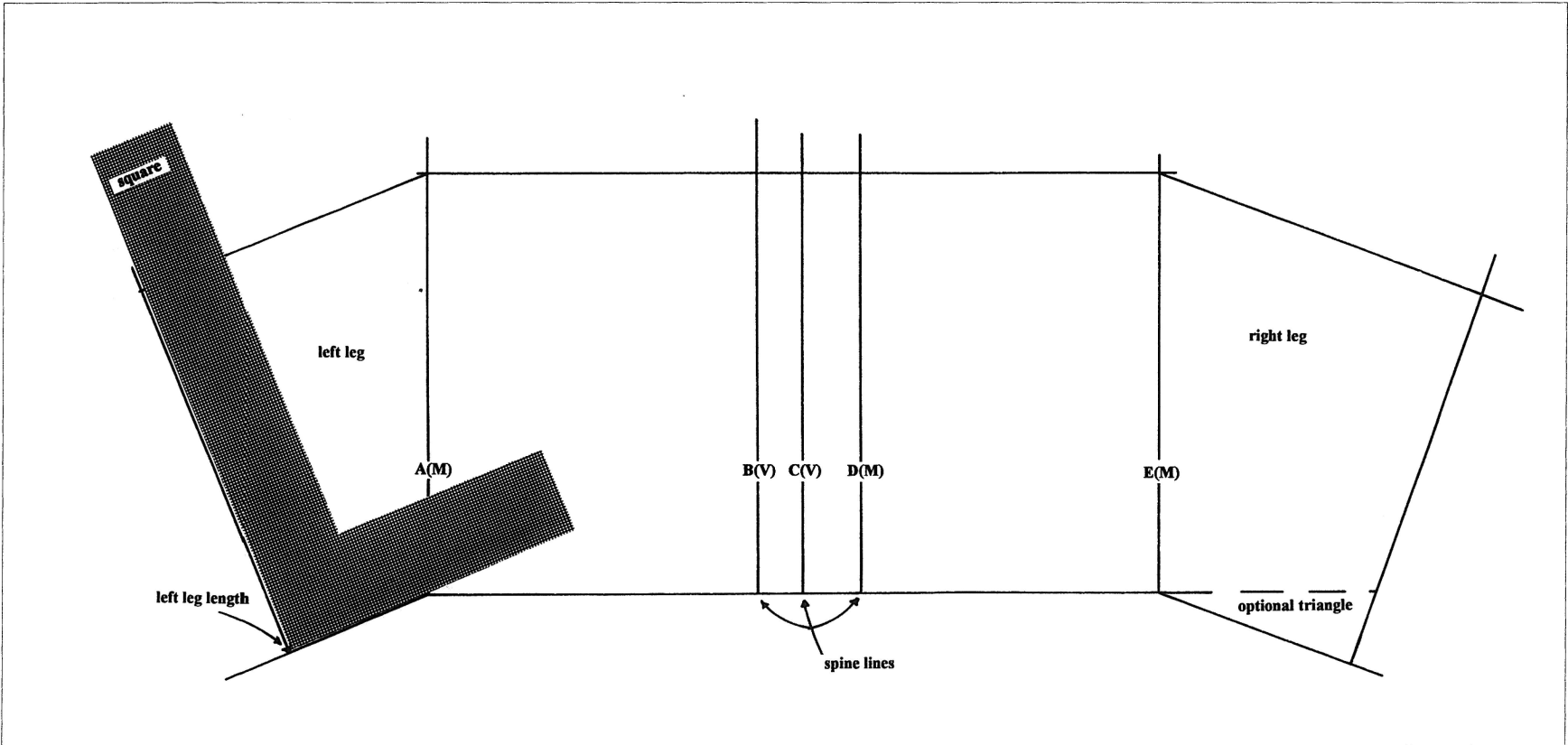

Fig. 9a. Drawing the leg bottoms

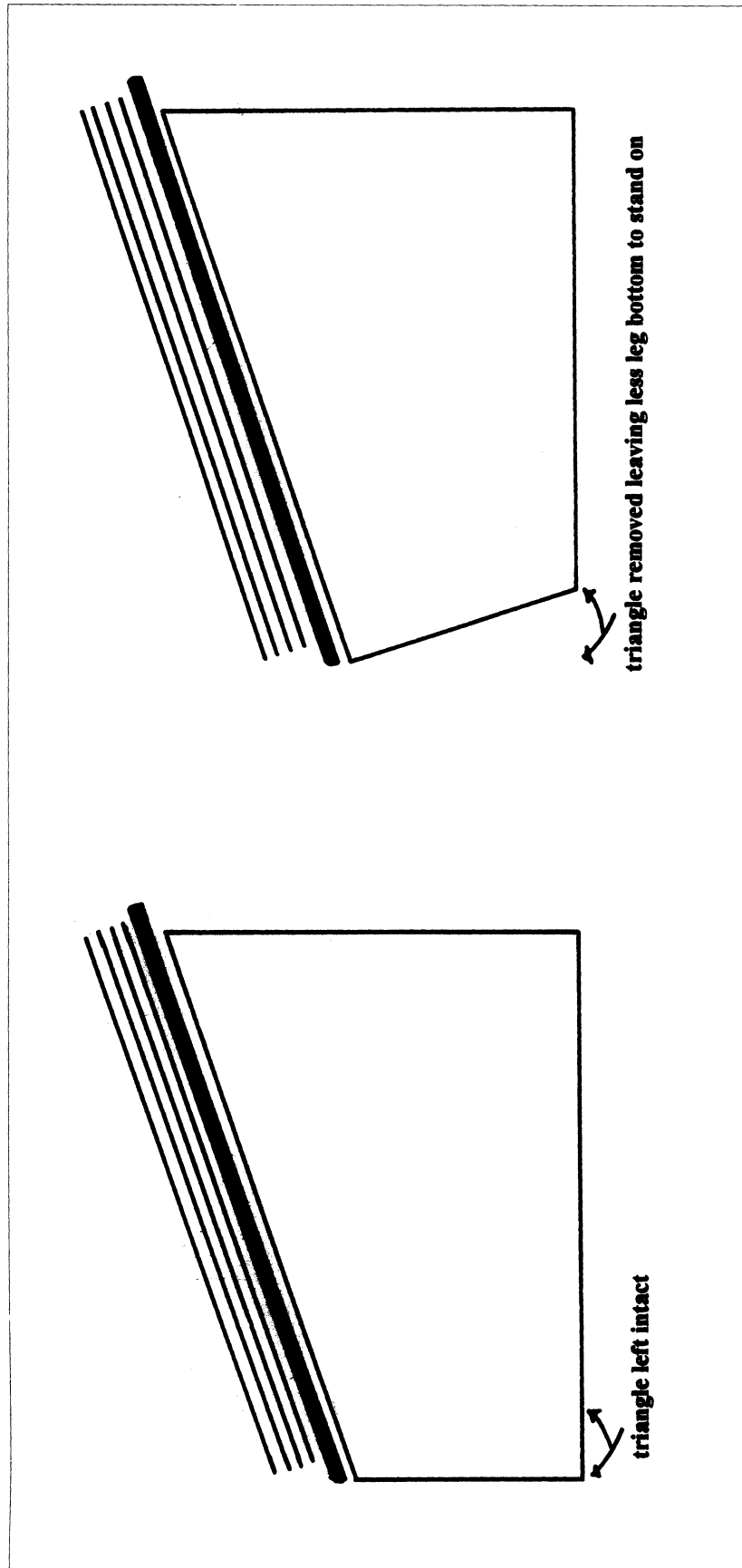

Fig. 9b. Noting importance of removing triangle on lower legs

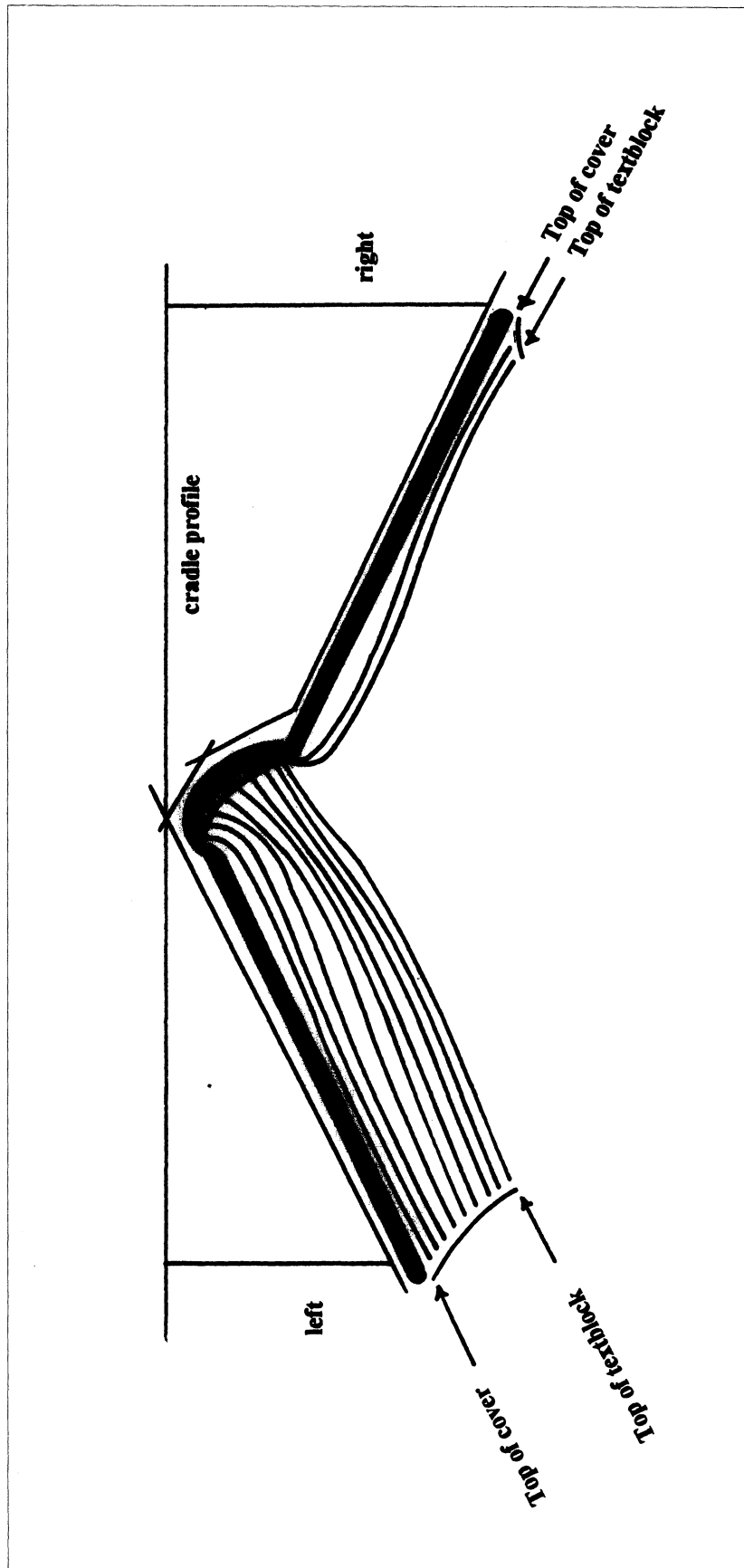

Fig. 10. Marking textblock and cover thickness

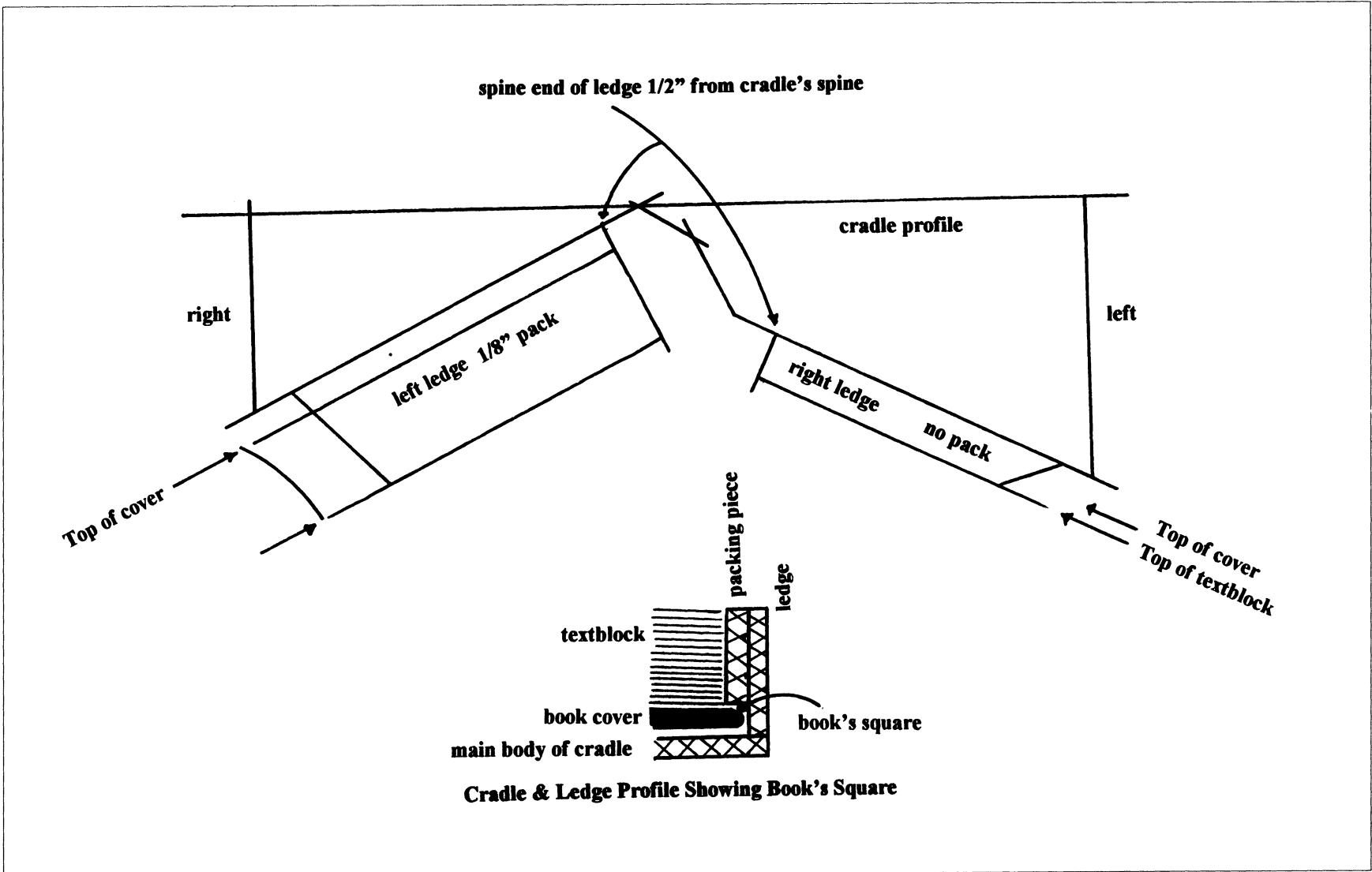

Fig. 11. Drawing ledges and packing pieces

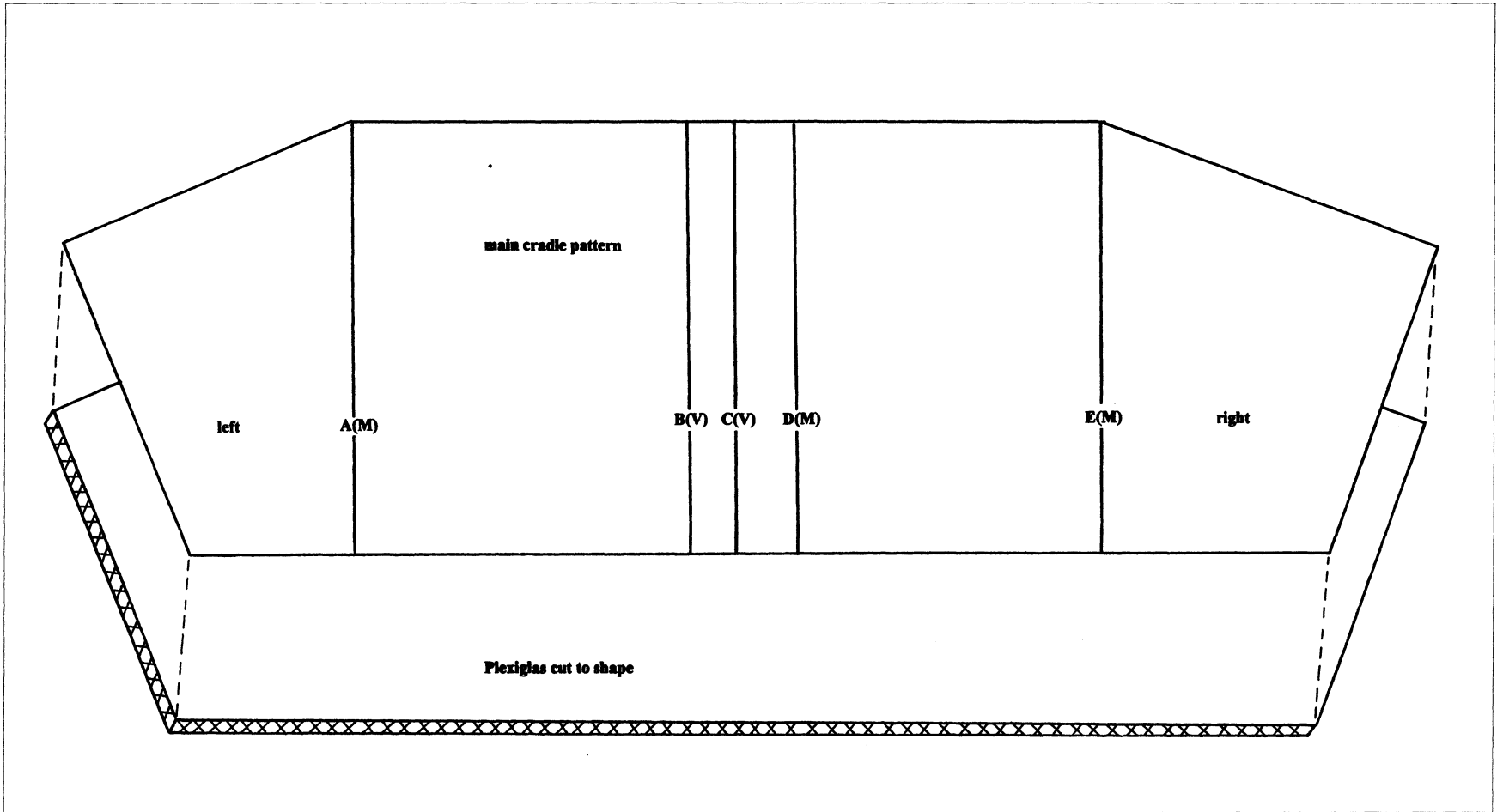

Fig. 12a. Cutting Plexiglas for main body of cradle

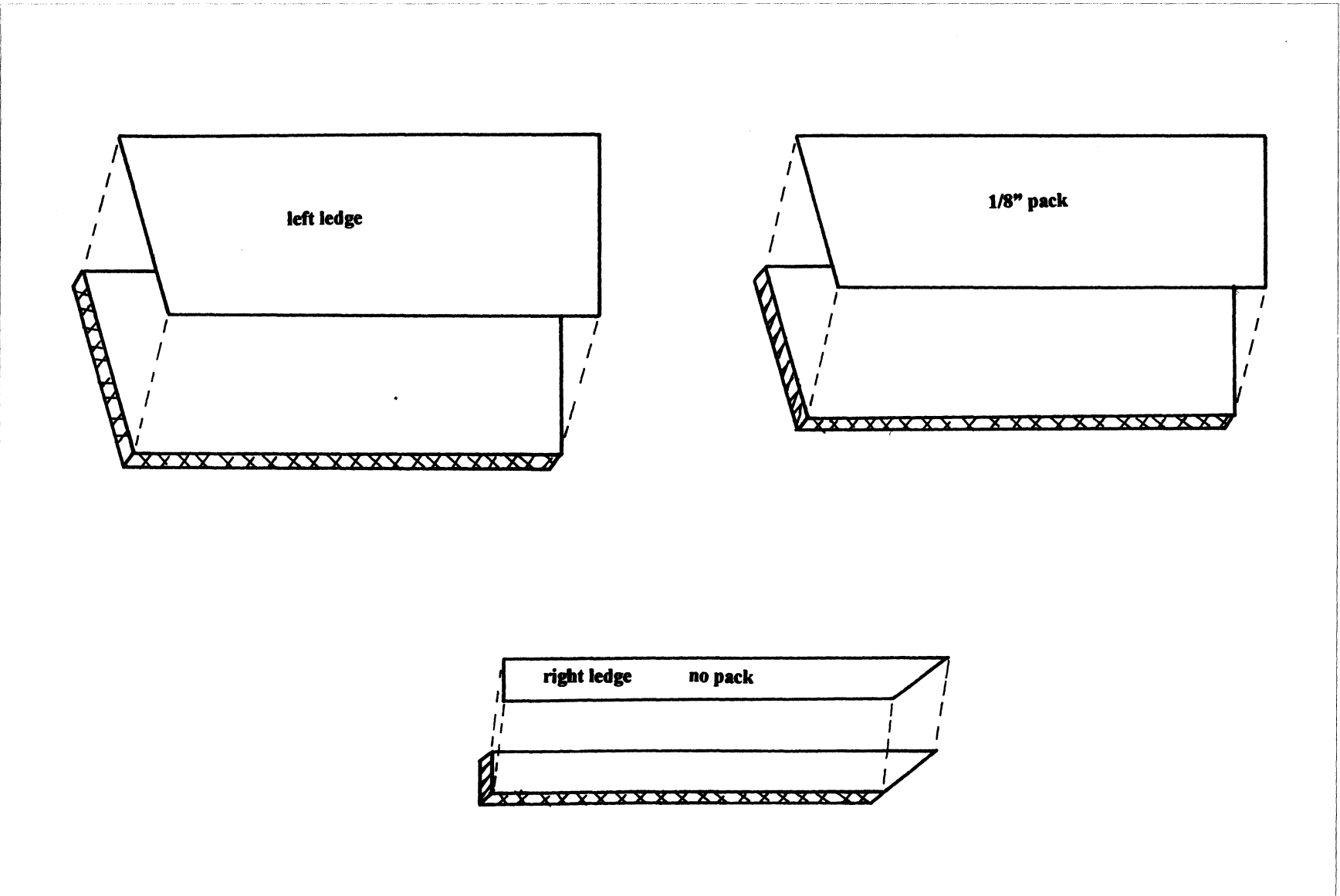

Fig. 12b. Cutting Plexiglas for ledges and packing pieces

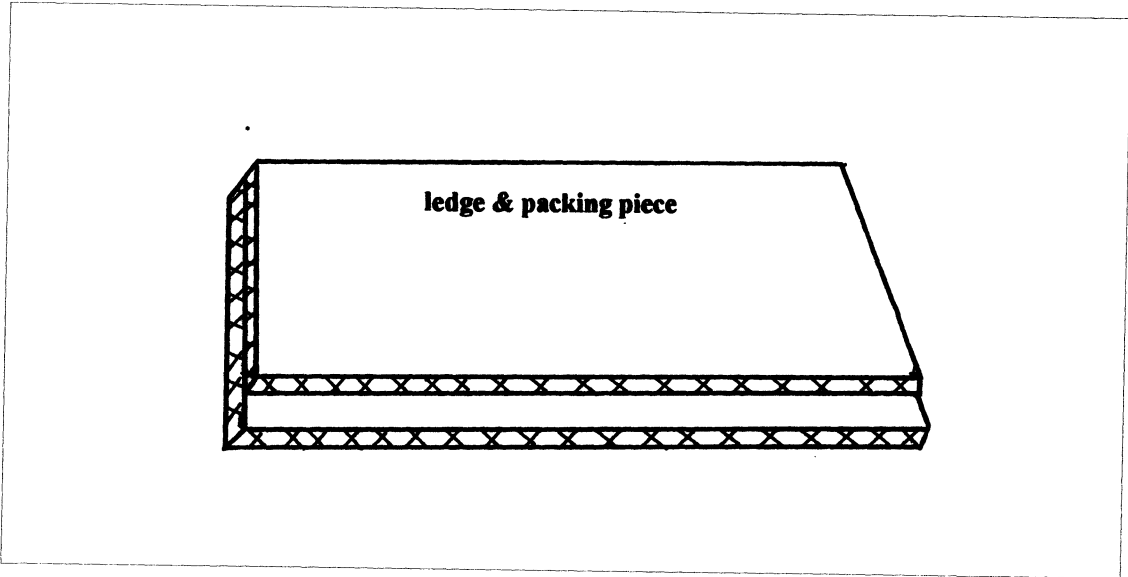

Fig. 13. Laminated ledge and packing piece

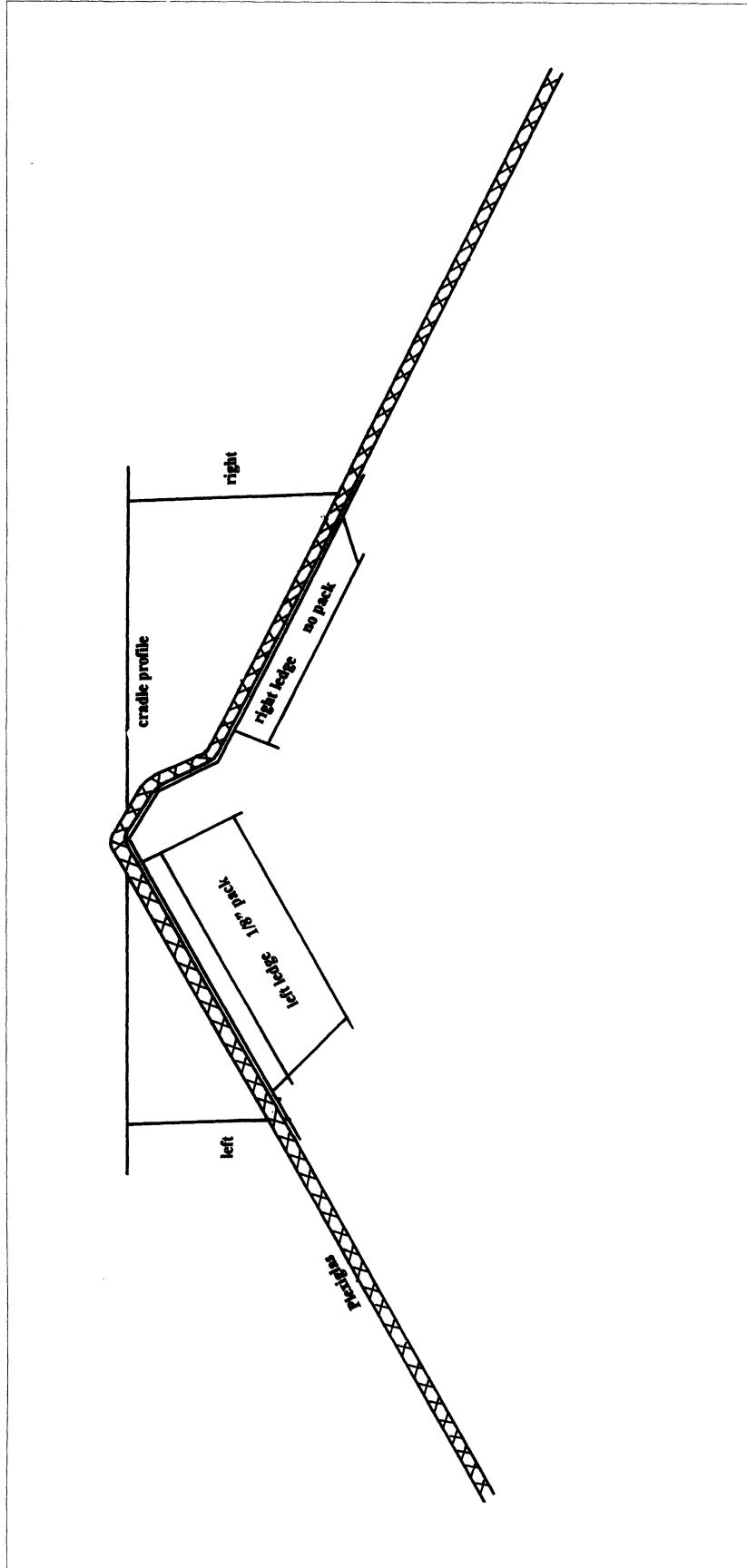

Fig. 14. Folding Plexiglas to match cradle profile

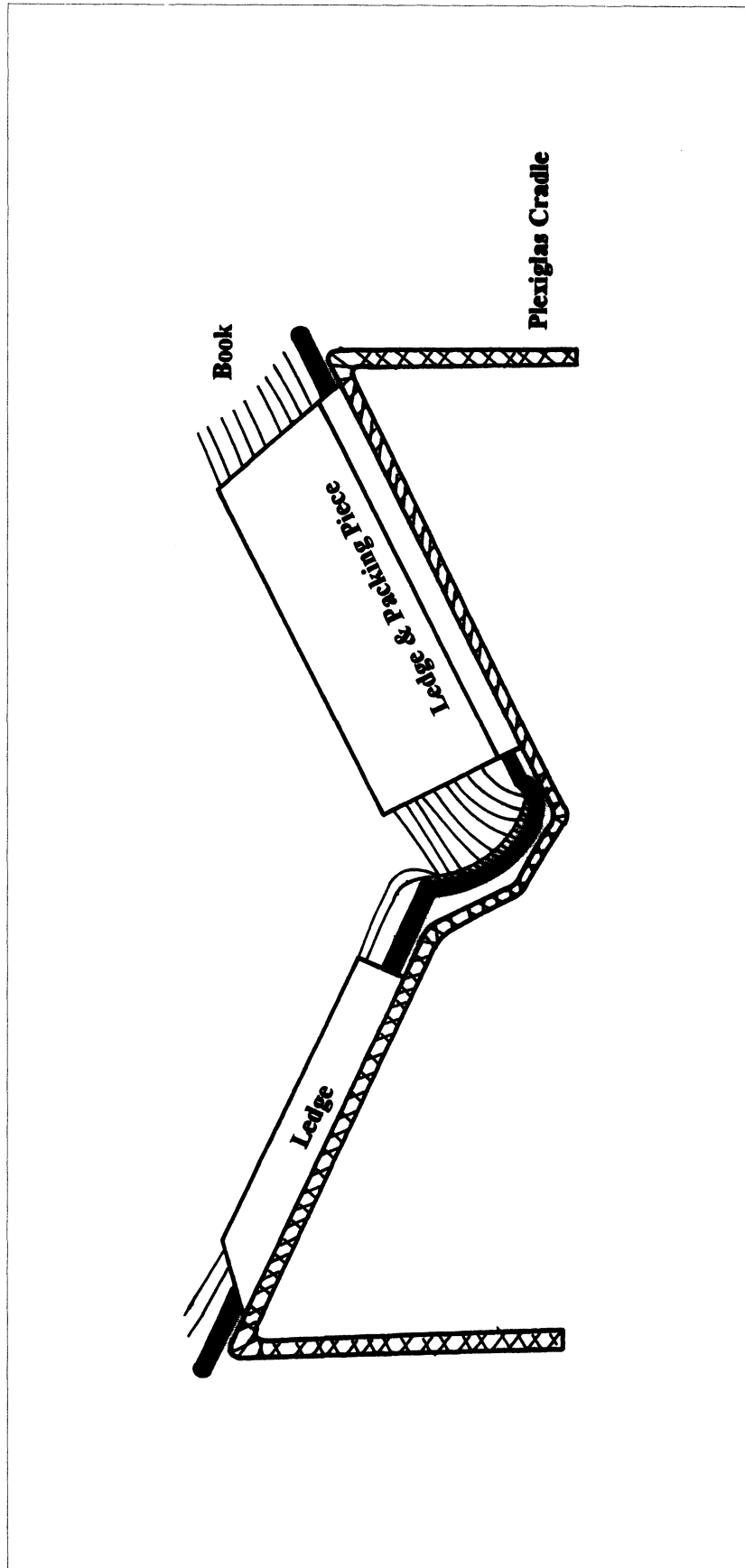

Fig. 15. Book in position on cradle