

## Acidic and Alkaline Sizings for Printing, Writing, and Drawing Papers

### ABSTRACT

This review of paper sizing systems describes a recent, quiet revolution with respect to the chemicals used during the manufacture of paper. Before this revolution the primary means of imparting water-resistance to mass-produced paper involved rosin and alum, the latter of which is highly acidic. During the 1980s, and continuing up to today, there has been a dramatic shift to new sizing chemicals that employ an alkaline buffering system. As a side benefit of this change, most printing, writing, and drawing papers now made in the U.S. tend to be brighter and more resistant to embrittlement during storage. Perhaps surprisingly, however, the roots of the revolution may have had little to do with paper's permanence.

### A TALE OF TWO BUFFERING SYSTEMS

It was the best of times. It was the worst of times. In the years leading up to about 1980 papermakers in the U.S. believed they had a good thing going—and they did. One of the things they had going for them was clay. Clay was first used as a filler for paper in 1807, and such practices had become common by 1870 (Hunter 1947). A typical printing paper made during the 1970s in the U.S. contained 5–10% clay by mass. Prior to recent discoveries in the Amazon region (Halward et al. 1978), the clays from Georgia and South Carolina were regarded as being among the best in the world in terms of making smooth, relatively opaque, and relatively inexpensive papers for printing, writing, and related purposes. Clay is a moderately bright, platy mineral (fig. 1), which is quite easy to collect with steam shovels and to disperse in water without extensive

Presented at the AIC seminar Contemporary Machine-Made Papermaking, October 20–23, 2004, Williamstown, Massachusetts. Received for publication Fall 2004. Color images for this paper are available online at <http://aic.stanford.edu/bpg/annual/>.

grinding required (Slepetys and Cleland 1993). Another important fact about clay is that it is chemically inert. In other words, it can be used both under acidic and alkaline conditions.

### THE BEST OF TIMES

Another good thing that papermakers had going for them at that time, so it seemed, was their system for imparting water resistance to some of their products. When papermakers use the word “sizing” they usually mean one of two things, either adding something to the slurry of pulp fibers to make the resulting paper resist fluids, or applying a viscous solution to the surface of paper. To distinguish these two practices, the addition of hydrophobic materials to the pulp slurry is often called “internal sizing.” The second usage of the term, often called “surface sizing,” will be considered at the end of this paper.

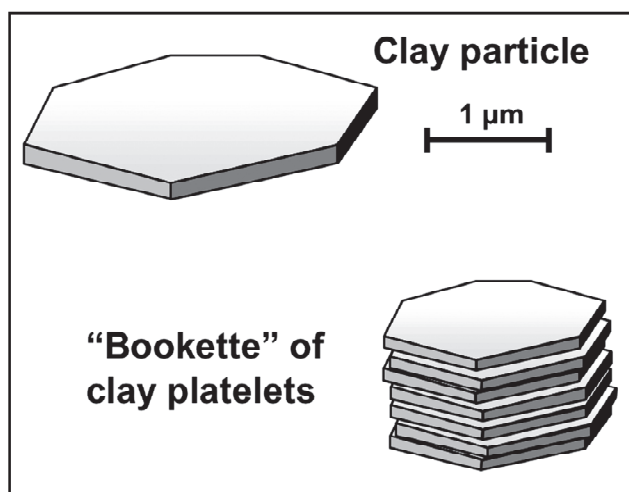

Fig. 1. Schematic illustration of the shape and size of typical clay particles used in the filling of paper.

The traditional way to internally size printing and writing papers during most of the previous two centuries was based on the use of rosin and alum (Strazdins 1989a; Scott 1996). The major source of rosin, as used by papermakers, has been the wood itself. Rosin compounds can comprise as much as 1–2% of the dry mass of wood from a pine tree (Back and Allen 2000). The pitch that tends to ooze from injured areas in the trunk of a pine tree contains a lot of rosin. One of its purposes can be compared to formation of a scab on a wound. Though once it was common to collect rosin from freshly cut stumps in the forest, now most rosin is derived from the industrial process of preparing wood pulp for papermaking (Smook 1992). Indeed, rosin is a component of the “tall oil” that becomes distilled from wood chips as they are “cooked” under alkaline conditions in the kraft pulping process.

Rather than referring to a single compound, the word “rosin” actually refers to a mixture of closely related materials from the wood (Strazdins 1989a). One of the major components of this mixture is abietic acid. As shown in the left-hand side of figure 2, abietic acid has three six-membered rings fused together. Because the rings contain only carbons and hydrogens, most of the molecule is water-hating. The single carboxylic acid group, though it tends to impart water-loving character, is hardly enough to make the rosin molecule as a whole dissolve in water. As we will see later, this group can be the key to anchoring the molecule in place at the fiber surface.

Before it is used in papermaking, most rosin is modified according to the reaction shown in figure 2. This modification was first reported in 1962, and by the 1980s most rosin used in papermaking was fortified with between 2% and 8% of fumeric or maleic anhydride (Strazdins 1989). The reaction product, often called “fortified rosin,” initially contains an additional ring, as shown. Subsequent interaction with water opens up the ring, forming the sec-

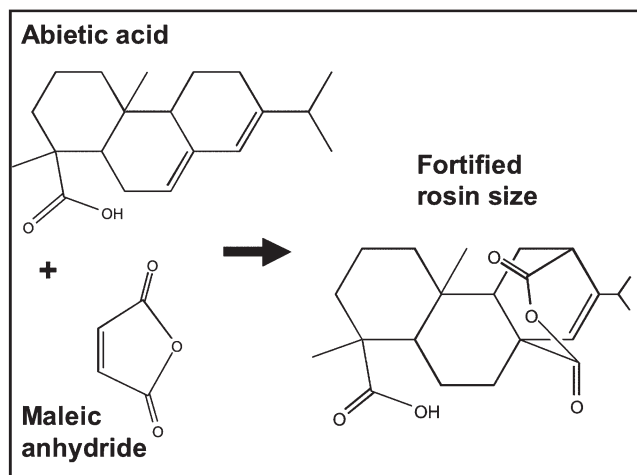

Fig. 2. Abietic acid, a major component of wood rosin, and its reaction with maleic anhydride to form fortified rosin size.

ond and third carboxylic acid group on the molecules. One of the benefits of fortification is a much improved storage stability of the rosin formulation. In addition, the fortification process contributes two additional carboxylic acid functions to the molecule, rendering it much easier to distribute on the fiber surfaces, using either of two preparation procedures. Thus, fortification is expected to decrease the amount of rosin required to achieve certain goals in fluid resistance without noticeable changes in other paper properties. Ordinary, unfortified rosin is susceptible to oxidation, crystal formation, and biological decay. However, it has not been demonstrated whether fortification of rosin affects permanence characteristics.

### Rosin Soap

The simpler and older of the two main formulation strategies for rosin size involves treatment with base to saponify the carboxylic acid groups. The term saponification means that an organic acid, of the type commonly found in natural materials, is converted into its corresponding soap form. The chemical reaction of saponification can be illustrated by the following simplified equation, in which we consider the unfortified form of abietic acid:



The symbol R in equation 1 represents the water-hating hydrocarbon part of the molecule. As is true of soaps in general, the sodium salt of rosin acid is readily dispersed in water in the form of micelles. Each such micelle consists of a cluster of rosin soap molecules in which the hydrophobic parts are bunched together, and the water-loving carboxylate groups face outwards toward the water.

### Rosin Acid Emulsion

The second main procedure for formulating rosin for papermaking applications involves emulsification. In principle, this approach is expected to require a lower addition of aluminum to the process, compared to the soap form for rosin sizing. This translates into a somewhat higher pH range during papermaking, and the rate of embrittlement of the paper during storage also is likely to be slower, in a typical case. In other respects probably it would be difficult to tell, after the paper is made, what type of rosin had been used.

An emulsion consists of droplets of one liquid in another. To form the rosin emulsion, the waxy material is first heated above its melting point. Instead of converting the rosin to its soap form, most of it is kept in its water-insoluble, “free acid” form. In the presence of intense agitation the liquefied rosin is combined with an aqueous solution of a stabilizing polymer. One function of the polymer is to stabilize the resulting droplets of rosin so that they don’t

stick to each other, forming agglomerates due to chance collisions. Most of the polymers now used as stabilizers for rosin size have a net positive charge (Ehrhardt and Gast 1988; Nitzman and Royappa 2003). This charge allows the polymers to perform a second function, helping to retain the rosin on negatively charged fiber surfaces during the papermaking process.

#### Alum, Papermakers' Friend

In the years leading up to 1980 another aspect that made it seem like "the best of times" for U.S. papermakers involved the use of aluminum sulfate, or "papermaker's alum." Alum was sometimes called the papermaker's friend, due to its wide-ranging and dependable effects on the papermaking process. These benefits included not only the development of paper's hydrophobicity (in combination with rosin), but also increased efficiency of retaining small particles in the paper during its formation. Best of all, alum addition often resulted in more rapid drainage of water from the fibers, making it possible to increase the speed of many paper machines.

As illustrated in figure 3, one particularly attractive feature of rosin-alum sizing systems in general is that it is relatively easy to control the level of hydrophobicity imparted to the paper. The left-hand axis of the figure shows the time, in seconds, required for an aqueous solution of dye to penetrate through paper. The horizontal axis shows the amount of rosin size, added together with alum to the fiber suspension before making the paper. The smooth, gentle slope of the results in figure 3 has been an advantage to papermakers, making it relatively easy to achieve the different levels of hydrophobicity required for different paper products, including writing paper, paper for different printing processes, and cup stock, for instance. Note that the alkaline sizes, to be discussed later, show a more abrupt increase in hydrophobic character with dosage.

The invention of the paper machine in 1798 marked a turning point in papermaking practices (Hunter 1947). Figure 4 illustrates the first machine capable of forming a continuous sheet of paper. Though papermakers, as a group, have tended to be conservative, preferring the old ways to the new, the emergence of modern machinery gradually brought changes. Fibers from rags gradually became replaced by wood fibers. The speed of production gradually increased. However, rosin sizing, as well as the use of alum, remained well entrenched in papermaking practice.

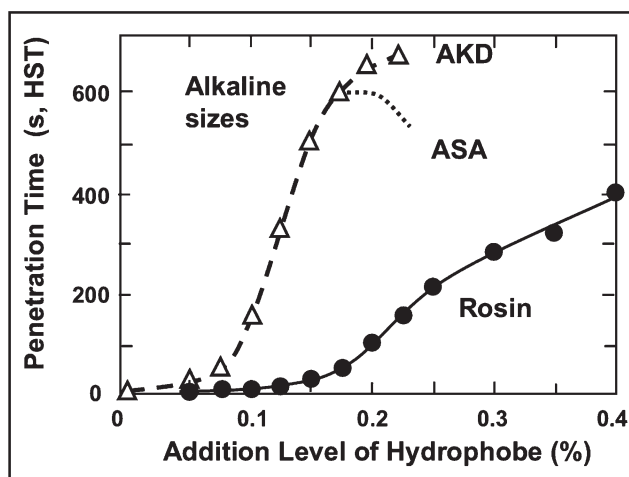

Fig. 3. Effect of sizing agents' addition level on the time required for aqueous solution to penetrate through paper (Royce 1995, redrawn figure).

#### Alum's Buffering System

Had early papermakers been able to guess at the complexity of aluminum's chemistry (Bottéro et al. 1980; Strazdins 1989b), perhaps they would have taken a different view of their "friend." If one adds aluminum sulfate or aluminum chloride to water, it dissociates into  $\text{Al}^{3+}$  ions that immediately begin to react with the  $\text{OH}^-$  ions in the water. The following equations represent some of the most important ionic species of aluminum that are formed in these hydrolysis reactions:



Fig. 4. The invention of the continuous paper machine in 1797, as illustrated by unsigned Italian sculpture in the author's collection.



Because each of these reaction systems consumes  $\text{OH}^-$  ions, it can be said that alum is "acidic" and that it tends to buffer the pH of the system. In other words, addition of either acid or base to the system will shift the equilibria of reactions such as those shown above, and the resulting change in pH will be much less than it would have been in the absence of aluminum ions. For these same reasons it is expected that a water-extract of aluminum-containing paper will be buffered in the acidic range. Even if a conservator bathes the paper in distilled water, the extract pH is expected to remain well below the neutral point.

In addition to the products of aluminum ions and the hydroxyl ions ( $\text{OH}^-$ ) shown above, it is worth noting that the sulfate ion also has a strong ability to complex with aluminum (Matijević and Stryker 1966). Though it is clear that the presence of sulfate ion has a large effect on the behavior of aluminum compounds during the papermaking process—and in other applications such as water treatment—relatively little research work has been reported to quantify the kinds of ions that may be important.

#### Alum's Interaction with Rosin Soap

When papermakers use the "soap" form of rosin, as described earlier, the chemical processes that are important for the development of paper's hydrophobicity take place already in the fiber suspension, before the paper is made. In the most traditional practice the rosin soap is mixed first with the suspension, either in an open-topped tank, or in a pipe, as the suspension is pumped in the direction of the paper machine. Next, a solution of alum is added to the flowing suspension of fibers to "fix" the rosin onto the fiber surfaces. As shown by equation 5, the compound formed between a rosin soap ion and an aluminum ion tends to precipitate out of solution, onto the surface of solids in the suspension (Back and Steenberg 1951; Marton 1989):



In equation 5 the term R is used to represent the hydrocarbon part of the rosin molecule, not distinguishing whether one or more  $\text{COO}^-$  functions from the same rosin molecule are involved. It is worth noting that equation 5 calls for trivalent  $\text{Al}^{3+}$  ions, which are the dominant aluminum species below a pH of about 4.5, depending on the overall concentration and other factors. Indeed, most sizing with rosin soap tends to be done within a pH range of about 3.8 to 4.5, which is quite acidic. Water extracts

obtained from the resulting paper can be expected to be similar in pH.

As a result of reactions of the type represented by equation 5, the rosin is precipitated onto the fiber surfaces. Part of the positive charge of the aluminum ion persists after the reaction, so the aluminum can anchor the rosin on the negative surface of a typical fiber used for papermaking. Meanwhile the hydrophobic part of the molecule is oriented outwards from the fiber surface, as shown in figure 5. Anchoring and orientation of a hydrophobic molecule are said to be two of the key requirements for the efficient hydrophobic sizing of paper.

#### Alum's Interaction with Rosin Acid Emulsion

By contrast, when papermakers rely on the emulsion types of rosin products to reach their sizing goals, the important reactions take place as the paper is dried. Another key difference between the two main strategies for rosin sizing involves the type of aluminum species that are most important. In the case of rosin emulsion sizing, studies have shown that alum can play a key role in retaining the emulsion droplets on the fiber surfaces (Kitaoka et al. 1997). The "polynuclear" ionic species, represented by equation 3, have been shown to be particularly effective in this regard (Bottéro et al. 1980; Arnson and Stratton 1983; Strazdins 1989b). Values of pH in the range of about 4.5 to 6 during the manufacture of paper favor efficient adsorption of such ionic species onto the fiber surfaces. Then, as the paper is dried, the molecules of rosin either vapor-diffuse or spread along the fiber surface to interact with aluminum species. It is not necessary to show another figure here, since the manner of chemical anchoring of the rosin to the surface is essentially the same as in the case shown in figure 5 for rosin soap sizing. Although recent analytical methods can be used to evaluate the evenness of a rosin distribution on a surface (Wang et al. 2000), it seems

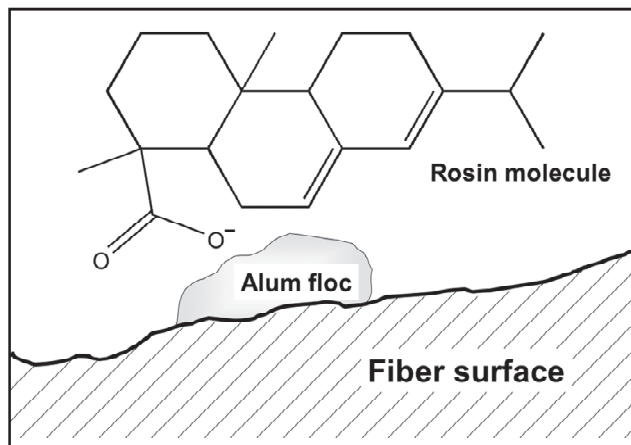

Fig. 5. The anchoring of a rosin molecule at a fiber surface by means of an aluminum compound, which provides a positively charged site.

unlikely that rosin particles would be observable by methods commonly used by conservators.

#### THE WORST OF TIMES

Not everyone was content with the results of acidic papermaking, as described above. In particular, there was growing concern regarding the embrittlement of paper products that were stored for long periods. Conservators noted a surprising phenomenon: the paper in certain books produced in the 1700s seemed to be in much better condition than typical books made during the late 1800s and 1900s (Barrett 1989). Barrett did a comparative study of such cases, extracting the paper with distilled water and measuring the pH. A strong correlation was found between the extract pH of the paper and its tendency to become brittle during storage.

To understand this phenomenon, follow-up work was carried out in which paper was heated in order to accelerate the aging process (Arney and Chapdelaine 1981). Figure 6 shows some results. It became clear from such studies that much of the blame for paper's premature embrittlement can be attributed to acidic conditions. Though there is no doubt that acidity can be contributed by air pollution (Ehrhardt 1990), rosin-alum sizing has probably been a much larger contribution to the problem over the years.

To be fair, acidity is not the only factor that affects the storage-stability of paper. In particular, the aging of paper also tends to become more rapid with increases in moisture and temperature (Du Plooy 1981; Klungness and Caulfield 1982; Wilson and Parks 1982; Waterhouse 1990; Hubbe et al. 2003). Air-oxidation also has been found to accelerate the rate of chemical breakdown of cellulosic fibers during storage (Arney and Novak 1982).

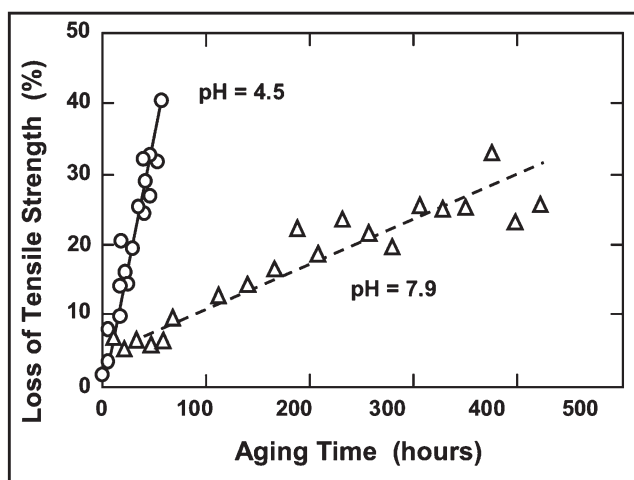

Fig. 6. Loss in tensile strength *vs.* time for newspaper samples prepared under acidic (pH=4.5) and near-neutral (pH=7.9) conditions; Redrawn figure (Arney and Chapdelaine 1981).

#### The Cost of Opacity

Perhaps because they represented only a small fraction of the overall customer base for paper products, librarians and conservators did not at first get much attention when paper's aging problems started to become evident. However, there was an additional issue that was increasingly affecting the papermaker's bottom line. Various paper products generally have tended to become thinner and lighter over the years as papermakers attempt to satisfy their customers with a lower usage of fibers and other materials. A trend in reduced weight per unit area has been apparent in such paper grades as magazine paper, the outer, linerboard layer of corrugated boxes, and lithographic printing papers. Lighter-weight paper is more convenient for shipping. At the same time, the paper still needs to meet certain requirements of opacity so that the end-user isn't disturbed by "show-through" of printed images on the back side of a sheet, or on a subsequent sheet.

Under acidic papermaking conditions one of the main additives used by papermakers to meet increasingly challenging opacity goals has been titanium dioxide. When it is used, typical amounts of  $\text{TiO}_2$  in paper range from zero to about 5%, though higher amounts may be used when making thin, opaque paper for religious texts. The anatase and rutile forms of  $\text{TiO}_2$  are especially good at scattering light. The light scattering ability of different minerals can be quantified in terms of a light scattering index, *s*. The specific light scattering index for  $\text{TiO}_2$  in paper tends to be about 6000  $\text{m}^2/\text{g}$ , compared to about 1500  $\text{m}^2/\text{g}$  in the case of clay filler, and about 200–400  $\text{m}^2/\text{g}$  for the fibers themselves (Middleton et al. 1994).

Despite its strong ability to scatter light,  $\text{TiO}_2$  never achieved the status of "friend" in the papermaker's perspective. Not only does  $\text{TiO}_2$  tend to be expensive, but it also it is relatively hard to retain during the papermaking process, due to the small size of the particles. Special water-soluble polymers called retention aids are typically added to the papermaking mixture in order to retain the mineral in the paper as the sheet is being formed. Once a sheet of paper is dried, any filler particles, including  $\text{TiO}_2$ , are expected to become strongly attached to the fibers. It has been shown that  $\text{TiO}_2$  particles, due to their small size, are very difficult to wash from a surface to which they have become attached (Hubbe 1985). Thus, if a conservator bathes a sheet in mild aqueous solution, the original retention aid chemicals can be expected to prevent release of the mineral particles.

#### A REVOLUTION OCCURS

Before 1980 calcium carbonate already was used sometimes as a filler for paper, especially in Europe (Hagemeyer 1984). It so happened that there were excellent deposits of the chalk form of calcium carbonate that could be mined

in England and Denmark. As is true also for clay, chalk is quite easy to mine, requiring relatively little energy for grinding. European papermakers found that they could reduce their cost of materials by replacing about 10% to 30% of their fiber material with  $\text{CaCO}_3$ . The result of this substitution also yielded a smoother and more opaque sheet of paper. At the same time, increasing filler tends to reduce the stiffness, and surface treatment of the paper may be needed to avoid a chalky feel.

But in the U.S. the only high-quality deposits of  $\text{CaCO}_3$  consisted of limestone or marble, which are hard materials, requiring a lot of grinding energy to convert them into useful papermaking fillers. Also it was known that purified  $\text{CaCO}_3$  products could be formed by precipitation of calcium ions from solution. Cigarette papers were one of the few products that were made with calcium carbonate filler, due to some favorable effects on the uniform burning of the paper.

Then the situation began to change rapidly after the discovery that certain precipitated calcium carbonate (PCC) products were able to yield favorable opacity and bulking effects in paper, while at the same time avoiding the high grinding requirements of limestone (Laine 1980; Hagemeyer 1984). In addition, PCC helped papermakers to avoid the high abrasiveness of the ground limestone (GCC) products that were available during the 1980s. GCC products that contained quartz particles as an impurity caused rapid wear of the paper machine's forming fabric, slitter knives used to cut the paper, and lithographic printing press blankets. Such problems have been greatly reduced in the case of GCC products made more recently, but today PCC remains the dominant  $\text{CaCO}_3$  product for paper filling in the U.S. Because of the shift towards calcium carbonate, the majority of white paper grades, both coated and uncoated, are now produced under neutral to alkaline conditions. Certain unfilled products, such as boxboard and various specialty paper grades, continue to be made under acidic conditions.

In the process of preparing PCC, the first step is, ironically, to heat up the original  $\text{CaCO}_3$  obtained from the mine, driving off carbon dioxide gas in a process called "calcination." The process can be represented as follows:

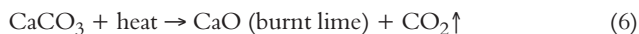

Because the resulting "burnt lime" weighs only 56% as much as the original limestone, shipping costs can be greatly reduced. The next steps are often carried out at the point of paper manufacture in a so-called "satellite" production facility. The satellite production concept became very popular after it was demonstrated that  $\text{CO}_2$  gas from smokestacks could be recovered and used in the process. Most often, the  $\text{CaCO}_3$  is reconstituted from lime in a two-step process represented by equations 7–8:

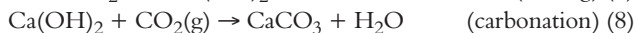

During the steps of the precipitation process it is possible to exclude some of the abrasive impurities, such as quartz, that were present in the original mined  $\text{CaCO}_3$ . However, a more striking benefit of the precipitation process is an ability to control the shape of the resulting PCC (Gill and Scott 1987; Hubbe 2004). This is done by controlling such factors as the temperature and various ion concentrations during processing. Figure 7 contrasts the shapes of three of the types of  $\text{CaCO}_3$  filler particles in widespread use. The "rosette" (scaleno-hedral) shape is favored by papermakers who are making products such as xerographic paper, which need to be relatively stiff and opaque to perform their function. Papermakers wanting to produce products having a higher apparent density favor the less bulky forms of  $\text{CaCO}_3$  filler.

#### Paper's Antacid Pill

In addition to its various industrial roles,  $\text{CaCO}_3$  also is the active ingredient in many of the most popular antacid tablet products. As shown in figure 8, placement of  $\text{CaCO}_3$  into an acidic solution causes it to dissolve. The dissolution process can be described chemically as follows:

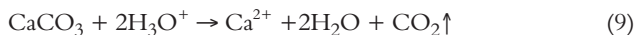

It is worth noting that equation 9 involves evolution of carbon dioxide. If the  $\text{CO}_2$  is released as gas, the reaction is essentially reversible. However, the  $\text{CO}_2$  also can be partly dissolved in the water (Evans et al. 1991; Rauch and Sangl 2000). Because acidity is consumed in the dissolution of  $\text{CaCO}_3$ , the filler can act as an effective buffer against the lowering of pH. Papermaking systems that con-

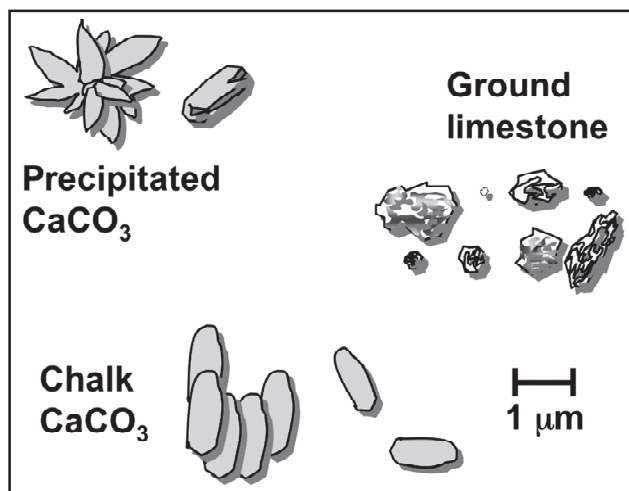

Fig. 7. Schematic illustration of shapes and sizes of typical calcium carbonate particles used in the filling of paper.

tain significant amounts of  $\text{CaCO}_3$  tend to have pH values in the range of about 7.0 to 9.0, though somewhat lower pH values can be achieved by careful addition of acidic materials, or the addition of phosphate ions (Pang et al. 1998). While pH values higher than 9.0 during the papermaking process would be considered unusual, it is worth noting that the presence of calcium carbonate does not place any upper limit on the pH of the system.

#### Slower Aging of Paper

Among the benefits of so-called “alkaline papermaking” with  $\text{CaCO}_3$  has been a marked reduction in the rate of deterioration of paper strength (McComb and Williams 1981; Lyne 1995). One example of this kind of benefit is shown in figure 9 (Lyne 1995). In this experiment different samples of light-weight-coated (LWC) magazine papers were exposed to accelerated aging conditions of 90°C and 50% relative humidity. Two samples of paper manufactured under acidic conditions with alum (circles) were compared with two LWC samples prepared under alkaline conditions in the presence of  $\text{CaCO}_3$  filler (triangles). As shown, the folding endurance of the acidic paper samples deteriorated to zero in less than 32 days of aging, whereas the alkaline papers lost only about 30%–40% of their folding endurance when subjected to the same conditions of storage. It is worth noting that one of the LWC samples prepared under acidic conditions started out with the highest strength.

#### THE NEW pH REGIME FACES CHALLENGES

The first and most critical challenge faced by the new alkaline buffering “regime,” inherent in the use of calcium carbonate filler, involved the ineffectiveness of rosin sizing under those conditions. The reasons why conventional

rosin sizing does not work at high values of pH can be traced back to the reactions shown in equations 4–5, and they involve the chemical forms of aluminum and rosin. For effective sizing to occur, it is first necessary that the aluminum be present in the form of multivalent positive ions. However, above a pH of about 6 almost all of the aluminum becomes converted to neutral “alum flocc” (eq. 4). This uncharged form of aluminum is unable to interact with rosin soap (eq. 5), and also it is not efficient as a retention aid for rosin emulsion products.

#### Cationic Rosin Formulations

Faced with the challenge of achieving sizing at pH values in the neutral to slightly alkaline range, suppliers of rosin products responded with new formulations. Among the most successful approaches involved the use of highly cationic polymers for the stabilization of rosin free-acid emulsion sizing agents (Ehrhardt and Gast 1988; Nitzman and Royappa 2003). The polymers used for stabilization of such emulsions included polyamidoamine-epichlorohydrin, a well-known wet-strength resin. The cationic charge imparted to the emulsion droplets by such polymers allows them to be retained with satisfactory efficiency on fiber surfaces during paper formation. Efficient sizing with this kind of rosin emulsion system has been demonstrated within the pH range of 5 to 6.5, and even into the weakly alkaline range in certain cases.

Unfortunately, retention of the rosin was not the only problem faced by the manufacturers of those products. Another key problem was undesired saponification (eq. 1). Though it is true that rosin soap (i.e. saponified rosin) is widely used for the sizing of paper, soap sizing is best carried out at even lower values of pH, ideally within a pH range of about 4 to 5. Still, there has been some success in implementing emulsion-type rosin sizing systems under

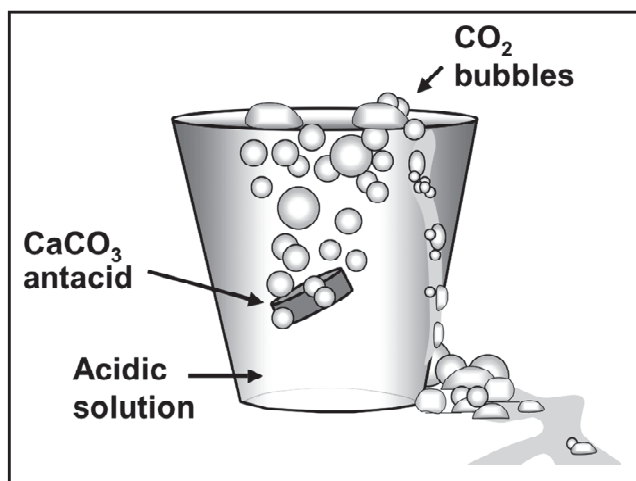

Fig. 8. Schematic illustration of foam generation resulting from the addition of calcium carbonate to an acidic aqueous solution.

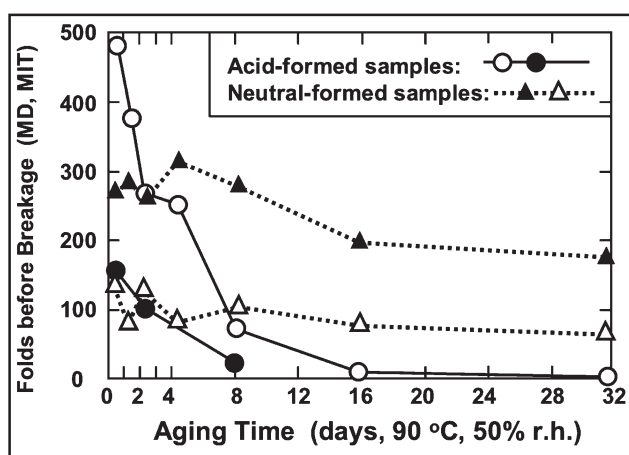

Fig. 9. Loss in folding endurance vs. time for light-weight-coated papers formed under acidic (circles) and near-neutral (triangles) conditions; figure redrawn (Lyne 1995).

neutral or alkaline conditions by employing such measures as minimizing the time of contact between the rosin emulsion and the fiber slurry, pre-mixing of the rosin with aluminum compounds, and replacing some of the rosin with esterified forms of rosin that are not subject to saponification.

#### Alkylketene Dimer (AKD) Sizing

The first "alkaline sizing" system became established in Europe, where the chalk form of  $\text{CaCO}_3$  has been widely used as a filler for many years. The hydrophobic additive was alkylketene dimer (AKD), which was developed in 1956 (Neimo 1999). This chemical compound is a waxy material that can be produced from fatty acids, as found in vegetable oils. In order to be able to distribute and retain AKD during the paper forming process, AKD is always emulsified in the presence of a cationic polymer, using basically the same strategy as already has been described for rosin emulsion products.

The sizing of paper with AKD does not require the use of aluminum compounds. From the papermaker's viewpoint, this is a good thing, since the aluminum compounds in question are acidic, and alkaline conditions are needed for the best curing of the AKD size. Surprisingly, however, there are other reasons why alum and related additives are still used during alkaline papermaking with AKD. These include more efficient retention of fine particles, easier release of water during the formation of the paper sheet, and better control of pitch deposits on the papermaking equipment (Farley 1992; Öhman et al. 1997).

In the case of AKD sizing it is widely agreed that the key processes involved in imparting hydrophobic character to the fiber surfaces occurs as the paper sheet is being dried. For instance, it has been proposed the reaction shown in figure 10 occurs between an AKD molecule and an OH

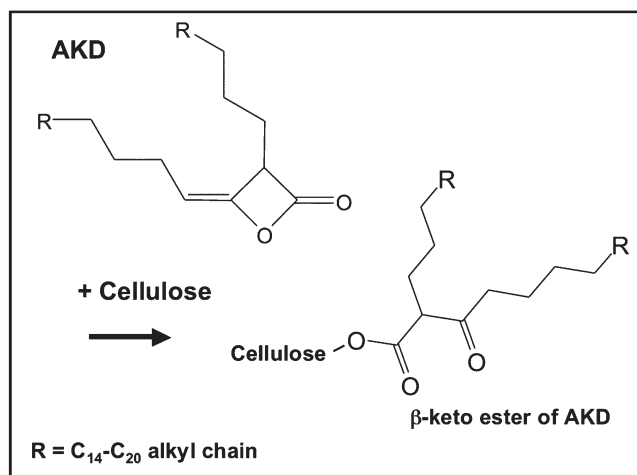

Fig. 10. Hypothetical reaction between alkylketene dimer (AKD) and fiber surfaces, expected to impart sizing effect as the paper is being dried.

group at the fiber surface (Ödberg et al. 1987; Bottorff 1994). The beta-keto ester provides a covalent attachment of the hydrophobic molecule to the fiber surface. As in the case of rosin emulsion, described earlier, the primary means by which the AKD molecules spread over the fiber surfaces is a combination of vapor diffusion, plus some limited migration of molecules along the surface (Akpabio et al. 1987; Yu and Garnier 1997; Shen et al. 2002).

In addition to the reaction shown in figure 10, the AKD molecules used in the sizing of paper can suffer a variety of different fates (Bottorff 1994). Most importantly, due to a relatively low reactivity of AKD, some of it still may be found in its unreacted form immediately after paper is made. A proportion of this unreacted AKD can gradually interact with the paper surface, increasing the level of hydrophobicity as the rolls of paper gradually cool. These changes ordinarily will not be apparent to the user, since little curing takes place after the paper has cooled. In addition, part of the AKD may become decomposed by reaction with water, as shown in figure 11, losing its ability to contribute hydrophobicity to the paper. Also, some of the AKD can decompose into a polymeric form, which is not expected to be efficient as a sizing agent.

Some of the major advantages of AKD as a sizing agent include its ability to develop high levels of water resistance and its good chemical stability, making it possible to deliver the product to its point of use as a concentrated dispersion. Possible disadvantages of AKD include the fact that it does not completely cure under ordinary conditions of paper drying, and high levels of AKD can result in slippery paper. Although such materials can be removed from the paper surface with an organic solvent, none of the products of AKD sizing are likely to be removed by bathing of paper with water as part of a conservation procedure.

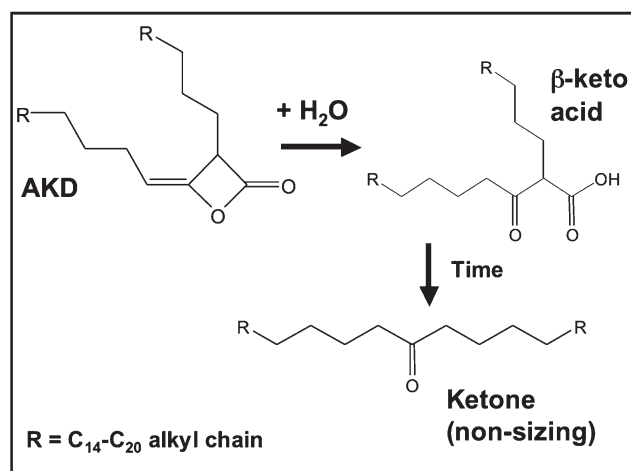

Fig. 11. Competing reaction in which the AKD molecules may become hydrolyzed to an unstable intermediate, eventually forming a ketone.



### Alkenylsuccinic Anhydride (ASA) Sizing

The second widely used sizing chemical suitable for neutral and alkaline papermaking conditions is alkenylsuccinic anhydride (ASA). This product was first developed for paper sizing in 1974 (Hodgson 1994), and it became widely used during the 1980s, especially in the U.S. ASA is produced by reacting maleic anhydride with petroleum-derived alkenes having chain lengths in the range of about 14 to 20. The resulting mixtures of compounds usually are liquids at room temperature, and they can be converted readily to emulsions by addition to a solution of cationic starch, with high agitation.

The most notable characteristic of ASA, compared to AKD, is its much higher reactivity (Dumas 1981; Wasser 1987; Hodgson 1994). The two main reactions of ASA are shown in figure 12. On the one hand, ASA reacts quickly and completely with the fiber surfaces during the drying of paper, achieving a complete cure. The high cure rate is related not only to the higher reactivity of the anhydride ring, but also to the lower molecular mass of ASA, compared to AKD, allowing it to vapor-diffuse more rapidly to sites on the fiber surfaces (Back and Danielsson 1991). On the other hand, ASA decomposes so rapidly in the presence of water that the emulsion needs to be prepared “on-site” immediately before its use. Also, the ASA tends to gradually become hydrolyzed as soon as it is added to the fiber slurry (Wasser 1987; Yu and Garnier 2002). For this reason, papermakers who use ASA need to use effective chemical programs for retaining the fine solids, and other associated materials, thus minimizing the amount of ASA that becomes recirculated several times in the water system of the paper mill.

The quick curing of ASA is of particular advantage for the production of surface-sized paper, since the ASA treatment then makes it possible to control the penetration of

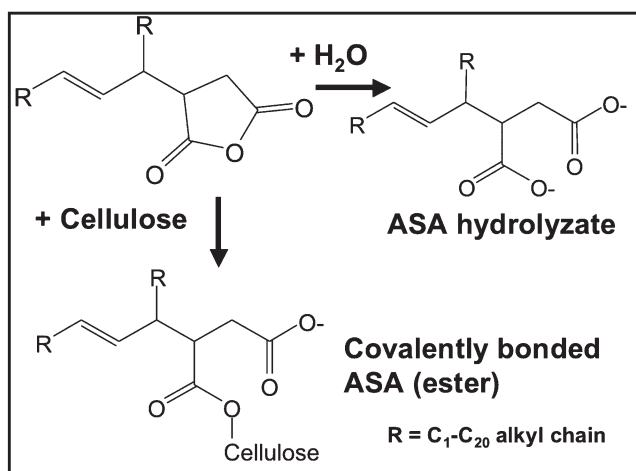

Fig. 12. Reactions of alkenylsuccinic anhydride (ASA), resulting either in the hydrophobation of paper surface or the formation of a hydrolyzate.

surface-applied starch solution. ASA is often preferred, relative to AKD, for this purpose, since the latter agent usually is not completely cured before the paper enters the size press. However, the sizing effect tends to be somewhat less durable than what can be achieved with AKD. ASA has become especially used for the production of cut-size printing and converting papers. In such applications it is very important to achieve a high precision of cutting, and the slippery nature of AKD can be a significant issue.

### Surface Sizing

The story of paper sizing would not be complete without a description of “surface sizing,” the process of applying a film of starch or other materials to the surface of paper. As early as 700 A.D. it was common to spread a layer of animal glue or starch onto the surface of paper that was intended for writing (Hunter 1947). Today almost all printing and writing papers are surface-sized with starch. Corn and potato starches are mainly used in the U.S., though tapioca, wheat, and rice starches also have been used. Before use, the starch is heated in water to form a solution, and also it is treated with an enzyme or an oxidizing agent to improve its flow properties. Equipment called a “size press” is used to spread the starch as a solution of about 10% solids onto the paper surface.

The most important purpose of surface sizing usually is to increase the surface strength of paper. This is especially important in the case of papers that need to withstand the forces of tacky inks in lithographic printing. Also, starch applied to the surface of paper helps to compensate for the effect of fillers, such as calcium carbonate, in decreasing the strength of paper. For instance, the surface of filled paper sometimes can be described as “dusty,” especially in the absence of surface sizing. Especially after the advent of alkaline papermaking there has been a trend towards higher levels of fillers, and this trend, by itself, would be expected to decrease paper strength properties in general. A layer of starch on the top and bottom surfaces of paper can partly compensate for the strength loss.

As shown in figure 13, during surface sizing a viscous solution of starch is spread over the newly formed paper surface as the sheet passes through a nip between two solid rolls. The amount of material taken up by the paper depends on such factors as the solids content of the solution, its viscosity, the paper’s roughness and porosity, and the degree to which the paper has been made hydrophobic by the use of internal sizing agents such as rosin, AKD, or ASA (fig. 14). Indeed, papermakers often optimize the level of internal sizing in order to control how far the starch solution penetrates into the paper at the size press (Tompkins and Shepler 1991; Brungardt 1997). Complete penetration is highly undesirable, since the re-wetted paper can stretch uncontrollably, or even break. A high level of hold-out usually maximizes both surface strength

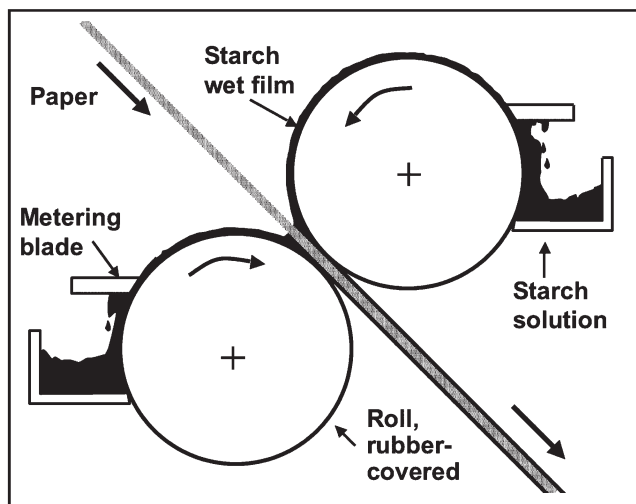

Fig. 13. Schematic illustration of a blade-metering size press used to spread starch, as an aqueous solution, over the paper surface.

and the stiffness of the resulting paper. Intermediate penetration is often best for maximizing the uptake of starch film at the size press. In this way, intermediate use of internal sizing agent can maximize properties such as tensile strength and the ability of the paper to avoid delamination. Although the relative location of starch in a sheet of paper sometimes can be judged by staining with an iodine solution, the analyst needs to bear in mind that the papermaker may also be adding starch to the fiber suspension, in addition to the starch added at the size press.

#### Surface Hydrophobic Additives

Depending on the paper product's requirements, additional resistance to aqueous liquids can be achieved by the addition of water-resisting (hydrophobic) polymer materials to the size-press starch solution (Tompkins and Shepler 1991; Batten 1995; Garnier et al. 2000). The most popular additives of this type are copolymers of styrene, maleic anhydride, acrylic acid, and related materials. Hydrophobic urethane-type polymers are also widely used. In each case, the additives are simply mixed with the size-press starch solution and applied at the size press. During the drying of paper it is thought that these polymers migrate to the surface of the film, with the hydrophobic substituent groups tending to face outwards. The hydrophobic polymers added to the surface starch usually supplement, rather than replace, the internal sizing agents described earlier. Indeed, sometimes there is an optimum ratio of internal and surface sizing that achieve the best economy and the best overall balance of effects (Tompkins and Shepler 1991; Brungardt 1997).

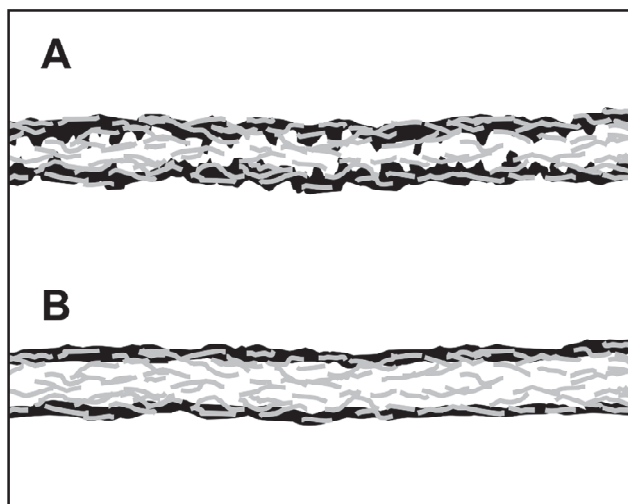

Fig. 14. Schematic illustration of impact of internal sizing on starch film penetration into paper. A: Low degree of sizing. B: High degree of sizing.

#### THE REVOLUTION CONTINUES

Though the trends towards an increased use of calcium carbonate filler, with the resulting neutral to alkaline papermaking conditions, generally have been favorable in terms of the aging properties of paper, there are some additional trends that can be expected to continue into the future. Not all of these changes will be welcomed by librarians, artists, and others who are interested in the long-term stability of paper's strength and stability.

#### Reduced Fiber Length

Producers of printing and writing papers have been steadily reducing the proportion of relatively long softwood fibers, in favor of a larger share of hardwood fibers from such wood species as maple, birch, and eucalyptus. Improvements in paper machine design, making it possible to produce weaker paper at high speed (Atkins 2003), have tended to accelerate this trend. However, the downside is that paper's resistance to tear can be expected to decrease, on average.

#### Increased Filler Content

The cost of mineral fillers, such as calcium carbonate, tends to be lower, compared to the fibers used in papermaking. Thus, papermakers have a long-term incentive to continue pushing the filler content of paper to yet higher levels (Bown 1990; Strutz et al. 1991; Fairchild 1992). For example, a typical uncoated paper for xerographic printing or offset lithography made today in the U.S. contains about 15%–20% filler, and the average amount has been increasing at a rate of about 0.2% to 0.3% per year. Both strength and hydrophobic sizing become more problematic with

increased filler levels due to the high surface area of filler particles.

#### Increased Content of Recycled Fibers

While concerns for environmental protection favor the reuse of papermaking fibers, such reuse can be unfavorable to paper's long-term stability. For one thing, studies have shown that the adverse effects of paper drying are cumulative when kraft fibers are made into successive generations of paper (Klungness and Caulfield 1982; Howard and Bichard 1992; Hubbe et al. 2003). The fibers tend to become more brittle each time they are dried during papermaking—not unlike what happens during natural aging of paper. Fortunately, such problems are expected to be less serious with the increased use of neutral to alkaline conditions of manufacturing.

#### Higher Yield

Finally, there is a quiet trend toward the use of higher-yield fibers in many grades of paper. Again, the idea is noble: use more of the wood material from the tree and waste less of it. But the phenolic lignin compounds in high-yield papermaking pulps tend to make the fibers stiffer and less bondable. Also, some high-yield pulps are especially prone to yellowing upon storage and exposure to light. A final problem with high-yield pulps brings us full circle to where this discussion started: the natural wood resins in high-yield fibers tend to migrate to the surface of fibers, gradually making the paper more hydrophobic (Swanson and Cordingly 1959).

#### Digital Media

Electronic documents such as computer files can offer extremely high resolution, as well as compact storage of information; however, their long-term “aging” characteristics are highly suspect. The lifetime of digital media faces such challenges as the obsolescence of software, discontinued computer drives, physical or magnetic damage to the storage media, and even the challenge of identifying high quality documents amid a rising tide of spam.

Though digital media have the potential to replace paper in many aspects of communication and art, there is no guarantee that future generations will have better luck in viewing such documents, when compared to the ongoing challenges with the preservation and distribution of paper documents. Whereas ancient texts written on paper, papyrus, and other such media still can be read, it is doubtful that a future civilization will be able to “reinvent” long-discarded versions of software to convert old strings of binary code into something readable. Rather than relying on luck and the self-interest of publishers and producers of storage media, including paper, it is important for archivists and librarians to continually advocate for time-tested and reliable means of document preservation.

#### REFERENCES

- Akpabio, U. D., and J. C. Roberts. 1987. Alkylketene dimer sizing: Vapor-phase deposition of tetradecyl ketene dimer on paper. *Tappi J.* 70(12): 127–129.
- Arney, J. S., and A. H. Chapdelaine. 1981. A kinetic study of the influence of acidity on the accelerated aging of paper. In *Preservation of paper and textiles of historic and artistic value II*, ed. J. C. Williams. Washington, DC: Amer. Chem. Soc., Advan. Chem. Ser. 193. Ch. 14, 189–204.
- Arney, J. S., and C. L. Novak. 1982. Accelerated aging of paper: The influence of acidity on the relative contribution of oxygen-independent and oxygen-dependent processes. *Tappi J.* 65(3): 113–15.
- Arnson, T. R., and R. A. Stratton. 1983. The adsorption of complex aluminum species by cellulosic fibers. *Tappi J.* 66(12): 72–75.
- Atkins, J. 2003. Papermaking in 2035: What will the paper machine look like? *Solutions* 86(3): 25–27; The modern paper machine, Part 2: Coated and fine paper. *Solutions* 86(12): 31–34.
- Back, E., and L. H. Allen. 2000. *Pitch control, wood resin, and deresination*. Atlanta: TAPPI Press.
- Back, E. L., and S. Danielsson. 1991. Hot extended press nips as gas-phase reactors: Hydrophobation with ASA. *Tappi J.* 74(9): 167–174.
- Back, E., and B. Steenberg. 1951. Isolation and properties of aluminum di- and mono-abietate. *Svensk Papperstidn* 54: 510–516.
- Barrett, T. D. 1989. Early European papers / contemporary conservation papers: A report on research undertaken from fall 1984 through fall 1987. *The Paper Conservator* 13.
- Batten, G. L., Jr. 1995. The effects of SMA surface sizes on paper end-use properties. *Tappi J.* 78(1): 142–146.
- Bottéro, J. Y., J. E. Poirier, and F. Fiessinger. 1980. *Prog. Water Technol.* 13: 601–612.
- Bottorff, K. J. 1994. AKD sizing mechanism: A more definitive description. *Tappi J.* 77(4): 105–116.
- Bown, R. 1990. Effect of filler particle size and shape in highly filled papers. *Przegl. Papier* 46(1): 18–23.
- Brungardt, B. 1997. Improving the efficiency of internal and surface sizing agents. *Pulp Paper Can.* 98(12): T480–83.
- Dumas, D. H. 1981. An overview of cellulose-reactive sizes. *Tappi* 64(1): 43–46.
- Du Plooy, A. B. J. 1981. The influence of moisture content and temperature on the aging rate of paper. *Appita* 34: 287–292.
- Ehrhardt, D. 1990. Paper degradation: A comparison of industrial and archival concerns. In *Paper preservation. Current issues and recent developments*, Atlanta: TAPPI Press. 63–68.
- Ehrhardt, S. M., and J. C. Gast. 1988. Cationic dispersed

- rosin sizes. In *Proc. 1988 Papermakers Conf.* Atlanta: TAPPI Press, 182–186.
- Evans, D. B., D. K. Drummond, and M. H. Koppelman. 1991. PCC fillers for groundwood papers. In *Proc. 1991 Papermakers Conf.* Atlanta: TAPPI Press, 321–330.
- Fairchild, G. H. 1992. Increasing the filler content of PCC-filled alkaline papers. *Tappi J.* 75(8): 85–90.
- Farley, C. E. 1992. Influence of dissolved ions on alum cationicity under alkaline papermaking conditions. *Tappi J.* 75(11): 193–199.
- Garnier, G., M. Duskova-Smrckova, R. Vyhalkova, T. G. M. van de Ven, and J.-F. Revol. 2000. Association in solution and adsorption at an air-water interface of alternating copolymers of maleic anhydride and styrene. *Langmuir* 16: 3757–3763.
- Gill, R., and W. Scott. 1987. The relative effects of different calcium carbonate filler pigments on optical properties. *Tappi J.* 70(1): 93–99.
- Hagemeyer, R. W. 1984. Calcium carbonate. In *Pigments for Paper*, ed. R. W. Hagemeyer, Atlanta: TAPPI Press, Ch. 5, 53–94.
- Halward, A., C. Sanchez, and A. Pinto de Oliveira. 1978. Comparison of some physical-chemical properties between Amazon 88 and other kaolins. *Paper* (London) 190: 563–564, 567–568.
- Hodgson, K. T. 1994. A review of paper sizing using alkyl ketene dimer versus alkenyl succinic anhydride. *Appita* 47: 402–406.
- Howard, R. C., and Bichard, W. 1992. The basic effects of recycling on pulp properties. *J. Pulp Paper Sci.* 18: J151–59.
- Hubbe, M. A. 1985. Detachment of colloidal hydrous oxide spheres from flat solids exposed to flow. 2. Mechanism of release. *Colloids Surf.* 16: 249–270.
- Hubbe, M. A., R. A. Venditti, R. L. Barbour, and M. Zhang. 2003. Changes to unbleached kraft fibers due to drying and recycling. *Prog. Paper Recycling* 12(3): 11–20.
- Hubbe, M. A. 2004. Filler particle shape vs. paper properties: A review. In *Proc. TAPPI Spring Tech. Conf.*, Atlanta: TAPPI Press, paper 7–3.
- Hunter, D., 1947. *Papermaking: The history and technique of an ancient craft.* New York: Dover Publ., Inc.
- Kitaoka, T., A. Isogai, and F. Onabe. 1997. Sizing mechanism of emulsion rosin size-alum systems. Part 2. Structures of rosin size components in the paper sheet. *Nordic Pulp Paper Res. J.* 12: 26–31.
- Klungness, J. H., and D. F. Caulfield. 1982. Mechanisms affecting fiber bonding during drying and aging of pulps. *Tappi J.* 65(12): 94–97.
- Laine, J. 1980. Manufacture of precipitated calcium carbonate. *Paperi ja Puu* 11: 725–734.
- Lyne, M. B. 1995. The effect of pH on the permanence of LWC paper and fine paper made from LWC. *Tappi J.* 78(12): 138–144.
- Marton, J. 1989. Mechanistic differences between acid and soap sizing. *Nordic Pulp Paper Res. J.* 4: 77–80.
- Matijevic, E., and L. J. Stryker. 1966. Coagulation and reversal of charge of lyophobic colloids by hydrolyzed metal ions. III. Aluminum sulfate. *J. Colloid Interface Sci.* 22: 68–77.
- McComb, R. E., and J. C. Williams. 1981. The value of alkaline papers for recycling. *Tappi* 64 (4): 93–96.
- Middleton, S. R., J. Desmeules, and A. M. Scallan. 1994. The Kubelka-Munk coefficients of fillers. *J. Pulp Paper Sci.* 20: J231–35.
- Neimo, L. 1999. Internal sizing of paper. In *Papermaking Chemistry*, ed. L. Neimo. Helsinki: Fapet Oy. Ch. 7, 151–203.
- Nitzman, A. F., and A. T. Royappa. 2003. Sizing variations of dispersed rosin sizes with fortification, hardness, pH, and temperature. *Tappi J.* 2(4): 8–11.
- Ödberg, L., T. Lindström, B. Liedberg, and J. Gustavsson. 1987. Evidence for  $\beta$ -ketoester formation during the sizing of paper with alkylketene dimers. *Tappi J.* 70(4): 135–139.
- Öhman, L.-O., L. Wågberg, K. Malmgren, and Å. Tjernström. 1997. Adsorption of aluminum (III) on cellulosic fibers in neutral to alkaline solutions— influence of charge and size of the particles formed. *J. Pulp Paper Sci.* 23: J467–74.
- Pang, P., K. K. Khoultchev, and P. Englezos. 1998. Inhibition of the dissolution of papermaking grade precipitated calcium carbonate filler. *Tappi J.* 81(4): 188–192.
- Rauch, R., and R. Sangl. 2000. Latest findings on entrained air and dissolved gases in pulp suspensions. *Proc. TAPPI Papermakers Conf.*, Atlanta: TAPPI Press, 159–175.
- Royce, R. 1995. Internal sizing. In *Course Notes from 1995 Introduction to Wet End Chemistry.* Atlanta: TAPPI Press.
- Scott, W. E. 1996. *Principles of Wet End Chemistry.* Atlanta: TAPPI Press.
- Shen, W., F. Xu, and I. H. Parker. 2002. The effect of the melting of AKD and its corresponding ketone on spreading behavior. *Appita J.* 55: 375–381.
- Slepety, R. A., and A. J. Cleland. 1993. Determination of the shape of kaolin pigment particles. *Clay Minerals* 28: 495–508.
- Smook, G. A., *Handbook for pulp and paper technologists*, 2nd ed. Vancouver, BC: Angus Wilde.
- Strazdins, E. 1989a. Paper sizes and sizing. In *Naval stores*, ed. D. F. Zinkel and J. Russell. New York: Pulp Chemicals Assoc. Ch. 16, 575–624.
- Strazdins, E., 1989b. Theoretical and practical aspects of alum use in papermaking. *Nordic Pulp Paper Res. J.* 4: 128–134.
- Strutz, M. D., J. C. Pleiger, and P. A. Duncan. 1991. Calcium carbonate filler optimization for alkaline paper. *Pulp Paper Can.* 92(8): 39–42.

- Swanson, J. W., and S. Cordingly. 1959. Surface chemical studies of pitch. II. The mechanism of the loss of absorbency and development of self-sizing in papers made from wood pulps. *Tappi* 42(10): 812–19.
- Tompkins, T. W., and J. A. Shepler. 1991. Combination sizing. The use of synthetic surface size with an alkaline internal size. In *Proc. 1991 Papermakers Conf.*, Atlanta: TAPPI Press. 191–201.
- Wang, F., H. Tanaka, T. Kitaoka, and M. A. Hubbe. 2000. Distribution characteristics of rosin size and their effect on the internal sizing of paper. *Nordic Pulp Paper Res. J.* 15: 80–85.
- Wasser, R. B. 1987. The reactivity of alkenyl succinic anhydride: its pertinence with respect to alkaline sizing. *J. Pulp Paper Sci.* 13: J29–J32.
- Waterhouse, J. F. 1990. Monitoring the aging of paper. In *Paper preservation: Current issues and recent developments*. Atlanta: TAPPI Press, 53–57.
- Wilson, W. K., and E. J. Parks. 1982. Comparison of accelerated aging of book papers in 1937 with 36 years natural aging. *Restaurator* 4: 1–55.
- Yu, L., and G. Garnier. 1997. Mechanism of internal sizing with alkyl ketene dimers: The role of vapor deposition. In *The Fundamentals of Papermaking Materials*, ed. C. F. Baker. Leatherhead, Surrey: Pira International, vol. 2, 1021–1046.
- Yu, L., and G. Garnier. 2002. The role of vapor disposition during internal sizing: A comparative study between ASA and AKD. *J. Pulp Paper Sci.* 28: 327–331.

MARTIN A. HUBBE  
Associate Professor  
North Carolina State University  
Raleigh, North Carolina  
hubbe@ncsu.edu