

## Restoring a Carte-de-Visite Album: The “Hinged Back” of Philadelphia, 1863

### ABSTRACT

This article outlines a case study of the restoration of a patented carte-de-visite album in the collection of the Metropolitan Museum of Art in New York City. The Hinged Back album is a noteworthy case due to its binding structure of metal rods weaving through alternate leather loop hinges, which are attached to the leaves. Because of the album’s complex design and the extremely deteriorated condition of its hinged connections, the process required to successfully restore the album’s functional integrity was quite challenging. Pre-treatment and treatment are reviewed here, as well as some practical considerations for carte-de-visite album conservation in general.

### INTRODUCTION

This album came to Book Conservation at the Metropolitan Museum of Art from the Department of Photographs. All of its leaves were detached from one another, most of its leather loop hinges were disintegrating from red rot, the metal rods were rusted and bent in spots, and the sections could not be handled without causing further damage (figs. 1–3). The dust and debris from the red rot were migrating into the interior of the album, staining some of the pages. While the photographs were in good condition overall, the heavy, sculpted boards were detached, and the album was not functional. Because the album had an important provenance, housed valuable photographs, and was a candidate for exhibition and loan, restoration was advised. Prior to commencing treatment, however, research was needed on the unusual design of the album.<sup>1</sup>

### BACKGROUND RESEARCH

Victorian albums (ca. 1850–1890s) in general reflect the period’s effort to keep up with the pace of innovations in

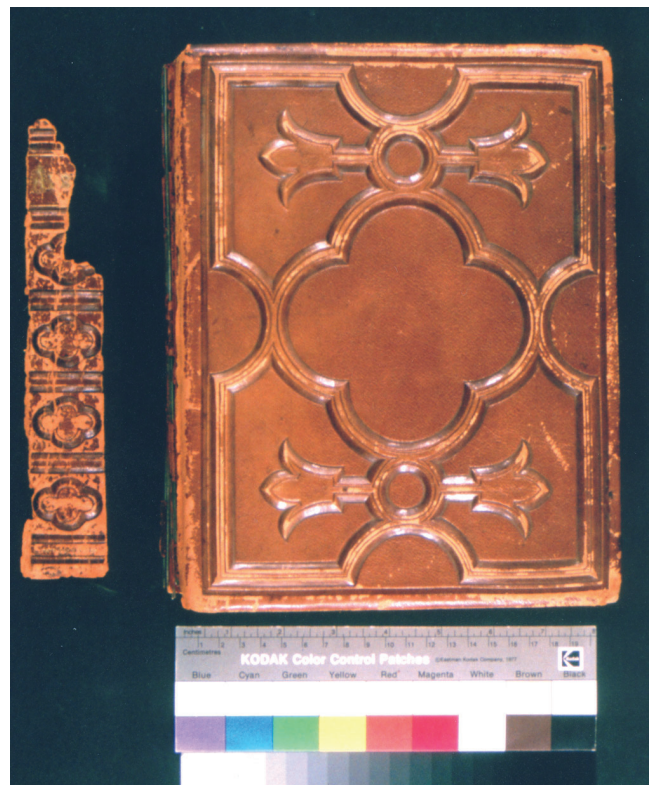

Fig. 1. Hinged Back carte-de-visite album, ca. 1860–1880s, 25.4 x 20.0 x 4.1, Metropolitan Museum of Art, New York, Gift of A. Hyatt Mayor 1967 (67.580.4): front view and spine fragment before treatment.



Fig. 2. Spine view: before treatment

Received for publication Fall 2005.

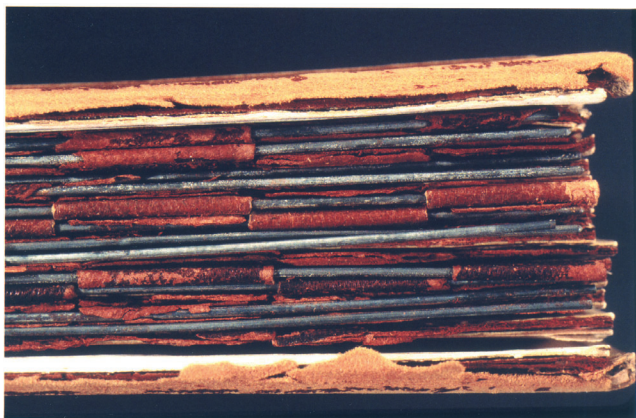

Fig. 3. Detail of spine view: before treatment

photography, as well as general technological innovations, the use of new materials, and the rise of photograph collecting. The bulky *carte-de-visite* required a specific kind of album-leaf design, for proper display and storage of the image. A *carte-de-visite*, or “visiting card,” is a thin albumen print mounted on card, popularized first in France and then later in England and the United States in the late 1850s and early 1860s. Its subjects included landscapes and portraits of individuals, families, and luminaries of the time. They became immediate collectibles, driving the invention of ways to present and store them. Because the thick leaves designed to house these *cartes-de-visite* could not be sewn together in any traditional way, various alternate ways of attaching the leaves were invented. The most commonly used of these methods for stiff-board albums was the cloth V-hinge, with other variations of cloth guarding and stubbing following close behind. More uncommon attachment methods were found in patented albums such as Harding’s Flexible Chain Back Album, which uses tab hinges, and the Hinged Back album, which uses loop hinges.

Harding’s Flexible Chain Back Album was described in B. P. Eldridge’s article, “A Photo Album Structure from Philadelphia, 1865” (2002). At first glance, the similarity of the spine structures of the Harding album and Hinged Back album is striking. While the respective tab and loop hinges are actually quite different, both album designs show the similar idea of using alternating hinge attachments for the smooth and flexible turning action of their leaves. It is worth noting that the Hinged Back album, also patented in Philadelphia, preceded the Harding album by only two years. One can easily imagine a feisty competition for the local album market. Indeed, there were apparently at least fifteen patents issued between 1861–65 for album structures, or their modifications (Taft 1938).

Finally, while researching album structure, the article, “The Structure’s the Thing! Problems in the Repair of Nineteenth-Century Stiff-Paged Photograph Albums”

(Wootton et al. 1999), was of critical importance. While it said very little directly about the Hinged Back album, it did show a photo of one: the Wadsworth Album at the Library of Congress. Consequently, a very useful exchange ensued with staff there (especially Terry Boone), including tips based on the Wadsworth Album treatment. It was in large part due to the above-mentioned articles that this present article was written, as a continuation of the dialogue on the peculiarities of Victorian album structure and treatment.

#### THE HINGED BACK ALBUM STRUCTURE AND PRE-TREATMENT CONSIDERATIONS

The Hinged Back album has a “piano hinge” structure, with iron rods weaving through alternate loop hinge segments and attaching each leaf to its neighbor. The use of rods (or pins, or wire, depending on the source) for albums was designed with the needs of stiff boards in mind. They allow for the flexibility and smooth turning action required for these thick leaf structures. Further, the rods and alternating looped segments do not have the vulnerability to tearing of the more traditional paper or cloth hinges. In fact, the authors of the patent also recommended using metal hinge materials (among many others) for this structure (Mets 1863); they were obviously aware of the need for stronger and more durable album materials.

This particular Hinged Back album originally consisted not of metal, but of leather-loop hinges, wrapped around iron rods. The looped segments were very deteriorated, and the leaves were completely detached from one another. Each leaf had been constructed of a thick cardstock core with a piece of sturdy facing paper on each side, overlapping the edges of the window and acting as a frame or mat. Each leaf presents four cut-out windows, with slit openings at the top and bottom edges for insertion of the *cartes-de-visite*. The facing paper projects over the cardstock core at the hinge area by approximately a quarter of an inch, leaving a slot for the insertion of the hinge. Based on the evidence of the few remaining intact hinges, the leather was folded over the rod, glued together forming strips, and placed inside this slot, against the inner cardstock edge (figs. 6b and 9). The looped portion of the hinge had cuts at regular intervals, allowing its segments to project in opposite directions (fig. 4 and 6a–b). The iron rods wove through the alternating segments, each rod attaching two leaves. The rod-and-loop hinge construction plus the two facing papers equaled the thickness of the constructed leaf.

As for the other details of the album, it came with a brown, full-leather case binding, with thick, detached, sculpted or paneled boards (Primanis 1999). Boards with raised, sculpted designs were typical of the period’s penchant for Gothic Revival design (Rutherford 1999). The two fore-edge clasps were missing, the edges were gilded,





Fig. 4. Detached leaf showing loop hinge detail: before treatment

and there was a partial original leather spine fragment remaining, with the patent date stamped near the tail (fig. 5). The pastedowns were white moiré-patterned, with no corresponding flyleaves.

When considering the treatment of this album, it was clear that rehousing the album and/or minimal intervention would not be ideal. Rehousing the photographs may have been another option, but this would have permanently altered the historical and viewing environment of the photographs. Minimal conservation treatment such as cleaning and consolidating the leather loop hinges had already been performed, but had not prevented further accumulation of red rot dust and deterioration of the structure when handled. Finally, the Hinged Back album's provenance is significant; it was a gift from A. Hyatt Mayor, a former Metropolitan Museum of Art Curator of Prints, 1946–66. It also houses portraits taken by important early pioneers of photography, including Disdéri (who first patented the *carte-de-visite*), Nadar, and Rejlander. These valuable photographs make the album a likely candidate for future exhibition and loan. Hence, preserving the aesthetic, historical, and social contexts of the photographs required that the album function.

Having come to this conclusion, many challenges remained. Looking at the deteriorated spine area and leaves, the mechanism of the rods and loop hinges seemed fairly straightforward, but it was unclear exactly how to reattach the boards, and which materials to use for reconstructing the hinges. It was also not clear whether the original, rusted rods (two were missing) should be used,

and how to best maintain flexibility. Following the lead of Eldridge and the advice of a colleague, it seemed wise to further investigate the title page information: “Hinged Back. Patented July 21<sup>st</sup>, 1863. Manufactured by Altemus & C<sup>o</sup>, Philadelphia” (fig. 5).

#### PATENT INFORMATION

Having a patent description and design drawings in hand for a restoration treatment is like having a window in time and is a good place to investigate appropriate treatment options. It is also a gift; there are very few other occasions when book conservators have such clear and detailed information of the inventor's intent and design of a structure. Particularly for severely deteriorated album structures with complex designs, the patent is indispensable, when available.

However, doing a patent search is not always straightforward. By going to the United States Patent and Trademark Office website ([www.uspto.gov](http://www.uspto.gov)), patent queries may be made, but there is no keyword search, and those patents registered between 1790 through 1975 are searchable only by Patent Number and Current U. S. Classification. If you are unfamiliar with either, it is unclear how to proceed.<sup>2</sup>

Finally, however, patent number 39,300 was located. It included an informative promotional essay, several diagrams (figs. 6a–b), and the classification numbers for this type of album (282/15.1; 281/40). In addition, interesting patent history concerning the album was provided in the description.

While first issued on July 21<sup>st</sup>, 1863, to John D. Mets (and called the “J. D. Mets Photographic Album” on the patent diagrams), the patent was later assigned to Samuel T. Altemus and Henry Altemus of Altemus & Company and reissued on December 1, 1863. This explains the title page reference to “Altemus & C<sup>o</sup>” and the appearance of

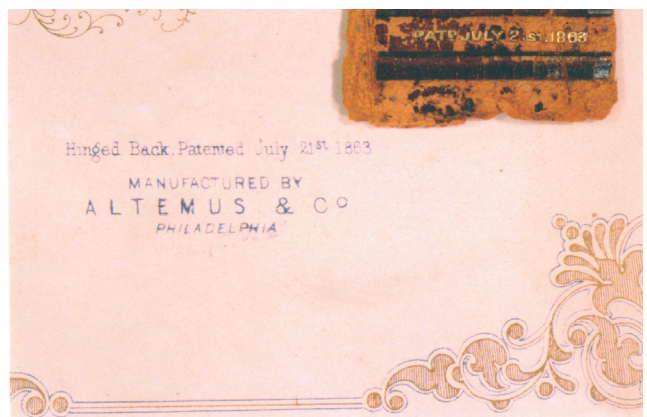

Fig. 5. Detail of title page and spine fragment, stamped with the patent date

*J.D. Mets. Sheet 1.2, Sheets  
Photographic Album.*

*N<sup>o</sup> 1,591.*

*Reissued Dec. 1, 1863*

*Fig 1*

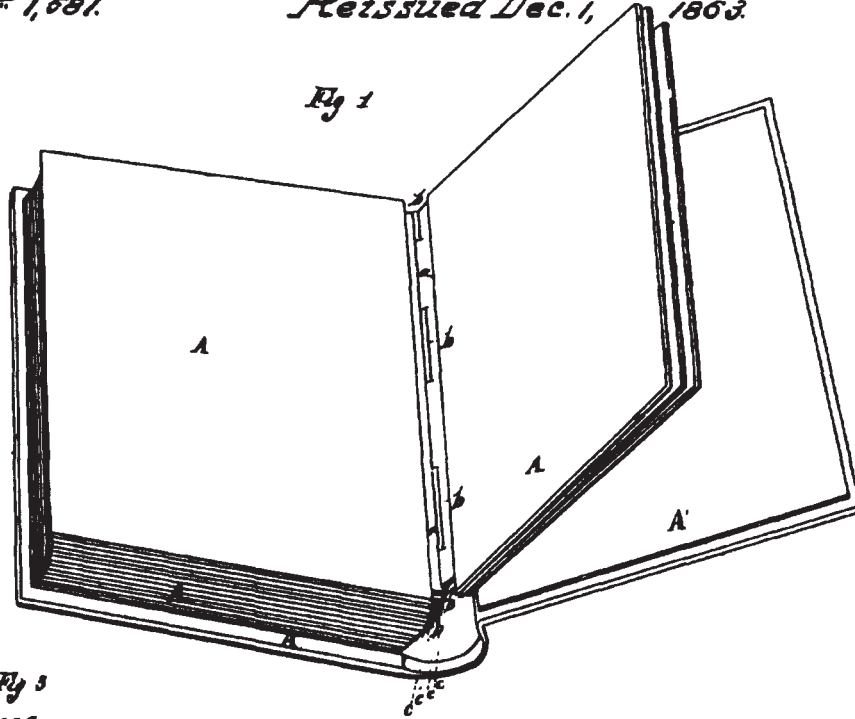

*Fig 1 Fig 3*

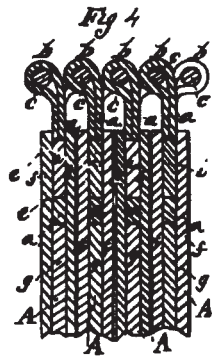
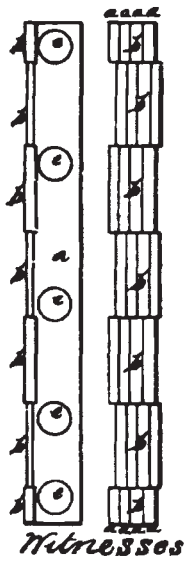

*Fig 5*

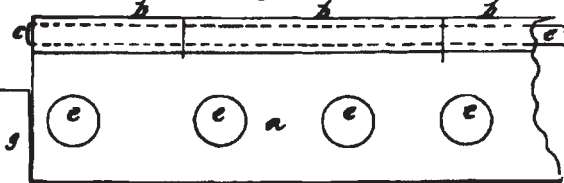

*Inventor  
John D. Mets  
by his atty's  
Mason, Dumont & Williams*

Fig. 6a. U.S. Patent 39,300: diagram 1:2

*J. D. Mets. Sheets 2 Sheets*  
*Photographic Album.*

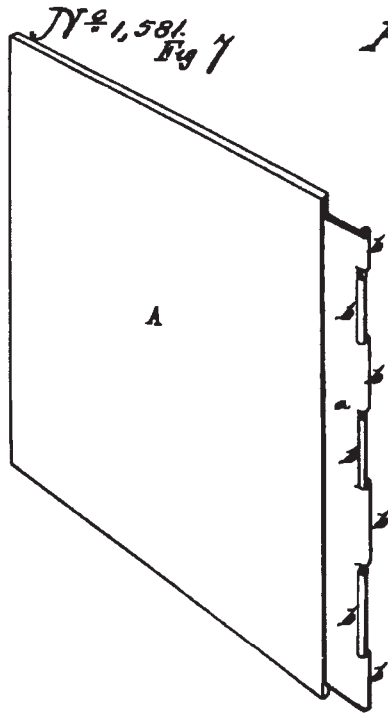

*Reissued Dec. 1, 1863*  
*Fig 6*

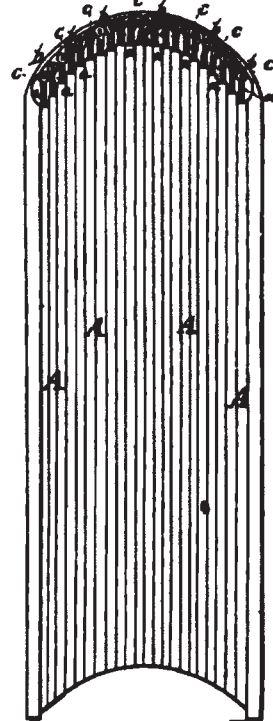

*Fig 8*

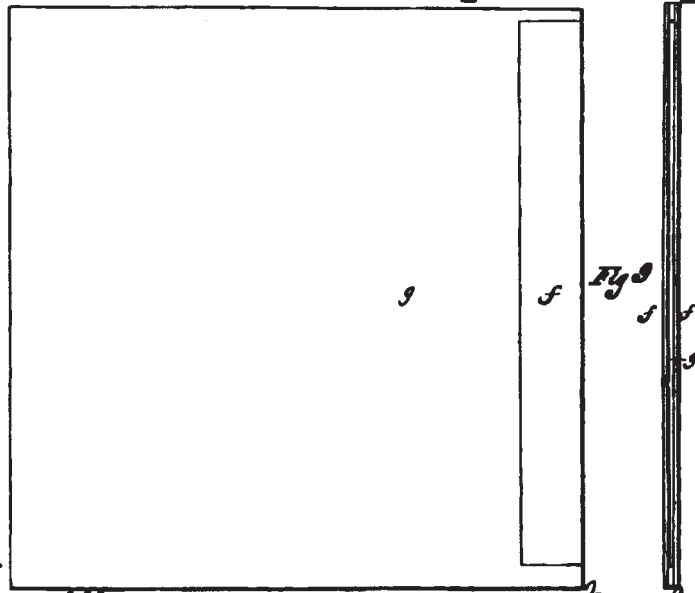

*Witnesses*  
*R. T. Campbell*  
*James A. Campbell*

*Inventor*  
*John D. Mets*  
*by his atty's*  
*Malson, Tenenck & Sauer*

Fig. 6b. U.S. Patent 39,300: diagram 2:2

the original patent date. The Altemus team also apparently renamed the album the “Hinged Back.”

From the patent description, it is clear that they considered their invention to be an improvement in the area of album strength and durability:

. . . [O]ur invention consists of a succession of leaves hinged together substantially in the manner described hereinafter. . . The thick and stiff leaves which are required in photograph-albums and other books cannot be bound together by stitching in the manner employed in binding ordinary books. Several modes, none of them of a very durable character, have consequently been resorted to in securing the leaves of this class of books (Mets 1863, 1).

It is also interesting to note that they considered the structure to be versatile, not only in terms of hinge materials and construction (e.g., using metal, leather, cloth, gutta-percha, single or double plates, etc.), but also in terms of use:

Although special allusion has been made to the binding of photograph-albums, it will be evident that the invention is applicable to the binding of tablets and all books having thick and strong leaves which it is advisable to bind together securely and permanently — such, for instance, as the sample-books used by drapers and others, and books used by botanists for containing dried samples of plants (Mets 1863, 2).

#### TREATMENT

Based on review of the patent drawings and information and consultation with colleagues, work began. The major steps undertaken were as follows:

- A model was constructed, experimenting with different laminates and different coatings on the rods (fig. 7).
- The cartes-de-visite were removed by Metropolitan Museum of Art Photograph Conservation staff. The album leaves were numbered in pencil, and notes and diagrams were made of original photograph order and placement (fig. 8).
- The album was disassembled and dusted, the loop hinges and rods were separated and removed, and the slots were cleared of red rot debris (fig. 9).
- The original iron rods were straightened and cleaned with steel wool (#000). New “piano wire” rods of the same diameter were used to replace the two missing rods. The rods were coated with Staples Clear Paste Wax by Metropolitan Museum of Art Arms and Armor Conservation staff.<sup>3</sup> They were then buffed to provide toughness, increase smoothness of motion when turning the leaves, and to help prevent future rust (figs. 10–11).

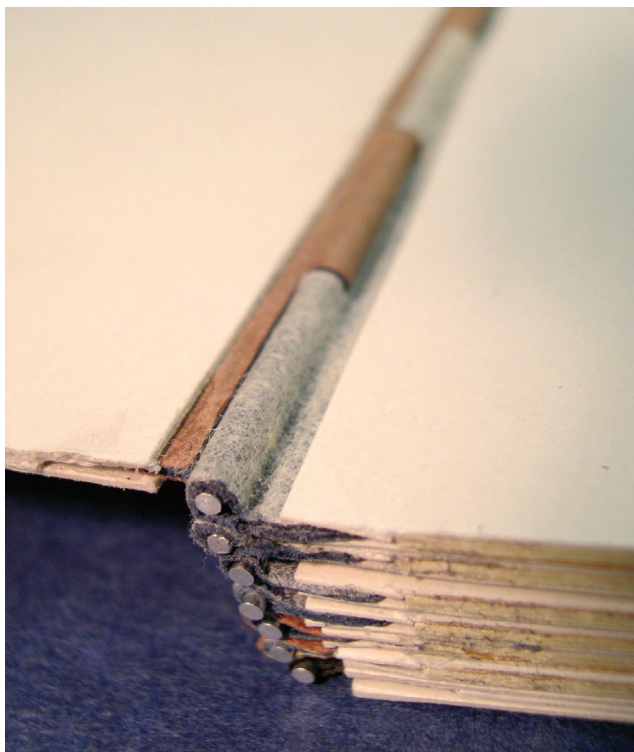

Fig. 7. A model showing construction details: every other looped segment is cut out of the first hinged strip to accommodate the adjacent leaf. This is done only for the first and last loop hinges.

- Dyed brown Japanese paper was laminated to cotton flannel to provide the thickness of the original hinges. Aesthetically, it approximated the look of leather on the outside, while providing the grab necessary to best replicate the suede of the leather hinges on the inside. When formed, the hinges were lightly coated with methyl cellulose to consolidate fibers and burnished when dry with a bone folder for increased durability (fig. 12). In general, this laminate was a better choice than using leather, as it is stronger and less liable to stretch, break down, or eventually rot.
- Cuts were made to create the looped segments, and then the loop hinges were attached to the album leaves and the rods woven through the alternating looped segments. Every other looped segment was cut out of the first and last loop hinge strips only; the free hinge area was then used for board attachment (figs. 13–14 and fig. 7).
- The original boards were reattached and the album was rebaked in French chagrin goatskin to match the character of the original leather (fig. 15).
- Restoration of the aesthetic aspects of the spine required several steps. The original spine fragment (fig. 16) was attached to the new leather. This fragment was completed using a photocopier and scanner to replicate the



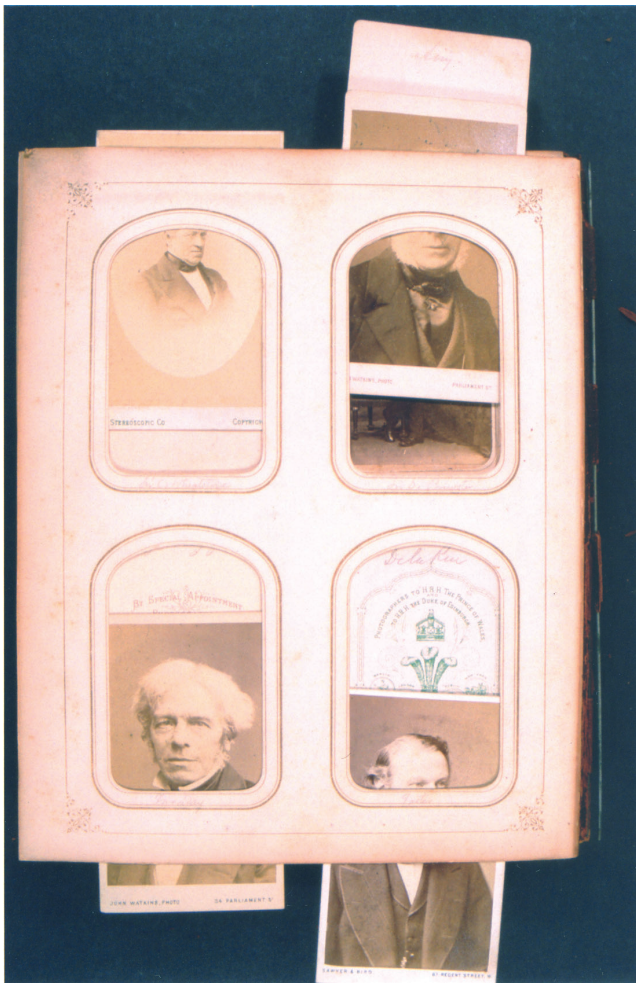

Fig. 8. Cartes-de-visite in the process of being removed from a detached leaf

missing portion of the spine. These copies were transferred to thin, toned Japanese paper, which was then adhered to the new leather (figs. 17–18).

- Final testing and documentation completed the project (figs. 19–21). The album was then boxed and returned to Photograph Conservation for the reinsertion of the cartes-de-visite.

#### CONSIDERATIONS FOR HINGED BACK/CARTE-DE-VISITE ALBUM TREATMENT

The decision to restore is often a complicated one, especially within an institution, and requires consideration of many diverse factors. Besides the previously noted specific details for this Hinged Back album restoration, it is useful to keep in mind the bigger picture as well. In this case it was critical and very fortunate to have institutional support for the project, photograph and objects conservators close at hand for consultation and collaboration, and no urgent time pressure for its completion.



Fig. 9. Disassembled leaf, loop hinge, and rod

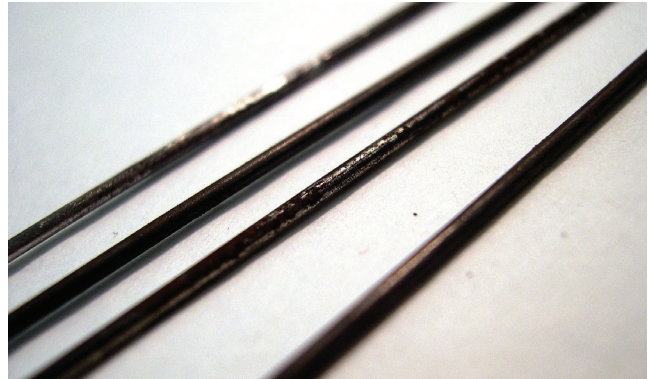

Fig. 10. Original iron rods: before treatment

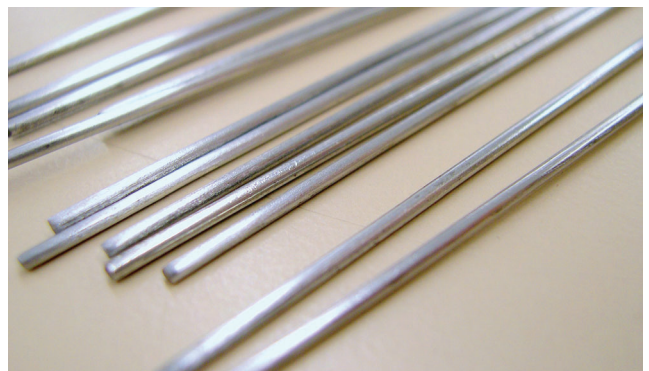

Fig. 11. Original iron rods: after cleaning, coating, and buffing



Fig. 12. Dyed Japanese paper and cotton flannel laminate: final shaping and burnishing



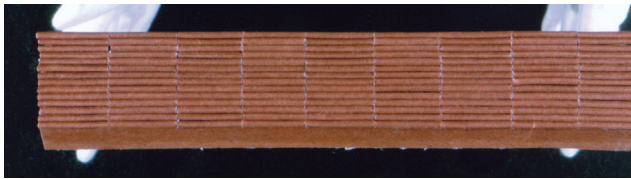

Fig. 13. Spine view after new loop hinges were attached

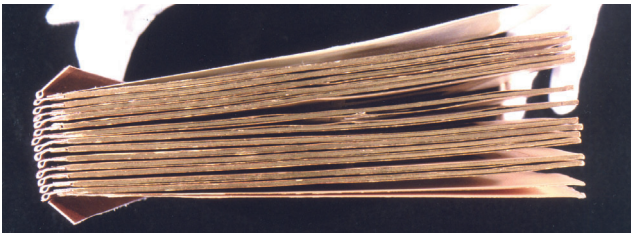

Fig. 14. Top view with free first and last loop hinges visible

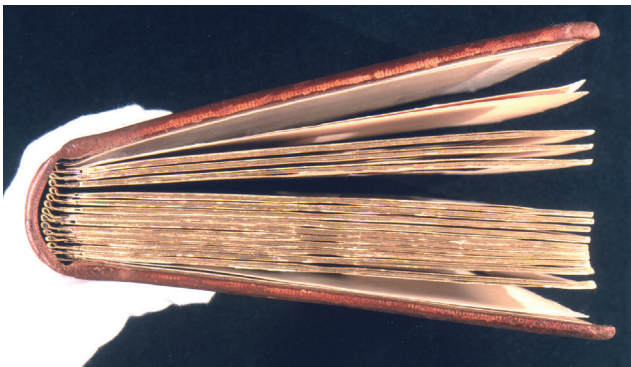

Fig. 15. After leather rebacking

Besides doing a patent search, when possible, there are many other issues to consider before treating a carte-de-visite album. For example, how does one decide when a rare album merits such an elaborate restoration? Under what circumstances should the cartes-de-visite be removed from the frames? How is this done safely? What kinds of adhesives are suited to carte-de-visite album repair? What should one consider in terms of final spine flexibility and housing? These are only a few of the questions that arose during the process of researching and treating the Hinged Back album, and many of these concerns may be useful for other carte-de-visite or stiff-board album structures as well.

The question of whether to re-house only, make a preservation handling copy, perform minimal conservation, or restore, is a major one, and cannot be adequately summarized here. Further, each album treatment inevitably poses its own challenges based on numerous factors, including provenance, storage history, contents, materials, amount and type of use, etc. However, it is generally preferable to keep album photographs in their original album environment. As receptacles for original material, album formats preserve an historical, sometimes personal, viewing opportunity as conceived by the arranger in a particular order. They also include many details of the period, such as the patent and production information, the materials used, annotations, and evidence of fashions and trends (Rutherford 1999).

When the album condition is actually harming the images, removal and rehousing may be the only option. In other cases, frequent exhibition of a particular leaf may warrant album disbinding. Alternatively, a handling copy



Fig. 16. Spine fragment: before treatment



Fig. 17. Spine view: after treatment



Fig. 18. Spine detail: after treatment



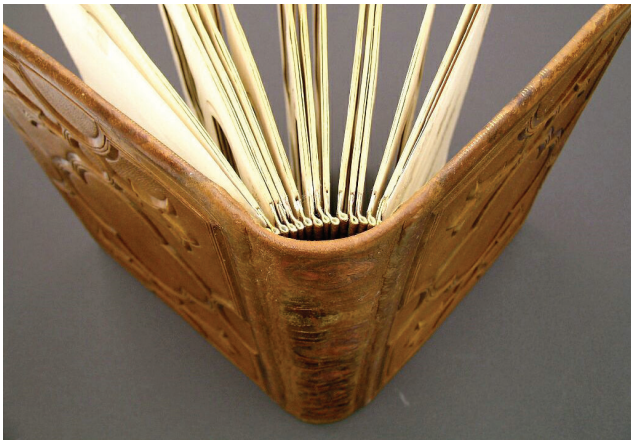

Fig. 19. Top view: after treatment

of the album may be made, either by preservation photocopying all of the leaves, and placing or sewing them in a modern binding, or by disbinding the original album leaves, and placing them in plastic pockets for three-ring binder housing (Cartier Bresson and Nyeberg 1998). A surrogate or handling copy also has the advantage of potentially including copies of the backs of the photographs as well, providing researchers with the important notes often inscribed there (Wootton et al. 1999).

When doing a major restoration such as this, it is always best to remove the photographs while doing the treatment, especially when there is debris or red rot dust. To protect both the photographs and the album, the photographs should be removed by a photograph conservator or other experienced professional. The facing paper and windows of carte-de-visite leaves are fragile, tight, often acidic, and liable to tear easily with the slightest movements. If necessary, and if the openings are not too tight, cartes-de-visite may be carefully removed with a small piece of polyester film (Mylar), or a Mylar sandwich, cut to the width of the opening, and left long. The Mylar is inserted onto either side of the carte-de-visite. Then, using gentle pressure and motion, one can generally ease the carte out without damage to the photograph, its mount, or to the leaf. Careful notes, diagrams, and/or photodocumentation must be made on the placement of each image so that they can be reinserted after treatment of the album in the same orientation and location. And if the leaves are separated, numbering each one with pencil is also helpful.

The issue of adhesive use for the various stages of this album treatment also presented a challenge. Starch paste, while usually the adhesive of choice in conservation repair, had little place in this type of album restoration, aside from mending the facing papers. And while animal glue was the adhesive of choice in the Victorian period, in this case modern adhesives provided a viable option. Following recommendations of fellow conservators, Jade 403/methyl cellulose mixture (3:1) was used to laminate and attach the



Fig. 20. Inside album: hinging detail



Fig. 21. Hinged Back album: after treatment

hinges. Considering the fragility of the leather, and the flexibility required by the structure, various combinations of Klucel-G (in ethanol), and Lascaux 360 HV and 498 HV were used for the leather reback and original spine replacement. While the Lascaux adhesives are relatively new to book conservation, their flexibility, strength, and versatility make them ideal for many treatments, particularly for leather repair (minimal darkening). While further testing needs to be done, the use and testing to date shows these adhesives to be reversible in a short-term period using solvents or heat (Anderson and Puglia 2003), and potentially

reversible over long periods of time (Duffy 1989). As a side note, no additional repairs to the leather in the case of the Hinged Back treatment were needed, but making coated or solvent-set mending tissues (e.g., using Lascaux 498 HV) for joint or spine area repairs is also recommended for the reasons mentioned above (Anderson and Puglia 2003).

Another important consideration is the openability of the album after treatment. These stiff-board albums differ radically from traditional bookbinding; the tremendous flexibility that these thick leaves require in the spine also requires a corresponding flexibility in the case. And while some *carte-de-visite* structures may never have opened completely flat, their flexibility becomes more crucial with passing time, as their heavy boards and aged materials make them more fragile.

This spine area flexibility depends on many factors. For example, only a thin *usu mino* (11g/m<sup>2</sup>) Japanese paper was used to line the new leather of this album before rebacking, to strengthen it and prevent it from excessive stretch. However, even this thin lining may have slightly hindered the flexibility of the final structure. The boards open well, and the leaves are flexible and turn smoothly, but do not lie completely flat on their own. This could be due to many factors, but for future reference, no lining on the new leather is recommended when rebacking this type of structure. It is also important to remember that both the Hinged Back album and Harding's Flexible Chain Back Album, with their moving tab and loop hinges in their respective spine areas, cannot be lined if they are to open. With no lining on either the spine of the album or of the case, the original clasps on these albums do serve the important function of helping the album to keep its shape, and are much more than a decorative addition (Wootton et al. 1999).

Finally, these albums should have a durable enclosure of some kind, for protection from dirt, dust, environmental fluctuations, and handling. *Carte-de-visite* albums should be kept horizontal on the shelf, to minimize stress on the album connections and to keep the photographs in place. It is also helpful to label the enclosure with any user handling guidelines, degree of opening/openability (e.g. 45°, 90°, 135°), and to note the need for a cradle or other support. Figure 22 shows Katherine Beaty's "cradle-box," which is an excellent solution for particularly rare, fragile, or inflexible albums; the item stays supported for viewing without having to leave its enclosure.<sup>4</sup>

## CONCLUSION

The Hinged Back album, as stated in its patent description, was certainly an improvement upon the *carte-de-visite* albums of its period. While later patents introduced further improvements on its structure, it marks

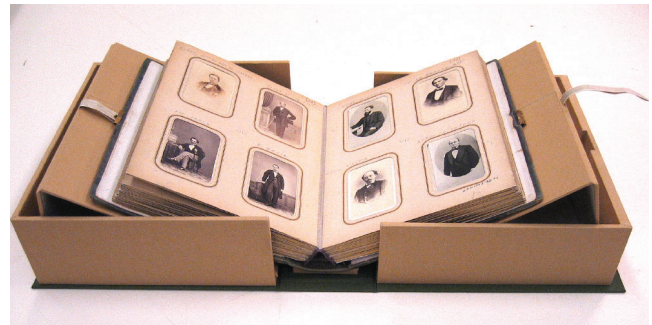

Fig. 22. An example of a "cradle box": a double-tray clamshell box with a built-in foldout cradle. Courtesy of Katherine Beaty, 2005 (album pictured belongs to the Library of Congress).

an interesting turning point in album design. It is an important task to document and restore as many of these period structures as possible, as they have become important social and historical documents. Moreover, pristine examples are becoming increasingly rare, due to poor storage, handling, and the cheap, mass-produced, and acidic materials out of which many were made.

Further, it may be useful to point out that apart from strict research or restoration purposes, this structure could be used in the modern conservation setting to recreate a sympathetic album which requires removable leaves (for exhibition, loan, etc.). Unlike most other structures from the Victorian period, this structure has the potential for removing or rearranging of leaves without harming the binding, due to the easy removal of the rods. And, if left with an exposed spine, this structure has additional creative and versatile potential, and certainly resembles contemporary "piano hinge" bindings. Additionally, as stated in the patent description, it could be used for textile or other sample books.

There is little in the conservation literature that deals with *carte-de-visite* album conservation or restoration concerns in depth. This project required an understanding of an unusual album construction and its mechanical functioning. It also provided an opportunity to make these notes available for future reference. *Carte-de-visite* albums have many peculiarities in general, and examples such as the Hinged Back album (and Harding's Flexible Chain Back Album) are especially challenging because they do not conform to well-known binding structures.

## ACKNOWLEDGMENTS

I would like to thank my colleagues at the Metropolitan Museum of Art, Nora Kennedy and Edward Hunter, for their support and technical help with photograph and metal conservation aspects of this treatment, and especially Mindell Dubansky, for general support and for allowing me to pursue this project in depth. I would also like to



thank Barbara Brown, Olivia Primanis, Hedi Kyle, Katherine Beaty, Alan Puglia, and Shannon Zachary for all kinds of interest, input, and advice. Terry Boone in particular helped me understand the Hinged Back album structure, steered me toward the patent search, and was an invaluable support from the beginning. Finally, I am very grateful to Betsy Palmer Eldridge for responding so promptly to queries, sharing her knowledge and enthusiasm for historical album structures, and especially for assistance with the preparation of this article.

The photographs of figures 1–3, 5, 8, and 16 are courtesy of the Photograph Conservation Section at the Metropolitan Museum of Art; Figure 22 is courtesy of Katherine Beaty. All other photographs were taken by the author.

## NOTES

1. While I was familiar with diagrams of various historical album constructions, including those of Richard Horton and those presented in the articles below, the precise way to reconstruct the design of the Hinged Back album, with its casing, initially remained elusive. Also consulted during this process were contemporary bindings, such as Daniel Kelm’s wire bindings ([www.garageannexschool.com](http://www.garageannexschool.com)) and Hedi Kyle’s “piano-hinge” structures. The term was coined by Kyle, and her design inspired by door hinges and a Victorian album (see *Non-Adhesive Binding* by Keith Smith. Fairport, N.Y.: Sigma Foundation, 1990).

Parentetically, the earliest piano-hinge book structure found during this research was from the late tenth to early eleventh century. This Byzantine book shows a spine with a metal piano hinge type design. It, as well as an eighteenth-century Roman book — also with metal hinges — is included in *La Reliure d’Art*, by Giulia Bologna (Paris: Grund, 1999, pp. 9, 144). The Byzantine book can also be seen in the catalog *The Glory of Byzantium: Art and Culture of the Middle Byzantine Era, A.D. 843–1261* (New York: Metropolitan Museum of Art; distributed by H. N. Abrams, 1997, p. 88). These historical examples are humbling reminders that there is nothing new under the sun.

2. In fact, if necessary, there is a way to search by date, but it is very painstaking and time-consuming: it involves looking at each image, in order by date, under the category Patent Number Search. All of this effort would have been avoided if Google Patent Search had been available at the time this album was being researched.

3. Staples Crystal Clear Paste Wax (with imported carnauba) contains no synthetics, no silicone, and no “soft beeswax.” It is reversible with mineral spirits. This wax was applied by Arms and Armor conservation staff of the Metropolitan Museum of Art. The metal was first warmed with a hot air gun before the first application. The coating was applied, and when dry, buffed. The warmed wax flows into any pitting, crevices, or cracks, creating a more uniform coating. A second coat was applied, dried,

and also buffed. It provided additional smoothness and toughness for the constant contact and friction from the motion of the loop hinge segments.

4. An example of Beaty’s cradle-box was presented at the exposition *The Changing Book: Traditions in Design, Production & Preservation*, which took place in Iowa City, July 22–25, 2005. A variation of the cradle-box was also found in the article by Cartier Bresson and Nyeberg, referenced below, pp. 33, 36. They call the support in their box a “lutrin moderne de consultation” (modern consultation lectern). It differs from Beaty’s box in that they line the boards with Propyflex (polypropylene) instead of cloth and paper, and the support is constructed from only one fold-out piece instead of two.

## REFERENCES

- Anderson, P., and A. Puglia. 2003. Solvent-set book repair tissue. *The Book and Paper Group Annual* 22:3–8.
- Cartier Bresson, A., and P. E. Nyeberg. 1998. De Disdéri à la photographie lettriste; les choix d’intervention sur les albums photographiques à la Ville de Paris. In *L’Album photographique; histoire & conservation d’un objet; Journées d’études du Groupe Photographie de la Section française de l’Institut international de conservation*, 27–37. Paris: L’Institut International de Conservation.
- Duffy, M. C. 1989. A study of acrylic dispersions used in the treatment of paintings. *Journal of the American Institute for Conservation* 28(2):66–67.
- Eldridge, B. P. 2002. A photo album structure from Philadelphia, 1865. *The Book and Paper Group Annual* 21:35–43.
- Mets, J. D. 1863. Improvement in photographic albums. U.S. Patent 39,300. Assigned to Altemus & Company, Philadelphia, Penn.
- Primanis, O. 1999. Interim report on the HRHRC photograph album survey: 1. Nineteenth-century photograph albums: Structures, conditions, and treatments. In *Conservation of Scrapbooks and Albums*, 47–64. Washington, D.C.: American Institute for Conservation.
- Rutherford, J. 1999. Victorian album structures. *The Paper Conservator* 23:13–25.
- Taft, R. 1938. *Photography and the American Scene, A Social History*. New York: Macmillan Company.
- Wootton, M., T. Boone, and A. Robb. 1999. The structure’s the thing! Problems in the repair of nineteenth-century stiff-paged photograph albums. In *Conservation of Scrapbooks and Albums*, 37–44. Washington, D.C.: American Institute for Conservation.

## MATERIALS

Metal rods: “piano wire”



Metalliferous  
34 West 46th St.  
New York, NY 10036  
(888) 944-0909  
[www.metalliferous.com](http://www.metalliferous.com)

Staples Crystal Clear Paste Wax  
H. F. Staples & Co.  
P.O. Box 956  
Merrimack, NH 03054  
(800) 682-0034  
[www.hfstaples.com](http://www.hfstaples.com)

100% Cotton Flannel  
Test Fabrics  
415 Delaware Ave.  
P.O. Box 26  
West Pittston, PA 18643  
(570) 603-0432  
[www.testfabrics.com](http://www.testfabrics.com)

Lascaux 360 HV and 498 HV  
Talas  
20 West 20th, fifth floor  
New York, NY 10011  
(212) 219-0770  
[www.talasonline.com](http://www.talasonline.com)

JAE CAREY  
Senior Book Conservation Associate  
Metropolitan Museum of Art  
New York, New York  
[jae.carey@metmuseum.org](mailto:jae.carey@metmuseum.org)