

802.11ad - WLAN at 60 GHz

A Technology Introduction

White Paper

Data rates in the range of several Gigabit/s are needed to transmit signals like uncompressed video signals. Amendment 802.11ad to the WLAN standard defines the MAC and PHY layers for very high throughput (VHT) in the 60 GHz range. The specification 802.11-2016 has defined additional modulation and coding schemes for the 11ad single carrier part to increase the data rate. The OFDM part is obsolete.

This white paper provides an introduction to the technology behind 802.11ad and highlights the test and measurement requirements.

Note:

Please find the most up-to-date Application Note on our homepage <http://www.rohde-schwarz.com/appnote/1MA220>.

WLAN 802.11ad – 1MA220_3e (11.2017)

Contents

1	Introduction.....	3
2	Key Features.....	5
3	The 11ad Physical Layer (PHY).....	6
4	Measurement Requirements.....	22
5	Appendix.....	26
6	Rohde & Schwarz.....	29

1 Introduction

Digital wireless communications will always demand more throughput than is available. Especially when several users must share the same physical resources, only a fraction of the nominal throughput remains. Multimedia data streams in particular require very high throughput on a continuous basis. One example is uncoded 3D high definition video streams (currently at 4k resolution (Ultra-HD: 3840 x 2160 pixels), and the trend is toward higher frame rates of e.g. 48 frames per second).

To meet this need, the 802.11ad specification for wireless transmission of data (originally for video streams) in the 60 GHz band provides speeds in the multi-Gigabit range.

Why the 60 GHz band?

In the range around 60 GHz, an unlicensed frequency band is available everywhere in the world. This range permits higher channel bandwidths for greater throughput. Another advantage is the small wavelengths (approx. 5 mm). These make it possible to use compact and competitive antennas or antenna arrays (e.g. for beamforming).

At first glance, however, this range also has some apparent disadvantages:

- very high free field attenuation in this band. (attenuation after 1 m: 68 dB, after 10 m: 91 dB)
- oxygen (O₂) absorption

However, because the transmission typically takes place within a limited range of under 10 m (the typical living room), the high degree of attenuation can also be seen as an advantage. Interference from adjacent transmissions is very unlikely. The transmission is very difficult to intercept, making it even more secure. Finally, beamforming can be used to focus the power to the receiver.

WLAN 802.11

The 802.11 WLAN standard has also been continuously updated to permit higher throughput. These changes were developed as amendments, but have since been assigned their own letter as enhancements to the standard using the MAC and PHY layers. The relevant standard enhancements are 11a,b,g,n and these cover the two bands in the 2.4 GHz and the 5 GHz range. The 11n extension (also called High Throughput (HT)) uses up to four MIMO streams to achieve a data rate of up to 600 Mbit/s. The 11p standard is an extension that permits robust data traffic between automobiles (car to car).

You can read more about the various standards in The WLAN Universe [3]. For T&M possibilities using Rohde & Schwarz instruments, refer to

- <http://www.rohde-schwarz.com/appnote/1MA169>
- <http://www.rohde-schwarz.com/appnote/1MA179>
- <http://www.rohde-schwarz.com/appnote/1EF82>
- <http://www.rohde-schwarz.com/appnote/1MA152>

The latest developments are known as Very High Throughput (VHT) and are specified in different new parts:

- 11ac is intended for the frequency range under 6 GHz and uses "conventional" technologies, such as those seen in 11n. It uses bandwidths of up to 160 MHz and eight MIMO streams to achieve data rates of more than 1 Gbit/s for the 80 MHz bandwidth (see <http://www.rohde-schwarz.com/appnote/1MA192>).
- 11ax improves the user experience of the "conventional" technologies by using multi-user techniques like Multi-User-MIMO (MU-MIMO) and OFDMA (see <http://www.rohde-schwarz.com/appnote/1MA222>).
- 11ad covers the frequency range at 60 GHz.

Chapter 2 provides an overview of the key features.

Chapter 3 provides a detailed explanation of the three different PHYs being used and highlights the differences.

Chapter 4 describes the T&M requirements.

2 Key Features

802.11ad includes the following key features:

- Support for data rates of up to 8 Gbit/s, divided into
 - a mode with simple, robust modulation, but lower data rates (single carrier),
 - an energy-saving mode for battery-operated devices (single carrier low power)
 - and a high-performance mode with OFDM technology for very high throughput
- Use of the 60 GHz unlicensed band
 - provides global availability
 - avoids the overcrowded 2.4 GHz and 5 GHz bands
 - uses short wavelengths (5 mm at 60 GHz), making compact and affordable antennas or antenna arrays possible
- Beamforming
 - optimizes power at the receiver.
 - provides necessary antenna gain to compensate high free space pass loss
 - overcomes interference (e.g. changes in the channel conditions caused by obstacles) during the transmission in realtime
- is fully integrated in the WLAN universe
 - "triband" devices: across both bands 2.4 GHz and 5 GHz, plus 11ad in the 60 GHz range
 - Seamless use of 802.11a,b,g,n,ac,ax: "fast session transfer"

Typical applications for 11ad are:

- Wireless Display
- Distribution of HDTV content (e.g. in residential living rooms)
- Wireless PC connection to transmit huge files quickly
- Automatic sync applications (e.g. uploading images from a camera to a PC, "kiosk" applications)

3 The 11ad Physical Layer (PHY)

The 11ad physical layer was originally added as an amendment, and now is included as chapter 20 of the 802.11-2016 standard. It is called "Directional Multi-Gigabit (DMG) PHY". This chapter provides a detailed description of the various implementations. Standard 2016 defines new MCSs to increase the data rate for Single Carrier mode with 64-QAM modulation up to 8 Gbit/s. The OFDM mode is now obsolete.

3.1 Channels

The nominal channel bandwidth is 2.16 GHz. The useful ISM band around 60 GHz (57 GHz to 66 GHz) is regulated differently in various regions of the world. Six channels are defined for this band, but they are not universally available. Channel 2 is available in all regions and is therefore used as the default channel.

Table 3-1: Channel numbers in the 60 GHz band

Channels	
1	58.32 GHz
2	60.48 GHz
3	62.64 GHz
4	64.80 GHz
5	66.96 GHz
6	69.12 GHz

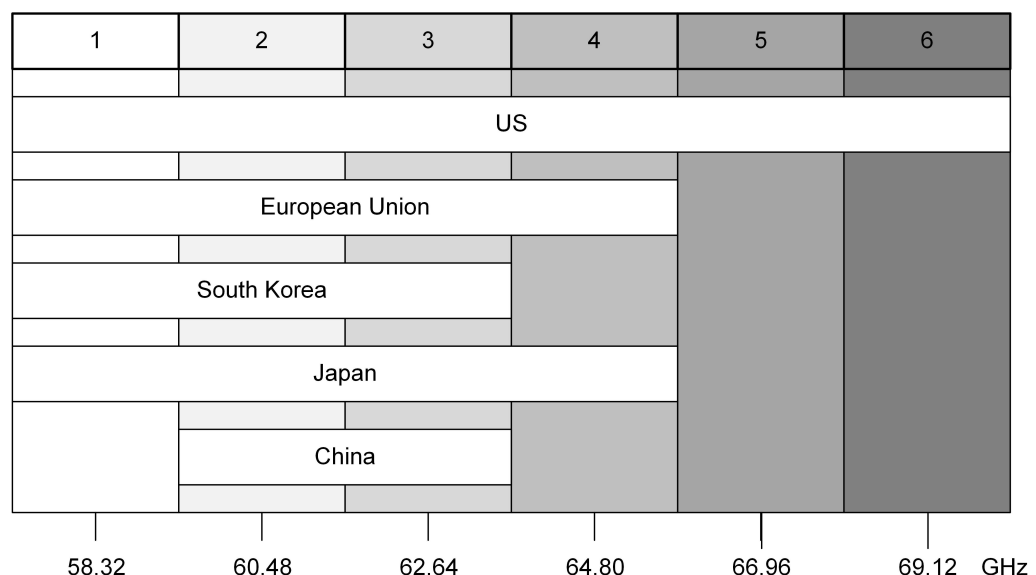

Figure 3-1: Channels in the 60 GHz band

A transmitter operating in this band must match a spectrum mask; see [Chapter 4, "Measurement Requirements"](#), on page 22.

3.2 Directional multi-Gigabit (DMG): Three different PHYs.

In principle, three different modulation modes are available. They make it possible to fulfill differing requirements (such as high throughput or robustness). Not all three modes need to be supported by every implementation. **The use of the OFDM mode is obsolete. Consequently, this option may be removed in a later revision of the standard.** The low-power Single Carrier mode is optional.

Table 3-2: Three different PHYs.

PHY	MCS	Comment
Control PHY	0	
Single carrier PHY (SC PHY)	1...12 25...31	mandatory (low power SC PHY), optional
OFDM PHY	13...24	optional, obsolete

All DMG PHYs use the same packet structure, but they differ in how the individual fields are defined as well as in the coding and modulation that is used.

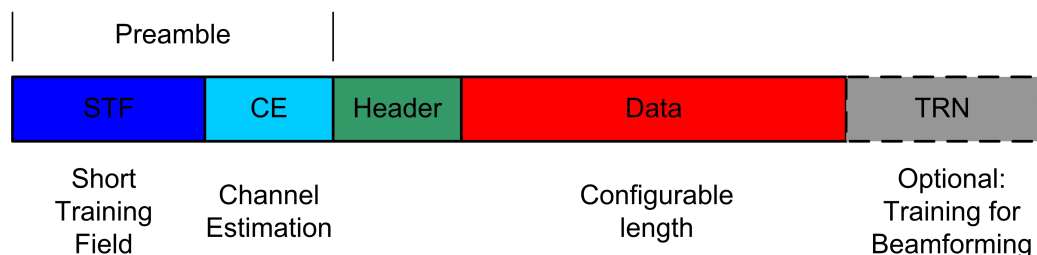

Figure 3-2: General structure of a packet in 11ad.

A packet is made up of the following common parts:

- **Preamble**
The preamble consists of the short training field (STF) and the channel estimation (CE) field. It is required in every packet. It supports the receiver during automatic gain control (AGC), when recognizing the packet and in estimating the frequency offset, and it displays the type of PHY that is used (SC or OFDM). The receiver can also use the known CE field to estimate the channel.
- **Header**
The header is different for every PHY and contains additional important information for the receiver, such as the modulation mode (MCS), the length of the data field or a checksum.
- **Data**
This part is used to transmit the actual data with different modulations (MCS). The length of the field varies (number of bytes/octets).
- **TRN**

This field is optional and can be appended to all packets. It allows to optimize beamforming settings (see [Chapter 3.3, "Beamforming"](#), on page 17)

Individual fields in the packets (e.g. the preamble) are made up of Golay sequences (see [Chapter 5.1, "Golay Sequences"](#), on page 26) Each sequence consists of bipolar symbols (± 1). They are constructed mathematically in order to achieve specific auto-correlation characteristics. Each consists of a complementary pair (a and b). An additional index contains the length of the sequence. For example, G_a128 and G_b128 represent a complementary sequence with a length of 128. In addition, four specific G_x128 are then logically combined into G_u512 or G_v512

The single carrier PHYs (SC, low power SC and control) nominally use a bandwidth of 1760 MHz, while the OFDM PHY uses 1830.47 MHz.

3.2.1 Control PHY

This mode is used to exchange signaling and/or control messages in order to establish and monitor connections between the various devices. Support for this mode is therefore mandatory for all devices. MCS0 was selected to provide very robust transmission that can withstand possible interference in the channel. BPSK modulation is used and the preamble (STF) is longer than in the other packets to make the transmission more robust.

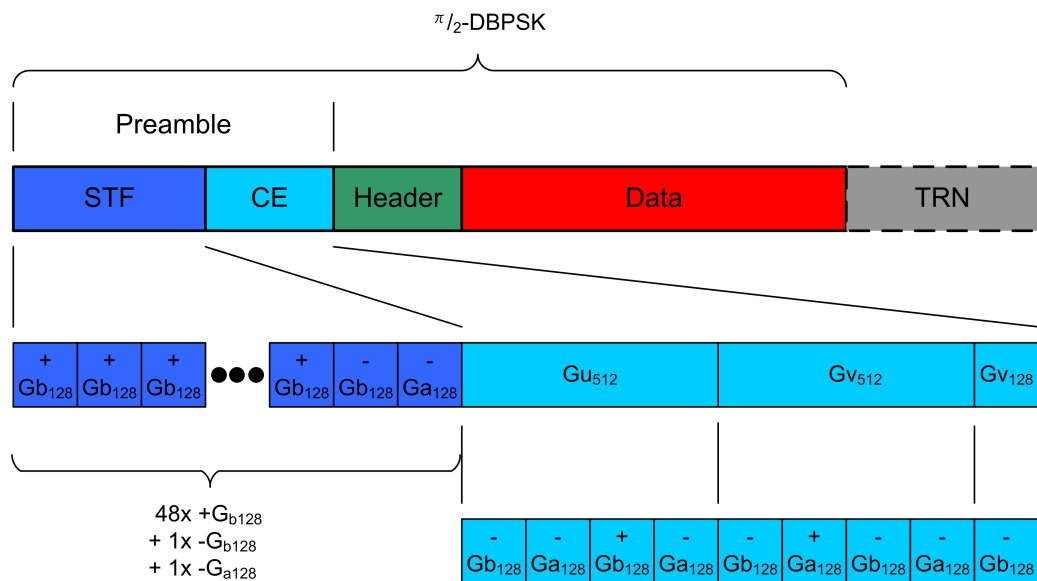

Figure 3-3: Control packet preamble: STF consists of 50 $G128$ sequences and CE transmits $G_u + G_v$.

The STF is made up of a total of 50 $G128$ sequences. G_b128 is first repeated 48 times, followed by one $-G_b128$ and one $-G_a128$. As a result, the STF is $50 \times 128 = 6400 T_c$ in length. The CE field consists of one G_u512 and one G_v512 , followed by a $-G_b128$ sequence. The same CE field is also used for SC PHY. As a result, the CE field is $9 \times 128 = 1152 T_c$ in length.

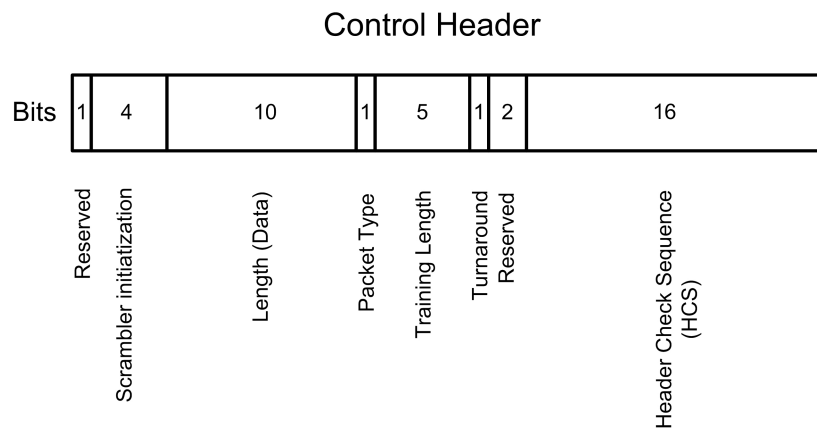

Figure 3-4: Control packet header (40 bits).

The control header is a total of 40 bits in length. The most important fields are explained here:

- Scrambler initialization: Provides the start point for the scrambler (see [Figure 3-5](#))
- Length (data): Specifies the length of the data field. For control, the range is 14 octets to 1023 octets
- Packet type: Specifies whether the beamforming training field is intended for the receiver or the transmitter. It carries no information when Training Length = 0
- Training length: Specifies whether a beamforming training field is used and if so, how long it is
- HCS: Provides a checksum per CRC for the header

The data to be transmitted is scrambled, coded, modulated and spread.

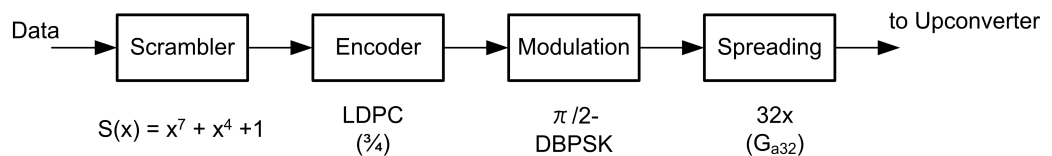

Figure 3-5: Control packet: Data processing.

- The scrambler is the same for all PHYs; only the initialization value is set differently (transmitted in the header)
- For the encoding, a low-density parity check (LDPC) coder is used. It always uses a codeword length of 672 bits, and the coding rate varies depending on the PHY. The 3/4 matrix with shortening is used here, which results in a code rate of 1/2 or less.
- Differential BPSK is used as a robust modulation. It is shifted by $\pi/2$ to avoid zero crossings in the I/Q diagram. As a result, the difference between the peak and average power remains low.
- Finally, the signal is spread with a G_{a32} sequence.

3.2.2 Single Carrier Modes

In SC mode, from 385 Mbit/s up to 8.085 Gbit/s are transmitted depending on the MCS. To support mobile devices that are sensitive to power consumption, an additional (optional) low-power SC mode with an energy-saving encoder is defined.

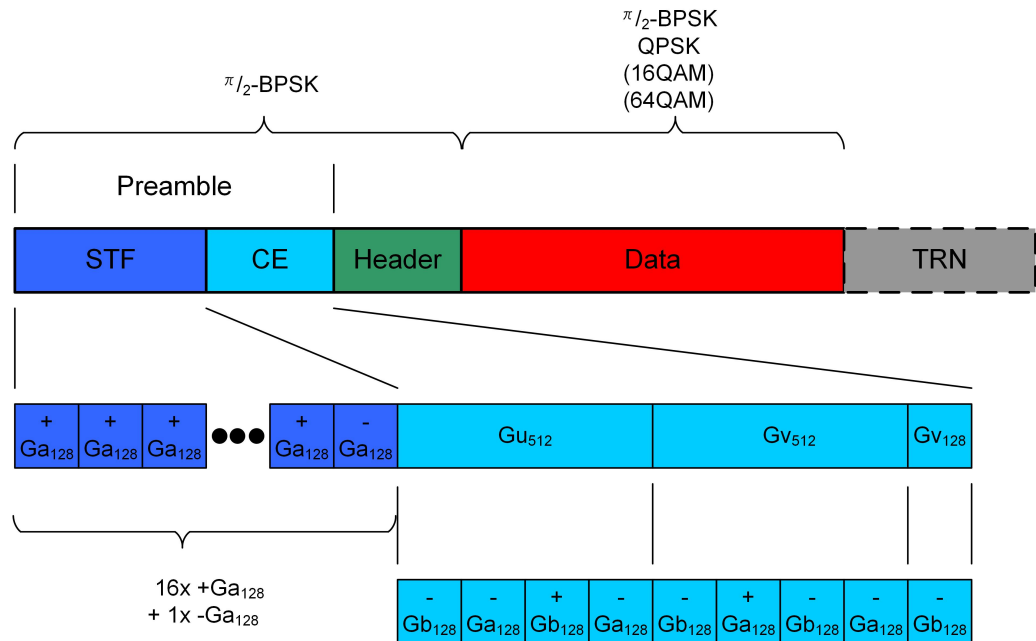

Figure 3-6: SC packet preamble: STF consists of 17 G_{a128} sequences and CE transmits $G_u + G_v$.

The basic packet structure is the same for both SC types. In the case of the low-power PHY, the 16QAM and 64QAM modulation is not used during data transmission in order to save energy. The STF is made up of a total of 17 G_{128} sequences. G_a128 is first repeated 16 times, followed by one $-G_a128$. As a result, the STF is $17 \cdot 128 = 2176 T_c$ in length. The CE field consists of one G_u512 and one G_v512 , followed by a $-G_b128$ sequence. As a result, the CE field is $9 \cdot 128 = 1152 T_c$ in length. The same CE field is also used in the control PHY.

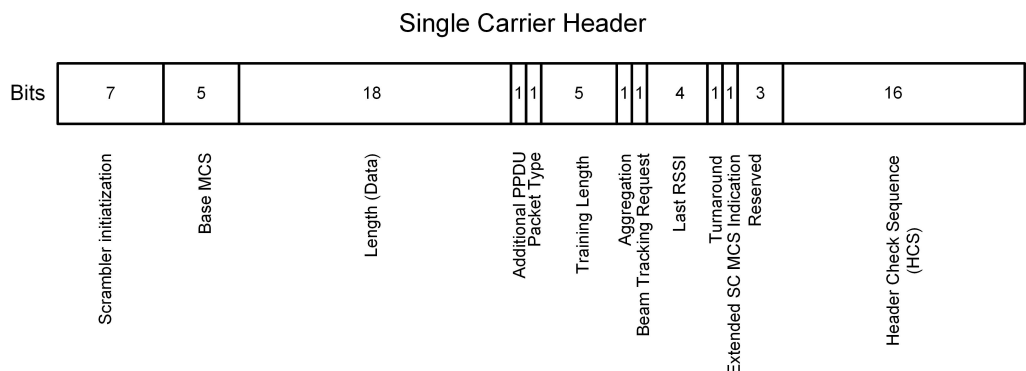

Figure 3-7: SC packet header (64 bits).

The SC header is a total of 64 bits in length. The most important fields are explained here:

- Scrambler initialization: Provides the start point for the scrambler (see [Figure 3-5](#))
- MCS: Displays the modulation and coding scheme used in the data field
- Length (data): Specifies the length of the data field. For control, the range is 1 octet to 262143 octets
- Packet type: Specifies whether the beamforming training field is intended for the receiver or the transmitter. It carries no information when Training Length = 0
- Training length: Specifies whether a beamforming training field is used and if so, how long it is
- Last RSSI: Displays the power level of the last field received
- Extended SC MCS: indicates the use of the new MCSs
- HCS: Provides a checksum per CRC for the header

The additional steps for the data field differ for SC PHY and for low-power SC PHY.

3.2.2.1 SC PHY

This method is the simplest transmission option. A total of 19 MCS (1 to 12, and 9.1, 12.1 to 12.6) are defined, whereby support for MCS 1 to 4 is mandatory. The various MCSs have different modulations and code rates, and therefore also different throughputs. MCS1 (BPSK and code rate 1/2) can achieve 385 Mbit/s, MCS4 (BPSK and code rate 3/4) up to 1.115 Gbit/s and MCS12 (16QAM and code rate 3/4) up to 4.620 Gbit/s, and with extended MCS12.6 (64QAM and code rate 7/8) up to 8.085 Gbit/s. A complete table of MCS for SC PHY is available at [1 - Table 20-19].

The data to be transmitted is scrambled, coded, modulated and blockwise transmitted.

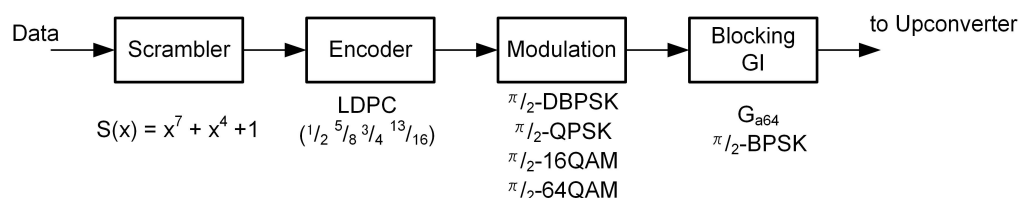

Figure 3-8: SC PHY packet: Data processing.

- The scrambler is the same for all PHYs; only the initialization value is set differently (transmitted in the header)
- A low-density parity check (LDPC) coder is used for the encoding. It always uses a codeword length of 672 bits, and the coding rate varies depending on the PHY. In this case, code rates 1/2, 5/8, 3/4, 7/8 and 13/16 are used.
- Depending on the data rate, various types of modulation are used (BPSK, QPSK, 16QAM and 64QAM). Each is shifted by $\pi/2$ to avoid zero crossings in the I/Q diagram. As a result, the difference between the peak and average power remains low.
- The data are transmitted blockwise at 448 symbols per block. Another 64 symbols are inserted between the individual blocks as guard intervals (GI) in order to pro-

vide a known reference signal to the receiver in the case of long data packets. The complete block is therefore 512 (448 + 64) symbols in length. The GI consists of a Ga64 Golay sequence and is always modulated with $\pi/2$ -BPSK.

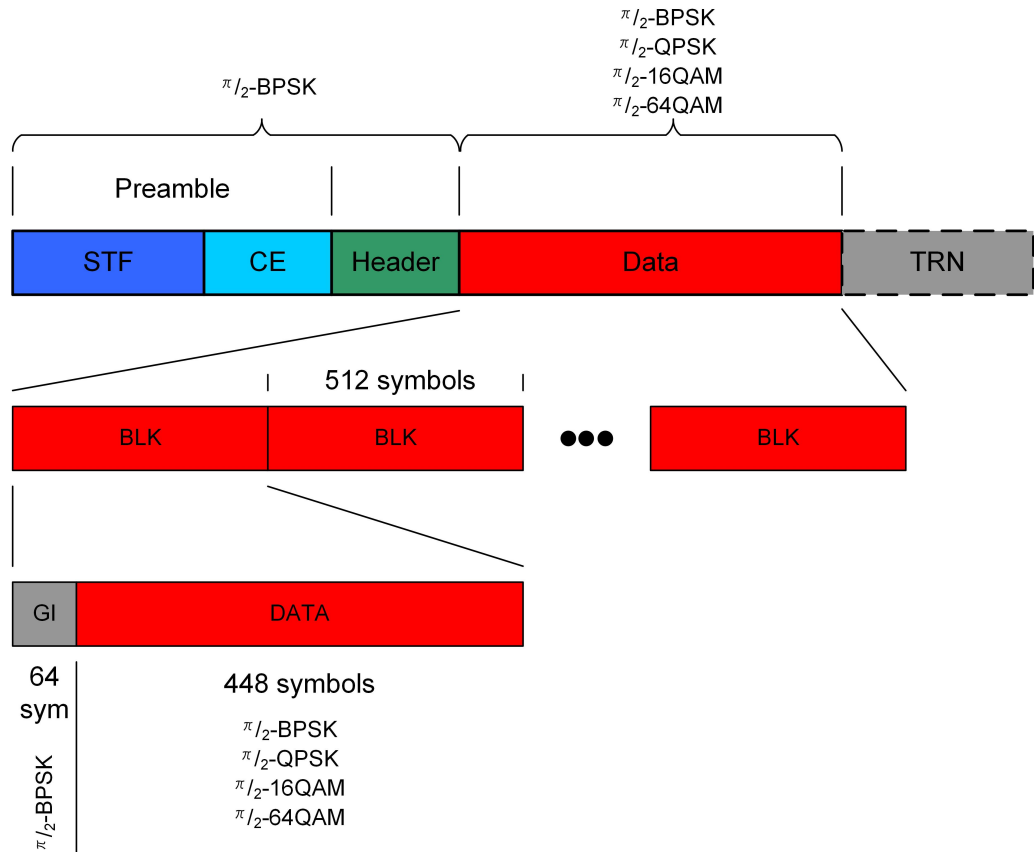

Figure 3-9: SC PHY data blocks: A data block is made up of 512 symbols (64 GI + 448 data).

3.2.2.2 Low-power SC PHY

This method is set up similarly to the SC PHY, but it is optimized to save energy in order to support small, battery-operated devices as well. In contrast to all other PHYs, the LDPC is replaced by an energy-saving alternative, and unlike SC PHY, 16QAM modulation is not used. A total of seven MCS (25 to 31) are defined, and all are optional. The various MCSs have different modulations and code rates, and therefore also different throughputs. MCS25 (BPSK and code rate 13/28) permits rates of 626 Mbit/s to be achieved, and for MCS31 (QPSK and code rate 13/14) it is up to 2.503 Gbit/s. A complete table of MCS25 to 31 for low-power SC PHY is available at [1 - Table 20-23].

The data to be transmitted is scrambled, coded, modulated and blockwise transmitted.

Directional multi-Gigabit (DMG): Three different PHYs.

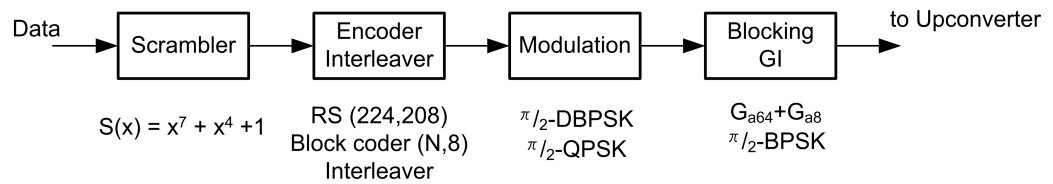

Figure 3-10: Low-power SC PHY packet: Data processing.

- The scrambler is the same for all PHYs; only the initialization value is set differently (transmitted in the header)
- A Reed-Solomon (RS 224,208) coder and a (Hamming) block code (N,8) are used for the encoding. The data is also interleaved. The coding rate varies depending on MCS.
- Depending on the data rate, various types of modulation are used (BPSK or QPSK). Each is shifted by $\pi/2$ to avoid zero crossings in the I/Q diagram. As a result, the difference between the peak and average power remains low.
- The data are transmitted blockwise at 512 symbols per block in this case as well. Another 64 symbols are inserted between the individual blocks as guard intervals (GI) in order to provide a known reference signal to the receiver in the case of long data packets. The GI consists of a G_{a64} Golay sequence and is always modulated with $\pi/2$ -BPSK. An additional eight symbols are inserted after every 56 symbols to act as a guard block. The guard block is a copy of the final eight symbols from the G_{a64} sequence. A block of 512 symbols therefore includes 392 data symbols. A final G_{a64} is transmitted at the end of all blocks (i.e. at the end of the data range).

Directional multi-Gigabit (DMG): Three different PHYs.

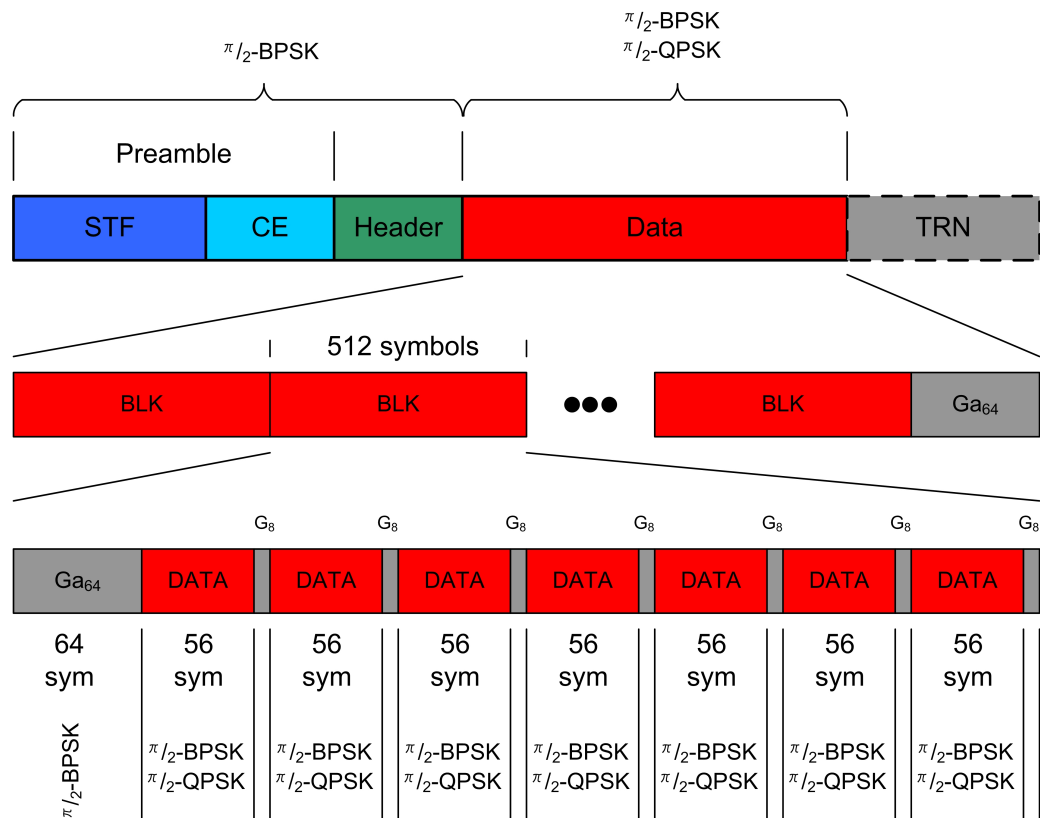

Figure 3-11: Low-power SC PHY data blocks.

3.2.3 OFDM PHY

The use of the OFDM mode is obsolete.

To achieve the highest data rates, an OFDM mode was implemented. OFDM is also used in 802.11n, LTE(A) or DVB-T.

A total of 12 MCS (13 to 24) are defined. The various MCSs have different modulations and code rates, and therefore also different throughputs. MCS13 (SQPSK and code rate 1/2) permits rates of 693 Mbit/s to be achieved, and for MCS24 (64QAM and code rate 13/16) it is up to the maximum possible rate of 6.757 Gbit/s. A complete table of MCS13 to 24 for OFDM PHY is available at [1 - Table 20-14]. OFDM mode is optional, but when it is implemented, MCS 13 to 17 must be supported.

Directional multi-Gigabit (DMG): Three different PHYs.

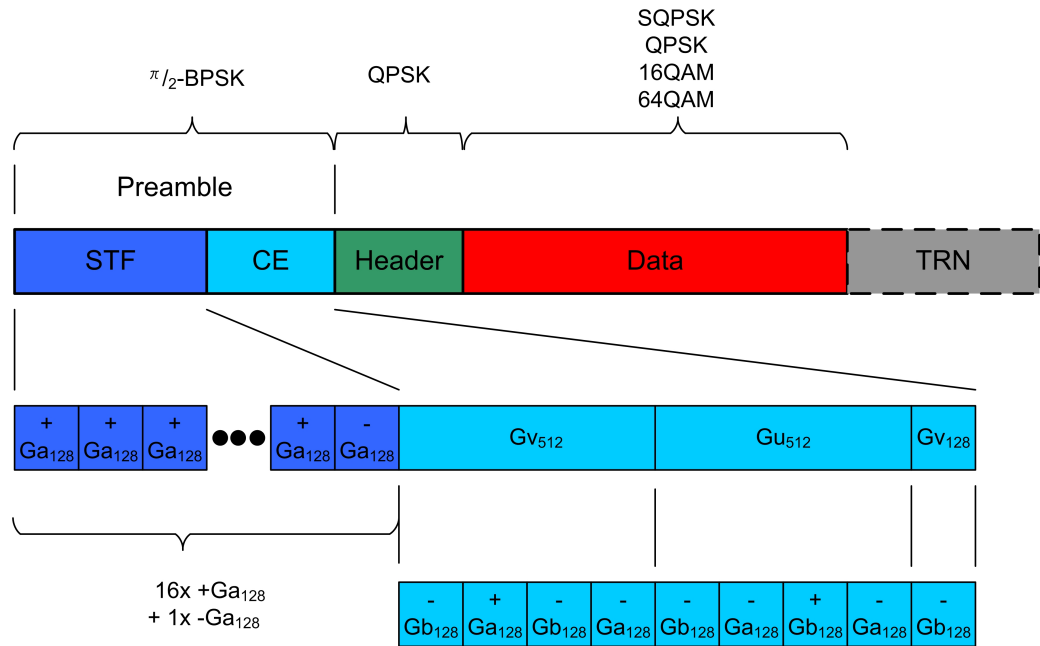

Figure 3-12: OFDM packet preamble: STF consists of 17 G_{a128} sequences and CE transmits $G_v + G_u$.

The basic packet structure is the same as the SC packet. However, to permit the receiver to differentiate this packet from the SC packet, the sequence of G_u and G_v is swapped in the CE field. The STF is made up of a total of 17 G_{128} sequences. G_a_{128} is first repeated 16 times, followed by one $-G_a_{128}$. As a result, the STF is $17 \cdot 128 = 2176 T_c$ in length. The CE field consists of one G_v_{512} and one G_u_{512} , followed by a $-G_b_{128}$ sequence (the sequence of the SC-CE field is swapped). As a result, the CE field is $9 \cdot 128 = 1152 T_c$ in length.

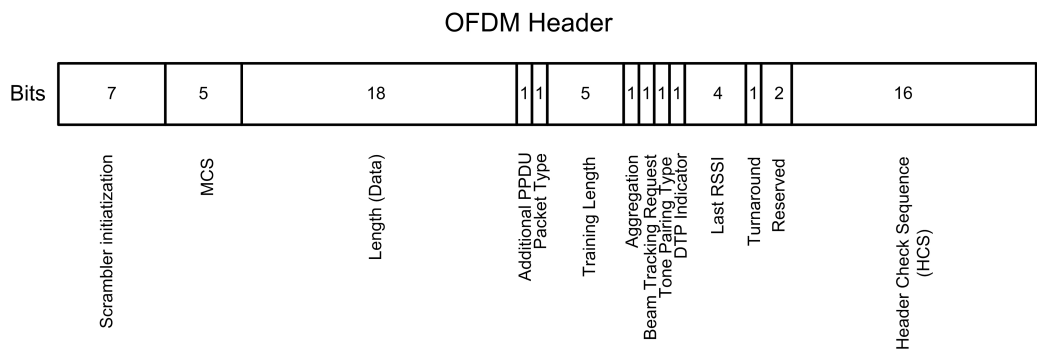

Figure 3-13: OFDM header (64 bits).

The OFDM header is a total of 64 bits in length. The most important fields are explained here: The basic structure is similar to the SC, except for two additional bits specific to OFDM:

- Scrambler initialization: Provides the start point for the scrambler (see Figure 3-5)
- MCS: Displays the modulation and coding scheme used in the data field

Directional multi-Gigabit (DMG): Three different PHYs.

- Length (data): Specifies the length of the data field. For control, the range is 1 octet to 262143 octets
- Packet type: Specifies whether the beamforming training field is intended for the receiver or the transmitter. It carries no information when Training Length = 0
- Training length: Specifies whether a beamforming training field is used and if so, how long it is
- Tone pairing type: Specifies the tone pairing used for MCS13 to 17 (see below)
- Last RSSI: Displays the power level of the last field received
- HCS: Provides a checksum per CRC for the header

The data to be transmitted is scrambled, coded, modulated and transmitted via OFDM.

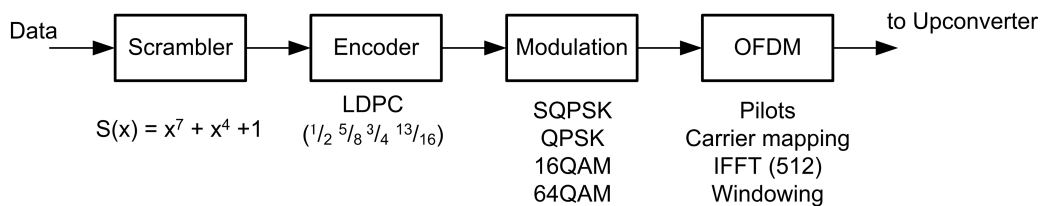

Figure 3-14: OFDM: Data processing.

- The scrambler is the same for all PHYs; only the initialization value is set differently (transmitted in the header)
- A low-density parity check (LDPC) coder is used for the encoding. It always uses a codeword length of 672 bits, and the coding rate varies depending on the PHY. In this case, code rates $1/2$, $5/8$, $3/4$ and $13/16$ are used.
- Different modulations are used depending on the data rate (spread QPSK (SQPSK), QPSK, 16QAM and 64QAM). The following special behaviors apply for SQPSK and QPSK:
 - Tone pairing is employed, where two subcarriers at a specified frequency offset transmit the same data. This makes the transmission more robust to frequency-selective interference. In static tone pairing (STP), which is mandatory for all implementations, the frequency offset is always one half the subcarriers (336 subcarriers/ $2 = 118$). There is also an optional dynamic tone pairing (DTP), which is used to allow a response to varying channel conditions.
 - In the case of SQPSK, only one half of the carriers are modulated with QPSK, and the other half contain a (conjugated complex) copy of the data.
 - In the case of QPSK, a matrix is additionally used for multiplexing at the I/Q level. Bits 0 and 2 or bits 1 and 3 are combined into a four-way group via QPSK modulation. Group 1 (bits 0 and 2) are transmitted in the first subcarrier and group 2 (bits 1 and 3) on the associated tone pairing subcarrier, and so on.

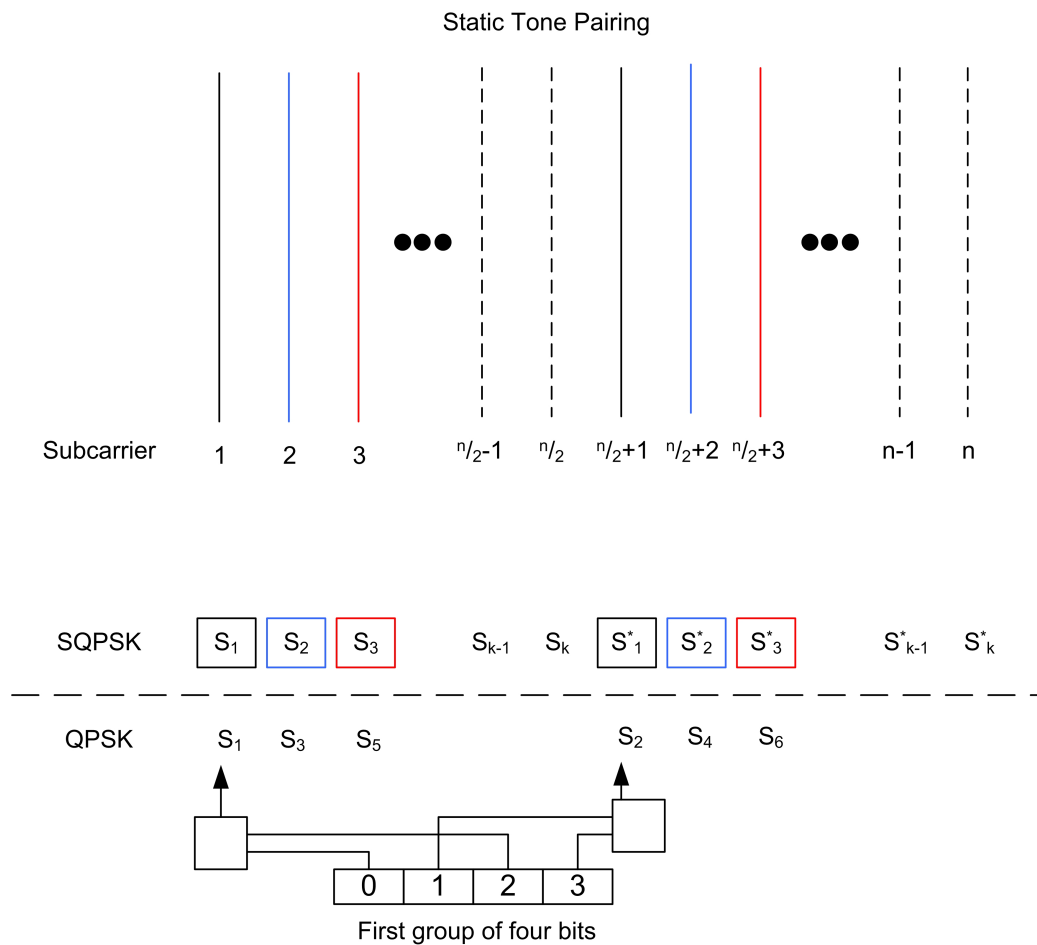

Figure 3-15: Tone pairing with OFDM.

- A 512-point FFT is used for the allocation to the individual subcarriers. A total of 355 subcarriers at a distance of 5.15625 MHz are used, resulting in a total bandwidth of 1830.47 MHz. The 355 subcarriers consist of 16 pilots, 3 DC and 336 data carriers. The guard interval is 1/4 of a symbol. The pilots are located on carriers 10, 30, 50, 70, 90, 110, 130 and 150, each \pm . The three DC carriers are located in the middle (-1 , 0 and $+1$) and are suppressed (nulled).

3.3 Beamforming

Transmission in the 60 GHz range is subject to greater free-space loss than in the 2.4 GHz or 5 GHz range. The channel conditions can change dramatically during a connection (for example, someone moves between a BluRay player and a projector during a 3D-HD connection). Both can be managed in realtime by using beamforming. Because the antenna size in the 60 GHz band is very compact, small and competitive antenna arrays can be used. 802.11ad supports beamforming in realtime. During the beam refinement process, training sequences for beamforming are sent between the transmitter and receiver and evaluated. The best antenna weightings for each situation can then be set.

Beamforming training sequences can be appended to all PHY packets (control, SC, low-power SC and OFDM) for this purpose. The packet type and training length are set accordingly in the respective header.

- Packet type:
 - 0 Receiver training
 - 1 Transmitter training
- Training length:
 - Parameter n length -> AGC contains 4n fields
 - TRN contains 5n fields

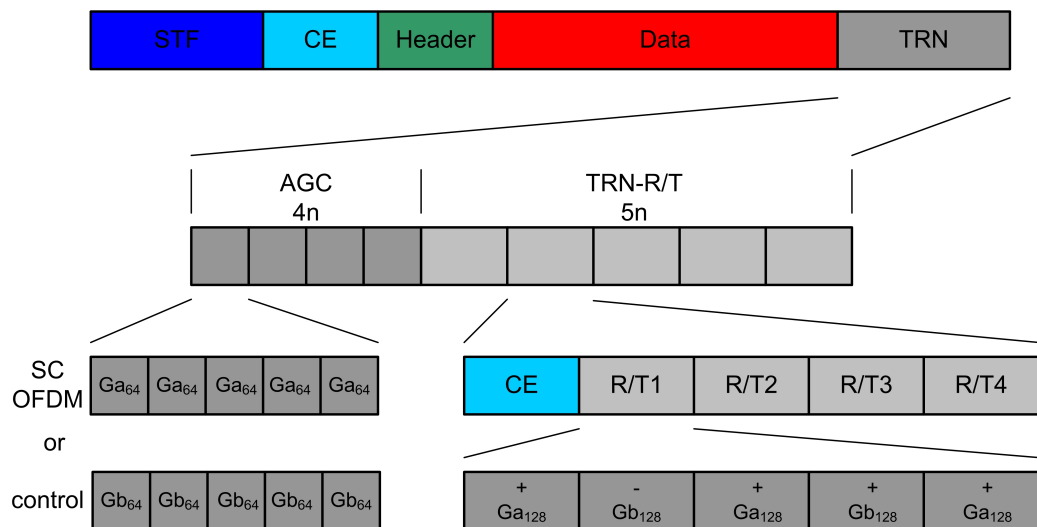

Figure 3-16: Beamforming TRN.

The antenna configuration cannot be changed during the "normal" packet (STF, CE, header, data).

The AGC field consists of 4n repetitions of five G64 sequences. G_a64 is used for SC and OFDM packets, and G_b64 is used for control packets. In the case of a transmitter packet, the antenna weighting can be changed for every individual AGC field; however, it must be the same for the subfields. For a receiver field, the antenna weighting must be the same as in the rest of the packet (preamble and data).

The training field consists of 5n repetitions of a block. This includes a copy of the CE field from the preamble, followed by five G128 sequences. For the CE field, the same antenna weighting must be used as in the packet (preamble and data).

All training fields must be transmitted with $\pi/2$ -BPSK modulation.

3.4 Overview

This section provides a summary of the various PHYs.

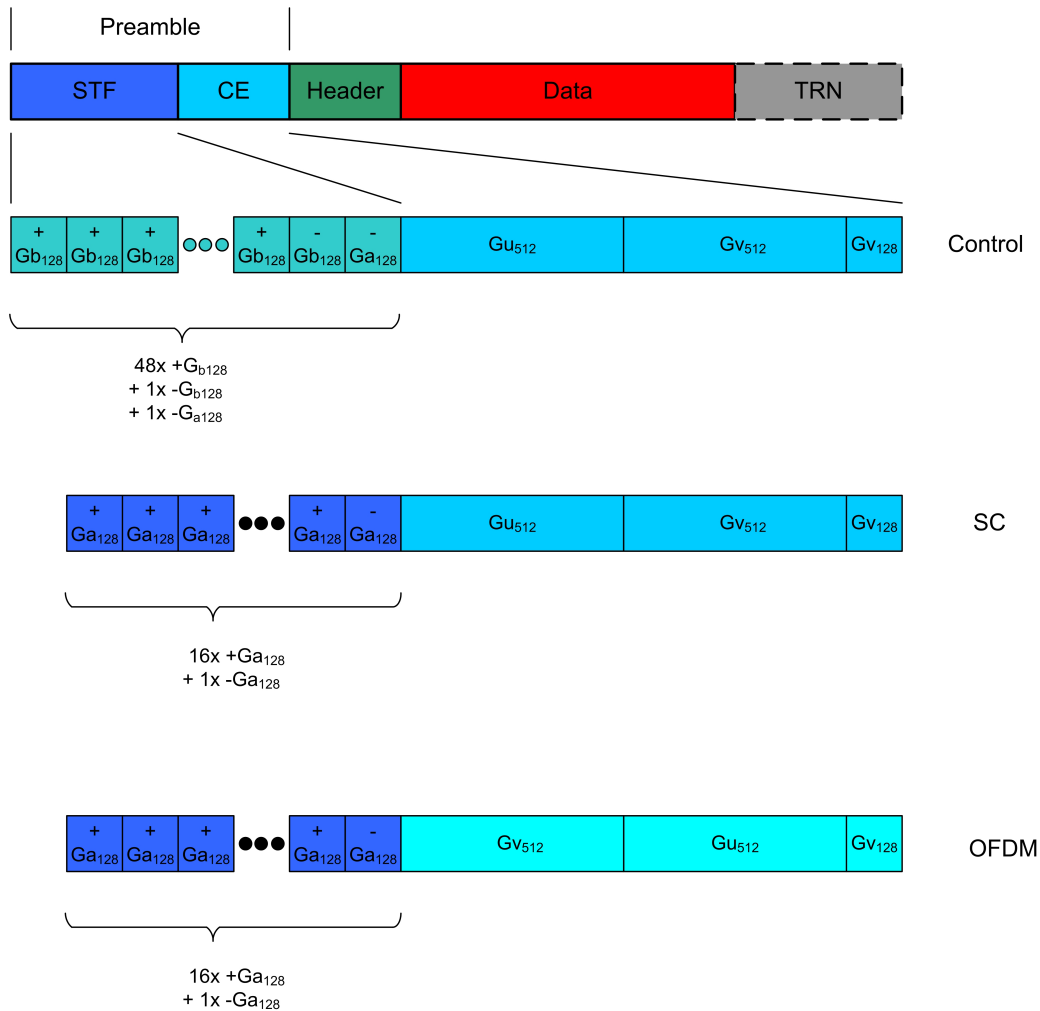

Figure 3-17: Overview of different preambles: Top for control, middle for SC, and bottom for OFDM.

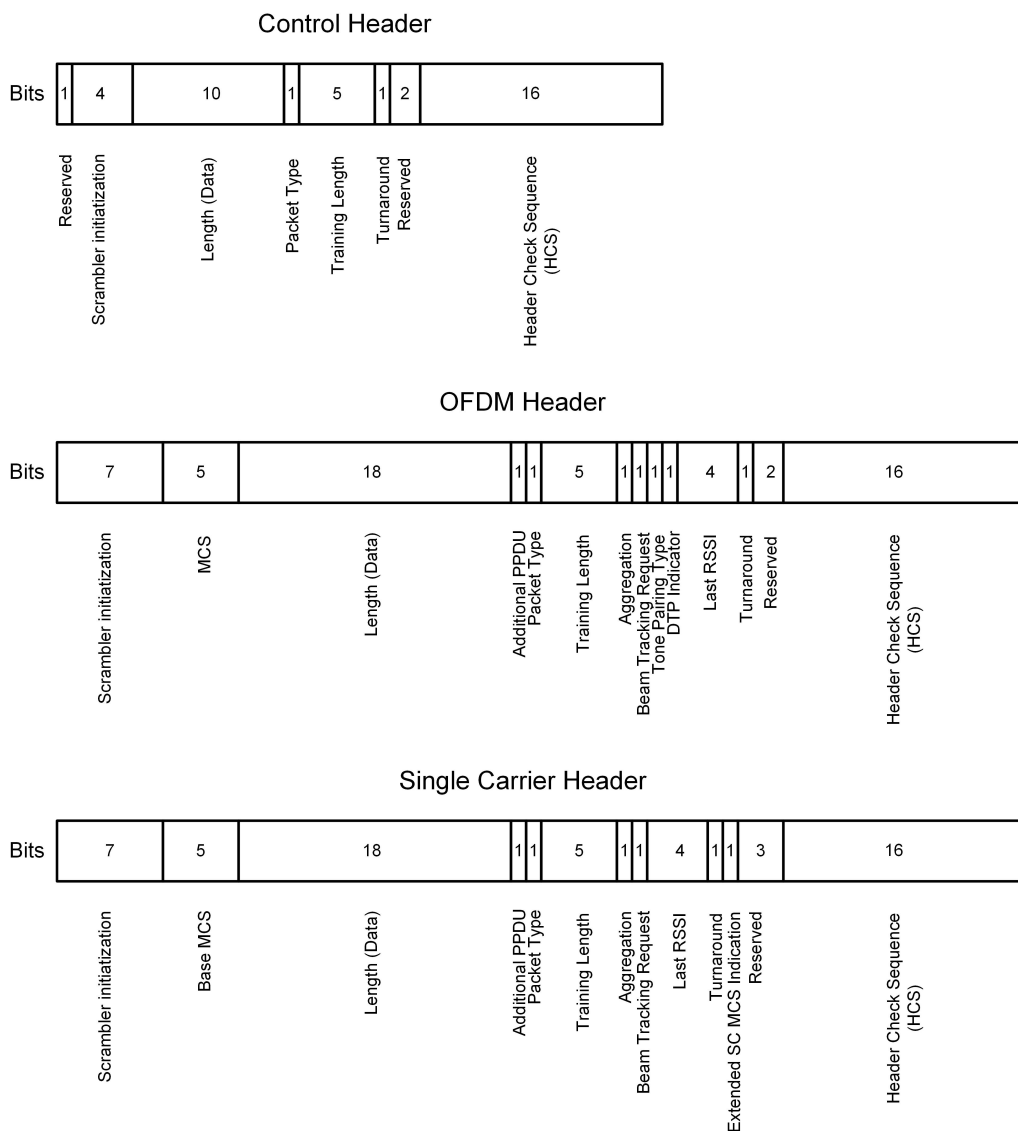

Figure 3-18: Overview of different headers: Top for control 40 bits, middle for OFDM 64 bits, and bottom for SC 64 bits.

PHY	MCS	Preamble		Header		Data			Datarate (Mbit/s @MCS)
		STF (Golay (T _c))	CE (Golay (T _c))	Mod.	Length (bits)	Mod.	Coder (rate)	Length (octets)	
Control									
CPHY	0	G _b 128 6400	G _u +G _v 1152	$\pi/2$ -DBPSK	40	$\pi/2$ -DBPSK	LDPC $1/2$	14...1023	27.5
Single Carrier									
SC PHY	1...12 Ext.: 9.1 12.x	G _a 128 2176	G _u +G _v 1152	$\pi/2$ -DBPSK	64	$\pi/2$ -DBPSK $\pi/2$ -QPSK $\pi/2$ -16QAM $\pi/2$ -64QAM	LDPC $1/2$ $5/8$ $3/4$ $13/16$ $7/8$	1...262143	385 (1) 1115 (4) 4620 (12) 8085 (12.6)
Low Power SC PHY	25...31					$\pi/2$ -DBPSK $\pi/2$ -QPSK	RS Block		625 (25) 2503 (31)
Orthogonal Frequency Division Modulation									
OFDM PHY	13...24	G _a 128 2176	G _v +G _u 1152	QPSK	64	SQPSK QPSK 16QAM 64QAM	LDPC $1/2$ $5/8$ $3/4$ $13/16$	1...262143	693 (13) 6756 (24)

Figure 3-19: Overview of different PHYs.

4 Measurement Requirements

This section lists the T&M requirements for devices in accordance with 802.11ad. The first section covers general requirements. Special requirements for the individual PHYs are then explained in the second section.

4.1 General Measurement Requirements

The requirements in this section apply to all devices, regardless of which PHY is used.

4.1.1 Transmit Mask (20.3.2)

Even when the 802.11ad transmission takes place in the open ISM band, interference of other applications must be minimized. This why a spectrum mask is applicable here, as well.

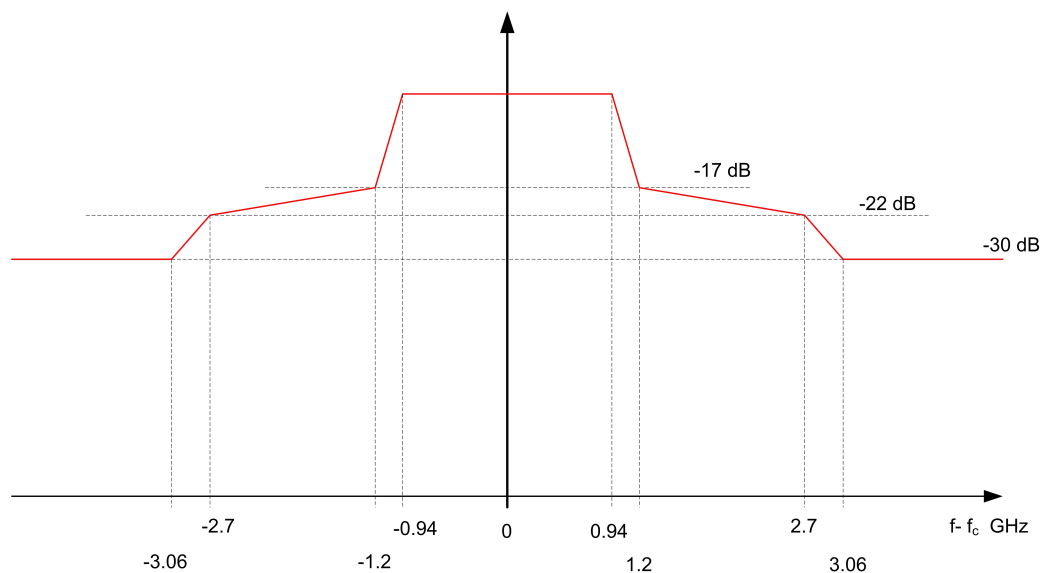

Figure 4-1: Transmitter mask: The limits are relative to the power in the actual channel (± 0.94 GHz). At ± 1.2 GHz it is -17 dB, at ± 2.7 GHz it is -22 dB, and starting at ± 3.06 GHz it is -30 dB

The limits apply relative to the nominal power (maximum spectral density). The measurements are taken with a resolution bandwidth (RBW) of 1 MHz. The nominal bandwidth is 1760 MHz for SC PHY and 1830.47 MHz for OFDM.

4.1.2 Center Frequency Tolerance (20.3.3.2)

A maximum deviation from center frequency of ± 20 ppm is permitted. For example, this is ± 1.2096 MHz for channel 2. In addition, the center frequency shall converge to 1 ppm of the nominal value within $0.9 \mu\text{s}$ after the start of the packet.

4.1.3 Symbol Clock Tolerance (20.3.3.3)

The maximum of ± 20 ppm also applies for the symbol clock. Both the symbol clock and the center frequency shall be derived from the same reference.

4.1.4 Transmit Center Frequency Leakage (20.3.3.4)

The center frequency leakage shall be less than -23 dB relative to the total power for SC PHYs, or $+2.5$ dB relative to the power of a subcarrier for OFDM.

4.2 Transmit Rampup and Rampdown (20.3.3.5)

Both the ramp-up and the ramp-down times (10 % to 90 %) should be less than 10 ns.

4.3 Requirements Dependent on PHY or MCS

Both the requirements for the transmit EVM (see [1], chapter 20.4.4.1.2, 20.5.4.1.2 and 20.6.4.1.1) and the receiver sensitivity (see [1] chapter 20.3.3.8 Table 20-3) depend on the PHY and/or MCS. In the case of the low-power SC PHY, no limits are specified for Transmit EVM.

Table 4-1: Summary of the limits for transmit EVM and receiver sensitivity.

MCS			Transmit EVM (dB)	Receiver Sensitivity (dBm)
CPHY	0	DPSK	- 6	- 78
SC PHY	1	$\pi/2$ -PSK	- 6	- 68
	2		- 7	- 66
	3		- 9	- 65
	4		- 10	- 64
	5		- 12	- 62
	6		$\pi/2$ -QPSK	- 11
7	- 12	- 62		
8	- 13	- 61		
9	- 15	- 59		
9.1	- 16	- 57		
	10	$\pi/2$ -16QAM	- 19	- 55
	11		- 20	- 54
	12		- 21	- 53

Transmit Flatness for OFDM PHY (20.5.4.1.3)

MCS			Transmit EVM (dB)	Receiver Sensitivity (dBm)
	12.1	$\pi/2$ -64QAM	- 22	- 51
	12.2		- 23	- 50
	12.3		- 26	- 48
	12.4		- 27	- 46
	12.5		- 29	- 44
	12.6		- 31	- 42
OFDM PHY	13	SQPSK	- 7	- 66
	14		- 9	- 64
	15	QPSK	- 10	- 63
	16		- 11	- 62
	17		- 13	- 60
	18	16QAM	- 15	- 58
	19		- 17	- 56
	20		- 19	- 54
	21		- 20	- 53
	22	64QAM	- 22	- 51
	23		- 24	- 49
	24		- 26	- 47
LP SC PHY	25	$\pi/2$ -BPSK	n/a	- 64
	26		n/a	- 60
	27		n/a	- 57
	28	$\pi/2$ -QPSK	n/a	- 57
	29		n/a	- 57
	30		n/a	- 57
	31		n/a	- 57

4.4 Transmit Flatness for OFDM PHY (20.5.4.1.3)

For OFDM PHY a special spectrum flatness requirement applies, different for inner and outer carriers:

- Subcarriers -146 to -2 and +2 to +146 -> +- 2 dB
- Subcarriers -177 to -147 and +147 to +177 -> +2/-4 dB

Received Channel Power Indicator (RCPI) Measurement (20.3.10)

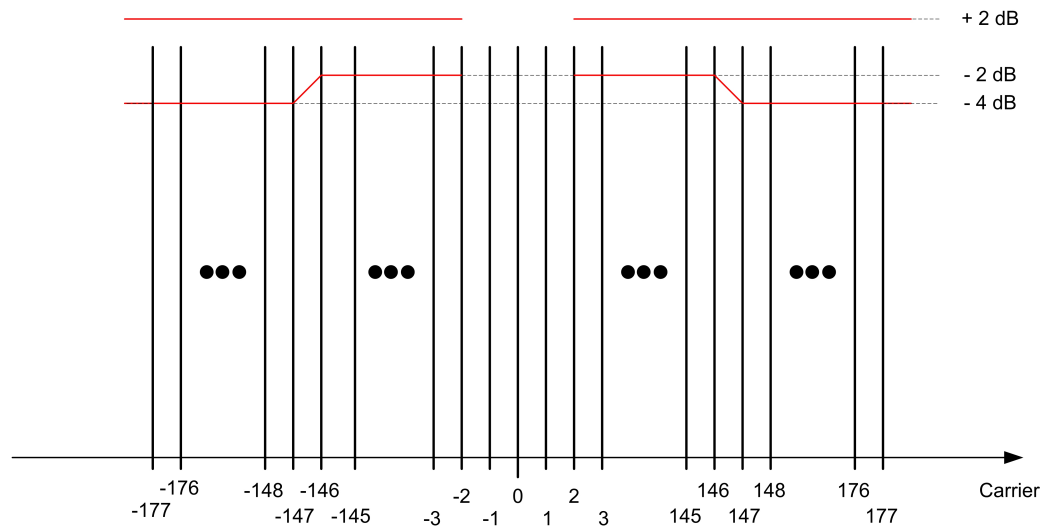

Figure 4-2: Graphical summary of the requirements for TX flatness; the requirements are relaxed starting with carrier 147.

4.5 Received Channel Power Indicator (RCPI) Measurement (20.3.10)

The RCPI indicates the received RF power by a value in the range 0..255 in the power range 0 dBm....-110 dBm in 0.5 dB steps. For more details see [1]. The RCPI difference to the actual power shall be at maximum ± 5 dB.

5 Appendix

5.1 Golay Sequences

In radiocommunications, training sequences are used for channel estimation. Predefined sequences that are already known to the receiver are transmitted over the channel and evaluated by the receiver in order to estimate the channel. Complementary Golay sequences are perfectly suited to this task because:

- the sum of the autocorrelation functions for two complementary Golay sequences is ideal (lobes average out; see Figure 5-1)
- a Golay correlator is easy to implement

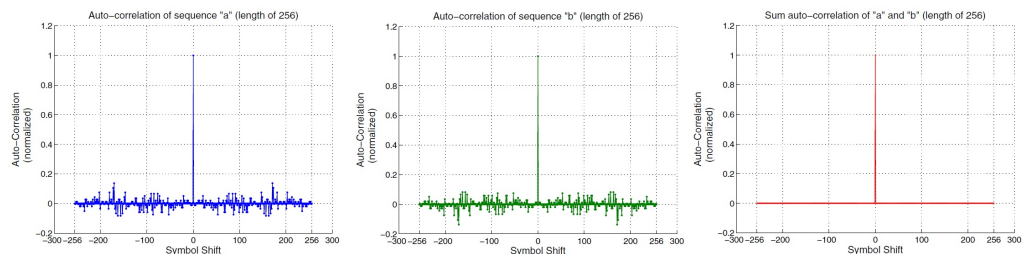

Figure 5-1: Examples for the ideal autocorrelation sum for a Golay sequence [2].

A Golay sequence is made up of bipolar (± 1) symbols of the length n (G_n). A complementary sequence consisting of two sequences, each with a length of n , is identified as $G_{a,n}$ and $G_{b,n}$, for example $G_{a,128}$.

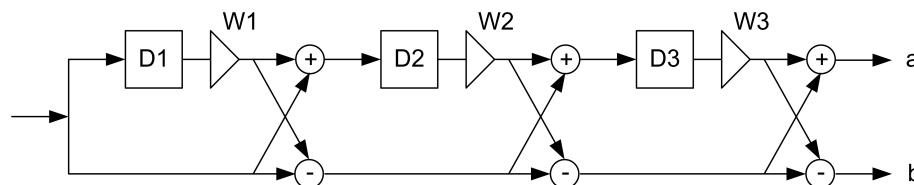

Figure 5-2: Example of a stage 3 Golay correlator; results in a length of $n=8$.

A fast correlator consists of the logarithm dualis of n blocks (i.e. seven blocks for G_{128}), that completes both correlations for a and b in parallel. For example, if the correlator is fed with G_b sequences, peaks will appear at Output b .

In 11ad, sequences of varying lengths are used for different tasks (see [1] 21.11 for sequences).

STF: G_{128} . In this case the individual sequences are repeated, and a – sequence terminates the STF.

- Control sends $G_{b,128}$ first, followed by $-G_{a,128}$
- All others send $G_{a,128}$ first, followed by $-G_{a,128}$

- For STF, only the coding is used; the attributes of the complementarity remain unused

CEF: G128. Four are combined into each G512

- Control and SC send G_u 512 first, followed by G_v 512
- OFDM sends G_v 512 first, followed by G_u 512
- The complementary attributes of the G_u and G_v Ssequences are used. The correlation allows channel impulse response h to be determined, and from that channel attribute H to be estimated. For example, sequence b is sent over the channel (multiplication by h), resulting in $h * b$. In the correlator (multiplication by b), this becomes $b * b * h$. For a , it is $a * a * h$. Adding up the two results leads to $a * a * h + b * b * h$, which can also be written as $(a * a + b * b) * h$. The sum of the auto-correlation functions results in the impulse word, thus h remains.

Golay sequences are also used in the guard interval in SC PHY (G64) and in the beamforming training sequences (G64 and G128).

5.2 Abbreviations

CE	Channel Estimation (field)
CRC	Cyclic Redundancy Check
dB	Decibel
dBm	Decibel Milliwatt
DMG	Directional multi-gigabit
DTP	Dynamic Tone Pairing
FFT	Fast Fourier Transformation
GI	Guard Interval
HCS	Header Check Sequence
HD	High Definition
HT	High Throughput
LDPC	Low Density Parity Check
MAC	Medium Access Control layer
MCS	Modulation and Coding Scheme
OFDM	Orthogonal Frequency Division Modulation
PHY	Physical Layer
PPM	parts per million
RS	Reed Solomon
RSSI	Receive Signal Strength Indicator

STF	Short Training Field
STP	Static Tone Pairing
TRN	Training (field)
VHT	Very High Throughput
WiGig	Wireless Gigabit Alliance

5.3 References

[1] IEEE: IEEE Std 802.11™-2016. Part 11: Wireless LAN Medium Access Control (MAC) and Physical Layer (PHY) Specifications. Chapter 20.

[2] Ming Lei and Ye Huang: CFR and SNR Estimation Based on Complementary Golay Sequences for Single-Carrier Block Transmission in 60-GHz WPAN

6 Rohde & Schwarz

The Rohde & Schwarz electronics group offers innovative solutions in the following business fields: test and measurement, broadcast and media, secure communications, cybersecurity, radiomonitoring and radiolocation. Founded more than 80 years ago, this independent company has an extensive sales and service network and is present in more than 70 countries.

The electronics group is among the world market leaders in its established business fields. The company is headquartered in Munich, Germany. It also has regional headquarters in Singapore and Columbia, Maryland, USA, to manage its operations in these regions.

Sustainable product design

- Environmental compatibility and eco-footprint
- Energy efficiency and low emissions
- Longevity and optimized total cost of ownership



Regional contact

- Europe, Africa, Middle East - customersupport@rohde-schwarz.com
Phone +49 89 4129 12345
- North America - customer.support@rsa.rohde-schwarz.com
Phone 1-888-TEST-RSA (1-888-837-8772)
- Latin America - customersupport.la@rohde-schwarz.com
Phone +1-410-910-7988
- Asia/Pacific - customersupport.asia@rohde-schwarz.com
Phone +65 65 13 04 88
- China - customersupport.china@rohde-schwarz.com
Phone +86-800-810-8228 / +86-400-650-5896

Headquarters

Rohde & Schwarz GmbH & Co. KG

Mühldorfstraße 15 | D - 81671 München

+ 49 89 4129 - 0 | Fax + 49 89 4129 – 13777

www.rohde-schwarz.com

This application note and the supplied programs may only be used subject to the conditions of use set forth in the download area of the Rohde & Schwarz website.

R&S® is a registered trademark of Rohde & Schwarz GmbH & Co. KG. Trade names are trademarks of the owners.