

# How CERN's Documents Contradict its Safety Assurances:

## Plans for 'Strangelet' Detection at the LHC

Eric Penrose<sup>§</sup>

*'Negatively charged strange matter, either as strangelets or in bulk, does not exist on earth. If it is stable and could be created it could react exothermically with ordinary matter, converting everything it touched into more of itself.'*

E. Farhi and R.L. Jaffe, *Phys. Rev. D* **30** (1984) p. [2390](#)

### Contents

I Strangelets and the LHC.....	<a href="#">1</a>
II Strangelet Searches with the CASTOR Detector of CMS.....	<a href="#">3</a>
III Strangelet Searches with the ALICE Detector.....	<a href="#">6</a>
IV Seven Contradictions between CERN's Safety Report and the Statements of the CASTOR Team and ALICE Collaboration.....	<a href="#">8</a>
V Published Physicists' Doubts about CERN's Remaining Safety Arguments.....	<a href="#">12</a>
VI Overview.....	<a href="#">14</a>
Notes.....	<a href="#">15</a>
Acronyms.....	<a href="#">17</a>
References.....	<a href="#">18</a>
List of CASTOR Strangelet Papers.....	<a href="#">22</a>
List of ALICE Strangelet Papers.....	<a href="#">25</a>
Exhibits.....	<a href="#">26</a>

§ Email: [info@heavyionalert.org](mailto:info@heavyionalert.org)

All internet links as given in the references were functional and freely accessible at the time of the compilation of this report. If at some point in the future some of them are no longer functional or accessible, proof can be obtained by contacting the author.

Images in this report are included in accordance with a 'fair use' policy.

This report is a third revised version of 'How CERN Documents Contradict the Bases of Its Own Safety Assurances'.

# I Strangelets and the LHC

## What is a strangelet?

So first, what exactly is a strangelet? A single ‘bag-like’ sphere can be said to surround a proton or neutron. The term strangelet was coined [1] in 1984, for the case of such a ‘bag’ that would surround a greater number than so far known, of the fundamental subnuclear particles called ‘quarks’ and which further includes an additional of type of quark. This larger bag then, would include a mixture of the more normal ‘up’ quarks and ‘down’ quarks along with the heavier “strange” quarks. It has been shown that strange quarks are included in many of the particles are produced in high-energy particle collisions.

## ... a dangerous strangelet?

The following quotes set the criteria for what would be a ‘dangerous strangelet’ and elaborate upon the potential catastrophic implications for the transforming of surrounding matter. This is from a paper that is repeatedly referred to – and relied upon – within CERN's own safety analysis. This paper, ‘Review of Speculative “Disaster Scenarios” at RHIC’ [2] (the ‘Relativistic Heavy Ion Collider’ - ‘RHIC’, operated before CERN's LHC), was produced shortly before RHIC’s operation, which began with colliding gold ions in 2000. On pages 11 and 20 of [2] by Jaffe *et al.* (1130 and 1136 of physics journal version) it states:

*‘In light of the possible consequences of production of a stable negatively charged strangelet, we shall refer to such an object as a “dangerous” strangelet.’<sup>1</sup>* [Ref. 2, p. 11 ▶ [Exhibit 2](#)]

*‘A strangelet growing by absorbing ordinary matter would have an electric charge very close to zero. If its electric charge were negative, it would quickly absorb (positively charged) ordinary matter until the electric charge became positive. At that point absorption would cease until electron capture again made the quark charge negative. As soon as the quark charge became negative the strangelet would absorb a nucleus. Thus the growing strangelet’s electric charge would fluctuate about zero as it alternately absorbed nuclei and captured electrons. Even though the typical time for a single quark to capture an electron might be quite long, the number of participating quarks grows linearly with A, so the baryon number of the strangelet would grow exponentially with time, at least until the energy released in the process began to vaporize surrounding material and drive it away from the growing strangelet. **This process would continue until all available material had been converted to strange matter. We know of no absolute barrier to the rapid growth of a dangerous strangelet, were such an object hypothetically to exist and be produced.**’ [Emphasis added.] [Ref. 2, p. 20 ▶ [Exhibit 3](#)]*

This coming November, the first heavy ion (lead-lead) collisions are scheduled to take place at the LHC. Within this context – the question of strangelet production has been raised. What does CERN tell the public about the prospect of strangelets being produced at the LHC?

According to CERN's safety page: '*Strangelet production at the LHC is therefore less likely than at RHIC, and experience there [at RHIC] has already validated the arguments that strangelets cannot be produced.*'<sup>ii</sup> [3 ► [Exhibit 4](#)]

## **Strangelets at the LHC?**

In 2008, the LHC Safety Assessment Group (LSAG) produced a report [4] claiming that: '*The previous arguments about the impossibility to produce strangelets at the LHC are confirmed and reinforced by the analysis of the RHIC data.*'<sup>ii</sup> [Ref. 4, p. 13 ► [Exhibit 5](#)]

But it can now be shown that claims in the safety report about the non-production of strangelets – are in clear contradiction with two experimental research projects for the LHC. Theoretical papers, documents and online material relating to LHC detector work have been recently unearthed, stating that the production of strangelets is either a serious possibility or a likely prospect at the LHC. Those of the latter who are<sup>iii</sup> attached [5] to CERN at the time of writing, outnumber by at least twenty six to ten, those still<sup>iii</sup> attached ([5]) to CERN, who had made up the entirety of both LSAG and the CERN Scientific Policy Committee (SPC) (the SPC essentially validated [4] – see [6]). Only one of the latter groups<sup>iv</sup> (and from the SPC, not LSAG) has, according to 'Google Scholar' [7], authored or co-authored a paper other than a LHC safety review, that refers to 'strangelet(s)'. But two LSAG members – including its chair – have been involved<sup>iv</sup> with the 'Large Hadron Collider Committee' (LHCC), and the minutes from that committee's meetings indicate their familiarity with CERN's strangelet detection projects. In 1996 its chair was a 'referee' assigned<sup>iv</sup> to the ALICE detector that was associated at that time with both these proposals.

One of these projects is in fact, a self-contained subdetector that is presently installed and operational as part of one of the LHC's four main detector systems – the Compact Muon Solenoid (CMS). This detector is called CASTOR, short for 'CentauRO And STRange Object Research'. Another strangelet search project is associated with the ALICE detector.

## **... fulfilling the above criteria of dangerous?**

Moreover, these projects indicate that the criteria given above for a catastrophic process can be met by strangelets produced at the LHC. This report shows that many official statements and arguments from CERN, about the possibility for the production of strangelets at the LHC, are contradicted by CERN's own researchers who are directly involved in this field. It is not claimed here that these researchers state that there are dangers, nevertheless, CERN's remaining safety assurances are also shown to be disputed by the published statements of other physicists.

## II Strangelet Searches with the CASTOR Detector of CMS

### The CASTOR detector

Under the tab ‘Detector’ of the CMS website [8], there is no information displayed about the CASTOR subdetector. It is here not shown at the end of the most extended CMS detector diagram available [9] (diagram shown on the right). Like the CMS site, the ALICE detector site [10] is associated with CERN’s main site. However, the ALICE site does include far-end subdetectors in its diagram, yet has its own subdetector tab and only the ALICE detector has a comparable amount of end subdetectors. Also absent from the diagram on the right is the ‘TOTEM’ detector (‘T1’ in the diagram below), but, unlike CASTOR, the TOTEM detector has its own tab even in CERN’s main detector page [11].

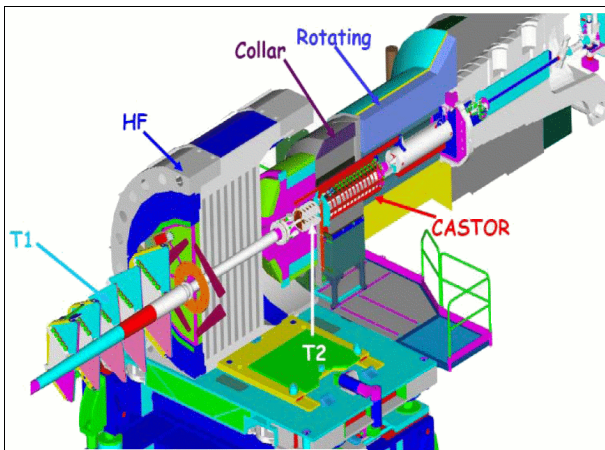
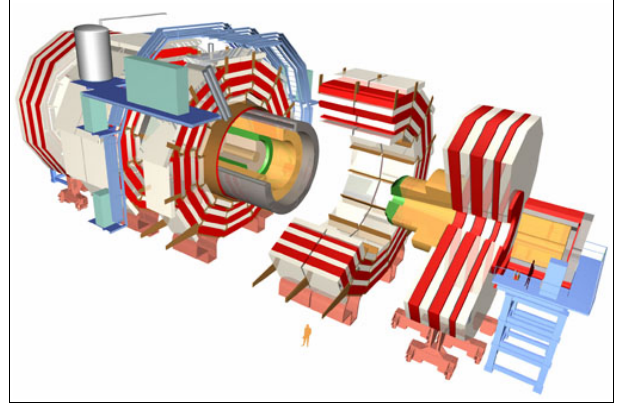

This image though (left), from a CMS newsletter article about CASTOR [12], shows that the subdetector is installed at the far end of the main CMS detector system:

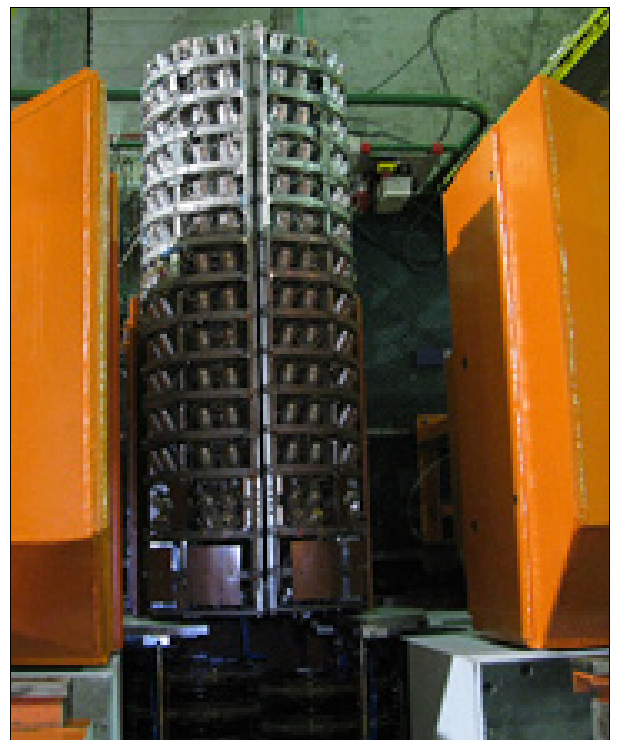

Its size is significant (below [13], right [14]):

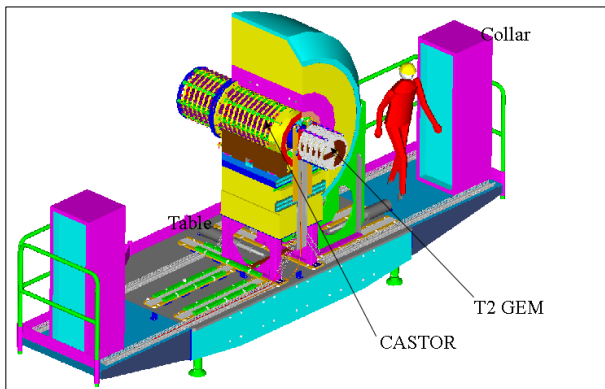

Without prior knowledge of this detector, information about it can only be traced with difficulty, from deep within the extended resources of the ‘CERN Document Server’ [15] or from the CERN CMS website (the latter specifically from either within the newsletter archives of *CMS Times* [16] - or from a website [17] that is only given in a reference from [18]). For casually expressed evidence of its installation and operation from 2009 see [19 ▶ [Exhibit 6](#)].

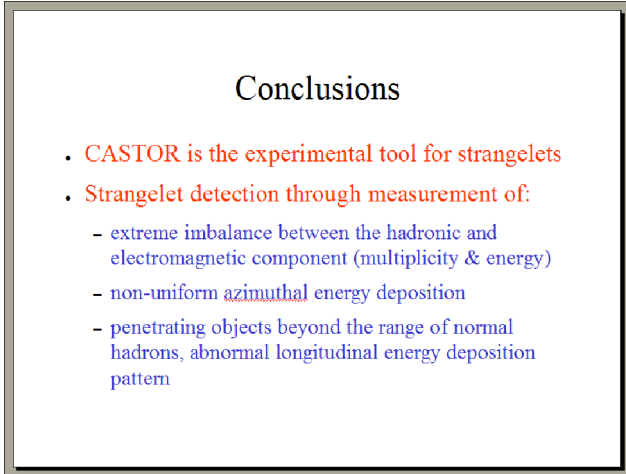

Aside from those sources, various CERN documents and other scientific papers have been found concerning the theory behind the CASTOR detector, which provide further disclosures (see the listing given on pages [22-23](#)). The CASTOR website – which presently<sup>iii</sup> is not available from either CERN’s own search facility<sup>v</sup> or from Google – shows that the possibility of negative or neutral strangelets is accepted [17]. Only unstable, short-lived, positively charged strangelets have been described as having no potentially dangerous implications in CERN’s official safety report quoted earlier [4].

As shown from this CASTOR presentation slide [Ref. [20](#), slide [32](#)], the main purpose of the CASTOR detector is the detection of strangelets.

### **Strangelets ‘are likely to be produced’**

The 3rd December 2007 issue of the *CMS Times* reveals the aspirations of a representative of the CASTOR Team:

*‘I work as an experimental physicist for the CASTOR forward calorimeter of CMS and my main area of interest is the study of exotic events in heavy ion collisions, especially the identification of strangelets, which are likely to be produced.’* [21 ▶ [Exhibit 7](#)]

For the podcast associated with this newsletter, the last three minutes appear to have been edited, so that the speaker is neither moving nor audible.

Shown on the following page is a CASTOR theory estimate of the likelihood per collision for strangelet production of around one in three hundred (with the likelihood of detection by CASTOR estimated further below) [Ref. [22](#), slide [30](#)].

**Cross Section Estimation for Strangelets**

- The probability for a hadron-rich ‘Centauro-type’ event, estimated from statistics of [Chacaltaya](#) and [Pamir](#) experiments for cosmic ray families with visible energy greater than 100 TeV, is about 3%.

- In about 10% of these hadron-rich events, strongly penetrating cascades, clusters, or “halo” were observed. We assume the total probability for “Long Flying Component” (Strangelet?) production in central nucleus-nucleus collisions to be approximately:  $0.03 \times 0.1 \sim O(10^{-3})$ .

- At LHC kinematics, the percent of Strangelets falling in CASTOR phase space is  $\sim 10\%$  of total number of [Strangelets](#) produced in central [Pb-Pb](#) collisions. This quantity depends on the mass and energy of the Strangelet, as calculated by the “Centauro model” MC code CENGEN.
- A rough estimation of the total probability for Strangelet production and detection in CASTOR is:
 
$$P_{\text{CASTOR strangelet}} \approx 10^{-3} \times 0.1 \approx O(10^{-4})$$
- This number, even if it is uncertain by an order of magnitude down, is a very large number !

The CASTOR theory of strangelet production is based on the view that there are good indications that strangelets emerging from cosmic ray collision have actually been observed, though only at above energies correlated to that of the RHIC collider (the most similar collider to LHC). In fact it is argued [23] and [24] that present collider results do not so far reproduce aspects of these cosmic ray detections. These were from mountain-based cosmic ray detectors from back in the 70’s.

These views concerning detected strangelets, themselves contradict two claims of the LSAG report [4]: that there is no evidence for the existence of strangelets and that strangelet production likelihoods decrease with collision energy (see rows ‘6’ and ‘2’ respectively in the table). For this naturally occurring – cosmic ray – case at least, CASTOR theory argues that the strangelets would eventually become destroyed [23] by subsequent collisions with nuclei.

CASTOR theorists have also indicated that both stable and negative or neutrally charged strangelets are feasible (as shown in the [table](#) below), thus fulfilling the criteria of dangerous above for dangerous strangelets.

It is furthermore suggested (see row ‘7’ of the table) by several CASTOR theorists [18], that the generally accepted model of nuclei cosmic rays at energies comparable to the LHC’s may need to be reconsidered. In these cases also, a main CASTOR theoretical model – would in itself still enable strangelets to be produced at the LHC from heavy ion collisions, whilst secondary arguments within CASTOR theory arguments explore how the mountain-based cosmic ray detections could have resulted from non-nuclei cosmic rays.

### III Strangelet Searches with the ALICE Detector

This chart below from the ‘ALICE Technical Proposal’ [Ref. 25, p. 224] shows the Strangelets Physics Performance Working Group at ALICE, led by J.P. Coffin:

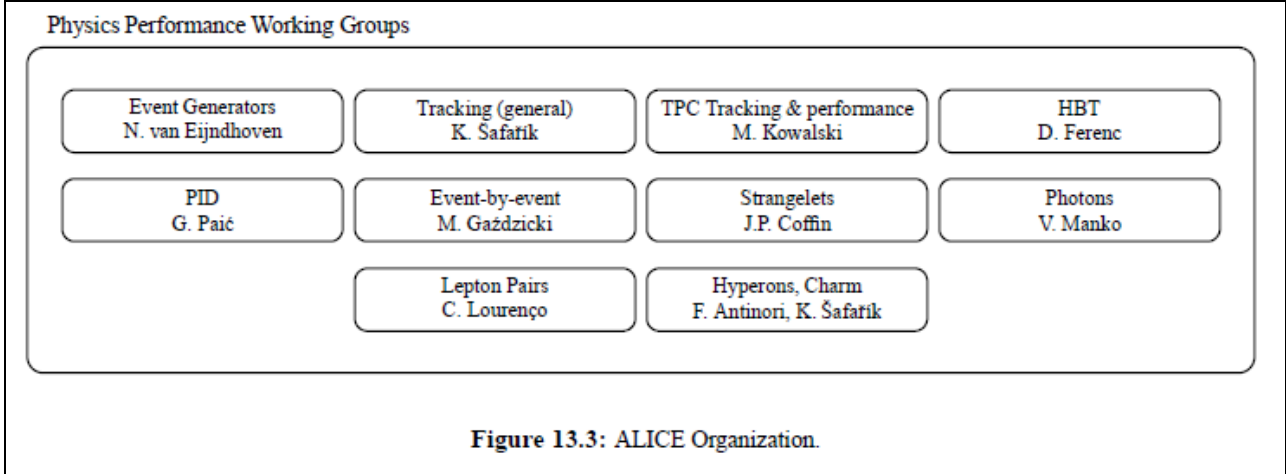

Chapter 11 of this document considers the physics that will apply for the ALICE detector. Strangelets are analysed for how they would be detected [Ref. 25, pp. 189-192: see image on the right]. This relies upon the theoretical arguments enabling strangelet production for this context, described as involving ‘fluctuations in net baryon number’ <sup>vi</sup> [Ref. 26, p. 1776]. These issues – entirely neglected by the LSAG report [4] – have been put forward to explain how strangelets could emerge so as to be detected by the central parts of the ALICE detector.

For this scenario of so called ‘midrapidity’ <sup>vi</sup> production, it is clear that the strangelets produced could be moving slowly enough not to be fully destroyed by subsequent collisions with surrounding matter, as the given location of their detection range in ALICE would correlate to this prospect. In this regard, Jaffe *et al.* state: ‘*Since strangelets produced at high rapidity are likely to be destroyed by subsequent collisions, . . .*’. [Ref. 2, p. 20 ▶ [Exhibit 8](#)]

So strangelets could survive at such lower rapidities. (‘Rapidity’ is an alternative measure for the component of velocity along the beam direction.)

#### 11.10 Strangelets

##### 11.10.1 Strangelet production at the LHC

QGP formation should result in an enhanced production of strange quarks and it has been speculated that droplets of strange matter (i.e. strangelets) could be formed in heavy-ion collisions (for a review see Ref. 95 and references quoted in Ref. 96). Strange matter may also ap-

Recent theoretical developments [97] suggest, however, that strangelets could be produced also at the LHC as a result of local fluctuations in the net baryon number<sup>12</sup>.

Strangelets and MEMOs could be stable or metastable objects, and their stability, lifetime, and decay modes are strongly parameter dependent [96].

Strangelets (S) may be

- i) unstable ( $\tau < 10^{-20}$  s), in which case they decay via hyperon emission ( $\Lambda$ ,  $\Sigma$ ,  $\Xi$ ) and meso-nucleonic strong interaction processes [96]:

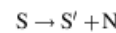
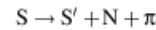

- ii) metastable ( $\tau < 10^{-4}$  s), in which case they decay via weak interaction processes:

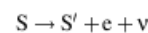
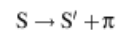
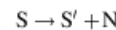

- iii) stable ( $\tau > 10^{-4}$  s).

<sup>12</sup> As the average baryon and strangeness density at midrapidity is zero, strangelets and *anti*-strangelets would be produced in equal numbers.

This Jaffe *et al.* paper, indicates that a negative strangelet lasting over one 10 millionth of a second ( $10^{-7}$ s), so as to traverse the detector [Ref. 2, p. 20 ▶ [Exhibit 9](#)], could be potentially dangerous. But durations well beyond this are seriously considered (see last image on previous page) [Ref. 25, p. 189], while negative or neutral strangelets are allowed (see row '4' in the table).

Included under section 11.10.2 [Ref. 25, pp. 190-192] is a detailed study of the ALICE detector indications for long lived or stable strangelets, produced by collision and passing through the detector. This is given after the text partly shown to the right [Ref. 25, p. 190].

Again, the potential for enabling strangelet detection – and for strangelets to meet the criteria for being classified as dangerous – are satisfied.

#### **11.10.2 Strangelet detection in ALICE**

The search for strangelets within ALICE will depend on lifetime and decay modes.

- i) If these objects are stable or long-lived metastable ( $> 10^{-7}$  s), they will pass through the complete detector (assuming  $\beta \approx 0.1$ ) and can be seen as tracks with unusual charge-to-mass ratio.



# IV Seven Contradictions between CERN’s Safety Report and the Statements of the CASTOR Team and ALICE Collaboration

CERN's Safety Report	Statements from CASTOR Physicists	Statements from ALICE Physicists
<b>1. Likelihood of strangelet production at the LHC</b>		
<p>‘The previous arguments about the impossibility to produce strangelets at the LHC are confirmed and reinforced by the analysis of the RHIC data.’<sup>ii</sup>            [Ref. 4, p. 13 ▶ <a href="#">Exhibit 5</a>]</p> <p>—</p> <p>‘Our conservative estimate for the thermal production of a normal <math>A = 10</math> nucleus at the LHC was <math>3 \times 10^{-25}</math> times the rate of nucleon production. Taking the latter rate to lie in the hundreds, we arrive at a probability of <math>10^{-13}</math> that a single normal nucleus of size <math>A = 10</math> [10 proton masses] is produced during the entire LHC program as a result of the essentially thermal dynamics in a heavy ion collision. So, if LHC would run for the entire lifetime of the universe, the probability of producing such a single nucleus via thermal production would be <math>1/1000</math><sup>[Note]</sup>.</p> <p>We note that the above is an estimate for the thermal production of a normal <math>A = 10</math> nucleus from a hadron gas of temperature <math>T = 165 \text{ MeV}</math><sup>ii</sup>. The production of normal nuclear matter provides an extremely conservative upper bound on the production of strange quark matter.’            [Ref. 4, p. 19 ▶ <a href="#">Exhibit 10</a>]</p> <p>Note: MeV is one million 'electron volt' units of energy.</p>	<p>‘We assume the total probability for “Long Flying Component” (Strangelet?) production in central nucleus-nucleus collisions to be approximately: <math>0.03 \times 0.1 \sim O(10^{-3})</math>’            [Ref. 22 slide 30 ▶ <a href="#">Exhibit 11</a>]</p> <p>Note: For each collision, a chance of over one in a thousand. The LHC expects to have up to 10 billion central heavy ion collisions. [Ref. 4, p. 19 ▶ <a href="#">Exhibit 12</a>]. This number of collisions would be expected to produce about 10 million strangelets.</p> <p>—</p> <p>“Strangelet” Cosmic Rays LHC            Mass            7 - 15 GeV   10- 80 GeV            [Ref. 27, tab. 1, p. 6 ▶ <a href="#">Exhibit 13</a>]</p>	<p>‘The distillation of very small strangelets of <math>A_B \leq 10</math> . . . cannot be excluded for the midrapidity region at colliders.’            [Ref. 26, p. 1779 ▶ <a href="#">Exhibit 14</a>]</p> <p>Note: <math>A_B=A</math> and <math>A = 10</math> is equivalent to the masses of 10 protons. The ‘midrapidity region’ enables slow moving strangelets to be produced</p>
<b>2. Likelihood of strangelet production at LHC compared to previous accelerators or colliders</b>		
<p>‘We conclude on general physical grounds that heavy-ion collisions at the LHC are less likely to produce strangelets than the lower-energy heavy-ion collisions already carried out in recent years at RHIC, just as strangelet production at RHIC was less likely than in previous lower-energy experiments carried out in the 1980s and 1990s’            [Ref. 4, p. 11 ▶ <a href="#">Exhibit 15</a>]</p>	<p>“CENTAURO” event.            . . .            Total interaction energy                                             in <math>N-N</math> c.m. <math>\sqrt{s_{N-N}} \geq 233 \text{ GeV}</math>            [Ref. 23, tab. 4.1, p. 84 ▶ <a href="#">Exhibit 16</a>]</p> <p>Note: The prerequisite for CASTOR theory strangelet production is known as a ‘CENTAURO’ type shower of particles after collision; this is above the energies of RHIC collision, ie.: <math>\sqrt{s_{NN}} = 200 \text{ GeV}</math>.</p>	<p>‘. . . we have to consider that the overall conditions for QGP [quark gluon plasma] formation and existence should be better at RHIC and even more at LHC than at all other accelerators. Consequently, if a strangelet really needs a QGP to be created, its production probability could be enhanced at the new colliders.’            [Ref. 28, p. 1055 ▶ <a href="#">Exhibit 17</a>]; also            [Ref. 29, pp. 1709-1710]</p>

CERN's Safety Report	Statements from CASTOR Physicists	Statements from ALICE Physicists
<b>3. Production of strangelets through ‘strangeness distillation’</b>		
<p>‘So, there is no evidence for a distillation mechanism capable of strangelet production at RHIC, and this suggestion for strange particle production has been abandoned for the LHC.’<sup>vi</sup></p> <p>[Ref. 4, p. 19 ▶ <a href="#">Exhibit 18</a>]</p> <p>—</p>	<p>‘Strangelet formation via a mechanism of strangeness distillation is possible...’</p> <p>[Ref. 18 p. 2 ▶ <a href="#">Exhibit 19</a>]</p> <p>The details of this mechanisms are still available<sup>iii</sup> from the CASTOR information site [17], from [Ref. 20, slide 14 ▶ <a href="#">Exhibit 20</a>] or [CASTOR Pres, slide 5].</p> <p>Note: According to paper [30], however, this particular mechanism is not necessarily the only one needed by CASTOR theory to enable strangelet production.</p> <p>[Ref. 30, p. 10 ▶ <a href="#">Exhibit 21</a>]</p>	<p>‘Moreover some calculations [ref.] indicate that, even at LHC where <math>\mu_B</math> is expected to be almost zero, there might be non-negligible fluctuations of different rapidity bins in the central region. Hence distillation could take place locally.’</p> <p>[Ref. 28, p. 1055 ▶ <a href="#">Exhibit 22</a>]</p> <p>—</p> <p>‘The formation of exotic multistrange objects may proceed as strangelet distillation out of a QGP droplet or as clustering of (anti)hyperons.’</p> <p>[Ref. 26, p. 1779 ▶ <a href="#">Exhibit 23</a>]</p> <p>Note: ‘Clustering’ here refers to the alternative ‘coalescence’ mechanism.</p> <p>—</p> <p>See also the entry for this column in row ‘1’.</p>
<b>4. Negatively charged or neutral strangelets</b>		
<p>‘It is generally expected that any stable strangelet would have a positive charge, in which case it would be repelled by ordinary nuclear matter, and hence unable to convert it into strange matter[ref.]’</p> <p>[Ref. 4, p. 9 ▶ <a href="#">Exhibit 24</a>]</p> <p>—</p> <p>‘Unreasonably low values of the bag constant [with lower energy density around the quarks] are necessary to compensate for a large repulsive gluonic interaction energy, which is why negatively charged strangelets are regarded as extremely unlikely.’</p> <p>[Ref. 4, p. 15 ▶ <a href="#">Exhibit 25</a>]</p>	<p>“Strangelet” Cosmic Rays LHC  ...  <math>Z</math> [charge] <math>\leq 0</math> <math>\leq 0</math></p> <p>[Ref. 23, tab. 6.3, p. 112 ▶ <a href="#">Exhibit 26</a>]</p> <p>See also: [Ref. 31, tab. 1, p. 3 ▶ <a href="#">Exhibit 27</a>]</p> <p>—</p> <p>‘Generally, for higher bag parameter values [higher energy density around the quarks] there are less long-lived strangelets and they are shifted towards higher values of baryon number <math>A</math>, strangeness factor <math>f_s</math> and towards higher negative charges.’</p> <p>[Ref. 23, pp. 76-77 ▶ <a href="#">Exhibit 28</a>]</p>	<p>‘In heavy-ion reactions strangelets and MEMOs might be found in the final state as objects with baryon number <math>A \approx 2-40</math> [between 2-40 proton masses], <math>Z/A</math> ratio ranging from <math>\sim -0.5</math> up to <math>+0.5</math>’</p> <p>[Ref. 25, p. 189 ▶ <a href="#">Exhibit 29</a>]</p> <p>Note: A <math>Z/A</math> ratio ranging from <math>-0.5</math> up to <math>+0.5</math> implies a charge that is negative, neutral, or positive.</p>

CERN's Safety Report	Statements from CASTOR Physicists	Statements from ALICE Physicists
<b>5. Stability of strangelets with masses below that of 10 protons</b>		
<p><i>'Finite size effects make it very unlikely that small strangelets (<math>A &lt; 10</math>) can be stable or long-lived.'</i><sup>viii</sup> [Ref. 4, p. 14 ▶ <a href="#">Exhibit 30</a>]</p> <p>Note: <math>A &lt; 10</math> is a mass less than that of 10 protons.</p>	<p><i>'There are also predictions that quite small strangelets might gain stability due to shell effects [refs.]. They are called "magic strangelets". However, due to the lack of theoretical constraints on bag model parameters and difficulties in calculating colour magnetic interactions and finite size effects, experiments are necessary to help answer the question of the stability of strangelets.'</i> [Ref. 23, p. 77 ▶ <a href="#">Exhibit 31</a>]</p>	<p><i>'Special (meta)stable candidates for experimental searches are the quark alpha [ref.] with <math>A_B = 6</math> and the Hdibaryon with <math>A_B = 2</math> [ref.]'</i> [Ref. 26, p. 1779 ▶ <a href="#">Exhibit 32</a>]</p> <p>Note: <math>A_B=A</math> (mass number)</p> <p>—</p> <p><i>'There is a mass range, below 2055 MeV (the mass of a lambda and a neutron), where it [Hdibaryon] could only decay by a doubly weak decay into two neutrons. This is a <math>\Delta S = 2</math> reaction and leads to a predicted lifetime of the order of days.'</i> [Ref. 29 p. 1708 ▶ <a href="#">Exhibit 33</a>]</p> <p>—</p> <p><i>'Strangelets and MEMOs could be stable or metastable objects and their stability, lifetime, and decay modes are strongly parameter dependent [ref.]'</i> [Ref. 25, p. 189 ▶ <a href="#">Exhibit 34</a>]</p> <p>—</p> <p>under 'Stable or long-lived strangelets': <i>'As an example, we consider strangelets with <math>Z = 1</math> and <math>Z = 2</math> and a mass between 6 and 15 GeV (i.e. <math> Z/A  &lt; 0.3</math>)'</i> [Ref. 25, p. 190 ▶ <a href="#">Exhibit 35</a>]</p> <p>—</p> <p>See also the entry for this column in row '1'.</p>
<b>6. Existing observational data and the existence of strangelets</b>		
<p><i>'More recently, additional direct upper limits on strangelet production have been provided by experimental searches at RHIC [ref] and among cosmic rays [ref], which have not yielded any evidence for the existence of strangelets.'</i> [Ref. 4, p. 9 ▶ <a href="#">Exhibit 36</a>]</p>	<p><i>'The simulations show that transition curves, produced by strangelets during their passage through the [cosmic ray detector] chamber, resemble the experimentally detected long many-maxima.'</i> [Ref. 18, p. 3 ▶ <a href="#">Exhibit 37</a>]</p> <p>—</p> <p><i>'The old [comic ray detection] experimental results are also worth to recalling. Anomalous massive (<math>A=75...1000</math>) and relatively low charged objects (<math>Z=14...46</math>), which could be interpreted as strangelets, have been observed.'</i> [Ref. 23 p. 79 ▶ <a href="#">Exhibit 38</a>]</p>	

CERN's Safety Report	Statements from CASTOR Physicists	Statements from ALICE Physicists
<b>7. Comparison of LHC with cosmic-ray collisions</b>		
<p><i>‘ . . . This is because cosmic rays have a significant component of heavy ions, as does the surface of the Moon.’</i></p> <p>[Ref. 4, p. 12 ▶ <a href="#">Exhibit 39</a>]</p>	<p><i>‘It is assumed that cosmic ray showers are caused by nuclei, protons through iron, hitting the atmosphere. If CASTOR does not find events that can be identified with the anomalous cosmic-ray events, this assumption may need to be reconsidered. Pb-Pb collisions with the LHC will have an energy 28 times that of Au-Au collisions studied at RHIC. With this huge increase in energy a wealth of new phenomena is almost assured. Because of the much larger mass number, Pb-Pb events can be expected to show exotic phenomena that is beyond the reach of cosmic rays.’</i></p> <p>[Ref. 18, p. 1 ▶ <a href="#">Exhibit 40</a>]</p>	

## V Published Physicists' Doubts about CERN's Remaining Safety Arguments

Where the question of safety is twice referred to in CASTOR papers, it is claimed that cosmic ray collisions can provide assurance for safety. Such arguments are presented in the LSAG report [4] as further reasons for LSAG to claim LHC collision safety. Below, CERN's two remaining safety assurance arguments and their critiques by other physicists, are given. The first issues concern astrophysical assurance arguments of the LSAG report, the last relates to an argument of only CERN's earlier LSSG report [32]. It should be recognised that regarding case i) below, it was shown above in [Sect. II](#) and the [table](#), that even the underlying assumption of heavy ion cosmic rays at comparable energies, had been suggested as potentially open to doubt by members of the CASTOR team.

### i) Survival of the Moon.

The LSAG report relies here upon the analysis of Jaffe *et al.* (2000) [2] quoted near the start of this report. In this argument, enough emerging strangelets from cosmic ray to lunar collision, would be slow moving enough to survive collisions with subsequent nuclei, yet no catastrophe has occurred there. Therefore the survival of the Moon is presented as a reassurance argument against risks from LHC. However this argument is itself disputed by theoretical physicist Adrian Kent [33] and to the nuclear physicist Calogero it is questionable [34]. In fact, it had even been interpreted as not completely reliable in an earlier paper [35] – from CERN's Theory Department. This Dar *et al.* paper ([35]) is referenced by LSAG, but no acknowledgment of this uncertainty – or of other questions as to the reliability of Jaffe *et al.*'s astrophysical safety argument – are given. The LSAG report claims that this argument is strengthened by existing data from RHIC (here appearing to rely on the assumed inapplicability of strangeness distillation<sup>vii</sup>) and fails to give any reference for this claim, which itself appears unjustified due to the lack of sufficiently relevant data<sup>ix</sup>. The doubts, elaborated in most detail by Kent, are due to a) the uncertainties around Jaffe *et al.*'s [2] assumptions of the possible (or likely) range of speeds of strangelets emerging from lunar collisions, b) the strangelet speed at which it is at least partly destroyed by collisions with subsequent nuclei, c) the extent of the collision-slowing effect upon any surviving strangelet fragments after earlier collisions with nuclei and d) the comparability of the much heavier gold or lead ions of high energy colliders, to the iron nuclei which are expected frequently to occur in cosmic rays. A further doubt e) (not challenged by Kent) that is implied elsewhere [23] [35] [29], concerns the comparability of lower than RHIC or LHC correlated cosmic ray energies for enabling strangelet production, which pertains to the diminished number of cosmic rays at these higher energies.

Two indications from a graph<sup>x</sup> [Ref. 36, fig. 9, p. 13 ▶ [Exhibit 41](#)] from CASTOR theory, either reinforce or make relevant the risk implied doubts a) - c) (though not stated in such a way by the CASTOR theorists). One is associated with doubt a), as the graph suggests that no such dangerously slow moving strangelets would occur<sup>x</sup>, when considered for the Moon case. The second suggests<sup>x</sup> that some of the CASTOR theory proposed strangelets from LHC may inevitably emerge more slowly than the slowest strangelets from the correlated lunar cosmic ray collisions (the latter also according to the main CASTOR theory). From this latter implication of this graph, the arguments in b) and c) of Kent [33], then appear to potentially enable the prospect of catastrophe

from LHC, because of the differing configuration of LHC's head to head collisions to one way collisions at the Moon. It is more clear that emerging strangelets which could be found by the main ALICE detector, can be slow moving enough to survive and so potentially grow catastrophically. The further safety doubts of astrophysical assurance implied by d), refer to the comparability of the unusually high atomic mass of RHIC or LHC's heavy ions with the much less frequently expected lead cosmic ray nuclei (too infrequent for reassurance in the Moon collision case). This suggestion of incomparability of iron cosmic rays, is itself effectively relied on in Dar *et al.*'s [35] construction of a safety argument, which involves predictions not of iron nuclei, but of much lower frequencies of lead nuclei cosmic ray (the safety argument itself is disputed by the LSAG report, [2], [33] and [34] for only considering fully stable strangelets, not 'metastable' ones). The doubt is further reinforced by the similar doubts of CASTOR theorists (as quoted in row '7' of the table). Doubt e) is supported by another feature within the basis of Dar *et al.*'s safety argument, where it conservatively assumes a minimum of either RHIC or LHC correlated energies, to enable strangelet production from cosmic ray collision. The CASTOR theory interpretation of cosmic ray data also assumes that higher than RHIC related energies are required to produce strangelets from cosmic rays (as discussed in Sect. II and quoted in row '2' of the table) and such a prospect appears further implied by [29].

## ii) Charge of growing strangelets reaching an intermediate mass

A further argument (though not in fact included in the LSAG report itself) was emphasised in the earlier 2003 CERN safety paper [32]. This entails that intermediate mass strangelets – such as initially negative strangelets after their growth – must end up as positively charged due to strangelet surface effects upon strange quarks near the edge. But the paper this relies on is undermined by this subsequent paper by Wen *et al.* [37] – which is neglected by the LSAG report – despite that [4] refers to another recent strangelet paper by the same authors which is based on differing assumptions. Wen *et al.* [37] indicates that fully stable negative to neutral strangelets states can feasibly extend along the range of mass.

## **VI Overview**

It has been shown that with respect to strangelet production at the LHC, CERN presents us with two faces. The private one looks inward, fulfilling CERN's functional scientific role. For this side, free of a concern to reassure the public, the viability of producing long-lived strangelets that can be negatively charged or neutral, is accepted. The other looks outward, apparently bearing the responsibility for continuing LHC's heavy ion project, assures us that this could not occur and, largely as a result, that LSAG's most emphasised and direct criteria for danger don't apply.

For the remaining safety reassurances that CERN have discussed, various published works of physicists demonstrate the insufficient and unsatisfactory nature of these last remaining safety arguments.

CERN's withholding of relevant information and negligence in its safety assessments is particularly significant given the magnitude of what is at stake. CERN has misled the public to the extent that its mandate to conduct heavy ion collisions is called into question.

Under such circumstances, the safety of the public needs to be ensured. It is recommended that no heavy ion collisions be permitted at the LHC prior to a multi-disciplinary safety review panel – fully independent of CERN – conducting a thorough and transparent review involving the neglected issues associated with such collisions.

Eric Penrose  
London, UK  
31 October 2010

on behalf of the  
Heavy Ion Alert network  
info@heavyionalert.org

## **Acknowledgements**

The assistance of other LHC critics is appreciated, for support in background research, suggestions and help in the finalisation of this report.

## Notes

**Going Back:** Readers viewing this document in Acrobat Reader can return to their previous page by using the 'Previous View' button. (See: Tools → Customize Toolbars → Page Navigation Toolbar → Previous View)

- i. The use of quotes here appears to relate to the uncertainties expressed in the paper [2] about whether or not the results of these strangelets would necessarily be catastrophic, and upon the astrophysical assurance argument given in that paper. However, given that the word is used in the paper elsewhere for this context without quotes and that the reassurance argument itself is criticised or questioned by other physicists, I refer to dangerous strangelets without quotes.
- ii. Concerning likelihood of strangelet production:  
These likelihood estimates disregard calculation for producing smaller strangelets, on the basis that these wouldn't be stable enough to be hazardous - a claim itself disputed (see row '5' of the table) by CASTOR or ALICE related theories. For smaller mass strangelets, likelihoods would then become significant over LHC's operational lifetime (see above), even with LSAG's supported production models. This is much more greatly the case for the particular possibility of long lived  $A=2$  Hdibaryon mentioned in row '5' of the table and below. The two models accepted by CERN in relation to likelihood of strangelet production at LHC, are the coalescence and thermal models. Nevertheless, the thermal model relies on overall unlike particle correlation data itself, to reconstruct what those same results would be for specific particle ratios. But it is acknowledged by papers promoting the thermal model, that it still involves problems reproducing the range of results at certain energy levels [38]. So it is shown to not clearly to be reliable. Such a thermal model as disputed as needed for explaining various results by Schaffner-Bielich *et al.*[39] when the differing model of his group used was also successful for the other set of data. The latter model itself involved a notion for which further validation have been shown [40] and [41]. The coalescence model yields are for a much greater range for possible strangelet production and are based only on data in the 'midrapidity range', though it has been shown in [42] how the rapidity range selection effects the likelihood significantly. Also neglected is CERN's previous LSSG report [32] claim that strangelet production prospects increase if a mechanism known as 'colour-flavour-locking' is applicable.
- iii. By this is meant 'at the time of writing this report'. Proof can be supplied by contacting the author.
- iv. P. Braun-Munzinger of the SPC is listed for the ALICE collaboration within the ALICE Technical Proposal and is listed [5] for ALICE at the time of writing. LSAG's I. Tkachev is listed for CMS. The two LSAG members are M. Mangano and J. Ellis. See [43] and note that some of the CERN documents from 1996 in the 'List of CASTOR Papers' (p.22 of this report), were made available during the time that J. Ellis was an ALICE referee (as shown by the first document given in [43]). Subsequent LSAG chair, J. Ellis, also appears to have presented at a conference in 1999 where another talk was a CASTOR one with its title referring to strangelets from LHC, while a further one again was CASTOR theory related [43]. Presumably then, at least the programme details would have been available to J. Ellis.
- v. Also, CMS' own search function hasn't been functioning up to the time of writing.
- vi. Net baryon number refers to the net surplus of matter above antimatter. The context for this argument is 'midrapidity' which is the circumstance for emitted particles within the slowest category, for their component of velocity along the beam direction. The LSAG report several times refers to the paper [44], which details the thermal model that CERN accepts. On p.23 it is stated: '*In this description [used by [44]], the net value of a given charge (e.g. electric charge, baryon number, strangeness, charm, etc.) fluctuates from event to event.*'
- vii. Concerning doubts over 'strangeness distillation':  
The cosmic ray data suggesting collision induced strangelets above RHIC energy is, irrespective to RHIC results, a central issue to what could be different features of collision at energies above previous heavy ion colliders. More generally though, near the end of sect 3.1 [45] it is indicated that particle yield ratio results



(like those relied on by LSAG to support the thermal model) could yet be explained by strangeness distillation models, once ‘lattice gauge’ theory is taken into account. LSAG refers to RHIC data to claim that the QGP is too short lived to enable strangeness distillation. However the collision detectors are unable to directly measure the duration of this assumed QGP state so a ‘blast wave’ model is relied on for the estimates LSAG cites for the ‘too short-lived’ claim. The LSAG referenced paper for this estimate [46], refers to [47] for the relevant calculations. On pages 2-3, this states the following about its own model ‘With eight freely tunable parameters, it is a toy model with little predictive power’ [47]. The paper [48], dismisses the concept relied on - ‘boost invariance’ - for this estimate, as demonstrably inapplicable. According to [39], this model (along with thermalised model above) is further disputed as needed to explain results, as for some data at least, this can be alternatively achieved. The ‘nucleon density is small’ claim at RHIC neglects the potential for ‘net baryon fluctuation’ as discussed in [26] for the relevant midrapidity. Three papers [49] [50] [51] of 2000-2005 consider strangeness distillation as a way to explain an anomaly of thermal model data present at the time – one of those authors (Redlich) had previously co-authored the main thermal model paper [44]. As stated by in [52] of 2008 and [53] of 2009, strangelet distillation is still an accepted mechanism. Even so, though distillation is highlighted by CASTOR theory and ALICE, it is not relied upon entirely for their suggestions of strangelet production – perhaps because they both allow for strangelets at below 10 proton mass equivalent ( $A=10$ ).

- viii. Strangelet mass less than that of 10 protons ( $A < 10$ ):  
As shown by Jaffe *et al.* [2] the papers that this ultimately relies upon are [1] or [54]. [1] only disputes strangelet stability for  $A \leq 6$ , but then with the noted potential exception of  $A=2$ . [54] is referenced within the relevant table CASTOR quote (above) because this paper even refers to the potential stability (or metastability) of  $A=6$  strangelets. Furthermore, the paper of [55] elaborates on the potential for a (meta)stable neutral strangelet of  $A=6$ .
- ix. High rapidity data:  
Evidence at RHIC of non-negligible values at the relevant extreme rapidity range for both the relevant strange baryons and net baryon density are not demonstrated, as follows. This paper [56] of 2009, which, for strange baryon yields at the higher rapidities in particular, only includes predictions and not also the data, suggesting that no actual relevant data is available. For net baryon number at rapidity, the data plots at extreme rapidities are missing from figs. 3 and 4, pages 3 and 4, from [57] while the ‘mongaus’ projection of fig. 4 inset, indicates negligible net baryon number at the extreme RHIC rapidity range. For the predictions of fig.1, p.1776 of [26] or fig. 6 p.7 of [58] for LHC, the net baryon number can be negligible at the relevant highest rapidity range, again in contradiction to the claim of the LSAG report.
- x. Graph of strangelets’ rapidity distribution [Ref. 36, fig. 9, p. 13 ▶ [Exhibit 41](#)]:  
In relation to negligible strangelet production likelihood in relation to rapidity, for the theoretical case of (3) for example, the 2.5 rapidity difference for negligible strangelet production between 6.4 and 8.9 (the latter is maximum possible rapidity for emitted particles) implies that in the CASTOR model applied for the cosmic ray context, the minimum speed of cosmic ray produced strangelets would be over .92 of the speed of light, at  $\sqrt{s_{NN}} = 233\text{GeV}$  (energy per nucleon-nucleon in centre of mass of collision system) - the minimum cosmic ray collision energy to enable strangelet production according to CASTOR theory. Otherwise this would correlate to .99c (.99 of light speed) for cosmic ray caused strangelets at LHC correlated energies ( $\sqrt{s_{NN}} = 5.5\text{TeV}$ ). (The ‘multiplicity’ or likelihood units in the figure are arbitrary). Either of these values is well above the value (.1c) expected by [2] [35] for non-strangelet disruption by subsequent collision with nuclei. Furthermore, for the limit case given in p.5 of [59] and in [60], when applied to the graph, the minimum strangelet speed from LHC appears to be .98c, which is less than the .99c given in the above case for LHC correlated collision energy. The latter would be most relevant for risk if the cause of the cosmic ray collision detections (at  $\sqrt{s_{NN}} = 233\text{GeV}$ ) was related to non-nuclei cosmic rays. On the other hand, if ALICE strangelet theories were also to apply alongside CASTOR theories, then these models would together imply that LHC strangelets survive whilst analogous ones from cosmic rays would be too fast to survive disruption.

## Acronyms

ALICE	A Large Ion Collider Experiment
CASTOR	CentauRO And STRange Object Research
CERN	European Organization for Nuclear Research (originally: Conseil Européen pour la Recherche Nucléaire)
CMS	Compact Muon Solenoid
LHC	Large Hadron Collider
LSAG	LHC Safety Assessment Group
LSSG	LHC Safety Study Group
MEMO	Metastable Exotic Multi-hypernuclei Objects
SPC	(CERN's) Scientific Policy Committee

## References

- [1] E. Farhi and R.L. Jaffe, ‘Strange matter’, *Phys. Rev.* **D30**(11) (1 Dec 1984) 2379-2390, doi: [10.1103/PhysRevD.30.2379](https://doi.org/10.1103/PhysRevD.30.2379).
- [2] R.L. Jaffe, W. Busza, F. Wilczek and J. Sandweiss, ‘Review of speculative “disaster scenarios” at RHIC’, *Rev. Mod. Phys.* **72**(4) (2000) 1125-1140, doi: [10.1103/RevModPhys.72.1125](https://doi.org/10.1103/RevModPhys.72.1125); arXiv: [hep-ph/9910333v3](https://arxiv.org/abs/hep-ph/9910333v3) (2000).
- [3] <http://public.web.cern.ch/public/en/lhc/safety-en.html>
- [4] J. Ellis, G. Giudice, M.L. Mangano, I. Tkachev and U. Wiedemann (LHC Safety Assessment Group), ‘Review of the safety of LHC Collisions’, *J. Phys.* **G35**(11) (2008) id. 115004 (18pp.), doi: [10.1088/0954-3899/35/11/115004](https://doi.org/10.1088/0954-3899/35/11/115004); arXiv: [0806.3414v2](https://arxiv.org/abs/0806.3414v2) [hep-ph] (2008).
- [5] Results are from entering surname in: <http://user.web.cern.ch/user/AcceleratorServices/OnSiteServices/Directory/Directory.html> This states that the directory is of ‘. . . individual persons or services at CERN.’ (As directory results show, this doesn’t imply that such people are necessarily based at the CERN location).
- [6] G. ‘t Hooft, P. Braun-Munzinger, B. Webber, F. Zwirner and M. Cavalli-Sforza, ‘SPC Report on LSAG Documents’, <http://cdsweb.cern.ch/record/1113558/files/cer-002766289.pdf>.
- [7] <http://scholar.google.co.uk/>
- [8] <http://cms.web.cern.ch/cms/Detector/index.html>
- [9] <http://cms.web.cern.ch/cms/Detector/Designed/index.html>
- [10] <http://aliceinfo.cern.ch/Public/en/Chapter2/Chap2Experiment-en.html>
- [11] <http://public.web.cern.ch/public/en/lhc/LHCExperiments-en.html>
- [12] A. Panagiotou, K. Borras and D. d’Enterria, ‘Looking forward with the CASTOR Calorimeter’, *CMS Times* (12 Nov 2007), [http://cms.web.cern.ch/cms/Media/Publications/CMStimes/2007/11\\_12/index.html](http://cms.web.cern.ch/cms/Media/Publications/CMStimes/2007/11_12/index.html), [http://cms.web.cern.ch/cms/Media/Publications/CMStimes/2007/11\\_12/pdf/CMS%20Times.pdf](http://cms.web.cern.ch/cms/Media/Publications/CMStimes/2007/11_12/pdf/CMS%20Times.pdf).
- [13] E. Norbeck, Y. Onel, A. Panagiotou and M. Murray, ‘Physics at Very Small Angles with CASTOR at CMS’, for the 22nd Winter Workshop On Nuclear Dynamics (13 Mar 2006), <http://rhic.physics.wayne.edu/~bellwied/sandiego06/talks/norbeck-sd.ppt>
- [14] A.D. Panagiotou, ‘CASTOR’s installation in CMS’, *CMS Times* (6 Jul 2009), [http://cms.web.cern.ch/cms/Media/Publications/CMStimes/2009/07\\_06/index.html](http://cms.web.cern.ch/cms/Media/Publications/CMStimes/2009/07_06/index.html), [http://cms.web.cern.ch/cms/Media/Publications/CMStimes/2009/07\\_06/pdf/CMS%20Times.pdf](http://cms.web.cern.ch/cms/Media/Publications/CMStimes/2009/07_06/pdf/CMS%20Times.pdf).
- [15] Enter title or document code (replacing '/' with a space) into CERN Document Server: <http://cdsweb.cern.ch/>
- [16] <http://cms.web.cern.ch/cms/Resources/archive.html>
- [17] <http://cmsdoc.cern.ch/cms/castor/html/>. For negative strangelets, follow the tabs: Motivation> phenomenological model> Predictions of the Model. Strangeness distillation is outlined under ‘phenomenological model’ tab.
- [18] E. Norbeck, Y. Onel, E. Gładysz-Dziaduś, A.D. Panagiotou and P. Katsas, ‘Exotic Physics at the LHC with

CASTOR in CMS', CMS Conference Report 2007/013, *Int. J. Mod. Phys. E* **16**(7-8) (2007) 2451-2456, doi: [10.1142/S0218301307008082](https://doi.org/10.1142/S0218301307008082), [http://cms.cern.ch/iCMS/jsp/openfile.jsp?type=CR&year=2007&files=CR2007\\_013.pdf](http://cms.cern.ch/iCMS/jsp/openfile.jsp?type=CR&year=2007&files=CR2007_013.pdf)>

- [19] <<http://cms.web.cern.ch/cms/News/e-commentary/cms-e-commentary09a.htm>>
- [20] P. Katsas, 'Strangelet hunt at CMS' [slides], QCD at Cosmic Energies II Workshop, Skopelos, Greece, 25 Sep - 1 Oct 2005, <[http://cmsdoc.cern.ch/cms/castor/html/files/Strangelets\\_hunt\\_v3.ppt](http://cmsdoc.cern.ch/cms/castor/html/files/Strangelets_hunt_v3.ppt)> or 2nd to last transparency from: <<http://indico.cern.ch/event/a056703>>
- [21] D. Barney and M. Lapka, Eds., 'The University of Athens (Greece) in CMS', *CMS Times* (3 Dec 2007), <[http://cms.web.cern.ch/cms/Media/Publications/CMStimes/2007/12\\_03/index.html](http://cms.web.cern.ch/cms/Media/Publications/CMStimes/2007/12_03/index.html)>, <[http://cms.web.cern.ch/cms/Media/Publications/CMStimes/2007/12\\_03/pdf/CMS%20Times.pdf](http://cms.web.cern.ch/cms/Media/Publications/CMStimes/2007/12_03/pdf/CMS%20Times.pdf)>
- [22] P. Katsas, A.D. Panagiotou and E. Gładysz-Dziaduś for the CMS/CASTOR Group, 'Searching for Strange Quark Matter with the CMS/CASTOR Detector at the LHC', CMS-HI meeting, (23 Sep 2006) <[http://cmsdoc.cern.ch/cms/castor/html/files/strangelet\\_cmsweek230906.ppt](http://cmsdoc.cern.ch/cms/castor/html/files/strangelet_cmsweek230906.ppt)>. Also: A.D. Panagiotou, P. Katsas for the CMS collaboration, 'Searching for Strange Quark Matter with the CMS/CASTOR Detector at the LHC', Proc. 5th Int. Conf. on Perspectives in Hadron Physics, Particle-Nucleus and Nucleus-Nucleus Scattering at Relativistic Energies, Trieste, Italy, 22-26 May 2006, *Nucl. Phys. A* **782**(1-4) (2007) 383-391, doi: [10.1016/j.nuclphysa.2006.10.020](https://doi.org/10.1016/j.nuclphysa.2006.10.020).
- [23] E. Gładysz-Dziaduś, 'Are Centauros exotic signals of the QGP?', *Phys. Part. Nucl.* **34** (2001) 285-347; see also *Fiz. Elem. Chast. Atom. Yadra* **34** (2003) 565-678; arXiv: [hep-ph/0111163v1](https://arxiv.org/abs/hep-ph/0111163v1) (2001).
- [24] J.S. Lange, 'Au+Au collisions at RHIC and implications for ultra-relativistic astrophysical A+A collisions', *Nucl. Phys. B (Proc. Suppl.)* **151**(1) (2006) 183-190, doi: [10.1016/j.nuclphysbps.2005.07.033](https://doi.org/10.1016/j.nuclphysbps.2005.07.033)
- [25] ALICE Collaboration, 'ALICE: Technical Proposal for A Large Ion Collider Experiment at the CERN LHC', CERN document code: CERN/LHCC/95-71, LHCC/P3, (1995), ISBN: 9789290830771 and ISBN: 9290830778; abstract: <<http://consult.cern.ch/alice/Documents/1995/01/abstract>>, available as download at: <http://cdsweb.cern.ch/record/293391?ln=en>>.
- [26] C. Spieles, L. Gerland, H. Stöcker, C. Greiner, C. Kuhn and J.P. Coffin, 'Creation of Strange Matter at Low Initial  $\mu/T$ ', *Phys. Rev. Lett.* **76**(11) (1996) 1776-1779, doi: [10.1103/PhysRevLett.76.1776](https://doi.org/10.1103/PhysRevLett.76.1776).
- [27] E. Gładysz-Dziaduś for the CASTOR group, 'CASTOR: Centauro and Strange Object Research in nucleus-nucleus collisions at LHC', talk given at the Int. Workshop on Nuclear Theory, 10-15 Jun 2002, Rila Mountains, Bulgaria, arXiv: [hep-ex/0209008v2](https://arxiv.org/abs/hep-ex/0209008v2) (2002).
- [28] J.P. Coffin, C. Kuhn, B. Hippolyte, J. Baudot and I. Belikov, 'Multi-strange-quark states at ultra-relativistic heavy-ion collisions', *Pramana* **60**(5) (2003) 1055-1058, <<http://www.ias.ac.in/pramana/v60/p1055/fulltext.pdf>>, doi: [10.1007/BF02707030](https://doi.org/10.1007/BF02707030).
- [29] C. Kuhn, B. Hippolyte, J.P. Coffin, J. Baudot, I. Belikov, D. Dietrich, M. Germain and C. Suire, 'Search for strange dibaryons in STAR and ALICE', *J. Phys. G* **28**(7) (2002) 1707-1714, doi: [10.1088/0954-3899/28/7/323](https://doi.org/10.1088/0954-3899/28/7/323).
- [30] E. Gładysz-Dziaduś, 'Black Holes versus Strange Quark Matter', arXiv: [hep-ph/0405115v3](https://arxiv.org/abs/hep-ph/0405115v3) (2005); see also: E. Gładysz-Dziaduś and Z. Włodarczyk, 'Black Holes versus Strange Quark Matter' in *Trends in Black Hole Research*, Ed. P.V. Kreitler (Nova Science, New York, 2006) 163-180.
- [31] A.L.S. Angelis, J. Bartke, M.Yu. Bogolyubsky, S.N. Filippov, E. Gładysz-Dziaduś, Yu.V. Kharlov, A.B. Kurepin, A.I. Maevskaya, G. Mavromanolakis, A.D. Panagiotou, S.A. Sadovsky, P. Stefanski and Z. Włodarczyk, 'CASTOR: A Forward Detector for the Identification of Centauros and Strangelets in Nucleus-Nucleus Collisions at the LHC', arXiv: [hep-ex/9901038v1](https://arxiv.org/abs/hep-ex/9901038v1) (1999). Also: A.L.S. Angelis *et al.*, 'Formation and identification of centauro and strangelets in nucleus-nucleus collisions at the LHC', *Nucl. Phys. B (Proc. Suppl.)* **75**(1-2) (1999) 203-205, doi: [10.1016/S0920-5632\(99\)00243-1](https://doi.org/10.1016/S0920-5632(99)00243-1); also: Proc. Int.

Symp. on Multiparticle Dynamics, Delphi, 6-11 Sep (1998).

- [32] J.-P. Blaizot, J. Iliopoulos, J. Madsen, G.G. Ross, P. Sonderegger, H.-J. Specht, 'Study of Potentially Dangerous Events During Heavy-ion Collisions at the LHC: Report of the LHC Safety Study Group', CERN Theoretical Physics Division, Document code: CERN 2003-001, (2003), <[http://www.inr.ac.ru/ads\\_icons/history/8/cern\\_p1.pdf](http://www.inr.ac.ru/ads_icons/history/8/cern_p1.pdf)>
- [33] A. Kent, 'Problems with empirical bounds for strangelet production at RHIC', arXiv: [hep-ph/0009130v2](https://arxiv.org/abs/hep-ph/0009130v2) (2000).
- [34] F. Calogero, 'Might a laboratory experiment destroy planet earth?', *Interdisciplinary Science Reviews* **25**(3) (2000) 191-202 doi: [10.1179/030801800679224](https://doi.org/10.1179/030801800679224)
- [35] A. Dar, A. De Rújula and U. Heinz, 'Will relativistic heavy-ion colliders destroy our planet?', *Phys. Lett.* **B470**(1-4) (1999) 142-148, doi: [10.1016/S0370-2693\(99\)01307-6](https://doi.org/10.1016/S0370-2693(99)01307-6); arXiv: [hep-ph/9910471v1](https://arxiv.org/abs/hep-ph/9910471v1) (1999).
- [36] S.A. Sadovsky, Yu. V. Kharlov, A.L.S. Angelis, E. Gładysz-Dziaduś, V.L. Korotkikh, G. Mavromanolakis and A.D. Panagiotou, 'Model for describing the production of Centauro events and strangelets in heavy-ion collisions', *Phys. At. Nucl.* **67**(2) (2004) 396-405, doi: [10.1134/1.1648929](https://doi.org/10.1134/1.1648929); see also: *Yad. Fiz.* **67** (2004) 414-424; arXiv: [nucl-th/0301003v1](https://arxiv.org/abs/nucl-th/0301003v1) (2003).
- [37] X.J. Wen, G.X. Peng and P.N. Shen, 'Color-flavor locked strangelets in a quark mass density-dependent model', *Int. J. Mod. Phys.* **A22**(8-9) (2007) 1649-1661, doi: [10.1142/S0217751X07035276](https://doi.org/10.1142/S0217751X07035276); arXiv: [hep-ph/0612253v1](https://arxiv.org/abs/hep-ph/0612253v1) (2006)
- [38] A. Andronic, P. Braun-Munzinger, J. Stachel, 'Hadron production in central nucleus-nucleus collisions at chemical freeze-out', *Nucl. Phys.* **A772** (2006) 167-199, doi: [10.1016/j.nuclphysa.2006.03.012](https://doi.org/10.1016/j.nuclphysa.2006.03.012); arXiv: [nucl-th/0511071v3](https://arxiv.org/abs/nucl-th/0511071v3) (2006).
- [39] J. Schaffner-Bielich, D. Kharzeev, L. McLerran and R. Venugopalan, 'Scaling properties of the transverse mass spectra', Proc. 30th International Workshop on Gross Properties of Nuclei and Nuclear Excitation, Hirschegg, Austria, 13-19 Jan 2002, <<http://www.bnl.gov/isd/documents/24816.pdf>>; arXiv: [nucl-th/0202054v1](https://arxiv.org/abs/nucl-th/0202054v1) (2002).
- [40] B. K. Srivastava, 'Forward-Backward Multiplicity Correlations in Au+Au Collisions at  $\sqrt{s_{NN}} = 200$  Gev', *Int. J. Mod. Phys.* **E16** (2008) 3371-3378; arXiv: [nucl-ex/0702054v1](https://arxiv.org/abs/nucl-ex/0702054v1) (2007).
- [41] T. Lappi, L. McLerran, 'Long range rapidity correlations as seen in the STAR experiment', *Nucl. Phys.* **A832** (2010) 330-345.
- [42] T.A. Armstrong *et al.*, 'Measurements of light nuclei production in 11.5A GeV/c Au+Pb heavy-ion collisions', *Phys. Rev.* **C61** (2000) id. 064908.
- [43] For CERN 'Large Hadron Collider Committee' minutes referring to 'CASTOR' (detector), CERN document codes: LHCC 062, LHCC 089, LHCC 091, LHCC 095, LHCC 096, LHCC 097, LHCC 099, LHCC minutes referring to (ALICE) 'Technical Proposal': CERN LHCC 95-41, CERN LHCC 94-25, CERN LHCC 97-053 rev., CERN LHCC 96-044, CERN LHCC 96-028, CERN LHCC 96-031, CERN LHCC 96-024, CERN LHCC 97-048, CERN LHCC 96-011. Enter code into [15]. For conference J. Ellis presented at, see details given within <http://cdsweb.cern.ch/search?sysno=000279424CER> '26th International Cosmic-ray Conference', 17 - 25 Aug 1999, Salt Lake City, UT, USA. (If necessary, contact this report author for evidence of any of this.)
- [44] P. Braun-Munzinger, K. Redlich and J. Stachel, 'Particle Production in Heavy Ion Collisions', arXiv: [nucl-th/0304013v1](https://arxiv.org/abs/nucl-th/0304013v1) (2003); Also P. Braun-Munzinger *et al.*, 'Particle Production in Heavy Ion Collisions', Quark Gluon Plasma 3, Eds. R.C. Hwa and X.-N. Wang (World Scientific, Singapore, 2004) 491.
- [45] C. Greiner, 'Physics of Strange Matter', *J. Phys.* **G25**(2) (1999) 389-401, doi: [10.1088/0954-3899/25/2/028](https://doi.org/10.1088/0954-3899/25/2/028).

- [46] M.A. Lisa, S. Pratt, R. Soltz and U. Wiedemann, ‘Femtoscopy in Relativistic Heavy Ion Collisions: Two Decades of Progress’, *Ann. Rev. Nucl. Part. Sci.* **55** (2005) 357-402, doi: [10.1146/annurev.nucl.55.090704.151533](https://doi.org/10.1146/annurev.nucl.55.090704.151533)
- [47] F. Retière and M.A. Lisa, ‘Observable implications of geometrical and dynamical aspects of freeze-out in heavy ion collisions’, *Phys. Rev.* **C70**(4) (2004) id. 044907 (33pp.), doi: [10.1103/PhysRevC.70.044907](https://doi.org/10.1103/PhysRevC.70.044907); arXiv: [nucl-th/0312024v3](https://arxiv.org/abs/nucl-th/0312024v3) (2004).
- [48] R.M. Weiner, ‘Surprises from the search for quark-gluon plasma? When was quark-gluon plasma seen?’, *Int. J. Mod. Phys.* **E15**(1) (2006) 37-70, doi: [10.1142/S0218301306004004](https://doi.org/10.1142/S0218301306004004); arXiv: [hep-ph/0507115v2](https://arxiv.org/abs/hep-ph/0507115v2) (2006).
- [49] J. Letessier, J. Rafelski, ‘Observing Quark-Gluon Plasma with Strange Hadrons’, *Int. J. Mod. Phys.* **E9** (2000) 107-147, doi: [10.1142/S0218301300000076](https://doi.org/10.1142/S0218301300000076); arXiv: [nucl-th/0003014v1](https://arxiv.org/abs/nucl-th/0003014v1) (2000).
- [50] A.S. Khvorostukhin, V.V. Skokov, V.D. Toneev, K. Redlich ‘Lattice QCD Constraints on the Nuclear Equation of State’, *Eur. Phys. J.* **C48** (2006) 531-543.
- [51] V.D.Toneev, A.S.Parvan, ‘Canonical Strangeness and Distillation Effects in Hadron Production’ *J. Phys.* **G31** (2005) 583-598 doi: [10.1088/0954-3899/31/7/005](https://doi.org/10.1088/0954-3899/31/7/005); arXiv: [nucl-th/0411125v2](https://arxiv.org/abs/nucl-th/0411125v2) (2005)
- [52] T.S. Biro, ‘Present and future challenges for quark matter theorists’, *J. Phys.* **G35**(4) (2008) id. 044056, doi: [10.1088/0954-3899/35/4/044056](https://doi.org/10.1088/0954-3899/35/4/044056).
- [53] J. Steinheimer, M. Mitrovski, T. Schuster, H. Petersen, M. Bleicher and H. Stöcker, ‘Strangeness fluctuations and MEMO production at FAIR’, *Phys. Lett.* **B676**(1-3) (2009) 126-131, doi:[10.1016/j.physletb.2009.04.062](https://doi.org/10.1016/j.physletb.2009.04.062); arXiv: [0811.4077v2](https://arxiv.org/abs/0811.4077v2) (2008).
- [54] E.P. Gilson and R.L. Jaffe, ‘Very Small Strangelets’, *Phys. Rev. Lett.* **71** (1993) 332-335, doi: [10.1103/PhysRevLett.71.332](https://doi.org/10.1103/PhysRevLett.71.332); arXiv: [hep-ph/9302270v1](https://arxiv.org/abs/hep-ph/9302270v1) (1993).
- [55] F.C. Michel, ‘Quark Matter or New Particles?’, *Phys. Rev. Lett.* **60**(8) (1988).
- [56] J. Song, F.-L. Shao and Q.-B. Xie, 'The Influence of Net Quarks on Yields and Rapidity Spectra of Identified Hadrons', *Int. J. Mod. Phys.* **A24**(6) (2009) 1161-1174, doi: [10.1142/S0217751X0904302X](https://doi.org/10.1142/S0217751X0904302X).
- [57] I.G. Bearden *et al.* (BRAHMS Collaboration), ‘Nuclear Stopping in Au+Au Collisions at  $\sqrt{s_{NN}}=200$  GeV’, *Phys. Rev. Lett.* **93**(10) (2004) id. 102301 (5pp.), doi: [10.1103/PhysRevLett.93.102301](https://doi.org/10.1103/PhysRevLett.93.102301).
- [58] L. Gerland, C. Spieles, M. Bleicher, H. Stoecker, C. Greiner , ‘Baryon Stopping and Strangeness Production in Ultra-Relativistic Heavy Ion Collisions’, Proc. of the Winter Meeting on Nuclear Physics, January 1996, Bormio, Italy; arXiv: [nucl-th/9606001v1](https://arxiv.org/abs/nucl-th/9606001v1) (1996).
- [59] E. Gładysz-Dziaduś, Yu V. Kharlov, Yu V, A. D. Panagiotou, A D, S.A. Sadovsky, ‘Generator for Centauro Event Simulation’, 3rd International Conference on Physics and Astrophysics of Quark-gluon Plasma Related, 17 - 21 Mar 1997, Jaipur, India. Available<sup>iii</sup> as .ps file from CERN Document Server [[15](#)].
- [60] M.N. Asprouli, A.D. Panagiotou and E. Gładysz-Dziaduś, ‘Interaction length and spontaneous decay of a cosmic ray “Centauro” fireball’, *Astropart. Phys.* **2**(2) (1994) 167-174, doi: [10.1016/0927-6505\(94\)90039-6](https://doi.org/10.1016/0927-6505(94)90039-6).

Please note that the quotes and exhibit images are taken from the arXiv version where available. The quotes themselves are usually identical in journal versions, for which the same content is sometimes slightly rephrased. Details of the CERN Document versions for the CASTOR papers are given in the subsequent section.

## List of CASTOR Strangelet Papers

Those papers available as CERN documents begin with 'ALICE-INT', 'CERN-ALICE', 'CERN-ALI', 'CERN-CMS-CR' or 'CERN-CMS' and should be accessible<sup>iii</sup> from the CERN Document Server [15]. The theoretical papers below appear in published physics journals or the free online <<http://www.arxiv.org>> collection of scientific papers (there are also several other related CERN documents). Note that CASTOR was originally to be installed at ALICE.

There are 16 CASTOR theory and a further 22 physicists who worked on the more technical aspects of CASTOR [17], who are<sup>iii</sup> all attached to CERN [5].

---

D. Apostolos-Panagiotou, 'Possible Production and Detection of Centauros and Strangelets at LHC', CERN document codes: ALICE-INT-1995-18; CERN-ALICE-INT-1995-18, Geneva, CERN (1995).

ALICE Collaboration, 'A Detector for ALICE at very Forward Rapidity Dedicated to the Identification and Study of Centauros and Strangelets, CERN document codes: ALICE-INT-1996-22; CERN-ALICE-INT-1996-22, CERN, Geneva (1996).

Yu V. Kharlov, A.D. Panagiotou, S.A. Sadovsky, 'Simulation of the Centauro events at CASTOR', CERN document codes: ALICE-INT-1997-06; CERN-ALICE-INT-1997-06, Geneva, CERN (1997).

A.D. Panagiotou, 'Particles from Centauro Decay in the CASTOR Detecting System', CERN document codes: ALICE-INT-1997-16; CERN-ALICE-INT-1997-16, Geneva, CERN (1997)

Z. Włodarczyk, 'Strongly Penetrating Cascades Caused by Strangelets in the Cosmic Ray Chambers and in the Castor Calorimeter', CERN document codes: ALICE-INT-1997-17; CERN-ALICE-INT-1997-17, Geneva, CERN (1997).

E. Gładysz-Dziadus, Z. Włodarczyk, 'Is the strongly penetrating component a sign of the strangelet passage through matter?' Presented at the International Symposium on Strangeness in Quark Matter (SQM '97), Thera, Santorini, Greece, 14 - 18 Apr 1997, CERN document codes: CERN-ALI-97-21; CERN-ALICE-PUB-97-21 (1997).

S. N. Filippov; E. Gładysz-Dziadus; Yu V Kharlov; A. B. Kurepin,; A. D. Panagiotou; S. A. Sadovsky, 'Centauro And STRange Object Research: CASTOR' Technical Proposal (Current Status Report). CERN document codes: ALICE-INT-1997-07; CERN-ALICE-INT-1997-07, CERN, Geneva (1997).

A.L.S. Angelis and A.D. Panagiotou, 'CASTOR: A dedicated detector for the detection of centauros and strangelets at the LHC', Proc. Int. Symp. on Strangeness in Quark Matter (SQM '97), Thera, Santorini, Greece, 14-18 Apr 1997, *J. Phys.* **G23**(12) (1997) 2069-2080, doi: [10.1088/0954-3899/23/12/032](https://doi.org/10.1088/0954-3899/23/12/032); CERN document codes: CERN-ALI-97-20; CERN-ALICE-PUB-97-20, Geneva, CERN (1997).

J. Bartke, E. Gładysz-Dziaduś and Z. Włodarczyk 'The energy deposition pattern as the unconventional strangelet signature and its relevance to the CASTOR calorimeter', CERN document codes: ALICE-INT-1998-38; CERN-ALICE-INT-1998-38, Geneva, CERN (1998)

A.L.S. Angelis, J. Bartke, M.Yu. Bogolyubsky, S.N. Filippov, E. Gładysz-Dziaduś, Yu.V. Kharlov, A.B. Kurepin, A.I. Maevskaya, G. Mavromanolakis, A.D. Panagiotou, S.A. Sadovsky, P. Stefanski and Z. Włodarczyk,

'Formation and identification of Centauro and Strangelets in nucleus- nucleus collisions at the LHC', 10th Int. Symp. on Very High Energy Cosmic Ray Interactions, L'Aquila, Italy, 12 - 17 Jul 1998, pp.203-205; CERN document codes: CERN-ALI-98-27; CERN-ALICE-PUB-98-27, Geneva, CERN (1999).

A.L.S. Angelis, J. Bartke, M.Yu. Bogolyubsky, S.N. Filippov, E. Gładysz-Dziadus, Yu.V. Kharlov, A.B. Kurepin, A.I. Maevskaya, G. Mavromanolakis, A.D. Panagiotou, S.A. Sadovsky, P. Stefanski and Z. Włodarczyk, 'Formation of Centauro in Pb+Pb Collisions at the LHC and their Identification in the ALICE Experiment' Presentation at the International Europhysics Conference on High-Energy Physics, Tampere, Finland, 15-21 Jul 1999, pp.957-958; CERN document codes: CERN-ALI-99-52; CERN-ALICE-PUB-99-52, Geneva : CERN (1999).

A.L.S. Angelis, J. Bartke, M.Yu. Bogolyubsky, S.N. Filippov, E. Gładysz-Dziadus, Yu.V. Kharlov, A.B. Kurepin, A.I. Maevskaya, G. Mavromanolakis, A.D. Panagiotou, S.A. Sadovsky, P. Stefanski and Z. Włodarczyk, 'Formation of Centauro and Strangelets in Nucleus-Nucleus Collisions at the LHC and their Identification by the ALICE Experiment'. Presentation at the 26th International Cosmic-ray Conference, Salt Lake City, UT, USA, 17-25 Aug 1999; CERN document codes: CERN-ALI-99-54; CERN-ALICE-PUB-99-54, Geneva, CERN (1999).

A.L.S. Angelis, J. Bartke, M.Yu. Bogolyubsky, S.N. Filippov, E. Gładysz-Dziadus, Yu.V. Kharlov, A.B. Kurepin, A.I. Maevskaya, G. Mavromanolakis, A.D. Panagiotou, S.A. Sadovsky, P. Stefanski and Z. Włodarczyk, 'Formation and identification of centauro and strangelets in nucleus-nucleus collisions at the LHC', Proc. Int. Symp. on Multiparticle Dynamics, Delphi, 6-11 Sep. 1998, *Nucl. Phys. B (Proc. Suppl.)* 75(1-2) (1999) 203-205, doi: [10.1016/S0920-5632\(99\)00243-1](https://doi.org/10.1016/S0920-5632(99)00243-1); CERN document codes: CERN-ALI-98-27; CERN-ALICE-PUB-98-27, Geneva, CERN (1999).

A.L.S. Angelis, J. Bartke, E. Gładysz-Dziadus and Z. Włodarczyk, 'The energy deposition pattern as the unconventional strangelet signature and its application to the new accelerator experiments', *EPJ direct* C9 (2000) 1-18, <<http://www.springerlink.com/content/knp6v16151258432/fulltext.pdf>>, doi: [10.1007/s1010500c0009](https://doi.org/10.1007/s1010500c0009); CERN document codes: CERN-ALI-99-55; CERN-ALICE-PUB-99-55, Geneva, CERN (1999).

A.L.S. Angelis, J. Bartke, M. Yu Bogolyubsky, S.N. Filippov, E. Gladysz-Dziadus, Yu V. Kharlov, A.B. Kurepin, A.I. Maevskaya, G. Mavromanolakis, A.D. Panagiotou, S.A. Sadovsky, P. Stefanski, Z. Włodarczyk, 'CASTOR : The ALICE forward detector for identification of Centauros and Strangelets in Nucleus-Nucleus Collisions at the LHC' hep-ex/9901038; CERN document codes: CERN-ALI-99-04 ; CERN-ALICE-PUB-99-04, Geneva, CERN (1999), arXiv: [hep-ex/9901038v1](https://arxiv.org/abs/hep-ex/9901038v1) (1999).

A.L.S. Angelis, J. Bartke, M.Yu. Bogolyubsky, S.N. Filippov, E. Gładysz-Dziadus, Yu.V. Kharlov, A.B. Kurepin, A.I. Maevskaya, G. Mavromanolakis, A.D. Panagiotou, S.A. Sadovsky, P. Stefanski and Z. Włodarczyk, 'CASTOR: A Forward Detector for the Identification of Centauros and Strangelets in Nucleus-Nucleus Collisions at the LHC', arXiv: [hep-ex/9901038v1](https://arxiv.org/abs/hep-ex/9901038v1) (1999); CERN document codes: CERN-ALI-99-14; CERN-ALICE-PUB-99-14, Geneva, CERN (2000).

A.L.S. Angelis, X. Aslanoglou, J. Bartke, M. Yu. Bogolyubsky, K. Choleev, S. Erine, E. Gładysz-Dziadus, Yu.V. Kharlov, A.B. Kurepin, M. Lobanov, A.I. Maevskaya, G. Mavromanolakis, N. Nicolis, A.D. Sadovsky, S.A. Panagiotou and Z. Włodarczyk, 'CASTOR detector: Model, objectives and simulated performance', Chacaltaya Meeting on Cosmic Ray Physics, La Paz, Bolivia, 23-27 Jul 2000, *Nuovo Cim.* C24(4-5) (2001) 755-760.

A.L.S. Angelis, J. Bartke, M.Yu. Bogolyubsky, E. Gładysz-Dziadus, Yu.V. Kharlov, A.B. Kurepin, A.I. Maevskaya, G. Mavromanolakis, A.D. Panagiotou, S.A. Sadovsky, P. Stefanski and Z. Włodarczyk, 'CASTOR: Centauro and strange object research in nucleus-nucleus collisions at the LHC', Proc. 11th Int. Symp. on Very High Energy Cosmic Ray Interactions, Campinas, Brazil, 17-21 Jul 2000, *Nucl. Phys. B (Proc. Suppl.)* 97(1-3)



(2001) 227-230, doi: [10.1016/S0920-5632\(01\)01270-1](https://doi.org/10.1016/S0920-5632(01)01270-1).

E. Gładysz-Dziaduś, 'Are Centauros exotic signals of the QGP?', *Phys. Part. Nucl.* **34** (2001) 285-347; see also *Fiz. Elem. Chast. Atom. Yadra* **34** (2003) 565-678; arXiv: [hep-ph/0111163v1](https://arxiv.org/abs/hep-ph/0111163v1) (2001).

E. Gładysz-Dziaduś for the CASTOR group, 'CASTOR: Centauro and Strange Object Research in nucleus-nucleus collisions at LHC', talk given at the Int. Workshop on Nuclear Theory, 10-15 Jun 2002, Rila Mountains, Bulgaria, arXiv: [hep-ex/0209008v2](https://arxiv.org/abs/hep-ex/0209008v2) (2002).

A.L.S. Angelis, X. Aslanoglu, J. Bartke, K. Choleev, E. Gładysz-Dziaduś, M.B. Golubeva, F.F. Guber, T.L. Karavitcheva, Yu.V. Kharlov, A.B. Kurepin, G. Mavromanolakis, A.D. Panagiotou, S.A. Sadovsky, V.V. Tiflov and Z. Włodarczyk, 'Formation and detection of centauro in Pb+Pb collisions at the LHC', *J. Phys.* **G28**(7) (2002) 1937-1942, doi: [10.1088/0954-3899/28/7/349](https://doi.org/10.1088/0954-3899/28/7/349).

A.L.S. Angelis, X. Aslanoglu, J. Bartke, K. Choleev, E. Gładysz-Dziaduś, M. Golubeva, F. Guber, T. Karavitcheva, Y.V. Kharlov, A.B. Kurepin, G. Mavromanolakis, A.D. Panagiotou, S.A. Sadovsky, V.V. Tiflov and Z. Włodarczyk, 'Formation of Centauro in Pb+Pb collisions at the LHC and their detection with the CASTOR detector of CMS', Proc. 12th Int. Symp. on Very High Energy Cosmic Ray Interactions, CERN, Geneva, Switzerland, 15-20 Jul 2002, *Nucl. Phys. B (Proc. Suppl.)* **122** (2003) 205-208, doi: [10.1016/S0920-5632\(03\)80379-1](https://doi.org/10.1016/S0920-5632(03)80379-1).

S.A. Sadovsky, Yu. V. Kharlov, A.L.S. Angelis, E. Gładysz-Dziaduś, V.L. Korotkikh, G. Mavromanolakis and A.D. Panagiotou, 'Model for describing the production of Centauro events and strangelets in heavy-ion collisions', *Phys. At. Nucl.* **67**(2) (2004) 396-405, doi: [10.1134/1.1648929](https://doi.org/10.1134/1.1648929); see also: *Yad. Fiz.* **67** (2004) 414-424; arXiv: [nucl-th/0301003v1](https://arxiv.org/abs/nucl-th/0301003v1) (2003).

E. Norbeck, Y. Onel, A.D. Panagiotou and M. Murray, 'Heavy-Ion Reactions at Forward Angles with CMS (LHC)', *Acta Physica Hungarica A) Heavy Ion Physics* **21**(2-4) (2004) 321-327.

E. Gładysz-Dziaduś, 'Black Holes versus Strange Quark Matter', arXiv: [hep-ph/0405115v3](https://arxiv.org/abs/hep-ph/0405115v3) (2005); see also: E. Gładysz-Dziaduś and Z. Włodarczyk, 'Black Holes versus Strange Quark Matter' in *Trends in Black Hole Research*, Ed. P.V. Kreitler (Nova Science, New York, 2006) 163-180.

E. Gładysz-Dziaduś, 'CASTOR: Centauro And STRange Object Research - Exotic Aspects of Forward Physics at the LHC', *Acta Phys. Pol.* **B37**(1) (2006) 153-160, <<http://th-www.if.uj.edu.pl/acta/vol37/pdf/v37p0153.pdf>>.

A.D. Panagiotou, P. Katsas for the CMS collaboration, 'Searching for Strange Quark Matter with the CMS/CASTOR Detector at the LHC', Proc. 5th Int. Conf. on Perspectives in Hadron Physics, Particle-Nucleus and Nucleus-Nucleus Scattering at Relativistic Energies, Trieste, Italy, 22-26 May 2006, *Nucl. Phys.* **A782**(1-4) (2007) 383-391, doi: [10.1016/j.nuclphysa.2006.10.020](https://doi.org/10.1016/j.nuclphysa.2006.10.020).

E. Norbeck, Y. Onel, E. Gładysz-Dziaduś, A.D. Panagiotou and P. Katsas, 'Exotic Physics at the LHC with CASTOR in CMS', CMS Conference Report 2007/013, *Int. J. Mod. Phys.* **E16**(7-8) (2007) 2451-2456, doi: [10.1142/S0218301307008082](https://doi.org/10.1142/S0218301307008082), <[http://cms.cern.ch/iCMS/jsp/openfile.jsp?type=CR&year=2007&files=CR2007\\_013.pdf](http://cms.cern.ch/iCMS/jsp/openfile.jsp?type=CR&year=2007&files=CR2007_013.pdf)>; CERN document codes: CMS-CR-2007-013; CERN-CMS-CR-2007-013, Geneva, CERN, (2007), 5 p.

## List of ALICE Strangelet Papers

The first is a CERN document and the five published papers involve CERN's Coffin and Kuhn and up to 8 other CERN-attached physicists at this time <sup>iii</sup> ([5]).

---

ALICE Collaboration, 'ALICE: Technical Proposal for A Large Ion Collider Experiment at the CERN LHC', CERN document codes: CERN/LHCC/95-71, LHCC/P3, (1995) ISBN: 9789290830771 and ISBN: 9290830778 CERN, Geneva; abstract: <<http://consult.cern.ch/alice/Documents/1995/01/abstract>>, available as download at: <http://cdsweb.cern.ch/record/293391?ln=en>>.

J.P. Coffin, P. Crochet, P. Fintz, G. Guillaume, F. Jundt, A. Michalon, F. Rami, C. Roy, 'Search for Exotic Forms of Strange Matter in the ALICE Experiment', CERN document codes: ALICE-INT-1995-49; CERN-ALICE-INT-1995-49, Geneva, CERN, (1995).

C. Spieles, L. Gerland, H. Stöcker, C. Greiner, C. Kuhn and J.P. Coffin, 'Creation of Strange Matter at Low Initial  $\mu/T$ ', *Phys. Rev. Lett.* **76**(11) (1996) 1776–1779, doi: [10.1103/PhysRevLett.76.1776](https://doi.org/10.1103/PhysRevLett.76.1776).

J.P. Coffin and C. Kuhn, 'Search for exotic strange matter in the ALICE and STAR experiments at the LHC and RHIC heavy-ion colliders', Proc. Int. Symp. on Strangeness in Quark Matter (SQM '97), Thera, Santorini, Greece, 14-18 Apr 1997, *J. Phys.* **G23**(12) (1997) 2117-2125, doi: [10.1088/0954-3899/23/12/037](https://doi.org/10.1088/0954-3899/23/12/037).

J.P. Coffin, 'Some Aspects of Ultra-Relativistic Heavy-Ion Collisions, Complex Forms of Strangeness', 241st WE-Heraeus Seminar: Symp. on fundamental issues in elementary matter, Bad Hannef, Germany, *Acta Phys. Hung.* **A14**(1-4) (2001) 72-82, doi: [10.1556/APH.14.2001.1-4.9](https://doi.org/10.1556/APH.14.2001.1-4.9); Also presentation at: <[http://www.star.bnl.gov/public/ssd/STAR\\_documents/BadHonnef00JPC/sld001.htm](http://www.star.bnl.gov/public/ssd/STAR_documents/BadHonnef00JPC/sld001.htm)>.

C. Kuhn, B. Hippolyte, J.P. Coffin, J. Baudot, I. Belikov, D. Dietrich, M. Germain and C. Suire 'Search for strange dibaryons in STAR and ALICE', *J. Phys.* **G28**(7) (2002) 1707-1714, doi: [10.1088/0954-3899/28/7/323](https://doi.org/10.1088/0954-3899/28/7/323).

J.P. Coffin, C. Kuhn, B. Hippolyte, J. Baudot and I. Belikov, 'Multi-strange-quark states at ultra-relativistic heavy-ion collisions', *Pramana* **60**(5) (2003) 1055-1058, <<http://www.ias.ac.in/pramana/v60/p1055/fulltext.pdf>>, doi: [10.1007/BF02707030](https://doi.org/10.1007/BF02707030).

## Exhibits

### Exhibit 1

meaningful limit on its abundance will be a subtle and difficult undertaking.

Finally, it is of practical importance to know if stable strange matter exists or can be made in quantity. Negatively charged strange matter, either as strangelets or in bulk, does not exist on earth. If it is stable and could be created it would react exothermically with ordinary matter, converting everything it touched into more of itself. Positively charged strange matter would have no such immediate apocalyptic consequences. Nevertheless, its propensity to absorb neutrons exothermically without limit has implications for energy production which could have great importance.

[Farhi84] E. Farhi and R.L. Jaffe, ‘Strange matter’, *Phys. Rev.* **D30**(11) (1 Dec 1984) 2379-2390, doi: [10.1103/PhysRevD.30.2379](https://doi.org/10.1103/PhysRevD.30.2379). ▶ p. 2390 (no link) [[Back to the text](#)]

---

### Exhibit 2

#### V. STRANGELETS AND STRANGE MATTER

The scientific issues surrounding the possible creation of a negatively charged, stable strangelet are complicated. Also, it appears that if such an object did exist and could be produced at RHIC, it might indeed be dangerous. Therefore we wish to give this scenario careful consideration.

This section is organized as follows. First we give a pedagogical introduction to the properties of strangelets and strange matter. Second we discuss the mechanisms that have been proposed for producing a strangelet in heavy ion collisions. We examine these mechanisms and conclude that strangelet production at RHIC is extremely unlikely. Nevertheless, we go on to discuss what might occur if a stable, negatively charged strangelet could be produced at RHIC. In light of the possible consequences of production of a stable negatively charged strangelet, we shall refer to such an object as a “dangerous” strangelet.

We then turn to the cosmic ray data. We obtain strong bounds on the dangerous strangelet production probability at RHIC from physically reasonable assumptions.

[2] R.L. Jaffe, W. Busza, F. Wilczek and J. Sandweiss, ‘Review of speculative “disaster scenarios” at RHIC’, *Rev. Mod. Phys.* **72**(4) (2000) 1125-1140, doi: [10.1103/RevModPhys.72.1125](https://doi.org/10.1103/RevModPhys.72.1125); arXiv: [hep-ph/9910333v3](https://arxiv.org/abs/hep-ph/9910333v3) 14 Jul 2000. ▶ p. 11 [[Back](#)]

## Exhibit 3

might fragment the strangelet into smaller, unstable objects. Unfortunately, we do not know enough about QCD either to confirm or exclude these possibilities.

A strangelet growing by absorbing ordinary matter would have an electric charge very close to zero. If its electric charge were negative, it would quickly absorb (positively charged) ordinary matter until the electric charge became positive. At that point absorption would cease until electron capture again made the quark charge negative. As soon as the quark charge became negative the strangelet would absorb a nucleus. Thus the growing strangelet's electric charge would fluctuate about zero as it alternately absorbed nuclei and captured electrons. Even though the typical time for a single quark to capture an electron might be quite long, the number of participating quarks grows linearly with  $A$ , so the baryon number of the strangelet would grow exponentially with time, at least until the energy released in the process began to vaporize surrounding material and drive it away from the growing strangelet. This process would continue until all available material had been converted to strange matter. We know of no absolute barrier to the rapid growth of a dangerous strangelet, were such an object hypothetically to exist and be produced. This is why we have

[2] R.L. Jaffe, W. Busza, F. Wilczek and J. Sandweiss, 'Review of speculative "disaster scenarios" at RHIC', *Rev. Mod. Phys.* **72**(4) (2000) 1125-1140, doi: [10.1103/RevModPhys.72.1125](https://doi.org/10.1103/RevModPhys.72.1125); arXiv: [hep-ph/9910333v3](https://arxiv.org/abs/hep-ph/9910333v3) 14 Jul 2000. ▶ p. [20](#) [[Back](#)]

---

## Exhibit 4

### Strangelets

Strangelet is the term given to a hypothetical microscopic lump of 'strange matter' containing almost equal numbers of particles called up, down and strange quarks. According to most theoretical work, strangelets should change to ordinary matter within a thousand-millionth of a second. But could strangelets coalesce with ordinary matter and change it to strange matter? This question was first raised before the start up of the Relativistic Heavy Ion Collider, RHIC, in 2000 in the United States. A study at the time showed that there was no cause for concern, and RHIC has now run for eight years, searching for strangelets without detecting any. At times, the LHC will run with beams of heavy nuclei, just as RHIC does. The LHC's beams will have more energy than RHIC, but this makes it even less likely that strangelets could form. It is difficult for strange matter to stick together in the high temperatures produced by such colliders, rather as ice does not form in hot water. In addition, quarks will be more dilute at the LHC than at RHIC, making it more difficult to assemble strange matter. Strangelet production at the LHC is therefore less likely than at RHIC, and experience there has already validated the arguments that strangelets cannot be produced.

[CERN Safety] <<http://public.web.cern.ch/public/en/lhc/safety-en.html>> [[Back](#)]

## Exhibit 5

In the case of phenomena, such as vacuum bubble formation via phase transitions or the production of magnetic monopoles, which had already been excluded by the previous report [1], no subsequent development has put into question those firm conclusions. Stable and neutral black holes, in addition to being excluded by all known theoretical frameworks, are either excluded by the stability of astronomical bodies, or would accrete at a rate that is too low to cause any macroscopic effects on timescales much longer than the natural lifetime of the solar system. The previous arguments about the impossibility to produce strangelets at the LHC are confirmed and reinforced by the analysis of the RHIC data.

We have considered all the proposed speculative scenarios for new particles and states of matter that currently raise safety issues. Since our methodology is based on empirical reasoning based on experimental observations, it would be applicable to other exotic phenomena that might raise concerns in the future.

[4] J. Ellis, G. Giudice, M.L. Mangano, I. Tkachev and U. Wiedemann (LHC Safety Assessment Group), 'Review of the safety of LHC Collisions', *J. Phys.* **G35**(11) (2008) id. 115004 (18pp.), doi: [10.1088/0954-3899/35/11/115004](https://doi.org/10.1088/0954-3899/35/11/115004); arXiv: [0806.3414v2](https://arxiv.org/abs/0806.3414v2) [hep-ph] 18 Sep 2008. ▶ p. [13](#) [[Back to text](#)] [[Back to table](#)]

## Exhibit 6

**07 NOV, 21:25 CASTOR SEES PARTICLES FOR FIRST TIME!**

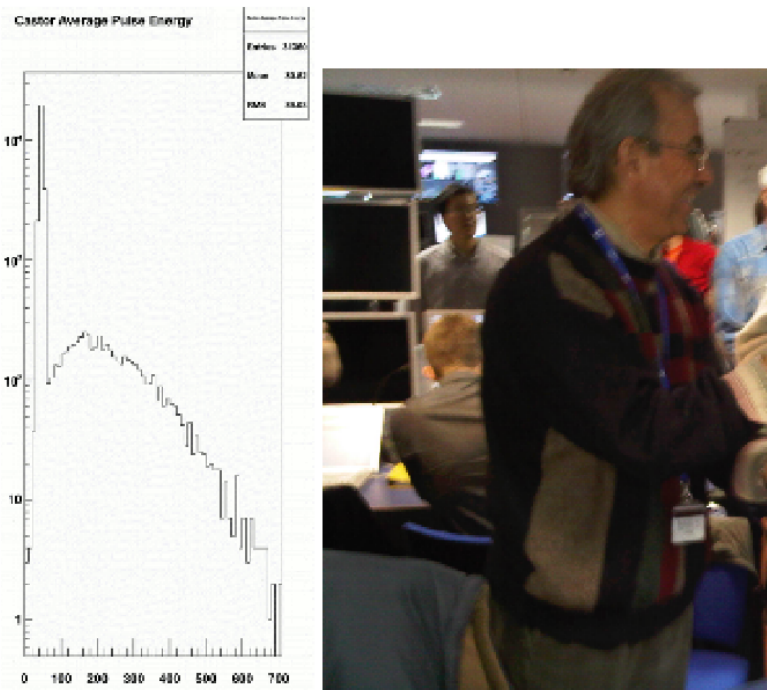

The new forward calorimeter Castor sees energy deposits.

[e-comm] <<http://cms.web.cern.ch/cms/News/e-commentary/cms-e-commentary09a.htm>> [[Back](#)]

## Exhibit 7

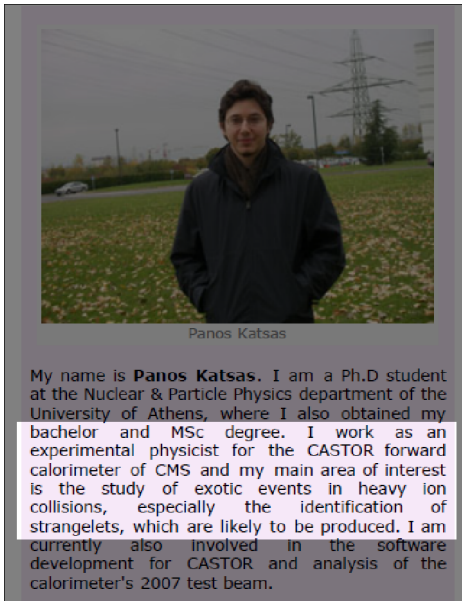

[Newslet07] D. Barney and M. Lapka, Eds., 'The University of Athens (Greece) in CMS', *CMS Times* (3 Dec 2007), <[http://cms.web.cern.ch/cms/Media/Publications/CMStimes/2007/12\\_03/index.html](http://cms.web.cern.ch/cms/Media/Publications/CMStimes/2007/12_03/index.html)>, <[http://cms.web.cern.ch/cms/Media/Publications/CMStimes/2007/12\\_03/pdf/CMS%20Times.pdf](http://cms.web.cern.ch/cms/Media/Publications/CMStimes/2007/12_03/pdf/CMS%20Times.pdf)> [Back]

---

## Exhibit 8

*Review of Speculative "Disaster Scenarios" at RHIC*

20

produced at RHIC. It would have to be a light representative of a generic form of strange matter with *negative* electric charge in bulk. It would have to live long enough to slow down and come to rest in matter. Note that the term "metastable" is used rather loosely in the strangelet literature. Sometimes it is used to refer to strangelets that live a few orders of magnitude longer than strong interaction time scales. As mentioned above, we use "metastable" to refer to a lifetime long enough to traverse the detector, slow down and stop in the shielding. Since strangelets produced at high rapidity are likely to be destroyed by subsequent collisions, we assume a production velocity below  $v_{\text{crit}} = 0.1c$  [2]. Hence it requires a lifetime greater than  $\sim 10^{-7}$  sec in order to satisfy our definition of "metastable".

Once brought to rest, a negative metastable strangelet would be captured quickly by an ordinary nucleus in the environment. Cascading quickly down into the lowest

[2] R.L. Jaffe, W. Busza, F. Wilczek and J. Sandweiss, 'Review of speculative "disaster scenarios" at RHIC', *Rev. Mod. Phys.* **72**(4) (2000) 1125-1140, doi: [10.1103/RevModPhys.72.1125](https://doi.org/10.1103/RevModPhys.72.1125); arXiv: [hep-ph/9910333v3](https://arxiv.org/abs/hep-ph/9910333v3) 14 Jul 2000. ▶ p. [20](#) [Back]

## Exhibit 9

produced at RHIC. It would have to be a light representative of a generic form of strange matter with *negative* electric charge in bulk. It would have to live long enough to slow down and come to rest in matter. Note that the term “metastable” is used rather loosely in the strangelet literature. Sometimes it is used to refer to strangelets that live a few orders of magnitude longer than strong interaction time scales. As mentioned above, we use “metastable” to refer to a lifetime long enough to traverse the detector, slow down and stop in the shielding. Since strangelets produced at high rapidity are likely to be destroyed by subsequent collisions, we assume a production velocity below  $v_{\text{crit}} = 0.1c$  [2]. Hence it requires a lifetime greater than  $\sim 10^{-7}$  sec in order to satisfy our definition of “metastable”.

Once brought to rest, a negative metastable strangelet would be captured quickly by an ordinary nucleus in the environment. Cascading quickly down into the lowest

[2] R.L. Jaffe, W. Busza, F. Wilczek and J. Sandweiss, ‘Review of speculative “disaster scenarios” at RHIC’, *Rev. Mod. Phys.* **72**(4) (2000) 1125-1140, doi: [10.1103/RevModPhys.72.1125](https://doi.org/10.1103/RevModPhys.72.1125); arXiv: [hep-ph/9910333v3](https://arxiv.org/abs/hep-ph/9910333v3) 14 Jul 2000. ▶ p. [20](#) [[Back](#)]

---

## Exhibit 10

Our conservative estimate for the thermal production of a *normal*  $A = 10$  nucleus at the LHC was  $3 \times 10^{-25}$  times the rate of nucleon production. Taking the latter rate to lie in the hundreds, we arrive at a probability of  $10^{-13}$  that a single normal nucleus of size  $A = 10$  is produced during the entire LHC program as a result of the essentially thermal dynamics in a heavy ion collision. So, if LHC would run for the entire lifetime of the Universe, the probability of producing such a single nucleus via thermal production would be  $1/1000^1$ .

We note that the above is an estimate for the thermal production of a *normal*  $A = 10$  nucleus from a hadron gas of temperature  $T = 165$  MeV. The production of normal nuclear matter provides an extremely conservative upper bound on the production of strange quark matter. For this reason, we find that the significant empirical support for thermal particle production in heavy ion collisions, which was substantiated further by RHIC data in recent years, strengthens the main conclusion

<sup>1</sup> One may add that in semi-peripheral collisions, nuclei with  $A = 10$  may appear amongst the break-up products of the spectators of the nuclear projectile. However, such fragment production of nuclear remnants is not a mechanism that could give rise to strangelets. For this reason, we focus solely on thermal production rates of normal nuclei.

[4] J. Ellis, G. Giudice, M.L. Mangano, I. Tkachev and U. Wiedemann (LHC Safety Assessment Group), ‘Review of the safety of LHC Collisions’, *J. Phys.* **G35**(11) (2008) id. 115004 (18pp.), doi: [10.1088/0954-3899/35/11/115004](https://doi.org/10.1088/0954-3899/35/11/115004); arXiv: [0806.3414v2](https://arxiv.org/abs/0806.3414v2) [hep-ph] 18 Sep 2008. ▶ p. [19](#) [[Back](#)]

## Exhibit 11

**Cross Section Estimation for Strangelets**

- The probability for a hadron-rich ‘Centauro-type’ event, estimated from statistics of Chacaltaya and Pamir experiments for cosmic ray families with visible energy greater than 100 TeV, is about 3%.
- In about 10% of these hadron-rich events, strongly penetrating cascades, clusters, or “halo” were observed. We assume the total probability for ‘Long Flying Component’ (Strangelet?) production in central nucleus-nucleus collisions to be approximately:  $0.03 \times 0.1 \sim O(10^{-3})$ .
- At LHC kinematics, the percent of Strangelets falling in CASTOR phase space is  $\sim 10\%$  of total number of Strangelets produced in central Pb-Pb collisions. This quantity depends on the mass and energy of the Strangelet, as calculated by the “Centauro model” MC code CENGEN.
- A rough estimation of the total probability for Strangelet production and detection in CASTOR is:  
$$P_{\text{CASTOR strangelet}} \approx 10^{-3} \times 0.1 \approx O(10^{-4})$$
- This number, even if it is uncertain by an order of magnitude down, is a very large number !

[CASTOR Pres] P. Katsas, A.D. Panagiotou and E. Gładysz-Dziaduś for the CMS/CASTOR Group, ‘Searching for Strange Quark Matter with the CMS/CASTOR Detector at the LHC’, CMS-HI meeting, (23 Sep 2006) <[http://cmsdoc.cern.ch/cms/castor/html/files/strangelet\\_cmsweek230906.ppt](http://cmsdoc.cern.ch/cms/castor/html/files/strangelet_cmsweek230906.ppt)>.

► slide [30](#) [[Back](#)]

---

## Exhibit 12

### Summary of the safety argument

#### 1. Quantitative considerations

The maximal luminosity of lead-lead (Pb+Pb) collisions at the LHC is  $L = 10^{27} \text{ cm}^{-2} \text{ s}^{-1}$ . With a hadronic Pb+Pb cross section of 8 barn, this implies a rate of up to 8000 Pb+Pb collisions per second. With a foreseen running time of 1 month per year ( $10^6$  seconds) times a duration of the program of, say, 10 years, we arrive at a conservative upper bound on the total number of ion-ion collisions at the LHC of  $O(10^{11})$ . However, a large fraction of the hadronic Pb+Pb cross section is diffractive or very peripheral. Only 10 percent of the entire rate can be considered as being sufficiently central for creating a collision system characteristic of a heavy-ion collision with a number of participants  $N_{\text{part}} > 20$ . As a consequence, a conservative bound on the number of heavy ion collisions relevant for production of an  $A = 10$  nucleus is  $O(10^{10})$ .

[4] J. Ellis, G. Giudice, M.L. Mangano, I. Tkachev and U. Wiedemann (LHC Safety Assessment Group), ‘Review of the safety of LHC Collisions’, *J. Phys.* **G35**(11) (2008) id. 115004 (18pp.), doi: [10.1088/0954-3899/35/11/115004](https://doi.org/10.1088/0954-3899/35/11/115004); arXiv: [0806.3414v2](https://arxiv.org/abs/0806.3414v2) [hep-ph] 18 Sep 2008. ► p. [19](#) [[Back](#)]



## Exhibit 13

**Table 1.** Average characteristic quantities of modeled Centauro and Strangelets produced in Cosmic Rays and expected at the LHC.

Centauro	Cosmic Rays	LHC
Interaction	“Fe + N”	Pb + Pb
$\sqrt{s}$	$\geq 6.76$ TeV	1148 TeV
Fireball mass	$\gtrsim 180$ GeV	$\sim 500$ GeV
Projectile rapidity $y_{proj}$	$\geq 11$	8.67
Lorentz factor $\gamma$	$\geq 10^4$	$\simeq 300$
Centauro pseudorapidity $\eta_{cent}$	9.9	$\simeq 5.6$
$\Delta\eta_{cent}$	1	$\simeq 0.8$
$\langle p_T \rangle$	1.75 GeV	1.75 GeV (*)
Lifetime	$10^{-9}$ s	$10^{-9}$ s (*)
Decay probability	( $x \geq 10$ km) 10 %	( $x \leq 1$ m) 1 %
Strangeness	14	60 - 80
$f_s$ (S/A)	$\simeq 0.1-0.4$	0.30 - 0.45
Z/A	$\simeq 0.3-0.4$	$\simeq 0.2$
Event rate	$\simeq 1$ %	$\simeq 0.1$ %
“Strangelet”	Cosmic Rays	LHC
Mass	$\simeq 7 - 15$ GeV	10 - 80 GeV
$f_s$	$\simeq 1$	$\simeq 1$
Strangelet pseudorapidity $\eta_{str}$	$\eta_{cent} + 1.2$	$\eta_{cent} + 1.2$

(\*) assumed

[27] E. Gładysz-Dziaduś for the CASTOR group, ‘CASTOR: Centauro and Strange Object Research in nucleus-nucleus collisions at LHC’, talk given at the Int. Workshop on Nuclear Theory, 10-15 Jun 2002, Rila Mountains, Bulgaria, arXiv: [hep-ex/0209008v2](https://arxiv.org/abs/hep-ex/0209008v2) (2002). ▶ tab. 1, p. 6 [Back]

## Exhibit 14

LHC. This can provide suitable initial conditions for the possible creation of strange matter in colliders. A phase transition (e.g., a chiral one) can further increase the strange matter formation probability. The formation of exotic multistrange objects may proceed as strangelet distillation out of a QGP droplet or as clustering of (anti)hyperons.

In a simple dynamic model the hadronization of QGP results in the formation of strangelets even for  $S/A^{\text{init}} \approx 500$  and  $A_B^{\text{init}} \approx 30$ . The distillation of very small strangelets of  $A_B \leq 10$  (see Table I) cannot be excluded for the midrapidity region at colliders. However, finite size effects of describing small strangelets neglected here might become crucial [20]. Be also reminded that the

[26] C. Spieles, L. Gerland, H. Stöcker, C. Greiner, C. Kuhn and J.P. Coffin, ‘Creation of Strange Matter at Low Initial  $\mu/T$ ’, *Phys. Rev. Lett.* **76**(11) (1996) 1776–1779, doi: [10.1103/PhysRevLett.76.1776](https://doi.org/10.1103/PhysRevLett.76.1776). ▶ p. 1779 (no link) [Back]

## Exhibit 15

produced at RHIC. This is one factor that makes strangelet production no more likely at the LHC than at RHIC. Another major factor pointing in the same direction is that the net density of nucleons, measured by the baryon number, will be lower at the LHC than at RHIC. This is because the system produced in heavy-ion collisions at the LHC is spread over a larger rapidity range, and the same total net baryon number will be spread over a larger volume. As discussed in more detail in the Appendix, this effect has already been seen at RHIC, where the net density of nucleons is lower than in lower-energy experiments, and this trend will continue at the LHC [3]. Since strangelets require baryon number to be formed, this effect makes strangelet production less likely at the LHC than at RHIC.

We conclude on general physical grounds that heavy-ion collisions at the LHC are less likely to produce strangelets than the lower-energy heavy-ion collisions already carried out in recent years at RHIC, just as strangelet production at RHIC was less likely than in previous lower-energy experiments carried out in the 1980s and 1990s [8].

[4] J. Ellis, G. Giudice, M.L. Mangano, I. Tkachev and U. Wiedemann (LHC Safety Assessment Group), ‘Review of the safety of LHC Collisions’, *J. Phys.* **G35**(11) (2008) id. 115004 (18pp.), doi: [10.1088/0954-3899/35/11/115004](https://doi.org/10.1088/0954-3899/35/11/115004); arXiv: [0806.3414v2](https://arxiv.org/abs/0806.3414v2) [hep-ph] 18 Sep 2008. ▶ p. 11 [Back]

## Exhibit 16

"Centauro" event	
Hadron multiplicity $\langle N_h \rangle$	64-90, $\langle 75 \rangle$
$\gamma$ multiplicity	0
Average total incident energy	$\langle E \rangle \geq 1740$ TeV
Total interaction energy in "60+14" c.m.	$\sqrt{s} \geq 6760$ GeV
Total interaction energy in N-N c.m.	$\sqrt{s_{N-N}} \geq 233$ GeV
Incident nucleus rapidity in laboratory frame	$y_{pr} = 11.03$
Midrapidity of "60+14" system	$y_{c.m.} = 6.24$
Laboratory pseudorapidity of emitted baryons	$\langle \eta_{cent} \rangle = 9.9 \pm 0.2$
Width of pseudorapidity distribution	$\langle \Delta \eta_{cent} \rangle \simeq 1 \pm 0.2$
Average transverse momentum	$\langle p_T \rangle = 1.75 \pm 0.7$ GeV/c
Mass of fireball	$M_{fb} = 180 \pm 60$ GeV
Volume of fireball	$V_{fb} \leq 75 - 100$ fm <sup>3</sup> (*)
Energy density of fireball	$\epsilon_{fb} \geq 2.4 \pm 1$ GeV fm <sup>-3</sup> (*)
Baryochemical potential of fireball	$\mu_b = 1.8 \pm 0.3$ GeV
Temperature of fireball	$T_{fb} = 130 \pm 6$ MeV
Quark density of fireball	$\langle \rho_q \rangle = 8 \pm 3$ fm <sup>-3</sup>
Baryon density of fireball	$\langle \rho_b \rangle = 2.7 \pm 1$ fm <sup>-3</sup>
Strange quark density	$\rho_s \sim 0.14$ fm <sup>-3</sup>

[23] E. Gładysz-Dziaduś, ‘Are Centauros exotic signals of the QGP?’, *Phys. Part. Nucl.* **34** (2001) 285-347; arXiv: [hep-ph/0111163v1](https://arxiv.org/abs/hep-ph/0111163v1) (2001). ▶ tab. 4.1, p. 84 [Back]

## Exhibit 17

### 1. Strange cluster production at RHIC and LHC

It is often speculated [1–3] that strange quark matter could be produced in heavy-ion collisions via two different scenarios: by coalescence of hyperons and nucleons in a hadronic medium [4] or by a strangeness distillation process [5] in a quark gluon plasma (QGP). The latter mechanism requires in principle a large baryonic chemical potential ( $\mu_B$ ). But the mid-rapidity region covered by the central barrel of STAR or ALICE does not, *a priori*, offer such conditions. Nevertheless, the first measurements at RHIC show that the free net baryon regime is still not reached. Moreover, some calculations [6] indicate that, even at LHC where  $\mu_B$  is expected to be almost zero, there might be non-negligible fluctuations of  $\mu_B$  between different rapidity bins in the central region. Hence distillation could take place locally.

Beside this possible hindrance, we have to consider that the overall conditions for QGP formation and existence should be better at RHIC and even more at LHC than at all other accelerators. Consequently, if a strangelet really needs a QGP to be created, its production probability could be enhanced at the new colliders.

Coming back to the first scenario, relativistic heavy-ion collisions provide a prolific source of hyperons which could, together with nucleons, coalesce during the later stage of the reaction and form MEMO's or purely hyperonic clusters, creating a doorway state to strangelets. For example, a dilambda could be formed by the coalescence of two  $\Lambda$ 's and transform to a  $H$ -dibaryon.

[28] J.P. Coffin, C. Kuhn, B. Hippolyte, J. Baudot and I. Belikov, 'Multi-strange-quark states at ultra-relativistic heavy-ion collisions', *Pramana* **60**(5) (2003) 1055-1058, <<http://www.ias.ac.in/pramana/v60/p1055/fulltext.pdf>>, doi: [10.1007/BF02707030](https://doi.org/10.1007/BF02707030). ▶ p. [1055](#) [[Back](#)]

---

## Exhibit 18

RHIC strongly supports explosive production scenarios, in which, for instance, collective-flow gradients increase with center-of-mass energy [26]. The short lifetime of the produced systems (of the order of 10 fm/c) is not expected to allow for an evaporation process. Moreover, the explosive collective dynamics is expected to favor bulk emission rather than surface emission [26]. So, there is no evidence for a distillation mechanism capable of strangelet production at RHIC, and this suggestion for strange particle production has been abandoned for the LHC.

[4] J. Ellis, G. Giudice, M.L. Mangano, I. Tkachev and U. Wiedemann (LHC Safety Assessment Group), 'Review of the safety of LHC Collisions', *J. Phys.* **G35**(11) (2008) id. 115004 (18pp.), doi: [10.1088/0954-3899/35/11/115004](https://doi.org/10.1088/0954-3899/35/11/115004); arXiv: [0806.3414v2](https://arxiv.org/abs/0806.3414v2) [hep-ph] 18 Sep 2008. ▶ p. [19](#) [[Back](#)]

## Exhibit 19

The possibility that fluctuations in normal air showers mimic Centauro-like exotic events has been studied and excluded by many authors. It is believed that Centauro-related phenomena cannot be due to any kind of statistical fluctuations in the hadronic content of normal events and/or in the development of nuclear-electromagnetic showers. Although many unconventional models have been proposed to explain these phenomena, their interpretation still remains an open question. The opinion that the likely mechanism for Centauro production is the formation of a quark-gluon plasma has been incorporated in many proposed models. New ideas are based on the DCC (Disoriented Chiral Condensate) [8] mechanism or the evaporation of mini-black holes [9]. Most of the models are not able to explain simultaneously all features of the Centauro-like events and they are mainly concentrated on the interpretation of the basic Centauro anomaly, i.e. the extreme hadron-rich composition. The exceptions are strange quark matter (SQM) based scenarios, which give the possibility of a simultaneous explanation of both the hadron-rich composition and the unusual features of the strongly penetrating component. According to the SQM fireball model [10, 11], Centauro arises through the hadronization of a QGP fireball of high baryochemical potential, produced in the forward direction in nucleus-nucleus collisions. Strangelet formation via a mechanism of strangeness distillation is possible and the hypothesis that strangelets can be identified as the strongly penetrating particles

[18] E. Norbeck, Y. Onel, E. Gładysz-Dziaduś, A.D. Panagiotou and P. Katsas, ‘Exotic Physics at the LHC with CASTOR in CMS’, CMS Conference Report 2007/013, *Int. J. Mod. Phys. E* **16**(7-8) (2007) 2451-2456, doi: [10.1142/S0218301307008082](https://doi.org/10.1142/S0218301307008082), [http://cms.cern.ch/iCMS/jsp/openfile.jsp?type=CR&year=2007&files=CR2007\\_013.pdf](http://cms.cern.ch/iCMS/jsp/openfile.jsp?type=CR&year=2007&files=CR2007_013.pdf). ▶ pp. 2-3 [Back]

## Exhibit 20

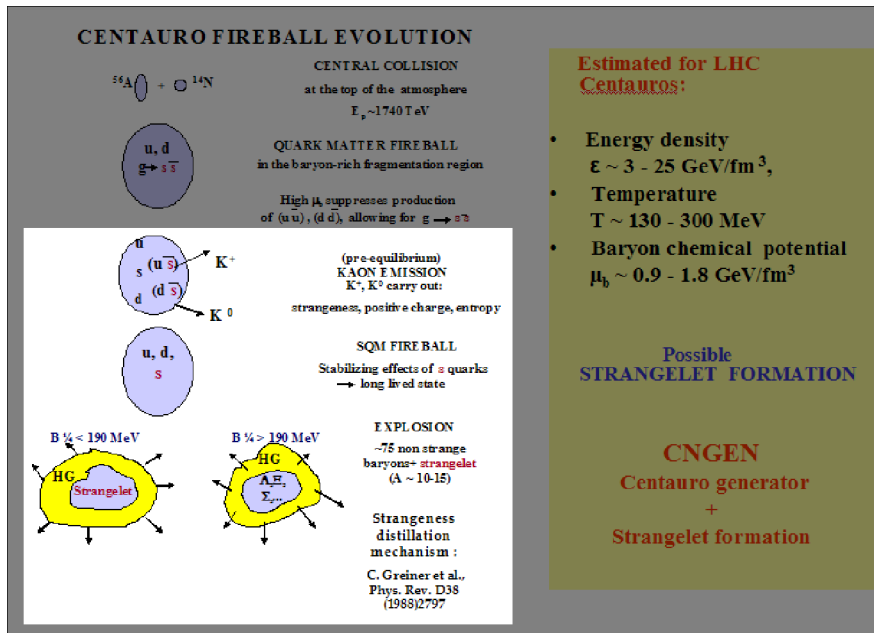

[20] P. Katsas, ‘Strangelet hunt at CMS’ [slides], QCD at Cosmic Energies II Workshop, Skopelos, Greece, 25 Sep - 1 Oct 2005, [http://cmsdoc.cern.ch/cms/castor/html/files/Strangelets\\_hunt\\_v3.ppt](http://cmsdoc.cern.ch/cms/castor/html/files/Strangelets_hunt_v3.ppt) or 2nd to last transparency from: <http://indico.cern.ch/event/a056703>. ▶ slide 14 [Back]

## Exhibit 21

Commenting the statement from [6], “The models involving strangelets ... depend, in addition, on *ad hoc* assumptions about properties of hypothetical strange matter (both its formation and decay)”, we would like to explain the following points:

- *The signal produced in the thick emulsion chamber/calorimeter by the strangelet passage through the apparatus does not depend on the mechanism of a strangelet formation.*

It does not matter, if the strangelet is produced via strangeness distillation, coalescence mechanism, or in other quite different process. The single strangelets born by any mechanism will give the same signals in the detector.

It is true that different patterns can be obtained if the strangelet formation is accompanied by production of other species. However, the conclusion from our studies is that both the strangelets born among other conventionally produced particles and the strangelets produced via the Centauro fireball decay give the signals quite different from usual events and resembling the experimentally found cascades, strongly penetrating through the apparatus. In the papers [2, 37] we have shown the sim-

[30] E. Gładysz-Dziaduś, ‘Black Holes versus Strange Quark Matter’, arXiv: [hep-ph/0405115v3](https://arxiv.org/abs/hep-ph/0405115v3) (2005). ▶ p. 10 [Back]

---

## Exhibit 22

### 1. Strange cluster production at RHIC and LHC

It is often speculated [1–3] that strange quark matter could be produced in heavy-ion collisions via two different scenarios: by coalescence of hyperons and nucleons in a hadronic medium [4] or by a strangeness distillation process [5] in a quark gluon plasma (QGP). The latter mechanism requires in principle a large baryonic chemical potential ( $\mu_B$ ). But the mid-rapidity region covered by the central barrel of STAR or ALICE does not, *a priori*, offer such conditions. Nevertheless, the first measurements at RHIC show that the free net baryon regime is still not reached. Moreover, some calculations [6] indicate that, even at LHC where  $\mu_B$  is expected to be almost zero, there might be non-negligible fluctuations of  $\mu_B$  between different rapidity bins in the central region. Hence distillation could take place locally.

Beside this possible hindrance, we have to consider that the overall conditions for QGP formation and existence should be better at RHIC and even more at LHC than at all other accelerators. Consequently, if a strangelet really needs a QGP to be created, its production probability could be enhanced at the new colliders.

[28] J.P. Coffin, C. Kuhn, B. Hippolyte, J. Baudot and I. Belikov, ‘Multi-strange-quark states at ultra-relativistic heavy-ion collisions’, *Pramana* **60**(5) (2003) 1055-1058, <<http://www.ias.ac.in/pramana/v60/p1055/fulltext.pdf>>, doi: [10.1007/BF02707030](https://doi.org/10.1007/BF02707030). ▶ p. 1055 [Back]

## Exhibit 23

rameters covered here. High initial entropies per baryon require more time for kaon and pion evaporation in order to end up finally in the same configuration of (meta)stable strange quark matter, if this is indeed a metastable state at zero temperature.

In conclusion, we have shown that large local net-baryon and net-strangeness fluctuations as well as a small but finite amount of stopping can occur at RHIC and LHC. This can provide suitable initial conditions for the possible creation of strange matter in colliders. A phase transition (e.g., a chiral one) can further increase the strange matter formation probability. The formation of exotic multistrange objects may proceed as strangelet distillation out of a QGP droplet or as clustering of (anti)hyperons.

In a simple dynamic model the hadronization of QGP results in the formation of strangelets even for  $S/A^{\text{init}} \approx$

[26] C. Spieles, L. Gerland, H. Stöcker, C. Greiner, C. Kuhn and J.P. Coffin, ‘Creation of Strange Matter at Low Initial  $\mu/T$ ’, *Phys. Rev. Lett.* **76**(11) (1996) 1776–1779, doi: [10.1103/PhysRevLett.76.1776](https://doi.org/10.1103/PhysRevLett.76.1776). ▶ p. 1779 (no link) [[Back](#)]

---

## Exhibit 24

smaller than 10. In this very hypothetical case, such a strangelet would be stable. It has been further speculated that, if produced, strangelets could coalesce with normal matter and catalyze its conversion into strange matter, thereby creating an ever-growing strangelet. This hypothetical scenario underlies concerns about strangelet production at accelerators, which were discussed previously in [8] and [1].

It is generally expected that any stable strangelet would have a positive charge, in which case it would be repelled by ordinary nuclear matter, and hence unable to convert it into strange matter [8], see [12], however. In some model studies, one finds that negatively-charged strangelets can also exist, but are unstable since the positively-charged states have lower energy [13]. However, there is no rigorous proof that the charge of a stable strangelet must be positive, nor that a negatively-charged strangelet cannot be metastable, i.e., very long-lived. So, one should also consider the possibility of a negatively-charged stable or very long-lived strangelet.

[4] J. Ellis, G. Giudice, M.L. Mangano, I. Tkachev and U. Wiedemann (LHC Safety Assessment Group), ‘Review of the safety of LHC Collisions’, *J. Phys.* **G35**(11) (2008) id. 115004 (18pp.), doi: [10.1088/0954-3899/35/11/115004](https://doi.org/10.1088/0954-3899/35/11/115004); arXiv: [0806.3414v2](https://arxiv.org/abs/0806.3414v2) [hep-ph] 18 Sep 2008. ▶ p. 9 [[Back](#)]

## Exhibit 25

5. *If stable strangelets exist, they are most likely positively charged. If strange matter contained equal numbers of  $u$ ,  $d$  and  $s$  quarks, it would be electrically neutral. Since,  $s$  quarks are heavier, Fermi gas kinematics alone indicates that strange quarks are suppressed, giving strange matter a positive charge per unit baryon number. However, the effects of gluon exchange reactions are difficult to quantify. Perturbatively, gluon exchange is repulsive and increases the mass. But gluon interactions weaken as quark masses are increased, so the gluonic repulsion is smaller between  $s$ - $s$ ,  $s$ - $u$  or  $s$ - $d$  pairs than between  $u$  and  $d$  quarks. Hence, increasing the strength of gluon interactions makes the charge of quark matter negative, but it also unbinds it.*

Unreasonably low values of the bag constant are necessary to compensate for a large repulsive gluonic interaction energy, which is why negatively-charged strangelets are regarded as extremely unlikely [8].

[4] J. Ellis, G. Giudice, M.L. Mangano, I. Tkachev and U. Wiedemann (LHC Safety Assessment Group), ‘Review of the safety of LHC Collisions’, *J. Phys. G* **35**(11) (2008) id. 115004 (18pp.), doi: [10.1088/0954-3899/35/11/115004](https://doi.org/10.1088/0954-3899/35/11/115004); arXiv: [0806.3414v2](https://arxiv.org/abs/0806.3414v2) [hep-ph] 18 Sep 2008. ▶ p. 15 [Back]

## Exhibit 26

<i>Centauro</i>	<i>Cosmic Rays</i>	<i>LHC</i>
<i>Interaction</i>	${}^A\text{Fe} + N$	$Pb + Pb$
$\sqrt{s}$	$\geq 6.76$ TeV	5.5 A TeV
<i>Fireball mass</i>	$\geq 180$ GeV	$\sim 500$ GeV
$y_{proj}$	$\geq 11$	8.67
$\gamma$	$\geq 10^4$	$\simeq 300$
$\eta_{cent}$	9.9	$\sim 5-7$
$\langle p_T \rangle$	1.75 GeV	1.75 GeV (*)
<i>Life - time</i>	$10^{-9}$ s	$10^{-9}$ s (*)
<i>Decay prob.</i>	10% ( $x \geq 10$ km)	1% ( $x \leq 1$ m)
<i>Strangeness</i>	14	60-80
$f_s(S/A)$	$\simeq 0.2$	$\sim 0.1-0.4$
$Z/A$	$\simeq 0.4$	$\sim 0.3-0.45$
<i>Event rate</i>	$\geq 1$ %	$\simeq 1000/\text{ALICE-year}$

<i>"Strangelet"</i>	<i>Cosmic Rays</i>	<i>LHC</i>
<i>Mass</i>	$\simeq 7-15$ GeV	10-80 GeV
$Z$	$\leq 0$	$\leq 0$
$f_s$	$\simeq 1$	$\simeq 1$
$\eta_{str}$	$\eta_{Cent} + 1.2$	$\eta_{Cent} + 1.2$

(\*) assumed

[23] E. Gładysz-Dziaduś, ‘Are Centauros exotic signals of the QGP?’, *Phys. Part. Nucl.* **34** (2001) 285-347; see also *Fiz. Elem. Chast. Atom. Yadra* **34** (2003) 565-678; arXiv: [hep-ph/0111163v1](https://arxiv.org/abs/hep-ph/0111163v1) (2001). ▶ tab. 6.3, p. 112 [Back]

## Exhibit 27

Table 1. Average characteristic quantities of Centauro events and Strangelets produced in Cosmic Rays and expected at the LHC.

Centauro	Cosmic Rays	LHC
Interaction	"Fe + N"	Pb + Pb
$\sqrt{s}$	$\gtrsim 6.76$ TeV	5.5 TeV
Fireball mass	$\gtrsim 180$ GeV	$\sim 500$ GeV
$y_{proj}$	$\geq 11$	8.67
$\gamma$	$\geq 10^4$	$\simeq 300$
$\eta_{cent}$	9.9	$\simeq 5.6$
$\Delta\eta_{cent}$	1	$\simeq 0.8$
$\langle p_T \rangle$	1.75 GeV	1.75 GeV (*)
Life-time	$10^{-9}$ s	$10^{-9}$ s (*)
Decay prob.	10 % ( $x \geq 10$ km)	1 % ( $x \leq 1$ m)
Strangeness	14	60 - 80
$f_s$ (S/A)	$\simeq 0.2$	0.30 - 0.45
Z/A	$\simeq 0.4$	$\simeq 0.3$
Event rate	$\gtrsim 1$ %	$\simeq 1000$ /ALICE-year
"Strangelet"	Cosmic Rays	LHC
Mass	$\simeq 7 - 15$ GeV	10 - 80 GeV
Z	$\lesssim 0$	$\lesssim 0$
$f_s$	$\simeq 1$	$\simeq 1$
$\eta_{str}$	$\eta_{cent} + 1.2$	$\eta_{cent} + 1.6$

(\*) assumed

[31] A.L.S. Angelis, J. Bartke, M.Yu. Bogolyubsky, S.N. Filippov, E. Gładysz-Dziaduś, Yu.V. Kharlov, A.B. Kurepin, A.I. Maevskaya, G. Mavromanolakis, A.D. Panagiotou, S.A. Sadovsky, P. Stefanski and Z. Włodarczyk, 'CASTOR: A Forward Detector for the Identification of Centauros and Strangelets in Nucleus-Nucleus Collisions at the LHC', arXiv: [hep-ex/9901038v1](https://arxiv.org/abs/hep-ex/9901038v1) (1999). Also: A.L.S. Angelis *et al.*, 'Formation and identification of centauro and strangelets in nucleus-nucleus collisions at the LHC', *Nucl. Phys. B (Proc. Suppl.)* 75(1-2) (1999) 203-205, doi: [10.1016/S0920-5632\(99\)00243-1](https://doi.org/10.1016/S0920-5632(99)00243-1); also: Proc. Int. Symp. on Multiparticle Dynamics, Delphi, 6-11 Sep. 1998. ▶ tab. 1, p. 3 [Back]



## Exhibit 28

Many authors investigated conditions for SQM stability (see for example [112, 113, 114]). The practical measure of stability of a strangelet is provided by the so called separation energy  $dE/dA$ , i.e. the energy which is required to remove a single baryon from a strangelet. If  $dE/dA > m_N$  then strangelet can evaporate neutrons from its surface. Contrary to normal nuclei, SQM stability increases with  $A$  and the threshold of its stability is close to  $A_{crit} \sim 300$ . Some calculations, based on QCD and the phenomenological bag model [114, 115] (up to the baryon number  $A = 40$ ) suggest that strange quark matter may be metastable or even completely stable for a wide range of bag model parameters values ( $B^{1/4} \sim 150-170$  MeV). Generally, for higher bag parameter values there are less

long-lived strangelets and they are shifted towards higher values of baryon number  $A$ , strangeness factor  $f_s$  and towards higher negative charges. There are also predictions that quite small strangelets might gain stability due to shell effects [116, 117]. They are called “magic strangelets”. However, due to the lack of theoretical constraints on bag model parameters and difficulties in calculating colour magnetic interactions and finite size effects, experiments are necessary to help answer the question of the stability of strangelets. The properties of some forms of hypothetical strange matter, as small lumps of strange quark matter (strangelets) or hyperon matter (metastable multihypernuclear objects MEMO’s) have been discussed by many authors (see for example [113, 114, 115, 118]) with special emphasis on their relevance to the present and future heavy ion experiments. Different aspects of strange quark matter physics are described in the recent reviews [16, 119, 120].

[23] E. Gładysz-Dziaduś, ‘Are Centauros exotic signals of the QGP?’, *Phys. Part. Nucl.* **34** (2001) 285-347; arXiv: [hep-ph/0111163v1](https://arxiv.org/abs/hep-ph/0111163v1) (2001). ▶ pp. [76-77](#) [[Back](#)]

## Exhibit 29

In order to assess the capability of the experiment to recognize less conventional or unusual signals, we have investigated sensitivity to strangelet production. A similar analysis could be done for other hypothetical objects like 'free quarks' ( $Z = 1/3$  or  $2/3$ ) or magnetic monopoles.

In heavy-ion reactions strangelets and MEMOs might be found in the final state as objects with baryon number  $A \approx 2-40$ ,  $Z/A$  ratio ranging from  $\sim -0.5$  up to  $+0.5$ , and fraction of strangeness within  $f_s \approx 0.5-1.5$ . Strangelets should be created preferentially in a region with large net baryon density. The phase space covered by ALICE ( $-0.9 \leq \eta \leq 0.9$ ) is characterized by a low net baryon density and a chemical potential  $\mu_B \approx 0$ , thus conditions not favourable for strangelet formation (as opposed to strangelet production at large rapidities [98]). Recent theoretical developments [97] suggest, however, that strangelets could be produced also at the LHC as a result of local fluctuations in the net baryon number<sup>12</sup>.

[25] ALICE Technical Proposal for A Large Ion Collider Experiment at the CERN LHC Document code: CERN /LHCC / 95-71 LHCC / P3, (1995),. Chapter 11 'Physics performance', Chapter 13 'Planning and organization': 13.4 'Organization'. ▶ p. [189](#) [[Back](#)]

---

## Exhibit 30

assumptions. As reviewed in detail in ref. [8], theoretical speculations about the existence of strangelets may be summarized as follows:

1. *It is unclear whether bulk strange quark matter exists at all.*
2. *It is unclear whether bulk strange quark matter can be stable. If it does exist, strange quark matter may be absolutely stable in bulk at zero external pressure, though the expected values for the relevant parameters tend to disfavour stability [1].*
3. *Finite size effects make it very unlikely that small strangelets ( $A < 10$ ) can be stable or long-lived. Even if bulk strange quark matter is stable, finite-size effects (surface tension and curvature) significantly destabilize strangelets with low baryon number. For typical parameters, it has been estimated that finite-size effects add, e.g., 50 MeV per baryon for  $A = 20$  and 85 MeV per baryon for  $A=10$  [1].*

[4] J. Ellis, G. Giudice, M.L. Mangano, I. Tkachev and U. Wiedemann (LHC Safety Assessment Group), 'Review of the safety of LHC Collisions', *J. Phys.* **G35**(11) (2008) id. 115004 (18pp.), doi: [10.1088/0954-3899/35/11/115004](https://doi.org/10.1088/0954-3899/35/11/115004); arXiv: [0806.3414v2](https://arxiv.org/abs/0806.3414v2) [hep-ph] 18 Sep 2008. ▶ p. [14](#) [[Back](#)]

## Exhibit 31

long-lived strangelets and they are shifted towards higher values of baryon number  $A$ , strangeness factor  $f_s$  and towards higher negative charges. There are also predictions that quite small strangelets might gain stability due to shell effects [116, 117]. They are called “magic strangelets”. However, due to the lack of theoretical constraints on bag model parameters and difficulties in calculating colour magnetic interactions and finite size effects, experiments are necessary to help answer the question of the stability of strangelets. The properties of some forms of hypothetical strange matter, as small lumps of strange quark matter (strangelets) or hyperon matter (metastable multihypernuclear objects MEMO’s) have been discussed by many authors (see for example [113, 114, 115, 118]) with special emphasis on their relevance to the present and future heavy ion experiments. Different aspects of strange quark matter physics are described in the recent reviews [16, 119, 120].

[23] E. Gładysz-Dziaduś, ‘Are Centauros exotic signals of the QGP?’, *Phys. Part. Nucl.* **34** (2001) 285-347; arXiv: [hep-ph/0111163v1](https://arxiv.org/abs/hep-ph/0111163v1) (2001). ▶ p. 77 [[Back](#)]

---

## Exhibit 32

In a simple dynamic model the hadronization of QGP results in the formation of strangelets even for  $S/A^{\text{init}} \approx 500$  and  $A_B^{\text{init}} \approx 30$ . The distillation of very small strangelets of  $A_B \leq 10$  (see Table I) cannot be excluded for the midrapidity region at colliders. However, finite size effects of describing small strangelets neglected here might become crucial [20]. Be also reminded that the question of whether strangelets or MEMO’s can exist as bound states at all is very speculative and thus still a controversial point, on which we did not focus in this Letter. Special (meta)stable candidates for experimental searches are the quark alpha [21] with  $A_B = 6$  and the H dibaryon with  $A_B = 2$  [22].

This work was supported by the Gesellschaft für Schwerionenforschung, Darmstadt, Germany, the Bundesministerium für Forschung und Technologie, Bonn.

[26] C. Spieles, L. Gerland, H. Stöcker, C. Greiner, C. Kuhn and J.P. Coffin, ‘Creation of Strange Matter at Low Initial  $\mu/T$ ’, *Phys. Rev. Lett.* **76**(11) (1996) 1776–1779, doi: [10.1103/PhysRevLett.76.1776](https://doi.org/10.1103/PhysRevLett.76.1776). ▶ p. 1779 (no link) [[Back](#)]

## Exhibit 33

### 2.2. The H-dibaryon

According to early predictions [6, 7], a six-quark-bag bound state, the strangelet (uuddss), may exist because the colour-magnetic forces are attractive and thus allow the groundstate of this configuration to be below the strong decay threshold ( $M_{\Lambda\Lambda} = 2231$  MeV). This doubly strange flavour-singlet object with hypercharge ( $Y$ ) = 0 (its quantum numbers are charge, spin, isospin zero and  $S = -2$ ) is named H-dibaryon ( $H^0$ ). Its stability against strong decay has been confirmed within the framework of the skyrmion picture and in lattice gauge theory. It was also predicted that it should not be stable against weak hadronic decay. There is a mass range, below 2055 MeV (the mass of a  $\Lambda$  and a neutron), where it could only decay by a doubly weak decay into two neutrons. This is a  $\Delta S = 2$  reaction and leads to a predicted lifetime of the order of days. But these small masses are considered as unrealistic. The most

[29] C. Kuhn, B. Hippolyte, J.P. Coffin, J. Baudot, I. Belikov, D. Dietrich, M. Germain and C. Suire, ‘Search for strange dibaryons in STAR and ALICE’, *J. Phys.* **G28**(7) (2002) 1707-1714, doi: [10.1088/0954-3899/28/7/323](https://doi.org/10.1088/0954-3899/28/7/323). ▶ p. 1708 (no link) [[Back](#)]

## Exhibit 34

Recent theoretical developments [97] suggest, however, that strangelets could be produced also at the LHC as a result of local fluctuations in the net baryon number<sup>12</sup>.

Strangelets and MEMOs could be stable or metastable objects, and their stability, lifetime, and decay modes are strongly parameter dependent [96].

Strangelets (S) may be

- i) unstable ( $\tau < 10^{-20}$  s), in which case they decay via hyperon emission ( $\Lambda$ ,  $\Sigma$ ,  $\Xi$ ) and meso-nucleonic strong interaction processes [96]:

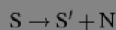
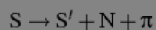

- ii) metastable ( $\tau < 10^{-4}$  s), in which case they decay via weak interaction processes:

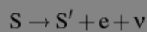
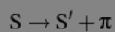
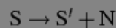

- iii) stable ( $\tau > 10^{-4}$  s),

<sup>12</sup> As the average baryon and strangeness density at midrapidity is zero, strangelets and *anti*-strangelets would be produced in equal numbers.

[25] ALICE Technical Proposal for A Large Ion Collider Experiment at the CERN LHC Document code: CERN /LHCC / 95–71 LHCC / P3, (1995),. Chapter 11 ‘Physics performance’, Chapter 13 ‘Planning and organization’: 13.4 ‘Organization’. ▶ p. [189](#) [[Back](#)]

## Exhibit 35

### Stable or long-lived strangelets

In general, strangelets will have some non-integer value for the charge-to-mass ratio and can therefore be identified via  $dE/dx$  and/or time of flight (TOF) versus momentum per charge ( $p/Z$ ). As an example, we consider strangelets with  $Z = 1$  and  $Z = 2$  and a mass between 6 and 15 GeV (i.e.  $|Z/A| < 0.3$ ). This mass range is of particular interest as lower mass strangelets are less stable (see Ref. 96) while heavier objects have lower production cross-section.

[25] ALICE Technical Proposal for A Large Ion Collider Experiment at the CERN LHC Document code: CERN /LHCC / 95–71 LHCC / P3, (1995),. Chapter 11 ‘Physics performance’, Chapter 13 ‘Planning and organization’: 13.4 ‘Organization’. ▶ p. [190](#) [[Back](#)]

---

## Exhibit 36

[1]. We revisit here this topic in light of recent advances in our understanding of the theory and experiment of heavy-ion collisions. These enable us to update and strengthen the previous conclusions about hypothetical scenarios based on strangelet production. More details of our considerations on strangelet production at the LHC are given in the appendix.

The 2003 report summarized the status of direct experimental searches and of theoretical speculations about hypothetical strangelet production mechanisms [1]. More recently, additional direct upper limits on strangelet production have been provided by experimental searches at RHIC [15] and among cosmic rays [16], which have not yielded any evidence for the existence of strangelets. In the near future, additional experimental information may be expected from strangelet searches in samples of lunar soil and from particle detectors in outer space [17].

[4] J. Ellis, G. Giudice, M.L. Mangano, I. Tkachev and U. Wiedemann (LHC Safety Assessment Group), ‘Review of the safety of LHC Collisions’, *J. Phys.* **G35**(11) (2008) id. 115004 (18pp.), doi: [10.1088/0954-3899/35/11/115004](https://doi.org/10.1088/0954-3899/35/11/115004); arXiv: [0806.3414v2](https://arxiv.org/abs/0806.3414v2) [hep-ph] 18 Sep 2008. ▶ p. [9](#) [[Back](#)]

## Exhibit 37

has been checked by simulations [11]. The simulations show that transition curves, produced by strangelets during their passage through the chamber, resemble the experimentally detected long many-maxima cascades. The new results obtained in remeasurement of the Centauro I also support the SQM scenario [12]. Different models proposed to explain Centauro-related phenomena are described and discussed in [7, 13].

The SQM, initially proposed by E. Witten, has been the subject of many recent theoretical works. Its existence could have strong cosmological consequences because it is a candidate for dark matter and because the appearance of events above the GZK energy threshold could be explained by assuming the presence of strangelets in the primary cosmic ray spectrum.

[18] E. Norbeck, Y. Onel, E. Gładysz-Dziaduś, A.D. Panagiotou and P. Katsas, ‘Exotic Physics at the LHC with CASTOR in CMS’, CMS Conference Report 2007/013, *Int. J. Mod. Phys. E* **16**(7-8) (2007) 2451-2456, doi: [10.1142/S0218301307008082](https://doi.org/10.1142/S0218301307008082), <[http://cms.cern.ch/iCMS/jsp/openfile.jsp?type=CR&year=2007&files=CR2007\\_013.pdf](http://cms.cern.ch/iCMS/jsp/openfile.jsp?type=CR&year=2007&files=CR2007_013.pdf)>. ▶ p. 3 [Back]

---

## Exhibit 38

It is important to note that all proposed pictures of the strangelet penetration through the matter and its successive destruction in the consecutive collision acts should be connected with the observation of the large cloud of the low energy nucleons from the destroyed target nuclei. Interesting, the extremely long delay ( $> 0.5$  msec) neutrons have been recently observed [123] in large Extensive Air Showers ( $N_e > 10^6$ ) by the neutron monitor working in conjunction with EAS instalation “Hadron”. This phenomenon appears at primary energies higher than  $3 \times 10^{15}$  eV and it is observed close to the EAS axis. As the tentative explanation of this phenomenon one can propose the arrival of a new type of primary cosmic ray particles, like strangelets, with gradual dispersion of their energy along the whole atmosphere.

Also muon bundles of extremely high multiplicity observed by ALEPH detector (in the dedicated cosmic-ray run) could originate from strangelets collisions with the atmosphere [124].

The old experimental results are also worth to recalling. Anomalous massive ( $A=75\dots 1000$ ) and relatively low charged objects ( $Z=14\dots 46$ ), which could be interpreted as strangelets, have been observed. These are :

- Two anomalous events, with charge  $Z \simeq 14$  and mass number  $A \simeq 350$  and  $\simeq 450$  (what can be consistent with theoretical estimate for  $Z/A$  ratio for SQM), observed

[23] E. Gładysz-Dziaduś, ‘Are Centauros exotic signals of the QGP?’, *Phys. Part. Nucl.* **34** (2001) 285-347; arXiv: [hep-ph/0111163v1](https://arxiv.org/abs/hep-ph/0111163v1) (2001). ▶ p. 79 [Back 38]

## Exhibit 39

It has been shown that the continuing survival of the Moon under cosmic-ray bombardment ensures that heavy-ion collisions do not pose any conceivable threat via strangelet production [8]. This is because cosmic rays have a significant component of heavy ions, as does the surface of the Moon. Since the Moon, unlike planets such as the Earth, is not protected by an atmosphere, cosmic rays hitting the Moon have produced heavy-ion collisions over billions of years at energies that are comparable to or exceed those reached in man-made experiments.

[4] J. Ellis, G. Giudice, M.L. Mangano, I. Tkachev and U. Wiedemann (LHC Safety Assessment Group), ‘Review of the safety of LHC Collisions’, *J. Phys.* **G35**(11) (2008) id. 115004 (18pp.), doi: [10.1088/0954-3899/35/11/115004](https://doi.org/10.1088/0954-3899/35/11/115004); arXiv: [0806.3414v2](https://arxiv.org/abs/0806.3414v2) [hep-ph] 18 Sep 2008. ▶ p. 12 [Back]

---

## Exhibit 40

### Exotic Physics at the LHC with CASTOR in CMS

E. Norbeck and Y. Onel

*Department of Physics and Astronomy, The University of Iowa, 203 Van Allen Hall, Iowa City IA, 52242, USA*

E. Gładysz-Dziaduś

*Institute of Nuclear Physics, Krakow, Poland*

A. D. Panagiotou and P. Katsas

*University of Athens, Athens, Greece*

(for the CMS Collaboration)

#### Abstract

Cosmic-rays sometimes produce showers of unusual composition that contain particles with energy-loss profiles different from all known particles. The Large Hadron Collider (LHC) will produce, for the first time, nuclear collisions at the extremely high energy characteristic of the cosmic-ray events. The CASTOR detector, a part of the huge CMS experiment, is designed for detailed studies of the products corresponding to the cores of cosmic-ray showers. It will cover angles of  $0.1^\circ$  to  $0.7^\circ$  from the beam. It will be divided azimuthally into 16 segments and longitudinally into 18 segments. It is assumed that cosmic ray showers are caused by nuclei, protons through iron, hitting the atmosphere.

If CASTOR does not find events that can be identified with the anomalous cosmic-ray events, this assumption may need to be reconsidered. Pb-Pb collisions with the LHC will have an energy 28 times that of Au-Au collisions studied at RHIC. With this huge increase in energy a wealth of new phenomena is almost assured. Because of the much larger mass number, Pb-Pb events can be expected to show exotic phenomena that is beyond the reach of cosmic rays.

[18] E. Norbeck, Y. Onel, E. Gładysz-Dziaduś, A.D. Panagiotou and P. Katsas, ‘Exotic Physics at the LHC with CASTOR in CMS’, CMS Conference Report 2007/013, *Int. J. Mod. Phys.* **E16**(7-8) (2007) 2451-2456, doi: [10.1142/S0218301307008082](https://doi.org/10.1142/S0218301307008082), <[http://cms.cern.ch/iCMS/jsp/openfile.jsp?type=CR&year=2007&files=CR2007\\_013.pdf](http://cms.cern.ch/iCMS/jsp/openfile.jsp?type=CR&year=2007&files=CR2007_013.pdf)>. ▶ p. 1 [Back]

## Exhibit 41

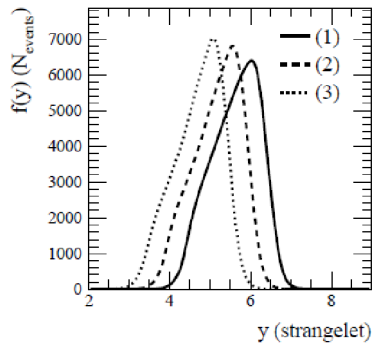

FIG. 9: Rapidity distribution of strangelets formed in the decay of Centauro fireballs produced in  $\sqrt{s} = 5.5 \times A$  TeV  $Pb + Pb$  collisions for  $\Delta y_{fb} = 2.0$  (1), 2.5 (2) and 3.0 (3).

[36] S.A. Sadovsky, Yu. V. Kharlov, A.L.S. Angelis, E. Gładysz-Dziaduś, V.L. Korotkikh, G. Mavromanolakis and A.D. Panagiotou, ‘Model for describing the production of Centauro events and strangelets in heavy-ion collisions’, *Phys. At. Nucl.* **67**(2) (2004) 396-405, doi: [10.1134/1.1648929](https://doi.org/10.1134/1.1648929); arXiv: [nucl-th/0301003v1](https://arxiv.org/abs/nucl-th/0301003v1) (2003). ▶ fig. 9, p. 13 [[Back to text](#)] [[Back to notes](#)]