



National Aeronautics and
Space Administration

Educational Product

Educators

Grades 9–12

EG-1999-06-121-HQ

Mars Exploration

Is There Water on Mars?

An Educator's Guide With Activities for
Physical and Earth and Space Science

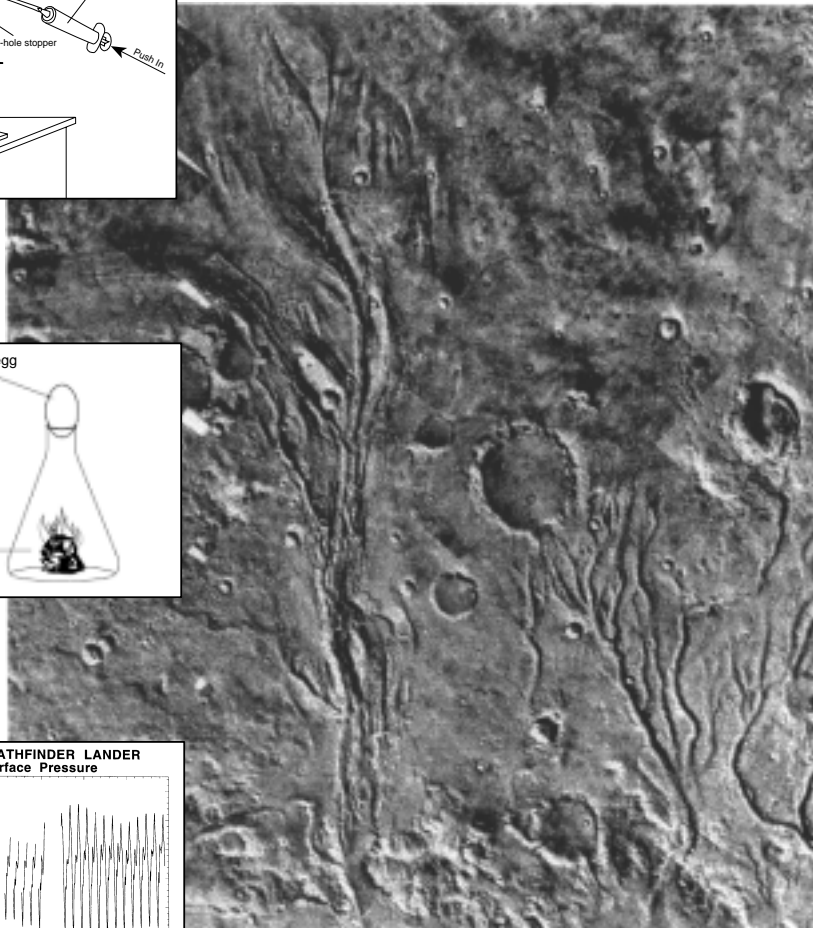
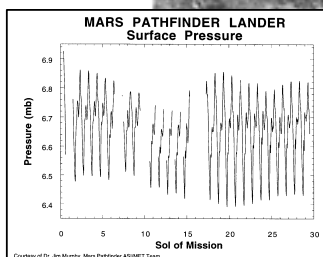
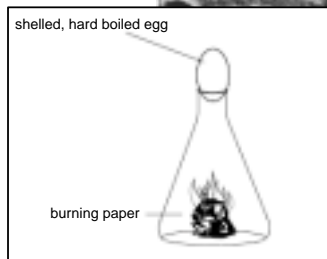
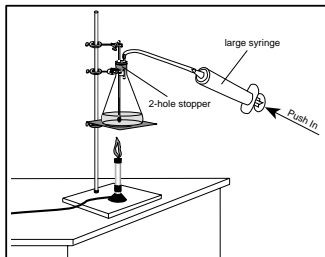



Is There Water on Mars?—An Educator's Guide With Activities for Physical and Earth and Space Science is available in electronic format through NASA Spacelink—one of the Agency's electronic resources specifically developed for use by the educational community.

This guide and other NASA educational products may be accessed at the following address:
<http://spacelink.nasa.gov/products>

Is There Water on Mars?

**An Educator's Guide With Activities
for Physical and Earth and Space Science**



NASA Aeronautics and Space Administration
Office of Human Resources and Education
Education
Washington, DC

Prepared by TERC, Inc.
2067 Massachusetts Avenue
Cambridge, Massachusetts 02140

This publication is in the Public Domain and is not protected by copyright.
Permission is not required for duplication.

EG-1999-12-121-HQ

Acknowledgments

Is There Water on Mars? An Educator's Guide With Activities for Physical and Earth and Space Science

Mars Exploration Education and Public Outreach Program

These modules were prepared by the TERC Center for Earth and Space Science Education with assistance from personnel of NASA's Mars Exploration Education and Public Outreach Program. This Program is managed for NASA by the Jet Propulsion Laboratory, a division of the California Institute of Technology.

These materials were developed for JPL's Mars Exploration Education and Public Outreach Program, which is part of NASA's Mars Exploration Program. The work is funded by NASA's Jet Propulsion Laboratory (JPL), which has overall responsibility for the Mars Exploration Program.

The curriculum materials were developed through a subcontract to the Center for Earth and Space Science Education (CESSE) at TERC, Inc., a nonprofit educational research and development company. The materials have been reviewed by NASA scientists and field-tested by scores of teachers.

Government Sponsorship is acknowledged under contract NASA7-1260.

Mars Pathfinder and **Mars Global Surveyor** are trademarks of the California Institute of Technology, Jet Propulsion Laboratory.



Welcome to the Mars Education Program



Between 1997 and 2007, NASA plans to send 10 spacecraft to investigate Mars. To take advantage of this historic set of explorations, NASA's Mars Exploration Program has created a series of curriculum modules to connect students to the excitement and learning potential of these missions. The Mars Exploration Program will help you:

- Engage your students in hands-on, inquiry-based learning
- Involve students in questions central to current Mars exploration
- Teach engineering concepts and physical, life, and Earth and space science in a relevant way
- Provide a context for learning about both Mars and Earth

- Address student misconceptions
- Prepare students for using live data and images from Mars

The module series was developed and field tested by a team of educators and scientists to make sure that it is both scientifically accurate and educationally powerful. Each module contains a set of activities that relate to an over-arching theme. The activities are sequenced so students can progress from introductory experiences to more advanced investigations and deeper understandings. The educator handbook and correlated student materials enable you and your students to do the activities regardless of your previous knowledge about Mars and planetary exploration.

Modules Available in the Mars Exploration Series



Getting Started in Mars Exploration

Grades 4–10, 2 Weeks

How can students study Mars and Mars exploration in the classroom?

This comprehensive introduction to studying Mars in the classroom develops students' understanding of Mars, the solar system, and planetary exploration. The module introduces many of the intriguing riddles posed by Mars and provides teachers a variety of ways to integrate the study of Mars into their classrooms.

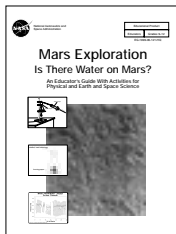

Is There Water on Mars?

Grades 9–12, 3 Weeks

Can water exist on Mars today?

By experimenting with water as it changes state and investigating some effects of air pressure, students not only learn core ideas in physical science but can deduce the water situation on Mars by applying those concepts. They use evidence from their work as well as data and images from NASA's missions to Mars to take a position on whether there was ever water on Mars.

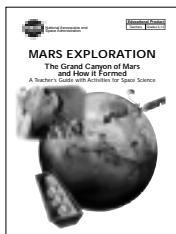

The Grand Canyon of Mars and How It Formed

Grades 6–12, 3 Weeks

What can a colossal fracture tell us about Mars?

Students investigate the formation of Mars' 3,000-mile-long rift valley. After investigating how a planet's surface can be altered and analyzing data and images from NASA's missions to Mars, students develop hypotheses to explain the rift valley's formation and amass evidence to support their ideas.

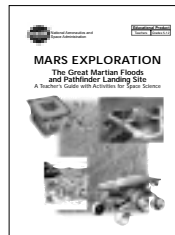

The Great Martian Floods and Pathfinder Landing Site

Grades 6–12, 3 Weeks

Is the landing site in a floodplain, and why would that be good news?

Students learn how sediment, landforms, and drainage patterns provide clues about a planet's geologic history. They use evidence from their work and data and images from NASA's missions to Mars to understand the advantages of landing at the end of a flood channel.

An Overview of What the Modules Provide

- Hands-on, inquiry-based activities written by educators, reviewed by NASA scientists, and field-tested by students
- Engaging physical and Earth science activities that use experiments, models, analogs, and image and data interpretation to investigate questions central to Mars research
- Practical applications of the National Science Standards
- Educator's guides with background information, procedures, teaching strategies, student sheets, assessment recommendations, and a resource list



Table of Contents

Is There Water on Mars? An Educator's Guide With Activities for Physical and Earth and Space Science

Module Overviewvi
An Overview of the Pedagogical Approach Used in the Moduleviii
How Do I Get Started?ix
How Is This Module Organized?x
Which Science Standards Are Supported in This Module?xii
Activity 1: How Hot Can You Make Water?1
Activity 2: How Fast Does Water Warm as Ice Melts?7
Activity 3: How Can We Increase the Height of the Plateau?13
Activity 4: Do Fish Believe in Water? Do Students Believe in Air?21
Activity 5: Testing Your Hypothesis by Boiling Water Below Its Boiling Temperature35
Activity 6: Is There Water on Mars?43
Activity 7: Where Would You Search for Water on Mars?49
Appendices	
A. Why Is Water a Priority for Mars Exploration?57
B. What Is So Special About Water?59
C. What Is Distinctive About the Module Series?61
D. The Scientific Research Techniques Used in the Modules63
E. Glossary65
F. Resources for Educators Interested in Mars67
G. Background Information on the Images in the Image Set69
H. Image Set A: 15 High-Contrast Images75
I. Image Set B: The Same 15 Images Processed So That, on a Photocopier, They Reproduce Better Than the High-Contrast Versions91



Module Overview

Is There Water on Mars? An Educator's Guide With Activities for Physical and Earth and Space Science

Module Overview

Is there liquid water on Mars? By experimenting with water as it changes state and investigating some effects of air pressure, students not only learn core ideas in physical science but can deduce the water situation on Mars by applying those concepts.

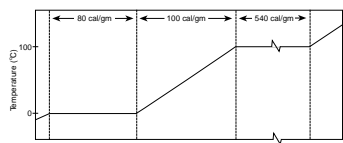

Calories added to 1 gram of water

In **Activities 1 and 2**, students discover the existence of two temperature plateaus as water changes state. Students have to make sense of these plateaus and come to grips with what changes of state mean at the molecular level. Once students understand the process of boiling and melting, they are ready to examine another factor that significantly impacts the existence of liquid water and atmospheric pressure.

Key Concepts in Activities 1 and 2

- Water can only be heated to its boiling temperature.
- The temperature of ice water can rise only after all the ice has melted.
- Temperature measures the average vibrational energy of a particle or group of particles.
- As the water in Activity 1 boiled and the ice in Activity 2 melted, the particles used the energy from the heat source to gain the extra kinetic energy required to change state. As a result, the temperature during these transitions never changed.

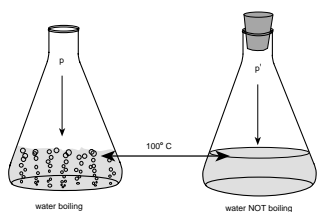

In **Activity 3**, students increase the boiling temperature of water by increasing the pressure in the container. In this activity, students not only develop an understanding of pressure's role in water's boiling temperature but also of its role in maintaining liquid water.

Key Concept in Activity 3

- Water boils when its vapor pressure equals atmospheric pressure. As a result, water's boiling temperature is pressure, rather than temperature, dependent.

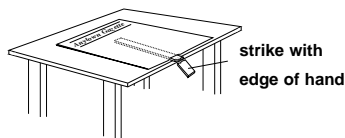

In **Activity 4**, students perform several activities showing that Earth's atmosphere exerts considerable force at the surface. Many students are unaware that they are subject to considerable atmospheric pressure and have little appreciation for how important this pressure is in their world. By acknowledging air pressure and understanding its role in maintaining water, students can consider questions such as: Why doesn't water on Earth boil away? Could water exist on planets such as Mars?

Key Concepts in Activity 4

- Air has mass and volume.
- Air pressure is a function of the height and density of the atmosphere in conjunction with a planet's gravitational pull.
- The particles in high-pressure air are packed more densely than those in low-pressure air.



- Air flows from areas of high pressure to areas of low pressure to equalize the pressures.
- When the volume of a given mass of gas increases, its pressure decreases, provided that the temperature remains constant (Boyle's Law).

In Activity 5, students build on ideas introduced earlier and discuss ways to reduce the boiling temperature of water. Students find that water can boil well below its typical boiling temperature by reducing the pressure above the surface of the liquid. They learn about phase change diagrams and use one to better understand their previous work with pressure and changes of state.

Key Concepts in Activity 5

- Water boils when its vapor pressure equals atmospheric pressure. As a result, water's boiling temperature is pressure, rather than temperature, dependent.

In Activity 6, students analyze temperature and pressure graphs from the first 30 days of the Pathfinder mission and realize that liquid water could not have existed under these conditions. Next, students look at a number of images of Mars. By interpreting the landforms and comparing a river-cut valley on Mars with Earth's Grand Canyon, they identify water as the agent that shaped the surface. They hypothesize about how water could have flowed across the Martian surface, even though current conditions make it virtually impossible for liquid water to exist.

Key Concepts in Activity 6

- Current climatic conditions make the existence of liquid water virtually impossible.
- Features on the Martian surface provide strong evidence for past flows of large amounts of water.

In Activity 7, students generate questions based on their module experiences, and they pinpoint specific information they would like to obtain. They then read about the objectives and instrument payloads of the upcoming missions and see how these missions may provide data that can help them answer their questions. Finally, students create a calendar for the missions and consider how they will access the information returned by the missions.

Key Concepts in Activity 7

- Each Mars mission has specific objectives and the instruments it needs to achieve them.
- Space missions arise out of questions people have about Mars, and students can generate questions worthy of future study.
- Every mission has a specific timetable, and students can follow the progress of each mission in a number of ways.

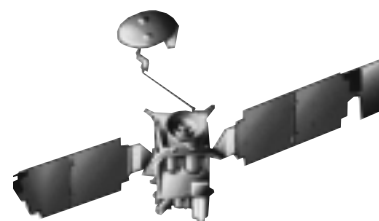
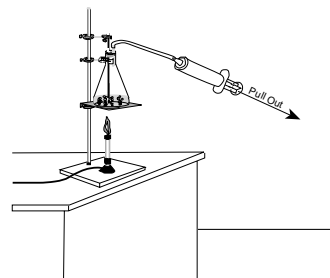

An Overview of the Pedagogical Approach Used in This Module

Mathematics and science distinguish themselves from other disciplines in that they have certain absolutes and fixed principles. Science further distinguishes itself in that most students arrive at school with their own ideas and explanations of many of these absolutes. Unfortunately, many of their ideas are at odds with current scientific understanding. The discrepancy between naive and expert understandings gives science teachers an unusual and exciting opportunity—to help students move from incomplete or incorrect explanations to ideas consistent with current understanding.

A considerable and growing body of research shows that one of the best ways to change students' thinking is to first make them aware of their preconceptions and then provide experiences that probe or challenge those preconceptions. Say that students conduct an experiment that produces an unexpected result. If their preconceived ideas cannot explain the observations, the students should be encouraged to construct new explanations. If these explanations are superior to the ones they previously held, the students are likely to change their ideas. If a student's new explanation is better than his or her old one but is still incomplete or incorrect, the educator can provide another experience and repeat the cycle until the student's understanding is consistent with current scientific understanding.

The well established methods of inquiry are not only desirable but also are absolutely necessary for students to construct ideas, test them, and, if necessary, reject them and begin again in their search for ideas that more accurately reflect the real world.

"Pathways to the Science Standards—High School Edition,"
National Science Teachers Association, 1997, p. 3

To help educators identify students' preconceptions, each activity begins with a preassessment question. These questions help students become aware of their own ideas, take

a position on a particular question, and have a personal stake in the activity. To avoid any embarrassment associated with feeling ignorant or uninformed, the students hand their answers in to the educator rather than state their ideas in a group or class discussion. At the end of each activity, the students are asked to respond to the preassessment question again and compare how they answered it before and after the activity. As the educator, you can use this comparison as:

- An assessment of student understanding
- An assessment of the effectiveness of the learning experience
- An indication of whether additional experiences are necessary to develop concept mastery
- A way to structure your class discussion of the experimental observations
- A way to document how students develop an understanding of a concept

The activities early in the module are more proscribed than those later in the module. Progressing from structured to more open-ended investigations lays an indispensable foundation for the inquiry-based learning later in the module. This "guided" approach helps students become increasingly independent investigators by:

- Assuring the mastery of a core set of concepts
- Developing skills required in scientific inquiry
- Providing students a common set of experiences to refer to as they investigate their own questions

Furthermore, the module promotes inquiry-based learning by providing students opportunities to design experiments, develop procedures, or pursue their own ideas. By the end of the module, the students will have developed the skills and understanding they need to investigate their own questions.



How Do I Get Started?

Module Overview

Is There Water on Mars? An Educator's Guide With Activities for Physical and Earth and Space Science

- As they move from areas of high pressure to areas of low pressure to equalize the pressure.
- When the volume of a given mass of gas increases, its pressure decreases, provided that the temperature remains constant (Boyle's Law).

In Activity 5, students build on ideas introduced earlier and discuss ways to reduce the boiling temperature of water. Students find that water can boil well below its typical boiling temperature by reducing the pressure above the surface of the liquid. They learn about phase change diagrams and use one to better understand their previous work with pressure and changes of state.

Key Concepts in Activity 5

- Water boils when its vapor pressure equals atmospheric pressure. As a result, water's boiling temperature is pressure, rather than temperature, dependent.

In Activity 6, students analyze temperature and pressure graphs from the first 30 days of the Phoenix mission and realize that liquid water could not have existed under these conditions. Next, students look at a number of images of Mars, by interpreting the landforms and comparing a river cut valley on Mars with Earth's Grand Canyon, they identify water as the agent that shaped the surface. This hypothesis about how water could have flowed across the Martian surface, even though current conditions make it virtually impossible for liquid water to exist.



Key Concepts in Activity 6

- Current climatic conditions make the existence of liquid water virtually impossible.
- Evidence on the Martian surface provides strong evidence for past flows of large amounts of water.

In Activity 7, students generate questions based on their module experiences, and they propose specific information they would like to obtain. They then read about the objectives and instrument payloads of the upcoming missions and see how those missions may provide data that can help them answer their questions. Finally, students create a calendar for the missions and consider how they will access the information returned by the missions.

Key Concepts in Activity 7

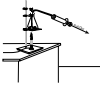
- Each Mars mission has specific objectives and the instruments it needs to achieve them.
- Space missions also raise questions people have about Mars, and students can generate questions worthy of future study.
- Every mission has a specific timetable, and students can follow the progress of each mission in a number of ways.



EG-1999-06-121-1HQ vii

Activity 1—At a Glance

Is There Water on Mars? An Educator's Guide With Activities for Physical and Earth and Space Science

How Hot Can You Make Water?

Purpose

To have students graph the temperature of water as it reaches a boil and discover the existence of the transition plateau.

Overview

Students become aware of their preconceptions by considering how hot they could heat water. They then test their preconceived ideas by heating water and measuring its temperature. At some point near 100 degrees Celsius, students find that the water temperature no longer rises. They graph the data and try to make sense of the temperature plateau.

Key Concepts

- Water can only be heated to its boiling temperature.
- The slope of a graph line in this activity shows the rate of temperature change.

Content for This Activity

Mars has such low atmospheric pressure that any water at the surface would boil away. In this activity, students investigate the process of boiling and what is involved when water changes from a liquid to a gas under everyday conditions. In Activities 3 and 5, they will take a closer look at pressure's role in maintaining liquid water.

Skills

- Predicting the outcome of an experiment
- Writing a procedure to test a prediction
- Controlling variables
- Conducting an experiment
- Collecting, recording, and graphing data
- Drawing conclusions
- Communicating explanations to others

Common Misconceptions

- Water can be heated indefinitely to very high temperatures.
- The heat source controls boiling.
- Boiling temperature plateaus means that something is malfunctioning.

Materials

Heat source, beaker or flask, water supply, thermometer, ring stand or tripod, ring clamps, thermometer clamp, stirring rod, wire gauze (flames only), graph paper, graphing, appropriate safety equipment (see pages 5 and 13).

Preparation

- Plan how to present the initial problem and the best way to develop a procedure.
- Set out the necessary equipment for each group. Attach thermometers to ring stands.
- Discuss safety procedures related to heat sources, thermometers, glassware, and hot water.

Time: 2 class periods



EG-1999-06-121-1HQ i

Finding Out What Is In a Module

To understand how the activities in the module examine a question or topic, read the overview of the science concepts starting on page vi. Each activity and its key concepts are succinctly described.

Finding Out What Is In an Activity

To understand each activity in greater detail (including material and time requirements), read the shaded "At a Glance" page at the beginning of each activity.

Materials

The "At a Glance" pages list the materials used in an activity. The activities use readily available materials.



How Is This Module Organized?

This module is written as an educator guide. This approach makes it possible to give it a conceptual and pedagogical structure while still providing educators the flexibility to tailor the activities to the needs of their classes. The educator guide prepares educators to conduct classes around core questions, and it outlines investigations that explore those questions.

Activity 1

Is There Water on Mars? An Educator's Guide With Activities for Physical and Earth and Space Science

Background

Why start a unit on Mars by boiling water? Interestingly, a lot of the boiling water seems to have boiled away, and studying boiling can help us understand why Mars has no liquid water. You should remember how water can boil when the average temperature on Mars is -60 degrees Celsius. The way to understand this apparent contradiction is to better understand boiling. Our day-to-day experiences give us a decidedly limited understanding of boiling. To better understand boiling, students need to experience the existence of the phase change plateau (Figure 1.1).

Temperature vs. Time

Figure 1.1. The boiling curve of water shows how temperature changes as heat is added. The temperature of the water rises linearly in the liquid phase, then levels off into a horizontal plateau during the phase change (boiling), and finally rises again in the vapor phase. The addition of 1 calorie of heat raises the temperature of 1 gram of water 1 degree Celsius. When the temperature of water reaches 100 degrees Celsius, it begins to boil. The addition of 540 calories to vaporize 1 gram of water. Because of the latent heat of vaporization, the temperature stays constant during the phase change. Once the water has all evaporated, any added heat goes to the temperature of the vapor.

← Organization →

← Particle's Kinetic Energy →

Figure 1.1.1. As a molecule's temperature changes, the spacing and energy level of its particles change.

In this activity, it is important to understand how liquids change into vapor (Figure 1.1). Molecules remain in the liquid phase until they gain sufficient kinetic energy (vibrational motion) to overcome the forces keeping them together. These forces include the attraction between molecules and the air pressure above the liquid. Adding heat to a liquid is an easy way to increase the kinetic energy of its particles. At some particular temperature, the particles will have become energetic enough to dissociate themselves from their neighbors and become a vapor. This is called the **boiling point**.

At the boiling point, any heat added to the liquid is absorbed by the molecules and the liquid changes to the vapor phase. Because these molecules escape into the air and carry away this extra heat, the temperature of the liquid never rises beyond the boiling point. In a graph showing the temperature history of some heating water (Figure 1.2), the boiling point graphs as a plateau.

EG-1999-12-121-14Q

Background

Thorough, easy-to-understand background information enables you to understand the key concepts in an activity.

Learning Activities

Clear, detailed activity procedures (with reproducible student sheets, when required) facilitate planning and classroom implementation.

Activity 1

Is There Water on Mars? An Educator's Guide With Activities for Physical and Earth and Space Science

Preassessment

(a) *Students Take a Position and Become Aware of Their Preconceptions:* Ask students how hot they could heat water given unlimited time and heating equipment.

(b) *Students Express Their Beliefs:* Have each student write down his or her prediction, sign his or her name, and hand it in to the teacher.

Procedure to Test Students' Preconceived Ideas

- Present the problem, "How hot can you heat water?" and as a class discuss how to control variables such as the amount of water, the number of burners, the height of the ring, etc.

Consider using 100-150 milliliters of water because it: (a) is easy to measure; (b) comes to a boil in 5-8 minutes; (c) does not boil away during a class period; (d) does not make too big a mess if spilled; (e) will not burn as badly as larger amounts of water if spilled on the skin; and (f) will cover the thermometer bulb. Make sure to read the safety notes on page 5 before beginning the activity.
- Have student teams set up the equipment for the activity (Figure 1.3):
 - Measure the agreed-upon amount of water
 - If using Bunsen or alcohol burners, adjust the lower ring to fit the burner properly and set a wire gauze on the lower ring.
 - Place the beaker or flask containing the water on the wire gauze or on the hot plate (turned off)
 - Attach the thermometer above the beaker with a clamp or string.
 - Adjust the thermometer so that the thermometer bulb is completely submerged and just above the bottom of the beaker (So it can measure the water temperature rather than the temperature of the glass, it should not touch the bottom of the beaker).
- Have students take the starting water temperature.

Teams of two students work well because there is little opportunity for off-task behavior when each student is totally engaged monitoring the time and temperature.
- After you check each group's setup, have students either light their burners or switch on their hot plates.
- Using a string rod (not the thermometer), have students stir and record the water temperature every 15 seconds.

Noticing a temperature plateau is a surprise that challenges students' intuition. Thus, the activity becomes a rich experience upon which to challenge old ideas and to develop new understandings. At some point between 97 and 105 degrees Celsius (depending on the weather and your elevation), students find that the temperature no longer changes. The crucial element in the discovery that, although the burner will quit in heat, the temperature stops rising. Do not let on that this is the result students are meant to achieve.

Figure 1.3. Activity 1 set up with (a) a burner and (b) a hot plate.

EG-1999-12-121-14Q



How Is This Module Organized?

Teaching Pointers

To assist you in conducting hands-on, inquiry-based activities, you will find pointers, classroom management strategies, discussion suggestions, extensions, and answers to the questions presented throughout the module.

Assessment Suggestions

This module outlines several options for assessing students, including preassessment questions, question sets, case studies, and suggestions for alternate ways of exhibiting student understanding.

Activity 1

© 1999-12-121-HQ

Preassessment

(a) *Students Take a Position and Become Aware of Their Preconceptions:* Ask students how hot they could heat water given unlimited time and heating equipment.

(b) *Students Express Their Beliefs:* Have each student write down his or her prediction, sign his or her name, and hand it in to the teacher.

Procedure to Test Students' Preconceived Ideas

- Present the problem, "How hot can you heat water?" and as a class discuss how to control variables such as the amount of water, the number of burners, the height of the rings, etc.

Consider using 100-150 milliliters of water because it: (a) is easy to measure; (b) comes to a boil in 5-8 minutes; (c) does not boil away during a class period; (d) does not make too big a mess if spilled; (e) will not burn or badly so large amounts of water if spilled on the skin; and (f) will cover the thermometer bulb. Make sure to read the safety notes on page 5 before beginning the activity.
- Have student teams set up the equipment for the activity (Figure 1.3):
 - Measure the agreed-upon amount of water.
 - If using Bunsen or alcohol burners, adjust the lower ring to fit the burner properly and set a wire gauze on the lower ring.
 - Place the beaker or flask containing the water on the wire gauze or on the hot plate (turned off).
 - Attach the thermometer above the beaker with a clamp or string.
 - Adjust the thermometer so that the thermometer bulb is completely submerged and just above the bottom of the beaker. (So it can measure the water temperature rather than the temperature of the glass, it should not touch the bottom of the beaker.)
- Have students take the starting water temperature.

Teams of two students work well because there is little opportunity for off-task behavior when each student is totally engaged monitoring the time and temperature.
- After you check each group's setup, have students either light their burners or switch on their hot plates.
- Using a stirring rod (not the thermometer), have students stir and record the water temperature every 15 seconds.

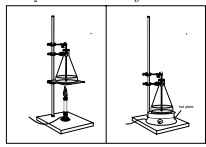



Figure 1.3. Activity 1 set up with (a) a burner and (b) a hot plate.

Heating a temperature plateau is a surprise that challenges students' intuition. Thus, the activity becomes a rich experience upon which to challenge old ideas and to develop new understandings. At some point between 97 and 105 degrees Celsius (depending on the weather and your elevation), students find that the temperature no longer changes. The crucial element is the discovery that, although the burner still puts its heat, the temperature stops rising. Do not let us see that this is the result students are meant to achieve.

EG-1999-12-121-HQ

3

Technology and Internet Recommendations

Computers and the Web can give students access to a rich set of support materials. The module lists pertinent Web sites, CD-ROM's, and videos and how to get actual Martian data and images. However, this module does not require the use of any classroom technology.

Case Study

Each activity in this module provides some of the information needed to answer the question: Is there water on Mars? In Activity 6, students take a position on this question and apply and integrate the module's concepts. This synthesis can be used as an assessment.

Activity 6

© 1999-06-121-HQ

MARS PATHFINDER LANDER
Temperature at 0.25 meters height

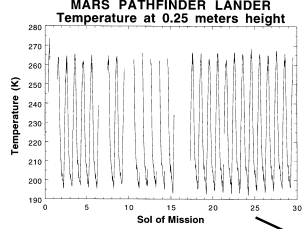

Courtesy of Dr. Jim Murphy, Mars Pathfinder ASIMET Team

MARS PATHFINDER LANDER
Surface Pressure

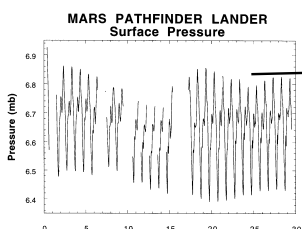

Courtesy of Dr. Jim Murphy, Mars Pathfinder ASIMET Team

48
EG-1999-06-121-HQ

Which Science Standards Are Supported in This Module?

	Activity 1: How Hot Can You Make Water?	Activity 2: How Fast Does Water Warm as Ice Melts?	Activity 3: How Can We Increase the Height of the Transition Plateau?	Activity 4: Do Fish Believe in Water? Do Students Believe in Air?	Activity 5: Testing Your Hypothesis: Boiling Water Below Its Temperature	Activity 6: Is There Water on Mars?	Activity 7: Where Would You Search for Water on Mars?
Unifying Concepts and Processes							
• Systems, Order, and Organization				●		●	●
• Evidence, Models, and Explanation	●	●	●	●	●	●	●
• Constancy, Change, and Measurement	●	●	●	●	●	●	●
• Evolution and Equilibrium	●	●	●		●		
Science as Inquiry							
• Abilities Necessary to Do Scientific Inquiry	●	●	●	●	●	●	
• Understandings About Scientific Inquiry	●	●	●	●	●	●	●
Physical Science							
• Structure and Properties of Matter	●	●	●	●	●	●	
• Motions and Forces	●	●	●	●	●	●	
• Conservation of Energy and Increase in Disorder	●	●	●		●		
• Interactions of Energy and Matter	●	●	●		●		
Earth and Space Science							
• Energy in the Earth System	●	●	●		●		
• Origin and Evolution of Planets						●	●
• Origin and Evolution of Planetary Systems						●	●
Science and Technology							
• Abilities of Technological Design							●
• Understandings About Science and Technology						●	●
History and Nature of Science							
• Science as a Human Endeavor						●	●
• Nature of Scientific Knowledge	●	●	●	●	●	●	●



How Hot Can You Make Water?

Purpose

To have students graph the temperature of water as it reaches a boil and discover the existence of the transition plateau

Overview

Students become aware of their preconceptions by considering how hot they could heat water. They then test their preconceived ideas by heating water and measuring its temperature. At some point near 100 degrees Celsius, students find that the water temperature no longer rises. They graph the data and try to make sense of the temperature plateau.

Key Concepts

- Water can only be heated to its boiling temperature.
- The slope of a graph line in this activity shows the rate of temperature change.

Context for This Activity

Mars has such low atmospheric pressure that any water at the surface would boil away. In this activity, students investigate the process of boiling and what is involved when water changes from a liquid to a gas under everyday conditions. In Activities 3 and 5, they will take a closer look at pressure's role in maintaining liquid water.

Skills

- *Predicting* the outcome of an experiment
- *Writing* a procedure to test a prediction
- *Controlling* variables
- *Conducting* an experiment
- *Collecting, recording,* and *graphing* data
- *Drawing* conclusions
- *Communicating* explanations to others

Common Misconceptions

- Water can be heated indefinitely to very high temperatures.
- The heat source controls boiling.
- Reaching temperature plateau means that something is malfunctioning

Materials

Heat source, beaker or flask, water supply, thermometer, ring stand or tripod, ring clamps, thermometer clamp, stirring rod, wire gauze (burners only), graph paper, goggles, appropriate safety equipment (see pages 5 and 19).

Preparation

- Plan how to present the initial problem and the best way to develop a procedure.
- Set out the necessary equipment for each group. Attach thermometers to ring stands.
- Discuss safety procedures related to heat sources, thermometers, glassware, and hot water.

Time: 2 class periods



Activity 1

Background

Why start a unit on Mars by boiling water? Interestingly, a lot of the Martian water seems to have boiled away, and studying boiling can help us understand why Mars has no liquid water. You might wonder how water can boil when the average temperature on Mars is -60 degrees Celsius. The way to understand this apparent contradiction is to better understand boiling. Our day-to-day experiences give us a decidedly limited understanding of boiling. To better understand boiling, students need to experience the existence of the *phase change plateau* (Figure 1.2).

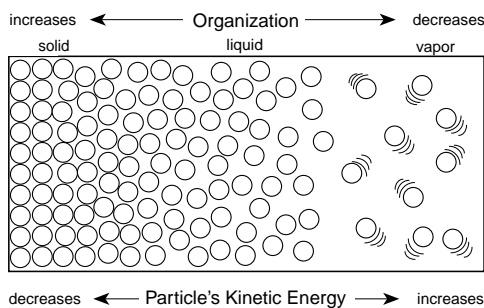

Figure 1.1. As a material's temperature changes, the spacing and energy level of its particles change.

In this activity, it is important to understand how liquids change into vapor (Figure 1.1). Molecules remain in the liquid phase until they gain sufficient kinetic energy (vibrational motion) to overcome the forces keeping them together. These forces include the attraction between molecules and the air pressure above the liquid. Adding heat to a liquid is an easy way to increase the kinetic energy of its particles. At some particular temperature, the particles will have become energetic enough to disassociate themselves from their neighbors and become a vapor. This is called the *boiling point*.

At the boiling point, any heat added to the liquid is absorbed by the molecules and the liquid changes to the vapor phase. Because these molecules escape into the air and carry away this extra heat, the temperature of the liquid never rises beyond the boiling point. In a graph showing the temperature history of some heating water (Figure 1.2), the boiling point graphs as a plateau.

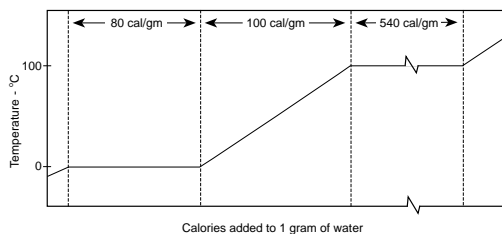

Figure 1.2. The heating curve of water shows how temperature changes as heat is added or subtracted. For example, when the temperature of ice reaches 0 degrees Celsius, it takes the addition of 80 calories to melt each gram of ice. Because all the added heat goes to melting the ice, the temperature holds constant during this phase change. Once the ice has all melted, any added heat raises the water temperature. The addition of 1 calorie raises the temperature of 1 gram of water 1 degree Celsius. When the temperature of water reaches 100 degrees Celsius, it takes the addition of 540 calories to vaporize 1 gram of water. Because all added heat goes to vaporizing the water, the temperature holds constant during this phase change. Once the water has all vaporized, any added heat raises the temperature of the vapor.

To many people, it does not seem possible that the water can remain the same temperature while heat is still being added. This phenomenon is nonintuitive and, as a result, is a source of misconceptions. What people forget is that each gram of water vapor carries away 540 calories, and the removal of this heat offsets the additional energy being provided by the heat source. If you add more heat by turning up the burner, all you will do is speed up how quickly the water boils away rather than increase the water's temperature. See the pedagogy overview at the beginning of the module for a discussion of the different ways to use the activity's preassessment questions to identify and alter students' misconceptions surrounding this topic.

Subsequent activities will show that boiling occurs at all sorts of different temperatures. This fact makes the liquid-vapor transition plateau extremely important. Because temperature is an unreliable indicator of boiling, the existence of a plateau is an important way to confirm whether you have boiling. When the whole class graphs its temperature data and discovers the (surprising) existence of a plateau, they are more ready to discuss boiling and conceptualize what the boiling temperature actually means.



Preassessment

- (a) *Students Take a Position and Become Aware of Their Preconceptions:* Ask students how hot they could heat water given unlimited time and heating equipment.
- (b) *Students Expose Their Beliefs:* Have each student write down his or her prediction, sign his or her name, and hand it in to the teacher.

Procedure to Test Students' Preconceived Ideas

1. Present the problem, "How hot can you heat water?" and as a class discuss how to control variables such as the amount of water, the number of burners, the height of the rings, etc.

Consider using 100–150 milliliters of water because it: (a) is easy to measure; (b) comes to a boil in 5–8 minutes; (c) does not boil away during a class period; (d) does not make too big a mess if spilled; (e) will not burn as badly as larger amounts of water if spilled on the skin; and (f) will cover the thermometer bulb. Make sure to read the safety notes on page 5 before beginning the activity.

2. Have student teams set up the equipment for the activity (Figure 1.3):
 - Measure the agreed-upon amount of water
 - If using Bunsen or alcohol burners, adjust the lower ring to fit the burner properly and set a wire gauze on the lower ring
 - Place the beaker or flask containing the water on the wire gauze or on the hot plate (turned off)
 - Attach the thermometer above the beaker with a clamp or string
 - Adjust the thermometer so that the thermometer bulb is completely submerged and just above the bottom of the beaker (So it can measure the water temperature rather than the temperature of the glass, it should not touch the bottom of the beaker.)
3. Have students take the starting water temperature.

Teams of two students work well because there is little opportunity for off-task behavior when each student is totally engaged monitoring the time and temperature.

4. After you check each group's setup, have students either light their burners or switch on their hot plates.
5. Using a stirring rod (not the thermometer), have students stir and record the water temperature every 15 seconds.

Hitting a temperature plateau is a surprise that challenges students' intuition. Thus, the activity becomes a rich experience upon which to challenge old ideas and to develop new understandings. At some point between 97 and 105 degrees Celsius (depending on the weather and your elevation), students find that the temperature no longer changes. The crucial element is the discovery that, although the burner still puts in heat, the temperature stops rising. Do not let on that this is the result students are meant to achieve.

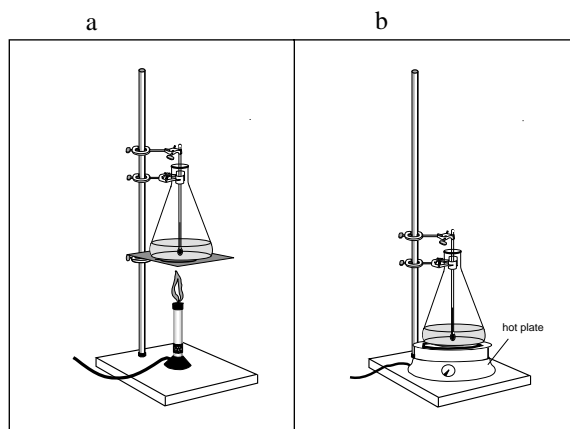

Figure 1.3. Activity 1 set up with (a) a burner and (b) a hot plate.

Activity 1

Have groups keep recording until most groups have several minutes' worth of temperatures at the water-to-vapor transition plateau. Obtaining a graph of the plateau is essential. Without it, students cannot fully understand boiling. Because the boiling temperature is pressure dependent, it is this plateau that indicates the boiling temperature—not the bubbling of water. When the whole class graphs the data and recognizes the (surprising) existence of a plateau, they are ready to discuss boiling and conceptualize the boiling temperature.

6. Have students graph their data.

Use the horizontal axis for time and the vertical axis for temperature.

7. Have each student make sense of the observations in his or her own way.

This step is vital in helping students resolve any conflicts between their preconceptions and observations. By making sense of the observations, students are forced to confront their earlier thinking and to accommodate a new concept.

8. Have students share their conclusions in their groups.

Questions to Probe Students' Observations

1. What is the general shape of your graph? How does it compare to the shape of your neighbor's graph?
2. At what temperature did the water in your beaker boil? How does it compare to the boiling temperature of the water in your neighbor's beaker?
3. What did you notice happening around the time the water temperature stopped rising?
4. How can the temperature stop rising while the hot plate/burner is still providing heat to the water? Where is all that energy going?



Safety Notes

Time should be spent in establishing procedures for working safely with burners, hot plates, glassware, boiling water, and steam. Having students follow safe laboratory procedures is prudent both in terms of personal safety and in terms of avoiding giving hands-on science a bad name in your school. You can require students to pass a written quiz before being allowed to participate in the lab or have students write a sentence explaining the rationale behind each precaution.

For classrooms using alcohol or Bunsen burners:

- Use the small cylindrical-shaped alcohol burners. The ones with a large ballooned-shaped bases contain large amounts of fuel, which can pose a significant fire danger.
- Fill burners at a central supply table, and show students how full to fill them.
- Have matches carried only in *match petries*—petri dishes with half a strike plate from a box of standard kitchen matches taped on the lid. Only three or four matches are carried in the petri at one time, enough to light a burner.
- Make sure each group has a *fire extinguisher beaker*—a beaker of water into which burned matches are placed and that can be used to douse accidental fires. Classes using alcohol burners should have boxes of baking soda to smother fires. Water can spread an alcohol fire.
- Place burners on a ceramic tile (standard wall tile) or ring stand base. This marks where a flame may safely be located.
- Position a ring over the burner at the appropriate height. Place a wire gauze on the ring to support the beaker. Alternatively, tripods may be used with burners but tripods are less stable than ring stands, are more likely to result in spills, and provide no place to clamp a thermometer.
- Have groups call the teacher over each time a match is struck. Check to see that students have a fire extinguisher beaker (or baking soda) and a proper lab set up. Watch them strike the match. Consider establishing a rule that says that no one may strike a match in the lab without the teacher's supervision. Even with such a rule, it takes just 3 or 4 minutes to light the burners of a class with 10 to 12 groups.

For classrooms with either burners or hot plates:

- Make sure students wear goggles throughout the lab. Goggles remind students to behave in a safe manner. Most state and school policies require them.
- Make sure thermometers are *not* carried around the room. Prior to the lab, clamp or hang thermometers from the upper rings of the ring stands. Students may adjust their rings but not remove the thermometers. This preparation virtually eliminates breakage. Hanging thermometers with pipe cleaners allows students to move them in and out of beakers and flasks without untying them, thus minimizing breakage.
- Use clamps to secure the beakers, flasks, and thermometers to the ring stand.
- Equip any classroom using heating sources with fire extinguishers, fire blankets, and a first aid kit.



How Fast Does Water Warm as Ice Melts?

Purpose

To have students graph the temperature of an ice-water slurry as it is heated and discover the existence of another transition plateau

Overview

Students become aware of their preconceptions by considering how hot they could heat ice water. They then test their preconceived ideas by heating an ice-water slurry and measuring its temperature. Until all the ice melts, students find that the temperature remains constant, nearly 0 degrees Celsius. They graph the data and try to make sense of the temperature plateau. Finally, the students explain what changes of state mean at the molecular level.

Key Concepts

- The temperature of ice water can rise only after all the ice has melted.
- The slope of a graph line in this activity shows the rate of temperature change.
- Temperature measures the average vibrational energy of a particle or group of particles.
- As the water in Activity 1 boiled and the ice in Activity 2 melted, the particles used the energy from the heat source to gain the extra kinetic energy required to change state. As a result, the temperature during these transitions never changed.

Context for This Activity

Mars has such low atmospheric pressure that ice at the surface would sublimate away. In this activity, students investigate the process of melting and what is involved when water changes from a solid to a liquid under everyday conditions. In Activity 5, they will take a closer look at pressure's role in maintaining ice.

Skills

- *Predicting* the outcome of an experiment
- *Writing* a procedure to test a prediction
- *Controlling* variables
- *Conducting* an experiment
- *Collecting, recording, and graphing* data
- *Drawing* conclusions and *communicating* them to others

Common Misconceptions

- The temperature of ice-water will rise as soon as heat is applied.
- Ice melts as a result of high water temperatures.
- A temperature plateau means that something is malfunctioning.

Materials

Heat source, beaker or flask, ice-water slurry, thermometer, ring stand or tripod, ring clamps, thermometer clamp, stirring rod, wire gauze (burners only), dishpan, graph paper, goggles, appropriate safety equipment (see pages 5 and 19).

Preparation

- Plan how to present the initial problem and the best way to develop a procedure.
- Set out the necessary equipment for each group. Clamp thermometers to ring stands.
- Discuss safety procedures related to heat sources, thermometers, glassware, and hot water.

Time: 2 class periods



Activity 2

Background

Activity 2 exposes students to yet another transition plateau—the one in which ice melts and becomes liquid water (Figure 2.1). The explanation of the ice-liquid transition plateau is much the same as the explanation of the liquid-vapor transition plateau in Activity 1. As heat is added to an ice-water slurry, the ice consumes 80 calories per gram. The ice will absorb all the heat available in order to melt. When the ice melts, it becomes water at 0 degrees Celsius, so the water remains at 0 degrees Celsius until all the ice has melted.

What is amazing is that on Mars, the ice-liquid transition plateau occurs at virtually the same temperature as the liquid-vapor transition plateau! How do the two plateaus, which are separated by about 100 degrees Celsius at sea level on Earth, end up being the same line on Mars? By the end of the module, you and your students will not only have an answer to this question, but you will understand enough about the intriguing story of water on Mars to be able to ask the same kinds of questions being asked by planetary scientists. You and your students will also learn how to use the data and images returned by NASA's missions to Mars to answer those questions (Figure 2.2).

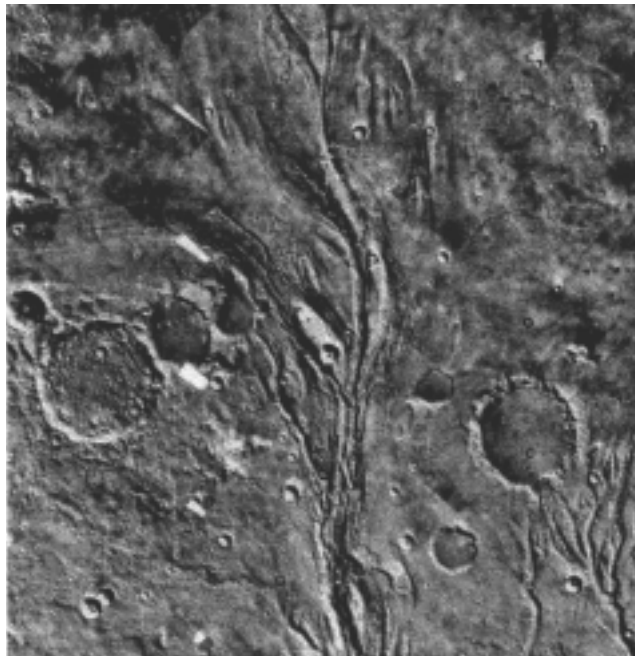

Figure 2.2. A Viking image of the channels between the Lunae Planum and the Chryse Planitia.

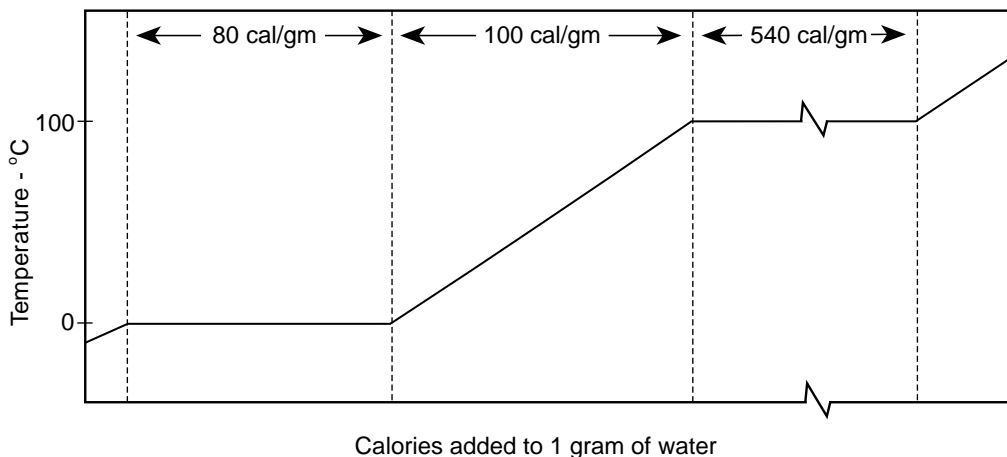

Figure 2.1. The heating curve of water shows how temperature changes as heat is added or subtracted.



Preassessment

(a) *Students Take a Position and Become Aware of Their Preconceptions:* Ask students:

- What will happen when you heat ice water?
- How hot can ice water get if given unlimited time and heating equipment?

(b) *Students Expose Their Beliefs:* Have each student write down his or her prediction, sign his or her name, and hand it in to the teacher.

Procedure to Test Students' Preconceived Ideas

1. Present the problem, "How hot can you heat ice water?" and as a class discuss how to control variables such as the amount of water, the number of burners, the height of the rings, etc.
2. Have students set up the equipment for the activity (see Figure 2.3):
 - Place crushed ice in a beaker up to the 150-milliliter line
 - Make an ice-water slurry by adding enough water to the beaker or flask to bring the ice-water mixture to the 150-milliliter line
 - Alternatively, prepare a large dishpan with the ice-water slurry and have students obtain 150 milliliters of it
 - If using a Bunsen or alcohol burner, adjust the lower ring to fit the burner properly and set a wire gauze on the lower ring
 - Place the beaker containing the slurry on the wire gauze or on the hot plate (turned off)
 - Attach the thermometer above the beaker with a clamp, string, or pipe cleaner
 - Adjust the thermometer so that the thermometer bulb is completely submerged and just above the bottom of the beaker (It should *not* touch the bottom of the beaker.)

3. Have students record the beginning temperature of the ice-water mixture.

The temperature should be close to 0 degrees Celsius.

4. After you check each group's setup, have students either light their burners or switch on their hot plates.
5. Using a stirring rod (NOT the thermometer), have students stir and record the temperature of the ice-water mixture every 15 seconds until the water temperature reaches 25 degrees Celsius.

Stirring is important because pockets of warm water can collect before all the ice has melted. This procedural mistake can give misleading results that take time to explain and might cause already disbelieving students to discount their observations.

Their Activity 1 graph started at about 20 degrees Celsius. If this graph ends at 25 degrees Celsius, the graphs from the two activities can be joined to show the relationship between the two plateaus. If time permits, have students gather a continuous set of ice-to-water-to-vapor data by continuing to heat their water to boiling.

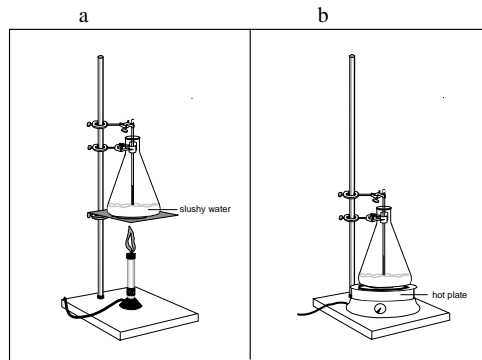

Figure 2.3. The activity set up with (a) a hot plate and (b) a burner.

Activity 2

6. Have students graph their data.

Have students use the same intervals they used for their Activity 1 graph. The graphs may be two or three papers long. If students use several sheets of paper to make their graphs, have them trim the edges and make one continuous graph.

7. Have each student make sense of the observations in his or her own way.

This step is vital in helping students resolve any conflicts between their preconceptions and observations. By making sense of the observations, students are forced to confront their earlier thinking and to accommodate a new concept.

8. Have students share their conclusions in their groups.

9. Conduct a discussion centered on having students explain changes of state in molecular terms based on the graphs generated in Activities 1 and 2.

Some possible ways to discuss change of state include (a) reviewing the kinetic theory and having students act out what is happening at the molecular level; (b) using flow diagrams to show how energy enters and leaves the system; (c) inventing analogies related to changes that occur after overcoming a resistance; (d) challenging students' understanding with questions similar to Analysis Questions 10–15 below.

Questions to Probe Students' Observations

1. What is the general shape of your graph? How does it compare to the shape of your neighbor's graph?
2. At what temperature did the ice in your beaker melt? How does it compare to the melting temperature of the ice in your neighbor's beaker?
3. What did you notice happening during the time the temperature plateaued?
4. How can the temperature remain steady while the hot plate/burner is still providing heat to the ice? Where is all that energy going?



Analysis Questions

These questions pertain to both Activities 1 and 2 and probe students' assumptions and understanding of boiling and melting. They are listed after Activity 2 because students will get more out of them after having direct experience with both boiling and melting. Use these questions as the basis of a discussion, for group work, or for homework.

1. How might the temperature plateau be related to the process of water boiling?
2. How might the temperature plateau be related to the process of ice melting?
3. What does the heat from the hot plate/burner do to the water molecules?
4. What does the heat from the hot plate/burner do to the ice molecules?
5. When a molecule goes from the liquid to the vapor state, how does its energy level change? What happens to its vibrational speed?
6. When a molecule goes from the solid to the liquid state, how does its energy level change? What happens to its vibrational speed?
7. Name the states of matter involved in the boiling of water.
8. Name the states of matter involved in the melting of ice.
9. Draw a cartoon panel or sequence of pictures that shows what is happening when:
 - (a) The hot plate/burner is heating the water but the water has not reached the boiling point and is not boiling
 - (b) The hot plate/burner is heating the water and the water has reached the boiling point and is boiling
 - (c) The hot plate/burner is heating the ice, but the ice has not fully melted
 - (d) The hot plate/burner has melted the ice and is now heating liquid water
10. What would you have to do to make the boiling plateau last exactly 10 minutes? An hour?
11. What would you have to do to make the melting plateau last exactly 10 minutes? An hour?
12. How is the melting of ice similar to the boiling of water? How is it different?
13. Why does water not boil at room temperature? What stops it from turning into a vapor?
14. What shape do you get when you attach the solid-to-liquid and the liquid-to-vapor graphs together? What do these shapes tell you about when water changes state?
15. Is water the only substance whose solid-to-liquid and liquid-to-vapor graphs have this shape? How could you test this idea? What differences would you predict between the change of state graphs of water and other substances?
16. Write a paragraph comparing how you answered the preassessment questions to Activities 1 and 2 with how you would answer them now.



How Can We Increase the Height of the Plateau?

Purpose

To have students increase the boiling temperature of water by increasing the pressure in the container

Overview

Students become aware of their preconceptions by considering what will happen to the boiling temperature of water if they increase the pressure in the container. They then test their preconceived ideas by heating water in an enclosed container and measuring its temperature. Students find that the boiling temperature is higher than when measured in an open container. They try to make sense of their observations and share their conclusions. Finally, students develop a hypothesis about the relationship between pressure and water's boiling temperature.

Key Concept

Water boils when its vapor pressure equals atmospheric pressure. As a result, water's boiling temperature is pressure, rather than temperature, dependent.

Context for This Activity

Most people think that a planet's temperature determines whether it can have liquid water. However, pressure plays a vital role, too. In this activity, students experiment with the relationship between pressure and temperature by increasing the pressure in a container and seeing that the boiling temperature of the water rises. This sets the stage for their work in Activity 5, when they reduce the pressure in a container.

Skills

- *Predicting* the outcome of an experiment
- *Developing* a hypothesis
- *Writing* a procedure to test a prediction
- *Controlling* variables
- *Conducting* an experiment
- *Collecting, recording, and graphing* data
- *Drawing* conclusions and *communicating* them to others

Common Misconceptions

- Boiling is a process that is controlled solely by the heat source.
- Atmospheric pressure is negligible.
- Pressure has no bearing on water's boiling temperature.

Materials

Heat source, 500 or 1,000-milliliter Erlenmeyer flask, three-hole stopper, plastic tubing, thermometer, ring stand or tripod, ring clamps, thermometer clamp, stirring rod, wire gauze (burners only), graph paper, goggles, appropriate safety equipment (see pages 5 and 19).

Preparation

- Plan how to present the initial problem and the best way to develop a procedure.
- Set up the apparatus for safely increasing the pressure in a container.
- Insert thermometers in the rubber stoppers.
- Set out the necessary equipment for each group.
- Discuss safety procedures related to heat sources, thermometers, glassware, and hot water.

Time: 2 class periods



Activity 3

Background

In Activity 3, the water story gets more involved and more interesting. For reasons such as the atmosphere's height, density, temperature, and humidity, atmospheric pressure can change. As a result, the force the atmosphere exerts on molecules, squeezing them together, can change. When a liquid tries to boil under high pressures, its molecules require more kinetic energy than usual to break free of their neighbors and become vapor (Figure 3.1). Higher kinetic energy translates into higher boiling temperatures. This is why a pressure cooker cooks food so fast. The high pressure inside the cooker requires that water reaches a higher temperature in order to boil. This higher temperature cooks the food faster. Conversely, under low pressures, molecules require little kinetic energy to break free of their neighbors and become vapor. Low levels of kinetic energy translate into low boiling temperatures. Consequently, under low pressures, water can boil at temperatures as low as 0.0098 degrees Celsius! And this is the reason there is no liquid water on Mars today. The pressure is so low that water boils away as soon as the temperature rises high enough to melt the ice. This concept is explored further in Activity 5.

It is important that students “play” with the relationship between pressure and boiling temperature. Activity 3 gives students an introductory experience with this

relationship and sets them up for a more complete exploration of it in Activity 5.

Students' answers to Activity 1 and 2's preassessment questions will reveal many misconceptions about the temperature at which water changes state. Some will say that they can heat water to 500 degrees if given enough burners and time. Others will recite the memorized answer that water boils at 100 degrees Celsius. Because the boiling point of water—the temperature at which it changes from liquid to vapor—is pressure dependent, water can be made to boil at temperatures between 0.0098 and several hundred degrees C! Consequently, *both* answers reveal a lack of understanding.

Students almost always think of boiling as something that happens from underneath. Intuitively, focusing on the heat source makes sense—the bottom of a pot is where the heat is concentrated, where the molecules have the most kinetic energy, and where bubbles form. This module provides experiences that can help change this perception to the idea that boiling is controlled by what is *on top* of the liquid. That boiling is pressure dependent is a significant concept in physical and Earth science. Therefore, it is important to address and alter any misconceptions students may hold.

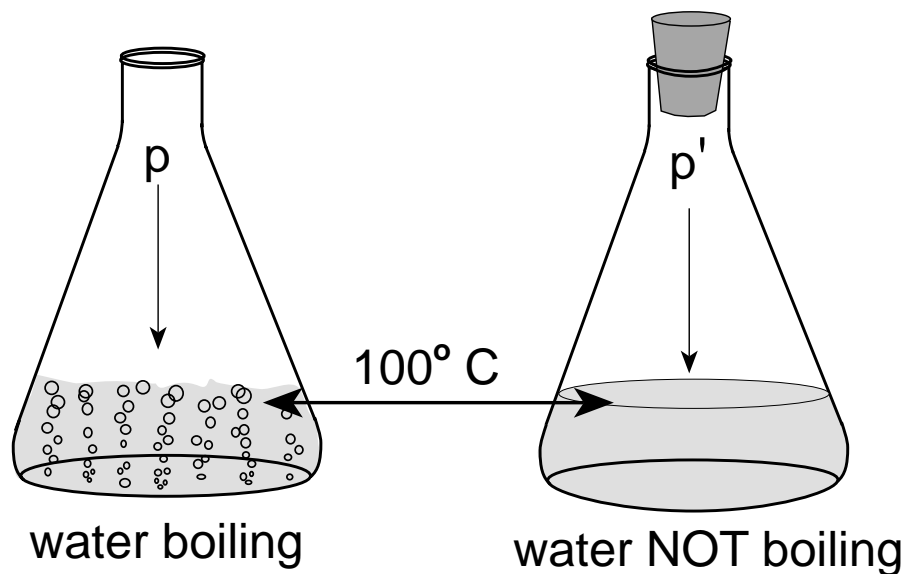

Figure 3.1. The water in both flasks is at 100 degrees Celsius, but it is only boiling in Flask A, which is open and at atmospheric pressure (p). Flask B is stoppered, and the pressure is above atmospheric pressure (p'), preventing the water from boiling.

Preassessment

(a) *Students Take a Position and Become Aware of Their Preconceptions:* Ask students:

- What would it take to change the boiling temperature of water?
- What will happen if one increases the air pressure in a container of boiling water?

(b) *Students Expose Their Beliefs:* Have each student write down his or her prediction, sign his or her name, and hand it in to the teacher.

Procedure to Test Students' Preconceived Ideas

1. Have groups discuss the possible effects of increasing the pressure above the water's surface. How would increasing the pressure affect a water molecule's ability to go from the liquid to vapor state? Have each group present its best idea. List them on the board.
2. Ask groups to develop hypotheses based on the ideas listed in Step 1. List the hypotheses on the board.
3. Select a hypothesis for students to investigate related to increasing the boiling temperature by increasing the pressure.

If you need to justify choosing a particular hypothesis, you can say that it lends itself best to the equipment you have available. Record any unused hypotheses for future projects.

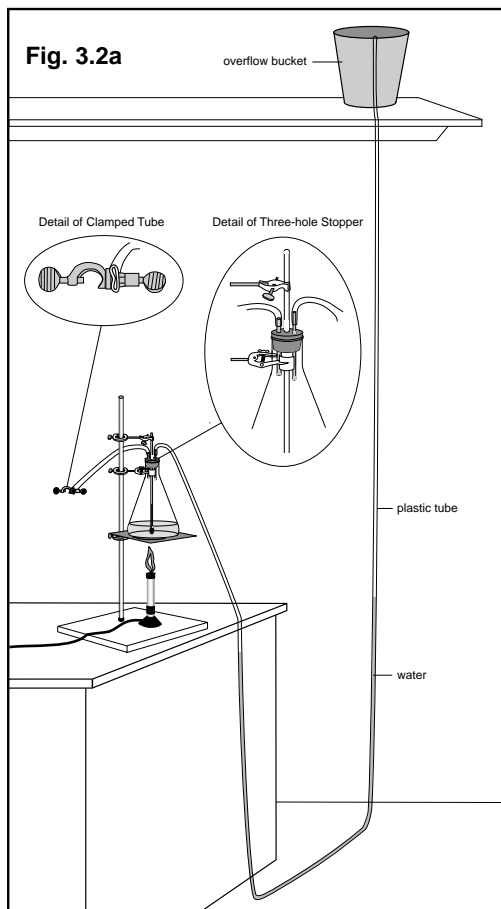

In Figure 3.2a, students can adjust the clamp on the tube and regulate the pressure inside the flask. Changes in pressure cause changes in the boiling temperature. The long tube serves as a manometer that enables students to measure the pressure in the flask. It also acts as a pressure relief valve. To measure the pressure inside the flask, students must measure the difference in the water levels between the two vertical sections of the plastic tube. Each centimeter of difference equals about 1 millibar. The manometer is no longer accurate when the water reaches the horizontal section of the tubing. Figure 3.2b shows how a syringe can be used to increase the internal pressure and stop the boiling process.

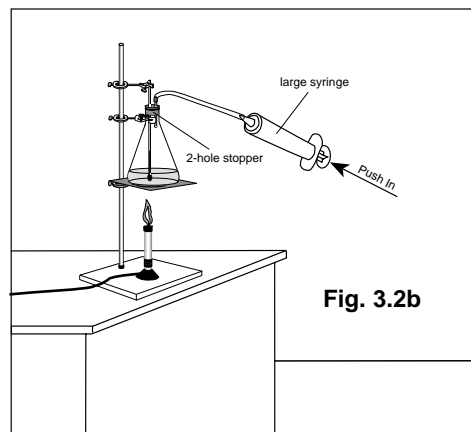

Activity 3

4. Ask students to describe any hazards associated with building up pressure inside a glass container.

The container may be unable to withstand the internal pressures and explode. See safety notes.

5. Show students the apparatus for safely increasing the pressure in a container and explain to them how it works (Figure 3.2).
6. Have the class outline a procedure to test the hypothesis.

The goal is for students to be able to measure a rise in the boiling temperature when there is an increase in pressure inside the container. Make sure that they record the boiling temperature before increasing the pressure so they have a baseline for comparison.

7. Have groups follow the procedure.
8. Have each group summarize its observations.
9. Have each student make sense of the observations in his or her own way.

This step is vital in helping students resolve any conflicts between their preconceptions and observations. By making sense of the observations, students are forced to confront their earlier thinking and to accommodate a new concept.

10. Have students share their conclusions in their groups.
11. In a class discussion, have groups share their findings.

The focus of this activity is the role pressure plays in determining water's boiling temperature. Press students to explain the relationship between boiling temperature and pressure. Consider having students make analogies or act out skits to explain what is happening on a molecular level.

12. At the conclusion of the discussion, ask each group to develop a hypothesis about the relationship between pressure and water's boiling temperature.

Questions to Probe Students' Observations

1. What was the boiling temperature of the water before you increased the pressure? How does that compare to your neighbor's initial boiling temperature?
2. How did the boiling temperature change when you increased the pressure? How did it change for other groups when they increased the pressure?
3. How might pressure influence the way molecules behave?



Analysis Questions

This series of questions probes students' assumptions and understanding of boiling. Use them as the basis of a discussion, for group work, or for homework.

1. Why did the boiling temperature increase in this activity?
2. How can you change the following analogies so they help explain why increasing the pressure raises the boiling temperature?
 - (a) The load on a ski lift's motor as more and more skiers fill the chairs
 - (b) The load on a bulldozer's engine as it scrapes the surface and builds a large dirt pile
 - (c) The resistance on a pump's motor as it raises some water to a pond at the top of a hill

In each of these cases, the motors (and, by extension, the amount of energy) have to work harder as the resistance increases. Likewise, pressure influences how easily a molecule in the liquid state can disassociate itself from its neighboring molecules and enter the vapor state. The greater the pressure, the greater the resistance to becoming vapor. When the pressure is increased, molecules in the liquid state need to vibrate faster than before to break away and enter the vapor state. Since temperature is a measure of a particle's vibrational speed, an increase in pressure raises the boiling (that is, the water-to-vapor) temperature of water.

3. Draw a cartoon panel or sequence of pictures to show what is happening when the pressure above a container of boiling water increases.
4. Why does water not boil at room temperature? What stops it from turning into a vapor?
5. How are boiling and melting like:
 - (a) Jumping out of bed after throwing back a sheet versus a blanket versus three heavy blankets?
 - (b) Lifting a car with a jack versus lifting a house with a jack?
 - (c) Running while pushing a shopping cart versus running while not pushing anything?
6. Write a paragraph comparing your how you answered the preassessment question with how you would answer it now.



Activity 3

Extension—What Is This Mystery Object?

Procedure

1. By way of introduction, tell students that archaeologists found an interesting object at the site of an ancient yard sale. Their job is to help you figure out what it is and how it works.
2. Have the class gather around the pressure cooker and examine it (Figure 3.3).
 - Let them determine how all the parts fit together.
 - Have them feel the heft of the pressure regulator.
 - Ask them what the markings or gauge on the pressure regulator might mean.
 - Ask them to speculate about what goes in the pot.
 - Have them examine the thickness of the walls and the way the lid secures. Is this typical of kitchen pots? Why might this pot be made this way?

Make sure students understand that pressure cookers are used to increase the pressure inside the pot. The pot has thick walls to withstand the pressure, and it seals tightly to keep in the pressure.

3. After students understand the principle behind pressure cookers, ask why anyone would want to increase the pressure when they cook.
4. Have student groups write a brief paragraph that could be used in an advertisement. The ad copy must explain what pressure cookers do, how they work, and why someone would want one.

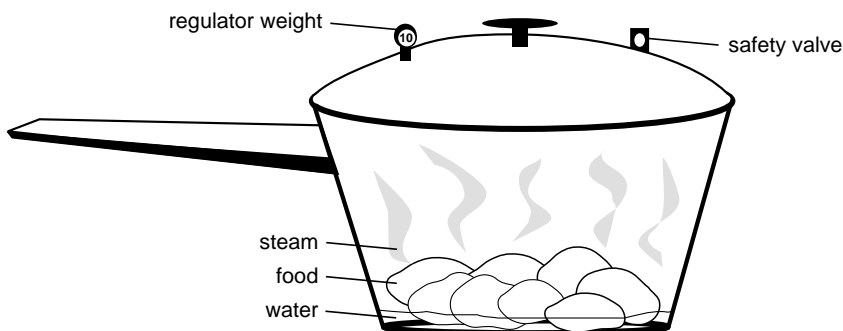

Figure 3.3. Cross section of a pressure cooker.

Safety Procedures: True Tales of a Teacher's Worst Nightmare

Steam and hot water burns are particularly dangerous. Not only are the temperatures high, but the specific heat of water is very high. This means that water contains more heat than the same amount of almost any other substance at the same temperature. When a spill concentrates all of this heat on someone's skin, serious second- and third-degree burns result. In addition to the safety procedures mentioned in Activity 1, additional safety procedures include:

- **Use a safe setup.** In the field test, some teachers asked students to increase the pressure inside a flask by having students use a pencil to apply pressure to a loosely set stopper. In several cases, the steam jetted around the stopper and burned students' hands. In addition, several students tipped over their unsecured flasks, sending glass and hot water across their table.
- **Provide a pressure relief valve.** Stoppers use friction to maintain a tight seal. Depending on the type of material used to make a stopper and on its age and condition, some stoppers can hold very tenaciously. Unfortunately, people often mistakenly believe that the stopper is the weak point of the system and that it will pop when pressures in a container build to unsafe levels. They trust that the stopper will act as a de facto pressure-relief valve. However, stoppers can hold unexpectedly firmly. In addition, classroom glassware is often scratched. Even minor, undetectable scratches weaken the glass. The combination of a tight stopper and scratched glassware is a recipe for serious harm.
- **Avoid building up internal pressures.** Some teachers attached a long plastic tube to one of the holes in a two-hole stopper (the thermometer occupied the other hole). They wanted students to open and close the end of the tube to control the pressure in the flask. In theory, this works well. Unfortunately, some overzealous students wanted to see how high the pressure (and, correspondingly, the temperature) would go. The pressure built to a point where the flask shattered. The stopper never popped.



Do Fish Believe in Water? Do Students Believe in Air?

Purpose

To have students perform several activities showing that Earth's atmosphere exerts considerable force at the surface

Overview

Students rotate through a number of stations, each of which has an activity that uses atmospheric pressure to produce an unexpected outcome. They then distill the activity's common elements into a set of core principles. Finally, they apply their understanding of atmospheric pressure by designing devices that make use of pressure differences.

Key Concepts

- Air has mass and volume.
- Air pressure is a function of the mass and temperature of the atmosphere in conjunction with Earth's gravitational pull.
- The particles in high-pressure air are packed more densely than those in low-pressure air.
- Air flows from areas of high pressure to areas of low pressure to equalize the pressures.
- When the volume of a given mass of gas increases, its pressure decreases, provided that the temperature remains constant (Boyle's Law).

Context for This Activity

Many students are unaware that they are subject to atmospheric pressure, or even that they live within an atmosphere. In this activity, students make the often-unnoticed effects of the atmosphere noticeable. Activity 4 sets the stage for Activities 5 and 6, when students consider the consequences of little or no atmospheric pressure.

Skills

- *Observing* a situation
- *Developing* a hypothesis
- *Drawing* conclusions and *communicating* them to others
- *Applying* their understanding
- *Designing* devices

Common Misconceptions

- Air has no mass or volume.
- Atmospheric pressure is negligible.
- Day-to-day air pressure changes have no rational explanation.

Materials

See notes pertaining to each station.

Preparation

- Determine how well the class understands that air has mass and volume, and consider ways to review or develop these ideas if they are new or if students need a refresher.
- Set up the stations you have selected for your class.
- Select one or two demonstrations to test the class's core principles.
- Decide which devices you want to have students design/build in Step 8.

Time: 2–3 class periods



Activity 4

Background

Because air is invisible and generally imperceptible, it is hard for people to identify it and its effects. In addition, many book presentations use abstract concepts and technical terminology to discuss air and air pressure. As a result, many students find these topics confusing and are discouraged from altering their prior views and ideas.

Students may not understand that air has mass and that our atmosphere, which is more than 100 kilometers thick, has considerable weight. Just as fish may be oblivious to the water that supports and sustains them, most people are oblivious to the fact that they live at the bottom of a great sea of air.

While we have little trouble understanding why we feel significant water pressure at the bottom of a swimming pool, we often find it hard to accept that we are subject to air pressure. Because our arms and bodies move so effortlessly, we find it hard to believe that the atmos-

phere presses down on us as hard as it does. In the case of a moving arm, what we forget is that the atmosphere presses equally hard on the top, sides, and bottom of our arms, so the force is equalized in all directions, effectively eliminating any sensation of pressure. It is, perhaps, testimony to the ways our bodies have adapted to air pressure that we can live quite happily without ever acknowledging air or air pressure.

Earth's atmosphere is estimated to weigh 5.8 million billion tons, and the atmosphere pushes with a force of 1,013 millibars at sea level (see Figure 4.1)—a function of the mass and temperature of the atmosphere in conjunction with Earth's gravitational pull. Higher pressures result when there is more atmosphere overhead. Conversely, lower pressures result when there is less atmosphere overhead (Figure 4.1). Under high pressure, particles are packed together more tightly than under low pressure. The scientific maxim, "Nature abhors a vacuum," also applies to partial vacuums and pressure

Altitude (Meters)	Pressure (Millibars)	Percent of Atmosphere Above This Altitude	Boiling Point (Celsius)
0	1,013	100	100.0
500	955	94	98.5
1,000	899	89	96.9
1,500	846	83	95.0
2,000	795	78	93.5
2,500	747	74	91.9
3,000	701	69	90.0
3,500	658	65	88.5
4,000	617	61	86.8
4,500	578	57	85.0
5,000	541	53	83.5
5,500	505	50	81.5
6,000	472	47	80.0
6,500	441	43	78.5
7,000	411	41	76.5
7,500	383	38	74.9
8,000	357	35	73.1
8,500	332	33	71.5
9,000	308	30	69.7
9,500	286	28	68.0
10,000	265	26	66.4

Figure 4.1. This vertical profile of air pressure is based on the Standard Atmosphere, a model averaged for all seasons and latitudes. It uses a fixed sea-level air temperature of 15 degrees Celsius and a pressure of 1,013 millibars. For comparison, Denver is at 1,500 meters, and Mount Everest is 8,848 meters tall. Ninety-nine percent of the atmosphere is below 32 kilometers.



Activity 4

differentials. As a result, high-pressure air moves to areas of low-pressure air to equalize the pressure and to achieve a consistent spacing between all the particles.

This module is about water. Because water could not exist in the liquid form without a certain amount of air pressure, it is crucial to understand that Earth's atmosphere exerts a significant force at the surface. Because of their kinetic energy, molecules in the liquid state can become vapor if the atmospheric pressure is low enough. To remain a liquid, molecules must be pressed together enough so that they cohere rather than separate and become vapor.

To get the most out of this activity, students will have to understand that air has mass and volume and that it can exert pressure. If these concepts are unclear to your students, there are a number of hands-on ways to develop them. For example, to show that air has volume, inflate a bag or invert a cup in a pan of water and discuss why the bag cannot collapse or why water cannot enter the cup (Figure 4.2). To show that air has mass, weigh a minimally inflated volleyball (something whose volume will remain constant, unlike a balloon), add some air with a pump, and weigh it again. It will weigh more.

There are two concepts that help explain the situations at each station in Activity 4:

- When the volume of a given mass of gas increases, its pressure decreases, provided that the temperature remains constant (Boyle's Law).
- Air flows from areas of high pressure to areas of low pressure to equalize the pressures.

In the situations at the stations, students increase the volume of a contained amount of gas. According to Boyle's law, when the volume of a given mass of gas increases, its pressure decreases. Because nature abhors a vacuum (or even a partial vacuum), whenever there is a decrease in pressure, higher pressure air moves in to equalize the pressure. At each station, there is a barrier between the areas of high and low pressure, so the higher pressure air is blocked from reaching the lower pressure air. This creates a pressure gradient. The atmosphere will push on the barrier in its attempt to overcome the gradient and equalize the pressures.

In each of the setups, students can calculate the force exerted by the atmosphere by multiplying atmospheric pressure (about 1 kilogram per centimeter²) by the surface area of the barrier between the high and low pressures.

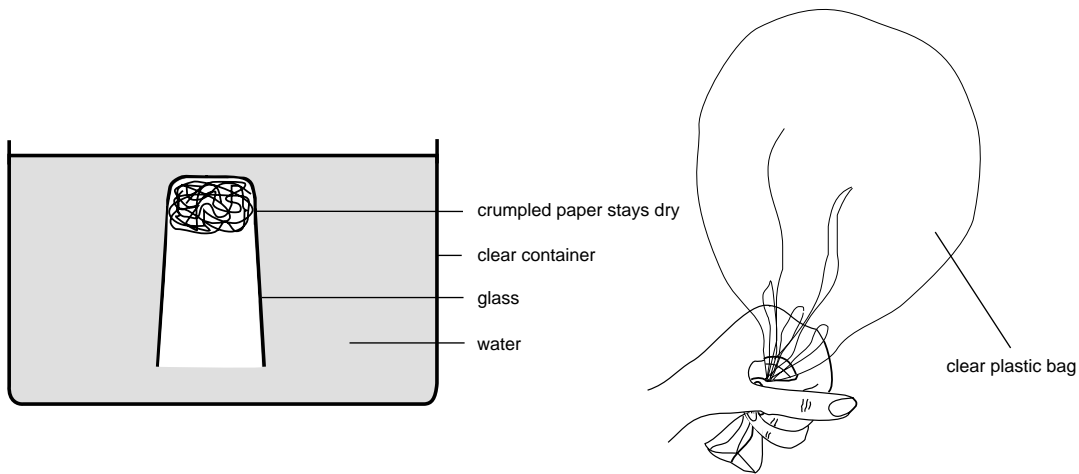

Figure 4.2. Two ways to demonstrate that air has volume and occupies space.

Activity 4

Preassessment

(a) *Students Take a Position and Become Aware of Their Preconceptions:* Ask students:

- Describe a time when the atmosphere was pushing on you.
- How hard was it pushing on you at that time?
- Why can you drink a milkshake through a straw?
- If the lid is on tightly, why is it sometimes hard to drink the milkshake through the straw?

(b) *Students Expose Their Beliefs:* Have each student write down his or her prediction, sign his or her name, and hand it in to the teacher.

Procedure to Test Students' Preconceived Ideas

1. Set up a number of stations (see preparation notes on page 28) and have groups spend a few minutes at each one. Have each student record his or her observations and answers to the questions.
2. Have each student make sense of the observations in his or her own way by explaining how the situation at each station works.

This step is vital in helping students resolve any conflicts between their preconceptions and observations. By making sense of the observations, students are forced to confront their earlier thinking and to accommodate a new concept.

3. Have students share their explanations in their groups. Have groups summarize the explanations and develop a set of operating principles that can explain the situations at the different stations.
4. Challenge the groups to eliminate duplication and redundancy and reduce their lists of explanations to a core set of operating principles.
5. Have each group share the operating principle with the greatest explanatory power. Record the principles on the board.
6. Examine the list for duplication. Ask whether there are other principles to add to the list.
7. Test the principles against the situations at each station. If the class is struggling to understand a particular situation, have them repeat Steps 2–6.

Probe students' thinking by pointing out apparent contradictions and flaws. Consider using a demonstration not used in a station either as a way to open up students' thinking or as a test of the class's principles.

8. Test students' grasp of atmospheric pressure by giving them challenges, such as:
 - Devise a way to measure elevation using air pressure (for example, a barometer).
 - Build a device that measures differences in daily air pressure (for example, a barometer).
 - Without blocking the tube, modify a straw so it is impossible to use (for example, poke holes in the straw).
 - Design an exercise system based on differences in air pressure (for example, a resistance device employing pistons or suction cups).
 - Design three systems that let astronauts drink from a straw in the vacuum of space (for example, a squeeze bag, a pressurized cup, a pump, etc.).



Analysis Questions

This series of questions probes students' assumptions and understanding of air pressure. Use them as the basis of a discussion, for group work, or for homework.

1. What causes air pressure?
2. What might cause air pressure to change?
3. On a molecular level, describe the differences between high- and low-pressure air.
4. Why does high-pressure air try to flow to areas of low pressure?
5. Name three ways to change high-pressure air into low-pressure air and three ways to change low-pressure air into high-pressure air.
6. Why is air pressure typically lower at the top of a mountain than at sea level?
7. If the atmosphere really presses down on your arm with great force, why is it so easy to move it?
8. What is the typical atmospheric pressure on Earth? What was it at your school today?
9. Write a paragraph comparing your how you answered the preassessment question with how you would answer it now.

Extension

Barometers measure changes in air pressure. You can easily make the aneroid barometers illustrated below from readily available materials. In each case, as the air pressure changes, the volume of the enclosed air will either increase or decrease, depending on the pressure gradient between the room air and the trapped air.

Stretch a piece of balloon over the mouth of a jar, and secure it with tape to trap some air. With rubber cement or petroleum jelly, attach two small pieces of wood or plastic to the balloon, one over the center of the opening and the other over the rim of the jar. Position a straw, as shown in Figure 4.3, and secure the end over the middle to the wood with some rubber cement or petroleum jelly. The straw functions as a lever, and its movement indicates the increase or decrease in the volume of the trapped air. *Caution:* If students handle the jar while they are taking measurements, the heat from their hands will warm the enclosed air and cause it to expand, increase the interior pressure, and alter the measurement.

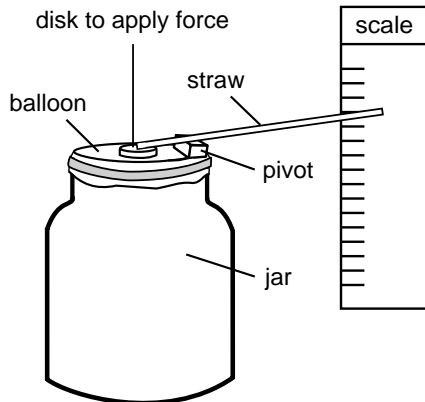

Figure 4.3. The elastic material in this barometer moves in response to changes in atmospheric pressure.

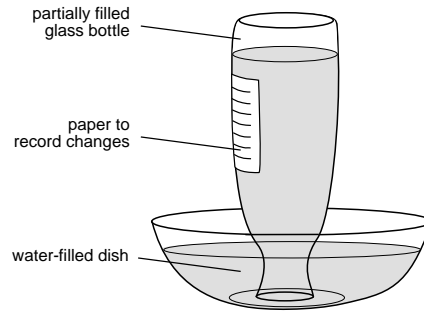

Figure 4.4. The water level in this barometer changes in response to changes in atmospheric pressure.

Partially fill a rigid bottle (for example, glass) with water. Invert it so its mouth is under the surface of a water-filled saucer. To prevent evaporation, cover the water exposed to air with a thin film of vegetable oil. You can record variations in air pressure by attaching a strip of paper to the outside of the bottle (Figure 4.4).



Can You Unstick the Plunger?

Procedure

1. Press the plunger onto a smooth, hard surface. Note any air flowing in or out of the small hole.
2. Pull straight up and pull the plunger off the surface. Note any air flowing in or out of the hole.
3. Press the plunger onto a smooth, hard surface. Cover the small hole with a wetted finger.
4. Pull straight up and pull the plunger off the surface.

Questions

1. Why does air come out the small hole in Step 1?
2. Why does air enter the small hole in Step 2?

Can You Get the Glove Out of the Jar?

Procedure

1. Put your hand in the glove.
2. Keeping the jar on the table, pull the glove out of the jar without disturbing the jar's seal.
3. Keep the jar on the table at all times, and please do not rip anything.

Questions

1. When did you first feel resistance?
2. Can you curl your fingers without feeling any resistance?
3. What is keeping the glove in the jar?
4. How could you alter the setup so the glove could come out easily? Why would your change make a difference?

How High Can You Lift Water?

Procedure

1. Submerge the glass and tip it so it fills with water but still has a small air pocket above the liquid.
2. Lift the glass straight up. How high can you lift the water inside the glass before it spills out?
3. Try setups with bigger, smaller, and no air pockets. How high can you lift the water inside these situations before it spills out?

Questions

1. Does the size of the air pocket change as you lift the glass? Mark the water level, if necessary.
2. How did the size of the air pocket affect the outcome?
3. What changes occur to enable the water to flow out?
4. Why does the water stay in the glass instead of flowing back into the pool of water?

Can You Inflate the Balloon?

Procedure

1. Slip a section of drinking straw onto the open tube (for example, the tube without the balloon attached).
2. Inflate the balloon as much as possible by sucking on the straw.

Questions

1. How was air moving into the balloon?
2. What were you doing to help air move into the balloon? What important system of the body works this way?
3. What do you have to do to keep the balloon inflated? Why?
4. How else could you inflate the balloon? Describe the way the air would flow if you tried your method.
5. What would happen if you blew through the open tube?

Can You Fix a Leaky Bottle?

Procedure

1. Fill the bottle with water.
2. How can you stop the water from flowing out the small hole at the bottom of the bottle without turning it over?

Questions

1. Do any of your ideas involve air pressure? How?
2. Does the water stop flowing immediately after you cover the top?
3. When the top is covered, why does air not enter the bottle through the small hole?
4. Why did the water stop flowing out of the bottle?

How Strong Is a Suction Cup?

Procedure

1. Press one of the suction cups onto a smooth surface.
2. Attach the scale's hook to the suction cup.
3. Have people stand back so a flying elbow does not hurt someone. Pull straight up until the suction cup pops off, noting the amount of force required to remove it.
4. If available, try some of the other suction cups.

Questions

1. How much force did it take to remove a suction cup?
2. Did each suction cup require the same amount of force? If not, why are there differences?
3. What keeps the suction cup sticking to the surface?
4. Why is it so easy to remove a suction cup if you lift an edge?

Can You Trap Water Inside a Straw?

Procedure

1. Hold a finger over the end of a straw, and lower it into the water.
2. Remove the finger, and observe what happens.
3. Replace the finger on top of the straw, and lift it out of the water.

Questions

1. Why did the water not enter the straw in Step 1?
2. Why did the water rush in once you removed your finger?
3. How did you get the water out of the straw? What changed once the finger was removed that enabled the water to flow out of the straw?

Can You Use a Card to Keep Water Inside an Inverted Glass?

Procedure

1. Fill the container three-quarters full of water.
2. Place the card over the mouth of the container.
3. Holding the card to the rim with a dry hand, invert the container over the dishpan.
4. Mark the position of the top surface of the liquid.
5. Slowly, remove the hand holding the card.
6. Again, mark the position of the top surface of the liquid.

Questions

1. Did the position of the top surface of the liquid change?
2. Describe the shape of the card.
3. What is keeping the water in the container?
4. How far can you slant the container before the water pours out?



Activity 4

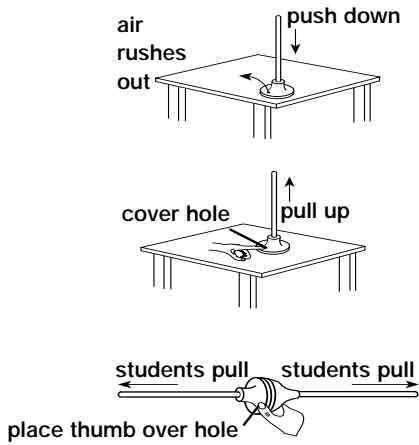

Figure 4.5. The rubber cup expands, increasing the volume and lowering the pressure of the trapped air.

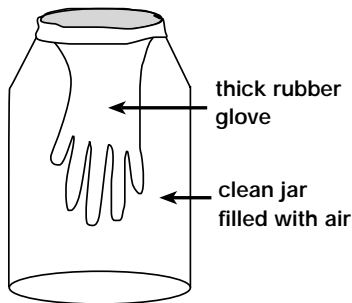

Figure 4.6. When the glove is removed, the volume of the trapped air increases, and its pressure decreases.

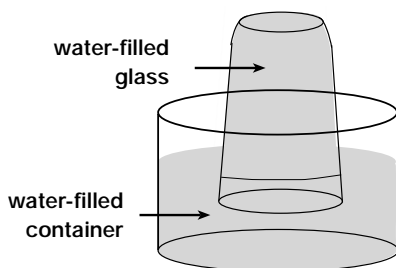

Figure 4.7. Some water leaves the glass, increasing the volume and decreasing the pressure of the trapped air.

Notes for Preparing Each Station

Can You Unstick the Plunger?

Preparation and Pointers

1. Make a small hole in the plunger cup with some scissors or an awl.
2. You can improve the seal by moistening the edge of the plunger or one's finger (Figure 4.5).

Alternatives or Extensions

Instead of using one plunger on a hard surface, stick two plungers together. Poke a small hole in one of them. In the year 1650, a similar experiment with two hollow iron hemispheres was performed in Magdeburg, Germany. The hemispheres were placed together, and some air was removed. The vacuum was so strong that it required 16 horses to separate them.

Can You Get the Glove Out of the Jar?

Preparation and Pointers

1. Use a clear, 1-gallon, wide-mouthed jar, such as a pickle jar. If you are worried that students might break a glass jar, consider using a clear plastic jug.
2. Use good quality, heavy-duty rubber gloves (Figure 4.6).

Alternatives or Extensions

1. A plastic bag, such as a bread bag, also works, although it is prone to tearing.
2. To show that air occupies space with this setup, invert a plastic bag over the mouth of the jar, blow a little air into the bag so that it stays inflated over the jar, and seal the bag air-tight against the jar. Ask students to push the bag into the jar. Because the jar is already full of air, the bag cannot go in.

How High Can You Lift Water?

Preparation and Pointers

At the station, provide a dishpan of water, a clear glass, a marker or tape for marking the water level, and towels (Figure 4.7).

Alternatives or Extensions

Ask students: "What is the least amount of water needed to support a glass full of water?" Fill the glass, place a petri dish over it, hold it over the dishpan, invert the glass and petri, and let a little water into the petri. The shallow pool of water will support an entire glass of water because atmospheric pressure acts on the surface area rather than the volume of the liquid.



Can You Inflate the Balloon?

Preparation and Pointers

1. Use a flask or a tall jar whose opening can accommodate a two-hole stopper.
2. Insert two glass tubes through the holes in the stopper. To keep the tubes away from the students' eyes during inflation, either make the balloon's tube stick only a short way above the stopper or use a glass tube with a 90-degree bend as the mouthpiece tube.
3. Use a rubber band or tape to attach a small balloon to one of the glass tubes.
4. For sanitary reasons, cut drinking straws into sections, and have students slip them over the glass tube and use them as mouthpieces.
5. Choose glass tubes and drinking straws that fit snugly together (Figure 4.8).

Alternatives or Extensions

1. Students will have to seal the open tube to maintain the lower pressure in the jar and keep the balloon inflated.
2. Students can also inflate the balloon by blowing into the tube attached to the balloon, provided the other tube remains unblocked.
3. Have students consider how their lungs are similar to and different from this model.

Can You Fix a Leaky Bottle?

Preparation and Pointers

1. A 12-, 16-, or 32-ounce plastic soda bottle with a small mouth works well.
2. Use a nail to make a small hole, and test the setup to make sure it works properly.
3. Provide a water supply, a cup for filling the bottle, a dishpan, and towels at the station (Figure 4.9).

Alternatives or Extensions

1. If students turn the bottle upside down, can they prevent water from flowing out the unsealed stopper hole? Out of an unstoppered bottle? Why or why not?
2. Ask why it is a good idea to poke two holes in the top of a can, such as an evaporated milk or frying oil can.

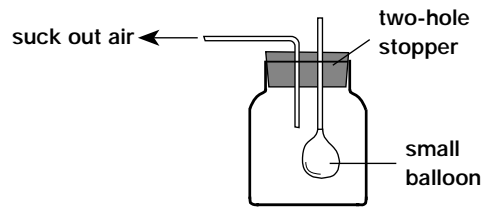

Figure 4.8. When air is removed from the jar, the pressure inside the jar decreases.

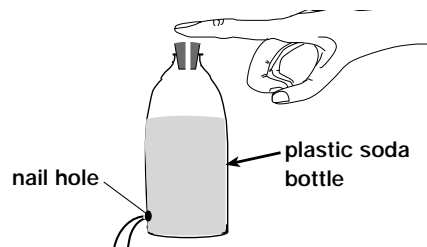

Figure 4.9. When some water flows out, the volume of the trapped air increases and its pressure decreases.

Activity 4

How Strong Is a Suction Cup?

Preparation and Pointers

1. Find suction cups with hooks *securely attached* with a loop of metal around the top of the suction cup rather than with a hook screwed into the rubber.
2. If a hook comes off, wrap wire around the bulb on top of the suction cup and form a loop. Alternatively, you can pierce the bulb and thread a wire through it.
3. Buy many backup suction cups if the hooks tend to come off easily. If keeping hooks attached is difficult, students can still get the point by just tugging at the suction cup. This gives them a good qualitative rather than quantitative experience.
4. *Stress caution.* Students will be pulling hard, and a sudden release will cause the puller's arm to swing back quickly.
5. Buy suction cups in a variety of sizes.
6. Use heavier duty scales, such as ones that measure up to 25 or 50 kilograms.
7. Make sure the surface is smooth enough for the suction cups to make a good seal.
8. Putting stiff suction cups in boiling water for a few minutes can revitalize them (Figure 4.10).

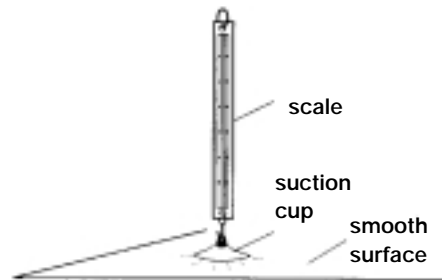

Figure 4.10. The rubber cup expands, increasing the volume and lowering the pressure of the trapped air.

Can You Trap Water Inside a Straw?

Preparation and Pointers

1. Make sure the straw is transparent. A glass tube can be substituted.
2. Adding color to the water can make it easier to see.
3. Provide towels at the station (Figure 4.11).

hold index finger against top of straw



Figure 4.11. Gravity pulls the water down, increasing the volume and lowering the pressure of the trapped air.

Can You Use a Card to Keep Water Inside an Inverted Glass?

Preparation and Pointers

1. Make sure the container is transparent and that its opening is smaller than a playing card. It must be made of a rigid material, such as glass. Otherwise, the card will be forced off when the container is squeezed.
2. Plastic-coated playing cards work well because they do not soak through. In addition, a deck of 52 cards assures that a dry card can be used each time.
3. Provide a marking pen, dishpan, and towels at the station (Figure 4.12).

Alternatives or Extensions

1. Other noncarbonated liquids will work equally well.
2. A container filled to the brim will also work. With no air pocket, there is no air pressure in the container. Therefore, the only pressure on the container side of the card is the weight of the water. If this weight is less than atmospheric pressure, the card will remain on the rim. You can determine the pressure gradient by comparing the pressure on the card with the weight of the water.

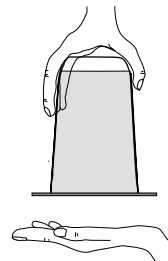
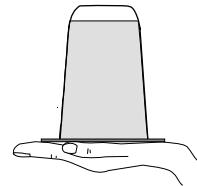
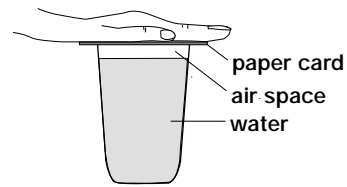

Figure 4.12. The card bows slightly, increasing the volume and lowering the pressure of the trapped air.

Activity 4

Teacher Demonstrations

These activities are better conducted as demonstrations because they either use materials that are in limited supply, involve fire or boiling water, take longer to complete than the activities recommended for the stations, or are best understood when you are able to use questions to guide students' thinking. Practice these demonstrations before trying them.

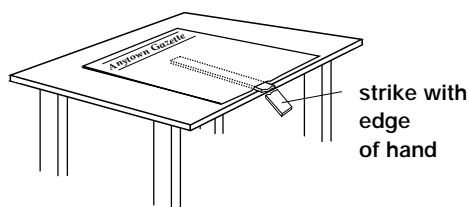

Figure 4.13. The pressure under the paper is far less than the pressure above the paper.

The Heavy Newspaper

Lay a long, thin, flat, breakable board (for example, paneling or a yardstick) on a table so that about 8 centimeters protrude. Ask students what will happen if you hit the end of the board. They will probably say that it will fly up. Hit the board so that it flies up. Next, spread one or two sheets of newspaper over the board. Position the newspaper flush with the edge of the table and remove all air pockets by smoothing it from the center outwards. Ask again what will happen if you hit the board. The students will probably think that the stick will fly up and tear the paper. Push down on the end of the board *slowly* and lift up the paper. Reset the paper and, this time, strike the end of the board sharply. The rising board will increase the volume of the small air pocket under the paper. However, there is too little time for air to get under the paper (Figure 4.13). The resulting pressure gradient temporarily turns the newspaper into an unyielding barrier, and the stick breaks. You can calculate the force on the paper by multiplying its area by atmospheric pressure. Pull another 8 centimeters of the board over the edge. Smooth the newspaper, and break the board as before. This can be repeated, but at some point the board will be able to rip the paper because of its mechanical advantage as a lever. Stop while you are ahead!

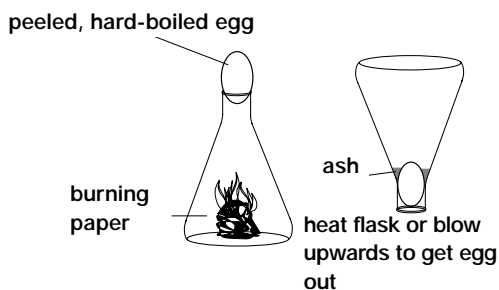

Figure 4.14. Fire drives out air and reduces the interior pressure, and atmospheric pressure pushes in the egg.

Egg in a Bottle

Lubricate a peeled, hard-boiled egg with vegetable oil or glycerin. Place it on the rim of a container whose opening is slightly smaller than the diameter of the egg. Ask: "What will happen if I light a fire under the egg?" Expect a wide variety of predictions. Light a piece of paper, lift up the egg, insert the burning paper, and set the egg quickly back onto the container's mouth. The egg will vibrate as the air warms, expands, and exits the container by slipping past the egg. When the fire goes out, the air cools and contracts. This lowers the pressure in the container, and atmospheric pressure *pushes* the egg into the container (Figure 4.14). To get the egg out, invert the container so that the egg blocks the passage, blow some air past the egg into the container, and let the increased pressure push out the egg. Alternatively, invert the container so that the egg blocks the passage, and heat the container. The air will expand when it warms and will push out the egg. This activity is also a good way to review the effect of heat on matter.



Drinking Through a Straw

Fill a flask with water, and seal it with a one-hole stopper fitted with a straw or glass tube. Challenge a student to drink water through the straw. When the student removes some water, the pressure in the flask drops (Figure 4.15). Because the pressure in the straw at that point is greater than the pressure in the flask, it quickly becomes impossible to extract any water. You can also use a two-hole stopper. By covering and uncovering the second hole, students can examine the effect of letting air move freely into the flask and contrast it with the situation when the hole is covered.

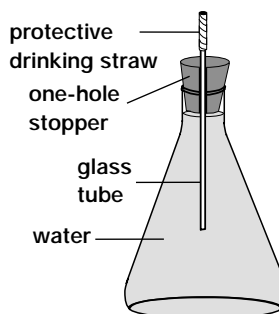

Figure 4.15. After a little water is removed, the interior pressure drops too low for students to overcome.

The Can Crush

Cover the bottom of a soda can with water. Using tongs, hold the can over a heat source until the water boils vigorously for around 30 seconds. Quickly, invert the can and dip 2 centimeters or so of the end with the opening into a container of cold water. With a dramatic crunching of aluminum, it will collapse instantly (Figures 4.16 a–c). The boiling water drove out the air and replaced it with water vapor. When the cold water cooled this vapor, it condensed. At 100 degrees Celsius and 1 atmosphere, liquid water is 1,600 times as dense as water vapor, so the volume of the vapor in the can drops significantly. The reduction in volume creates a partial vacuum in the can, and the atmospheric pressure outside the can crushes in to equalize the pressure differential. Although water is being sucked into the can through the opening, it cannot enter quickly enough to equalize the pressure. Plus, it further cools the vapor, further reducing the pressure. This activity is also a good way to review changes of state and the properties of liquids and gasses. This demonstration can also be done in “slow motion” by using a large metal can, such as a duplicator fluid gallon can (Figure 4.16 d–e). Instead of dipping it into cold water, screw on the lid, and let it cool slowly on a table top.

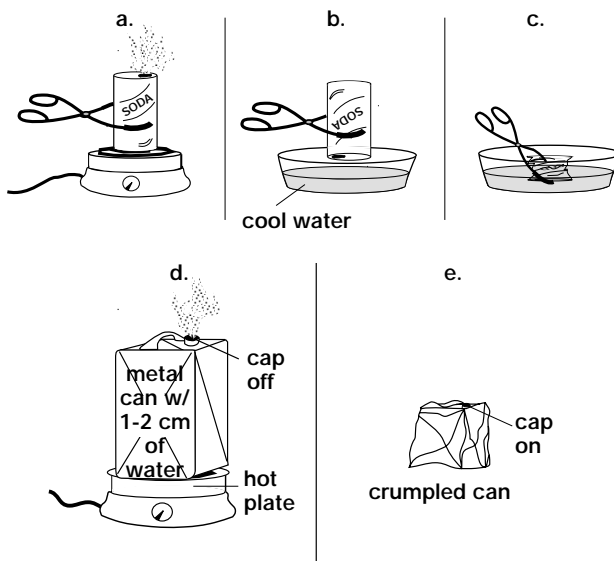

Figure 4.16. Condensing steam reduces the interior pressure, and atmospheric pressure crushes the can.

Testing Your Hypothesis by Boiling Water Below Its Boiling Temperature

Purpose

To have students boil water below its typical boiling temperature by reducing the pressure above the surface of the liquid

Overview

Groups discuss ways to reduce the boiling temperature of water and present their best idea. After discussing each idea, groups select an approach, write a procedure, and follow it. Students find that water can boil well below its typical boiling temperature. They try to make sense of their observations and discuss their conclusions in their groups. Next, the teacher gives the students a phase diagram for water without telling them what it is. The groups study it and write a caption for it based on what they think it shows. Through a discussion, the students learn about phase diagrams and use them to better understand their previous work with pressure and changes of state. Finally, the students hypothesize about the effects of different elevations and weather conditions on the boiling point of water.

Key Concept

Water boils when its vapor pressure equals atmospheric pressure. As a result, water's boiling temperature is pressure, rather than temperature, dependent.

Context for This Activity

Mars has such low atmospheric pressure that any water at the surface would boil away. In this activity, students see that they can get water to boil below its "typical" boiling temperature when they drop the pressure in a closed container. By extrapolating the pattern between boiling temperature and pressure, they realize that even water near its freezing point has enough kinetic energy to boil if the pressure is low enough.

Skills

- *Predicting* the outcome of an experiment
- *Developing* a hypothesis
- *Writing* a procedure to test a hypothesis
- *Controlling* variables
- *Conducting* an experiment
- *Using* a phase change diagram
- *Collecting, recording, and graphing* data
- *Drawing* conclusions and *communicating* them to others

Common Misconceptions

- Boiling is a process that is controlled solely by the heat source.
- Pressure has no bearing on water's boiling temperature.

Materials

Heat source, 500- or 1,000-milliliter round-bottomed, thick-walled (for example, Florence) flask, three-hole stopper, plastic tubing, thermometer, 100 cc or larger air piston (syringe), ring stand or tripod, ring clamps, thermometer clamp, stirring rod, wire gauze (burners only), graph paper, goggles, appropriate safety equipment.

Preparation

- Plan how to present the initial problem and the best way to develop a procedure.
- Insert thermometers in the rubber stoppers.
- Set out the necessary equipment for each group. Make sure the glassware is heavy-duty enough to withstand considerable pressure.
- Discuss safety procedures related to heat sources, thermometers, glassware, pressurized containers, and hot water.

Time: 2–3 class periods



Activity 5

Background

In Activity 3, students raised the boiling temperature of water by increasing the pressure above the water. To vaporize in the pressurized container, the water molecules needed to increase their kinetic energy. This increase in kinetic energy translated into a higher boiling temperature. Activity 5 is a natural extension of this earlier work. In this activity, students find ways to *reduce* the temperature of the water-to-vapor plateau. By challenging students to reduce water's boiling temperature, they must apply their understanding to a related, but new, situation. Their hypotheses will reveal how well they understand the relationship between pressure and boiling temperature.

Just how do you reduce water's boiling temperature? You can do this by reducing the pressure above the water. With a reduced pressure, the water molecules need less kinetic energy to vaporize than they do in an open container. This decrease in kinetic energy translates into a lower boiling temperature.

Whether water exists as a solid, liquid, or gas depends on its temperature *and* the pressure of the surrounding environment. Change the temperature or pressure, and water may undergo a phase change. We are familiar with how water responds to changes in temperature—at sea level, it typically freezes at 0 degrees Celsius and boils at 100 degrees Celsius. However, we are less familiar with how water responds to changes in pressure (recall Figure 4.1).

Researchers have measured the phase changes of water over a wide variety of temperatures and pressures. The resulting graph is called a *phase diagram* (Figure 5.1).

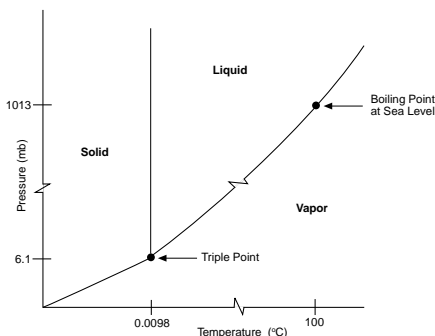

Figure 5.1. A phase diagram shows the equilibria among the three phases of water. At the triple point, the vapor pressure of ice, water, and water vapor are equal.

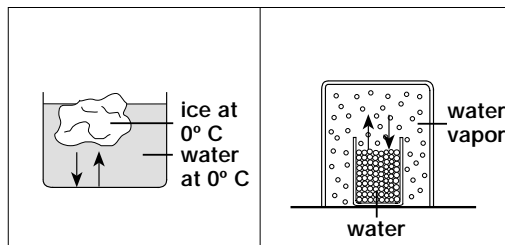

Figure 5.2. Water is in equilibrium with ice when it freezes at the same rate that the ice melts (a). It is in equilibrium with vapor when it evaporates at the same rate that the vapor condenses (b).

Every substance has its own unique phase diagram. At a boundary line between two phases, two phases are in *equilibrium* with one another—that is, the rate of molecules leaving a particular phase equals the number returning (Figure 5.2). We refer to the inclination of a molecule to change phase and establish an equilibrium as its *vapor pressure*. Vapor pressure increases with increasing temperatures. At higher temperatures, a particle's kinetic energy is higher, and, with more energy available at higher temperatures, it is easier for particles to change phase. Even solids such as ice have a vapor pressure and can *sublimate* directly to the vapor phase.

If two phases are not in equilibrium, molecules will change from one phase to the other until an equilibrium is established. The water evaporating out of a lake in the desert is trying to establish an equilibrium with the dry desert air. In the case of a puddle, the water disappears completely before an equilibrium is established. Each temperature-pressure combination has its own equilibrium point. If you connect these many equilibrium points, you will have drawn the boundary lines on the phase diagram.

All three boundary lines meet at a point called the *triple point*. At this temperature and pressure, all three phases are in equilibrium with one another. In other words, at the triple point, vapor sublimates to ice and condenses to liquid, liquid evaporates to vapor and freezes to ice, and ice melts to liquid and sublimates to vapor all at the same rate. A minuscule change in either temperature or pressure will move the phase changes away from the triple point. Away from the boundary lines, water exists in a single phase over a particular range of temperatures and pressures.

Because a phase diagram shows so clearly how water changes phase in relation to pressure and temperature lev-



els, it is the key to helping students understand the current situation with liquid water on Mars. In fact, a phase diagram contains the essence of this entire module!

On the phase diagram, notice that below 6.1 millibars, liquid water cannot exist, irrespective of the temperature. Water's vapor pressure is just too high to remain a liquid below this level. When atmospheric pressure falls below 6.1 millibars, water can only exist as ice or vapor, depending on the temperature. This fact is significant in our study of Mars because the atmospheric pressure at the Martian surface hovers just above 6.1 millibars. Any water that might form on a warm afternoon from melting ice would quickly disappear in the desiccated Martian atmosphere. If the vapor pressure of the warmed water exceeded atmospheric pressure, it would boil. If, instead, its vapor pressure stayed below atmospheric pressure, the water would evaporate. The temperature and pressure combinations on Mars make liquid water theoretically possible on an occasional basis. However, the desiccated atmosphere and the short-term nature of the appropriate temperature-pressure conditions make the existence of significant amounts of water on the Martian surface impossible (Figure 5.3).

On Earth, propane, butane, dry ice, ether, and freon are familiar materials whose vapor pressure is considerably higher than Earth's atmospheric pressure. Toy stores often sell freon-filled "perpetual drinking birds" and globes containing freon that can boil when held in one's hand. Bring these or a butane lighter into class and discuss what is happening inside. On Mars, water would behave the way freon and butane behave on Earth.

Something to be alert to when discussing weather-related pressure changes is the fact that humid air weighs *less* than dry air. This is because water vapor (H_2O) weighs less than gaseous nitrogen (N_2). Because liquid water weighs more than air, students invariably say that humid air weighs more than dry air. This response reveals that

they make no distinction between liquid and gaseous water, even though we teach about states of matter. Consider addressing this common misconception during the activity. So, there are actually two reasons why low pressures are associated with rainy weather—a humid air mass weighs less than a dry air mass, and a low pressure system rises to a lower altitude than a high-pressure system (that is, it is not as tall).

Use the phase diagram to answer questions about cooking modifications, the boiling of eggs, and water sterilization. Whenever the pressure changes, there is a corresponding change in water's boiling temperature. People living at high altitudes use pressure cookers, cook foods longer, or modify their recipes to compensate for the lower boiling temperatures. In fact, Galileo used differences in boiling temperature to calculate elevation. Students might try to predict the weather or measure elevations using water's boiling temperature.

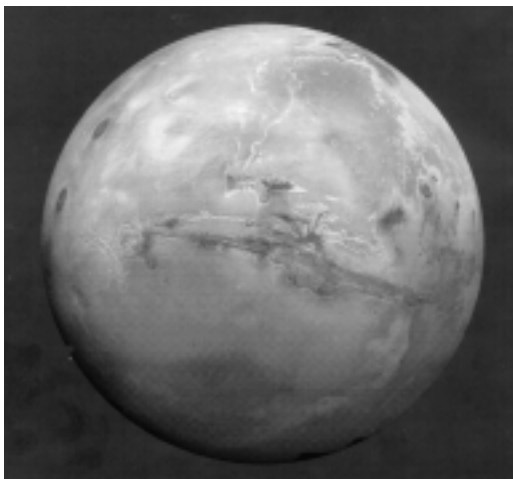

Figure 5.3. This image of Mars shows that the Martian surface is currently dry.

Activity 5

Preassessment

(a) *Students Take a Position and Become Aware of Their Preconceptions:* Ask students:

- How low can air pressure on Earth be lowered?
- What happens when one lowers the air pressure over some liquid water?

(b) *Students Expose Their Beliefs:* Have each student write down his or her prediction, sign his or her name, and hand it in to the teacher.

Procedure to Test Students' Preconceived Ideas

1. At the end of Activity 3, each group developed a hypothesis about the relationship between pressure and water's boiling temperature. For this lab, ask students groups to suggest procedures to *reduce* the boiling temperature of water.
2. Have each group present its best idea for how to reduce the boiling temperature of water and explain how its approach works. List the ideas on the board, and have the class identify the ones that achieve the objective and are testable in the classroom.

If students suggest some feasible, nonpressure-related ideas, decide whether you want the groups that came up with them to test their procedures. Doing so maintains student ownership of the problem but risks extending the time required to complete the unit. Record any unused hypotheses for future projects.

3. Depending on time, equipment, and the nature of the suggested procedures, decide which approach below best fits your situation:
 - Have each group select a feasible idea, write a procedure, and follow it.
 - As a class, select a feasible idea, write a procedure together, and have each group follow it.
 - Write a procedure as a class, and then perform it as a demonstration (see Figure 5.4).

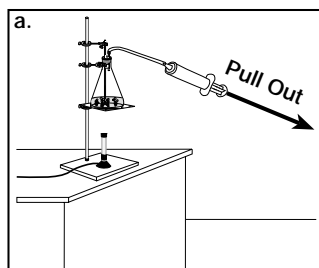
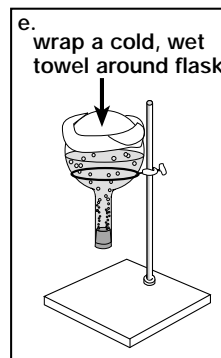
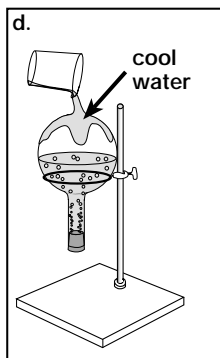
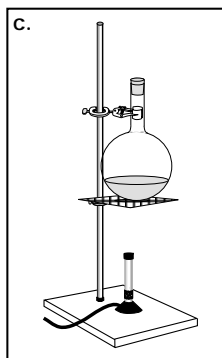
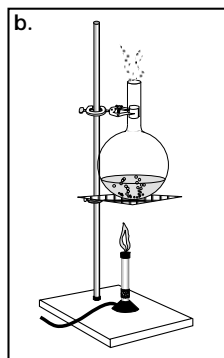

Figure 5.4. These figures show two ways to cause boiling at temperatures below 100 degrees Celsius by reducing the pressure in a sealed container. Figure a shows how a syringe can be used to reduce the internal pressure and restart the boiling process. Figures b–e show how to reduce pressure by condensing vapor (Figures d and e are alternate ways to cool the water heated in Figures b and c).



Writing a procedure as a class enables you to discuss the elements of a complete procedure and to highlight safety concerns. If groups each write their own procedures, you may want to check the procedures for dangerous practices before having students begin. Writing the procedure can also be assigned as homework and discussed at the start of the next class, either in groups or as a class. The appeal of a demonstration is its efficiency. However, research shows that students retain ideas best when they play an active role. A demonstration robs students of the direct involvement so crucial to experiencing and understanding an activity.

4. After groups complete the procedure, have them summarize their observations.
5. Have each student explain in his or her own way how water can boil by lowering the temperature of the flask.

This step is vital in helping students resolve any conflicts between their preconceptions and observations. By making sense of the observations, students are forced to confront their earlier thinking and to accommodate a new concept.

6. Have students share their explanations in their groups.
7. Have groups summarize their conclusions and share them in a class discussion.
8. Without introducing it, distribute the two phase diagrams of water to each group. Have each group write a caption for the diagram based on what they think it shows.
9. Have groups share their captions in a class discussion.
10. Ask groups to explain how this diagram can be used to explain what happened in this activity and in Activities 1, 2, and 3.
11. Have students hypothesize about the effects of different elevations and weather conditions on the boiling point of water. Ask how they might test their hypotheses.

Have students test their hypotheses by boiling water under different weather conditions and/or by contacting schools at very different elevations and comparing boiling temperatures.

Questions to Probe Students' Observations

1. How did you lower the boiling temperature of water?
2. What was the temperature of the water when it boiled?
3. Why did your approach enable water to boil below its typical boiling temperature?



Activity 5

Analysis Questions

This series of questions probes students' assumptions and understanding of boiling. Use them as the basis of a discussion, for group work, or for homework.

1. Use the phase diagram to explain why, under the same weather conditions, it is harder to make hard-boiled eggs in Denver, known as the "mile-high city," than in Miami, a sea-level city.
2. On rainy days, water's boiling temperature is several degrees lower than it is on dry days. Also, water at sea level boils at a higher temperature than water at higher elevations. Why does boiling temperature vary?
3. How could you use boiling temperature to predict weather or determine elevation?
4. How might recipes need to be modified for mountain cooking?
5. Why is it hard to sterilize drinking water by boiling it at a higher elevation?
6. Will water always boil at the same temperature in your kitchen? Why or why not?
7. How could you get water to boil at its freezing temperature?

Lower the pressure to the triple point.

8. What do you think water would look like at the triple point?

Water can change phase only after crossing a boundary line. Therefore, it would remain in its current phase until it crossed a boundary line. However, the three phases are in equilibrium at the triple point. As a result, the water would change phase in order to establish an equilibrium between all three phases over time.

9. Why does water not boil at room temperature? What stops it from turning into a vapor?
10. Suppose you are on a climbing expedition to the top of Mount Everest. Near the top you decide to pause and boil tea for lunch. What can you predict about the process of boiling here? Would the tea burn your mouth?
11. Write a paragraph comparing how you answered the preassessment question with how you would answer it now.
12. At the start of this unit, you were asked to write down how hot could you heat water given unlimited time and heating equipment. How would you respond to this question now?



Pressure (mb)

Detail of the Phase Diagram of Water from -1 C to 2 C

Pressure (mb)

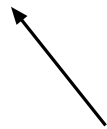

Is There Liquid Water on Mars?

Purpose

To have students analyze actual data and images to assess whether there is liquid water on Mars

Overview

Groups analyze temperature and pressure graphs from the first 30 days of the Pathfinder mission and discuss whether liquid water could have existed under these conditions. The pressures make water theoretically possible although the temperatures are below water's freezing point. Next, students look at images of Mars. By interpreting the landforms and comparing a river-cut valley on Mars with Earth's Grand Canyon, they identify water as the agent that shaped the surface. They hypothesize about how water could have flowed across the Martian surface, even though current conditions make it virtually impossible for liquid water to exist. Finally, they consider how the considerable amount of water that seems to have flowed across the Martian surface could have disappeared.

Key Concepts

- Current climatic conditions make the existence of liquid water on Mars virtually impossible.
- Features on the Martian surface provide strong evidence for past flows of large amounts of water.

Context for This Activity

The Viking and Pathfinder missions have collected temperature and pressure data from the Martian surface. In this activity, students analyze some of these data and realize that the pressure at the Martian surface is so low that no liquid water can exist. Given this fact, they are then challenged to explain the existence of water-related features on Mars.

Skills

- *Analyzing* graphs
- *Interpreting* images
- *Measuring* distances using a map scale
- *Comparing* landforms on two planets
- *Developing* hypotheses to explain apparent contradictions
- *Drawing* conclusions and *communicating* them to others

Common Misconceptions

- Mars has liquid water (for example, the famous “canals”).
- Liquid water can exist on Mars.
- Mars is dry and never had any water.
- Massive amounts of surface water cannot just disappear from view.

Materials

Pathfinder's temperature and pressure graphs, Images 1–15 in Appendix I, Notes on the Image Set in Appendix H

Preparation

- Plan how to conduct a discussion based on the Pathfinder data.
- Plan how you want students to proceed through the image set.

Time: 2 class periods



Activity 6

Background

After a 7-month, 300-million-kilometer journey, Mars Pathfinder landed on Mars July 4, 1997. The lander contained the radio link to Earth, most of the science instruments, and a rover named Sojourner (Figure 6.1). Sojourner was used to deploy two imagers and an instrument that could determine the composition of rocks and minerals on the surface.

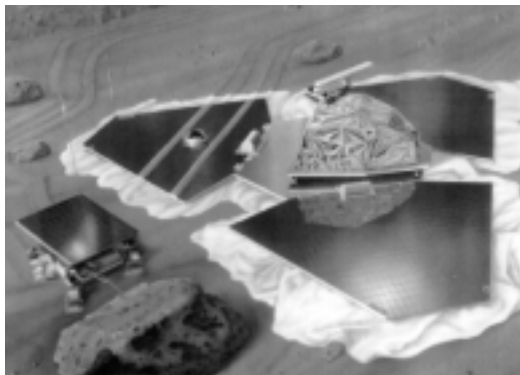

Figure 6.1. An artist's rendition of the Mars Pathfinder and Sojourner on Mars.

Pathfinder also carried temperature, pressure, and wind sensors. Temperature was measured by thin-wire *thermocouples* mounted on a mast that was deployed after landing. The thermocouples monitored atmospheric temperatures 25, 50, and 100 centimeters above the surface. Atmospheric pressures were measured by a mechanical sensor (basically an aneroid barometer) similar to the one used by Viking in the mid-1970's. Visit the Jet Propulsion Laboratory (JPL) web site (<http://www.jpl.nasa.gov>) for additional information on the instruments. With its instruments, the Pathfinder mission was able to investigate the structure of the Martian atmosphere, the weather and meteorology on the surface, the surface geology, and the form, structure, and composition of Martian rocks and soil.

The Martian atmosphere is made almost entirely of carbon dioxide (CO₂)—more than 95 percent. Because the weak Martian gravitational field has retained relatively few gas molecules, this tenuous atmosphere has a very low mass. On Earth, you would have to go about 13 kilometers above the surface to find an equivalent density and pressure. Keep the following points in mind when analyzing the temperature graph:

- The Mars Pathfinder landed at the height of summer in Mars' northern hemisphere (i.e., the Earth equivalent of mid-August) at a latitude of 19.3 degrees N, roughly the latitude of the Tropic of Cancer on Earth.
- The temperature never reached the melting point of ice, 273.16 kelvins.

The Kelvin scale begins at absolute zero, and 1 kelvin equals 1 degree celsius. Ice melts at 273.16 kelvins, and water boils at 373.16 kelvins.

- The steep slopes of the graph's temperature line show how quickly temperatures change in response to the available sunlight.
- The large daily temperature range suggests that the atmosphere is a poor insulator.
- The temperature spike on the first *sol* (a Martian day, 24.67 hours) occurred because the meteorological mast was not deployed until the afternoon of sol 1, so the thermocouples were positioned just above a solar panel. The dark panel absorbed sunlight and warmed the thermocouples.
- The gaps in data were caused by Pathfinder shutting itself down after sensing a problem. The problem turned out to be competition for memory. While the meteorological instruments were collecting data, the camera was panning the landing area, a memory-intensive task. Pathfinder sensed the overload, shut itself down, and reset itself. Each time, it took nearly 5 hours to resume data collection. Once engineers diagnosed the problem, they restricted meteorological data collection to 3:00–7:00 p.m. On sol 16, engineers sent a software "patch" that permitted data collection throughout the day.

The pressure at the Pathfinder landing site ranged from roughly 6.4–6.85 millibars during the first 30 sols. The pressure is close to the minimum at which liquid water can exist—6.13 millibars. Students can use the phase diagram to discuss how water would behave at these pressures. To boil at 6.4 millibars, water would need to warm to above 0.6 degrees celsius. Between zero and 0.6 degrees celsius, it would evaporate in the desiccated Martian atmosphere. Keep the following points in mind when analyzing the pressure graph:

- Pressure is temperature related. The pressures are highest around 6 a.m., when the atmosphere is at its coolest and densest. The pressures are lowest around 6 p.m., when the atmosphere is at its warmest and least dense.



- The pressure spike on sol 1 is not yet understood.
- The blips in the middle of the day are caused by thermal tides. The side of a planet facing the Sun warms, while the side away from the Sun cools. Thus, the temperatures and, by extension, the pressures are constantly changing on a rotating planet. On-shore and off-shore breezes along a coast are analogs of how changing temperatures can affect air pressure and the movement of air. The continuous changes between the warm and cool sides of the planet set up thermal tides that travel a planet much the way our ocean tides sweep across Earth. However, rather than being based on gravity, thermal tides are based on heat. Earth has similar blips, but, because of our considerable atmospheric pressure of around 1,013 millibars, they are far less noticeable.
- Pathfinder landed at the height of winter in the southern hemisphere. Because of the elliptical orbit of Mars, the southern winter is colder than the northern winter. Consequently, more CO₂ sublimates out of the atmosphere and onto the southern pole as frost during this time. This buildup of frost deprives the atmosphere of gaseous CO₂ molecules and decreases the planet's pressure. The pressure minimums around sol 20 are also the annual pressure minimums for the planet. As the southern hemisphere warms, the CO₂ frost will sublimate back into the atmosphere and raise the pressure. The graph shows this pressure increase beginning to happen. Martian pressures reach their maximums just after the solstices.

- Pressure reflects planetary trends, while temperature is a function of local factors, such as the color and nature of the area within a few hundred meters of the sensor.
- The decreasing range of daily pressures during sols 20–30 is not yet understood.

The Viking missions collected atmospheric data from 1976 to 1978. If students want to analyze long-term trends, look at seasonal variations, or study the impact of dust storms, have them obtain the Viking data from the atmospheric node of NASA's Planetary Data System (http://pds.jpl.nasa.gov/pds_home.html). They can also find the complete Pathfinder data sets at this node.

The virtual impossibility of water on Mars poses a perplexing dilemma—how to explain all the surface features that were apparently produced by flowing water. While most scientists embrace the idea that water flowed across the Martian surface, how long it flowed, the amounts that flowed, and the climatic conditions under which it flowed are still being debated. Images of channels, meanders, and eroded landforms on Mars strongly suggest flowing water. Step 4 of the “Procedure” below reinforces the idea of sustained, long-term flows by comparing two river-cut valleys on Earth with what seems to be a meandering river valley on Mars (Figure 6.2). The “Notes on the Images” provide a more complete discussion of the evidence for water on Mars.

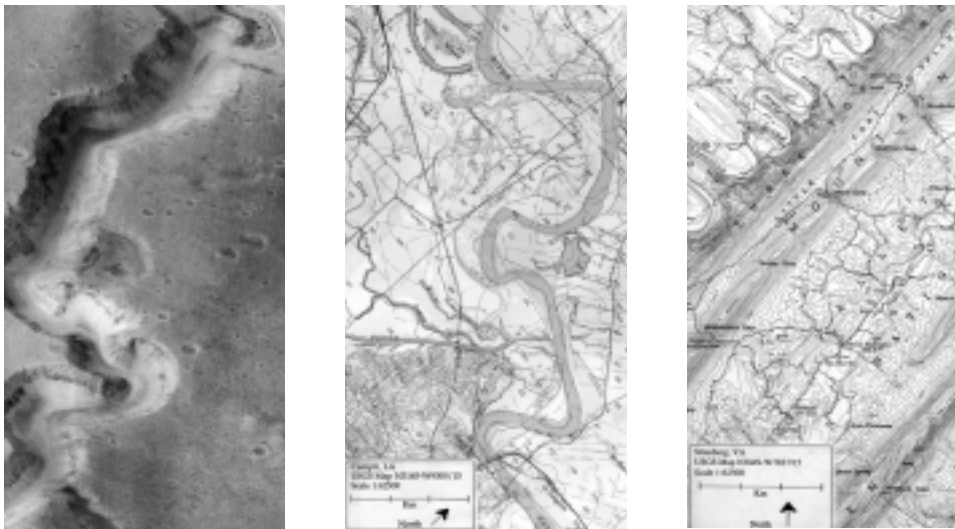

Figure 6.2. Nani Vallis on Mars shows similarities to river-cut valleys on Earth. See Images 11, 12, and 13 for a larger scaled view of these valleys.

Activity 6

Preassessment

(a) *Students Take a Position and Become Aware of Their Preconceptions:* Ask students:

- If a person visiting Mars gets hot in the noon sun and takes off his/her space suit, what will happen?
- What forms of water do you think might be found on Mars?
- What are some of the water-related features Mars Global Surveyor might see on Mars with its camera?

(b) *Students Expose Their Beliefs:* Have each student write down his or her prediction, sign his or her name, and hand it in to the teacher.

Procedure to Test Students' Preconceived Ideas

1. Distribute the temperature and pressure graphs based on data collected by Pathfinder. Have students consider questions such as:

- How many sols are represented on the graph?
- What is the temperature range? The pressure range?
- When are the temperatures and pressures at their highest? Lowest?
- How do the temperatures and pressures change over the course of the day?
- Do the patterns of temperature and pressure seem to be linked?
- What are the approximate maximum, minimum, and mean temperature and pressure levels?
- How do the maximum, minimum, and mean temperature and pressure levels on Earth and Mars compare?
- How does the variability of Martian temperature and pressure compare with the variability of temperature and pressures on Earth?
- At these pressures, what would the temperature have to be for liquid water to exist?
- At these temperatures, what would the pressure have to be for liquid water to exist?
- What would it take for liquid water to boil? Evaporate?
- Did Pathfinder ever measure temperatures or pressures that would enable liquid water to exist? If so, did the required temperatures and pressures occur at the same time? How long did these conditions last?

To find temperature and pressure data for places on Earth, consult the National Climate Data Center (<http://www.ncdc.noaa.gov/ol/ncdc.html>) and (1) select "Products," (2) scroll down and select "CLIMVIS Global and US," (3) click on the map for desired region, (4) select graph type and state or location from menu, (5) click on boxes to select the parameters and time period for which you want data, and (6) select "Submit Graph Values."

2. Have students look at images of Mars and describe what they see.

Features students might mention include:

- Ice caps
- Canyons
- Craters
- Volcanoes
- Meanders
- Fractures
- A dry surface
- Runoff channels

3. Have students examine Images 6 and 7 showing the area around Pathfinder's landing site. What processes have altered this region? Is there any evidence for water?

Scientists feel that vast floods flowed in this region. The evidence includes:

- Runoff channels
- Streamlined landforms
- Rounded boulders
- Craters with mud-flow-like ejecta blankets
- A smooth floodplain
- Scour marks and grooves in the channels



4. Have students compare Images 11, 12, and 13. How are the valleys on Mars and Earth alike and different? What conclusions can they draw about water on Mars based on this comparison?

Both canyons seem to show the effects of sustained water flow. For example:

- *Because runoff channels tend to be straight and shallow, the meanders and canyon depths suggest water flowing over a long period of time.*
- *The terraces and narrow channel suggest continual fluid flow and downcutting to produce such canyons.*
- *The walls of both canyons reveal layers. The meanders suggest that some layers are more resistant to erosion than others.*
- *As is typical with meandering rivers, there seem to be sediment deposits on the inside bends of the meanders. Such deposits are typical of continual, long-term flow. In addition, the channel seems to undercut the banks on the outer bends of the meanders. Undercutting is also typical of continual, long-term flow.*

5. By this point in the module, we know that we will not see evidence of liquid water on Mars, but we do! What must this mean? Ask student groups to develop two hypotheses that might explain the fact that water seems to have flowed across the Martian surface in the past, even though current conditions make it virtually impossible for liquid water to exist. Have them present their best idea to the class. Create a list of possible explanations on the board.

Below are several hypotheses scientists have developed to explain the apparent contradictions:

- *The atmosphere may have been denser at one time, making the pressure considerably higher.*
- *The temperature may have been considerably higher at one point.*
- *Massive amounts of water burst through the crust, and this water flow was enough to erode the surface before boiling off.*
- *The top of the flowing water froze in the cold Martian temperatures, forming a protective ice sheet that greatly slowed the boiling off of the water. The temporarily encapsulated water eroded the surface before it eventually boiled off or percolated into the surface.*

6. As a class, discuss how a planet's surface water could disappear. Ask what kinds of information students would like to have to be more sure of their answers.

Water can percolate into the ground, become chemically incorporated in minerals, exist as vapor in the atmosphere, become frozen in an ice cap, or be lost to space. Students might like to know whether the temperatures and pressures measured by Pathfinder were typical, what the surface is like, whether there is a lot of ice on Mars, how much water vapor is in the Martian atmosphere, and the past climate history of Mars. Activity 7 suggests a number of ways for students to gather additional information and to investigate their hypotheses. Question 6 could be assigned as homework.



Activity 6

MARS PATHFINDER LANDER Temperature at 0.25 meters height

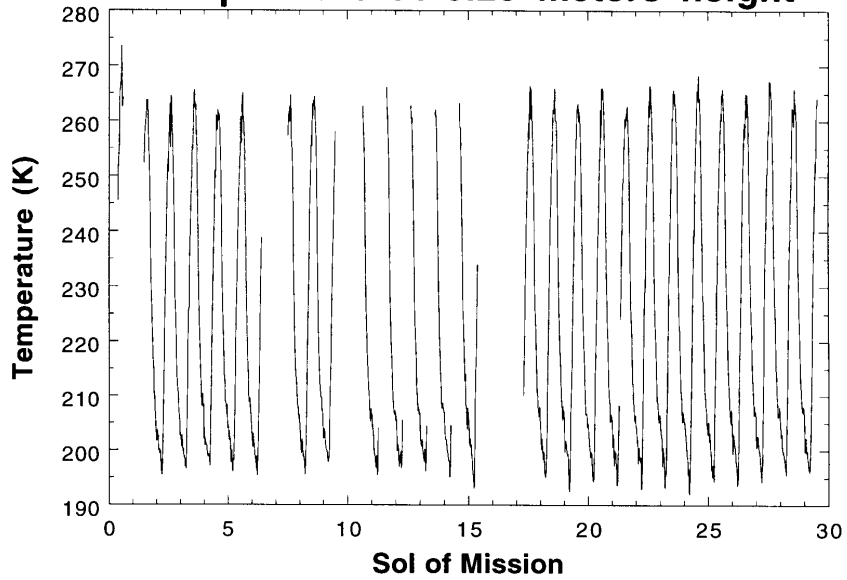

Courtesy of Dr. Jim Murphy, Mars Pathfinder ASI/MET Team

MARS PATHFINDER LANDER Surface Pressure

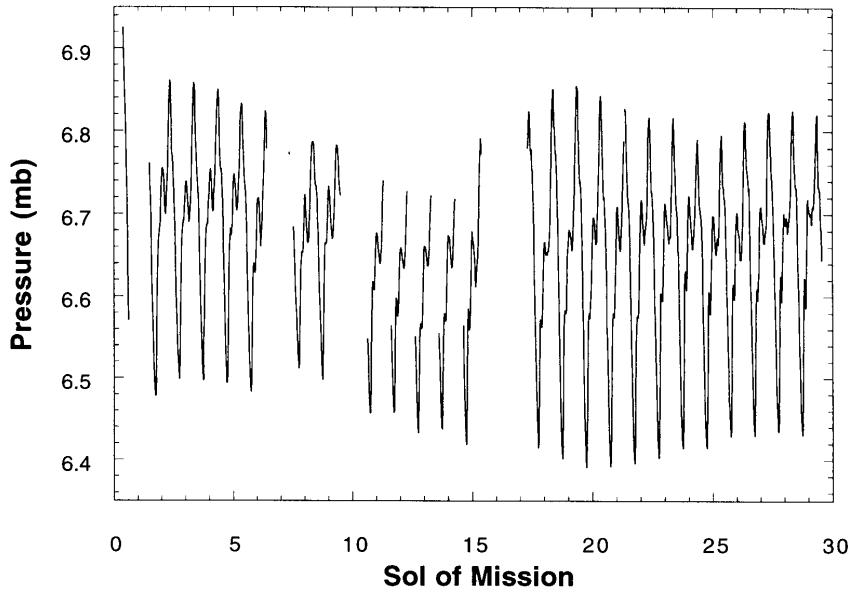

Courtesy of Dr. Jim Murphy, Mars Pathfinder ASI/MET Team



Where Would You Search for Water on Mars?

Purpose

To help students develop an ongoing connection to the Mars missions

Overview

Students generate questions based on their module experiences and pinpoint specific information they would like to obtain. They then read about the objectives and instrument payloads of the upcoming missions and see how these missions may provide data that can help them answer their questions. Finally, the students create a calendar for the missions and consider how they will access the information returned by the missions.

Key Concepts

- Each Mars mission has specific objectives and the instruments it needs to achieve them.
- Space missions arise out of questions people have about Mars, and students can generate questions worthy of future study.
- Every mission has a specific timetable, and students can follow the progress of each mission in a number of ways.

Context for This Activity

Over the next decade, NASA will be sending a series of spacecraft to Mars. In this activity, students see how they can access the information collected by these probes and how they can use this information to find out more about Mars and to answer their own questions.

Skills

- *Identifying* questions that really interest students
- *Devising* a plan for answering those questions

Materials

Calendar of the missions, length of paper to make a timeline

Preparation

If possible, obtain a computer with web access to visit some of the mission-related sites.

Time: 1 class period



Activity 7

Procedure

1. Have students reflect on their work with experiments and images and generate a list of questions of personal interest. What have they wondered about during the module? What struck them as particularly interesting? What additional information do they wish they had? Which features would they like to see in more detail? Why?
2. Have students read the essay on the upcoming missions.
3. Review the missions and the instruments (Figure 7.1). Which instrument(s) can help answer their questions about water on Mars? What instruments would they like to see on a future mission? Could they imagine themselves designing or operating such an instrument?
4. Show students the calendar for the missions (Figure 7.2). Ask them:
 - Where they expect they might be at these times
 - How might they access information from the instruments or about the mission (*newspapers, magazines, the Web, television, radio, friends*)

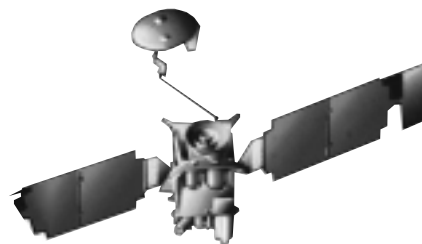

Figure 7.1. An artist's rendition of the Mars Global Surveyor.

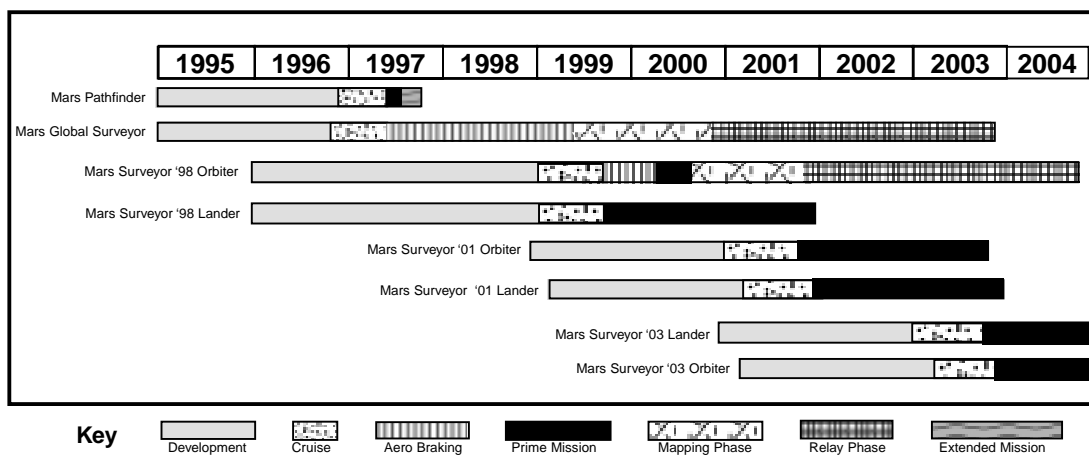

Figure 7.2. The timeline for NASA's missions to Mars.

5. Have each student devise a plan that outlines how he or she might obtain answers to his or her questions.
6. Put a timeline on the wall. Mark the events listed on the calendar to follow the progress of the missions.
7. Explain that NASA will regularly post data and images from its current missions on the World Wide Web. With these, your students can extend their study of Mars by following their own interests and building on their own questions.

To learn more about the Mars Exploration Program, explore the web pages in the box to the right.

Extension

Have each group write a rationale for sending a space mission to particular parts of Mars to help us better understand the history of water on Mars.

Spacelink	http://spacelink.nasa.gov
Jet Propulsion Laboratory	http://www.jpl.nasa.gov/
Mars Pathfinder	http://mpfwww.jpl.nasa.gov
Mars Global Surveyor	http://mgs-www.jpl.nasa.gov/
Mars Surveyor 1998	http://mars.jpl.nasa.gov/msp98/
Mars Surveyor 2001	http://mars.jpl.nasa.gov/2001/



How Can I Learn More About Mars? Where Do I Go From Here?

A spunky spacecraft about the size of a kitchen stove (Figure 7.3) recently left Earth forever and rocketed over to Earth's next-door neighbor, Mars. The 300-million-kilometer trip was short by space-travel standards, just 7 months. Because Pathfinder was small, scientists were limited in terms of the instruments they could send. They had to write detailed proposals to convince NASA that their instrument or experiment should be chosen over others and be one of the few sent to Mars. The competition was fierce. In the end, Pathfinder carried a microwave oven-sized rover, cameras, a spectrometer, and temperature, pressure, and wind sensors. Before its batteries ran down and it froze, Pathfinder collected data on:

- Structure of the Martian atmosphere
- Weather and meteorology on the surface
- Surface geology
- Form, structure, and composition of Martian rocks and soil

All these data help scientists understand more about the history of water on Mars and assess which of the current theories about water are valid.

To obtain more detailed maps of the Martian surface and a better understanding of surface features, NASA decided to send another spacecraft, the Mars Global Surveyor, to map

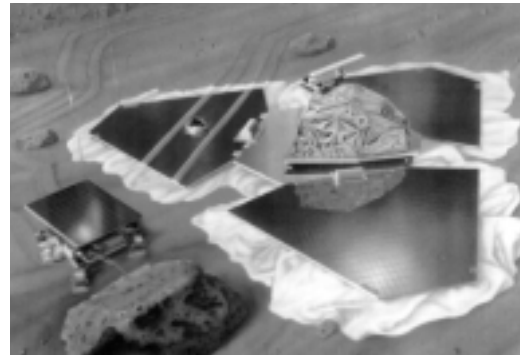

Figure 7.3. An artist's rendition of the Mars Pathfinder and Sojourner on Mars.

Mars (Figure 7.4). From its vantage point 400 kilometers above the Martian surface, the Mars Global Surveyor not only has a great view, but it has state-of-the-art instruments to analyze the surface in many different ways. Again, scientists competed fiercely to get their instruments included on the mission. The instruments include:

- Two low- and one high-resolution cameras to study daily changes and surface features
- A magnetometer/electron reflectometer to study the planet's magnetic field
- A radio system to study the planet's gravitational field and subsurface mass distribution

Prevailing Theory	Evidence	Upcoming Data
Water flowed across the Martian surface	<ul style="list-style-type: none"> • Large, runoff channels • Extensive river networks • Eroded landforms 	<ul style="list-style-type: none"> • High-resolution images of valley networks and small-scale features, such as boulders carried long distances by floods • Spectroscopy that can reveal the composition of rocks and sediments
Water pooled numerous times throughout Martian history	<ul style="list-style-type: none"> • Shorelines • Sediment layers 	<ul style="list-style-type: none"> • Closeups of shorelines and rock and sediment layers • Identification of hydrated minerals and deposits of rocks that are deposited in bodies of water (such as carbonates and tufa)
There is much water and/or ice below the surface	<ul style="list-style-type: none"> • Large channels lead from areas where magma heated the ground • Surface patterns formed by repeated freezing and thawing • Mud flows created by impacts that melted sub-surface ice 	<ul style="list-style-type: none"> • High-resolution images of active seeps, melted ice, temporary pools of water, talus slopes, pits, valleys, channels, patterned ground, and lobed ejecta blankets • Spectroscopy that can reveal the composition of rocks and sediments

Activity 7

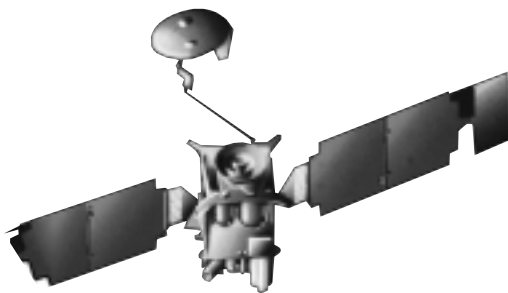

Figure 7.4. An artist's rendition of the Mars Global Surveyor.

- A laser altimeter to study the planet's surface topography and overall shape
- A thermal emission spectrometer to study the heat coming from the surface and atmosphere (This information will enable scientists to create weather maps and identify the size and composition of surface materials.)

Mars Global Surveyor has helped scientists understand more about the surface and subsurface geology. This information has helped them understand more about the history of water on Mars.

Particularly relevant to the study of water are the three cameras. The Mars Global Surveyor has two low-resolution cameras capable of recognizing features 500 meters across and one narrow-angle camera able to see things as small as 3 meters across (Figure 7.5). This compares to the highest resolution images from Viking of 20 meters. The low-resolution cameras will make daily maps of the entire planet, enabling scientists to see daily changes in such things as ice caps and dust and ice clouds. The narrow-angle camera, which can see boulders the size of cars, will be used to search for evidence of erosion, shorelines, glaciers, the effects of water seeping from canyon walls, and layers in polar deposits that reflect climate changes.

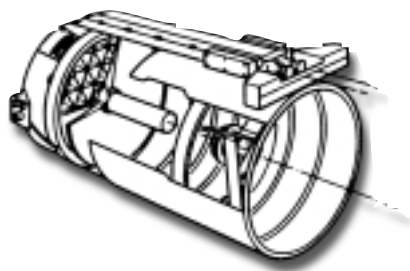

Figure 7.5. A camera from the Mars Global Surveyor mission.

The Thermal Emission Spectrometer measures the amount of heat coming from the surface and atmosphere at many different wavelengths (Figure 7.6). The spectrometer will determine:

- Atmospheric temperature and pressure at several different altitudes
- The concentration of dust both in layers and spread throughout the atmosphere
- The size of particles on the surface, from dust grains to bedrock, by comparing the temperature during the day with that observed at night (the same effect that causes beach sand to be very hot during the day and to be cool at night)—the sizes of particles on the surface tell scientists how the particles were moved (such as by wind water or other processes)

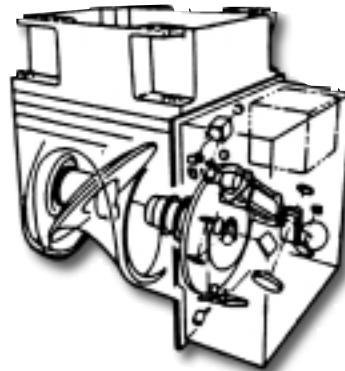

Figure 7.6. The Thermal Emission Spectrometer from the Mars Global Surveyor mission.

- Of what the Martian rocks, soil, and dust are made and in what proportions (The spectrometer will be able to discriminate volcanic rocks similar to those found in Hawaii (basaltic) from rocks and ash similar to those erupted by Mount St. Helens (rhyolitic). It will search for minerals left behind as possible lakes or other bodies of water dried up and for minerals that formed when the atmosphere was potentially thicker and wetter than it is today.)

Visit the Pathfinder and Global Surveyor web sites to learn about the missions, to access the data and images from the instruments, to see the kinds of conclusions scientists have been able to draw, and to discover the new questions emerging from the missions. You will find all sorts of information that will help you answer your questions and that may inspire you to undertake a research project to investigate these questions.



Activity 7

The Pathfinder and Global Surveyor missions are just the first two spacecraft in a series of missions to Mars. Every 2 years, Mars and Earth align so that a spacecraft can travel efficiently between the two planets. Over the next decade, NASA plans to launch new missions each time Earth and Mars are in a position for efficient travel (Figure 7.7):

- Mars Global Surveyor (1997)—The orbiter will map the planet's atmosphere and surface. It will look for evidence of surface water, study the surface geology and structure, and examine changes in Martian weather for at least 1 Martian year (about 2 Earth years).
- Mars Surveyor '98 (1998–99)—The lander will land near the edge of Mars' south polar cap and focus on studies of geology, weather, and past and present water resources. Before touchdown, it will release two micro-probes that will drop into the soil to search for the presence of subsurface water. The orbiter will examine the atmosphere and changes in water vapor during the Martian seasons.

- Mars Surveyor '01 (2001)—The lander will carry a rover capable of traveling dozens of kilometers to gather surface dust and soil samples. There will also be a test of our ability to produce rocket propellant using Martian rocks and soil as raw materials. The orbiter will study the mineralogy and chemistry of the surface, including the identification of water resources just below the Martian surface.
- Mars Surveyor '03 (2003)—This lander will carry a wide-ranging rover to collect samples from a different part of the planet. The orbiter will provide the complex links needed for communication and navigation for this and future surface missions.

NASA scientists are waiting to see what this current set of missions will reveal about Mars before deciding where to send the 2005 and 2007 missions and what data they should collect.

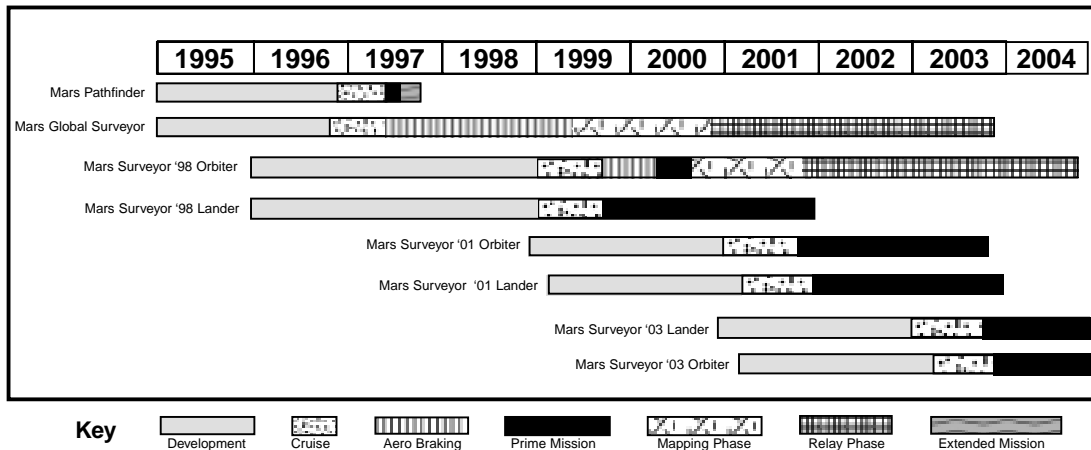

Figure 7.7. The timeline for NASA's missions to Mars.



- A. Why Is Water a Priority for Mars Exploration?**
- B. What Is So Special About Water?**
- C. What Is Distinctive About the Module Series?**
- D. The Scientific Research Techniques Used in Each Module**
- E. Glossary**
- F. Resources for Educators Interested in Mars**
- G. Background Information on the Images in the Image Set**
- H. Image Set A: 15 High-Contrast Images**
- I. Image Set B: The Same 15 Images Processed So That, on a Photocopier, They Reproduce Better Than the High-Contrast Versions**



Why Is Water a Priority for Mars Exploration?

Studying water on Mars gives scientists insights into how planets evolve, how water accumulates, how climates develop, and, possibly, how life begins. For these reasons, understanding the story of water is central to most of NASA's planetary missions.

Scientists believe that 3.5 billion years ago, Mars experienced the largest known floods in the solar system. This water may even have pooled into lakes or shallow oceans. Knowing where this water came from, how long it lasted, and where it went will reveal much about the past history of the planet. Consequently, many scientists who want to understand the history of Mars need to understand the story of water on Mars.

To try to account for this water, the scientific community is debating whether the climate of Mars has slowly changed over time or whether it has remained the same for the last several billion years. The two positions lead to two very different views of the planet and of life and water on Mars:

- If Mars has always had the climate we find today, huge quantities of water must have been released over a short period of time to create the water-related landforms found on the surface, many of which require significant amounts of water to form. These great quantities of water would have to have shaped the surface quickly, before evaporating or boiling away. Also, life would not have had a chance to evolve in such short-lived bodies of water.
- If Mars once had a warmer, wetter climate, water could have existed over a long period of time, altered the surface gradually, and allowed for the possible formation of life.

These different water scenarios give rise to different views of the planet's evolution. Regardless of whether water existed for long or short periods of time, it probably escaped into space and/or sank into the ground to become permafrost.

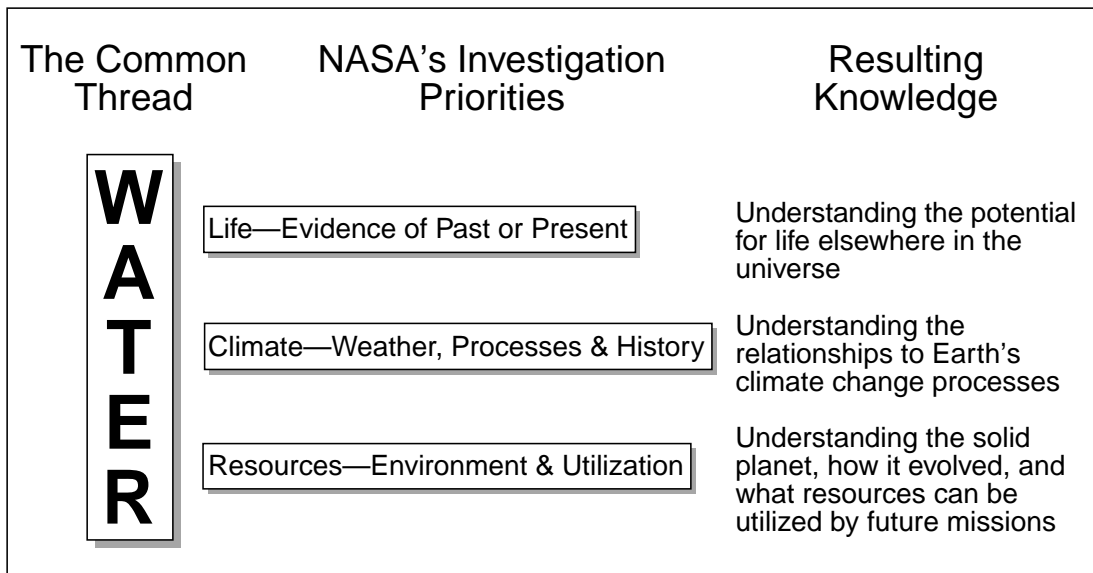

What Is So Special About Water?

Water is critical to so many biologic and physical processes that it is one of the first things planetary scientists look for when they study planets and planetary

bodies, such as moons and asteroids. Water's unique properties make it an important compound in a number of ways.

Property	Attribute Because of This Property	Examples
Bi-polar molecule	Superior solvent of ionic compounds	<ul style="list-style-type: none"> • Diffuses across cell membranes to deliver nutrients and to remove wastes • Dissolves many surface materials
Forms hydrogen bonds	Chemically active molecule	<ul style="list-style-type: none"> • Exhibits surface tension (cohesion) • Exhibits capillary action (adhesion) • Present in many classes of compounds
High-density liquid	Exerts force and distributes pressure	<ul style="list-style-type: none"> • Provides organisms mobility and buoyancy • Erodes and transports surface materials
High specific heat capacity	Stores large amounts of heat	<ul style="list-style-type: none"> • Moderates climates on Earth • Moderates daily temperature swings • Moves equatorial heat toward the poles
Expands upon freezing	Ice is less dense than water	<ul style="list-style-type: none"> • Ice floats on water and protects organisms below the ice from colder temperatures • Water expands upon freezing and cracks rocks and minerals through physically weathering
Relatively low vapor pressure given its molecular weight	Changes phase within a moderately narrow temperature range	<ul style="list-style-type: none"> • Exists in all three states on Earth • Enables a water cycle that moves water through the environment • Enables cooling through evaporation
Molecule resonates at a number of frequencies	Absorbs wavelengths such as ultraviolet and infrared	<ul style="list-style-type: none"> • Liquid water shields aquatic organisms • Water vapor shields land organisms • Acts as a greenhouse gas
Contains hydrogen and oxygen	Electrolysis can separate these elements	<ul style="list-style-type: none"> • Possible fuel source for Earth-returning missions



What Is Distinctive About the Module Series?

Brings Science Topics to Life in an Engaging, Relevant Way

Students not only learn about Mars, Earth science, astronomy, chemistry, biology, physics, engineering, and geography, but they also develop and hone their science thinking skills, such as designing experiments, devising models, analyzing data, developing and refining hypotheses, and applying their understanding to real-world situations.

Provides Multiple Paths to Investigate a Topic

In the module activities, students use experimentation, modeling, Mars-Earth comparisons, and image analysis to amass evidence to support their ideas.

Promotes Student Ownership of the Investigative Process

Because the mastery of fundamental science concepts is dramatically enhanced when students feel ownership for their work, the activities directly involve students in the intellectual process going on in the classroom.

Builds a Foundation for Understanding Data from Mars

NASA is using the Internet to provide the public with the latest images and data from its missions to Mars. To



help prepare students to make effective use of this information, the modules provide students background experiences, such as analyzing data and images, knowing NASA's key research questions, understanding the missions, and recognizing Martian features. Having well-prepared students opens a new chapter in the way students can participate in ongoing research.

Gives Students a Stake in the Missions

Mars exploration is at its beginning. The competing explanations within the scientific community and the gaps in the existing evidence leave plenty of room for students to develop their own hypotheses. Students can use evidence from their own investigations to take positions on a particular question, debate the alternate hypotheses, and refine their own thinking about the planet.

Helps Transform Science Education

The educator guide provides detailed, standards-based, hands-on activities that promote inquiry-based learning and address student misconceptions. The teaching strategies and assessments provide guidance for teachers unfamiliar with student-centered teaching.

Implements National Science Education Standards

The module series develops skills and understanding by responding to many of the National Science Education Standards' recommendations for science teaching, professional development, assessment, and content. The series can help schools implement these standards in a creative, innovative, and multifaceted program.

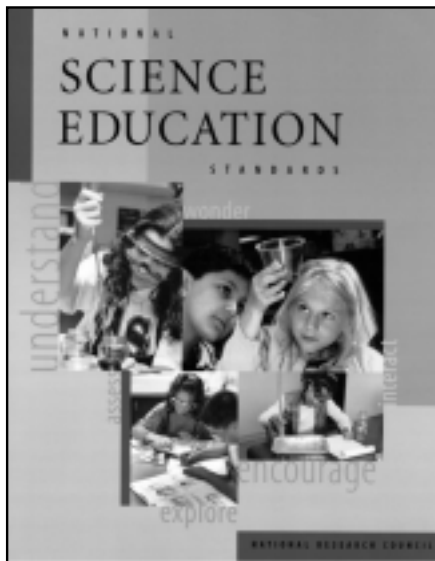

The Scientific Research Techniques Used in the Modules

Each module is designed around a question that is examined through four different investigative paths—experimentation, modeling, Mars-Earth comparisons, and image and data interpretation. Each path sheds light on a different aspect of the question. Students piece together the evidence to develop hypotheses, debate and refine their thinking, and address their misconceptions.

Conducting Classroom Experiments and Creating Models

Students conduct hands-on experiments to generate data and model processes that occur on Earth and Mars. These inquiry-based experiences build understanding and lay the conceptual and experiential base for subsequent activities.

Making Mars/Earth Comparisons

Mars-Earth comparisons help students bridge the gap from a local, familiar environment on Earth to distant Mars.

Using Real Data and Images from Mars

The modules' image sets provide students with maps and photos of the surface of Mars. Many activities are based on these images, and the students use them to provide clues for their investigations. NASA also makes many of its data and images from current and previous missions available over the Internet. By obtaining the latest data and images, students can experience the excitement of scientific exploration and discovery as they happen.

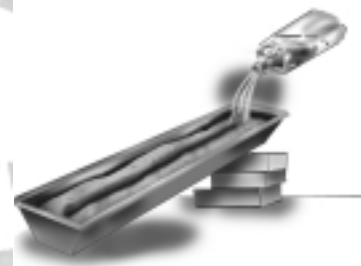
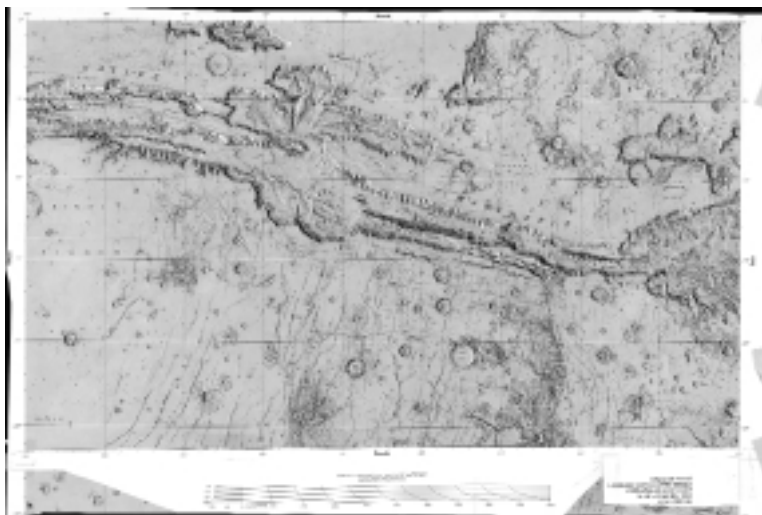
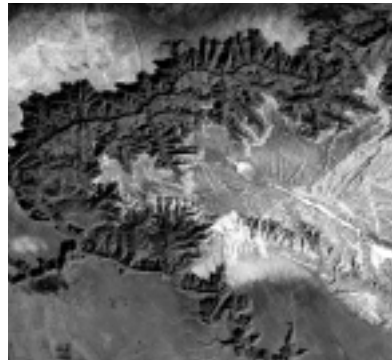
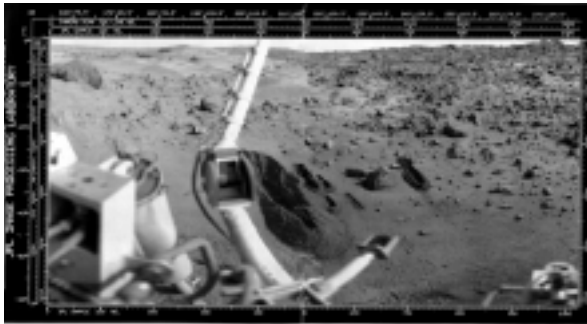

Glossary

Atmospheric Pressure	The force produced by the gas molecules in the atmosphere. Atmospheric pressure is a function of the height and density of the atmosphere in conjunction with a planet's gravitational field. At sea level, Earth's atmosphere pushes with a force of 1,013 millibars. On Mars, surface pressures are typically in the range of 6.8 millibars.
Barometer	A device with an enclosed volume of air that measures changes in air pressure. As pressure changes, the enclosed air either increases or decreases, depending on the pressure gradient between the room air and the trapped air. An arm on the barometer displays this change.
Boiling Point	Boiling is when the vapor pressure of the liquid equals the atmospheric pressure. At this point, the liquid can turn to vapor. The bubbles one sees are bubbles of water vapor. They arise from the bottom of a pot because this is usually where the heat is concentrated and where the particles have the most kinetic energy.
Boyle's Law	A gas law described by Robert Boyle in 1662 that states when the volume of a given mass of gas increases, its pressure decreases, provided that the temperature remains constant.
Equilibrium	When the rate of molecules leaving a particular phase equals the number returning. For example, water is in equilibrium with ice when it freezes at the same rate that the ice melts. It is in equilibrium with water vapor when it evaporates at the same rate that the vapor condenses.
Kinetic Energy	The internal energy of an atom or molecule often thought of as the vibrational energy of a particle. Higher kinetic energies translate into higher temperatures.
Mars Global Surveyor	An orbiter launched in November 1996 to map the Martian atmosphere and surface. The data it collects are used to look for evidence of surface water, study the surface geology and structure, and examine changes in Martian weather for at least 1 Martian year (about 2 Earth years).
Mars Pathfinder	A lander launched in December 1996 that contained the radio link to Earth, most of the science instruments, and a rover named Sojourner. Sojourner was used to deploy two imagers and an instrument that could determine the composition of rocks and minerals on the surface.
Meander	A bend in a river caused by the erosion of the bank along the outer edge of the bend and the deposit of sediment along the inner bend of the curve. Meanders occur in mature, slow-flowing rivers.
Phase Change Diagram (also called Phase Diagram)	Researchers have measured the phase changes of water over a wide variety of temperatures and pressures. The resulting graph is called a phase change diagram. Every substance has its own, unique phase diagram.
Phase Change Plateau (also called Change of State Plateau)	When melting or boiling, any heat added is absorbed by the particles changing state. The particles use the energy from the heat source to gain the extra kinetic energy required to change state and to maintain themselves in the new state. As a result, the temperature during these transitions never changes. On a graph, these transitions graph as plateaus. When condensing or freezing, particles give off heat, and there is a similar transition plateau.



Appendix E

Sol	One Martian day, 24.67 hours long.
Sublimation	A change from the solid phase directly to the vapor phase.
Thermocouple	A device that measures temperature by measuring how the resistance to electrical flow changes with temperature.
Triple Point	At the triple point, all three phases are in equilibrium with one another—vapor sublimates to ice and condenses to liquid at the same rate that the liquid evaporates to vapor and freezes to ice at the same rate that the ice melts to liquid and sublimates to vapor.
Vapor Pressure	The inclination of a molecule to change phase and establish an equilibrium. Vapor pressure changes with temperature—the higher the temperature, the higher the vapor pressure.
Viking Missions	A series of two missions, each with a lander and an orbiter. These missions studied Mars from 1976 to 1978. Viking was the first mission to land on Mars.



Resources for Educators Interested in Mars

Web Sites

Spacelink	http://spacelink.nasa.gov	Mars Surveyor '01	http://mars.jpl.nasa.gov/2001/
Jet Propulsion Laboratory	http://www.jpl.nasa.gov/	The Planetary Society	http://planetary.org/tps/
Mars Pathfinder	http://mpfwww.jpl.nasa.gov	Center for Mars Exploration	http://cmex-www.arc.nasa.gov/
Mars Global Surveyor	http://mgs-www.jpl.nasa.gov/	Arizona Mars K-12	
Mars Surveyor '98	http://mars.jpl.nasa.gov/msp98/	Education Program	http://esther.la.asu.edu/asu_tes/

Periodicals

<i>The Planetary Report</i>	<i>Mars Underground News</i>
The Planetary Society	The Planetary Society
65 North Catalina Avenue	65 North Catalina Avenue
Pasadena, CA 91106-2301	Pasadena, CA 91106-2301
Phone: (818) 793-5100	Phone: (818) 793-5100
Fax: (818) 793-5528	Fax: (818) 793-5528

Recommended Maps and Photomosaics of Selected Martian Features

General

Map of Olympus Mons to Ares Valles	I-1618
Map of Eastern Valles Marineris to Ares Valles	I-1448
Topographic Map of Mars (1:25,000,000) (1 map)	I-961
Topographic Map of Mars (1:15,000,000) (3 maps)	I-2160

Volcanoes

Photomosaic of Olympus Mons	I-1379
Map and photomosaic of Tharsis volcanoes	I-1922

Canyons

Map of Central Valles Marineris	I-1253
Photomosaic of entire Valles Marineris	I-1206, I-1207, I-1208, I-1184, I-1381

Floods

Photomosaic of channels and eroded landforms	I-1652
Photomosaic of Dromore crater with breached ridge	I-1068

Pathfinder

Map of Ares Valles	I-1551
Photomosaic of the flood channels near landing site	I-1343
Closeup photomosaic of landing site	I-1345, I-2311
U.S. Geological Survey (\$4.00, 3- to 4-week turnaround)	
Box 25286	
Federal Center, Building 810	
Denver, CO 80225	
Phone: (800) 435-7627	

Posters

Two Faces of Mars (Item #1338, \$15.00)

Spaceshots
33950 Barnaby Road
Acton, CA 93510
Phone: (800) 272-2779
Fax: (805) 268-1653

An Explorer's Guide to Mars (Item #505, \$6.00)

The Planetary Society
65 North Catalina Avenue
Pasadena, CA 91106-2301
Phone: (818) 793-1675
Fax: (800) 966-7827



Background Information on the Images in the Image Set

Image 1

This image shows Mars as if you were viewing it from 2,500 kilometers above the surface. It is a mosaic of 102 images taken by Viking I in 1976. This view shows some large impact craters, volcanoes, and Valles Marineris, a huge 4,800-kilometer canyon (across the middle of the photograph). The volcanoes are the three round spots on the left. Each one is 25 kilometers tall and about 350 kilometers in diameter. In this view, the two Martian polar caps are not apparent.

Sample Questions

- What is the feature across the middle?
- What do you think the circles on the left side are?

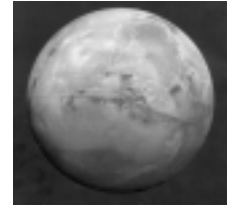

Image 1. Mars hemisphere.

Image 2

From 18,000 kilometers away and at an orbital height of about 1,500 kilometers, Viking I took this image of the sky above the *Argyre Planitia* (that is, the Argyre Plain). Of special interest are the light-colored bands above the horizon. Dust from a dust storm creates a haze in the atmosphere 25–30 kilometers above the planet's surface. This view emphasizes the shallowness of the Martian atmosphere. (47S, 22W, Viking Orbiter Image 34A13)

Sample Questions

- What is the line on the horizon above the Martian surface?
- How high above the surface is it?
- What causes it to be visible?

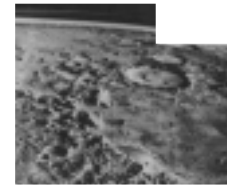

Image 2. View of the thin Martian atmosphere.

Image 3

The surface of Mars has volcanoes, none of which are active. These two shield volcanoes formed as low-viscosity basaltic lava flowed from a central vent. The larger one is 6 kilometers tall, 90 by 130 kilometers in diameter, with a slope of 7 degrees. The smaller one is 3.5 kilometers tall, 60 kilometers in diameter, with a slope of 5 degrees. They are among the steepest volcanoes on Mars. On both volcanoes, note the lava channels and the impact craters. The long, straight fractures on the left formed when the Martian surface in this region bulged upward. (25N, 95W, Viking Orbiter Photomosaic 211-5593)

Sample Questions

- Which came first, the volcano or the impact craters? How can you tell?
- What might have caused the channels on the side of the volcanoes?
- What are the lines in this image? What might have caused them?

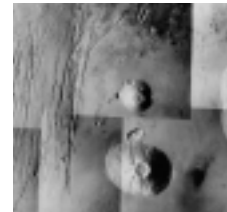

Image 3. Martian volcanoes and fault lines.

Image 4

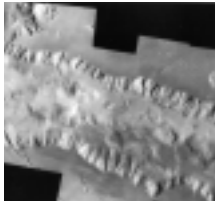

Image 4. A section of the Candor Chasm of Valles Marineris.

Mars has many canyons, and your students can learn more about them in other modules in the series. This image shows a 100-kilometer-wide by 8-kilometer-deep section of the Candor Chasm of Valles Marineris. Valles Marineris is a huge rift valley roughly as long as the United States. Numerous landslides have eroded its edges and widened it. (25N, 95W, Viking Orbiter Frame P40381)

Sample Questions

- What do you think caused the valley?
- What do you think shaped the cliffs on the edges of the canyon?
- How did this canyon get so wide?

Image 5



Image 5. Landforms at the mouth of the Kasei Vallis.

This image shows a rich diversity of geological processes. There are fractured, ridged plains (top center), craters as big as 100 kilometers (several have been severely degraded), lobed ejecta blankets, an enormous channel, and wind streaks (going in the opposite direction of the former water flow). (27N, 58W, courtesy of Arizona State University's Planetary Geology Group)

Sample Questions

- Which came first, the fractures or the large crater in the center left?
- Which came first, the crater in the bottom center or the channel?
- Which direction did the fluid flow? Is any fluid apparent now?
- What caused the "tails" behind the small craters in the channel?
- What sequence of events and processes makes most sense in explaining all these features?

Image 6



Image 6. Closeup view of Pathfinder's landing site at the mouth of the Ares Vallis.

This image shows the area around Pathfinder's landing site (19.35N, 33.55W). Although there is currently no liquid water on Mars, the landforms strongly suggest that water flowed in an earlier stage of Mars' history. Note the landforms sculpted by flowing water (suggesting that large-scale floods swept this region), a smooth outwash plain (good for a safe landing and full of sediments from upstream), and impact craters with mud-flow-like ejecta blankets (suggesting water or ice-rich surface layers, an idea consistent with flooding). (USGS Photomosaic I-1345)

Sample Questions

- What do you notice about this region?
- How might the teardrop-shaped landforms have formed?
- What might make this region a desirable landing site?
- Do you see anything that might make this an interesting area to explore?

Image 7

This image highlights many of the region's interesting features. Channels descend 2 to 3 kilometers from a plateau that surrounds most of the low-lying Chryse Planitia. Many channels emanate from rough-looking depressions. These are *chaotic terrain*, a unique Martian feature that formed when large areas of permafrost melted, causing the surface to collapse. The numerous areas of chaotic terrain and the many channels suggest that flowing water was a regional phenomenon. As water flowed downhill, it crossed many different types of terrain and carried sediments from the highlands. The possibility of finding sediments from many rock types at the mouth of this channel made Pathfinder's landing site exceptionally valuable to scientists wanting to learn more about the geology and hydrology of Mars. While there are many lobed ejecta blankets in the Chryse Planitia, there are none in the highlands. Because lobed ejecta blankets occur only in water or ice-rich areas, the highlands must have been drier than the plain at the times of impact. Also, the highlands are heavily cratered, while the Chryse Planitia is relatively free of craters. Our solar system experienced a period of heavy bombardment by asteroids 3 billion years ago. This bombardment created most of the craters on Mars, so the floods that obliterated the Chryse Planitia's craters must have occurred after that time. (Detail from USGS Map I-1448)

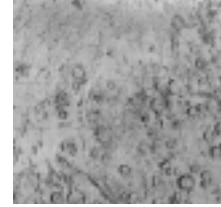

Image 7. Regional map of the Ares Vallis.

Sample Questions

- How big is this area?
- What is the general topography of this region? Which direction is uphill?
- How much water flowed in this region, a little or a lot?
- From where might the water that flowed in these channels have come?
- Why is the area at the end of the channel so smooth? (*It is a floodplain covered with sediment.*)
- What do you think the Chryse Planitia looked like when water flowed in the channels?
- Describe the distribution of craters in this region.
- What might explain this pattern of distribution?
- What are some differences between the craters on the plain and in the highlands?
- What might explain the differences between the craters in these two areas?

Image 8

This image was made on Pathfinder's fourth day. "Twin Peaks," the two hills about 1 kilometer away from the landing site, are of great interest to scientists. Sections of the hills look stratified, and white areas on the left hill (nicknamed the "Ski Run") may represent a high-water mark from one of the floods that swept this area. The jumbled boulders in the foreground probably were carried from upper portions of the Ares Vallis by ice or water. Sojourner used its Alpha Proton X-ray Spectrometer to determine the mineral composition of rocks and soil around the landing site.

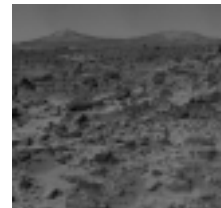

Image 8. The view from Pathfinder toward Twin Peaks

Sample Questions

- Does this look like any place on Earth?
- Why did the landing site look so smooth when it is really full of boulders?
- What are some ways a plain such as this can become littered with rocks?

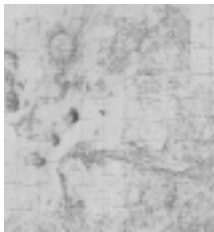

Image 9. Valles Marineris and the surrounding region.

Image 9

This map shows some of Mars' most prominent features. Olympus Mons, the left-most volcano, is the largest volcano in the solar system at about 27 kilometers high and more than 600 kilometers across at the base. Valles Marineris is the largest canyon in the solar system. It is a system of rift valleys that together stretch more than 5,000 kilometers in length. A 30 million square kilometer section of the Martian surface bulges nearly 11 kilometers. This bulge is centered on the western end of Valles Marineris and may have formed when magma rose from deep within the planet, causing the lithosphere to dome upward and fracture. One can see many fractures radiating radially from the bulge. The many volcanoes in this region attest to the existence of an active magma chamber at one time. The smooth-looking surface around the volcanoes was caused when lava flows covered the surface that scientists believe was once as heavily cratered as the surface in the bottom right of the map. On the eastern end of Vallis Marineris, channels flow from areas of chaotic terrain in the highlands onto the Chryse Planitia. Both the 1976 Viking I and the 1998 Pathfinder missions landed in the Chryse Planitia. (USGS Map I-1618)



Image 10. The Ophir Chasma.

Image 10

The Ophir Chasma is one of the northern-most canyons of Valles Marineris. It is approximately 125 kilometers wide and 325 kilometers long, and the walls are about 5 kilometers tall. The plateau at the top of the canyon is probably a thick deposit of lava, and the resistant rock layers form steep cliffs at the upper edges of the canyon. These cliffs are vulnerable to landslides, and, indeed, numerous landslides have widened the canyon. (USGS Photomosaic I-1592)

Sample Questions

- What processes have affected this canyon?
- Why might the plateau be so smooth?

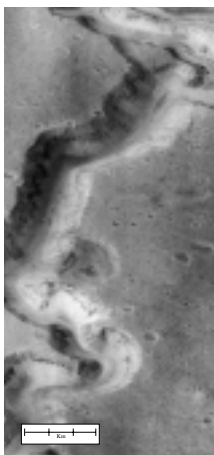

Image 11. The Nanedi Vallis.

Image 11

The Mars Global Surveyor took this image of the Nanedi Vallis, one of the Martian valley systems cutting through cratered plains in the Xanthe Terra region of Mars. The picture covers an area 9.8 by 18.5 kilometers, and features as small as 12 meters can be seen. The canyon is about 2.5 kilometers wide. You can see rocky outcrops along the upper canyon walls and weathered debris on the lower canyon slopes and along the canyon floor. The origin of this canyon is enigmatic: some features, such as terraces within the canyon (near the top of the frame) and the small 200-meter-wide channel (also near the top of the frame) suggest continual fluid flow and down-cutting. Other features, such as the lack of a contributing pattern of smaller channels on the surface surrounding the canyon, box-headed tributaries, and the size and tightness of the apparent meanders, suggest formation by collapse. It is likely that both continual flow and collapse have been responsible for the canyon as it now appears. Further observations, especially in areas west of the present image, will be used to help separate the relative effects of these and other potential formation and modification processes. (These notes are courtesy of Malin Space Science Systems. Image available on NASA's Planetary Photojournal, http://photojournal.jpl.nasa.gov/cgi-bin/PIA_GenCatalogPage.pl?PIA01170)

Sample Questions

- What processes have affected this canyon?
- What evidence is there for the idea that water flowed here?
- What evidence is there against the idea that water flowed here?

Image 12

The Red River of Louisiana is a tributary of the Mississippi River. It meanders over a broad floodplain bordered by higher, more rugged uplands. Notice that the river undercuts the valley walls just north of Grand Ecore (near the upper right corner of the legend). Undercutting happens because inertia carries most of the water to the outside of the curve. Conversely, sand bars (shown by dotted lines) form on the inside of river curves because the slowness of the current on the inside of a curve permits the deposition of sand by the river. The several oxbow lakes formed when the Red River cut through the land, originally creating the meander, thus isolating the former river bend. The Nanedi Vallis on Mars (Image 11) is quite similar to the Red River in that it, too, has a narrow river carving a wide valley, meanders, two oxbow lakes in the early stages of formation, undercut rocky ledges, and sandbars on the inside of the bends. Such interplanetary comparisons support the view that, at one time, Mars had a climate that could support the long-term flow of water. (Detail of USGS Map 3200N9315W/15)

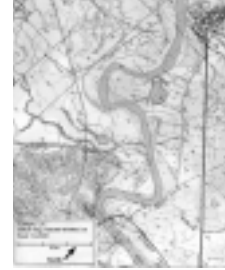

Image 12. Oxbows and meanders of the Red River in Campti, Louisiana.

Sample Questions

- How are the two banks different as the river goes around a bend?
- How did the oxbow lakes form?
- How does the Red River compare with the Nanedi canyon?

Image 13

This image exhibits many of the same features seen in Image 12. However, these rivers wind through a mountainous terrain and change direction each time they meet a significant obstacle, such as a mountain side. Again, students can see how a river undercuts the banks on the outside of a curve and deposits sediments on the inside of the curve. They can also speculate on the fate of the hills separating one meander from the next. At some point, the river will erode these hills and cut through them to create islands. Ultimately, oxbows will form. It has taken eons for these rivers to develop their meanders. They probably started as straight runoff channels. As they eroded the land, they took on the meandering shape characteristic of mature rivers. The shapes of river beds and river valleys give scientists an idea of how long water has flowed over an area. Because the Nanedi Vallis meanders and is quite deep, water must have flowed for a long time. (Detail of USGS Map 3849N7827W/15)

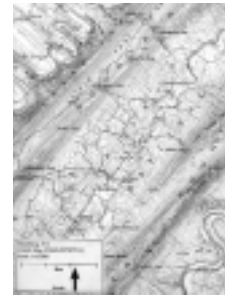

Image 13. Meanders of the North and South Branches of the Shenandoah River in Strasburg, Virginia.

Sample Questions

- How do the valleys carved by the Shenandoah and Red Rivers compare to the Nanedi Vallis?
- How long might it take for a river to form a valley of this size?
- On which side of each sharp turn is the bank steeper?
- What factors might influence how quickly a valley forms?

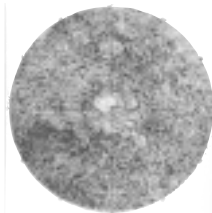

Image 14. The Martian South Pole.



Image 15. The Martian North Pole.

Images 14 and 15

Because of Mars's elliptical orbit, the southern winter is colder than the northern winter, and the south pole is composed primarily of solid carbon dioxide (that is, dry ice). By contrast, the north pole is primarily water ice and is considered a reservoir of considerable amounts of Martian water. Scientists know this because they see the south pole get smaller during its summer at temperatures far below the melting point of water. The north pole remains a constant size, even though its temperature is above that needed for dry ice to sublimate. The spiraling is thought to be caused by differential melting—slopes facing the Sun melt and retreat, while ice and dry ice accumulate on the slopes facing away from the Sun. (USGS Map I-961)

Sample Questions

- How might one tell whether the poles are covered with water ice or dry ice?
- What might cause the spiraling shape of the poles?

Image Set A: High-Contrast Images

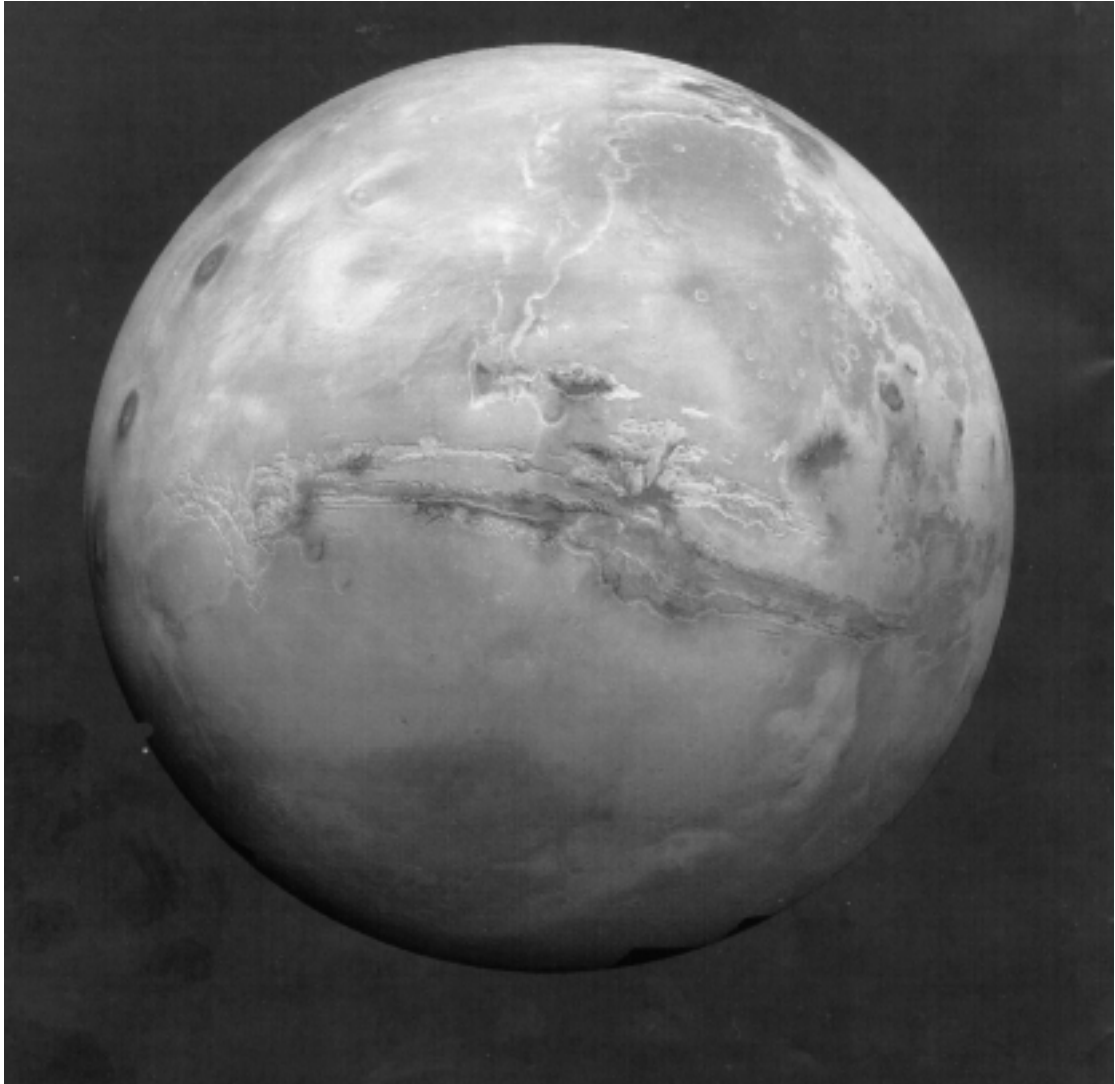

Image 1. Mars hemisphere. Scale: Mars is 6,787 km in diameter.

Image 1 Questions

- What is the feature across the middle?
- What do you think the circles on the left side are?

Appendix H



Image 2. A view across the Argyre Planitia. Scale: The large crater in the upper right is about 200 km in diameter.

Image 2 Questions

- What is the line on the horizon above the Martian surface?
- How high above the surface is it?
- What causes it to be visible?



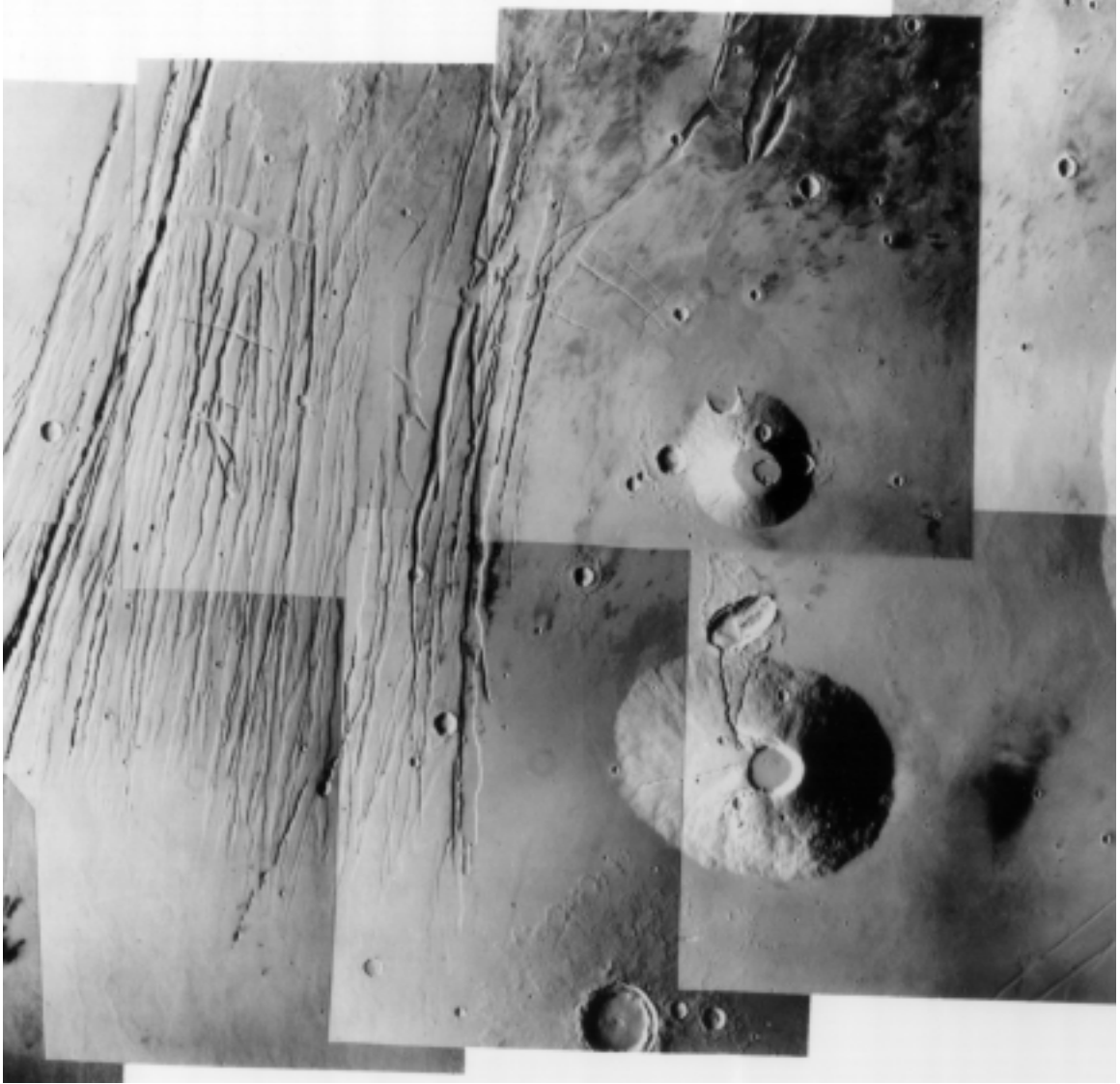

Image 3. Martian volcanoes and fault lines. Scale: The lower volcano is 90 by 130 km.

Image 3 Questions

- Which came first, the volcano or the impact craters? How can you tell?
- What might have caused the channels on the side of the volcanoes?
- What are the lines in this image? What might have caused them?

Appendix H

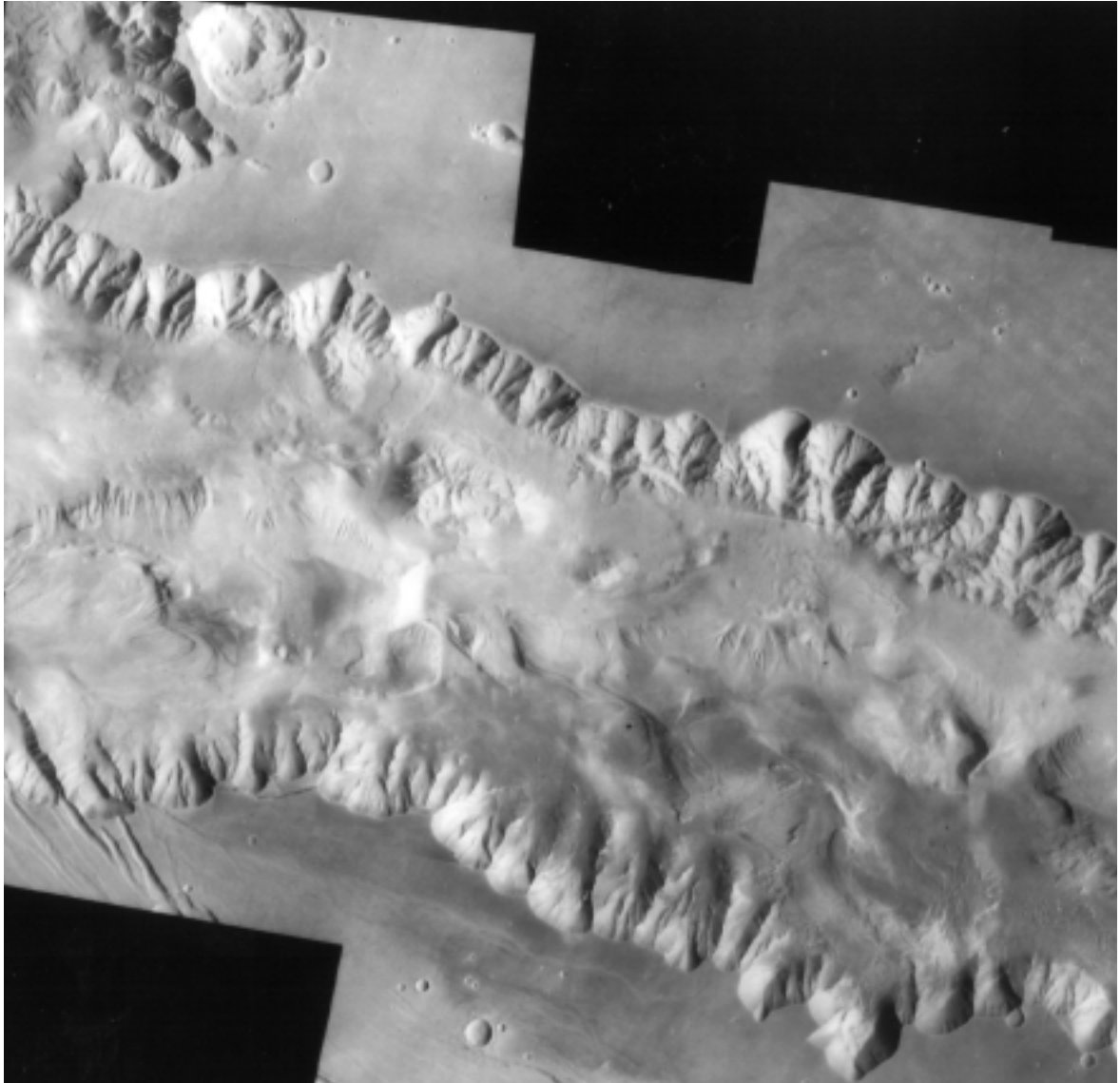

Image 4. A section of the Candor Chasm. Scale: This section is about 125 km wide and 8 km deep.

Image 4 Questions

- What do you think caused the valley?
- What do you think shaped the cliffs on the edges of the canyon?
- How did this canyon get so wide?





Image 5. Landform at the mouth of the Kasei Vallis. Scale: The crater in the lower right is about 100 km across.

Image 5 Questions

- Explain which came first, the fractures or the large crater in the center left?
- Which came first, the crater in the bottom center or the channel?
- Which direction did the fluid flow? Is any fluid apparent now?
- What caused the “tails” behind the small craters in the channel?
- What sequence of events and processes makes most sense in explaining all these features?

Appendix H



Image 6. *Pathfinder's landing site at the mouth of the Ares Vallis. Scale: The dark crater near the center is about 60 km across.*

Image 6 Questions

- What do you notice about this region?
- How might the teardrop-shaped landforms have formed?
- What might make this region a desirable landing site?
- Do you see anything that might make this an interesting area to explore?



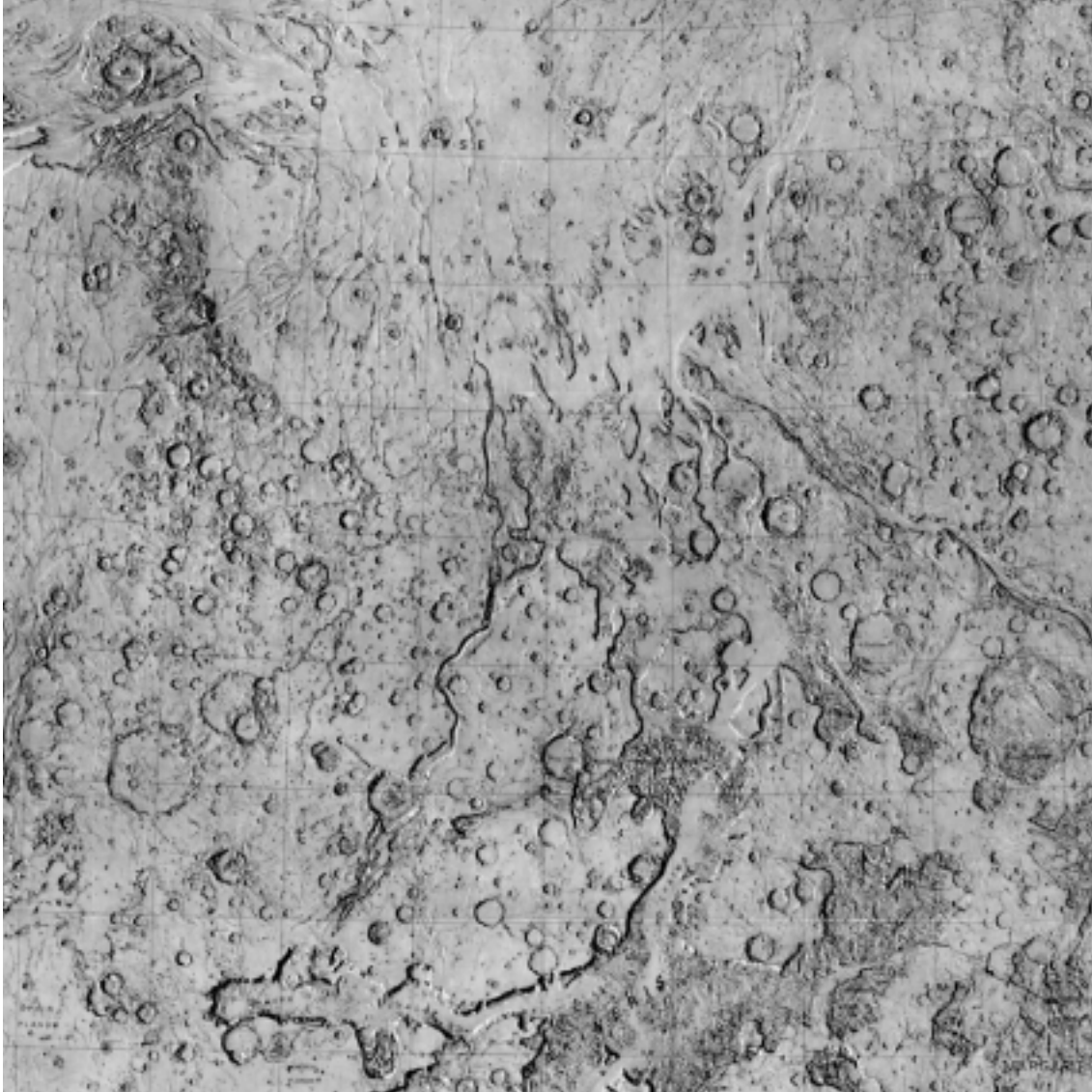

Image 7. Regional view of Ares Vallis and the Chryse Planitia. Scale: The map shows an area roughly 3,000 by 3,400 km.

Image 7 Questions

- How big is this area?
- What is the general topography of this region? Which direction is uphill?
- How much water flowed in this region, a little or a lot?
- From where might the water that flowed in these channels have come?
- Why is the area at the end of the channel so smooth?
- What do you think the Chryse Planitia looked like when water flowed in the channels?
- Describe the distribution of craters in this region.
- What might explain this pattern of distribution?
- What are some differences between the craters on the plain and in the highlands?

Appendix H

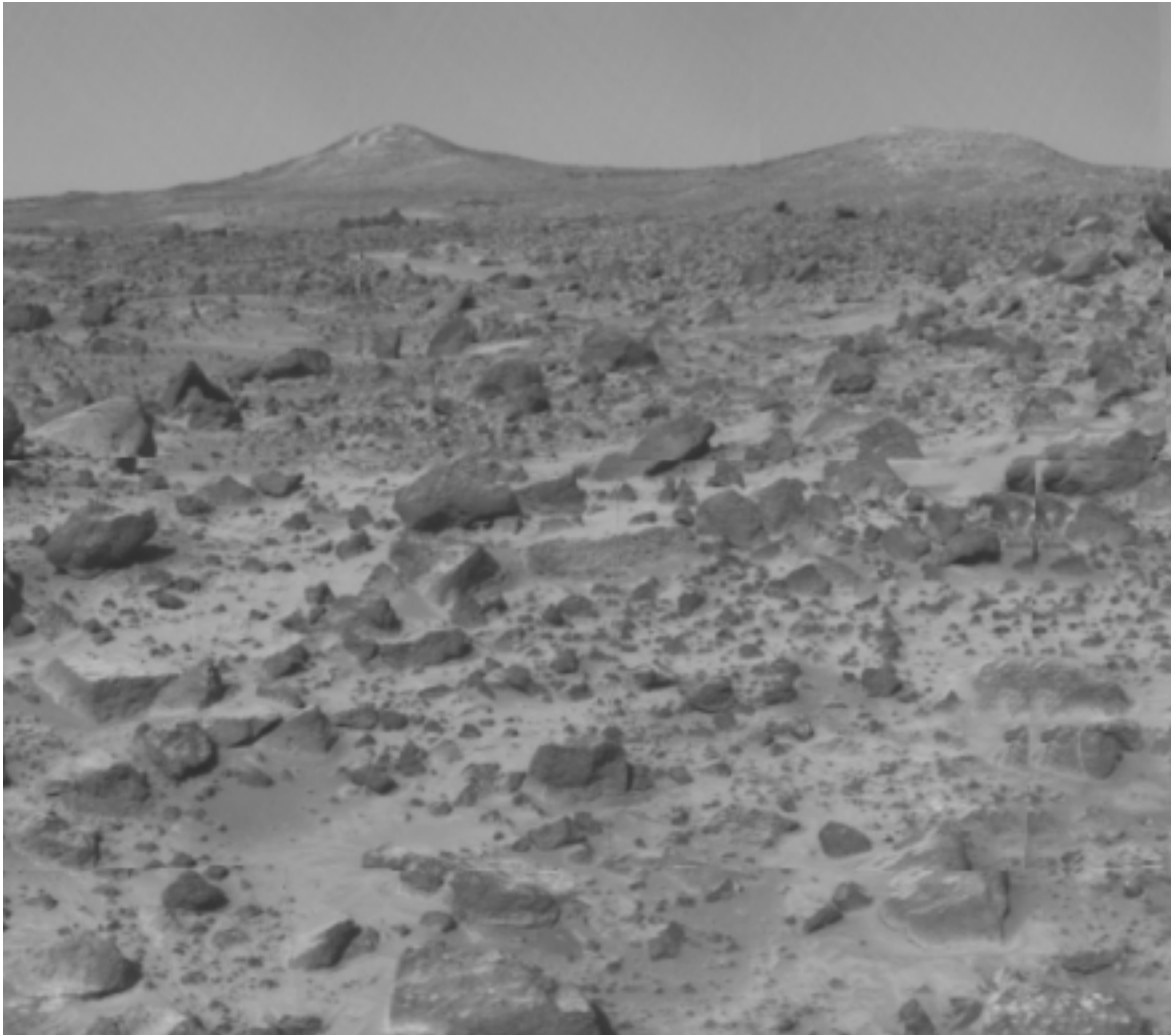

Image 8. The view from Pathfinder toward Twin Peaks. Scale: The Twin Peaks are about 1 km away and are about 50 m tall.

Image 8 Questions

- Does this look like any place on Earth?
- Why did the landing site look so smooth when it is really full of boulders?
- What are some ways a plain such as this can become littered with rocks?



Appendix H

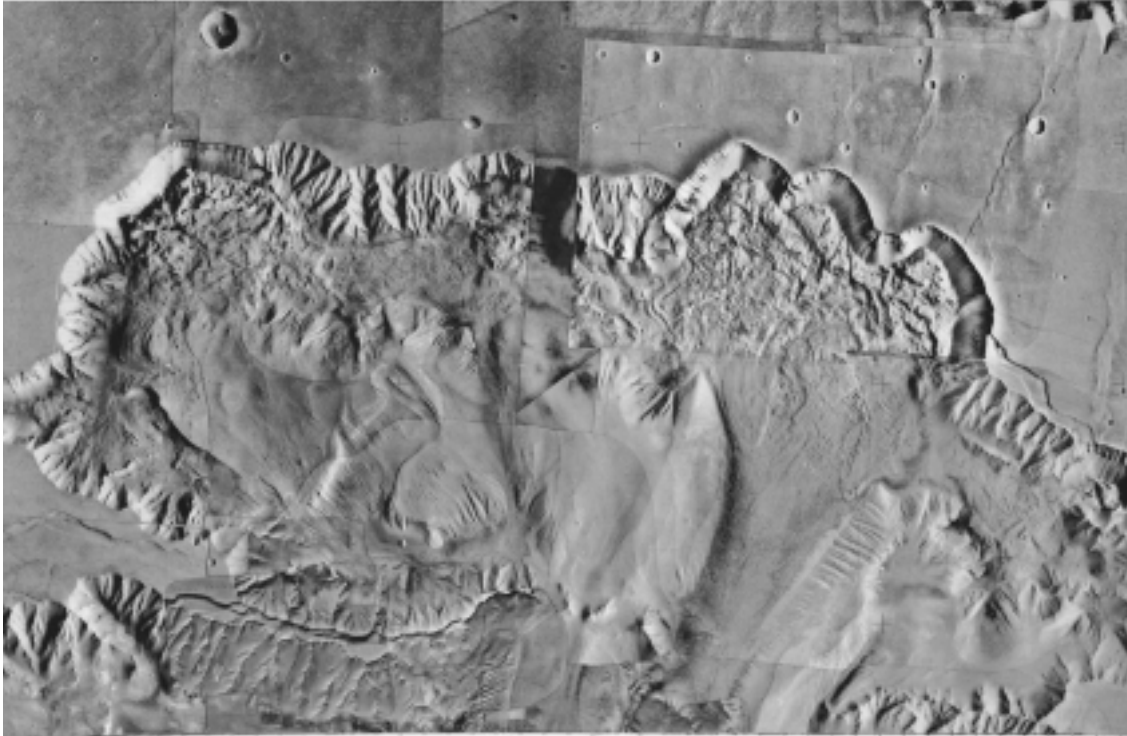

Image 10. The Ophir Chasma. Scale: The Ophir Chasma is about 125 by 325 km, and the walls are about 5 km tall.

Image 10 Questions

- What processes have affected this canyon?
- Why might the plateau be so smooth?



Image 11. The Nani Vallis. Scale: The image size is 9.8 by 15 km, and the canyon is about 2.5 km wide.

Image 11 Questions

- What processes have affected this canyon?
- What evidence is there for the idea that water flowed here?
- What evidence is there against the idea that water flowed here?

Appendix H



Image 12. Oxbows and meanders on the Red River in Campti, Louisiana. Scale: The area shown is about 10 by 17 km.

Image 12 Questions

- How are the two banks different as the river goes around a bend?
- How did the oxbow lakes form?
- How does the Red River compare with the Naniedi canyon?



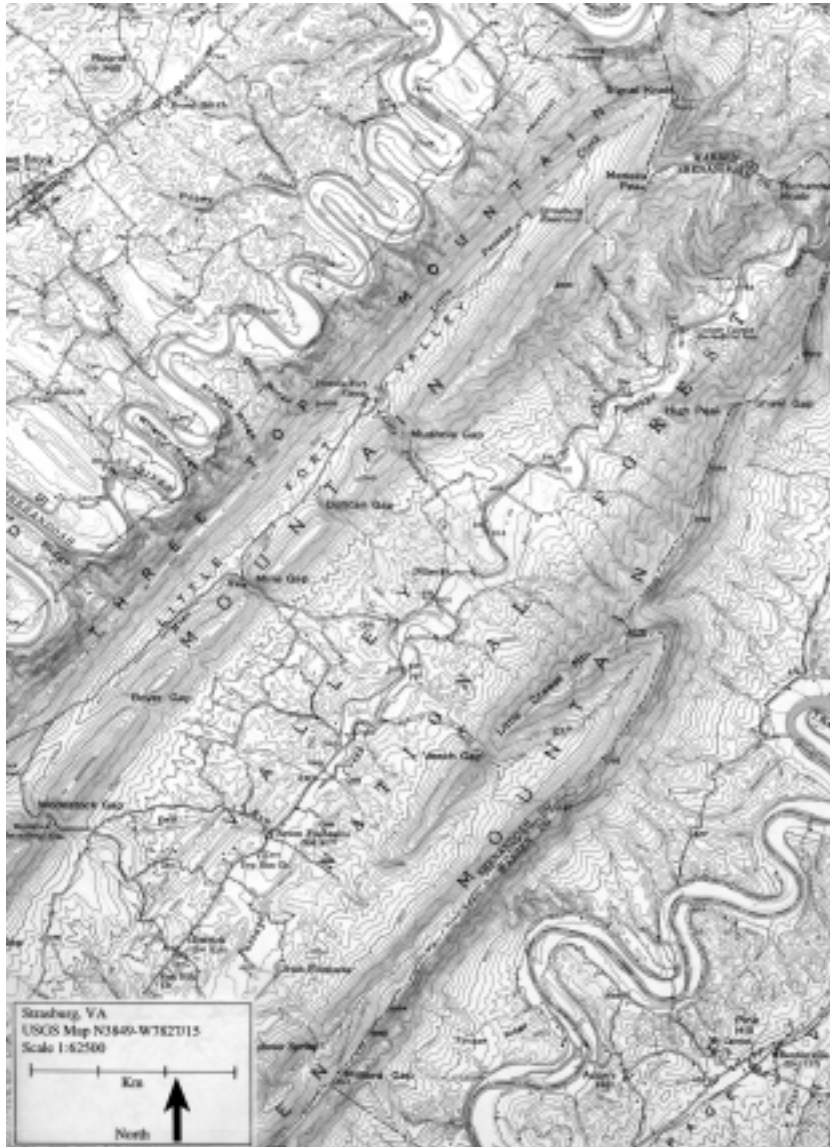

Image 13. Meanders on the Shenandoah River near Strasburg, Virginia. Scale: The area shown is about 13 by 17 km.

Image 13 Questions

- How do the valleys carved by the Shenandoah and Red Rivers compare to the Nanedi Vallis?
- How long might it take for a river to form a valley of this size?
- On which side of each sharp turn is the bank steeper?
- What factors might influence how quickly a valley forms?

Appendix H



Image 14. The Martian South Pole. Scale: This view is about 3,375 km across.

Image 14 Questions

- How might one tell whether the poles are covered with water ice or dry ice?
- What might cause the spiraling shape of the poles?



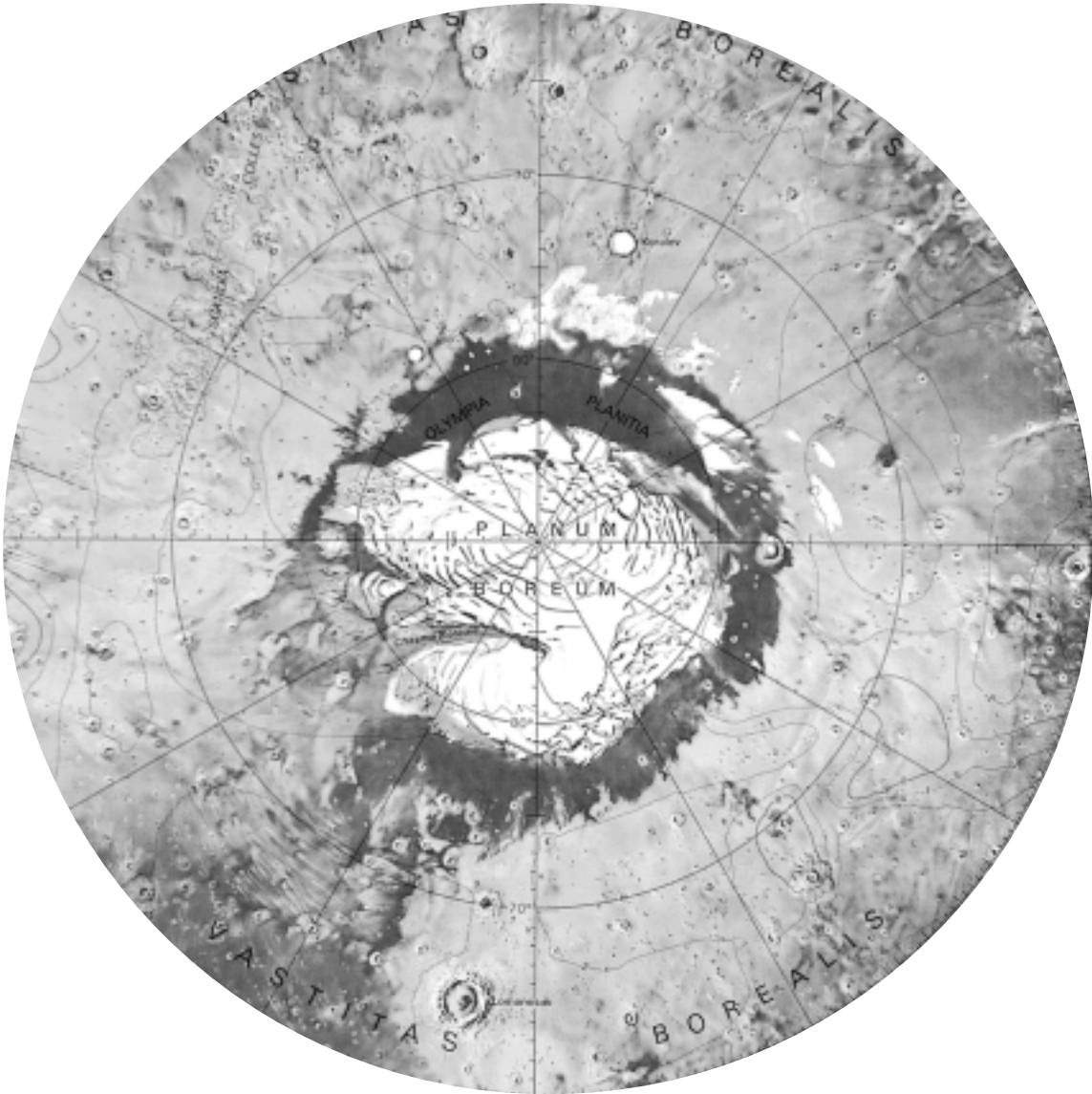

Image 15. The Martian North Pole. Scale: This view is about 3,375 km across.

Image 15 Questions

- How might one tell whether the poles are covered with water ice or dry ice?
- What might cause the spiraling shape of the poles?

Image Set B: The Same 15 Images Processed So That, on a Photocopier, They Reproduce Better Than the High-Contrast Versions



Image 1. Mars hemisphere. Scale: Mars is 6,787 km in diameter.

Image 1 Questions

- What is the feature across the middle?
- What do you think the circles on the left side are?

Appendix I

Is There Water on Mars? An Educator's Guide With Activities for Physical and Earth and Space Science



Image 2. A view across the Argyre Planitia. Scale: The large crater in the upper right is about 200 km in diameter.

Image 2 Questions

- What is the line on the horizon above the Martian surface?
- How high above the surface is it?
- What causes it to be visible?



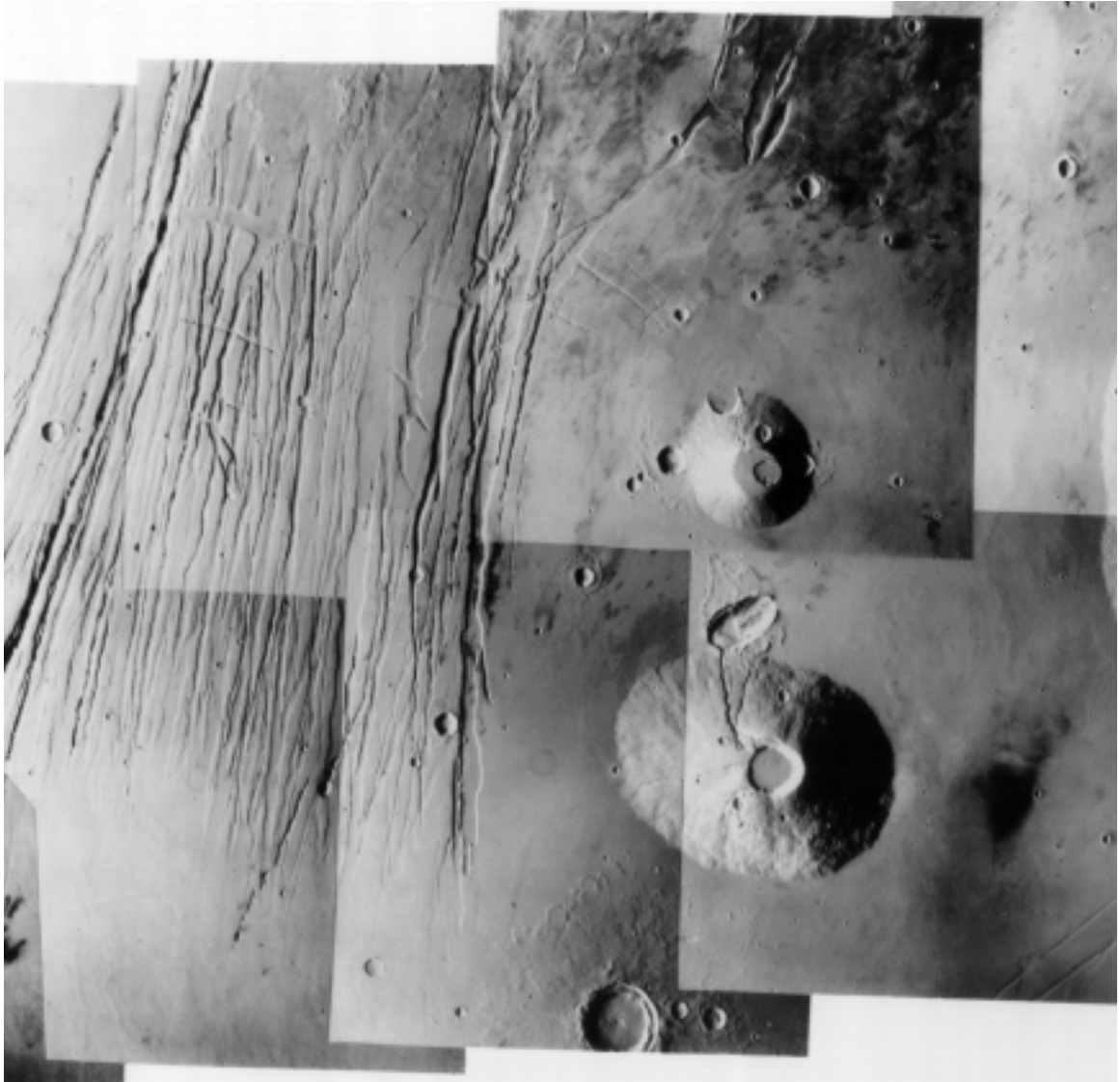

Image 3. Martian volcanoes and fault lines. Scale: The lower volcano is 90 by 130 km.

Image 3 Questions

- Which came first, the volcano or the impact craters? How can you tell?
- What might have caused the channels on the side of the volcanoes?
- What are the lines in this image? What might have caused them?

Appendix I

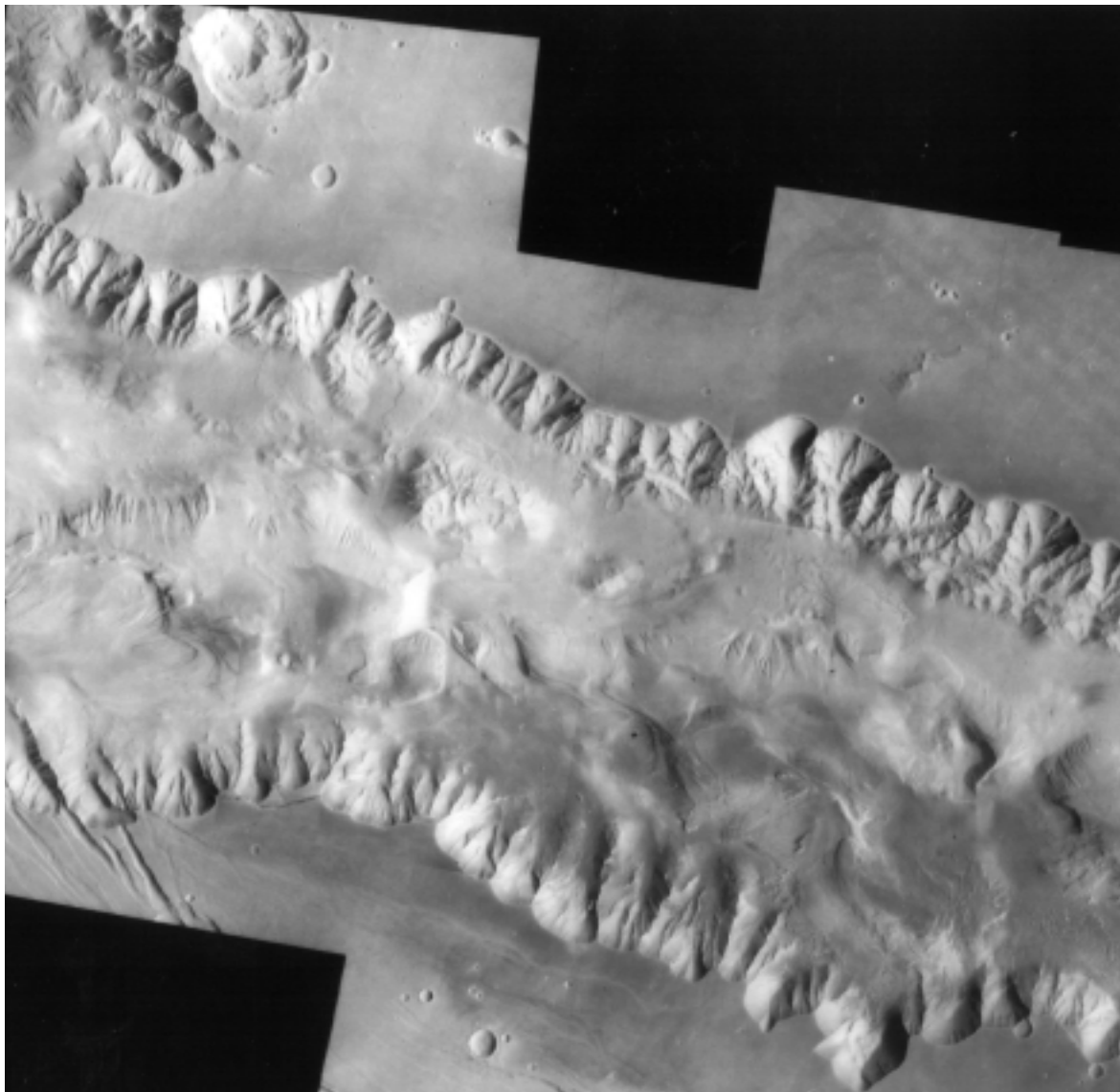

Image 4. A section of the Candor Chasm. Scale: This section is about 125 km wide and 8 km deep.

Image 4 Questions

- What do you think caused the valley?
- What do you think shaped the cliffs on the edges of the canyon?
- How did this canyon get so wide?





Image 5. Landform at the mouth of the Kasei Vallis. Scale: The crater in the lower right is about 100 km across.

Image 5 Questions

- Explain which came first, the fractures or the large crater in the center left?
- Which came first, the crater in the bottom center or the channel?
- Which direction did the fluid flow? Is any fluid apparent now?
- What caused the “tails” behind the small craters in the channel?
- What sequence of events and processes makes most sense in explaining all these features?

Appendix I

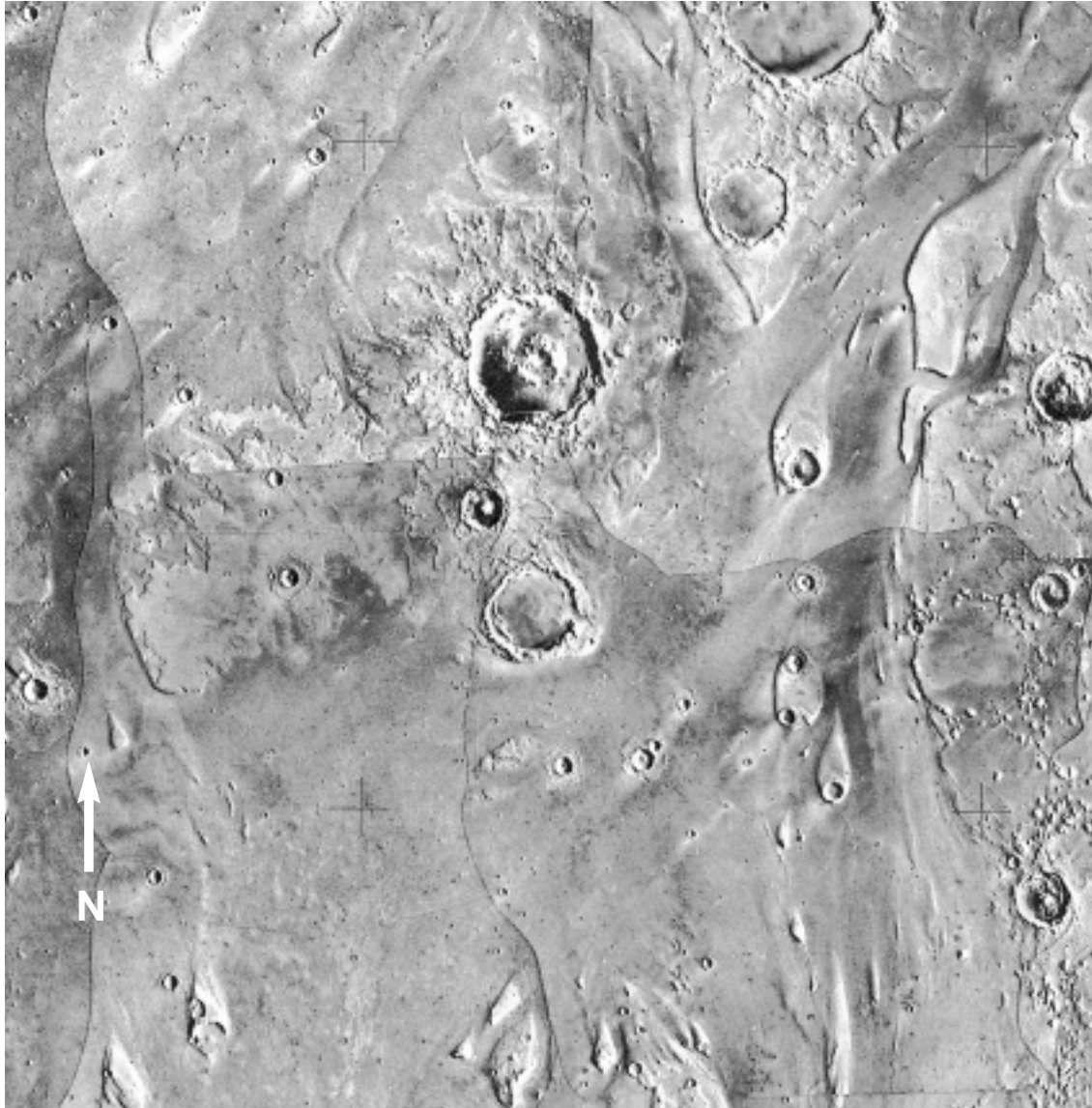

Image 6. *Pathfinder's landing site at the mouth of the Ares Vallis. Scale: The dark crater near the center is about 60 km across.*

Image 6 Questions

- What do you notice about this region?
- How might the teardrop-shaped landforms have formed?
- What might make this region a desirable landing site?
- Do you see anything that might make this an interesting area to explore?



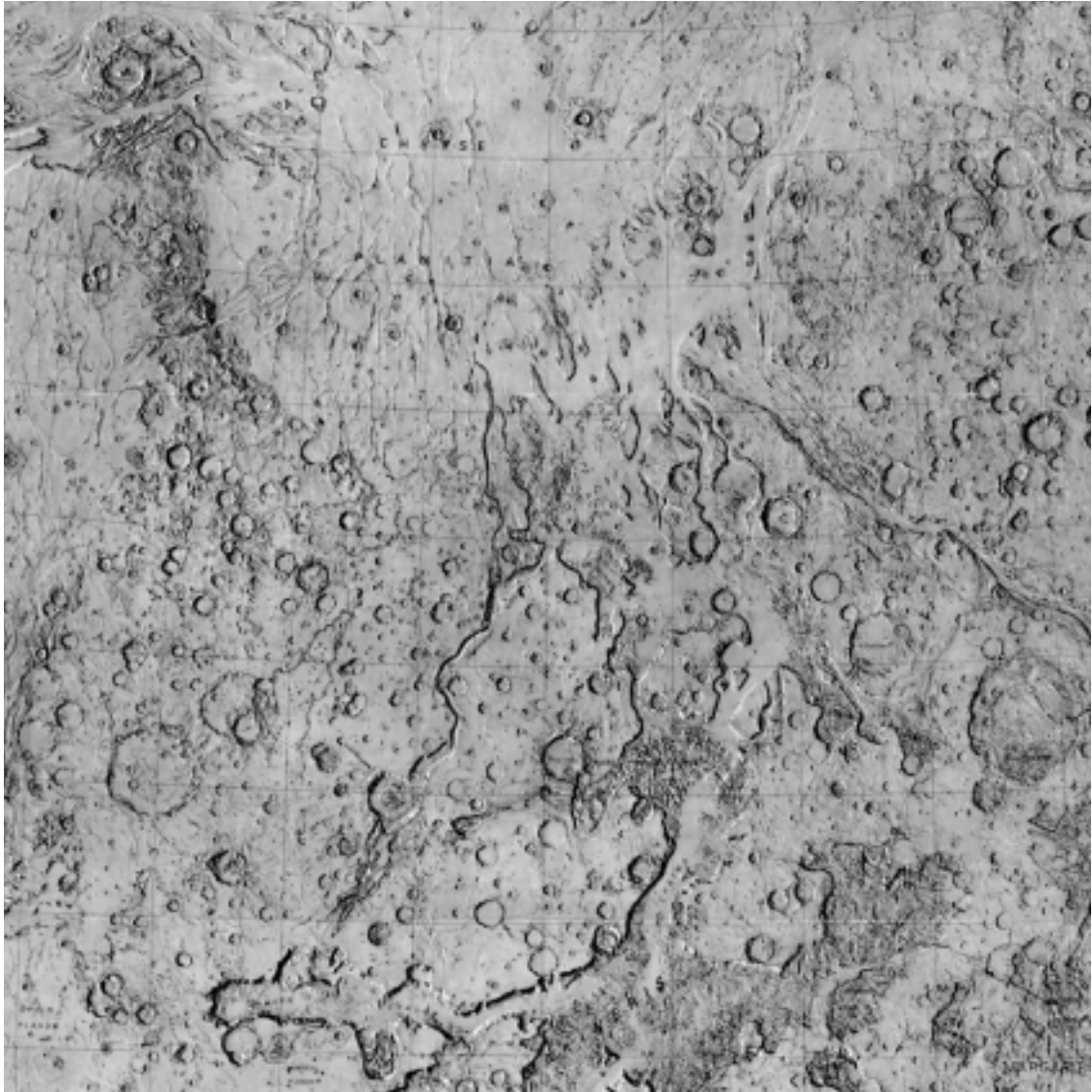

Image 7. Regional view of Ares Vallis and the Chryse Planitia. Scale: The map shows an area roughly 3,000 by 3,400 km.

Image 7 Questions

- How big is this area?
- What is the general topography of this region? Which direction is uphill?
- How much water flowed in this region, a little or a lot?
- From where might the water that flowed in these channels have come?
- Why is the area at the end of the channel so smooth?
- What do you think the Chryse Planitia looked like when water flowed in the channels?
- Describe the distribution of craters in this region.
- What might explain this pattern of distribution?
- What are some differences between the craters on the plain and in the highlands?
- What might explain the differences between the craters in these two areas?

Appendix I

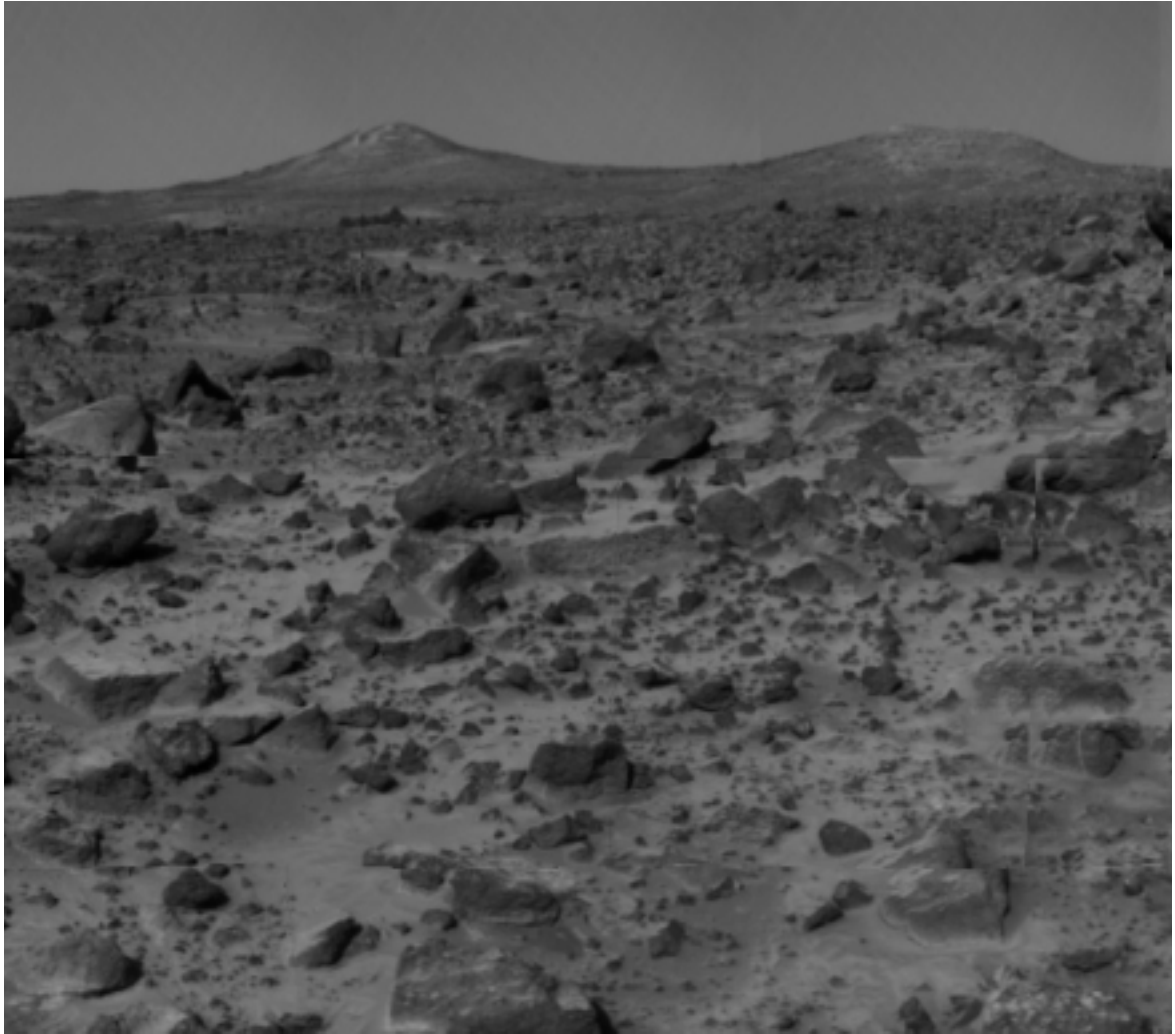

Image 8. The view from Pathfinder toward Twin Peaks. Scale: The Twin Peaks are about 1 km away and are about 50 m tall.

Image 8 Questions

- Does this look like any place on Earth?
- Why did the landing site look so smooth when it is really full of boulders?
- What are some ways a plain such as this can become littered with rocks?



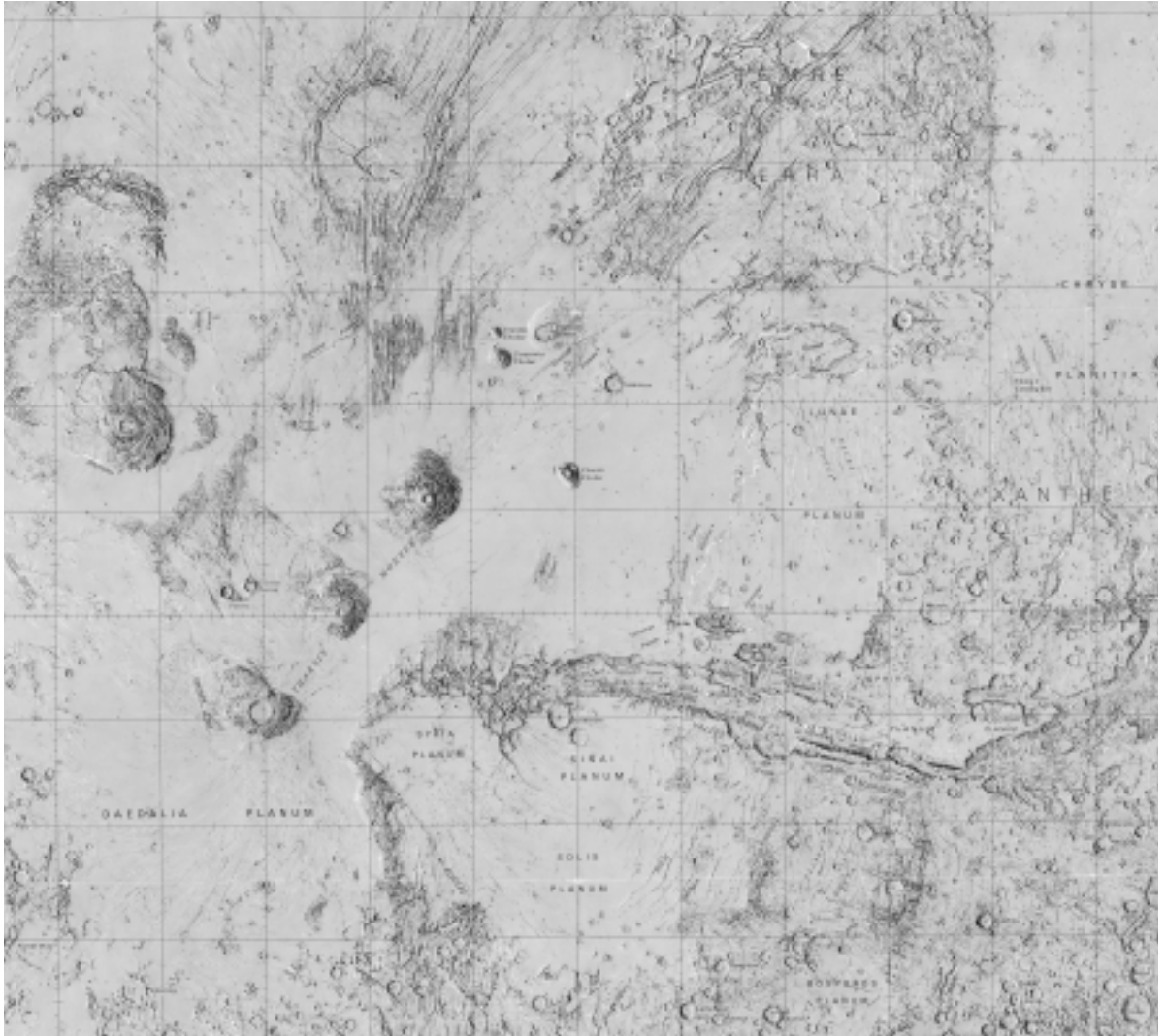

Image 9. Valles Marineris and the surrounding region. Scale: Olympus Mons, the left-hand most volcano, is about 600 km in diameter. The map shows an area roughly 8,250 by 6,750 km.

Image 9 Questions

- How many volcanoes can you find?
- How long is the large canyon?
- Does the canyon seem to be a single formation or a series of smaller, distinct canyon systems?
- What might explain having volcanoes, fractures, and canyon systems in one area of Mars?

Appendix I

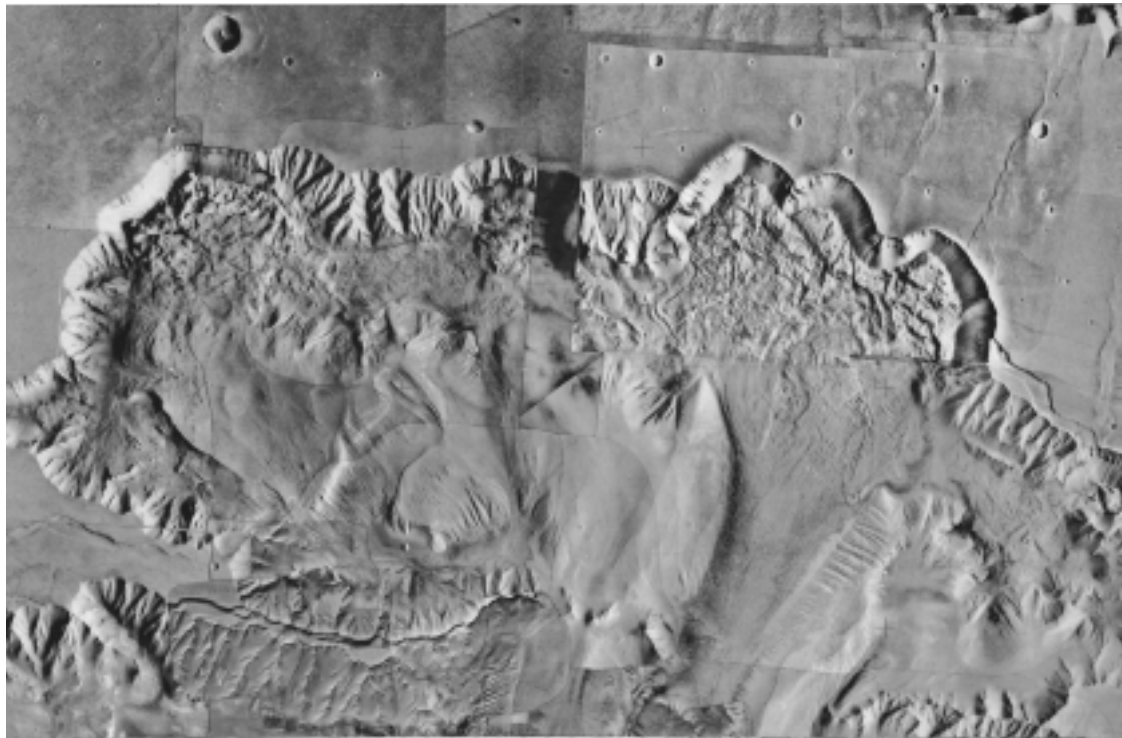

Image 10. The Ophir Chasma. Scale: The Ophir Chasma is about 125 by 325 km, and the walls are about 5 km tall.

Image 10 Questions

- What processes have affected this canyon?
- Why might the plateau be so smooth?



Image 11. The Nani Vallis. Scale: The image size is 9.8 by 15 km, and the canyon is about 2.5 km wide.

Image 11 Questions

- What processes have affected this canyon?
- What evidence is there for the idea that water flowed here?
- What evidence is there against the idea that water flowed here?

Appendix I



Image 12. Oxbows and meanders on the Red River in Campti, Louisiana. Scale: The area shown is about 10 by 17 km.

Image 12 Questions

- How are the two banks different as the river goes around a bend?
- How did the oxbow lakes form?
- How does the Red River compare with the Naniedi canyon?



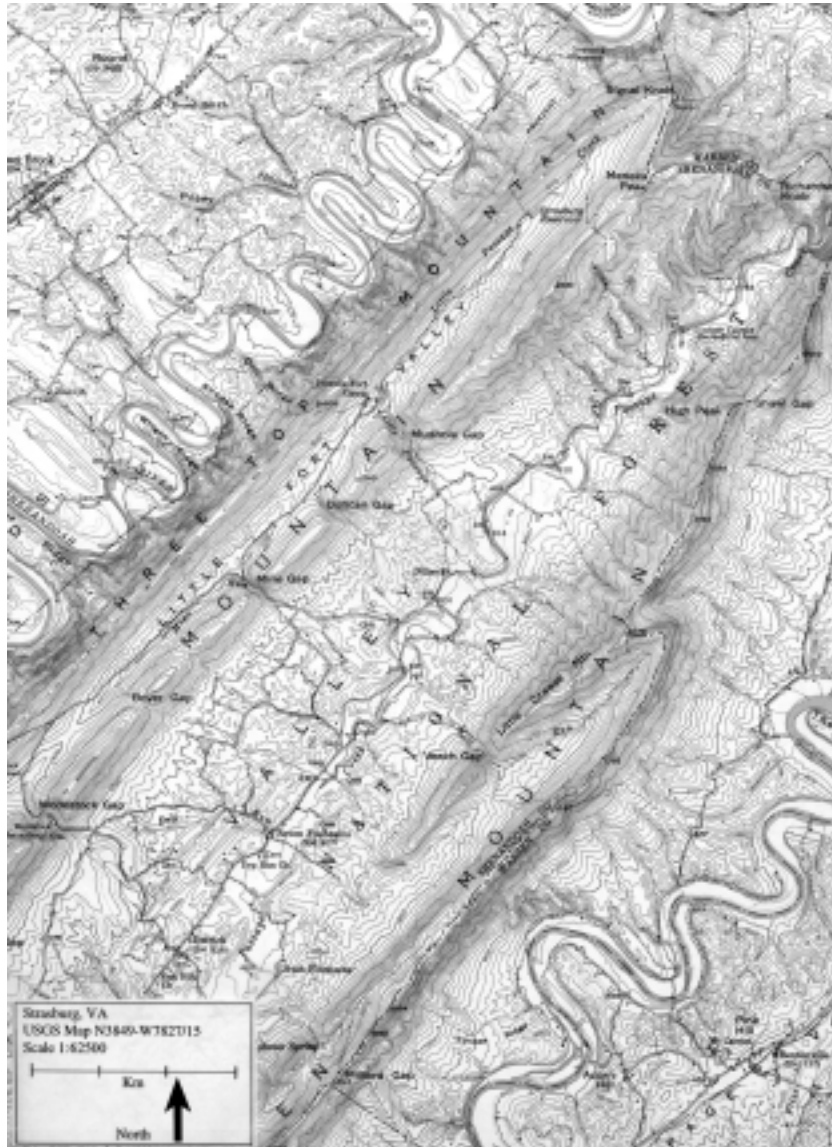

Image 13. Meanders on the Shenandoah River near Strasburg, Virginia. Scale: The area shown is about 13 by 17 km.

Image 13 Questions

- How do the valleys carved by the Shenandoah and Red Rivers compare to the Nandedi Vallis?
- How long might it take for a river to form a valley of this size?
- On which side of each sharp turn is the bank steeper?
- What factors might influence how quickly a valley forms?

Appendix I

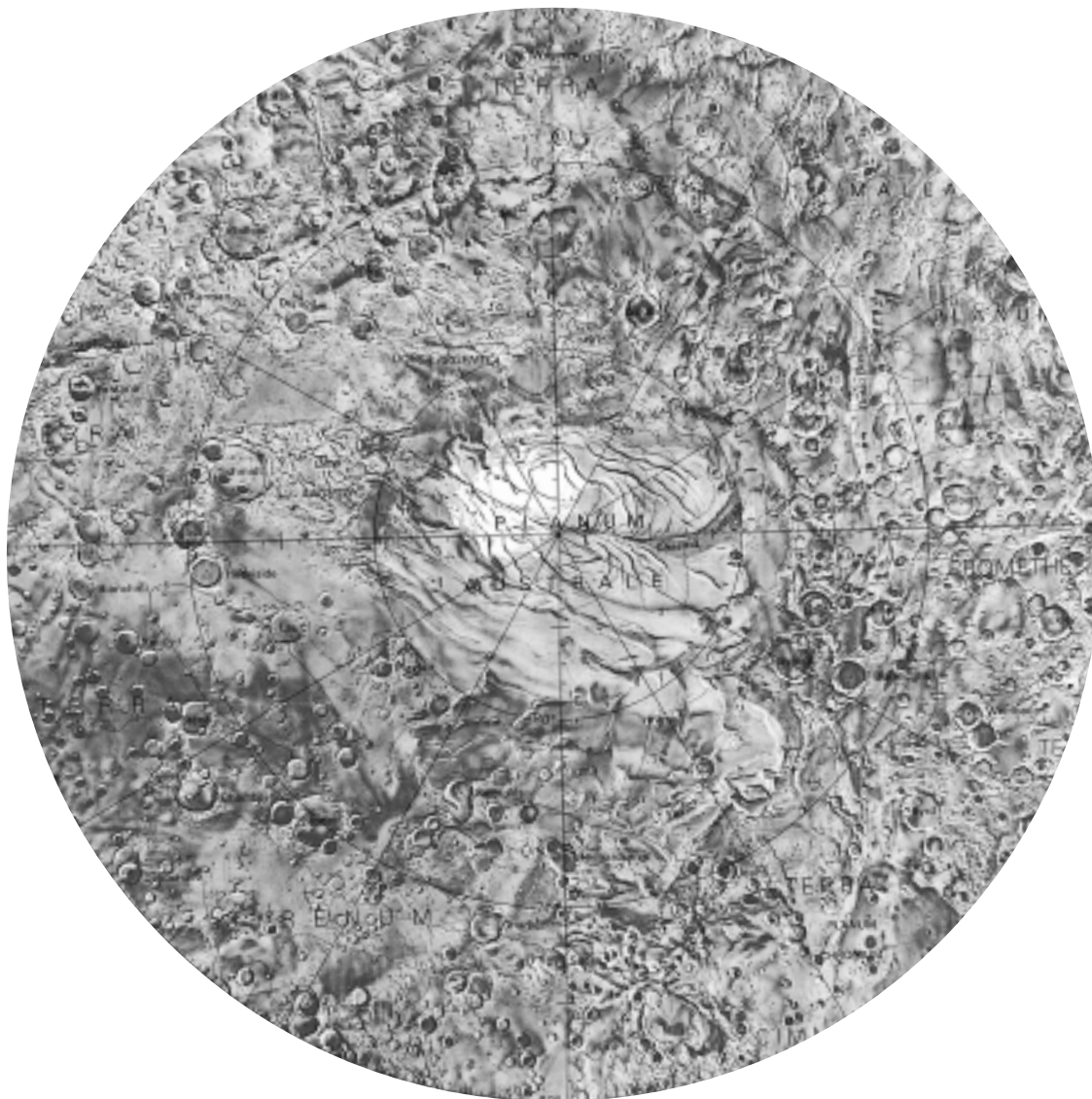

Image 14. The Martian South Pole. Scale: This view is about 3,375 km across.

Image 14 Questions

- How might one tell whether the poles are covered with water ice or dry ice?
- What might cause the spiraling shape of the poles?



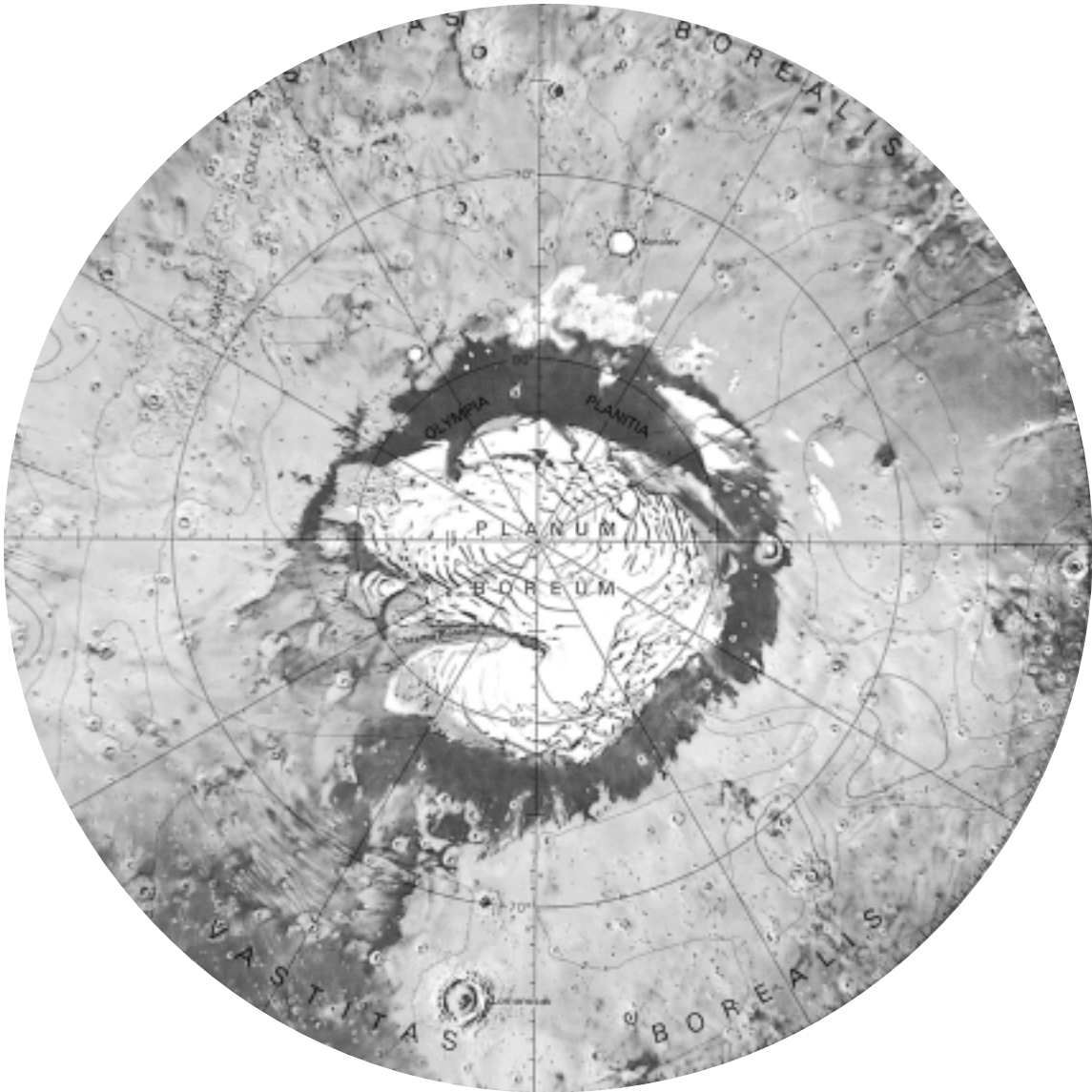

Image 15. The Martian North Pole. Scale: This view is about 3,375 km across.

Image 15 Questions

- How might one tell whether the poles are covered with water ice or dry ice?
- What might cause the spiraling shape of the poles?

Is There Water on Mars?

An Educator's Guide for Physical and Earth and Space Science

EDUCATOR REPLY CARD

To achieve America's goals in Educational Excellence, it is NASA's mission to develop supplementary instructional materials and curricula in science, mathematics, and technology. NASA seeks to involve the educational community in the development and improvement of these materials. Your evaluation and suggestions are vital to continually improving NASA educational materials.

Please take a moment to respond to the statements and questions below. You can submit your response through the Internet or by mail. Send your reply to the following Internet address:

http://ehb2.gsfc.nasa.gov/edcats/educator_guide

You will then be asked to enter your data at the appropriate prompt.

Otherwise, please return the reply card by mail. Thank you.

1. With what grades did you use the educator guide?
 Number of Teachers/Faculty:
 _____ K-4 _____ 5-8 _____ 9-12 _____ Community College
 College/University - _____ Undergraduate _____ Graduate

 Number of Students:
 _____ K-4 _____ 5-8 _____ 9-12 _____ Community College
 College/University - _____ Undergraduate _____ Graduate

 Number of Others:
 _____ Administrators/Staff _____ Parents _____ Professional Groups
 _____ General Public _____ Civic Groups _____ Other
2. What is your home 5- or 9-digit zip code? _____ — _____
3. This is a valuable educator guide?
 Strongly Agree Agree Neutral Disagree Strongly Disagree
4. I expect to apply what I learned in this educator guide.
 Strongly Agree Agree Neutral Disagree Strongly Disagree

Fold along line and tape closed.

5. What kind of recommendation would you make to someone who asks about this educator guide?
 Excellent Good Average Poor Very Poor
6. How did you use this educator guide?
 Background Information Critical Thinking Tasks
 Demonstrate NASA Materials Demonstration
 Group Discussions Hands-On Activities
 Integration Into Existing Curricula Interdisciplinary Activity
 Lecture Science and Mathematics
 Team Activities Standards Integration

 Other: Please specify: _____
7. Where did you learn about this educator guide?
 NASA Educator Resource Center
 NASA Central Operation of Resources for Educators (CORE)
 Institution/School System
 Fellow Educator
 Workshop/Conference
 Other: Please specify: _____
8. What features of this educator guide did you find particularly helpful?

9. How can we make this educator guide more effective for you?

10. Additional comments:

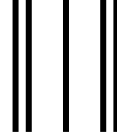

Please Place
Stamp Here
Post Office
Will Not Deliver
Without Proper
Postage

**NATIONAL AERONAUTICS AND SPACE ADMINISTRATION
EDUCATION DIVISION
MAIL CODE FE
WASHINGTON DC 20546-0001**



Fold along line and tape closed.