



A psychoengineering paradigm for the neurocognitive mechanisms of biofeedback and neurofeedback



A. Gaume^{a,b}, A. Vialatte^{a,c}, A. Mora-Sánchez^{a,b}, C. Ramdani^d, F.B. Vialatte^{b,*}

^a Université Pierre et Marie Curie, 4 Place Jussieu, 75005 Paris, France

^b Laboratoire Plasticité du Cerveau, UMR 8249, ESPCI Paris Tech, PSL Research University, 10 rue Vauquelin 75005 Paris, France

^c Institut Langevin, UMR 7587, ESPCI Paris Tech, PSL Research University, 1 Rue Jussieu, 75005 Paris, France

^d Institut de recherche biomédicale des armées, BP 73, 91223 Brétigny sur Orge Cedex, France

ARTICLE INFO

Article history:

Received 18 February 2016

Received in revised form 3 June 2016

Accepted 14 June 2016

Available online 20 June 2016

Keywords:

Biofeedback

Neurofeedback

Learning

Psychoengineering

Executive function

Brain plasticity

Development

ABSTRACT

We believe that the missing keystone to design effective and efficient biofeedback and neurofeedback protocols is a comprehensive model of the mechanisms of feedback learning. In this manuscript we review the learning models in behavioral, developmental and cognitive psychology, and derive a synthetic model of the psychological perspective on biofeedback. We afterwards review the neural correlates of feedback learning mechanisms, and present a general neuroscience model of biofeedback. We subsequently show how biomedical engineering principles can be applied to design efficient feedback protocols. We finally present an integrative psychoengineering model of the feedback learning processes, and provide new guidelines for the efficient design of biofeedback and neurofeedback protocols. We identify five key properties, (1) perceptibility = can the subject perceive the biosignal?, (2) autonomy = can the subject regulate by himself?, (3) mastery = degree of control over the biosignal, (4) motivation = rewards system of the biofeedback, and (5) learnability = possibility of learning. We conclude with guidelines for the investigation and promotion of these properties in biofeedback protocols.

© 2016 Elsevier Ltd. All rights reserved.

Contents

1. Introduction	892
1.1. Potential of feedback approaches	892
1.2. Towards higher standards	892
1.3. Modeling neurofeedback and biofeedback: how does it work?	893
2. Biomedical perspective	893
2.1. Acquiring skills	893
2.2. Volitional and conscious strategy?	894
2.3. Synthetic biomedical model	894
3. Psychological perspective	894
3.1. Operant conditioning: the reward problem	894
3.2. Developmental psychology and schemata	895
3.3. Skill learning	896
3.4. Executive function and attention	897
3.5. Working memory models	897
3.5.1. Multiple-component model	897
3.5.2. Embedded-process model	897
3.5.3. Long-term working memory	898
3.5.4. Time-based resource-sharing model	898

* Corresponding author.

E-mail address: francois.vialatte@espci.fr (F.B. Vialatte).

3.6.	Volitional action, agency, and fluency	898
3.7.	Synthetic psychological models	898
4.	Neuroscience perspective	899
4.1.	Neural correlates of schemata formation.....	899
4.2.	Schemata and working memory	900
4.3.	Executive functions and the prefrontal cortex	900
4.4.	Self-control networks	901
4.5.	Consciousness of errors and error potentials.....	901
4.6.	Motivation and reward	902
4.7.	General model of feedback learning.....	902
5.	Engineering perspective	903
5.1.	Process control models of feedback learning.....	903
5.1.1.	Controllability	903
5.1.2.	Observability	903
5.1.3.	Basic model.....	903
5.1.4.	Explicit model of neurofeedback and biofeedback	904
5.1.5.	Implicit model of neurofeedback and biofeedback.....	904
5.2.	Limits of process control models	904
5.2.1.	Linearity	904
5.2.2.	Stability.....	904
5.2.3.	Temporality: transients and steady-states	904
5.2.4.	Precision	904
5.3.	Serious games	904
6.	Psychoengineering model	905
6.1.	The missing keystone: toward a psychoengineering model	905
6.2.	Bridging the disciplinary gaps	905
7.	Conclusion	905
7.1.	Investigating and promoting perceptibility	905
7.2.	Investigating and promoting autonomy	906
7.3.	Investigating and promoting mastery	906
7.4.	Investigating and promoting motivation.....	907
7.5.	Investigating and promoting learnability	907
	References	907

1. Introduction

1.1. Potential of feedback approaches

When children go to school to learn how to read and write, they receive guidance and feedback from their teachers. Through hard work and receptivity to instruction, their cognitive skills will adapt and they will eventually acquire reading and writing skills. This adaptation is crucial to human development and central to the acquisition of what makes us human; tutored interaction plays a key role in culture acquisition. Biofeedback provides a subject with a similar type of training, but instead of acquiring knowledge, the subject acquires self-regulation mechanisms in order to control affective, biological, and/or cognitive skills. Such psychophysiological self-regulation could theoretically extend to the functioning of both the autonomic and the central nervous systems (Prinzel et al., 2001). Common modalities of biofeedback include respiratory, cardiovascular, neuromuscular, skin conductance and temperature, and central nervous system (Khazan, 2013).

Biofeedback can be explicit or implicit information (Dekker and Champion, 2007; Kuikkaniemi et al., 2010; Nacke et al., 2011). In the explicit model, feedback is given to the controller so that the controller can act on the system. This is the most typical case of biofeedback or neurofeedback: the user observes a (generally visual or auditory, less frequently tactile) feedback signal, which is a direct correlate of the biosignal to regulate. For example, the user hears a sound with an amplitude directly proportional to his heart rate, providing him/her with an additional perception to help him/her regulate this biosignal. In implicit biofeedback, the signal is not explicitly presented to the subject, but instead changes some detail(s) of the experimental conditions. For example, a person

using a videogame whose content (e.g., changing levels of difficulty or access to bonus items) evolves depending upon his heart rate is receiving implicit feedback; he/she does not know directly that his heart rate has dropped, but he/she experiences indirect effects of this physiological change. The user is not directly aware of his biosignal, but since it changes the behavior of the system he/she is observing, he/she gets implicit access to a correlate of that biosignal. Implicit feedback is used for subtle and indirect interactions (e.g., changing implicitly the game difficulty) rather than to provide information (Dekker and Champion, 2007; Kuikkaniemi et al., 2010). Such indirect biofeedbacks have an effect on motivational variables (Nacke et al., 2010), and are typically used in affective videogames (Gilleade and Dix, 2005). However, note that if the user of an implicit biofeedback starts learning how the system works and thereby gains control over it, implicit biofeedback becomes explicit (Kuikkaniemi et al., 2010).

Biofeedback is also one of the best approaches to the problem of neurophenomenology (Varela et al., 2001). Especially when applied to the brain (neurofeedback), it is a promising new scientific avenue to explore phenomenology and to investigate the self and consciousness (Bagdasaryan and Le Van Quyen, 2013), thereby attempting to solve the so-called hard problem of consciousness (Chalmers, 1995).

Finally, biofeedback holds a prominent position in the transhumanist agenda (Hansell and Grassie, 2011). Transhumanism is an international and intellectual movement that aims to enhance human intellectual, physical, and psychological capacities (Bostrom, 2006). The cybernetics perspective on biofeedback (Anliker, 1977) opens new perspectives about human enhancement, attracting the attention of a growing scientific community.

1.2. Towards higher standards

In order to clearly evaluate the clinical efficacy of biofeedback interventions, the Association for Applied Psychophysiology and Biofeedback and the Society for Neuronal Regulation developed guidelines with five levels of performance (Moss and Gunkelman, 2002): (1) not empirically supported, (2) possibly efficacious, (3) probably efficacious, (4) efficacious, (5) efficacious and specific. In order to reach level 4 and be considered efficacious, a treatment must be replicated in at least two independent studies, the data analysis must not be flawed, the outcome must be evaluated with precise inclusion criteria, and the experimental setting must involve randomized control trials. Level 5 is reached if the treatment satisfies level 4 conditions, and in addition is statistically superior to credible sham therapy, pill, or alternative bona fide treatment in at least two studies. In a review of 41 treatments, urinary incontinence in females was the only biofeedback treatment found to be efficacious and specific (Yucha and Montgomery, 2008). In the same study, biofeedback was deemed efficacious for ten other conditions: anxiety, attention deficit hyperactivity disorder (ADHD), chronic pain, epilepsy, constipation, headache, hypertension, motion sickness, Raynaud's disease, and temporomandibular disorder. Note that the survey criteria did not require double-blind investigations; consequently, some of the treatments ranked at level 4 may still be biased by placebo effects. In other words, despite several well-conducted studies exist, the effectiveness of biofeedback has not been fully demonstrated yet, due to insufficient evidences. We hope future biofeedback studies will reach higher standards, so they can meet with level 5 condition with double-blind protocols.

1.3. Modeling neurofeedback and biofeedback: how does it work?

Previous studies attempted to describe the cognitive adaptation mechanisms supporting neuro and biofeedback (Sherlin et al., 2011; Bagdasaryan and Le Van Quyen, 2013; Gevensleben et al., 2014; Ros et al., 2014; Micoulaud-Franchi et al., 2015). We believe that the missing keystone to design effective and efficient approaches is a clear and comprehensive model synthesizing the existing medical, neurological, psychological and engineering perspectives. Considering that information processing is impacted by biofeedback, one would expect to see a model—or at least an explanation—of how these processes will adapt. Due to disciplinary barriers, even though these cognitive adaptation processes have been described in the scientific literature, a general model has never been proposed. In the interest of removing those barriers, we will review existing models of biofeedback from biomedical, psychological, brain science, and bioengineering perspectives. We will then synthesize those views and present a general model of the cognitive adaptation mechanisms underlying biofeedback. As was stated by Georges Box, all models are essentially wrong, but some are useful (Box and Draper, 1987). We will prove the usefulness of this model by providing guidelines for proper development of efficient biofeedback and neurofeedback protocols and the means to control key parameters for successful feedback learning.

2. Biomedical perspective

Psychophysiological self-regulation, also commonly termed biofeedback (biological feedback), can be investigated from a biomedical perspective. In this section we will review the existing models of biofeedback mechanisms from the perspective of biomedical interventions, where the aim is to improve biological variables impaired by dysfunctions (e.g., blood pressure, tension, heart rate variability, etc.). The variable of interest is fed back to

the subject as a biosignal that he/she then attempts to regulate. Consequently, investigations in the biomedical field are more concerned with optimizing conditions for the provision of effective and efficient treatments. In other words, most manuscripts in this field focus more on biofeedback efficiency rather than on biofeedback mechanisms. Consequently, we will review in this section the interpretations found in the biomedical literature about the conditions for efficient biofeedback design, considered as a treatment.

Indeed, a medical approach to biofeedback necessarily means an approach centered on treatment of pathologies, for the purposes of improving health and performance (Yucha and Montgomery, 2008). This perspective is to be distinguished from the transhumanist goal of performance enhancement (Maheu et al., 2004), and should not be confused with the entertainment perspective of biofeedback games (Arns et al., 2015). In other words, medical biofeedback seeks to cure, not to enhance or entertain. Some authors defend the thesis that biofeedback would normalize biological functions, thereby treating pathologies. For instance, for Arns the main goal neurofeedback is to normalize deviant brain activity (Arns, 2011). The biofeedback aim would in this case be to train the patient so he can reach normality. However, judging a statistically abnormal feature as pathology is rather a normative judgement than a scientific one. One shall always refer to the individual's own reference when defining pathology¹ (Canguilhem, 1966). According to Canguilhem's perspective, the aim of medicine in general and biofeedback in particular would be to seek improvements in impaired functions, instead of seeking normality. However, as the distinction between the vital norms of the body and the disciplinary norms of society is becoming difficult to maintain in the modern times, this ethical question remains to be solved (Rose, 2009).

2.1. Acquiring skills

For decades, the biomedical literature has emphasized biofeedback's basis in the acquisition of self-regulation and self-control skills that subjects could use to correct their states toward an optimum (Schwartz and Schwartz, 2003; Norris, 1986; Epstein and Blanchard, 1977; Hauri, 1975). The consequence of this acquisition of new self-control skills would be an improved "calibration" of the nervous system (Brenner, 1974). The key to understanding the effect of biofeedback would then be to model how these volitional skills or strategies are acquired during biofeedback sessions. One can identify two specific skills: **discrimination**, which is the aptitude to achieve an inner perception of the biological variable, and **self-maintenance**, which is the ability to affect the biological variable and effectively change it in the intended direction (Epstein and Blanchard, 1977). These skills would in turn allow subjects to regulate their biological constants through a volitional psychosomatic process (Leigh, 1978). This model provides an important guideline for evaluating biofeedback systems—a model that unfortunately has not been taken into account in several studies. Indeed, if discrimination and self-maintenance are acquired, then a proper evaluation of biofeedback should be based on an evaluation of this acquisition. Biofeedback, therefore, should be evaluated pre- and post-training to determine whether the subject has an improved perception of and action on the targeted biological variable (Epstein and Blanchard, 1977). This should be done by comparing the subject's perceptions before and after training (rather than merely evaluating objective performances). There is, however, a surprising lack of reflection in the biomedical literature regarding the nature of those self-control skills and what those strategies could be. Nevertheless, one could easily make the small leap to define

¹ En matière de normes biologiques, c'est toujours à l'individu qu'il faut se référer.

discrimination and self-maintenance skills as *cognitive processes*. We will attempt to provide a proper definition of this new class of cognitive processes in Sections 3 and 4.

2.2. Volitional and conscious strategy?

The existing literature presents contradictory theories about the effects of biofeedback: it is either attributed to *volitional* control over the biological variables (involving executive function) or to *autonomic regulation* of subcognitive systems. The biofeedback literature most often argues that observed effects are due to volitional control of biological variables (e.g., Abukonna et al., 2013), and neurofeedback is known to be more efficient when based on volitional and conscious cognitive strategies demanding the use of attentional processes (Bagdasaryan and Le Van Quyen, 2013). However, one could argue that improved regulation could be achieved without volitional control (in which case the subject would not exert voluntary control over the regulation). In a recent review, for example (Lehrer and Gevirtz, 2014), the effect of heart rate variability biofeedback was attributed to a combination of causes, including homeostasis in the baroreceptors, parasympathetic reflex stimulation, improved gas exchange, mechanical stretching of airways, anti-inflammatory effects, and attentional effects. Nevertheless, as we will see in Section 3.6 it is difficult to defend a hypothesis involving a total absence of volitional control.

Furthermore, one could consider the learning strategy to acquire the biofeedback skills (discrimination and self-maintenance) to be conscious or unconscious. The discord between a cognitive model and an infra-cognitive model is more visible in neurofeedback publications, where two different models can easily be identified. On the one hand, a recent manuscript suggested that neurofeedback relies on a top-down processing mechanism, where higher cognitive functions percolate down from large-scale oscillations to small-scale and single-neuronal activities (Bagdasaryan and Le Van Quyen, 2013). On the other hand, operant conditioning (OC) has historically been the dominant interpretation of neurofeedback mechanisms; the feedback would in that case be modeled as an implicit infra-cognitive reinforcement signal (Lawrence et al., 2014; Caria et al., 2011; Koralek et al., 2012; Stermann and Egner, 2006). These two models lead to opposing perspectives on proper feedback designs: one based on a behavioral paradigm using conditioning strategies, discrete trials, reinforcement approaches, and exercises excluding entertainment (Stermann and Egner, 2006); and another based on a cognitive paradigm linking inner events with the corresponding neural signals (Bagdasaryan and Le Van Quyen, 2013). These two conflicting models have led to a dual-process theory for neurofeedback mechanisms (Wood et al., 2014), a theory that categorizes the cognitive functions supporting neurofeedback into two main types of processing: more automatic and capacity-free processes vs. more controlled and capacity-limited processes. One possible resolution to this contradiction would be to postulate the existence of interactions between these two types of processing. From this perspective, biofeedback could be considered as a self-investigation tool, where the patient improves his volitional control over autonomic mechanisms (Zolten, 1989). As we will see in Section 3.2, it is possible to reconcile these two apparently opposing perspectives, as recent connectionist models in developmental psychology can integrate both perspectives on a continuum. The question of entertainment and biofeedback will be discussed further with the paradigm of serious games in Section 5.3.

2.3. Synthetic biomedical model

From a biomedical perspective, biofeedback paradigms are based either on cognitive training—or subcognitive regulation—of two specific skills acquired using a biosignal (Fig. 1): discrimination

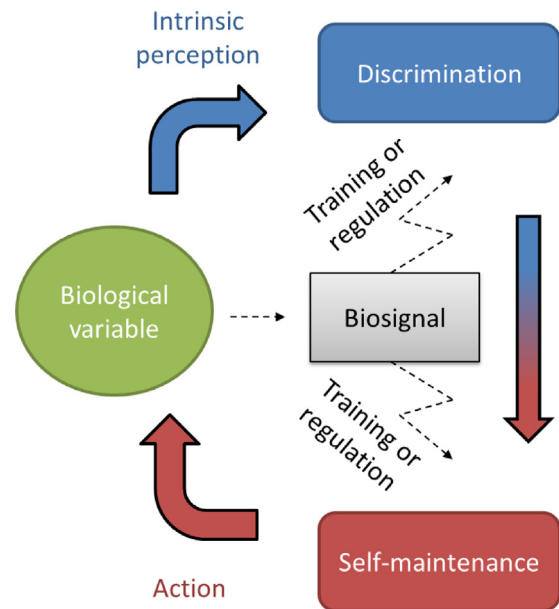

Fig. 1. Biomedical model of biofeedback.

(perception of the target biological variable) and self-maintenance (action over the biological variable). Successful training in either or both of these skills would lead to improved balance in the biological variable for patients suffering from medical conditions involving that variable, and the positive effect should remain when the feedback is turned off (otherwise the patient would be dependent upon the feedback system).

3. Psychological perspective

3.1. Operant conditioning: the reward problem

As we mentioned in Section 2.2, the mechanisms of biofeedback have traditionally been theorized using a behavioral approach inspired by Skinner's theories of OC (Skinner, 1938; Sherlin et al., 2011) and reinforcement learning (RL). The OC paradigm states that when a behavior has consequences (either rewards or punishments), it will be reinforced or repressed. In the case of biofeedback, the behavior is the regulation of an underlying biological variable, and the reinforcement signal is the success or failure of the subject to modulate the feedback signal. Such an approach is supported by animal studies: for example, prefrontal cortex neurons can be controlled by rhesus monkeys through an OC paradigm (Schafer and Moore, 2011). RL has two possible mechanisms (Sutton and Barto, 1998; Dayan and Berridge, 2014): either the subject is in a goal-directed setup and supports his learning from an internal model, in which case learning is termed as model-based RL; or the subject has no model of the outside events and learning arises from simple associations, termed as model-free RL. In the case of biofeedback and neurofeedback based on explicit feedbacks, a model-based RL is triggered: the subject seeks to reach a goal (regulating the feedback signal). In the case of biofeedback and neurofeedback based on implicit feedbacks, learning is more likely to follow a model-free RL mechanism. OC, and more specifically the SORC model (Goldfried and Sprafkin, 1976), has been used for decades to model the functional analysis of behaviors (Bellack and Hersen, 1988). In the SORC model (see Fig. 2), the behavior of an organism is modulated by the environmental feedback that is the consequence of its action. In other words, the action consequence acts as a reward signal.

However, whether for implicit or explicit feedbacks, the OC model for biofeedback has a fundamental limitation. The prob-

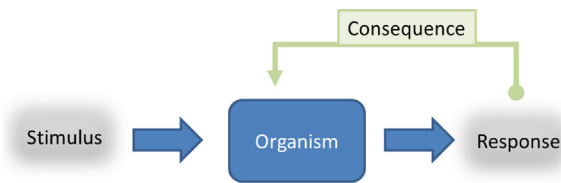

Fig. 2. The SORC model (Goldfried and Sprafkin, 1976), a behavioral model inspired by Skinner's theories on operant conditioning. SORC is an acronym for S-Stimuli, O-Organism variables, R-Responses, and C-Consequences. In this model, an individual's responses are thought to be a joint function of immediate environmental variables (stimuli and consequences) and of organism variables (physiological characteristics and past learning history) that the individual brings to the situation (Nelson-Gray and Farmer, 1999).

lem lies with the definition of the reinforcement signal. In animal experiments, it is standard practice to withhold food from a rat or a monkey and provide it later as a reward when the animal successfully modulates a biosignal, but it would be more difficult (and clearly unethical) to deprive human subjects of food. Furthermore, there is no guarantee that a human subject would interpret the biosignal as a reward: interpretation of the signal would depend upon the motivational state of the subject (see Section 5.3 about motivation).

The challenge is, therefore, to find an appropriate and effective reward to motivate human subjects. Rewards can be extrinsic when they take the form of external motivations (such as money, a pat on the back, or food) or intrinsic when based on self-motivation. Extrinsic rewards are maladaptive for human subjects: even if it were possible to control the rewarding effect of the biosignal, Lepper's studies on the overjustification effect (Lepper et al., 1973) demonstrated that extrinsic rewards have a detrimental effect on long-term motivation in human subjects, as they are perceived by human subjects as constraints rather than motivations. Extrinsic-reward-based strategies can therefore induce short-term stimulation followed by long-term aversive effects.

Another, more plausible option would be to base the reinforcement signal on intrinsic rewards. Intrinsic rewards are triggered when the action a subject takes is congruent with his internal motivation. When a human subject achieves learning toward proficiency in a skill (in the case of biofeedback, the skill would be discrimination and/or self-maintenance), exercising that skill provides an intrinsic reward. This intrinsic reward is the so-called flow state, obtained whenever a good balance is achieved between task difficulty and skill proficiency (Csikszentmihalyi, 1990). From this perspective, the implicit reward value of the biosignal in biofeedback paradigms would be intrinsic and due to achievement of a flow state, which involves voluntary attentional processes and higher cognitive functions. By integrating higher cognitive functions in the OC paradigm, one moves from behavioral learning theories to cognitive and developmental theories (explored in more depth in Section 3.2), which could explain the recent trend in neurofeedback publications toward cognitive strategies for the training of human subjects (Bagdasaryan and Le Van Quyen, 2013).

3.2. Developmental psychology and schemata

A central question in developmental psychology is how best to understand the acquisition of complex behaviors. Rats cannot surf the internet, dance the tango, or even solve the towers of Hanoi problem. These tasks involve the coordination of complex skills whose emergence cannot be attributed to simple reinforcement learning. To model the acquisition of such complex skills, psychologists have had to move away from learning theories grounded in behavioral psychology and notions of conditioning or reward and toward schemata formation and working memory (WM) span. We

will review these concepts here and explain how they can be used to model biofeedback mechanisms.

Piaget was the first to model human development, with a specific interest in childhood development. In 1926 he introduced the concept of schema (plural schemata), a cognitive structure representing organized knowledge of some part of the world that is acquired on the basis of experience (Piaget, 1971). The concept was further developed by Bartlett (Bartlett, 1932) and later by other developmental and cognitive psychologists. When new elements are encountered, a given schema could either be adapted to assimilate the element through an abstraction process, or be revised in order to accommodate the schema to the new element (Lewis and Durrant, 2011). The schemata theory has been successfully extended to development in adults and is still used to model skill acquisition (Weeks et al., 2013; Plant and Stanton, 2013). A neuroscience perspective regarding schemata formation and integration is presented in Section 4.

While it might appear that behavioral learning theories and developmental schemata integration theories are incompatible perspectives, it is possible to reconcile them. From a connectionist perspective, schemata emerge at the moment they are needed from the interaction of large numbers of much simpler elements all working in concert (Rumelhart et al., 1986). Reinforcement learning at a lower level can interact with integration mechanisms to become higher level skills, as has been suggested in recent cognitive neuroscience models of schemata (Lewis and Durrant, 2011), which we will discuss in Section 4.

Early in the development of schemata theories of skill acquisition, questions began to arise about how these skills evolve, since it became apparent that humans acquire skills through successive non-linear "steps." Strikingly, these steps are even evident in the acquisition of complex skills when children have already acquired their subcomponents. A child can learn motor and cognitive skills through apparently abrupt transformations. In order to model what happens between these discontinuous evolutions, the successors of Piaget (the so-called neo-Piagetians) introduced the concept of memory span (Pascual-Leone and Goodman, 1979; Case, 1985). Memory span is a limit on WM during the execution of tasks, the idea being that it is impossible to keep too many items in mind or execute too many cognitive operations simultaneously. The explanatory power of memory span resides in the explanation of developmental "steps" observed in children. Instead of proposing that schemata are created "out of nowhere," neo-Piagetians theorize mechanisms of progressive integration in which schemata with a higher degree of integration have a lower WM cost. Development, therefore, would move in observable steps, since whenever children have finished integrating their schemata they are suddenly able to coordinate more schemata and perform combinations of tasks. (A neuroscience perspective regarding schemata formation and integration is presented in Sections 4 and 4.2.)

A common observation in developmental skill acquisition is the U-shaped learning curve, representing a three-step process: good performance, followed by bad performance, followed by good performance once again (Carlucci and Case, 2013). The adoption of novel processing strategies leads to an increased cognitive load and to temporary losses of processing efficiency (Pauls et al., 2013; Siegler, 2004). Language acquisition models confirm that U-shaped behavior is unavoidable since human learners are limited by cognitive constraints (Carlucci and Case, 2013). If the cognitive load of a task is too high, performance will decline. This effect was observed early for biofeedback, where a transient decrease of galvanic skin response (usually following a U-shaped evolution) can be observed, representative of the increased attentional demand with the biofeedback (Gatchel et al., 1978; Montgomery, 1988; Freedman and Ianni, 1983; Gevensleben et al., 2014).

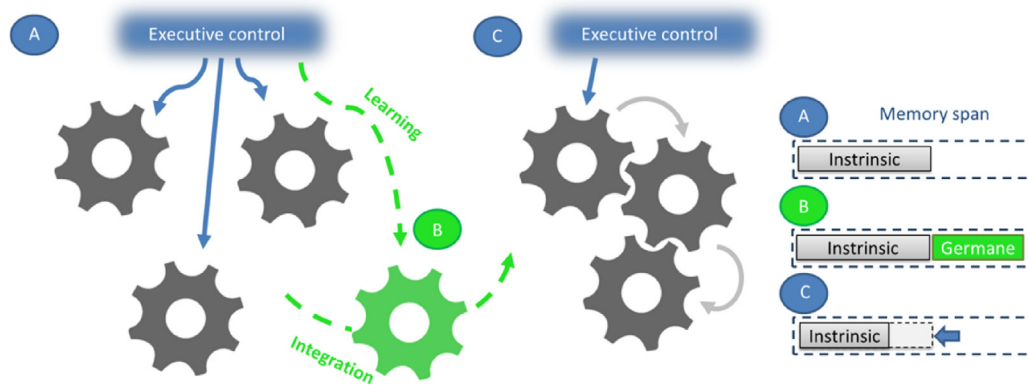

Fig. 3. The neo-Piagetian memory span model, cognitive load theory, and schemata integration. When a subject begins learning a task involving volitional control over a combination of schemata, the memory span is high. When learning begins (A), several storage and processing schemata have to be controlled, inducing a high intrinsic cognitive load. During learning (B), the use of learning schemata (in green) to integrate the processing and storage schemata increases the cognitive load. At this point, performance drops (performance follows a U-shaped curve) as the cognitive load increases (due to a germane cognitive load increase). After learning (C), the schemata are integrated and the cognitive load drops, leading to improvement in performance. (For interpretation of the references to colour in this figure legend, the reader is referred to the web version of this article.)

One explanation for this learning curve can be found in cognitive load theory (CLT) (van Merriënboer and Sweller, 2010). In CLT, WM is considered a resource divided between three different cognitive loads: intrinsic, extraneous, and germane. Extraneous load refers to the complexity of task presentation and is external to the subject. Intrinsic load refers to the amount of WM dedicated to task performance; it is high when element interactivity is high, i.e., when the subject has to process numerous elements (new elements not yet integrated into his own memorized schemata in long term memory). Germane load refers to the process learning load involving induction or “mindful abstraction,” whereby the subject performs abstractions on the schemata associated with the intrinsic cognitive load. We can see how this theory relates to the U-shaped learning curve (as illustrated in Fig. 3): when learning begins, subjects need to devote part of their WM to performing mindful observation of their WM in order to aggregate their schemata into a coherent new process. This increased germane cognitive load will in turn decrease performance. When the new schema is formed, performance improves again (since the intrinsic load is lower due to better schemata integration). It was already defended in 1989 by Zolten that biofeedback indeed follows the CLT predictions: “the better the clients are able to control their autonomic processes, the more efficient will be the organization of those processes when routinization occurs, and the clients will be able to direct their attentional abilities toward other important problem issues” (Zolten, 1989).

The classical perspective of Piaget restricts development of schemata to self-acquired experience (Piaget, 1971). However, both the social cognitive theory of Bandura (Bandura, 1986) and the social learning theories of Vygotski (Valsiner, 2012) placed social interaction at the heart of child development. Children learn more easily when learning is mediated by social interactions with a tutor (Dixon-Krauss, 1996). The tutor provides scaffolding, i.e., elements of a task that are initially beyond the learner’s capacity, thus permitting the child to concentrate upon and complete those elements that are within his range of competence (Wood et al., 1976). What a child is able to do today with instructional scaffolding, he/she will be able to do tomorrow alone (Valsiner, 2012). While the subject has limited abilities, with the help of a supervisor he/she is able to perform more complex tasks. What he/she can do alone is termed the “autonomy zone,” what he/she can do with help is termed the “zone of proximal development,” and what he/she cannot do even with help is termed the “rupture zone.” Numerous experiments have supported this model, demonstrating the direct impact of scaffolding on executive function, WM emergence, and

cognitive self-regulation (Valsiner, 2012; Hammond et al., 2012; Dilworth-Bart et al., 2010; Freund, 1990). Interestingly, cognitive self-regulation corresponds to the definition of self-maintenance in Section 2.1.

We will now illustrate with a simple example why schemata theory accurately models biofeedback effects. As noted in Section 2.2, a recent review (Lehrer and Gevirtz, 2014) attributed the effect of heart rate variability biofeedback to a combination of causes including: homeostasis in the baroreceptors, parasympathetic reflex stimulation, improved gas exchange, mechanical stretching of airways, anti-inflammatory effects, and attentional effects. As explained in Section 2.1, the effect of biofeedback is to improve biosignal control through the acquisition of two skills: discrimination and the self-maintenance. Here, both discrimination and self-maintenance can be seen as complex tasks; though a given subject may know how to sustain his attention, relax, or slow down his breathing, the coordination of these tasks is not necessarily a straightforward process. Similarly, though a subject can monitor his breathing, notice if he/she is relaxed or tense, and observe when his attention drops, the combined monitoring of multiple states can be challenging. In the case of heart rate variability biofeedback, therefore, discrimination and self-maintenance skills could be modeled as schemata. This example is not exceptional, as most biofeedback paradigms include involvement of executive function or attention (see Section 3.4 below). From this perspective, biofeedback provides scaffolding for the subject (Sanders and Welk, 2005), helping him/her to acquire or improve task-related discrimination and self-maintenance schemata.

3.3. Skill learning

Skill learning is a paradigm that describes the mechanisms involved in the acquisition of complex perceptual, cognitive, or motor skills. The effect of feedback is a variable of interest in skill learning—for example, it could be useful for the description of efficient coaching practices for motor skill acquisition. One can identify two significant properties of a motor action (Salmoni et al., 1984): its performance, i.e., the quality of the subject’s own movement (how to do the action); and its result, i.e., the success or failure of the action (what shall be done). The subject can learn about these two properties either by himself or with external help. When the subject has direct access to these two observables, it is termed “intrinsic feedback.” When the information comes from an exter-

nal source (for example, a sports coach or a device), it is termed “external feedback.”

The efficiency of external feedback for skill learning has been the object of several studies and some foundational truths have been demonstrated. First, extrinsic feedback helps to accelerate and facilitate the learning process (Poole, 1991), especially when it is not redundant with internal feedback (Schmidt and Wrisberg, 2007). It has informational functions and motivational properties with important influences on learning (Wulf et al., 2010), but it can also induce dependency (the so-called *guidance effect*): if administration of extrinsic feedback is not appropriate, performance decreases after the feedback is withdrawn (Buchanan and Wang, 2012). Second, the subject must be able to act upon his internal feedback when the external feedback is removed; successful feedback learning, therefore, is an adaptation of internal feedback in a way that incorporates the external feedback (Syznofzik et al., 2006). Finally, performance feedback is generally more effective for real-world tasks (Schmidt and Wrisberg, 2007).

The dissociation of performance feedback and result feedback can be observed for instance in skilled typists. Logan and Crump provided skilled typist with fake result feedbacks (Logan and Crump, 2010), either corrected errors that typists made or inserting errors in correct responses. When asked to report errors, typists took credit for corrected errors and accepted blame for inserted errors, claiming authorship for the result feedback. However, their typing rate showed no evidence of these illusions, slowing down after corrected errors but not after inserted errors. This dissociation suggests two error-detection processes: an outer loop sensitive to the appearance of the screen (result feedback) and an inner loop sensitive to keystrokes (intrinsic performance feedback). Another example in motor learning is voice control training or rehabilitation. Visual feedback on voice spectral properties can be used to train singers, and as one would expect, novice and expert singers require training tailored to their individual skill level: while beginners prefer simple and continuous information, experienced singers prefer more complex and discontinuous feedback (Hoppe et al., 2006). Internal result feedback develops with expertise, and therefore simple external result feedback is redundant and ineffective for experts. The results of the Sing & See project (Wilson et al., 2005) are of particular interest, as they illustrate how developmental psychology can explain feedback learning mechanisms: singers' performance dropped during feedback presentation but improved after feedback training (as compared to a control group). This is typical of a U-shaped performance curve (see Section 3.2).

Though motor skill learning theories cannot be directly adapted to explain biofeedback training, their core principles are similar in practice, and assumptions about efficiency of feedback from the motor skill model are likely to hold true for biofeedback. This model can easily be extended to any kind of feedback learning in general, including biofeedback and neurofeedback. The implications of skill learning for neurofeedback has already been debated by Strehl (Strehl, 2014). Skill learning theory models systems with explicit feedbacks, and therefore would relate to model-based RL mechanisms.

3.4. Executive function and attention

Biofeedback could not exist without involvement of executive functions and/or attention. Executive functions comprise the mental processes that enable individuals to take control over otherwise automatic responses of the brain in order to produce goal-oriented behaviors (Lamar and Raz, 2007; Garon et al., 2008; Lezak et al., 2012). They are strongly, but not exclusively, associated with neural networks located in the prefrontal cortex (Miller and Cohen, 2001) (more details in Section 4.3.). These executive functions allow individuals to handle new and/or complex situations where rou-

tine behavior does not exist or would prove suboptimal, and they include processes such as planning, goal setting, decision making, voluntary attention, task switching, set shifting, behavioral and perceptual inhibitions, voluntary emotional regulation, and error correction. In biofeedback paradigms, and especially when training is based on cognitive strategies (see Section 3), several executive functions appear to be essential to setting up an internal reward system (goal setting), integrating feedback information (voluntary attention, set-shifting), and adapting behavior toward self-maintenance (error correction).

Most of the aforementioned cognitive functions interact with attention, a broad concept that can be defined as the set of processes dealing with the allocation of WM to the different neural representations available in the brain (Knudsen, 2007). Many studies point to the common neural mechanisms that support both WM and attention (Ikka and Curtis, 2011a,b; Gazzaley and Nobre, 2012), reinforcing the idea of an overlap between the two functions. Because high-level cognition relies on WM's limited span (Cowan, 2005; Cowan et al., 2005), attention plays a crucial role in learning tasks where WM is partly occupied by learning schemata (see Section 3.2).

3.5. Working memory models

There are good reasons to hypothesize that WM plays a key role in biofeedback learning. The central role of WM is emphasized in motor skill learning (Seidler et al., 2012), and by definition, this theoretical construct intersects with all cognitive functions (see Section 3.4). While performing any cognitive task, information being processed is stored and maintained in WM. Miller coined the term “working memory” while studying everyday formation, transformation, and execution of plans in the context of behavioral science (Wallace, 1960).

3.5.1. Multiple-component model

Baddeley and Hitch's model (Baddeley and Hitch, 1974) remains the most influential model of WM. The original model included two slave storage subsystems in charge of storage and maintenance of visual and auditory information; and a coordinating system, the central executive. The central executive coordinates the slave subsystems, activates memory traces from long-term memory (LTM), selects coding strategies, and shifts attention. Two main criticisms of the concept of a central executive have been (1) that it is depicted as an homunculus, an all-powerful man running WM, and (2) that the lack of rigorous evidence makes it impossible to falsify (Parkin, 1998). A new slave system, the episodic buffer, was later introduced by Baddeley (Baddeley, 2000). The episodic buffer stores multi-dimensional pieces of information integrated by the central executive into time-ordered episodes, like fragments of a story. These episodes are then linked to multi-dimensional representations in LTM.

3.5.2. Embedded-process model

Cowan's model of WM (Cowan, 1988) outlines more precisely the mechanisms underlying attention and extends the notion of slave subsystems to more general types of encoding. In terms of flow, information enters the brief sensory store and is retained for several hundred milliseconds, whereupon LTM representations (sensory or semantic) become active and remain so for a few seconds. Depending on the salience of the stimuli and/or voluntary attention, the activated memories may enter the focus of attention or remain outside of it (yet still active). The attentional processes are mediated by the central executive, which can direct attention either outward to perceived stimuli or inward to LTM. The processing of activated traces of LTM might lead to controlled actions if information passes through the focus of attention or to automatic

actions otherwise. LTM storage of some coded features occurs automatically. Processing in this model can also be performed on active items outside the focus of attention.

3.5.3. Long-term working memory

Traditional models of WM perform rather well on laboratory tasks. However, the large storage demands of text comprehension and other skilled activity (e.g., good chess players, digit span experts) cannot be explained by models that rely only on temporally limited capacity (Anders Ericsson and Kintsch, 1995). To address this problem, Anders Ericsson and Knitsch proposed their long-term working memory (LTWM) model. Based on experimental findings (Anders Ericsson and Delaney, 1999) that conflicted with other WM models, they proposed the idea that skilled activity in everyday life does not rely heavily on temporal storage. On the contrary, while skills are developing, domain specific semantic structures are built in LTM that allow for efficient coding and fast retrieval, and hence LTM largely mediates expert performance.

3.5.4. Time-based resource-sharing model

A model of WM that proposes an interesting definition of cognitive load is the time-based resource-sharing model (TBRS) (Barrouillet et al., 2004). The main assumption of the TBRS model is that attentional resources, serial in nature, are needed not only for processing information, but are also shared with activation and maintenance processes. This holds true both for complex tasks as well as for simple activities like reading letters or digits.

Within this model, quick pauses are required during processing in order to maintain the memory traces, which would otherwise decay over time. This process does not necessarily correspond to rehearsal in the phonological loop proposed by Baddeley since different mechanisms could occur, such as the rapid and covert retrieval process through attentional focusing proposed by Cowan (Cowan, 1992). This attentional switch might occur constantly and at the micro level, as described in the micro-task-switching process by Towse et al. (Towse et al., 2007). This process is serial in nature at the micro level, yet rapid enough to seem parallel at the macro level.

Due to this attentional constraint, it is important to redefine the notion of cognitive load. A high load condition should involve not only the number of active items, but also the available time that can be devoted to attentional switches to refresh memory traces. If the task allows enough time to ensure proper maintenance of memory traces, it is said to correspond to low cognitive load, and conversely,

if high processing demands leave little time for refreshing, the task is said to involve high cognitive load. In this sense, the concept of load becomes task dependent.

3.6. Volitional action, agency, and fluency

In Section 2.2, we mentioned that biomedical models of biofeedback disagree over the need for volitional control of the regulated biological variables. Volitional action is associated with authorship of the action, a sense of agency or self-agency—the sense that “I am the one who is causing or generating an action” (Gallagher, 2000). In other words, a sense of agency refers to the feeling of controlling an external event through one’s own actions. Agency is at the center of neurocognitive models of schizophrenia as an explanation for volitional delusions (Lafargue and Franck, 2009). Interestingly, agency seems to be linked with both internal and external feedback about self-control (Syznofzik et al., 2006) and therefore has a direct relationship to fluency. Fluency is the subjective experience of ease or difficulty associated with completing a mental task (Oppenheimer, 2008) and therefore relates to the perception of self-control or self-regulation. Monitoring of physical efforts by a subject, for example, can lead to a retrospective sense of fluency, which can in turn contribute to a sense of agency (Demanet et al., 2013). This is not a new observation; Maine de Biran proposed in 1805 that the sensation of effort might provide an internal cue for distinguishing self-caused changes from other changes in the environment (Maine de Biran, 1805). Recent reports have shown that a sense of agency would be derived from both a prospective (action selection) and retrospective (action outcome) fluency (Chambon et al., 2014).

This relationship between agency and self-regulation is critically important for biofeedback training. First of all, successful volitional biofeedback induces improved fluency in regulation of the biological variable and consequently involves a sense of agency. Furthermore, self-regulation can be seen as one aspect of executive function, whose depletion has negative effects on task performance—the so-called ego depletion effect (Vinney and Turkstra, 2013). Again, this ego depletion effect predicts a drop in performance during effective biofeedback, in line with developmental psychology models (Section 3.2).

3.7. Synthetic psychological models

Biofeedback is concerned with a specific subtype of skill learning: biological variable regulation. Biofeedback setups provide the

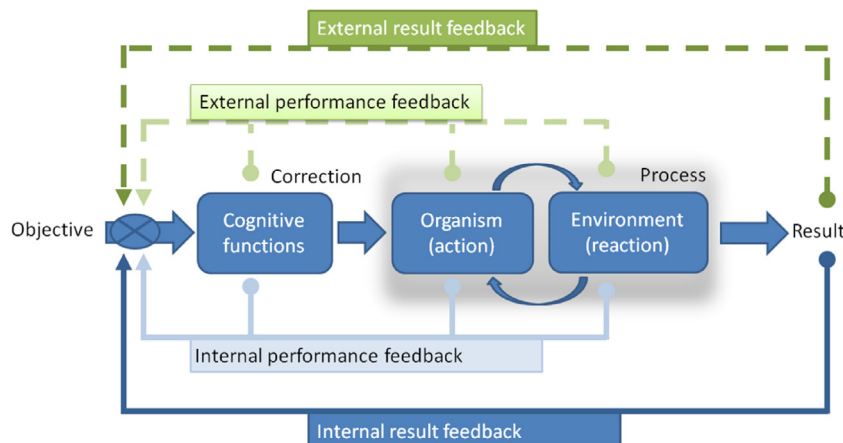

Fig. 4. Four-component biofeedback flow chart. The subject has access to two internal feedbacks (bottom of flow chart). The internal performance feedback corresponds to the discrimination skill. Succeeding or failing to regulate the biological variable is the result feedback. The biofeedback provides either external result or external performance evaluations to the subject (top of the flow chart). The self-maintenance skill integrates both internal and external feedback and regulates the biological variable based on these inputs.

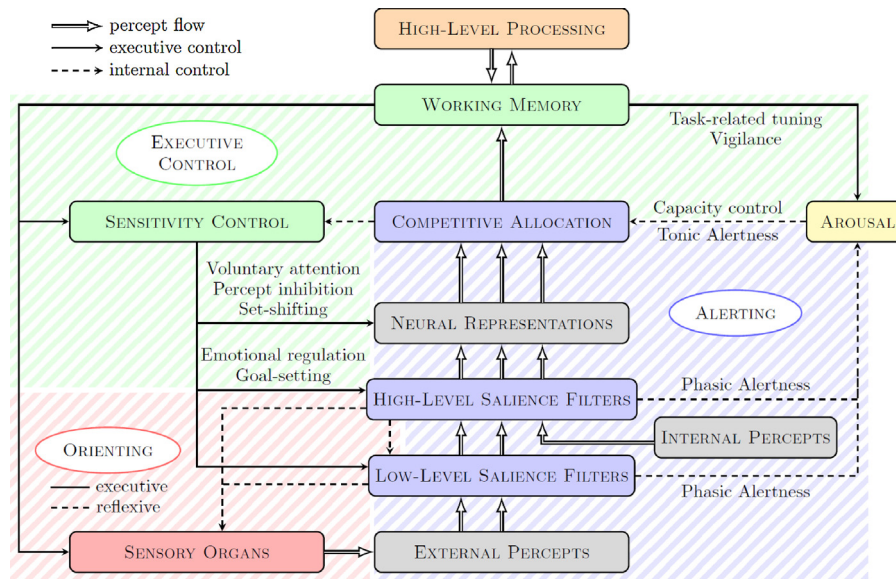

Fig. 5. Integrative model of attention and executive control. The role of attention is assumed to be the allocation of working memory between available percepts. Blue nodes represent the main components of attention, responsible for evaluation and selection of relevant information as well as executive feedback over the selection process. Red nodes are brain structures strongly linked with attention. Long-term memory could be represented as a red node as well. Green nodes are abstract representations of information flow and processing. Executive functions linked to the control of attention are represented in purple. (For interpretation of the references to colour in this figure legend, the reader is referred to the web version of this article.)

user with external feedback, while the discrimination skill is an internal performance feedback. The self-maintenance skill integrates both internal and external feedback and acts on the biological variable. As with motor learning, biological variable regulation seeks an effect involving the organism and its environment and has a directed functional goal; succeeding or failing to reach this goal is the result feedback. The main difference from motor learning resides in the type of action involved: while motor action learning involves sensorimotor processes, biofeedback is more general and can include any kind of biological variable. We can summarize these elements in a general biofeedback flow chart with four types of feedbacks: external result feedback, external performance feedback, internal result feedback, and internal performance feedback (Fig. 4).

A framework for the different executive functions involved in biofeedback, largely inspired by the work of Knudsen (Knudsen, 2007), is shown in Fig. 5. This model includes several levels of salience filters that attribute weights to both external and internal percepts based on their physical, temporal, motivational, and emotional properties (Menon and Uddin, 2010). The resulting neural representations then go through a competitive selection process to determine which information enters WM. This filtering layer is referred to as bottom-up attention and will, for example, allow a loud, unexpected sound to enter almost anyone's WM (in addition to triggering subcortical responses). Top-down signals can alter this selection process by modifying the behavior of salience filters (e.g., emotional regulation) or by enhancing or inhibiting a neural representation that has already entered WM and has gained or lost salience through high-level processing (voluntary attention and percept inhibition, respectively). Feedback signals can also modify the behavior of sensory organs at several levels of this weighting/selection process—for example, by orienting the eyes toward a stimulus to enhance its relative importance in the visual cortex. Other executive functions deal with the temporal allocation of WM and can therefore be considered components of attention. Set-shifting, for example, refers to the ability to switch between different high-level neural representations of a percept on the basis of feedback and is therefore an important mechanism in learning and biofeedback paradigms (Kehagia et al., 2010). Sustained atten-

tion is another key component of attention and refers to the ability to maintain neural representations in WM over time (Gazzaley and Nobre, 2012). This cognitive function is also strongly involved in the learning process described in Section 3.2, as both feedback information and learning schemata should be maintained in WM during the integration process.

As explained in Section 2.1, the interest of biofeedback is to help train two cognitive functions related to a target biological variable: discrimination and self-maintenance. Acquisition of the discrimination skill requires the subject to find an internal or autogenous percept that matches the fluctuation of the external feedback. This process requires the subject to scan the different percepts available to him/her at a given time (selective attention) and to manipulate their different neural representations (set-shifting) in order to find out if a correlation can be established with the feedback. Training of the discrimination skill is greatly facilitated by joint or prior development of the self-maintenance function, i.e., the ability to affect the biological variable voluntarily. Intended modification of the biological variable allows the subject to more easily confirm or contradict a possible correlation between an internal or autogenous percept and the external feedback than would mere observation of natural fluctuations in the biological variable. Development of the self-maintenance skill also requires the subject to try several approaches to infer whether or not a behavior has an influence on the feedback. Both functions are therefore acquired using typical learning strategies that involve reinforcement in the case of a positive correlation and error detection/correction otherwise.

4. Neuroscience perspective

4.1. Neural correlates of schemata formation

Straightforward links can be established between schemata theory and functional neuroanatomy (Johnson and Grafton, 2003; Cannon et al., 2008). Schemata correspond closely to biological networks of neurons usually termed "neural assemblies." A neural assembly is a small set of interconnected neurons that can persist without external stimulus, connected by learning and supported by synchronous firing behavior (Huyck and Passmore, 2013).

The “information overlap to abstract” (iOtA) model of Lewis and Durant (Lewis and Durrant, 2011) theorizes that schemata are created through reinforcement of synaptic connections of overlapping memories: when a group of neural assemblies are activated simultaneously, their common overlapping networks are reinforced. Through progressive abstraction due to synaptic homeostasis, a new assembly of neurons could be gathered into abstract schemata combining elements of these memories. Despite the likelihood that other biological mechanisms may also underlie the formation of schemata, such mechanisms have not yet been described (Huyck and Passmore, 2013), so the iOtA model is the most complete available.

The formation of neural assemblies occurs in two steps (Frankland and Bontempi, 2005). First, a transient neuronal assembly is formed to deal with a task, leading to short-term memory organization. The hippocampus probably plays a key role at this stage, especially for episodic memories (Shirvalkar, 2009). Reactivation of the assembly leads to its consolidation and the formation of a long-term memory through reinforcement learning (RL), stored in cortical networks. Classical models assume that memories are consolidated during sleep, but experimental evidence shows that this process can also occur during waking states (Axmacher et al., 2009). The ventromedial prefrontal cortex and the hippocampus may interact at this stage for schema formation and possibly in the representation of partially consolidated schemata (van Kesteren et al., 2010). Furthermore, schema acts as memory containers facilitating encoding: when a schema exists, the assimilation of new mnemonic traces into the schema can occur extremely quickly, and become rapidly hippocampal-independent (Tse et al., 2007).

A functional model of the neural correlates of schemata could be found in the notion of actor strategies in the prefrontal cortex (Koechlin, 2014; Collins and Koechlin, 2012). Actors are task sets driving ongoing behavior, stored in long-term memory. Koechlin’s theory (Koechlin, 2014, 2016) provides a model integrating schemata learning and self-control networks. While existing actors are used and reinforced through model-free RL (see Section 3), they are evaluated by the prefrontal cortex (PFC), and monitored by the anterior cingulate cortex (ACC). Cascade of interactions can be observed between the dorsolateral PFC and the anterior cingulate cortex, involved in response evaluation upon action performance (Banich, 2009). When the ACC detects suboptimal strategies, a model-based RL mechanism would be triggered in order to create a new actor. Once a new efficient actor is learned, model-free RL progressively dominates with time. Model-free RL and model-based RL form two cooperative systems with model-free RL driving online behavior and model-based RL working offline in the background to continuously adjust model-free RL (Sutton and Barto, 1998; Gershman et al., 2014; Koechlin, 2016). It can easily be seen that this theory articulates model-free RL mechanisms for schema assimilation and model-based RL mechanisms for schema accommodation (new actor creation), which bridges the gap between the CLT in psychology (Section 3.2) and RL mechanisms in neuroscience. The germane load could find a potential neural correlate in the frontopolar cortex, involved in the cognitively costly evaluation of new strategies in model-based RL by (Koechlin, 2014). A recent study illustrates this effect and indicate a neural correlate of the germane load: subjects exposed to a slow cortical potential followed a U-shaped evolution of neuronal resource allocations, measurable using the contingent negative variation (CNV) at the Cz electrode (Gevensleben et al., 2014), which was not observed in the sham group. The role of the PFC, the cognitive control network and the ACC are discussed with more details thereafter in Sections 4.3, 4.4 and 4.5.

4.2. Schemata and working memory

WM, or the processing of short-term memory, is fundamental to the functioning of schemata. As neural activity persists in subregions of the PFC and posterior parietal cortex (PPC) during maintenance of WM representations (Ikkai and Curtis, 2011a,b), one could consider these two brain regions together as the location of WM neural substrates.

Two subfunctions of WM have been identified: information storage and executive processing of stored data. Neuroimaging evidence links the short-term memory storage function with the ventrolateral PFC (Smith and Jonides, 1999; Stokes, 2015; Ester et al., 2015) and the PPC (Ester et al., 2015; Ikkai and Curtis, 2011a,b). The executive component, on the other hand, appears to be mediated by the dorsolateral PFC (Smith and Jonides, 1999), whose causal role is supported by transcranial magnetic stimulation studies (Mottaghy, 2006).

There are three hypotheses regarding the neural basis of WM storage. First, information could be stored in the PFC and PPC themselves; in fact, brain activity in these areas can be used to reconstruct orientation bars stored in visual WM (Ester et al., 2015). A second hypothesis is that WM is not stored in persistent neural activity, but instead in the combined interaction of ongoing activity and the hidden state (activity-silent states) in the brain’s structural connectivity (Stokes, 2015). This hypothesis is supported by the fact that dynamic states of neural networks are combinations of their ongoing activity, underlying connections, and short-term synaptic plasticity (Buonomano and Maass, 2009). The final hypothesis proposes a mediating role for the lateral PFC. Recent studies combining TMS and neural measures have shown that the lateral PFC modulates sensory activity during WM tasks and enhances selectivity of representations in the sensory cortex (Sreenivasan et al., 2014). According to these results, and in line with Cowan’s WM model (Section 3.5), the WM would not be stored in the lateral PFC, but instead stored in the sensory cortex and mediated by the lateral PFC (whose activity would therefore be a correlate of sensory cortex activity). There is no consensus yet on these three models. However, a recent study demonstrated that noise learning is accompanied by rapid formation of sharp neural selectivity to arbitrary and complex acoustic patterns within sensory regions (Andrillon et al., 2015). This is the first experimental confirmation that schemata bridge the gap between sensory and memory processes, and a validation of Cowan’s hypotheses.

The iOtA model is compatible with all three theories of WM storage, fitting best with the second (activity-silent states) theory. The model describes schemata as neural assemblies involving structural networks of neurons, a description that is consistent with activity-silent states. The TBRS model (see Section 3.5.4) is more compatible with the third theory (lateral PFC mediation of WM), as it separates the storage function from the storage location.

4.3. Executive functions and the prefrontal cortex

As mentioned in Section 3.4, executive functions play a key role in the integration of feedback in skill learning. Two frontal brain regions are central to several executive functions (Logue and Gould, 2014): the medial PFC, involved in general attention and set-shifting tasks; and the orbitofrontal cortex, involved in reversal learning and response inhibition tasks.

Koechlin’s hierarchical model of cognitive control (Koechlin et al., 2003; Koechlin and Summerfield, 2007) is a multistage architecture along the anterior–posterior axis of the lateral PFC where each stage maintains active representations that are controlled by

higher stages and that exert control on representations in lower stages. Control signals owing to events which occurred in the more and more distant past would arise from successively more anterior cortical regions. In this model, the apex of the prefrontal executive system is implemented in the most anterior prefrontal regions and corresponds to control processes underlying multitasking and the temporary maintenance of pending behavioral episodes. Logan and Crump's hierarchy of loops (Logan and Crump, 2010) involved in result (outer loop) and performance (inner loop) error-detection processes is compatible with this hierarchical model. Together, these models can explain the differences observed between result and performance feedbacks in skill learning (see Section 3.3).

There is general consensus about the nature of the PFC's mediation of executive functions (Smith and Jonides, 1999). PFC areas modulate the activity in sensory cortices, thereby allowing for voluntary control of brain functions. Similarly, emotional regulation involves a network of areas in the PFC, hippocampus, and parahippocampus (Phillips et al., 2008). The PFC most likely plays a central role in executive control of the brain: several reports indicate that top-down signals originating in the LPFC (representing current task goals) implement cognitive control by biasing information flow across multiple large-scale functional networks (Miller and Cohen, 2001; Cole et al., 2013). This specific role in cognitive control will be addressed in the next section.

4.4. Self-control networks

As noted in Section 2.1, the voluntary control of biosignals attempted in biofeedback paradigms depends on two functions: discrimination and self-maintenance. Here we will report recent evidence about the neural correlates of cognitive control, which could stand as potential candidates for the neural basis of self-maintenance. Recently it has been hypothesized that neurofeedback might tune brain oscillations toward a homeostatic point through a top-down regulation mechanism (Ros et al., 2014). If this theory is true, then top-down control of brain functions would play a key role in neurofeedback, even in autonomous (non-volitional) regulation neurofeedback models (see Section 2.2 for a discussion of volitional and autonomous regulation strategies).

The cognitive control network (CCN) is a brain network thought to underlie cognitive control capacity (Dosenbach et al., 2006; Cole and Schneider, 2007); to correlate with fluid intelligence (Cole et al., 2012a,b); and to support executive functions in general (Niendam et al., 2012). Regions within the CCN include the ACC and pre-supplementary motor area (pSMA), inferior frontal junction (IFJ), anterior insular cortex (AIC), dorsal premotor cortex (dPMC), and a subnetwork termed the frontoparietal network (FPN) that includes portions of the lateral prefrontal cortex (LPFC) and the posterior parietal cortex (PPC) (Cole and Schneider, 2007; Cole et al., 2013). The FPN acts as a hub that coordinates cognitive control (Cole et al., 2013); it centralizes functional connections with multiple brain networks and is involved in a wide variety of tasks. Furthermore, these connections form an organized framework, with systematic relationships between the types of tasks and the corresponding connectivity patterns. Consequently, the FPN can coordinate brain networks according to the requirements of the task, thereby enabling the transfer of abilities across tasks. The CCN is considered the neural seat of cognitive control, and therefore is a good candidate for the neural basis of self-maintenance; in a recent fMRI study, sham neurofeedback was indeed associated with activation in three areas of the CCN: the LPFC, ACC, and AIC (Ninaus, et al., 2013).

The CCN is likely not the only neural network supporting the self-maintenance function. In situations of wakeful rest such as day-dreaming, activity in a network of brain areas termed the default mode network (DMN) can be observed (Buckner et al.,

2008). Recent investigations have observed that cognitive control may actually be the outcome of dynamic functional couplings between the FPN system, the cingulo-opercular network, and the DMN (Cocchi et al., 2013). By applying network control theory on human diffusion tensor imaging, Gu et al. recently confirmed that: (i) DMN areas may be important in low cognitive effort tasks, (ii) the FPN and cingulo-opercular areas may be important in high cognitive effort tasks, and (iii) attention areas may be important in manipulating information across different cognitive processes (Gu et al., 2015). Furthermore, the FPN is anatomically positioned to integrate information from the attention system and the DMN (Vincent et al., 2008). From this perspective, the CCN, attentional networks, and DMN would share access to cognitive processes depending on the type of task. This observation confirms recent evidence pointing to correlations between dynamic interactions of the CCN and DMN on the one hand, and cognitive control performance of adolescent subjects on the other (Dwyer et al., 2014). This is also consistent with the dual-process theory mentioned in Section 2.2 (Wood et al., 2014), with the DMN corresponding to low-level processing and the CCN to high-level processing.

Finally, as explained in Section 3.6, a sense of agency would be directly related to the perception of self-maintenance. According to one meta-analysis, self-agency appears to involve the insula and the experience of a "global emotional moment" representative of the sequential integration of perceptive and motivational information (Sperduti et al., 2011). The angular gyrus (AG) may also play a key role in monitoring signals relating to action selection in the dorsolateral prefrontal cortex in order to prospectively inform subjective judgments of control over action outcomes. The online monitoring of these signals by the AG might provide a subject with subjective markers of volition prior to the action itself (Chambon et al., 2013), and therefore the AG might be a neural substrate of the sense of agency (Chambon et al., 2014). The main electrophysiological markers of a sense of agency in EEG signals are the alpha-band relative power in the central, parietal, and right temporal areas, as well as alpha phase coherence in frontal areas (Kang et al., 2013). The correlates of fluidity in EEG are the error potentials reported in the next section.

4.5. Consciousness of errors and error potentials

Action monitoring and error processing are two critical stages of executive control in humans, allowing for efficient behavioral adjustment and optimization of performance. These functions therefore play a central role in skill learning and are good candidates for neuronal markers of the discrimination function defined in Section 2.1.

Correct overt responses are frequently preceded by an early sub-threshold electromyographic burst recorded from the hand that is associated with the incorrect response (Burle and Bonnet, 1999). These bursts that occur in about 20% of correct response trials represent partial errors (Hasbroucq et al., 2009). If the correct response is provided by the subject, this means that the partial error has been identified and corrected, preventing an overt error. Rochet et al. studied whether partial errors are consciously detected by subjects (Rochet et al., 2014), and they showed that less than one-third of partial errors were reported. Even if partial errors are not consciously detected, however, they are being corrected for before producing an overt error.

One might ask: is it helpful to be aware of our errors if two-thirds are not reported but still corrected? Biofeedback could be used to explore brain mechanisms implicated in error monitoring and whether being aware of our errors has consequences on error processing and skill learning. Indeed, errors can be corrected without awareness before they reach the threshold of response. However, in situations where partial errors have been consciously detected,

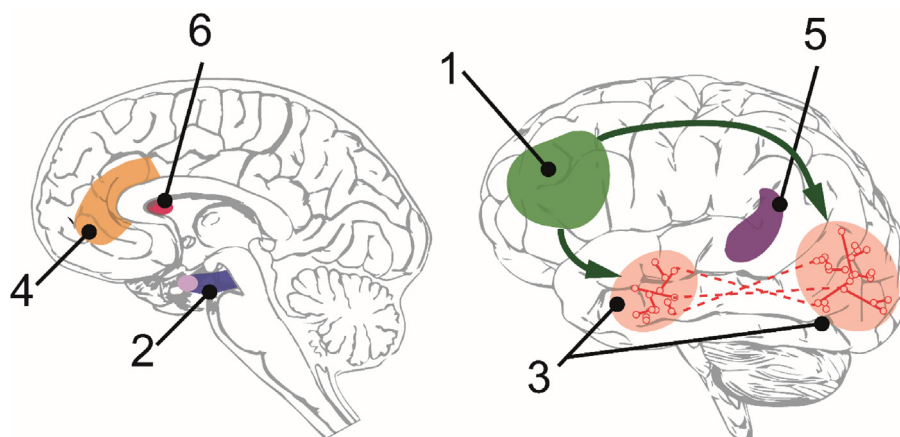

Fig. 6. Feedback learning from a neuroscience perspective. The user is focusing his executive functions on the task, involving the DLPFC (1) and the CCN (not represented in the illustration). Working memory is coordinated by these networks, involving both his hippocampus (2) and the neural assemblies supporting task performance (3) under the supervision of the DLPFC (1). Error monitoring in the ACC (4) allows the user to perceive fluidity, which is then converted into agency by the AG (5). If agency is perceived, and the user is training through a trial-and-error process, then the ventral striatum (6) activates. This leads to the formation of a schemata, progressively integrated and abstracted from the areas involved in the task (3) and consolidated into long-term memory as a skill.

it would be of interest to investigate whether they are corrected through the same processing mechanism or if other adjustments occur (such as a change in strategy). Evoked related potential (ERP) can be useful in exploring error monitoring and might be employed in biofeedback to investigate error monitoring mechanisms.

Errors in reaction-time tasks induce a response-locked ERP that peaks within 50–100 ms after the erroneous response. This ERP is a fronto-central negative deflection, and because it was originally reported as being absent following correct responses, it has been called error negativity or Ne (Falkenstein et al., 1991), or error-related negativity or ERN (Gehring et al., 1993). The Ne is strong evidence for the existence of an action monitoring system able to quickly separate errors from correct responses at the very moment of response (Vidal et al., 2015). In 2000, Vidal et al., by applying the Laplacian transformation, observed a smaller Ne-like potential following correct responses. Actually, Laplacian-transformed data argues in favor of a single-generator hypothesis (Vidal et al., 2015) for the Ne, and the Ne is sensitive to the correctness of the ongoing response. Previous studies suggest that Ne may remain present even when subjects are unaware of having made a partially erroneous eye-movement. It seems that Ne is generated independently of the conscious detection of errors (Nieuwenhuis et al., 2001; Endrass et al., 2007; O'Connell et al., 2007). More generally, the midline frontal theta power—the position and frequencies where Ne is observed—might be the best EEG marker for cognitive control (Cavanagh and Frank, 2014). The error positivity (Pe) is a positive deflection with more parietally distributed ERP than the Ne. It occurs 200–400 ms after a conscious erroneous response (Falkenstein et al., 1991; Nieuwenhuis et al., 2001; Overbeek et al., 2005). The amplitude of Pe is sensitive to the degree of awareness of an error (Dockree and Roberston, 2011) and is larger for conscious than unconscious errors (O'Connell et al., 2007; Charles et al., 2013; Logan et al., 2015). Ne and Pe are therefore neural correlates of volitional self-monitoring of errors.

4.6. Motivation and reward

As explained in Section 3, motivation and reward are central components of biofeedback mechanisms. Motivation involves dopaminergic circuits in the reward system, where the striatum plays a key role (Yager et al., 2015). Monitoring the neural correlates of motivation and reinforcement learning would provide direct insights into biofeedback learning mechanisms.

Volitional self-monitoring of errors is associated with Ne and Pe. When feedback is presented, a specific Ne can be recorded: feedback-related negativity (FRN), which follows the display of negative feedback (Miltner et al., 1997; Walsh and Anderson, 2012). FRN may be the best neural correlate of the reinforcement learning process (Walsh and Anderson, 2012) for several reasons: (1) FRN represents a quantitative prediction error; (2) it is evoked by rewards and by reward-predicting stimuli; (3) FRN and behavior change with experience; and (4) the system that produces FRN is maximally engaged by volitional actions. According to a recent joint EEG-fMRI investigation by Hauser and colleagues (Hauser et al., 2014), FRN could be a neural correlate of surprise signals involving top-down cognitive control in the ACC and may therefore be a good neural marker of fluency in feedback learning (see Section 3.6).

One well-studied ERP component that seems to play a role in reward processing is the P3 (or P300), a positive wave usually peaking between 300 and 600 ms post-stimulus with its largest amplitude at centroparietal scalp sites. When comparing P300 and FRN, reward magnitude (how much reward is received) is reflected by the P300 ERP but not by feedback negativity, while reward valence (positive or negative reward) was reflected by feedback negativity only (Yeung and Sanfey, 2004).

4.7. General model of feedback learning

Feedback learning is the generalization of skill learning to cognitive functioning. The principal brain areas involved in this learning process are illustrated in Fig. 6. The user is performing a learning task that involves both the executive functions and the self-control networks. During learning, working memories and neural assemblies are activated under the monitoring of the central executive (involving the CCN and the DLPFC). Error detection is related to fluency and agency, involving the ACC and the AG: AG playing a key role in the sense of agency (Chambon et al., 2014), while ACC is involved with error detection (Bush et al., 2000). If the protocol leads to motivating conditions (mainly intrinsic motivation in volitional biofeedback), then the reward system activates. Finally, feedback learning leads to the formation of coordinated and integrated neural assemblies through reinforcement of synaptic connections among overlapping memories. The resulting schemata have lower intrinsic cognitive load because the CCN will not need to coordinate the underlying neural assemblies anymore (the task is automated now; see Fig. 3).

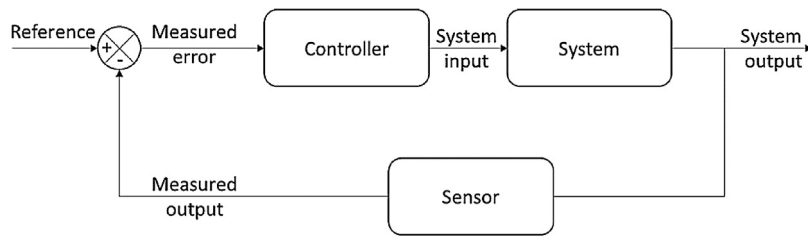

Fig. 7. Basic control theory model. Block Diagrams are graphical representations of processes. This diagram represents a closed-loop model, where a feedback is a correlate of the output returned back to the input to form part of the systems excitation.

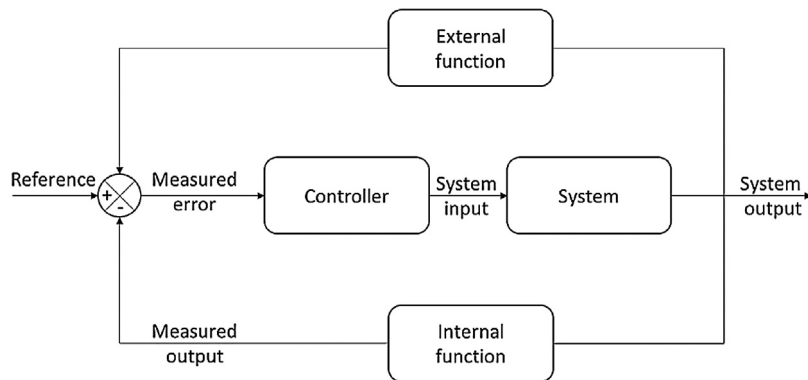

Fig. 8. Explicit model of biofeedback and neurofeedback. The feedback is subdivided into internal and external feedback, where the external feedback comes from an external device and the internal one is within the central nervous system of the subject.

Note that whereas conscious error monitoring involves the ACC, subliminal error monitoring does not (Dehaene et al., 2003). Implicit feedback strategies may indeed not involve the same mechanisms: they are more likely to be based on model-free RL mechanisms (Dayan and Berridge, 2014). Explicit feedbacks would foster schema accommodation with a model-based RL mechanism; whereas implicit feedbacks would foster schema assimilation with a model-free RL mechanism.

5. Engineering perspective

5.1. Process control models of feedback learning

In engineering, process control is a discipline that aims to maintain the output of a process in a certain desired state (Murrill, 2000; Bennett, 1993; Levine, 2010). For example, a thermostat on a heater can turn the heater on or off by comparing the temperature measured by a sensor to a reference temperature. Once the target temperature is reached, the difference between the room temperature and the target temperature is zero, so the thermostat stops the heater. Process control can work in an open loop or by using feedback (Wills, 1960). It can be continuous or discrete – causing a sequence of events (Levine, 2010). Its application to biomedical engineering models was first suggested by Norbert Wiener in 1948 who introduced cybernetics to model self-regulating mechanisms (Wiener, 1948 2nd revised ed. 1961; Mindell, 2002; Ross Ashby, 1956), and was soon identified as a framework to model biofeedback (Anliker, 1977). It is now commonly used to model systems biology (Cosentino and Bates, 2011), and was recently applied for instance to model biological motor systems (Scott, 2004) and their cognitive control (Frith et al., 2000), or speech acquisition (Tourville and Guenther, 2011; Vinney and Turkstra, 2013), and generally the behavior of biological organisms (Cowan et al., 2014). Biofeedback and neurofeedback are also often modeled using control theory, such as neurofeedback training of implanted brain-computer interface (Guenther et al., 2009), for biofeedback training of postural

control (Ersal and Sienko, 2013), biofeedback techniques in renal replacement therapy (Paolini and Bosetto, 1999), or electrodermal biofeedback of arousal (Parnandi et al., 2013). It was also suggested as a general model for neurofeedback (Ros et al., 2014).

Feedback can be positive or negative (Ross Ashby, 1956; Black, 1934)—terms that can refer either to the way we widen or narrow the gap between reference and measurement of a parameter, or to the valence of the action on the gap, which can have positive or negative emotional connotations.

5.1.1. Controllability

A deterministic system can be fully described by the set of values of all its state variables at a given time. These state variables are characterized by dynamic equations, and prior knowledge is not necessary to predict future states given the current state and current and future values of control variables. Controllability describes the ability to control the internal state of a system from an initial state to a final state in a finite time interval (Kalman, 1960). Controlling a system means being able to move it in all its configuration space using some determined displacements.

5.1.2. Observability

Observability is a measure of a system's predictability according to knowledge of its external outputs. A system is observable if the current state can be determined in a finite time using only its outputs, for any possible sequence of states and control (Kalman, 1960). If a system is not observable, it means that the current value of some of its state cannot be determined using the output sensors; they are unknown to the controller, but can be estimated under certain conditions.

5.1.3. Basic model

The basic model of feedback in process control theory can be illustrated as in Fig. 7 (Murrill, 2000). A sensor is used to measure the output of a system. This output is then compared to a reference value so that the error between measured output and reference can

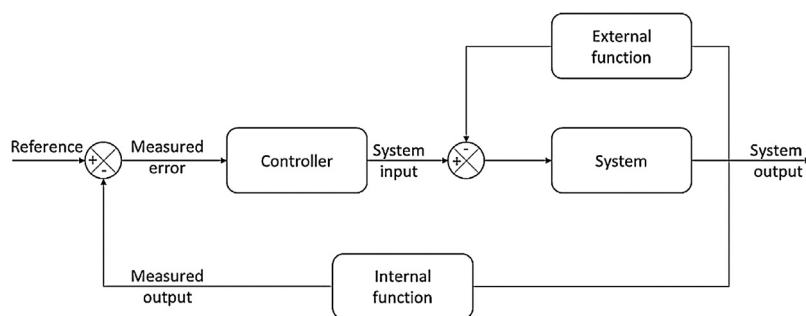

Fig. 9. Implicit model of biofeedback and neurofeedback. The feedback signal is not provided to the subject (controller input), but instead used to change the system conditions.

be reduced. In this model, the comparison only involves the output of the system.

5.1.4. Explicit model of neurofeedback and biofeedback

Biofeedback can be explicit or implicit (Dekker and Champion, 2007; Kuikkaniemi et al., 2010; Nacke et al., 2011); we will first provide a model for explicit biofeedback (see Fig. 8). In this model, both internal and external functions are used to control the current state of the system as compared to the target state.

5.1.5. Implicit model of neurofeedback and biofeedback

The process control model of implicit biofeedback is shown in Fig. 9. In this model, there are two kinds of comparisons: the system can use both internal and external functions to reach a target state. Internal functions refer to inner sensors of the system, while external functions are not directly accessible. External feedback is provided as an input to the system (it has an impact on the system input but not on the error measurement).

5.2. Limits of process control models

When using modelling biofeedback, one should bear in mind the typical limitations of process control methods, reflected in the following five “good practice” precautions.

5.2.1. Linearity

Linear process control models are generally only applicable to linear systems, and when applied to non-linear systems, definitions are only valid for small movements in the neighborhood of a functioning point (Trentelman et al., 2001). Physiological regulation is typically non-linear, and consequently, biofeedback systems need to be individually calibrated, with each user having his own functioning point depending upon both his physiology and his proficiency at regulating the biosignal of interest. Furthermore, the regulation task should also target small enough variations in performances to prevent non-linearity effects. In addition, neurophysiological regulation is allostatic (Sterling, 2004): the brain performs predictive regulations and retune its parameters according to changes. Therefore, experimental protocols should take into account the fact that individuals’ reference point may vary over time depending on task demands and learning.

5.2.2. Stability

Process control systems can be stable or unstable (Ross Ashby, 1956; Routh and Fuller, 1975; Lopez-Caamal et al., 2014). Unstable systems can be heavily perturbed by the slightest change in the input command, whereas stable systems can regulate even the most discontinuous perturbations (e.g., Dirac pulses, which have finite impulse responses). Biofeedback systems are in most cases unstable, and consequently, tolerance to variations around the functioning point is fairly limited.

5.2.3. Temporality: transients and steady-states

When the command changes in complex systems, transient variations typically occur before the system reaches its steady-state (Wilts, 1960). Controlling the amplitude of these variations usually leads to a tradeoff between convergence speed and transient variation amplitude. In other words, fast systems tend to have lots of fluctuations before they reach their goals, whereas slow systems tend to be more precise. This means that the temporality of biofeedback can be a crucial issue: while transient variations correspond to task performances, steady-state error relates to the task result (see Section 3.3 about performance and results). Consequently, continuous feedback about transient states is usually more efficient than discrete feedback about steady-state errors, unless steady-state error perception is not readily available to subjects. For example, in sports training, result feedback can provide useful information to beginners but is of less interest to trained subjects. In biofeedback, the type of feedback presented (transient or steady-state) has to match the subject’s level of fluency in the task.

5.2.4. Precision

In process control, a system’s precision (or accuracy) is defined by its ability to reach a zero steady-state error (Levine, 2010). This precision, or static error, is one of the key estimates of the system’s performance. Therefore, the precision of the biofeedback system (i.e., the precision of biosignal monitoring, the subject’s performance with or without feedback) should always be evaluated.

5.3. Serious games

“Serious games” are games with teaching, training, and informational purposes that utilize play as motivational leverage (Abt, 1970; Prensky, 2001; Michael and Chen, 2006; McGonigal, 2011). Such games have been designed and engineered to stimulate motivation in subjects learning new tasks. Video gaming has several effects on cognitive functions, and in particular may be efficient training for learning how to learn (Bavelier et al., 2012): action video game players have been shown to learn how to extract regular patterns in their environment, thereby improving their ability to learn new tasks. Furthermore, video gaming may lead to lasting changes in reward processing mechanisms (Lorenz et al., 2015). For example, it has been shown that cancer patients playing a serious game to encourage treatment-related behavior markedly activated neural circuits implicated in reward (caudate, putamen, and nucleus accumbens) as compared to patients observing the same audio-visual stimuli without playing (Cole et al., 2012a,b). Biofeedback can be considered a type of serious game: the user “plays” with his biological variable through an interface. Understanding the effective design of serious games is therefore critical to knowing how to design efficient biofeedback systems.

Games are interesting learning strategies because they stimulate motivation and therefore the reward system. Humans have

Table 1

Integrative perspective on biofeedback models, from biomedicine to neuroscience. WM = working memory, LPFC = lateral prefrontal cortex, CCN = cognitive control network.

Biomedicine		Engineering	Psychology	Neuroscience	Psychoengineering
Discrimination		Observability	Cognitive load, WM Agency	LPFC, sensory cortex Insula, Angular gyrus CCN,	Perceptibility Autonomy
Self maintenance	Volitional	Explicit paradigms	Fluency	Error potentials Reward system, Ventral striatum Neural assembly formation	Mastery Motivation
Biosignal regulation	Autonomous	Implicit paradigms Controllability	Extrinsic motivation Operant conditioning Schemata formation		Learnability

genuinely high motivation to play video games because they stimulate intrinsic motivation factors, i.e., psychological needs of mastery, autonomy, and relatedness (Przybylski et al., 2010; Lorenz et al., 2015). Several studies have been published on video games and flow (Olson, 2010; Swanson and Whittinghill, 2015), a state of being pleasantly and completely absorbed in a goal-driven activity with hyper-focused attention (Csikszentmihalyi and LeFevre, 1989). The flow state occurs when information processing matches the user's aptitudes and the task becomes a realizable challenge (neither too frustrating nor too boring). According to Csikszentmihalyi, the amount of information a human subject can process amounts to a bit rate of 126 bits/s (Csikszentmihalyi and Csikszentmihalyi, 1992), placing a higher bound on manageable cognitive load (which is modulated by the person's skills). This intrinsic motivation is mainly reported as "fun" by the video game player (Olson, 2010), associated with biological rewards with dopamine release in the ventral striatum (Lorenz et al., 2015).

Certain errors must be avoided to take full advantage of the "fun factor" in biofeedback treatments. Simply because a process is required during game play does not guarantee changes in that process (Bavelier et al., 2012). Unfortunately in some clinical studies the goal has been to "entertain" children with "EEG-driven games," rather than really applying a learning procedure the children could benefit from for a longer period (Arns et al., 2015). The game should be designed to induce training, and this is done by controlling the game's validity—in particular, its predictive validity, proving that performance in the game leads to better outcomes in reality (Graafland et al., 2014). In the field of biofeedback, the problem of transfer is as important as it is for serious games; the skill must be transferable to real life or the user will not benefit from treatment.

6. Psychoengineering model

6.1. The missing keystone: toward a psychoengineering model

In the previous sections, we have explored the various existing models of biofeedback: biomedical, psychological, neuroscience and bioengineering perspectives. We could argue in favor of any of these four perspectives, as each one answers a set of critical questions. However, we believe that a blended model would best describe the mechanisms of biofeedback and produce useful experimental paradigms. This model should represent the perspective of biofeedback itself and bridge the gaps among the aforementioned four disciplines. From a biofeedback perspective, the brain is regulating its own control over biosignals, thereby building itself anew. We have therefore coined the term "psychoengineering" to define our perspective and will attempt to develop such a model in this section.

6.2. Bridging the disciplinary gaps

First, we recapitulate the key points of the above-mentioned four models in the table below (Table 1). As we can see, there

is no direct mapping between the applied models (biomedicine and engineering perspectives) and the theoretical models (psychology and neuroscience perspectives) of self-maintenance. We can identify five key properties of an efficient biofeedback system: perceptibility, autonomy, mastery, motivation, and learnability. Controlling these five variables is necessary for evaluation of a biofeedback prototype.

Perceptibility refers to the potential for the subject to access the perception of the biosignal he/she has to regulate. Autonomy refers to the potential for the subject to regulate the biosignal by himself, without the help of biofeedback, once the training protocol is over. Mastery refers to the degree of control the subject can exercise over the biosignal. Motivation refers to the reward system of the biofeedback device—the reinforcement signal that will induce learning. Learnability refers both to the conditions for achieving long-term memory formation (e.g., sufficient amount of time and repetitions) and to the possibility of learning itself.

7. Conclusion

The learning mechanisms involved in biofeedback should be thoroughly investigated, as the existing literature is largely insufficient to understand biofeedback and explain how it works. We conclude thereafter with five directions that ought to be pursued to better investigate these mechanisms and to improve biofeedback and neurofeedback protocols. These guidelines are representative of the existing literature and should not be seen as established laws but rather as future research directions. They can be used to design a good practice guide for biofeedback and neurofeedback—a tool that is of critical importance to the clinical evaluation of these interventions (Micoulaud-Franchi et al., 2015). Thanks to these guidelines, we hope future biofeedback studies will reach higher standards.

Note that different standardized psychological scales are mentioned for each property, complicating the investigation of feedback protocols. Performing all these evaluations during online feedback procedures might lead to an increased cognitive load for the subject, which could lead to negative interactions with the feedback protocol. Therefore, developing a general feedback learning experience scale involving the main items of all five properties may provide us with a new and useful direction in biofeedback research. Furthermore, one should distinguish here the research purposes (when one evaluates a feedback procedure) and the clinical purposes (when one uses a feedback procedure for treatment). The evaluation of psychological scales during feedback trials is certainly useful for research purposes; however for the final clinical applications such evaluations could be pointless in many cases.

7.1. Investigating and promoting perceptibility

An efficient biofeedback system has to ensure that both the external and internal signals of interest can be perceived with sufficient precision and be effectively organized so that their bit rate will not exceed the user's perception capabilities. One method that

might improve perceptibility in explicit models would be to provide multimodal feedbacks (Lotte et al., 2013): each sensory modality would correspond to a different slave subsystem of working memory. Consequently, a sensory modality not involved in the task should be preferred in the feedback design (see Section 3.5 about working memory models).

From a psychological perspective, perceptibility is related to cognitive load, which can be measured using scales such as the NASA TLX (Hart and Staveland, 1988) or equivalent standardized measures while the subject performs the feedback learning task. The cognitive load is expected to be anti-correlated with the U-shaped evolution of performance (Pauls et al., 2013; Siegler, 2004) and should not reach too high a level, or the subject will experience a cognitive overload and a subsequent loss of motivation. Unfortunately, the issue of cognitive load is often overlooked or ignored in biofeedback studies. For instance, in Angelakis et al. (2007), the same neurofeedback is presented both in auditory and visual modalities (Angelakis et al., 2007) – without any discussion about the impact on cognitive load of this strategy. In Keizer et al. (2010), an auditory neurofeedback rate is bounded to a maximum of 1 feedback per second (Keizer et al., 2010). The amount of information a given subject can process during 1 s is limited, this limit has an interaction with the extraneous load of this task. In Kober et al. (2015), an SMR neurofeedback uses 3 bars, the subject having to modulate both SMR, alpha range and theta range (Kober et al., 2015). As the theta and beta range bars were used to prevent muscle contraction and eye blinks, they could have been replaced by an auditory feedback, and thereby the cognitive load could have been decreased. In Penzlin et al. (2015), a visual feedback is presented to indicate heart rate variability, while another visual cue is presented to indicate breath-pacing (Penzlin et al., 2015). The breath pacing cue could have been auditory, likely reducing the cognitive load.

Furthermore, one has to ensure that the informative external and internal feedback can be perceived as well. This concerns the validity of the external feedback signal: one must demonstrate that the signal is indeed correlated with biosignal regulation. It also concerns the precision of the feedback signal—a classical modelling problem, this precision is a test error that should be evaluated on an independent test set (not on the database used to develop the feedback model). For instance, in neurofeedback, the appropriate approach is to evaluate precision using the same methods as in brain-computer interface paradigms.

Finally, evaluating internal feedback is an observability issue: without the presence of internal feedback there is nothing to be learned. This evaluation can be achieved using psychophysiological scales measuring perception of the internal biosignal: subjects with a complete infirmity in the trained biosignal regulation would not be good candidates for a neurofeedback procedure (since they will never be able to develop autonomy, as explained in the next section). Instead, they would be limited to using the biofeedback system as a palliative measure—something akin to a wheelchair, which cannot be used to rehabilitate movement in hemiplegic individuals (though still useful to them). Inter-individual differences in the ability to monitor interoceptive signals, to concentrate on one's own internal representations and inhibit external, task-irrelevant, stimulation, should be tracked (Corbetta and Shulman, 2002; Burgess et al., 2007). Measuring these individual profiles in biofeedback subjects could be of use to adapt the protocol to individual needs. For instance, Lazarov et al. reported that individuals with obsessive compulsive disorders may suffer from interoceptive deficits, with deficits in internal signal perception, when exposed to biofeedbacks (Lazarov et al., 2010). One could use scales such as Rotter's Locus of control scale to evaluate whether subjects are internally or externally oriented (Rotter, 1966). Internal state per-

ceptibility might also be promoted by combining biofeedback with mindfulness interventions and strategies (Khazan, 2013).

7.2. Investigating and promoting autonomy

From a psychological perspective, autonomy could be promoted following the “guidance hypothesis” (Winstein and Schmidt, 1990; Strehl, 2014). Biofeedback aims to be a scaffolding system rather than palliation for a missing internal signal; otherwise, learning cannot occur. The biofeedback signal should help the subject identify his own internal signals and become progressively more independent of the external feedback, promoting the user's sense of agency. The biofeedback protocol should be as close to reality as possible (high predictive validity, with feedback progressively withheld to promote memorization and intrinsic motivation; see Sections 3 and 3.5.3). For instance, in O'Connell et al. (2007), a protocol promoting autonomy in an explicit biofeedback setting is presented (O'Connell et al., 2007): volitional control is promoted by allowing the subject to progressively initiate the biofeedback task, instead of externally cued; furthermore the subject has to progressively gain autonomy by learning to rely on his internal feedback, the final training step being performed with a withheld external feedback. Such procedures will induce generalization, a process whereby the learner control is progressively experienced without feedback (Sherlin et al., 2011; Strack, 2011).

Predictive validity is necessary to allow transfer from the task-training protocol to real-life positive outcomes. It can be investigated using task performance properties: the so-called “game metrics” used in serious-game designs. These game metrics must be reliable, valid, and cause-specific (Graafland et al., 2012). For example, in neurofeedback, predictive validity requires specificity of the feedback signal: is it targeting only the function to be regulated or a confused signal involving the target function together with additional brain systems? The feedback setup is also of interest: is the training related to real-life conditions or to an abstract conditioning protocol that has no meaning for the subject? Virtual reality setups, for example, seek to improve predictive validity by immersing the subject in a realistic task environment.

If the sense of agency is too low, the biofeedback protocol will not trigger intrinsic motivation and could have a negative impact on learning. Sense of agency can be measured using scales such as SOARS (Polito et al., 2013) or equivalent standardized measures. Other implicit, preverbal, measures such as action-outcome temporal compression or sensory attenuation following voluntary action could also be used to estimate agency (Brown et al., 2013; Dewey and Knoblich, 2014).

From a neuroscience perspective, monitoring the neural correlates of agency could be attempted by measuring the alpha-band relative power and phase coherence during feedback performance.

7.3. Investigating and promoting mastery

Biofeedback systems should provide the user with the possibility to experiment with a progressive experience of control over the regulatory task, promoting the user's sense of fluency. Mastery can be promoted by maintaining a reasonable challenge level, which can be achieved by breaking the treatment down into several sessions of progressive difficulty. In order to respect conditions of linearity and stability, a typical solution is to estimate a psychophysiological curve of subject performance during a calibration phase. This curve estimates both the optimal functioning point and the tolerance to variations around this point. The curve could then be optimized online while the subject is training with the biofeedback system. Task difficulty could either be regularly recalibrated

at the beginning of each session, or controlled in real-time using an adaptive calibration strategy.

A sense of fluency can be measured using scales such as SCS (Dong et al., 2015) or equivalent standardized measures. Task performance (such as biosignal modulation ability) or cognitive load physiological markers (such as galvanic skin response, or CNV in Cz) are objective but indirect indicator of mastery, and should follow a U-shaped evolution (Pauls et al., 2013; Siegler, 2004; Gevensleben et al., 2014) in explicit feedback protocols. Despite U-shape cognitive demand evolution was first reported in 1978 in biofeedback systems (Gatchel et al., 1978), and is still reported in recent investigations (Gevensleben et al., 2014), most studies investigate performances before and after feedback administration, instead of during – and are therefore ignoring this issue. Note however that this U-shaped evolution might not be observed in implicit reward feedback systems, as the subject is not focusing his attention directly onto the feedback. Optimally, the type of feedback (steady-state or transient) should be consistent with the subject's fluency without feedback. Fluent subjects will not be interested in steady-state discrete feedback but rather in transient continuous feedback, whereas subjects with low fluency may find discrete steady-state feedback useful.

From a neuroscience perspective, FRN may be a good neural marker of fluency in feedback learning and can be measured during tasks comparing naive, trained, and control subjects while they receive feedback (sham feedback for control subjects).

7.4. Investigating and promoting motivation

Within the five properties of efficient biofeedback systems, motivation is probably the most important research avenue. Most existing biofeedback systems are actually extremely boring: the subject sits in a chair and observes a biosignal correlate over a long period of time. A biofeedback system should be motivating (targeting extrinsic or intrinsic motivation) to best promote learning.

From a psychological perspective, though it is well-known that human interactions are catalysts of intrinsic motivation (Ryff and Keyes, 1995), biofeedback and neurofeedback paradigms are too often based on solitary human-computer interactions, and the “human variable” is seldom mentioned or investigated. Much biofeedback research seems to assume a treatment model, as if biofeedback is a procedure “done to” an individual (Yucha and Montgomery, 2008). As was previously stated by Strehl, neurofeedback and biofeedback will always take place within a patient-therapist interaction (Strehl, 2014). Furthermore, it should be noted that this human factor can have an effect both on feedback groups and on control groups in controlled studies (possibly biasing outcomes). Interactions with instructors are key motivational variables (Middaugh et al., 2001; Khazan, 2013) that should be taken into account and evaluated rigorously, for instance using principles taken from instructional design (Lotte et al., 2013).

Finally, from the perspective of OC, the reward percentage (positive feedback), the reward delay and the strategy of reward presentation can also play a key role (Sherlin et al., 2011). In any case, the subjective experience of motivation should be controlled, for instance using items from standardized flow-state evaluation scales such as the FSSOT (Yoshida et al., 2013) or equivalent standardized measures.

From a neuroscience perspective, monitoring the neural correlates of motivation and reinforcement learning would be of great interest. For instance, EEG signatures such as Ne, Pe, FRN, P300, or midline frontal theta power would provide direct insights into biofeedback learning mechanisms.

7.5. Investigating and promoting learnability

Learnability introduces a controllability issue: is the subject able to regulate his biosignal—at least slightly—before the biofeedback or neurofeedback protocol starts? Otherwise, the subject will never be able to learn anything: whatever the precision of the biofeedback, it cannot be used to train nonexistent internal mechanisms. This can be evaluated by determining the subject's fluency without feedback before training begins, which can be measured using scales such as the SCS (Dong et al., 2015).

From a neuroscience perspective, it could also be of great interest to measure a subject's aptitude in brain wave modulation as an indicator of his ability to be trained by neuro or biofeedback. For instance, performance in neurofeedback is usually defined as the ability to up-regulate the targeted neuromarker during feedback training sessions (Escolano et al., 2012; Witte et al., 2013; Zoefel et al., 2011; Reichert et al., 2015; Escolano et al., 2011). The investigation of biomarkers predicting learnability is of great interest for the design and evaluation of efficient bio and neurofeedback, and should be generalized. For instance, Reichert et al. reported a relationship between the controllability of the biosignal (ability to modulate the SMR) and the measurement of an EEG marker (rest signal pre-training value) in SMR neurofeedback (Reichert et al., 2015).

For other types of biofeedback, learnability could be measured by evaluating the modulation performance of the subject during the first training sessions: a low initial performance in explicit biofeedback (i.e. an absence of improvement, or an absence of aptitude to modulate the biosignal) would indicate poor learnability.

Finally, learning is constrained by mechanisms of long-term memory formation. Learning follows a succession of steps: memories are abstracted into functionally efficient schemata (see Section 4) and progressively consolidated. This process takes time, and it calls for a succession of sessions separated by nights of recuperation (sleep being a necessary ingredient for memory consolidation). The number of sessions, session duration, and time intervals between sessions are therefore all crucial parameters of biofeedback and neurofeedback protocols, and the long-term effects of feedback training should be evaluated to determine training stability.

References

- Abt, C., 1970. *Serious Games*. The Viking Press, New York.
- Abukonna, A., Xiaolin, Y., Zhang, C., Zhang, J., 2013. Volitional control of the heart rate. *Int. J. Psychophysiol.* 90, 143–148.
- Anders Ericsson, K., Delaney, P.F., 1999. Long-term working memory as an alternative to capacity models of working memory in everyday skilled performance. *Models of working memory: mechanisms of active maintenance and executive control*, 257–297.
- Anders Ericsson, K., Kintsch, W., 1995. Long-term working memory. *Psychol. Rev.* 102 (2), 211–245.
- Andrillon, T., Kouider, S., Agus, T., Pressnitzer, D., 2015. Perceptual learning of acoustic noise generates memory-evoked potentials. *Curr. Biol.* 25 (21), 2823–2829.
- Angelakis, E., Stathopoulou, S., Frymiare, J.L., Green, D.L., Lubar, J.F., Kounios, J., 2007. EEG neurofeedback: a brief overview and an example of peak alpha frequency training for cognitive enhancement in the elderly. *Clin. Neurophysiol.* 21 (1), 110–129.
- Anliker, J., 1977. Biofeedback from the Perspectives of Cybernetics and Systems Science. In: Beatty, J., Legewie, H. (Eds.), *Biofeedback and Behavior*, NATO Conference Series, 2. Plenum Press, New York, USA, pp. 21–45.
- Arns, M., 2011. Personalized medicine in ADHD and depression: a quest for EEG treatment predictors. *Ipskamp Drukkers*, Amsterdam.
- Arns, M., Heinrich, H., Ros, T., Rothenberger, A., Strehl, U., 2015. Editorial: Neurofeedback in ADHD. *Frontiers in Human Neuroscience* 9 (602), 1–3.
- Axmacher, N., Draguhn, A., Elger, C.E., Fell, J., 2009. Memory processes during sleep: beyond the standard. *Cell. Mol. Life Sci.* 66, 2285–2297.
- Baddeley, A.D., Hitch, G., 1974. Working memory. In: Bower, G.H. (Ed.), *The Psychology of Learning and Motivation: Advances in Research and Theory*, vol. 8. Academic Press, New York, pp. 47–89.
- Baddeley, A., 2000. The episodic buffer: a new component of working memory? *Trends Cogn. Sci.* 4 (11), 417–423.

- Bagdasaryan, J., Le Van Quyen, M., 2013. Experiencing your brain: neurofeedback as a new bridge between neuroscience and phenomenology. *Front. Hum. Neurosci.* 7 (680), 1–19.
- Bandura, A., 1986. *Social Foundations of Thought and Action: A Social Cognitive Theory*. Prentice-Hall, Englewood Cliffs, NJ.
- Banich, M.T., 2009. Executive function: the search for an integrated account. *Curr. Direct. Psychol. Sci.* 18, 89–94.
- Barrouillet, P., Bernardin, S., Camos, V., 2004. Time constraints and resource sharing in adults' working memory spans. *J. Exp. Psychol. Gen.* 133 (1), 83–100.
- Bartlett, F.C., 1932. *Remembering: A Study in Experimental and Social Psychology*. Cambridge University Press, Cambridge, England.
- Bavelier, D., Green, C.S., Pouget, A., Schrater, P., 2012. Brain plasticity through the life span: learning to learn and action video games. *Annu. Rev. Neurosci.* 35, 391–416.
- Bellack, A.S., Hersen, M., 1988. *Behavioral Assessment: A Practical Handbook*, 3rd ed. Pergamon Press, Elmsford, NY (USA).
- Black, H.S., 1934. Stabilized feed-back amplifiers. *Electr. Eng.* 53, 114–120.
- Bostrom, N., 2006. A history of transhumanist thought. *Anal. Metaphys.* 5 (1–2).
- Box, G.E., Draper, N.R., 1987. *Empirical Model Building and Response Surfaces*. John Wiley & Sons, New York, NY.
- Brenner, J., 1974. A general model of voluntary control applied to the phenomenon of learned cardiovascular change. In: Obrist, P.A., Black, A.H., DiCara, L.V. (Eds.), *Cardiovascular Psychophysiology*. Aldine, Chicago, pp. 365–391.
- Buchanan, J.J., Wang, C., 2012. Overcoming the guidance effect in motor skill learning: feedback all the time can be beneficial. *Exp. Brain Res.* 219 (2), 305–320.
- Buckner, R.L., Andrews-Hanna, J.R., Schacter, D.L., 2008. The brain's default network: anatomy, function, and relevance to disease. *Ann. N. Y. Acad. Sci.* 1124 (1), 1–38.
- Buonomano, D.V., Maass, W., 2009. State-dependent computations: spatiotemporal processing in cortical networks. *Nat. Rev. Neurosci.* 10, 113–125.
- Burle, B., Bonnet, M., 1999. What's an internal clock for? From temporal information processing to temporal processing of information. *Behav. Process.* 45, 59–72.
- Bush, G., Luu, P., Posner, M., 2000. Cognitive and emotional influences in anterior cingulate cortex. *Trends Cogn. Sci.* 4 (6), 215–222.
- Cannon, R., Lubar, J., Baldwin, D., 2008. Self-perception and experiential schemata in the addicted brain. *Appl. Psychophysiol. Biofeedback* 33 (4), 223–238.
- Canguilhem, G., 1966. *Le normal et le pathologique, reediting in 1979*. PUF, collection Galien, Paris.
- Caria, A., Sitaram, R., Birbaumer, N., 2011. Real-time fMRI: a tool for local brain regulation. *Neuroscientist* 18, 487–501.
- Carlucci, L., Case, J., 2013. On the necessity of U-shaped learning. *Top. Cogn. Sci.* 5 (1), 56–88.
- Case, R., 1985. *Intellectual Development: Birth to Adulthood*. Academic Press, Orlando.
- Cavanagh, J., Frank, M., 2014. Frontal theta as a mechanism for cognitive control. *Trends Cogn. Sci.* 18 (8), 414–421.
- Chalmers, D.J., 1995. Facing up to the problem of consciousness. *J. Conscious. Stud.* 2, 200–219.
- Chambon, V., Wenke, D., Fleming, S.M., Prinz, W., Haggard, P., 2013. An online neural substrate for sense of agency. *Cereb. Cortex* 23 (5), 1031–1037.
- Chambon, V., Sidarus, N., Haggard, P., 2014. From action intentions to action effects: how does the sense of agency come about? *Front. Hum. Neurosci.* 8 (320), 1–9.
- Charles, L., Van Opstal, F., Marti, S., Dehaene, S., 2013. Distinct brain mechanisms for conscious versus subliminal error detection. *Neuroimage* 73, 80–94.
- Cocchi, L., Zalesky, A., Fornito, A., Mattingley, J.B., 2013. Dynamic cooperation and competition between brain systems during cognitive control. *Trends Cogn. Sci.* 17, 493–501.
- Cole, M.W., Schneider, W., 2007. The cognitive control network: integrated cortical regions with dissociable functions. *Neuroimage* 37, 343–360.
- Cole, M.W., Yarkoni, T., Repovš, G., Anticevic, A., Braver, T.S., 2012a. Global connectivity of prefrontal cortex predicts cognitive control and intelligence. *J. Neurosci.* 32 (26), 8988–8999.
- Cole, S.W., Yoo, D.J., Knutson, B., 2012b. Interactivity and reward-related neural activation during a serious videogame. *PLoS One* 7 (3), 1–9.
- Cole, M.W., Reynolds, J.R., Power, J.D., Repovš, G., Anticevic, A., Braver, T.S., 2013. Multi-task connectivity reveals flexible hubs for adaptive task control. *Nat. Neurosci.* 16, 1348–1355.
- Cowan, N., Elliott, E.M., Saults, J.S., Morey, C.C., Mattox, S., Hismjatullina, A., et al., 2005. On the capacity of attention: its estimation and its role in working memory and cognitive aptitudes. *Cognit. Psychol.* 51 (1), 42–100.
- Cowan, N.J., Ankarali, M.M., Dyhr, J.P., Madhav, M.S., Roth, E., Sefati, S., Sponberg, S., Stamper, S.A., Fortune, E.S., Daniel, T.L., 2014. Feedback control as a framework for understanding tradeoffs in biology. *Integr. Comp. Biol.* 54 (2), 223–237.
- Cowan, N., 1988. Evolving conceptions of memory storage, selective attention, and their mutual constraints within the human information-processing system. *Psychol. Bull.* 104 (2), 163–191.
- Cowan, N., 1992. Verbal memory span and the timing of spoken recall. *J. Mem. Lang.* 31 (5), 668–684.
- Cowan, N., 2005. *Working Memory Capacity*. Psychology Press, Hove, East Sussex, UK.
- Csikszentmihalyi, M., LeFevre, J., 1989. Optimal experience in work and leisure. *J. Pers. Soc. Psychol.* 56, 815–822.
- Csikszentmihalyi, M., 1990. *Flow: The Psychology of Optimal Experience*. Harper & Row, New York.
- Csikszentmihalyi, M., Csikszentmihalyi, I.S., 1992. *Optimal Experience: Psychological Studies of Flow in Consciousness*. Cambridge University Press, New York.
- Dehaene, S., Artiges, E., Naccache, L., Martelli, C., Viard, A., Sch#xps1#rhoff, F., Recasens, C., Martinot, M.L., Leboyer, M., Martinot, J.L., 2003. Conscious and subliminal conflicts in normal subjects and patients with schizophrenia: the role of the anterior cingulate. *Proc. Natl. Acad. Sci. U.S.A.* 100 (23), 13722–13727.
- Demanet, J., Muhle-Karbe, P.S., Lynn, M.T., Blotenberg, I., Brass, M., 2013. Power to the will: how exerting physical effort boosts the sense of agency. *Cognition* 129 (3), 574–578.
- Dilworth-Bart, J., Poehlmann, J., Hilgendorf, A.E., Miller, K., Lambert, H., 2010. Maternal scaffolding and preterm toddlers' visual-spatial processing and emerging working memory. *J. Pediatr. Psychol.* 35 (2), 209–220.
- Dixon-Krauss, L., 1996. *Vygotsky in the Classroom. Mediated Literacy Instruction and Assessment*. Longman Publishers, White Plains, NY.
- Dockree, P.M., Roberston, I.H., 2011. Electrophysiological markers of cognitive deficits in traumatic brain injury: a review. *Int. J. Psychophysiol.* 82, 53–60.
- Dong, M.Y., Sandberg, K., Bibby, B.M., Pedersen, M.N., Overgaard, M., 2015. The development of a sense of control scale. *Front. Psychol.* 6 (1733), 1–14.
- Dosenbach, N., Visscher, K., Palmer, E., Miezin, F., Wenger, K., Kang, H., et al., 2006. A core system for the implementation of task sets. *Neuron* 50 (5), 799–812.
- Dwyer, D.B., Harrison, B.J., Yücel, M., Whittle, S., Zalesky, A., Pantelis, C., et al., 2014. Large-scale brain network dynamics supporting adolescent cognitive control. *J. Neurosci.* 34 (42), 14096–14107.
- Endrass, T., Reuter, B., Kathmann, N., 2007. ERP correlates of conscious error recognition: aware and unaware errors in an antisaccade task. *Eur. J. Neurosci.* 26, 1714–1720.
- Epstein, L.H., Blanchard, E.B., 1977. Biofeedback, self-control, and self-management. *Biofeedback Self-Regul.* 2 (2), 201–211.
- Escolano, C., Aguilar, M., Minguez, J., 2011. EEG-based Upper Alpha Neurofeedback Training Improves Working Memory Performance. 33rd Annual International Conference of the IEEE EMBS. Institute of Electrical and Electronics Engineers, Boston, MA, USA, pp. 2327–2330.
- Escolano, C., Oliván, B., Lopez-del-Hoyo, Y., Garcia-Campayo, J., Minguez, J., 2012. Double-blind single-session neurofeedback training in upper-alpha for cognitive enhancement of healthy subjects. 34th conference of the IEEE EMBS. IEEE Engineering in Medicine and Biology Society, San Diego, CA, USA, pp. 4643–4647.
- Ester, E.F., Sprague, T.C., Serences, J.T., 2015. Parietal and frontal cortex encode stimulus-specific mnemonic representations during visual working memory. *Neuron* 87 (4), 893–905.
- Falkenstein, M., Hohnsbein, J., Hoormann, J., 1991. Effects of crossmodal divided attention on late ERP components. II. Error processing in choice reaction time tasks. *Electroencephalogr. Clin. Neurophysiol.* 78, 447–455.
- Frankland, P.W., Bontempi, B., 2005. The organization of recent and remote memories. *Nat. Rev. Neurosci.* 6 (2), 119–130.
- Freund, L.S., 1990. Maternal regulation of children's problem-solving behavior and its impact on children's performance. *Child Dev.* 61, 113–126.
- Frith, C.D., Blakemore, S., Wolpert, D., 2000. Abnormalities in the awareness and control of action. *Trans. R. Soc. Lond.* 355, 1771–1788.
- Gallagher, S., 2000. Philosophical conceptions of the self: implications for cognitive science. *Trends Cogn. Sci.* 4 (1), 14–21.
- Garon, N., Bryson, S.E., Smith, I.M., 2008. Executive function in preschoolers: a review using an integrative framework. *Psychol. Bull.*, 31–60.
- Gatchel, R.J., Korman, M., Weis, C.B., Smith, D., Clarke, L., 1978. A multiple-response evaluation of EMG biofeedback performance during training and stress-induction conditions. *Psychophysiology* 15, 253–258.
- Gazzaley, A., Nobre, A.C., 2012. Top-down modulation: bridging selective attention and working memory. *Trends Cogn. Sci.* 16 (2), 129–135.
- Gehring, W.J., Goss, B., Coles, M.G., Meyer, D.E., Donchin, E., 1993. A neural system for error detection and compensation. *Psychol. Sci.* 4, 385–390.
- Gershman, S., Markman, A., Otto, A., 2014. Retrospective reevaluation in sequential decision making: a tale of two systems. *J. Exp. Psychol. Gen.* 143 (1), 182–194.
- Gevensleben, H., Albrecht, B., Lütcke, H., Auer, T., Dewiputri, W.I., Schweizer, R., et al., 2014. Neurofeedback of slow cortical potentials: neural mechanisms and feasibility of a placebo-controlled design in healthy adults. *Front. Hum. Neurosci.* 8 (990), 1–13.
- Goldfried, M.R., Sprafkin, J.N., 1976. Behavioral personality assessment. In: Spence, J.T., Carson, R.C., Thibaut, J.W. (Eds.), *Behavioral Approaches to Therapy. General Learning Press, Morristown (USA): NJ*, pp. 295–321.
- Graafland, M., Schraagen, J., Schijven, M.P., 2012. Systematic review of serious games for medical education and surgical skills training. *Br. J. Surg.* 99 (10), 1322–1330.
- Graafland, M., Dankbaar, M., Mert, A., Lagro, J., De Wit-Zuurendonk, L., Schuit, S., et al., 2014. How to systematically assess serious games applied to health care. *JMIR Serious Games* 2 (2), e11.
- Gu, S., Pasqualetti, F., Cieslak, M., Telesford, Q.K., Yu, A.B., Kahn, A.E., et al., 2015. Controllability of structural brain networks. *Nat. Commun.* 6 (8414).
- Guenther, F.H., Brumberg, J.S., Wright, E.J., Nieto-Castanon, A., Tourville, J.A., Panko, M., 2009. A Wireless Brain-Machine Interface for Real-Time Speech Synthesis. *PLoS One* 4 (12), e8218.
- Hammond, S.I., Müller, U., Carpendale, J.I., Bibok, M.B., Liebermann-Finestone, D.P., 2012. The effects of parental scaffolding on preschoolers' executive function. *Dev. Psychol.* 48 (1), 271–281.

- Hart, S.G., Staveland, L.E., 1988. Development of NASA-TLX (task load index): results of empirical and theoretical research. *Adv. Psychol.* 52, 139–183.
- Hasbroucq, T., Burle, B., Vidal, F., Possamaï, C.-A., 2009. Stimulus-hand correspondence and direct response activation: an electromyographic analysis. *Psychophysiology*, 1160–1169.
- Hauri, P.P., 1975. Biofeedback and self-control of physiological functions: clinical applications. *Int. J. Psychiatry Med.* 6 (1–2), 255–265.
- Hauser, T.U., Iannaccone, R., Stämpfli, P., Drechsler, R., Brandeis, D., Walitza, S., et al., 2014. The feedback-related negativity (FRN) revisited: new insights into the localization: meaning and network organization. *Neuroimage* 84, 159–168.
- Hoppe, D., Sadakata, M., Desain, P., 2006. Development of a real-time visual feedback assistance in singing training: a review. *J. Comp. Assist. Learn.* 22, 308–316.
- Huyck, C.R., Passmore, P.J., 2013. A review of cell assemblies. *Biol. Cybern.* 107 (3), 263–288.
- Ikkai, A., Curtis, C.E., 2011a. Common neural mechanisms supporting spatial working. *Neuropsychologia* 49 (6), 1428–1434.
- Ikkai, A., Curtis, C.E., 2011b. Common neural mechanisms supporting spatial working memory, attention and motor intention. *Neuropsychologia* 49 (6), 1428–1434.
- Johnson, S.H., Grafton, S.T., 2003. From 'acting on' to 'acting with': the functional anatomy of object-oriented action schemata. In: Prablanc, C., Péllisson, D., Rossetti, Y. (Eds.), *Neural Control of Space Coding and Action Production*, Progress in Brain Research, vol. 142. Elsevier Science B.V., pp. 127–139.
- Kalman, R.E., 1960. On the General Theory of Control Systems. Proc. First IFAC Congress Automatic Control. 1. Butterworths, London, Moscow, pp. 481–492.
- Kang, S.Y., Im, C.-H., Shim, M., Nahab, F.B., Park, J., Kim, D.-W., et al., 2013. Brain networks responsible for sense of agency: an EEG study. *PLoS One* 10 (8).
- Kehagia, A.A., Murray, G.K., Robbins, T.W., 2010. Learning and cognitive flexibility: frontostriatal function and monoaminergic modulation. *Curr. Opin. Neurobiol.* 20 (2), 199–204.
- Keizer, A.W., Verschoor, M., Verment, R.S., Hommel, B., 2010. The effect of gamma enhancing neurofeedback on the control of feature bindings and intelligence measures. *Int. J. Psychophysiol.* 75 (1), 25–32.
- Khazan, I.Z., 2013. *The Clinical Handbook of Biofeedback: A Step-by-Step Guide for Training and Practice with Mindfulness*. John Wiley & Sons, Ltd., Chichester, UK.
- Knudsen, E.I., 2007. Fundamental components of attention. *Annu. Rev. Neurosci.* 30, 57–78.
- Kober, S.E., Witte, M., Stangl, M., Väljamäe, A., Neuper, C., Wood, G., 2015. Shutting down sensorimotor interference unlocks the networks for stimulus processing: an SMR neurofeedback training study. *Clin. Neurophysiol.* 126 (1), 82–95.
- Koechlin, E., 2014. An evolutionary computational theory of prefrontal executive function in decision-making. *Phil. Trans. R. Soc. B* 369, 20130474.
- Koechlin, E., 2016. Prefrontal executive function and adaptive behavior in complex environments. *Curr. Opin. Neurobiol.* 37, 1–6.
- Koechlin, E., Ody, C., Kouneiher, F., 2003. The Architecture of Cognitive Control in the Human. *Science* 302 (5648), 1181–1185.
- Koralek, A.C., Jin, X., Long, J.D., Costa, R.M., Carmena, J., 2012. Corticostriatal plasticity is necessary for learning intentional neuroprosthetic skills. *Nature* 483, 331–335.
- Kuikkaniemi, K., Laitinen, T., Turpeinen, M., Saari, T., Kosunen, I., Ravaja, N., 2010. The influence of implicit and explicit biofeedback in first-person shooter games. CHI '10 Proceedings of the SIGCHI Conference on Human Factors in Computing Systems: Brains and Brawn. ACM, Atlanta, GA, USA, pp. 859–868.
- Lafargue, G., Franck, N., 2009. Effort awareness and sense of volition in schizophrenia. *Conscious. Cogn.* 18 (1), 277–289.
- Lamar, M., Raz, A., et al., 2007. Neuropsychological assessment of attention and executive functioning. In: Ayers, S., Baum, A., McManus, C., Newman, S., Wallston, K., Weinman, J. (Eds.), *Cambridge Handbook of Psychology, Health, and Medicine*, second edition. Cambridge University Press, New York, pp. 290–294.
- Lazarov, A.D., Liberman, N., Oded, Y., 2010. Obsessive? compulsive tendencies may be associated with attenuated access to internal states: Evidence from a biofeedback-aided muscle tensing task. *Conscious. Cognit.* 21 (3), 1401–1409.
- Lawrence, E.J., Sua, L., Barker, G.J., Medford, N., Dalton, J., Williams, S.C., et al., 2014. Self-regulation of the anterior insula: reinforcement learning using real-time fMRI neurofeedback. *Neuroimage* 88, 113–124.
- Lehrer, P.M., Gevirtz, R., 2014. Heart rate variability biofeedback: how and why does it work. *Front. Psychol.* 5 (756).
- Leigh, H., 1978. Self-control, biofeedback, and change in 'psychosomatic' approach. *Psychother. Psychosom.* 30 (2), 130–136.
- Lepper, M.P., Greene, D., Nisbett, R.E., 1973. Undermining children's intrinsic interest with extrinsic reward: a test of the overjustification hypothesis. *J. Pers. Soc. Psychol.* 28 (1), 129–137.3.
- Levine, W.S., 2010. *The Control Handbook: Control System Fundamentals*, Second Edition. Taylor & Francis, Boca Raton, USA.
- Lewis, P.A., Durrant, S., 2011. Overlapping memory replay during sleep builds cognitive schemata. *Trends Cogn. Sci.* 15 (8), 343–351.
- Lezak, M.D., Howieson, D.B., Bigler, E.D., Tranel, D., 2012. *Neuropsychological Assessment*, fifth edition. Oxford University Press, New York.
- Logan, D.M., Hill, K.R., Larson, M.J., 2015. Cognitive control of conscious error awareness: error awareness and error positivity (Pe) amplitude in moderate-to-severe traumatic brain injury (TBI). *Front. Hum. Neurosci.* 9 (397), 1–12.
- Logue, S.F., Gould, T.J., 2014. The neural and genetic basis of executive function: attention, cognitive flexibility: and response inhibition. *Pharmacol. Biochem. Behav.* 123, 45–54.
- Lopez-Caamal, F., Middleton, R.H., Huber, H., 2014. Equilibria and stability of a class of positive feedback loops. *J. Math. Biol.* 68, 609–645.
- Lorenz, R.C., Gleich, T., Gallinat, J., Kühn, S., 2015. Video game training and the reward system. *Front. Hum. Neurosci.* 9 (40), 1–9.
- Lotte, F., Larrue, F., Mühl, C., 2013. Flaws in current human training protocols for spontaneous Brain-Computer Interfaces: lessons learned from instructional design. *Front. Hum. Neurosci.* 7 (568), 1–11.
- Maheu, M.M., Pulier, M.L., Wilhelm, F.H., McMenamin, J.P., Brown-Connolly, N.E., 2004. *The Mental Health Professional and the New Technologies: A Handbook for Practice Today*. Lawrence Erlbaum Associates, Inc., Mahwah, New Jersey, USA.
- Maine de Biran, F.P., 1805. *Mémoire sur la décomposition de la pensée (Tome III)*. Vrin (1963), Paris.
- McGonigal, J., 2011. *Reality Is Broken: Why Games Make Us Better and How They Can Change the World*. Penguin press, New York.
- Menon, V., Uddin, L.Q., 2010. Saliency, switching, attention and control: a network model of insula function. *Brain Struct. Funct.* 214 (5–6), 655–667.
- Michael, D., Chen, S., 2006. *Serious Games: Games That Educate, Train and Inform*. Thomson, Boston, MA.
- Micoulaud-Franchi, J.A., McGonigal, A., Lopez, R., Daudet, C., Kotwas, I., Bartolomei, F., 2015. Electroencephalographic neurofeedback: level of evidence in mental and brain disorders and suggestions for good clinical practice. *Neurophysiol. Clin.* 45 (6), 423–433.
- Middaugh, S.J., Haythornthwaite, J.A., Thompson, B., Hill, R., Brown, K.M., Freedman, R.R., et al., 2001. The Raynaud's Treatment Study: biofeedback protocols and acquisition of temperature biofeedback skills. *Appl. Psychophysiol. Biofeedback* 26 (4), 251–278.
- Miller, E., Cohen, J., 2001. An integrative theory of prefrontal cortex function. *Annu. Rev. Neurosci.* 24, 167–202.
- Miltner, W.H., Braun, C.H., Coles, M.G., 1997. Event-related brain potentials following incorrect feedback in a time-estimation task: evidence for a generic neural system for error detection. *J. Cogn. Neurosci.* 9, 788–798.
- Mindell, D.A., 2002. *Between Human and Machine: Feedback, Control, and Computing Before Cybernetics*. JHU Press, Maltimore, Maryland, USA.
- Montgomery, G.T., 1988. Variations in Digital Temperature During Frontal EMG Biofeedback Training in Normal Subjects. *Biofeedback and Self-Regulation* 13 (2), 151–168.
- Moss, D., Gunkelman, J., 2002. Task force report on methodology and empirically supported treatments: introduction and summary. *Biofeedback* 30 (2), 19–20.
- Mottaghy, F.M., 2006. Interfering with working memory in humans. *Neurosciences* 139, 85–90.
- Murrill, P.W., 2000. *Fundamentals of Process Control Theory*, 3rd Edition. ISA: The Instrumentation, Systems, and Automation Society, Research triangle park, North Carolina, USA.
- Nacke, L.E., Grimshaw, M.N., Lindley, C.A., 2010. More than a feeling: Measurement of sonic user experience and psychophysiology in a first-person shooter game. *Interact. Comput.* 22 (5), 336–343.
- Nacke, L.E., Kaly, M., Lough, C., Mandryk, R.L., 2011. *Biofeedback Game Design: Using Direct and Indirect Physiological Control to Enhance Game Interaction*. Proceedings of the CHI 2011 Conference on Human Factors in Computing Systems. ACM, Vancouver, BC, Canada, pp. 103–112.
- Nelson-Gray, R.O., Farmer, R.F., 1999. Behavioral assessment of personality disorders. *Behav. Res. Ther.* 37, 347–368.
- Niendam, T.A., Laird, A.R., Ray, K.L., Monica Dean, Y., Glahn, D.C., Carter, C.S., 2012. Meta-analytic evidence for a superordinate cognitive control network subserving diverse executive functions. *Cogn. Affect. Behav. Neurosci.* 12, 241–268.
- Nieuwenhuis, S., Ridderinkhof, K.R., Blom, J., Band, G.P., Kok, A., 2001. Error-related brain potentials are differentially related to awareness of response errors: evidence from an antisaccade task. *Psychophysiology* 38, 752–760.
- Ninaus, M., Kober, S.E., Witte, M., Ikkoschutnig, K., Stangl, M., Neuper, C., et al., 2013. Neural substrates of cognitive control under the belief of getting neurofeedback training. *Front. Hum. Neurosci.* 7 (914), 1–10.
- Norris, P., 1986. Biofeedback, voluntary control, and human potential. *Biofeedback Self Regul.* 11 (1), 1–20.
- O'Connell, R.G., Dockree, P.M., Bellgrove, M.A., Kelly, S.P., Hester, R., Garavan, H., et al., 2007. The role of cingulate cortex in the detection of errors with and without awareness: a high-density electrical mapping study. *Eur. J. Neurosci.* 25 (8), 2571–2579.
- Olson, C.K., 2010. Children's motivations for video game play in the context of normal development. *Rev. Gen. Psychol.* 14 (2), 180–187.
- Oppenheimer, D.M., 2008. The secret life of fluency. *Trends Cogn. Sci.* 12 (6), 237–241.
- Overbeek, T.J., Nieuwenhuis, S., Ridderinkhof, K.R., 2005. Dissociable components of error processing: on the functional significance of the Pe vis-à-vis the ERN/Ne. *J. Psychophysiol.* 19, 319–329.
- Parkin, A.J., 1998. The central executive does not exist. *J. Int. Neuropsychol. Soc.* 4 (5), 518–522.
- Parnandi, A., Son, Y., Gutierrez-Osuna, R., 2013. *A Control-Theoretic Approach to Adaptive Physiological Games*. Proceedings of the 2013 Humaine Association Conference on Affective Computing and Intelligent Interaction. Association for the Advancement of Affective Computing, Geneva, Switzerland, pp. 7–12.

- Pascual-Leone, J., Goodman, D., 1979. Intelligence and experience: a neopiagetian approach. *Instr. Sci.* 8, 301–367.
- Pauls, F., Macha, T., Petermann, F., 2013. U-shaped development: an old but unsolved problem. *Front. Psychol.* 4 (301), 1–6.
- Penzlin, A.I., Siepmann, T., Illigens, B.M., Weidner, K., Siepmann, M., 2015. Heart rate variability biofeedback in patients with alcohol dependence: a randomized controlled study. *Neuropsychiatr. Dis. Treat.* 11, 2619–2627.
- Phillips, M.L., Ladouceur, C.D., Drevets, W.C., 2008. A neural model of voluntary and automatic emotion regulation: implications for understanding the pathophysiology and neurodevelopment of bipolar disorder. *Mol. Psychiatry* 13 (9), 829–857.
- Piaget, J., 1971. *Biology and Knowledge*. University of Chicago Press, Chicago.
- Plant, K.L., Stanton, N.A., 2013. The explanatory power of Schema Theory: theoretical foundations and future applications in Ergonomics. *Ergonomics* 56 (1), 1–15.
- Polito, V., Barnier, A.J., Woody, E.Z., 2013. Developing the Sense of Agency Rating Scale (SOARS): an empirical measure of agency disruption in hypnosis. *Conscious. Cogn.* 22 (3), 684–696.
- Poole, J.L., 1991. Application of motor learning principles in occupational therapy. *Am. J. Occup. Ther.* 45, 531–537.
- Premsky, M., 2001. *Digital Game-Based Learning*. McGraw-Hill, New York.
- Prinzl, L., Pope, A., Freeman, F., 2001. Application of Physiological Self-regulation and Adaptive Task Allocation Techniques for Controlling Operator Hazardous States of Awareness. NASA/TM-2001-211015, L-18075, NAS 1.15:211015. NASA Langley Research Center, Hampton, VA.
- Przybylski, A.K., Rigby, C.S., Ryan, R.M., 2010. A motivational model of video game engagement. *Rev. Gen. Psychol.* 14 (2), 154–166.
- Reichert, J.L., Kober, S.E., Neuper, C., Wood, G., 2015. Resting-state sensorimotor rhythm (SMR) power predicts the ability to up-regulate SMR in an EEG-instrumental conditioning paradigm. *Clin. Neurophysiol.* 126 (11), 2068–2077.
- Rochet, N., Spieser, L., Casini, L., Hasbroucq, T., Burle, B., 2014. Detecting and correcting partial errors: evidence for efficient control without conscious access. *Cogn. Affect. Behav. Neurosci.* 14 (3), 970–982.
- Rose, N., 2009. Normality and pathology in a biomedical age. *Sociolog. Rev.* 57 (s2), 66–83.
- Ross Ashby, W., 1956. *An Introduction to Cybernetics*. Chapman & Hall, London, UK.
- Ros, T., Baars, B.J., Lanius, R.A., Vuilleumier, P., 2014. Tuning pathological brain oscillations with neurofeedback: a systems neuroscience framework. *Front. Hum. Neurosci.* 8 (1008), 1–22.
- Rotter, J.B., 1966. Generalized expectancies for internal versus external control of reinforcement. *Psychological Monographs: General and Applied* 80, 1–28.
- Rumelhart, D.E., Smolensky, P., McClelland, J.L., Hinton, G.E., 1986. Schemata and sequential thought processes in PDP models. In: McClelland, J.L., Rumelhart, D.E. (Eds.), *Parallel Distributed Processing: Explorations in the Microstructure of Cognition. Volume 2: Psychological and Biological Models*. MIT Press, Cambridge, MA, pp. 7–57.
- Routh, E.J., Fuller, A.T., 1975. *Stability of Motion*. Taylor & Francis, London, UK.
- Ryff, C.D., Keyes, C.L., 1995. The structure of psychological well-being revisited. *J. Pers. Soc. Psychol.* 69 (4), 719–727.
- Salmon, A.W., Schmidt, R.A., Walter, C.B., 1984. Knowledge of results and motor learning: a review and critical reappraisal. *Psychol. Bull.* 95 (3), 355–386.
- Sanders, D., Welk, D.S., 2005. Strategies to scaffold student learning: applying Vygotsky's Zone of Proximal Development. *Nurse Educ.* 30 (5), 203–207.
- Schafer, R.J., Moore, T., 2011. Selective attention from voluntary control of neurons in prefrontal cortex. *Science* 332, 1568–1571.
- Schmidt, R.A., Wrisberg, C.A., 2007. *Motor Learning and Performance, 4th edition*. Human Kinetics, Champaign, IL, US.
- Schwartz, N.M., Schwartz, M.S., 2003. Definitions of biofeedback and applied psychophysiology. In: Schwartz, M.S., Andrasik, F. (Eds.), *Biofeedback*. The Guilford Press, New York, pp. 27–42.
- Scott, S.H., 2004. Optimal feedback control and the neural basis of volitional motor control. *Nat. Rev. Neurosci.* 5, 532–546.
- Seidler, R.D., Bo, J., Anguera, J.A., 2012. Neurocognitive contributions to motor skill learning: the role of working memory. *J. Mot. Behav.* 44 (6), 445–453.
- Shirvinkar, P.R., 2009. Hippocampal neural assemblies and conscious remembering. *J. Neurophysiol.* 101 (5), 2197–2200.
- Sherlin, L.H., Arns, M., Lubar, J., Heinrich, H., Kerson, C., Strehl, U., 2011. Neurofeedback and basic learning theory: implications for research and practice. *J. Neurother.* 15, 292–304.
- Siegler, R.S., 2004. U-shaped interest in U-shaped development and what it means. *J. Cogn. Dev.* 5 (1), 1–10.
- Skinner, B.F., 1938. *The Behavior of Organisms: An Experimental Analysis*. Appleton-Century-Crofts, New York.
- Smith, E.E., Jonides, J., 1999. Storage and executive processes in the frontal lobes. *Science* 283, 1647–1661.
- Sperduti, M., Delaveau, P., Fossati, P., Nadel, J., 2011. Different brain structures related to self- and external-agency attribution: a brief review and meta-analysis. *Brain Struct. Funct.* 216, 151–157.
- Sreenivasan, K.K., Curtis, C.E., D'Esposito, M., 2014. Revisiting the role of persistent neural activity during working memory. *Trends Cogn. Sci.* 18 (2), 82–89.
- Sterman, M.B., Egner, T., 2006. Foundation and practice of neurofeedback for the treatment of epilepsy. *Appl. Psychophysiol. Biofeedback* 31 (1), 21–35.
- Stokes, M.G., 2015. 'Activity-silent' working memory in prefrontal cortex: a dynamic coding framework. *Trends Cogn. Sci.* 19 (7), 394–405.
- Strack, B.W., 2011. *Biofeedback & Neurofeedback Applications in Sport Psychology*. Association for Applied Psychophysiology and Biofeedback, Wheat Ridge, CO, USA.
- Strehl, U., 2014. What learning theories can teach us in designing neurofeedback treatments. *Front. Hum. Neurosci.* 8 (894), 1–8.
- Sterling, P., 2004. Principles of allostasis: Optimal design, predictive regulation, pathophysiology, and rational therapeutics. In: Schulkin, J. (Ed.), *Allostasis, homeostasis, and the costs of physiological adaptation*. Cambridge University Press, New York, NY, pp. 17–64.
- Swanson, L.R., Whittinghill, D.M., 2015. Intrinsic or extrinsic? Using videogames to motivate stroke survivors: a systematic review. *Games Health J.* 4 (3), 253–258.
- Sweller, J., 2010. Element interactivity and intrinsic, extraneous: and germane cognitive load. *Educ. Psychol. Rev.* 22, 123–138.
- Szynofzik, M., Thier, P., Lindner, A., 2006. Internalizing agency of self-action: perception of one's own hand movements depends on an adaptable prediction about the sensory action outcome. *J. Neurophysiol.* 96 (3), 1592–1601.
- Towse, J.N., Hitch, G.J., Horton, N., 2007. Working memory as the interface between processing and retention: a developmental perspective. *Adv. Child Dev. Behav.* 219–251.
- Trentelman, H., Stoorvogel, A.A., Hautus, M., 2001. *Control Theory for Linear Systems*. Springer-Verlag, London, UK.
- Tse, D., Langston, R., Kakeyama, M., Bethus, I., Spooner, P., Wood, E., 2007. Schemas and memory consolidation. *Science* 316 (5821), 76–82.
- Valsiner, J., 2012. *The Oxford Handbook of Culture and Psychology*. Oxford University Press, New York, NY.
- Varela, F., Lachaux, J.P., Rodriguez, E., Martinerie, J., 2001. The brainweb: phase synchronization and large-scale integration. *Nat. Rev. Neurosci.* 2, 229–239.
- Vidal, F., Meckler, C., Hasbroucq, T., 2015. Basics for sensorimotor information processing: some implications for learning. *Front. Psychol.* 6 (33).
- Vincent, J., Kahn, I., Snyder, A., Raichle, M., Buckner, R., 2008. Evidence for a frontoparietal control system revealed by intrinsic functional connectivity. *J. Neurophysiol.* 100 (6), 3328–3342.
- Vinney, L.A., Turkstra, L.S., 2013. The role of self-regulation in voice therapy. *J. Voice* 27 (3), 390.e1–e11.
- Wallace, A.F., 1960. Plans and the structure of behavior. George A. Miller, Eugene Galanter, and Karl H. Pribram. Book review. *Am. Anthropol.* 62 (6), 1065–1067.
- Walsh, M.M., Anderson, J.R., 2012. Learning from experience: event-related potential correlates of reward processing, neural adaptation, and behavioral choice. *Neurosci. Biobehav. Rev.* 36, 1870–1884.
- Weeks, K.W., Higginson, R., Clochesy, J.M., Coben, D., 2013. Safety in numbers 7: Veni, vidi, duci: a grounded theory evaluation of nursing students' medication dosage calculation problem-solving schemata construction. *Nurse Educ. Pract.* 13 (2), e78–87.
- Wiener, N., 1948. *Cybernetics: Or Control and Communication in the Animal and the Machine*. The MIT Press, Cambridge, Massachusetts, 2nd revised ed. 1961.
- Wilson, P.H., Thorpe, C.W., Callaghan, J., 2005. August 4–6. Looking at singing: does real-time visual feedback improve the way we learn to sing. Second APSCOM Conference: Asia-Pacific Society for the Cognitive Sciences of Music, South Korea, Seoul.
- Wilts, C.H., 1960. *Principles of Feedback Control*. Addison-Wesley Educational Publishers Inc., Reading, Massachusetts, USA.
- Winstein, C.J., Schmidt, R.A., 1990. Reduced frequency of knowledge of results enhances motor skill learning. *J. Exp. Psychol. Learn. Mem. Cogn.* 16, 677–691.
- Witte, M., Kober, S., Ninaus, M., Neuper, C., Wood, G., 2013. Control beliefs can predict the ability to up-regulate sensorimotor rhythm during neurofeedback training. *Front. Hum. Neurosci.* 7, 1–8.
- Wood, D., Bruner, J., Ross, G., 1976. The role of tutoring in problem solving. *J. Child Psychol. Child Psychiatry* 17, 89–100.
- Wood, G., Kober, S.E., Witte, M., Neuper, C., 2014. On the need to better specify the concept of control in brain-computer-interfaces/neurofeedback research. *Front. Syst. Neurosci.* 8 (171), 1–4.
- Wulf, G., Shea, C., Lewthwaite, R., 2010. Motor skill learning and performance: a review of influential factors. *Med. Educ.* 44 (1), 75–84.
- Yager, L.M., Garcia, A.F., Wunsch, A.M., Ferguson, S.M., 2015. The ins and outs of the striatum: role in drug addiction. *Neuroscience* 301, 529–541.
- Yeung, N., Sanfey, A.G., 2004. Independent coding of reward magnitude and valence in the human brain. *J. Neurosci.* 24 (28), 6258–6264.
- Yoshida, K., Asakawa, K., Yamauchi, T., Sakuraba, S., Sawamura, D., Murakami, Y., et al., 2013. The flow state scale for occupational tasks: development, reliability, and validity. *Hong Kong J. Occup. Ther.* 23 (2), 54–61.
- Yucha, C.B., Montgomery, D., 2008. *Evidence-based Practice in Biofeedback and Neurofeedback*. Association for Applied Psychophysiology and Biofeedback, Wheat Ridge, CO.
- van Kesteren, M.T., Fernández, G., Norris, D.G., Hermansa, E.J., 2010. Persistent schema-dependent hippocampal-neocortical connectivity during memory encoding and postencoding rest in humans. *Proc. Natl. Acad. Sci. U. S. A.* 107, 7550–7555.
- van Merriënboer, J.J., Sweller, J., 2010. Cognitive load theory in health professional education: design principles and strategies. *Med. Educ.* 44, 85–93.
- Zoefel, B., Huster, R., Herrmann, C., 2011. Neurofeedback training of the upper alpha. *NeuroImage* 2, 1427–1431.
- Zolten, A.J., 1989. *Constructive Integration of Learning Theory and Phenomenological Approaches to Biofeedback Training*. *Biofeedback and Self-Regulation* 14 (2), 89–99.