

# Winning Ways for Your Mathematical Plays, Volume 1



# Winning Ways

for Your Mathematical Plays



Volume 1, Second Edition

Elwyn R. Berlekamp, John H. Conway, Richard K. Guy



A K Peters  
Wellesley, Massachusetts

Editorial, Sales, and Customer Service Office

A K Peters, Ltd.

888 Worcester Street, Suite 230

Wellesley, MA 02482

Copyright © 2001 by A K Peters, Ltd.

All rights reserved. No part of the material protected by this copyright notice may be reproduced or utilized in any form, electronic or mechanical, including photocopying, recording, or by any information storage and retrieval system, without written permission from the copyright owner.

**Library of Congress Cataloging-in-Publication Data**

Berlekamp, Elwyn R.

Winning Ways for your mathematical plays / Elwyn Berlekamp, John H. Conway, Richard Guy.--2nd ed.

p. cm.

Includes bibliographical references and index.

ISBN 1-56881-130-6 (alk.paper)

1. Mathematical recreations. I. Conway, John Horton. II. Guy Richard K. III. Title.

QA95 .B446 2000

739.74--dc21

00-048541

Printed in India

08 07 06 05

10 9 8 7 6 5 4 3 2



To Martin Gardner

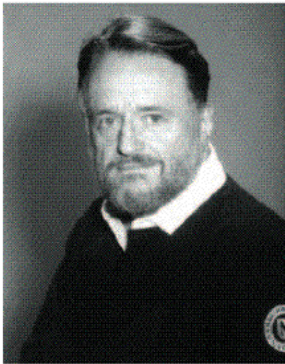
who has brought more mathematics to more millions than anyone else





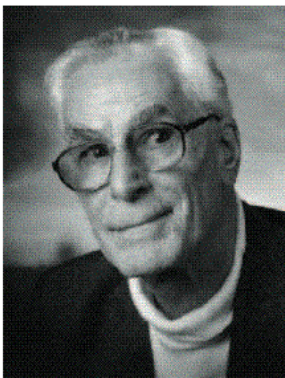
**Elwyn Berlekamp** was born in Dover, Ohio, on September 6, 1940. He has been Professor of Mathematics and of Electrical Engineering/Computer Science at UC Berkeley since 1971. He has also been active in several technology business ventures. In addition to writing many journal articles and several books, Berlekamp also has 12 patented inventions, mostly dealing with algorithms for synchronization and error correction.

He is a member of the National Academy of Sciences, the National Academy of Engineering, and the American Academy of Arts and Sciences. From 1994 to 1998, he was chairman of the board of trustees of the Mathematical Sciences Research Institute (MSRI).



**John H. Conway** was born in Liverpool, England, on December 26, 1937. He is one of the preeminent theorists in the study of finite groups and the mathematical study of knots, and has written over 10 books and more than 140 journal articles.

Before joining Princeton University in 1986 as the John von Neumann Distinguished Professor of Mathematics, Conway served as professor of mathematics at Cambridge University, and remains an honorary fellow of Caius College. The recipient of many prizes in research and exposition, Conway is also widely known as the inventor of the Game of Life, a computer simulation of simple cellular "life," governed by remarkably simple rules.



**Richard Guy** was born in Nuneaton, England, on September 30, 1916. He has taught mathematics at many levels and in many places—England, Singapore, India, and Canada. Since 1965 he has been Professor of Mathematics at the University of Calgary, and is now Faculty Professor and Emeritus Professor. The university awarded him an Honorary Degree in 1991. He was Noyce Professor at Grinnell College in 2000.

He continues to climb mountains with his wife, Louise, and they have been patrons of the Association of Canadian Mountain Guides' Ball and recipients of the A. O. Wheeler award for Service to the Alpine Club of Canada.



# Contents

Preface to Second Edition	xv
Preface	xvi
Spade-Work!	xix
<b>1 Whose Game?</b>	<b>1</b>
Blue-Red Hackenbush	2
The Tweedledum and Tweedledee Argument	3
How Can You Have Half a Move?	4
... And Quarter Moves?	6
Ski-Jumps for Beginners	8
Don't Just Take the Average!	10
What Is a Jump Worth?	11
Toads-and-Frogs	12
Do Our Methods Work?	12
What is a Game?	14
When Is a Move Good?	16
Figure 8(d) Is Worth $\frac{3}{4}$	17
References and Further Reading	18
<b>2 Finding the Correct Number is Simplicity Itself</b>	<b>19</b>
Which Numbers Are Which?	19
Simplicity's the Answer!	21
Simplest Forms for Numbers	22
Cutcake	24
Maundy Cake	26
A Few More Applications of the Simplicity Rule	27
Positive, Negative, Zero, and Fuzzy Positions	28
Hackenbush Hotchpotch	29
Sums of Arbitrary Games	30
The Outcome of a Sum	31
The Negative of a Game	33
Cancelling a Game with its Negative	34
Comparing Two Games	35
Comparing Hackenbush Positions	35
The Game of Col	37
A Star is Born!	38
Col Contains Such Values	39
Game Trees	40



Green Hackenbush, The Game of Nim, and Nimbers . . . . .	40
Get Nimble with Nimbers . . . . .	42
Childish Hackenbush . . . . .	43
Seating Couples . . . . .	44
Winning Strategies . . . . .	46
The Sum of Two Finite Games Can Last Forever . . . . .	46
A Theorem about Col . . . . .	47
Col-lections and Col-lapsings . . . . .	48
Maundy Cake . . . . .	51
Another Cutcake Variant . . . . .	51
How Childish Can You Get? . . . . .	51
References and Further Reading . . . . .	52
<b>3 Some Harder Games and How to Make Them Easier . . . . .</b>	<b>53</b>
Poker-Nim . . . . .	53
Northcott's Game . . . . .	54
Bogus Nim-Heaps and the Mex Rule . . . . .	55
The Sprague-Grundy Theory for Impartial Games . . . . .	56
The White Knight . . . . .	56
Adding Nimbers . . . . .	58
Wyt Queens . . . . .	59
Reversible Moves in General Games . . . . .	60
Deleting Dominated Options . . . . .	62
Toads-and-Frogs with Ups and Downs . . . . .	63
Game Tracking and Identification . . . . .	65
What Are Flowers Worth? . . . . .	66
A Gallimaufry of Games . . . . .	67
Who Wins Sums of Ups, Downs, Stars, and Numbers? . . . . .	68
A Closer Look at the Stars . . . . .	68
The Values $\{\uparrow   \uparrow\}$ and $\{0   \uparrow\}$ . . . . .	69
The Upstart Equality . . . . .	71
Gift Horses . . . . .	72
The Nim-Addition Rule in Several Variations . . . . .	73
Wyt Queens and Wythoff's Game . . . . .	74
Answers to Figures 8, 9, and 11. . . . .	75
Toad Versus Frog . . . . .	75
Two Theorems on Simplifying Games . . . . .	76
Berlekamp's Rule for Hackenbush Strings . . . . .	77
References and Further Reading . . . . .	78
<b>4 Taking and Breaking . . . . .</b>	<b>81</b>
Kayles . . . . .	81
Games With Heaps . . . . .	82
$\mathcal{P}$ -Positions and $\mathcal{N}$ -Positions . . . . .	83
Subtraction Games . . . . .	83
Ferguson's Pairing Property . . . . .	86
Grundy Scales . . . . .	87
Other Take-Away Games . . . . .	87



Dawson's Chess . . . . .	88
The Periodicity of Kayles . . . . .	90
Other Take-and-Break Games . . . . .	91
Dawson's Kayles . . . . .	92
Variations . . . . .	93
Guiles . . . . .	93
Treblecross . . . . .	94
Officers . . . . .	95
Grundy's Game . . . . .	96
Prim and Dim . . . . .	97
Replication of Nim-Values . . . . .	98
Double and Quadruple Kayles . . . . .	98
Lasker's Nim . . . . .	99
Some Remarks on Periodicity . . . . .	100
Standard Form . . . . .	100
A Compendium of Octal Games . . . . .	101
Additional Remarks . . . . .	109
Sparse Spaces and Common Cosets . . . . .	109
Will Grundy's Game Be Ultimately Periodic? . . . . .	111
Sparse Space Spells Speed . . . . .	112
Games Displaying Arithmetic Periodicity . . . . .	113
A Non-Arithmetic-Periodicity Theorem . . . . .	115
Some Hexadecimal Games . . . . .	117
Further References and Reading . . . . .	117
<b>5 Numbers, Nimbers and Numberless Wonders . . . . .</b>	<b>119</b>
Domineering . . . . .	119
Switch Games . . . . .	121
Cashing Cheques . . . . .	122
Some Simple Hot Games . . . . .	125
The Tiniest Games . . . . .	125
Modern Management of Cash Flow . . . . .	126
Tiny Toads-and-Frogs . . . . .	127
The Opening Dissection of Toads-and-Frogs . . . . .	127
Seating Boys and Girls . . . . .	131
Toads-and-Frogs Completely Dissected . . . . .	133
Toads-and-Frogs with Two Spaces . . . . .	136
More Domineering Values . . . . .	138
References . . . . .	143
<b>6 The Heat of Battle . . . . .</b>	<b>145</b>
Snort . . . . .	145
A Graphic Picture of Farm Life . . . . .	145
Don't Move In A Number Unless There's Nothing Else To Do! . . . . .	147
What's in it for Me? . . . . .	148
The Left and Right Stops . . . . .	149
Cooling—and the Thermograph . . . . .	151
Cooling Settles the Mean Value . . . . .	152



How to Draw Thermographs . . . . .	153
When A Player Has Several Options . . . . .	154
Foundations for Thermographs . . . . .	155
Examples of Thermographs . . . . .	156
Who Is To Move From The Final Stop? . . . . .	157
A Four-Stop Example . . . . .	158
The Cheque-Market Exchange . . . . .	158
Equitable Games . . . . .	159
Excitable Games . . . . .	160
The Extended Thermograph . . . . .	161
Getting the Right Slant . . . . .	162
The Thermostatic Strategy . . . . .	163
Thermostat's Not Often Wrong! . . . . .	165
Heating . . . . .	167
Does The Excitement Show? . . . . .	169
Selling Infinitesimal Values To Your Profit-Conscious Friends . . . . .	171
Nim, Remoteness and Suspense in Hot Games . . . . .	173
Overheating . . . . .	174
Cooling the Children's Party . . . . .	178
But How Do You Cool A Party By One Degree? . . . . .	179
Three Snort Lemmas . . . . .	180
A Snort Dictionary . . . . .	183
Proof of the Number Avoidance Theorem . . . . .	183
Why Thermostat Works . . . . .	183
Blockbusting . . . . .	186
... An On We Go! . . . . .	186
Hotstrat, Thermostat and Sentestrat . . . . .	187
References and Further Reading . . . . .	188
<b>7 Hackenbush . . . . .</b>	<b>189</b>
Green Hackenbush . . . . .	189
Green Trees . . . . .	191
Fusion . . . . .	192
Proving The Fusion Principle . . . . .	193
A More Complicated Picture . . . . .	195
Impartial Maundy Cake . . . . .	196
Blue-Red Hackenbush . . . . .	197
Hackenbush Hotchpotch . . . . .	197
Flower Gardens . . . . .	198
The Blue Flower Ploy . . . . .	199
Atomic Weights . . . . .	200
Atomic Weights of Jungles . . . . .	201
Making Tracks in the Jungle . . . . .	202
Tracking Down an Animal . . . . .	204
Amazing Jungle . . . . .	208
Smart Game in the Jungle . . . . .	209
Unparted Jungles . . . . .	210
Blue-Red Hackenbush Can Be Hard, Too! . . . . .	211





Redwood Furniture . . . . .	211
Redwood Beds . . . . .	215
How Big Is A Redwood Bed? . . . . .	216
What's The Bottle . . . . .	218
Ordinal Addition, The Colon Principle, and Norton's Lemma . . . . .	219
Both Ways of Adding Impartial Games . . . . .	219
Many-Way Maundy Cake . . . . .	220
Solution to Figure 15 . . . . .	221
Tracks Cleared Through the Amazing Jungle . . . . .	222
How Hard Was The Bed? . . . . .	222
NP-Hardness . . . . .	223
The Bottle at the End of Chapter 7 . . . . .	225
References and Further Reading . . . . .	225
<b>8 It's a Small Small Small Small World</b> . . . . .	<b>229</b>
Uppitiness and Uncertainty . . . . .	230
Computing Atomic Weights . . . . .	231
Eatcake . . . . .	233
Splitting The Atom . . . . .	234
Turn-and-Eatcake . . . . .	235
All You Need To Know About Atomic Weights But Were Afraid To Ask . . . . .	236
Childish Hackenbush Hotchpotch . . . . .	237
Atomic Weights of Lollipops . . . . .	238
Proving Things About Atomic Weights . . . . .	240
Playing Among the Flowers . . . . .	240
When is $g$ as uppity as $h$ ? . . . . .	241
Go Fly A Kite! . . . . .	243
All Remote Stars Agree . . . . .	244
Large and Small Flowerbeds . . . . .	245
Playing Under a Lucky Star . . . . .	246
General Multiples of Up . . . . .	247
Proof of the Remote Star Rules . . . . .	248
Proof That Atomic Weight = Uppitiness . . . . .	249
The Wholeness of Hackenbush Hotchpotch . . . . .	251
Proper Care of the Eccentric . . . . .	251
Galvanized Games . . . . .	252
Trading Triangles . . . . .	253
Multiples of Positive Games . . . . .	255
Multiples Work! . . . . .	255
First for the "With" Rule . . . . .	256
Now for the "Without" Rule: . . . . .	257
Shifting Multiples Of Up By Stars . . . . .	258
A Theorem on Incentives . . . . .	258
Seating Families of Five . . . . .	260
References . . . . .	262
<b>Index</b> . . . . .	<b>263</b>



# Preface to the Second Edition

It's high time that there was a second edition of *Winning Ways*.

Largely as a result of the first edition, and of John Conway's *On Numbers and Games*, which we are glad to say is also reappearing, the subject of combinatorial games has burgeoned into a vast area, bringing together artificial intelligence experts, combinatorists, and computer scientists, as well as practitioners and theoreticians of particular games such as Go, Chess, Amazons and Konane: games much more interesting to play than the simple examples that we needed to introduce our theory.

Just as the subject of combinatorics was slow to be accepted by many "serious" mathematicians, so, even more slowly, is that of combinatorial games. But now it has achieved considerable maturity and is giving rise to an extensive literature, documented by Aviezri Fraenkel and exemplified by the book *Mathematical Go: Chilling Gets the Last Point* by Berlekamp and Wolfe. Games are fun to play and it's more fun the better you are at playing them.

The subject has become too big for us to do it justice even in the four-volume work that we now offer. So we've contented ourselves with a minimum of necessary changes to the original text (we are proud that our first formulations have so well withstood the test of time), with additions to the Extras at the ends of the chapters, and with the insertion of many references to guide the more serious student to further reading. And we've corrected some of the one hundred and sixty-three mistakes.

We are delighted that Alice and Klaus Peters have agreed to publish this second edition. Their great experience, and their competent and cooperative staff, notably Sarah Gillis and Kathryn Maier, have been invaluable assets during its production. And of course we are indebted to the rapidly growing band of people interested in the subject. If we mention one name we should mention a hundred; browse through the Index and the References at the end of each chapter. As a start, try *Games of No Chance*, the book of the workshop that we organized a few years ago, and look out for its successor, *More Games of No Chance*, documenting the workshop that took place earlier this year.

Elwyn Berlekamp, University of California, Berkeley  
John Conway, Princeton University  
Richard Guy, The University of Calgary, Canada

November 3, 2000

# Preface

Does a book need a Preface? What more, after fifteen years of toil, do three talented authors have to add. We can reassure the bookstore browser, “Yes, this is just the book you want!” We can direct you, if you want to know quickly what’s in the book, to the last pages of this preliminary material. This in turn directs you to Volume 1, Volume 2, Volume 3 and Volume 4.

We can supply the reviewer, faced with the task of ploughing through nearly a thousand information-packed pages, with some pithy criticisms by indicating the horns of the polylemma the book finds itself on. It is not an encyclopedia. It is encyclopedic, but there are still too many games missing for it to claim to be complete. It is not a book on recreational mathematics because there’s too much serious mathematics in it. On the other hand, for us, as for our predecessors Rouse Ball, Dudeney, Martin Gardner, Kraitchik, Sam Loyd, Lucas, Tom O’Beirne and Fred. Schuh, mathematics itself is a recreation. It is not an undergraduate text, since the exercises are not set out in an orderly fashion, with the easy ones at the beginning. They are there though, and with the hundred and sixty-three mistakes we’ve left in, provide plenty of opportunity for reader participation. So don’t just stand back and admire it, work of art though it is. It is not a graduate text, since it’s too expensive and contains far more than any graduate student can be expected to learn. But it does carry you to the frontiers of research in combinatorial game theory and the many unsolved problems will stimulate further discoveries.

We thank Patrick Browne for our title. This exercised us for quite a time. One morning, while walking to the university, John and Richard came up with “Whose game?” but realized they couldn’t spell it (there are three tooze in English) so it became a one-line joke on line one of the text. There isn’t room to explain all the jokes, not even the fifty-nine private ones (each of our birthdays appears more than once in the book).

Omar started as a joke, but soon materialized as Kimberley King. Louise Guy also helped with proof-reading, but her greater contribution was the hospitality which enabled the three of us to work together on several occasions. Louise also did technical typing after many drafts had been made by Karen McDermid and Betty Teare.

Our thanks for many contributions to content may be measured by the number of names in the index. To do real justice would take too much space. Here’s an abridged list of helpers: Richard Austin, Clive Bach, John Beasley, Aviezri Fraenkel, David Fremlin, Solomon Golomb,



Steve Grantham, Mike Guy, Dean Hickerson, Hendrik Lenstra, Richard Nowakowski, Anne Scott, David Seal, John Selfridge, Cedric Smith and Steve Tschantz.

No small part of the reason for the assured success of the book is owed to the well-informed and sympathetic guidance of Len Cegielka and the willingness of the staff of Academic Press and of Page Bros. to adapt to the idiosyncrasies of the authors, who grasped every opportunity to modify grammar, strain semantics, pervert punctuation, alter orthography, tamper with traditional typography and commit outrageous puns and inside jokes.

Thanks also to the Isaak Walton Killam Foundation for Richard's Resident Fellowship at The University of Calgary during the compilation of a critical draft, and to the National (Science & Engineering) Research Council of Canada for a grant which enabled Elwyn and John to visit him more frequently than our widely scattered habitats would normally allow.

And thank you, Simon!

*University of California, Berkeley, CA 94720*

*University of Cambridge, England, CB2 1SB*

*University of Calgary, Canada, T2N 1N4*


*November 1981*

*Elwyn Berlekamp*

*John H. Conway*

*Richard Guy*

You are  
now here



If you want to know roughly what's elsewhere,  
turn to the little notes about our four main themes:

- Adding Games ... .. ♣ Volume 1
- Bending the Rules ... .. ♥ Volume 2
- Case Studies ... .. ♣ Volume 3
- Doing It Yourself ... .. ♦ Volume 4

There are a number of other connexions between various chapters of the book:

T H E O R Y													P R A C T I C E																									
General Addition													Other Theories													Case Studies												
1	2	3	4	5	6	7	8	9	10	11	12	13	14	15	16	17	18	19	20	21	22	23	24	25														
Numbers	Nimbers	Heat	Hackensbush	SmallGames	moves	Loopy	Coins	Pen&Paper	Trapping	On Your Own																												
Basics													Nim-like Games																									
Varied Values													T a b u l a t i n g													Board Games												

However, you should be able to pick any chapter and read almost all of it without reference to anything earlier, except perhaps the basic ideas at the start of the book.



# Spade-Work!

Let spades be trumps! she said, and trumps they were.

Alexander Pope, *The Rape of the Lock*, c.iii, l.46.

CECILY: When I see a spade I call it a spade.

GWENDOLEN: I am glad to say I have never seen a spade.

Oscar Wilde, *The Importance of Being Earnest*, II.

Our first few chapters do the spade-work for the rest by telling how to add games together and how to work out their values.

Chapters 1 and 2 introduce these ideas and show that some simple examples have ordinary numbers for values while others don't.

In Chapter 3 you'll see how the special values called nimbers, that arise in the game of Nim, suffice for *all* impartial games, and lots of examples are tackled in Chapter 4.

Chapter 5 has some very small games, and some others which, because they are both big (unlike nimbers) and hot (unlike nimbers), really need the theory of Chapter 6.

Finally, Chapter 7 discusses the small games to within an atom or two, and Chapter 8 show how such values arise along with ordinary numbers in the game of Hackenbush.





-1-

# Whose Game?

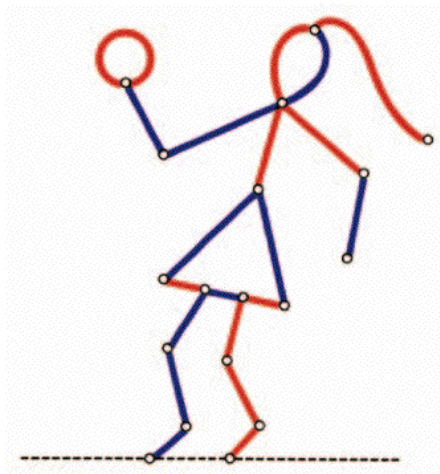
'Begin at the beginning,' the King said, gravely, 'and go on till you come to the end, then stop.'

Lewis Carroll, *Alice in Wonderland*, ch. 12

It is hard if I cannot start some game on these lone heaths.

William Hazlitt, *On Going a Journey*

Who's game for an easy pencil-and-paper (or chalk-and-blackboard) game?



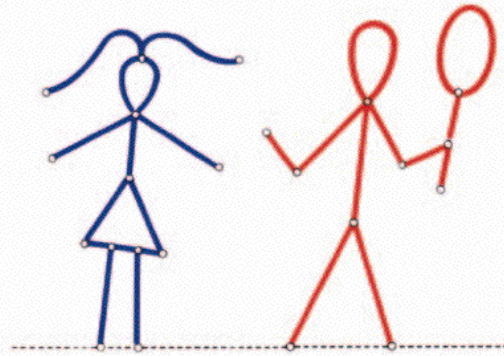
**Figure 1.** A Blue-Red Hackenbush Picture.



## Blue-Red Hackenbush

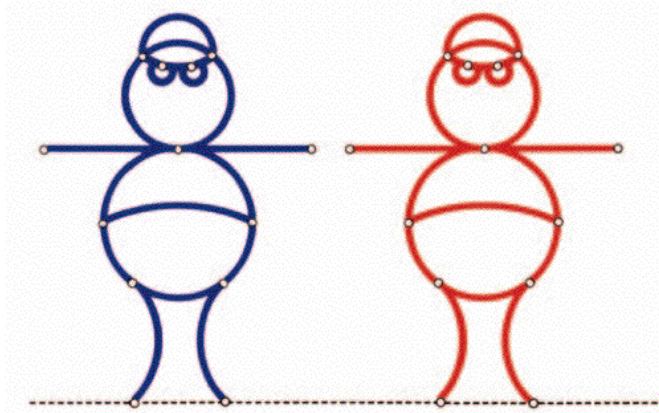
Blue-Red Hackenbush is played with a picture such as that of Fig. 1. We shall call the two players **Left** and **Right**. Left moves by deleting any blue edge, together with any edges that are no longer connected to the ground (which is the dotted line in the figure), and Right moves by deleting a Red edge in a similar way. (Play it on a blackboard if you can, because it's easier to rub the edges out.) Quite soon, one of the players will find he can't move because there are no edges of his color in what remains of the picture, and whoever is first trapped in this way is the loser. You must make sure that doesn't happen to you!

Well, what can you do about it? Perhaps it would be a good idea to sit back and watch a game first, to make sure you quite understand the rules of the game before playing with the professionals, so let's watch the effect of a few simple moves. Left might move first and rub out the girl's left foot. This would leave the rest of her left leg dangling rather lamely, but no other edges would actually disappear because every edge of the girl is still connected to the ground through her right leg. But Right at his next move could remove the girl completely, if he so wished, by rubbing out her right foot. Or Left could instead have used his first move to remove the girl's upper arm, when the rest of her arm and the apple would also disappear. So now you really understand the rules, and want to start winning. We think Fig. 1 might be a bit hard for you just yet, so let's look at Fig. 2, in which the blue and red edges are separated into parts that can't interact. Plainly the girl belongs to Left, in some sense, and the boy to Right, and the two players will alternately delete edges of their two people. Since the girl has more edges, Left can survive longer than Right, and can therefore win no matter who starts. In fact, since the girl has 14 edges to the boy's 11, Left ends with at least  $14 - 11 = 3$  spare moves, if he chops from the top downwards, and Right can hold him down to this in a similar way.



**Figure 2.** Boy meets Girl.

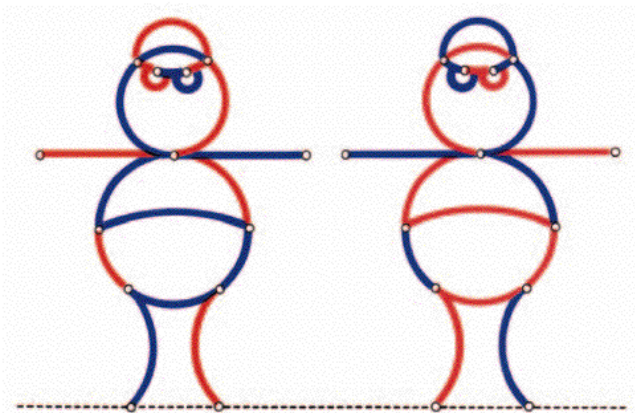
Tweedledum and Tweedledee in Fig. 3 have the same number of edges each, so that Left is  $19 - 19 = 0$  moves ahead. What does this mean? If Left starts, and both players play sensibly from the top downwards, the moves will alternate Left, Right, Left, Right, until each player has made 19 moves, and it will be Left's turn to move when no edge remains. So if Left starts, Left will lose, and similarly if Right starts, Right will lose. So in this **zero position**, whoever starts loses.



**Figure 3.** Tweedledum and Tweedledee, about to have a Battle.

### The Tweedledum and Tweedledee Argument

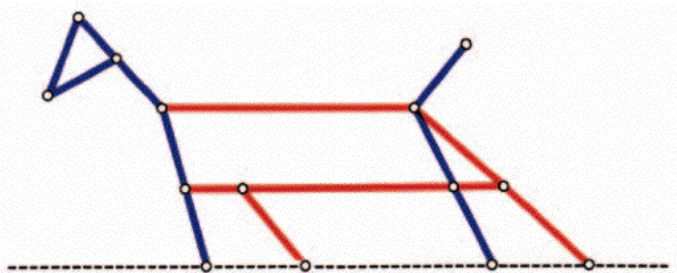
In Fig. 4, we have swapped a few edges about so that Tweedledum and Tweedledee both have some edges of each color. But since we turn the new Dum into the new Dee exactly by interchanging blue with red, neither player seems to have any advantage. Is Fig. 4 still a zero position in the same sense that whoever starts loses? Yes, for the player second to move can copy any of his opponent's moves by simply chopping the corresponding edge from the other twin. If he does this throughout the game, he is sure to win, because he can never be without an available move. We shall often find games for which an argument like this gives a good strategy for one of the two players—we shall call it the **Tweedledum and Tweedledee Argument** (or **Strategy**) from now on.



**Figure 4.** After their first Battle: Ready for the Next?



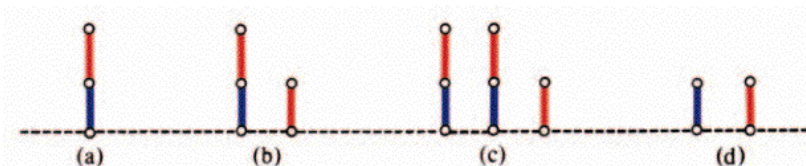
The main difficulty in playing Blue-Red Hackenbush is that your opponent might contrive to steal some of your moves by cutting out of the picture a large number of edges of your color. But there are several cases when even though the picture may look very complicated, you can be sure that he will be unable to do this. Figure 5 shows a simple example. In this little dog, each player's edges are connected to the ground via other edges of his own color. So if he chops these in a suitable order, each player can be sure of making one move for each edge of his own color, and plainly he can't hope for more. The value of Fig. 5 is therefore once again determined by counting edges—it is  $9 - 7 = 2$  moves for Left. In pictures like this, the correct chopping order is to take first those edges whose path to the ground via your own color has most edges—this makes sure you don't isolate any of your edges by chopping away any of their supporters. Thus in Fig. 5 Left would be extremely foolish to put the blue edges of the neck and head at risk by removing the dog's front leg; for then Right could arrange that after only 2 moves the 5 blue edges here would have vanished.



**Figure 5.** A Dog with Leftward Leanings.

### How Can You Have Half a Move?

But these easy arguments won't suffice for all Hackenbush positions. Perhaps the simplest case of failure is the two-edge "picture" of Fig. 6(a). Here if Left starts, he takes the bottom edge and wins instantly, but if Right starts, necessarily taking the top edge, Left can still remove the bottom edge and win. So Left can win no matter who starts, and this certainly sounds like a positive advantage for Left. Is it as much as a 1-move advantage? We can try counterbalancing it by putting an extra red edge (which counts as a 1-move advantage for Right) on the ground, getting Fig. 6(b). Who wins now?



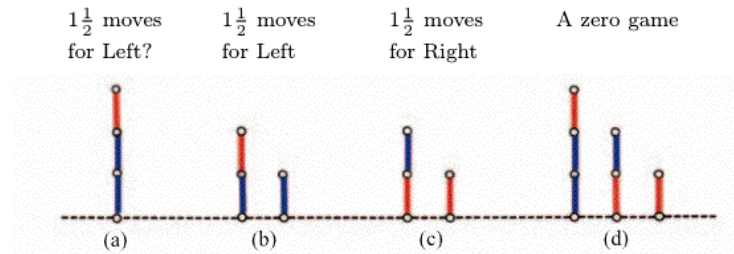
**Figure 6.** What do we mean by Half a Move?

If Right starts, he should take the higher of his two red edges, since this is clearly in danger. Then when Left removes his only blue edge, Right can still move and win. If Left starts, his only possible move still leaves Right a free edge, and so Right still wins. So this time, it is Right that wins, whoever starts, and Left's positive advantage of Fig. 6(a) has now been overwhelmed by adding the free move for Right. We can say that Left's advantage in Fig. 6(a), although positive, was strictly less than an advantage of one free move. Will it perhaps be one-half of a move?

We test this in Fig. 6(c), made up of *two* copies of Fig. 6(a) with just *one* free move for Right added, since if we are correct  $\frac{1}{2} + \frac{1}{2}$  for Left will exactly balance 1 for Right. Who wins Fig. 6(c)? Left has essentially only one kind of move, leading to a picture like Fig. 6(b), which we know Right wins. On the other hand, if Right starts sensibly by taking either of his two threatened edges, Left will move to a picture like Fig. 6(d) and win after Right's next move. If Right has used up his free move at the outset, Left's reply would take us to Fig. 6(a), which we know he wins.

We've just shown that Right wins if Left starts and Left wins if Right starts, so that Fig. 6(c) is a zero game. This seems to show that *two* copies of Fig. 6(a) behave just like *one* free move for Left, in that together they exactly counterbalance a free move for Right. So it's really quite sensible to regard Fig. 6(a) as being a half-move's advantage for Left.

Putting Right's red edge partly under Left's control made Fig. 6(a) worse for him than Fig. 6(d). So perhaps Fig. 7(a) should be worth less to Right than Fig. 7(b) in which Right's edge is threatened by only one of Left's?



**Figure 7.** Is Right's Edge even more under Left's Control?

We are asking whether Fig. 7(a) is worth exactly  $1\frac{1}{2}$  moves to Left like Fig. 7(b). We can test this by adding  $1\frac{1}{2}$  free moves for Right to Fig. 7(a). Since Fig. 7(c) is the opposite of Fig. 7(b), we produce the required allowance by adjoining it to Fig. 7(a), giving Fig. 7(d).

Who wins this complicated little pattern? Here each player has just one risky edge partly in control of his opponent, and if a player starts by taking his risky edge, his opponent can remove the other, leaving two unfettered moves each. If instead he takes the edge just below his opponent's risky edge, the opponent can do likewise, now leaving just one free move each. The only other starting move for Left is stupid since it leaves only red edges touching the ground and indeed Right can win with a move to spare.

What about Right's remaining move? Since this is to remove the isolated red edge, it *must* be stupid, for surely it would be better to take the middle red edge and so demolish a blue

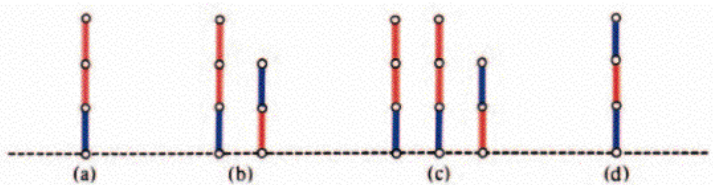




edge at the same time? And indeed Left's reply of chopping the middle edge of the chain of three proves perfectly adequate. So *every* first move loses, and once again the game is what we called a zero game. This seems to show that contrary to our first guess, Figs. 7(a) and 7(b) confer exactly the same advantage to Left, namely one and a half free moves.

### ... And Quarter Moves?

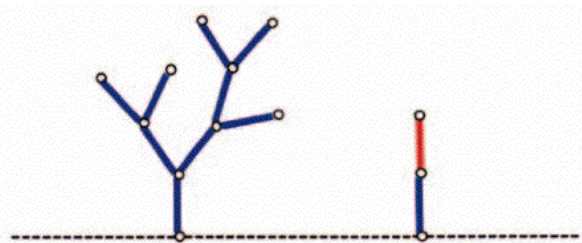
In Fig. 8(a), Right's topmost edge is partly under Left's control, but also partly under Right's as well, so it should perhaps be worth more to him than his middle one? Since we found that the middle edge was worth half a move to Right, the pair of red edges collectively would then be worth at least a whole move to him, counteracting Left's single edge. So maybe Right has the advantage here?



**Figure 8.** Are Right's Edges worth more than Left's?

This naive opinion is dispelled as soon as play starts, for Left's only move wins the game as soon as he makes it, showing that Fig. 8(a) gives a positive advantage to Left. But when we adjoin half a move for Right as in Fig. 8(b), Right can win by playing first, by removing the topmost edge, or playing second, by removing the highest red edge remaining. So Fig. 8(a), though a positive advantage for Left, is worth even less to him than half a move. Is it perhaps, being three edges high, worth just one-third of a move? No! We leave the reader to show that two copies of Fig. 8(a) exactly balance half a move for Right, by showing that the second player to move wins Fig. 8(c), so that Fig. 8(a) is in fact a quarter move's advantage for Left.

And how much is Fig. 8(d) worth?



**Figure 9.** A Hackenbush Position worth  $9\frac{1}{2}$ .

Figure 9 shows a Hackenbush position of value  $9\frac{1}{2}$ , since the tree has value 9, and the rest value  $\frac{1}{2}$ . What are the moves here? Right has a unique red edge, and so a unique move, to a position of value  $9 + 1 = 10$ , but Left can move either at the top of the tree, leaving  $8\frac{1}{2}$ , or by removing the  $\frac{1}{2}$  completely, which is a better move, since it leaves value 9. Since Left's best

move is to value 9, and Right's to 10, we express this by writing

$$\{9|10\} = 9\frac{1}{2} \quad (\text{"9 slash 10 equals } 9\frac{1}{2}\text{"})$$

In a similar way, we have the more general equation

$$\{n|n+1\} = n + \frac{1}{2},$$

of which the simplest case is

$$\{0|1\} = \frac{1}{2},$$

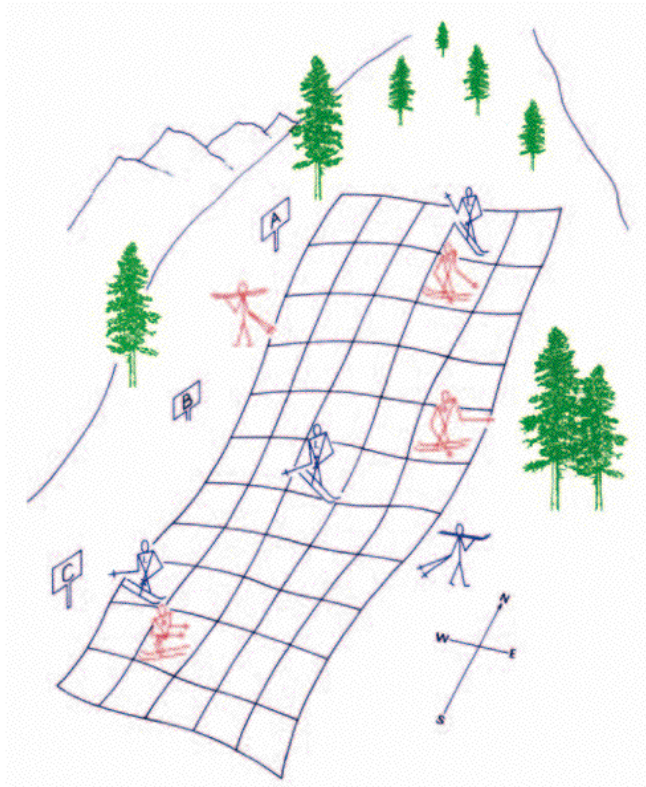
with which we began. We also have the simpler equation

$$\{n|\} = n + 1$$

for each  $n = 0, 1, 2, \dots$ , for if Left has just  $n + 1$  free moves, he can move so as to leave just  $n$  free moves, while Right cannot move at all. The very simplest equation of this type is

$$\{|\} = 0$$

which expresses the fact that if neither player has a legal move the game has zero value.



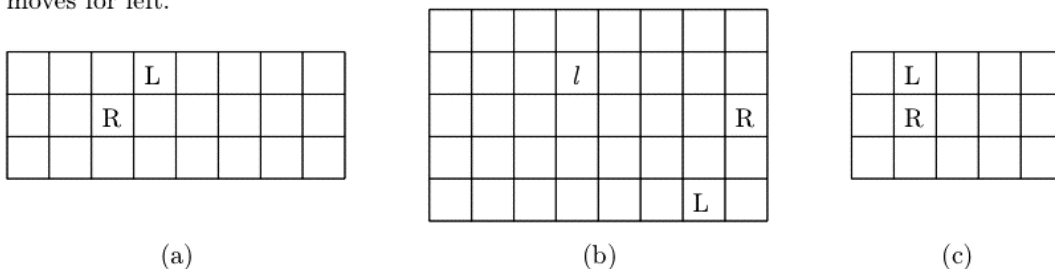
**Figure 10.** A Game of Ski-Jumps.



## Ski-Jumps for Beginners

Figure 10 shows a ski-slope with some skiers in the pay of Left and Right, about to participate in our next game. In a single move, Left may move any skier a square or more Eastwards, or Right any one of his, Westwards, provided there is no other active skier in the way. Such a move may take the skier off the slope; in this case he takes no further part in the game. No two skiers may occupy the same square of the slope. Alternatively a skier on the square immediately *above* one containing a skier of the opposing team, may jump over him onto the square immediately below, provided this is empty. A man jumped over is so humiliated that he will never jump over anyone else—in fact he is demoted from being a *juniper* to an ordinary skier, or *slipper*!

No other kind of move is permitted in this game, so that when all the skiers belonging to one of the players have left the ski-slope, that player cannot move, and a player who cannot move when it is his turn to do so, loses the game. Let's examine some simple positions. Figure 11(a) shows a case when Left's only juniper is already east of Right's, so that no jump is possible. Since Left's man can move 5 times and Right's only 3, the value is  $5 - 3 = 2$  spare moves for left.



**Figure 11.** Some Ski-Jumps Positions.

We can similarly evaluate any other position in which no further jumps are possible. Thus in Fig. 11(b) Left has one man on the row above Right's, and another lower down, but still no jump will be possible, for Left's upper man has been demoted to a mere slipper (hence his lower case name, *l*), while his lower man, being two rows below Right's, is not threatened. Left's two men have collectively  $2 + 5$  moves to Right's 8, so the value is

$$2 + 5 - 8 = -1$$

moves to Left, that is, 1 move in favor of Right.

Now let's look at Fig. 11(c), in which Left's man may jump over Right's, if he wishes. If he does so, the value will be  $4 - 2 = 2$ , which is better than the value  $3 - 2 = 1$  he reaches by sliding one place East. If, on the other hand, Right has the move, it will be to a position of value  $4 - 1 = 3$ . So the position has value

$$\{2|3\} = 2\frac{1}{2}$$

moves to Left. More generally, if Left has a single man on the board, with  $a$  spaces (and hence  $a + 1$  moves) before him, and Right a single man with  $b$  spaces before *him*, and one of the two



men is now in a position to jump over the other, the value will be

$$a - b + \frac{1}{2} \text{ or } a - b - \frac{1}{2}$$

according as it is Left's or Right's man who has the jump. We can think of an imminent jump as being worth half a move to the player who can make it.

Figure 12 shows all the positions on a  $3 \times 5$  board in which there are just two men, of which Left's might possibly jump Right's either at his first move or later.

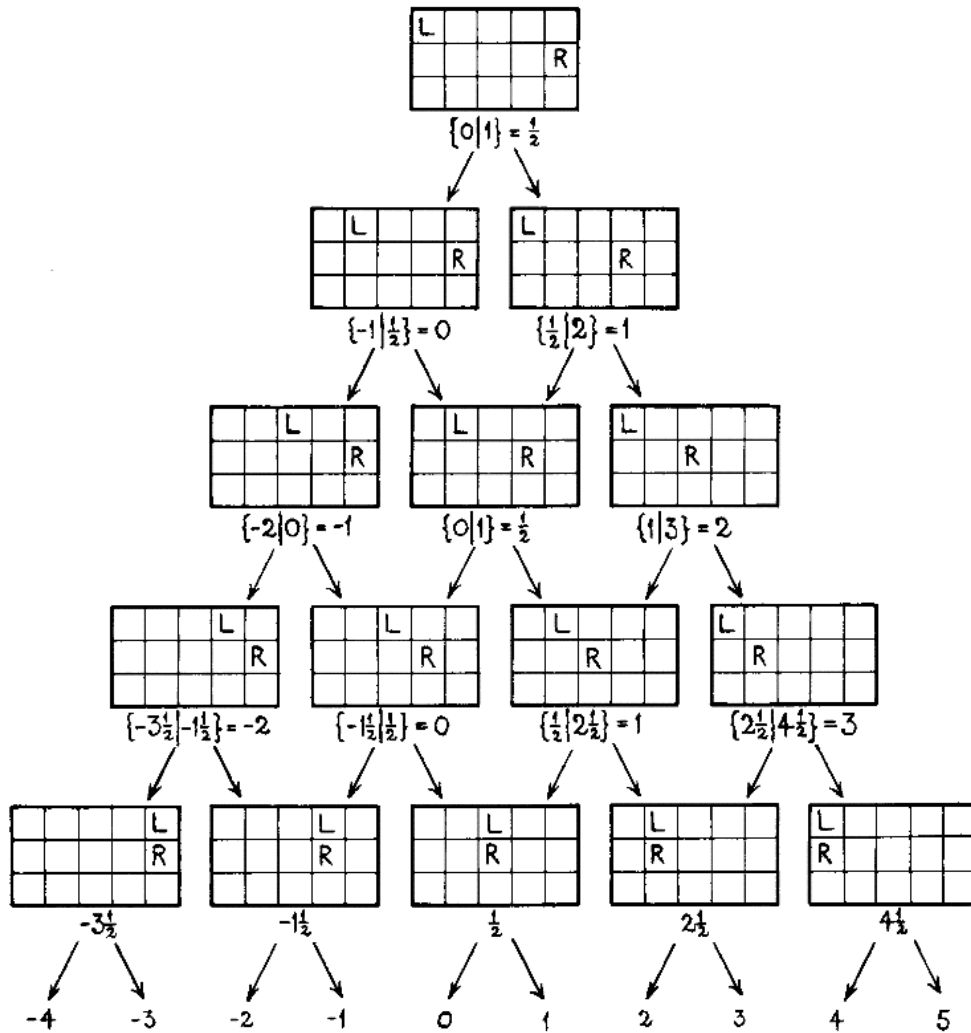


Figure 12. Ski-Jumps Positions on a  $3 \times 5$  Board.



## Don't Just Take the Average!

The positions in the bottom two lines are those we have just analyzed, in which the jump is imminent or past. From any of the other positions, Left has just one move, to the position diagonally down and left from the given one, and Right similarly has a unique move, to the position diagonally rightwards. We have appended the values of all these positions, measured as usual in terms of free moves for Left, and there are some surprises. We have evaluated the rightmost position on the fourth row as

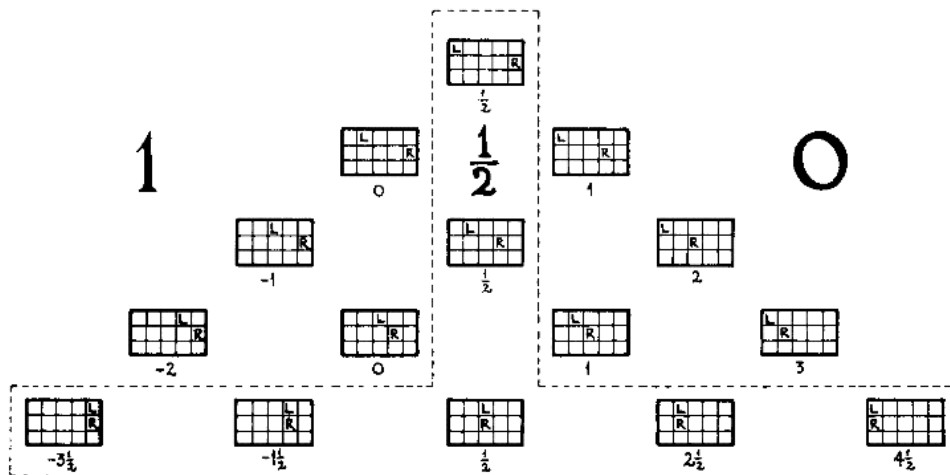
$$\{2\frac{1}{2}|4\frac{1}{2}\} = 3.$$

Surely this is wrong? Anyone can see that the average of  $2\frac{1}{2}$  and  $4\frac{1}{2}$  is  $3\frac{1}{2}$ , can't they?

Well yes, of course  $3\frac{1}{2}$  is the *average*, but it turns out that the *value* is 3, nevertheless. You *don't* simply evaluate positions in games by averaging Left's and Right's best moves! Exactly how you *do* evaluate them is the main topic of this book, so we can't reveal it all at once. But we *will* explain why the second position on the fourth row has value 0, rather than  $-\frac{1}{2}$ , as might have been expected.

If the value were  $-\frac{1}{2}$  or any other negative number, Right ought to win, no matter who starts. But in this position, if Right starts, Left can jump him immediately, after which they will have just three moves, and Right will exhaust his before Left. In fact neither player can win this position if he starts, for if Left moves first, Right can slip leftwards past him to avoid the threatened jump, leaving Left with but two moves to Right's three. A position in which the first player to move loses *always* has value zero.

We could have seen the same thing from the symbolic expression  $\{-1\frac{1}{2}|\frac{1}{2}\}$  for the position, for since Left's best option has negative value he cannot move to it and win (if Right plays well), and since Right's best move is positive, he cannot move to win either. It does not matter



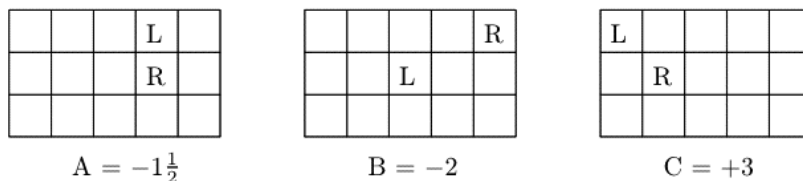
**Figure 13.** The value of a Potential Jump is 1,  $\frac{1}{2}$  or 0.

exactly *how much* each of these moves favors the second player, so long as he is assured of a win. So for exactly the same reason, the game  $\{-\frac{1}{2}|17\} = 0$ , since the starter loses, even though 17 is much further above 0 than  $-\frac{1}{2}$  is below it.

### What Is a Jump Worth?

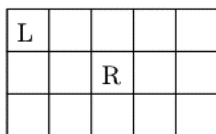
We do not explain the other values here. The reader can verify for example, that  $\{2\frac{1}{2}|4\frac{1}{2}\} = 3$ , by playing the position  $\{2\frac{1}{2}|4\frac{1}{2}\}$  together with an allowance of just 3 moves for Right, and checking that the starter loses. We can summarize the results of Fig. 12 as follows: a potential jump is worth half a move only if it is either imminent or the two players are the same distance from the central column. It is worth a whole move (just as if it were a sure thing) if the potential jumper is nearer to the central column than the jumpee and worth nothing (just as if it were impossible) otherwise (Fig. 13).

We can now predict who will win the more complicated Ski-Jumps position of Fig. 10. Because the pairs of rows A,B,C are so far apart, moves made by the skiers in one of these pairs will not affect the play in others, so we can just add up the values for the three pairs A,B,C (Fig. 14).



**Figure 14.** Values of Ski-Jumps Positions in Figure 10.

The values for A and C can be read off from Fig. 12 as  $-1\frac{1}{2}$  and +3, while that for B is



(value 2) with the roles of Left and Right reversed, and so has value -2.

The total value is therefore

$$-1\frac{1}{2} - 2 + 3 = -\frac{1}{2},$$

and so Right is half a move ahead and should be able to win, no matter who starts. It will be harder for him if he starts himself, since then he must use up a move. What move should he make? His three choices are from

$$-1\frac{1}{2} \text{ to } -1 \text{ (in A), } \quad -2 \text{ to } -1 \text{ (in B), } \quad \text{and } 3 \text{ to } 4\frac{1}{2} \text{ (in C)}$$

which lose him

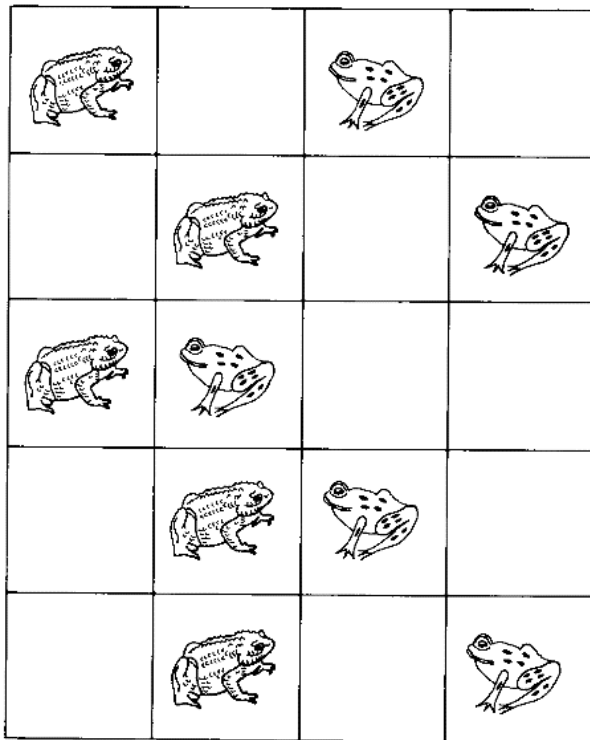
$$\frac{1}{2}, \qquad 1, \qquad 1\frac{1}{2}$$

moves respectively. So he can only guarantee to retain his win if he moves his A man, so as to avoid the otherwise imminent jump by Left.



## Toads-and-Frogs

Left has trained a number of Toads (*Bufo vulgaris*) and Right a number of Frogs (*Rana pipiens*) to play the following game. Each player may persuade one of his creatures either to move one square or to jump over an opposing creature, onto an empty square. Toads move only Eastward, Frogs only to the West (*toads to, frogs fro*). The game is to be played according to the normal play rule that a player unable to move loses. Verify the values in Fig. 16. Who wins Fig. 15 and by how much?



**Figure 15.** A Game of Toads-and-Frogs.

## Do Our Methods Work?

Several questions will have entered the reader's mind. Can we really evaluate positions by adding up numbers of moves advantage, even when they are fractions? Is it wise to regard all positions in which the starter loses as having zero value? The answers are yes. For the pragmatic reader perhaps the best proof of this pudding is in the eating—if he works out who has more moves advantage this way he'll be sure to pick the winner. Mathematical unbelievers must await our later discussion.

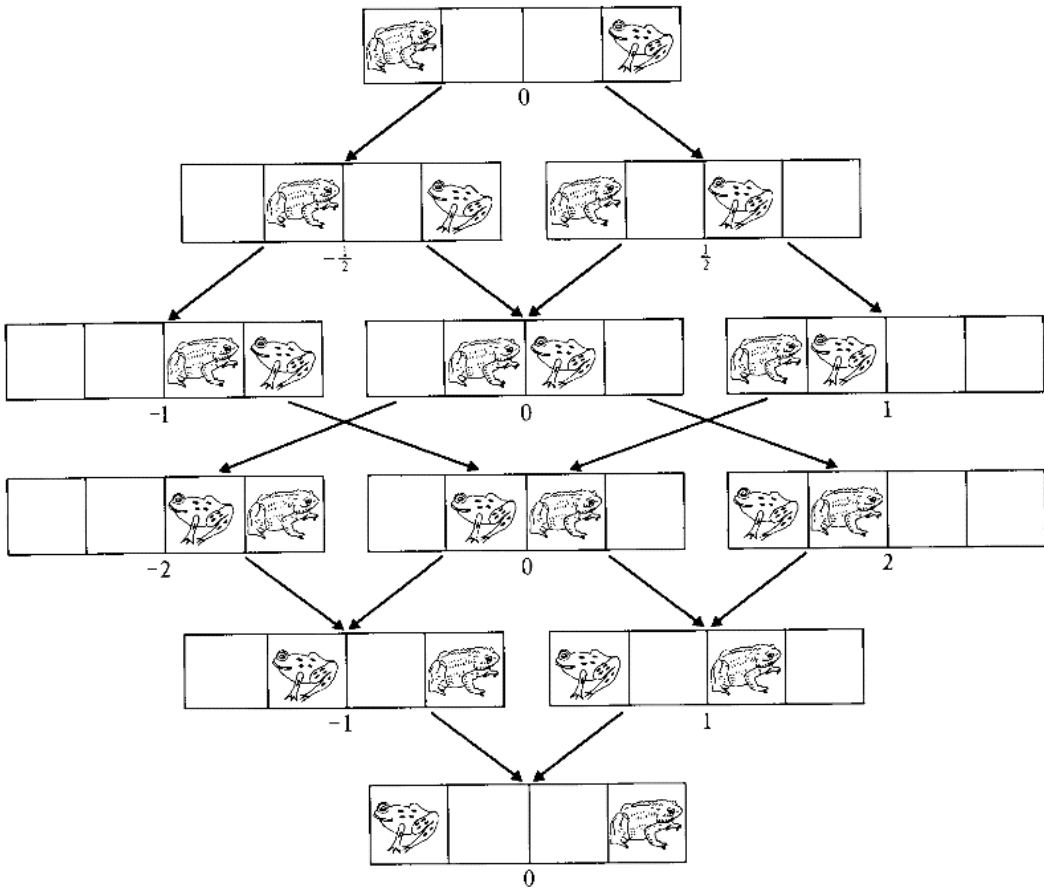


Figure 16. Values of Positions in 4-place Toad-and-Frog.

# Extras

Under this heading we shall occasionally insert additional detail and examples which will interest some readers, but might interrupt the general flow of ideas for others.

## What is a Game?

Our games of Hackenbush and Ski-Jumps are typical of many discussed in the first volume of *Winning Ways* in that:

1. There are just two players, often called Left and Right.
2. There are several, usually finitely many, **positions**, and often a particular **starting position**.
3. There are clearly defined **rules** that specify the **moves** that either player can make from a given position to its **options**.
4. Left and Right move alternately, in the game as a whole.
5. Both players know what is going on, i.e. there is **complete information**.
6. There are no **chance moves** such as rolling dice or shuffling cards.
7. In the **normal play** convention a player unable to move **loses**.
8. The rules are such that play will always come to an end because some player will be unable to move. This is called the **ending condition**. So there are no games which are drawn by repetition of moves.

The reader should see how far his own favorite games satisfy these conditions. He will also see from some of the comments below that many games not satisfying all the conditions are also treated later in this book. But all the games we *do* treat satisfy 5 and 6.

**Tic-Tac-Toe (Noughts-and-Crosses)** fails 7. because a player unable to move is not necessarily the loser, since ties are possible. We will give a complete analysis in Chapter 22, and will discuss various generalizations, such as **Go-Moku**.

**Chess** also fails 7. and contains positions that are *tied* by stalemate (in which the last player does *not* win) and positions that are *drawn* by infinite play (of which perpetual check is a special case). However, Noam Elkies has applied our methods to some positions near the end of the game.

The words “tied” and “drawn” are often used interchangeably, though with slight transatlantic differences, for games which are neither won nor lost. We suggest that **drawn** be used for cases when this happens because play is drawn out indefinitely and **tied** for cases when play definitely ends but the rules do not award a win to either player.

**Ludo**, **Snakes-and-Ladders**, and **Backgammon** all have complete information, but contain chance moves, since they all use dice.

**Battleships, Kriegspiel, Three-Finger Morra, and Scissors-Paper-Stone** have no chance moves but the players do not have complete information about the disposition of their opponent's pieces or fingers. In both the finger games, moreover, the players move simultaneously rather than alternately.

**Monopoly** fails on several counts. Like Ludo, it has chance moves and may have more than two players. The players don't have complete information about the arrangement of the cards and the game could, theoretically, go on for ever.

**Solitaire (Patience)** played with cards and **Peg Solitaire** (Chapter 23) are one-person games and in the first the arrangement of the cards is determined by chance.

The game of **Life** which we discuss in Chapter 25, is a no-player, never-ending game!

In **Poker** much of the interest arises from the incompleteness of the information, the chance moves and the possibility of **coalitions** which arises in games with three or more players.

**Bridge** is peculiar in that it has two players, each a team of two persons, and a "player" does not even have complete information about "his" own cards.

**Tennis, Hockey, Baseball, Cricket, Lacrosse, and Basketball** are also "two-person" games, but there are difficulties in the definitions of appropriate "positions" and "moves".

**Nim** (Chapter 2), **Wythoff's Game** (Chapter 3), and **Grundy's Game** (Chapter 4) satisfy all our conditions and indeed a further one, that from any position exactly the same moves are available to either player. Such games are called **impartial**. Games in which the two players may have different options we shall call **partizan**. Blue-Red Hackenbush is partizan because Left may only remove blue edges and Right only red ones; Ski-Jumps because different players control different skiers.

**Dots-and-Boxes** is usually won by the player scoring the larger number of boxes, so that it does not satisfy the normal play convention. However, we shall see in Chapter 16 that in practice it can almost always be treated as an impartial game, satisfying our normal play convention, part of whose theory is closely related to **Kayles** and **Dawson's Kayles** (see Chapter 4).

**Sylver Coinage**, which we discuss in Chapter 18, is an impartial game which violates the normal play convention because the last player to move is the *loser*. In Chapter 13 we show you how to play sums of impartial games subject to this **misère play** convention.

**Fox-and-Geese** is a pursuit game which doesn't satisfy the ending condition, but in Chapter 20 we are able to compare its value with those of other partizan games which *do* satisfy the condition. It is a loopy game in the sense of Chapter 11.

**The French Military Hunt** and other partizan pursuit games also yield to analysis in Chapter 21.

The basic techniques that we originally presented in this book have been extended to give insights into a much broader range of games than even we were able to imagine in 1982.

**Amazons** is a game in which each player controls several immortal chess queens. At each turn, you move any one of your queens, and after making her move this queen must shoot a flaming arrow, which also moves like a chess queen. The square on which the arrow lands is then burned from the board. Neither Amazons nor arrows can jump over each other or over burned squares. The game ends if a player is unable to move, and that player then loses.



Players of Amazons have maintained a regular ratings system and have competed in tournaments on the Internet since about 1990. The conventional version of Amazons is played on a 10x10 board. Each player has four Amazons, which start in a specified position.

**Konane** is a competitive form of peg solitaire which was popular in ancient Hawaii. It is played with black and white Go stones on the **squares** of a rectangular Go board. 12x12 and 18x18 are common sizes. Initially, the entire board is filled with stones in checkerboard fashion, black and white occupying alternate diagonals. Then two adjacent stones are removed from the center of the board, and the game begins. At each turn, a player jumps an opposing stone and removes it from the board. The game ends when someone is unable to move. In the original version of the game, multiple jumps in a straight line are legal, but multiple jumps which turn corners are not.

**Go** is a classical Asian board game which originated in China a few thousand years ago. It now supports about 2,000 professionally ranked players and literally millions of amateurs in Japan, China, Korea, Taiwan, Singapore, and many more thousands elsewhere in the world. Two players called “Black” and “White” take turns placing a stone of his color on an intersection of a 19x19 board. Groups of opposing stones may be captured and removed under certain conditions, but the primary objective is to surround territory. Although the basic rules are conceptually simple, the fine print is sufficiently complicated that there are, in fact, more than a half-dozen “dialects” of Go rules in use in different parts of the world today. Fortunately, the fine print is relevant only in arcane situations which very rarely occur.

To extend the techniques of *Winning Ways* to Go has been a major preoccupation of Berlekamp and his colleagues for the past 18 years. Fundamental challenges include the intricacies of the various dialects of scoring rules, and of a wide variety of loopy positions known as kos and superkos, which are the subject of yet more dialectical rule variations. More practical challenges arise from the richness of the game. All of these challenges have been addressed, with considerable success, in a sequence of publications that is destined to continue for several more years.

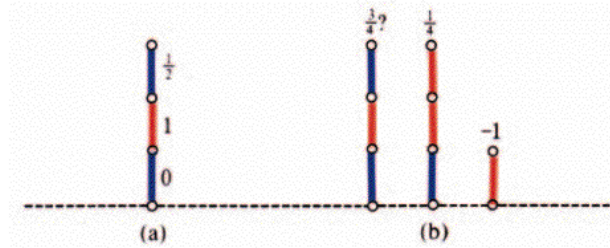
## When Is a Move Good?

We usually call a move “good” if it will win for you, and “bad” if it will not, and throughout most of the book we will regard it as sufficient analysis to find any good move, or show that none exists.

But in real life games there are many other criteria for choosing between your various options. If you’re *losing*, then all your options are bad in the above sense, but in practice they’re not all equal, and you might prefer one that makes the situation too complicated for your opponent to analyze (the **Enough Rope Principle**).

There are even cases where you should prefer a bad move to a good one! Your opponent might be learning how to play a game which you’re already familiar with. In this case you’ll probably be able to win a few times despite the bad moves you deliberately make so as not to give your strategy away. Or one move, though theoretically the best, might gain you only a dollar, while another, which theoretically *loses* a dollar, might actually get you a hundred if your opponent fails to find the rather subtle winning reply. And of course you might be a card sharp who’s playing badly now so as to win more later when the stakes are raised.



Figure 8(d) Is Worth  $\frac{3}{4}$ 

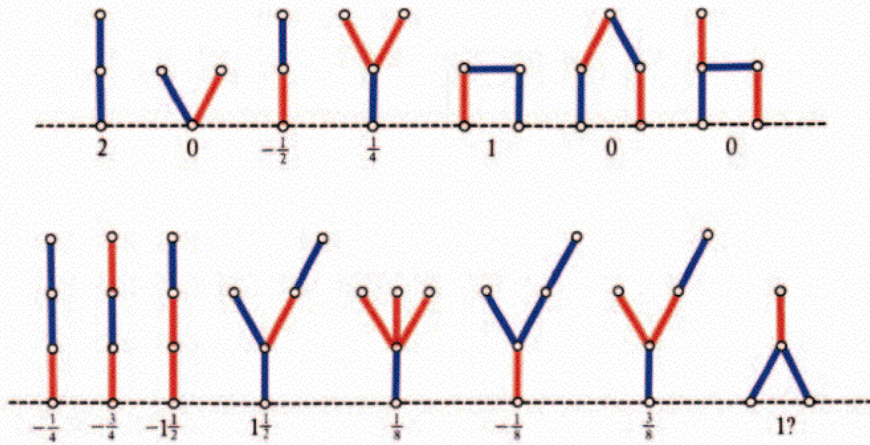
**Figure 17.** How we can have Three-Quarters of a Move.

The Blue-Red Hackenbush position of Fig. 8(d) may be evaluated as follows. Write against each edge (Fig. 17(a)) the value of the position when that edge is removed. Then the greatest number against a blue edge (here  $\frac{1}{2}$ ) is Left's best option and the least number against a red edge is Right's. So in the given case we obtain the expression

$$\{\frac{1}{2}|1\}$$

suggesting a value of  $\frac{3}{4}$ . So if we add  $\frac{1}{4}$  and subtract 1 as in Fig. 17(b) we should obtain a zero position. Check that whoever starts loses.

Verify that the Blue-Red Hackenbush positions in Fig. 18 have the indicated values, in terms of moves advantage to Left.



**Figure 18.** Values of some Blue-Red Hackenbush Positions.



## References and Further Reading

- John D. Beasley, *The Mathematics of Games*, Oxford University Press, 1990.
- E. Berlekamp, Two-person, perfect-information games, in: *The Legacy of John von Neumann* (Hempstead NY, 1988), *Proc. Sympos. Pure Math.*, **50**(1990), Amer. Math. Soc., Providence, RI, pp. 275–287.
- Elwyn Berlekamp, Introductory overview of mathematical Go endgames, in R. K. Guy (ed.), *Combinatorial Games, Proc. Symp. Appl. Math.*, **43**(1991), Amer. Math. Soc., Providence RI, pp. 73–100.
- Elwyn Berlekamp, The economist's view of combinatorial games, in Richard Nowakowski (ed.) *Games of No Chance*, Cambridge University Press, 1996, pp. 365–405.
- Elwyn Berlekamp & Yonghoan Kim, Where is the "Thousand-Dollar Ko"?, in Richard Nowakowski (ed.) *Games of No Chance*, Cambridge University Press, 1996; see also *Go World*, **71**(1994) 65–80.
- Elwyn Berlekamp & David Wolfe, *Mathematical Go: Chilling Gets the Last Point*, A K Peters, Ltd., 1994; also published as *Mathematical Go Endgames; Nightmares for the Professional Go Player*, Ishi Press International.
- J. H. Conway, *On Numbers and Games*, Second Edition, A K Peters, Ltd., 2001.
- J. H. Conway, All games bright and beautiful, *Amer. Math. Monthly*, **84**(1977) 417–434.
- J. H. Conway, A gamut of game theories, *Math. Mag.*, **51**(1978) 5–12.
- Noam Elkies, On numbers and endgames: combinatorial game theory in chess endgames, in Richard Nowakowski (ed.) *Games of No Chance*, Cambridge University Press, 1996, pp. 135–150.
- A. S. Fraenkel, From Nim to Go, *Ann. Discrete Math.*, **6**(1980) 137–156, Proc. Symp. on Combinatorial Mathematics, Combinatorial Designs and Their Applications (J. Srivastava, ed.), Colorado State Univ., Fort Collins, CO, June 1978.
- Martin Gardner, Mathematical Games, *Sci. Amer.*, each issue, 1957–1981.
- Richard K. Guy, What is a game?, in Richard Nowakowski (ed.) *Games of No Chance*, Cambridge University Press, 1996, pp. 43–60; see also *Combinatorial Games, Proc. Symp. Appl. Math.*, **43**(1991), Amer. Math. Soc., Providence RI, pp. 1–21.
- Donald Knuth, *Surreal Numbers*, Addison-Wesley, Reading MA, 1974.
- H. A. Landman, Eyespace values in Go, in Richard Nowakowski (ed.) *Games of No Chance*, Cambridge University Press, 1996, pp. 227–257.
- M. Müller & R. Gasser, Experiments in computer Go endgames, in Richard Nowakowski (ed.) *Games of No Chance*, Cambridge University Press, 1996, pp. 273–284.
- Jonathan Schaeffer & Robert Lake, Solving the game of checkers, in Richard Nowakowski (ed.) *Games of No Chance*, Cambridge University Press, 1996, pp. 119–134.

# -2-

## Finding the Correct Number is Simplicity Itself

Simplicity, simplicity, simplicity. I say let your affairs be  
as two or three, and not a hundred or a thousand; instead of a million  
count half a dozen and keep your accounts on your thumbnail.

Henry David Thoreau, *Walden*.

And calculate the stars.

John Milton, *Paradise Lost*, VIII, 80.

We have seen that positions in Hackenbush and Ski-Jumps are often composed of several non-interacting parts, and that then the proper thing to do is to add up the values of these parts, measured in terms of free moves for Left. We have also seen that halves and quarters of moves can arise. So plainly we'll have to decide exactly what it means to add games together, and work out how to compute their values.

### Which Numbers Are Which?

Let's summarize what we already know, using the notation

$$\{a, b, c, \dots \mid d, e, f, \dots\}$$

for a position in which the options for Left are to positions of values  $a, b, c, \dots$  and those for Right to positions of values  $d, e, f, \dots$ . In this notation, the whole numbers are

$$0 = \{ \mid \}, \quad 1 = \{0 \mid \}, \quad 2 = \{1 \mid \}, \quad \dots, \quad n + 1 = \{n \mid \},$$

for from a zero position, neither player has a move, and from a position with  $n + 1$  free moves for Left, he can move so as to leave himself just  $n$  moves, whereas Right cannot move at all.

The negative integers are similarly

$$-1 = \{ \mid 0 \}, \quad -2 = \{ \mid -1 \}, \quad -3 = \{ \mid -2 \}, \quad \dots, \quad -(n + 1) = \{ \mid -n \}.$$

We also found values involving halves:

$$\frac{1}{2} = \{0 \mid 1\}, \quad 1\frac{1}{2} = \{1 \mid 2\}, \quad 2\frac{1}{2} = \{2 \mid 3\}, \quad \dots,$$

$$-\frac{1}{2} = \{-1 \mid 0\}, \quad -1\frac{1}{2} = \{-2 \mid -1\}, \quad \dots, \quad \text{and so on.}$$

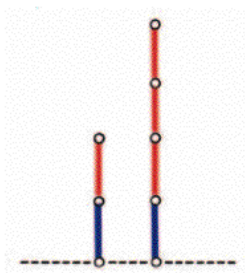
Our proof that  $\{0 \mid 1\}$  behaves like half a move was contained in the discussion of the Hackenbush position of Fig. 6(a) in Chapter 1.

We also discussed a Hackenbush position (Fig. 8(a) of Chapter 1) whose value was  $\{0 \mid \frac{1}{2}\}$  and showed that it behaved like one quarter of a move. So we can guess that we have all the equations

$$\{0 \mid 1\} = \frac{1}{2}, \quad \{0 \mid \frac{1}{2}\} = \frac{1}{4}, \quad \{0 \mid \frac{1}{4}\} = \frac{1}{8}, \quad \text{and so on,}$$

and leave a more precise discussion of what these equations mean until later.

Will there be any game with a position of value  $\frac{5}{8}$ ? Yes, of course! All we have to do is add together two positions of values  $\frac{1}{2}$  and  $\frac{1}{8}$  as in the Hackenbush position of Fig. 1.



**Figure 1.** A Blue-Red Hackenbush Position Worth Five-Eighths of a Move.

What are the moves from the position  $\frac{1}{2} + \frac{1}{8}$ , that is from the position

$$\frac{1}{2} + \frac{1}{8}$$

which we write

$$\{0 \mid 1\} + \{0 \mid \frac{1}{4}\}$$

in the new notation?

Each player can move in either the first or the second component, but must then leave the other component untouched, so Left's options are the positions

$$0 + \frac{1}{8} \quad (\text{if he moves in the first}), \quad \text{and}$$

$$\frac{1}{2} + 0 \quad (\text{if he moves in the second}).$$

He should obviously prefer the latter, which leaves a total value of half a move, rather than one-eighth of a move, to him. Right's moves are similarly

$$1 + \frac{1}{8} \quad \text{and} \quad \frac{1}{2} + \frac{1}{4}$$

of which he should prefer the second, since it leaves Left only three-quarters of a move, rather than one-and-one-eighth. We have shown that the best moves from  $\frac{5}{8}$  are to  $\frac{1}{2}$  (Left) and  $\frac{3}{4}$  (Right), or in our abbreviated notation, we have demonstrated the equation

$$\frac{5}{8} = \left\{ \frac{1}{2} \mid \frac{3}{4} \right\}.$$

In a precisely similar way, we can add various fractions  $1/2^k$  so as to prove that

$$\frac{2p+1}{2^{n+1}} = \left\{ \frac{2p}{2^{n+1}} \mid \frac{2p+2}{2^{n+1}} \right\} = \left\{ \frac{p}{2^n} \mid \frac{p+1}{2^n} \right\}.$$

or in words, that each fraction with denominator a power of two has as its Left and Right options the two fractions nearest to it on the left and right that have smaller denominator which is again a power of two. For example

$$3 \frac{57}{128} = \{3 \frac{56}{128} \mid 3 \frac{58}{128}\} = \{3 \frac{7}{16} \mid 3 \frac{29}{64}\}.$$

### Simplicity's the Answer!

The equations we've just discussed are the easy ones. What number is the game  $X = \{1\frac{1}{4} \mid 2\}$ ? We have already seen in our discussion of Ski-Jumps that we should not necessarily expect the answer to be the mean of  $1\frac{1}{4}$  and 2, that is,  $1\frac{5}{8}$ . Why not? We can test this question by playing the sum

$$X + (-1\frac{5}{8}) = \{1\frac{1}{4} \mid 2\} + \{-1\frac{3}{4} \mid -1\frac{1}{2}\}$$

since we already know that  $-1\frac{5}{8} = \{-1\frac{3}{4} \mid -1\frac{1}{2}\}$ . Only if neither player has a winning move in this sum will we have  $X = 1\frac{5}{8}$ .

The two moves from the component  $X$  are certainly losing ones, because  $1\frac{5}{8}$  is strictly between  $1\frac{1}{4}$  and 2, so that Left's move leaves the total value  $1\frac{1}{4} - 1\frac{5}{8}$  which is negative, while Right's leaves it  $2 - 1\frac{5}{8}$  which is positive. But Right nevertheless has a good move, namely that from  $-1\frac{5}{8}$  to  $-1\frac{1}{2}$ . Why is this?

The answer is that in the new game

$$X + (-1\frac{1}{2}) = \{1\frac{1}{4} \mid 2\} + \{-2 \mid -1\}$$

it is still true that neither player will want to move in the component  $X$ , for essentially the same reason as before, since  $1\frac{1}{2}$  still lies strictly between  $1\frac{1}{4}$  and 2. So Left's only hope for a reply is to replace  $-1\frac{1}{2}$  by  $-2$  which Right can neatly counter by moving from  $X$  to 2, leaving a zero position.

So the reason that  $\{1\frac{1}{4} \mid 2\}$  is *not*  $1\frac{5}{8}$  is that  $1\frac{5}{8}$  is not the *simplest* number strictly between  $1\frac{1}{4}$  and 2, because it has the Left option  $1\frac{1}{2}$  with the same property, and we therefore find ourselves needing to discuss  $X + (-1\frac{1}{2})$  before we can evaluate  $X + (-1\frac{5}{8})$ .

Now  $1\frac{1}{2}$  must be the simplest number between  $1\frac{1}{4}$  and 2, because the immediately simpler numbers are its options 1 and 2, which don't fit. We shall use this to prove that in fact  $X = 1\frac{1}{2}$ .

It is still true for the position

$$X + (-1\frac{1}{2}) = \{1\frac{1}{4} \mid 2\} + \{-2 \mid -1\}$$

that neither player has a good move from the component  $X$ , so that we need only consider their moves from  $-1\frac{1}{2}$ . After Right's move the total is  $X + (-1)$ , to which Left can reply by moving from the component  $X$  so as to leave the positive total  $1\frac{1}{4} - 1$ , because 1 is not *strictly between*  $1\frac{1}{4}$  and 2, but *less than*  $1\frac{1}{4}$ . After Left's move from  $-1\frac{1}{2}$ , the total is  $X + (-2)$  and



Right's response is to the zero position  $2 - 2$ , because 2 is no longer *strictly between*  $1\frac{1}{4}$  and 2, but this time *equal to* 2.

The argument can be used in general to prove the **Simplicity Rule**, which we shall use over and over again:

If there's *any* number that fits,  
the answer's the *simplest* number that fits.

### THE SIMPLICITY RULE

If the options in

$$\{a, b, c, \dots \mid d, e, f, \dots\}$$

are all numbers, we'll say that the number  $x$  **fits** just if it's

strictly greater than each of  $a, b, c, \dots$ , and  
strictly less than each of  $d, e, f, \dots$ ,

and  $x$  will be the **simplest** number that fits, if none of its options fit. For the options of  $x$  you should use the particular ones we found in the previous section.

For example, if the best Left move from some game  $G$  is to a position of value  $2\frac{3}{8}$ , and the best Right move to one of value 5, we can show that  $G$  itself must have value 3, which we found before in the form  $\{2 \mid \}$ , for in this form 3 has only one option, 2, which does *not* lie strictly between  $2\frac{3}{8}$  and 5, while 3 *does*. Note that the Simplicity Rule still works when one of the players, here Right, has no move from the number  $c$ . It also works for games of the form  $\{a \mid \}$  or  $\{ \mid b\}$  in which again one of the players is deprived of a move. For example,  $\{a \mid \}$  is a number  $c$  which is greater than  $a$ , but has no option with this property. This is in fact the smallest whole number 0 or 1 or 2 or  $\dots$  which is greater than  $a$ . Thus  $\{2\frac{1}{2} \mid \} = 3$ ,  $\{-2\frac{1}{2} \mid \} = 0$ .

## Simplest Forms for Numbers

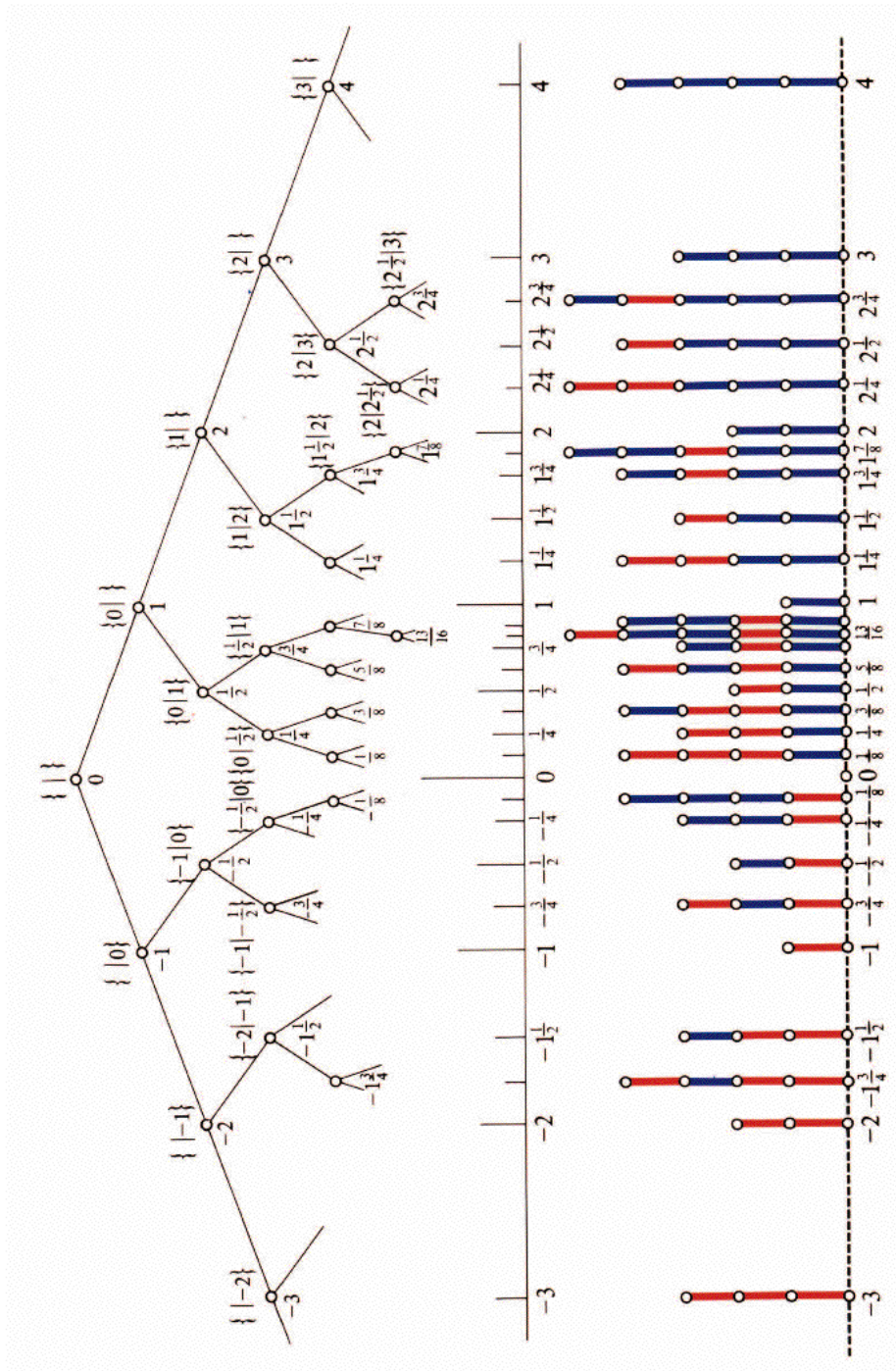
Figure 2 displays most of what we've learnt so far. The central ruler is the ordinary real number line with bigger marks for simpler numbers, while below it are the corresponding Hackenbush strings; the simpler the number the shorter the string.

The binary tree of numbers appears upside-down above the ruler, although we can't draw all of it on our finite page with finite type—for more details see ONAG<sup>1</sup>, pp. 3–14. Each fork of the tree is a number whose best options are the nearest numbers left and right of it that are higher up the tree. For example 1 and 2 are the best options for  $1\frac{1}{2}$ . For  $\frac{13}{16}$  we find  $\frac{3}{4}$  and  $\frac{7}{8}$ , so

$$\frac{13}{16} = \left\{ \frac{3}{4} \mid \frac{7}{8} \right\}$$

as a game. (The numbers on the leftmost branch have no Left options and those on the rightmost branch no Right ones.)

<sup>1</sup>Throughout the book, ONAG refers to J.H. Conway, "On Numbers and Games", 2nd edition, A K Peters, 2001



**Figure 2.** Australian Number Tree, the Real Number Line, and Hackenbush Strings.



The options of a number that we find in this way define its canonical or **simplest form**. Here are the rules for simplest forms:

$$\begin{array}{l}
 0 = \{ \mid \} \\
 n + 1 = \{ n \mid \} \\
 -n - 1 = \{ \mid -n \} \\
 \frac{2p + 1}{2^{q+1}} = \left\{ \frac{p}{2^q} \mid \frac{p + 1}{2^q} \right\}
 \end{array}$$

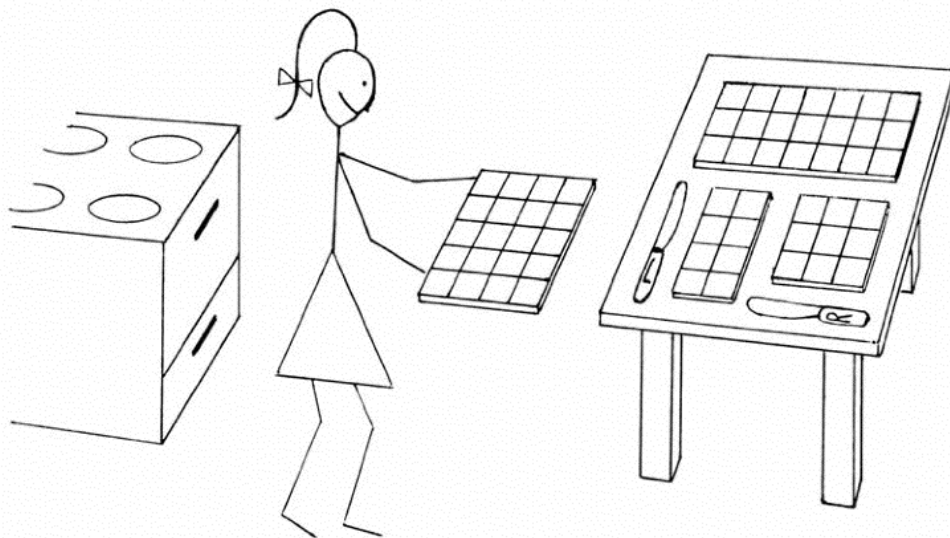
#### SIMPLEST FORMS FOR NUMBERS

e.g.  $79 = \{78 \mid \}$ ,  $-53 = \{ \mid -52 \}$ , and  $\frac{47}{64} = \{ \frac{23}{32} \mid \frac{24}{32} \} = \{ \frac{23}{32} \mid \frac{3}{8} \}$ .

The simpler the number, the nearer it is to the root (top!) of the tree.

### Cutcake

Mother has just made the oatmeal cookies shown in Fig. 3. She hasn't yet broken them up into little squares, although she has scored them along the lines indicated. Rita and her brother Lefty decide to play a game breaking them up. Left will cut any rectangle into two smaller ones along one of the North-South lines, and Rita will cut some rectangle along an East-West line. When one of the children is unable to move, the game ends and that child is the loser.



**Figure 3.** Ready for a Game of Cutcake.



We'll evaluate the positions in this game using the Simplicity Rule. Plainly a single square  $\square$  leaves no legal move for either player, and so is a zero position. The  $1 \times 2$  rectangle  $\square\square$  gives just a single free move for Lefty, the  $1 \times 3$  rectangle  $\square\square\square$  two free moves for him, and so on. When these rectangles are turned through a right angle, they yield the corresponding numbers of free moves for Rita instead.

The  $2 \times 2$  square is the zero position  $\{-2 \mid 2\}$ , for when Lefty starts, he leaves two moves for Rita, and if she starts, she must leave two moves for him. So let's consider the  $2 \times 3$  rectangle  $\begin{array}{|c|c|c|} \hline \square & \square & \square \\ \hline \square & \square & \square \\ \hline \end{array}$ . Since this has more vertical lines than horizontal ones, it should perhaps be a win

for Lefty? No! If he starts he must leave a  $2 \times 1$  rectangle, which is one move in favor of Rita, together with a  $2 \times 2$  square, which we can ignore as having value zero. But Rita can't win either, for her only opening move gives Left four free moves. So the  $2 \times 3$  rectangle is the zero position  $\{-1 \mid 4\}$ . But the  $2 \times 4$  rectangle  $\begin{array}{|c|c|c|c|} \hline \square & \square & \square & \square \\ \hline \square & \square & \square & \square \\ \hline \end{array}$  is long enough to favor Lefty, for if

he chops it into two  $2 \times 2$  squares at his first move, he wins, and he plainly wins if Rita is made to start. In fact we have

$$\begin{aligned} \begin{array}{|c|c|c|c|} \hline \square & \square & \square & \square \\ \hline \square & \square & \square & \square \\ \hline \end{array} &= \left( \begin{array}{|c|} \hline \square \\ \hline \end{array} + \begin{array}{|c|c|c|} \hline \square & \square & \square \\ \hline \square & \square & \square \\ \hline \end{array}, \begin{array}{|c|c|} \hline \square & \square \\ \hline \square & \square \\ \hline \end{array} + \begin{array}{|c|c|} \hline \square & \square \\ \hline \square & \square \\ \hline \end{array} \left| \begin{array}{|c|c|c|c|} \hline \square & \square & \square & \square \\ \hline \square & \square & \square & \square \\ \hline \square & \square & \square & \square \\ \hline \square & \square & \square & \square \\ \hline \end{array} \right. \right) \\ &= \{-1 + 0, \quad 0 + 0 \mid 3 + 3\} \\ &= \{-1, 0 \mid 6\}, \end{aligned}$$

which the Simplicity Rule tells us is worth one move for Lefty.

Using arguments like these, we can draw up a table (Table 1) showing the values of the rectangles of various sizes in Cutcake. We see that there is an interesting pattern—the border of the table is divided into  $1 \times 1$  squares each holding a different integer, corresponding to the values of strips of width 1. But then there's a second border of  $2 \times 2$  squares which is a bit harder to explain.

Thus all the four rectangles of breadth 2 or 3 and depth 4 or 5 have the same value,  $-1$ , meaning that they count as one free move for Rita. (We already saw that the  $2 \times 2$  and  $2 \times 3$  rectangles had the same value, namely 0.) Then the table continues with a border of  $4 \times 4$  squares, followed by a fourth of  $8 \times 8$  squares, and so on. So all rectangles whose depth is 4, 5, 6 or 7, and breadth 8, 9, 10 or 11 have value 1, and behave like a single free move for Lefty, despite their variable shapes.

Let's consider a fairly complicated example, the  $5 \times 10$  rectangle. Lefty can split 10 into  $1 + 9$ ,  $2 + 8$ ,  $3 + 7$ ,  $4 + 6$  or  $5 + 5$  and we can read the values of the corresponding rectangles  $5 \times 1$  and  $5 \times 9$ , etc. from Table 1 to see that Lefty's options have values

$$-4 + 1, \quad -1 + 1, \quad -1 + 0, \quad 0 + 0, \quad 0 + 0$$

Rita can split 5 into  $1 + 4$  or  $2 + 3$  yielding pairs of breadth 10 rectangles of values  $9 + 1$  or  $4 + 4$ . So the  $5 \times 10$  rectangle has value

$$\{-3, 0, -1, 0, 0 \mid 10, 8\} = \{0 \mid 8\} = 1,$$

and Table 1 is continued in this way.



		Breadth															
		1	2	3	4	5	6	7	8	9	10	11	12	13	14	15	16
Depth	1	0	1	2	3	4	5	6	7	8	9	10	11	12	13	14	15
	2	-1	0		1		2		3		4		5		6		
	3	-2	0		1		2		3		4		5		6		
	4	-3	-1		0				1				2				
	5	-4															
	6	-5	-2		0				1				2				
	7	-6															
	8	-7	-3		-1				0				1				
	9	-8															
	10	-9	-4		-1				0				1				
	11	-10															
	12	-11	-5		-2				0				1				
	13	-12															

**Table 1.** Values of Rectangles in Cutcake.

## Maundy Cake

Every Maundy Thursday Lefty and Rita play a different cake-cutting game, in which Lefty's move is to divide one cake into *any* number of *equal* pieces, using only vertical cuts, while Rita does likewise, but with horizontal cuts. Once again the cuts must follow Mother's scorings, so that all dimensions will be whole numbers.

This game was proposed and solved by Patrick Mauhin—can you see the general pattern in his table of values (Table 2)? We worked them out as follows:

$$\begin{aligned}
 \text{value of } 5 \times 12 &= \left\{ \begin{array}{ccccc|c} \text{twelve of} & \text{six of} & \text{four of} & \text{three of} & \text{two of} & \text{five of} \\ 5 \times 1 & 5 \times 2 & 5 \times 3 & 5 \times 4 & 5 \times 6 & 1 \times 12 \end{array} \right\} \\
 &= \left\{ \begin{array}{ccccc|c} \text{twelve of} & \text{six of} & \text{four of} & \text{three of} & \text{two of} & \text{five of} \\ -1 & 0 & 0 & 1 & 1 & 10 \end{array} \right\} \\
 &= \{ -12, 0, 0, 3, 2 \mid 50 \} = 4.
 \end{aligned}$$

	1	2	3	4	5	6	7	8	9	10	11	12	13	14	15	16	17	18
1	0	1	1	3	1	4	1	7	4	6	1	10	1	8	6	15	1	13
2	-1	0	0	1	0	1	0	3	1	1	0	4	0	1	1	7	0	4
3	-1	0	0	1	0	1	0	3	1	1	0	4	0	1	1	7	0	4
4	-3	-1	-1	0	-1	0	-1	1	0	0	-1	1	-1	0	0	3	-1	1
5	-1	0	0	1	0	1	0	3	1	1	0	4	0	1	1	7	0	4
6	-4	-1	-1	0	-1	0	-1	1	0	0	-1	1	-1	0	0	3	-1	1
7	-1	0	0	1	0	1	0	3	1	1	0	4	0	1	1	7	0	4
8	-7	-3	-3	-1	-3	-1	-3	0	-1	-1	-3	0	-3	-1	-1	1	-3	0
9	-4	-1	-1	0	-1	0	-1	1	0	0	-1	1	-1	0	0	3	-1	1
10	-6	-1	-1	0	-1	0	-1	1	0	0	-1	1	-1	0	0	3	-1	1
11	-1	0	0	1	0	1	0	3	1	1	0	4	0	1	1	7	0	4

**Table 2.** Maundy Cake Values.

If you haven't guessed a general rule, you'll find ours in the Extras. If you have, try it out on the  $999 \times 1000$  cake, or the  $1000 \times 1001$  one.

## A Few More Applications of the Simplicity Rule

The more questionable values for Ski-Jumps and Hackenbush positions are easily understood in terms of the Simplicity Rule. For example the Ski-Jumps position

$$\begin{array}{|c|c|c|c|c|} \hline L & & & & \\ \hline & R & & & \\ \hline & & & & \\ \hline & & & & \\ \hline \end{array} = \left\{ \begin{array}{|c|c|c|c|c|} \hline & L & & & \\ \hline & R & & & \\ \hline & & & & \\ \hline & & & & \\ \hline \end{array} \mid \begin{array}{|c|c|c|c|c|} \hline L & & & & \\ \hline R & & & & \\ \hline & & & & \\ \hline & & & & \\ \hline \end{array} \right\}$$

has value  $\{2\frac{1}{2} \mid 4\frac{1}{2}\}$  which the Simplicity Rule requires to be 3, just as we said. The last Hackenbush position

$$\begin{array}{c} \circ \\ | \\ \circ \\ / \quad \backslash \\ \circ \quad \circ \\ \hline \end{array} = \left\{ \begin{array}{c} \circ \quad \circ \\ | \quad | \\ \circ \quad \circ \\ / \quad \backslash \\ \circ \quad \circ \\ \hline \end{array} \mid \begin{array}{c} \circ \\ / \quad \backslash \\ \circ \quad \circ \\ \hline \end{array} \right\}$$



of Fig. 18 in the Extras to Chapter 1 can be seen to have value  $\{\frac{1}{2}, \frac{1}{2} \mid 2\} = 1$  by another application of the Rule. Values of more complicated positions such as the horse of Fig. 4 can be found by repeated applications. We have followed the recommended practice of writing against each edge the value of the position which would result if that edge were deleted. These positions will either be found later in the figure or are sums of the simple positions discussed in Chapter 1.

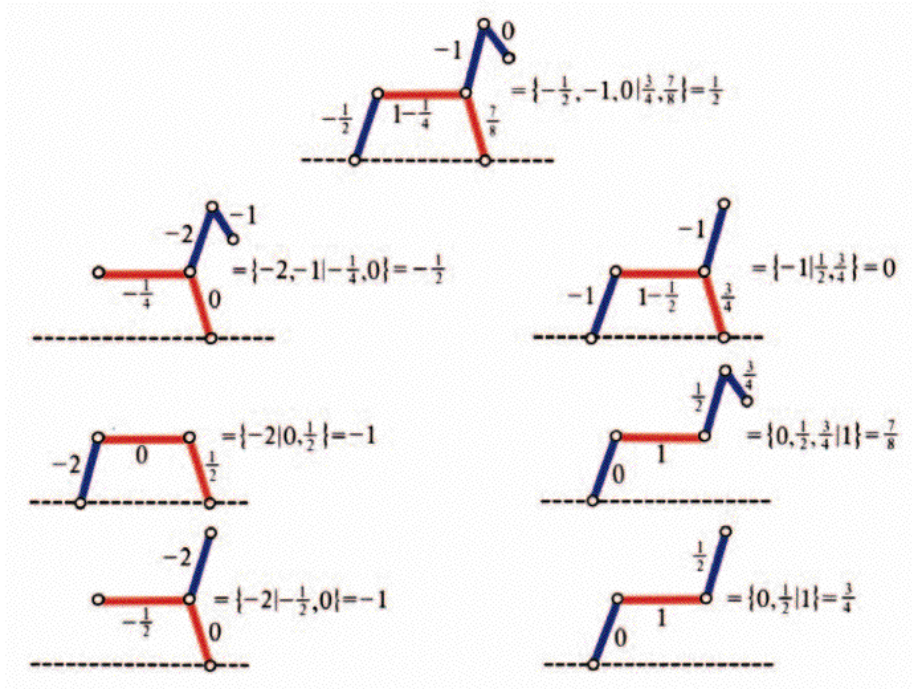


Figure 4. Working Out a Horse.

### Positive, Negative, Zero, and Fuzzy Positions

We can classify all games into four *outcome classes*, which specify who has the winning strategy when Left starts and who has the winning strategy when Right starts, as in Table 3. It may happen that Left can win no matter who starts—in this case we shall call  $G$  **positive**, since we are in favor of Left. Conversely, if Right wins whoever starts, we shall call  $G$  **negative**. In the other two cases, the player who wins may be Left or Right depending on who starts. If the player who starts is the *loser*, we have already called the game a **zero game**, and if the player who starts is the *winner*, we shall call it a **fuzzy** one.

		If Left starts	
		Left wins	Right wins
If Right starts	{	Left wins	positive (L wins)
		Right wins	zero (2 wins)
		fuzzy (1 wins)	negative (R wins)

**Table 3.** The Four Possible Outcomes.

A handy way of remembering these four cases is just to describe the player who has the winning strategy—this is either *Left*, *Right*, or the *first*, or the *second* player to move from the start. In symbols, we have

$G > 0$ or $G$ is <b>positive</b>	if player L (Left)	can always win
$G < 0$ or $G$ is <b>negative</b>	if player R (Right)	can always win
$G = 0$ or $G$ is <b>zero</b>	if player 2 (second)	can always win
$G \parallel 0$ or $G$ is <b>fuzzy</b>	if player 1 (first)	can always win.

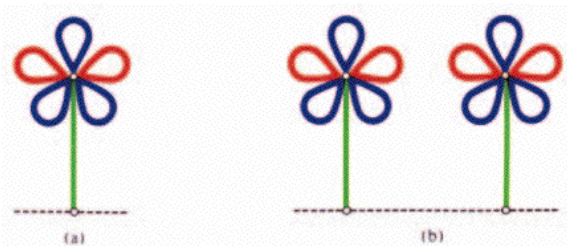
In Blue-Red Hackenbush we've already seen that a picture with only blue edges is positive (if there are any), and one with only red edges is negative. A picture having no edges is zero, but there are also other zero pictures, for example any picture with as many red edges as blue in which each edge is connected to the ground by its own color, or the rather simple picture of Fig. 6(c) in Chapter 1, which has two blue edges and three red.

There are no *fuzzy* positions in Blue-Red Hackenbush, which makes it rather unusual, because in most games it is some advantage to be the first player. So to get more varied behavior, we introduce a new kind of edge.

## Hackenbush Hotchpotch

This game is played as before except that there may also be some *grEen* edges, which Either player may chop. But blue edges are still reserved for Left, and red ones for Right and we continue to use the normal play rule, that when you can't move, you lose.

The pretty flower of Fig. 5(a) is an example of a fuzzy position in Hackenbush Hotchpotch, for since its stalk is green, either player may win the game at the first move by chopping this edge.

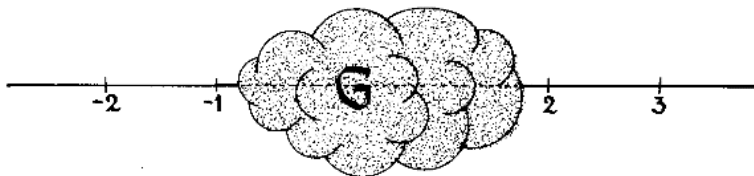


**Figure 5.** Two Fuzzy Flowers make a Positive Posy.



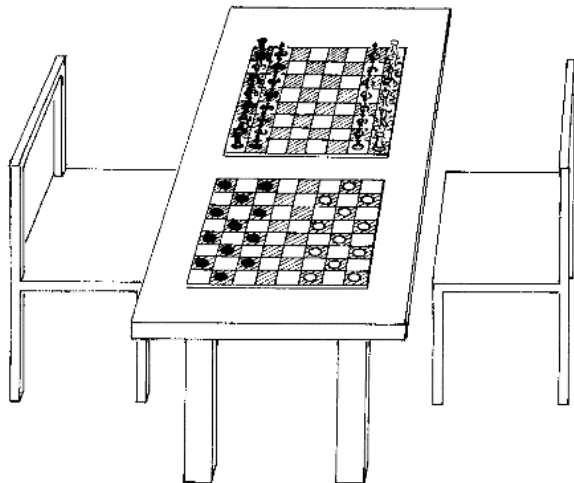
It might be thought that, like a zero game, a fuzzy game confers no particular advantage on either player, and so should also be said to have value 0. But this would be a misleading convention, because often a fuzzy game can be more in favor of one player than the other, even though either player can win starting first. For example, the flower of Fig. 5(a) has more blue petals than red ones, and this favors Left by just enough to ensure that the sum of two such flowers, as in Fig. 5(b), is positive. For no matter who starts in Fig. 5(b), Left has enough spare moves to arrange that Right is first to take a stalk, whereupon Left wins by taking the other.

In fact a fuzzy game is neither greater than 0, less than 0, nor equal to 0, but rather *confused* with 0. Figure 6 shows a good mental picture, illustrating a fuzzy game  $G$  whose place in the number scale is rather indeterminate, being represented by the cloud. Since this covers 0 and stretches some way on either side, we can't tell exactly where  $G$  is. It's probably buzzing about under the cloud, so that it seems positive at some times, and negative at others, according to its environment.



**Figure 6.** How Big is a Fuzzy Game?

### Sums of Arbitrary Games



**Figure 7.** Ready to Play the Sum of Two Games.

Now that we've learned how to work with numbers and how to find when games are positive, negative, zero, or fuzzy, we should learn what it means to add two games in general. Being very clever, Left and Right may play a sum of *any* pair of games  $G$  and  $H$  as in Fig. 7. We shall refer to the two games  $G$  and  $H$  as the **components** of the compound game  $G + H$ , which is played as follows. The players move alternately in  $G + H$ , and either player, when it is his turn to move, chooses one of the components  $G$  or  $H$ , and makes a move legal for him in that component.

The turn then passes to his opponent, who plays in a similar manner. The game ends as usual when some player finds himself unable to move (this will only happen when there is no component in which he has a legal move) and that player loses.

Symbolically we shall write  $G^L$  for the typical Left option (i.e., a position Left can move to) from  $G$ , and  $G^R$  for the typical Right option, so that

$$G = \left\{ G^L \mid G^R \right\}$$

We use this notation even when a player has more than one option, or none at all, so that the symbol  $G^L$  need not have a unique value. Thus if  $G = \{a, b, c, \dots \mid d, e, f, \dots\}$ ,  $G^L$  means  $a$  or  $b$  or  $c$  or  $\dots$  and  $G^R$  means  $d$  or  $e$  or  $f$  or  $\dots$ . In the game  $2 = \{1 \mid \}$ ,  $G^L$  has only the value 1, but  $G^R$  has no value. In this notation the definition of sum is written

$$G + H = \left\{ G^L + H, G + H^L \mid G^R + H, G + H^R \right\}$$

since Left's options from  $G + H$  are exactly the sums  $G^L + H$ , or  $G + H^L$  in which he has moved in just one component, and Right's are the similar sums  $G^R + H$ ,  $G + H^R$ .

It should be made clear that there is no restriction on the component a player moves in at any time other than his ability to move in that component. You need not follow your opponent's move with another move in the same component, nor need you switch components unless you want to. Indeed in many games (e.g. Blue-Red Hackenbush and Cutcake) a move may produce more than one component.

## The Outcome of a Sum

The major topic of this book is the problem of finding ways of determining the outcome of a sum of games given information only about the separate components, so we cannot expect to answer this question instantly. But we should at least expect that if both  $G$  and  $H$  are in favor of Left, so is  $G + H$  and this turns out to be the case. In fact we can strengthen the assertion a little, by allowing zero games.

If  $G$  and  $H$  are greater than or equal to 0, so is  $G + H$ .

What does it mean for  $G$  to be greater than or equal to 0? From Table 3, we see that these are just the two cases in which Left has a winning strategy *provided Right starts*. If this is



true of  $G$  and  $H$ , it is also true of  $G + H$ , for if Right starts, he must make a move in one of  $G$  and  $H$ , say  $G$ , and Left can reply with the responses of his winning strategy in  $G$  for as long as Right continues to move in that game. Whenever Right switches to  $H$ , Left responds in  $H$  with the moves of his winning strategy in that game, and so on. If he plays like this, Left will never be lost for a move in  $G + H$ , for he can always respond in whatever component Right has just played in, so he cannot lose.

Now we have another principle, which covers some fuzzy games:

If  $G$  is positive or fuzzy, and  
 $H$  is positive or zero, then  
 $G + H$  is positive or fuzzy.

For we see from Table 3 that the positive or fuzzy games are just those from which Left has a winning strategy *provided Left starts*. So what we have to show is that if Left has a winning strategy in  $G$  with Left starting, and one in  $H$  with Right starting, he has one in  $G + H$  with Left starting.

This is easy. He starts in  $G + H$  by making the first move of his winning strategy for  $G$ , and then always replies to any of Right's moves with another move in the same component, so that the sequence of moves played in  $G$  is begun by Left and that in  $H$  by Right. If Left follows his two winning strategies in the two components he will therefore win their sum.

We can summarize these results, and those obtained by interchanging the roles of Left and Right, in symbols:

If  $G \geq 0$  and  $H \geq 0$  then  $G + H \geq 0$ ,  
 If  $G \leq 0$  and  $H \leq 0$  then  $G + H \leq 0$ ,  
 If  $G \triangleright 0$  and  $H \geq 0$  then  $G + H \triangleright 0$ ,  
 If  $G \triangleleft 0$  and  $H \leq 0$  then  $G + H \triangleleft 0$ .

Here " $\geq$ " means " $>$ " or " $=$ ", " $\triangleleft$ " means " $<$ " or " $\parallel$ ", etc.

In particular if  $H$  is a zero game, it may be used in all four lines, and then  $G + H$  will have the same outcome as  $G$  in all circumstances.

Adding a zero game never affects the outcome.

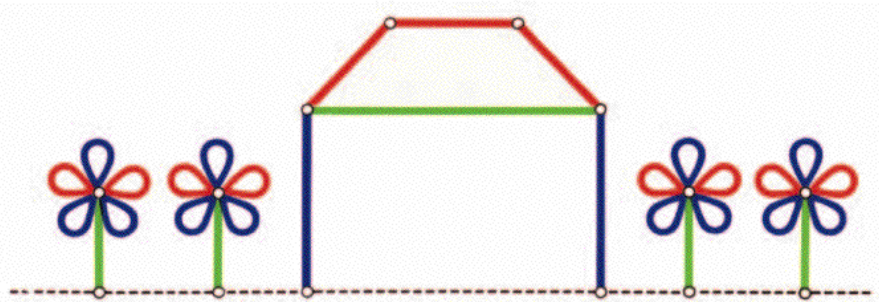
We've already seen some of these principles in action in Blue-Red Hackenbush. But now we know that they work for arbitrary games and did not depend on the fact that the positions we evaluated in Hackenbush turned out to be numbers. Table 4 shows the possibilities for the outcome of  $G + H$ , given those of  $G$  and  $H$ .

Any Hackenbush picture in which only blue edges touch the ground is positive, for plainly the last move will be Left's. In particular the house of Fig. 8 is positive. But the garden is also positive, for it is made up from two of the positive posies of Fig. 5(b). So the whole picture can be won by Left, no matter who starts.



	$H = 0$	$H > 0$	$H < 0$	$H \parallel 0$
$G = 0$	$G + H = 0$	$G + H > 0$	$G + H < 0$	$G + H \parallel 0$
$G > 0$	$G + H > 0$	$G + H > 0$	$G + H ? 0$	$G + H \triangleright 0$
$G < 0$	$G + H < 0$	$G + H ? 0$	$G + H < 0$	$G + H \triangleleft 0$
$G \parallel 0$	$G + H \parallel 0$	$G + H \triangleright 0$	$G + H \triangleleft 0$	$G + H ? 0$

**Table 4.** Outcomes of sums of games. The entries  $G + H ? 0$  are unrestricted.



**Figure 8.** A Positive House and Garden.

## The Negative of a Game

In our examples of Blue-Red Hackenbush we found that whenever we interchanged the colors red and blue throughout, the number representing the value changed sign. This suggests that in general we define the negative of a game by interchanging the roles of Left and Right throughout. So, from no matter what position of  $G$ , the moves that once were legal for Left now become legal for Right, and vice versa. If  $G$  is the position

$$G = \{A, B, C, \dots \mid D, E, F, \dots\},$$

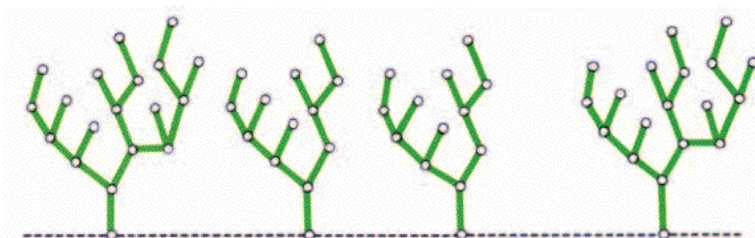
then  $-G$  will be the position

$$-G = \{-D, -E, -F, \dots \mid -A, -B, -C, \dots\}.$$

For the general game  $G = \{G^L \mid G^R\}$  we have

$$-G = \{-G^R \mid -G^L\}.$$

This definition works even when applied to fuzzy positions. Let's see what it means in practice. The negative of any Hackenbush position is obtained by interchanging the colors red and blue. Any green edges are unaltered. So for example the negative of the flower of Fig. 5(a) is a similar flower, but with three red and two blue petals instead of three blue and two red. A Hackenbush picture made entirely of green edges will therefore be its own negative. This means in particular that the little forest of Fig. 9 is a zero game, for it consists of the sum of two trees and their negatives (which have the same shape).

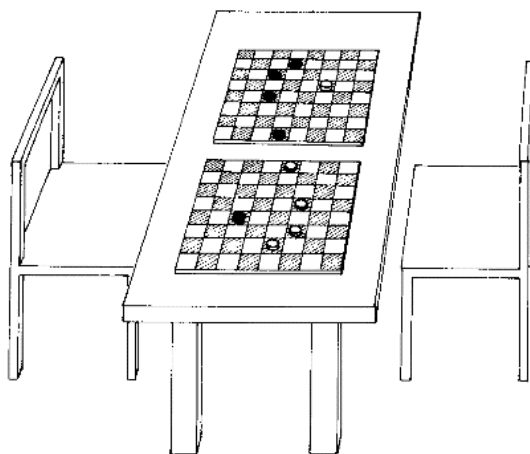


**Figure 9.** Under the Greenwood Trees.

But no single tree of this forest is zero (the first player could win by chopping its trunk), and in fact the sum of one large and one small tree from Fig. 9 is also non-zero (chop the larger one's horizontal branch). So  $G + G$  can be zero without  $G$ 's being zero. In fact we'll meet the commonest such game, Star, in just a few pages. Star is its own negative.

### Cancelling a Game with its Negative

Is the negative of a game properly defined? Is it really true that the sum of a game and its negative is a zero game? How does the second player win the compound game  $G + (-G)$ ?



**Figure 10.** Playing a Game with its Negative.

The answers are fairly obvious. The first player must move in some component—let's suppose he moves from  $G$  to  $H$ , making the total position  $H + (-G)$ . Then by the definition of  $-G$ , the move from  $-G$  to  $-H$  will be legal for his opponent, who can therefore convert the whole position to  $H + (-H)$ . The first player might then move to  $H + (-K)$ , but this the second player can convert to  $K + (-K)$ , and so on. In other words, the second player can always mimic his opponent's previous move by making an exactly corresponding move in the

other component. If he does this, he will never be lost for a move, and so will win the game. This is, of course, simply the Tweedledum and Tweedledee Argument, which we learned in Chapter 1.

For any game  $G$ , the game  $G + (-G)$  is a zero game.

We are only discussing finite games, so the ending condition prevents draws by infinite play.

## Comparing Two Games

We shall say that  $G$  is greater than or equal to  $H$ , and write  $G \geq H$ , to mean that  $G$  is at least as favorable to Left as  $H$  is. What exactly does this mean? We can get a hint from ordinary arithmetic, when  $x \geq y$  if and only if the number  $x - y$  is positive or zero. Let's take this as the definition for games:

$G \geq H$  means that  $G + (-H) \geq 0$ .

Then it's easy to see that if  $G \geq H$  and  $H \geq K$ , we have  $G \geq K$ . For  $G + (-K)$  has the same outcome as  $G + (H + (-K)) + (-H)$ , since  $H + (-H)$  is a zero game, and this can be written as the sum of  $G + (-H)$  and  $H + (-K)$ , which are both  $\geq 0$ . Appealing to our results on sums of games, we see that  $G + (-K) \geq 0$ , that is  $G \geq K$ . In a similar way, from Table 4 we derive Table 5, showing what we can deduce about the order relation between  $G$  and  $K$  from those between  $G$  and  $H$  and  $H$  and  $K$ .

	$H = K$	$H > K$	$H < K$	$H \parallel K$
$G = H$	$G = K$	$G > K$	$G < K$	$G \parallel K$
$G > H$	$G > K$	$G > K$	$G ? K$	$G \triangleright K$
$G < H$	$G < K$	$G ? K$	$G < K$	$G \triangleleft K$
$G \parallel H$	$G \parallel K$	$G \triangleright K$	$G \triangleleft K$	$G ? K$

**Table 5.** What relation is  $G$  to  $K$ ?

Here  $G = H$  means that  $G$  and  $H$  are *equally favorable* to Left

$G > H$  means that  $G$  is *better* than  $H$  for Left

$G < H$  means that  $G$  is *worse* than  $H$  for Left

$G \parallel H$  means that  $G$  is *sometimes better, sometimes worse*, than  $H$  for Left.

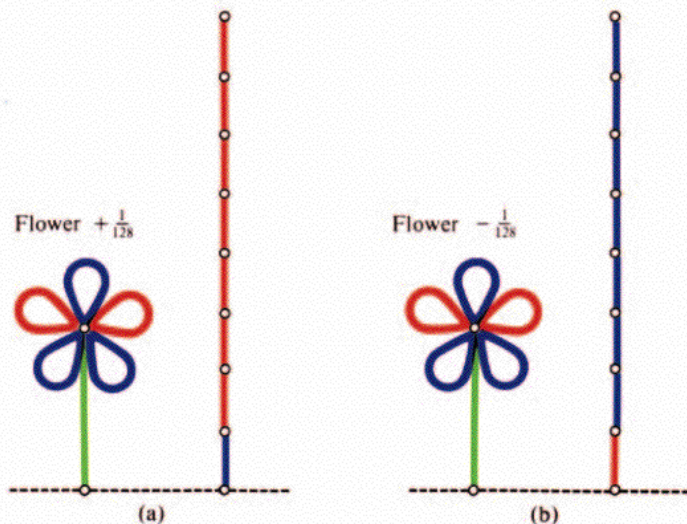
Once again “ $\triangleright$ ” means “ $>$ ” or “ $\parallel$ ”, etc.

## Comparing Hackenbush Positions

The comparisons we made between Blue-Red Hackenbush positions in Chapter 1 are still valid, but more general things can happen when we meet fuzzy positions. Let's discuss the flower of Fig. 5(a). This is fuzzy as it stands. How much do we have to add to it before it becomes



positive? It's not too hard to see that adding one free move for Left is already enough, since Left can win no matter who starts, by chopping the flowerstalk if this is still available, and using his free move if not.



**Figure 11.** The Flower is Dwarfed by Very Small Hollyhocks of Either Sign.

Is half a move still enough? The answer again turns out to be “yes”, and in fact Fig. 11 shows that even a very small fraction of a move is ample. Figure 11(a) adds only  $\frac{1}{128}$  of a move to the flower, but it is still clear that Left still wins by essentially the same strategy, giving first preference to chopping the flowerstalk, and if the flower has already gone, chopping the blue edge of his allowance. In Fig. 11(b) we have subtracted  $\frac{1}{128}$  of a move, and this time Right wins by a similar strategy.

This means that the flower must be very small indeed—we have just proved that

$$-\frac{1}{128} < \text{flower} < +\frac{1}{128}$$

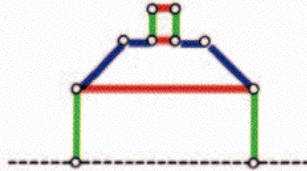
and of course our argument is actually enough to show that the flower is greater than all negative numbers and less than all positive ones, although still not zero. So the only number its cloud covers is 0 itself (see Fig. 12).

The same kind of argument proves a much more general result, that any Hackenbush picture in which all the ground edges are green has a value which lies strictly between all negative and



**Figure 12.** The Cloud Hides the Flower, but Covers only one Number.

all positive numbers. Right can win when we subtract  $\frac{1}{128}$  from such a picture by giving first priority to chopping any ground edge of the picture, and removing his free move allowance only when the rest of the picture has vanished. So the house of Fig. 13 is less than any positive number. But Left can win in this picture by itself, so although the house is small, it's quite



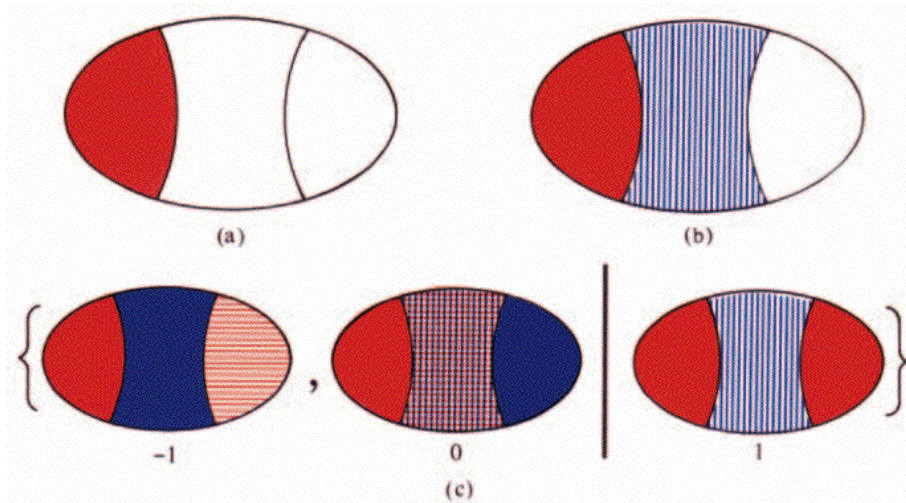
**Figure 13.** A Small but Positive House.

definitely positive (compare Fig. 5(b)). (The fight is about who chops one of the walls, for his opponent will win by chopping the other. If Left works down the edges available to him from the chimney, he can make at least 5 moves to Right's at most 4 before a wall need be chopped.)

## The Game of Col

Colin Vout has invented the following map-coloring game. Each player, when it is his turn to move, paints one region of the map, Left using the color blue and Right using red. No two regions having a common frontier edge may be painted the same color. Whoever is unable to paint a region loses. Let us suppose that Right has made the first move in the very simple map with three regions shown in Fig. 14(a). What is the value of the resulting position?

The effect of Right's move has been to reserve the central region for Left so that we can think of it as being already *tinted* blue (Fig. 14(b)). In general any unpainted region next



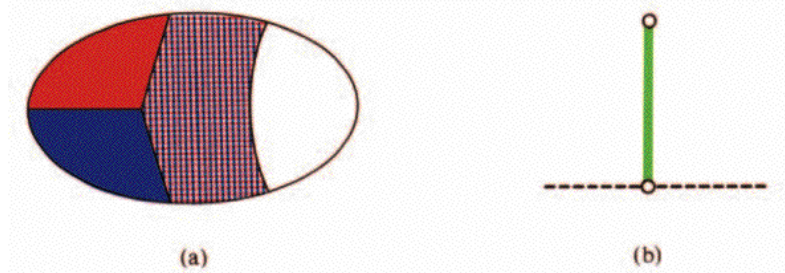
**Figure 14.** A Simple Game of Col.





to a painted one automatically acquires a tint of the opposite color, indicating that only one player may use it thereafter. In the figures tinting is represented by hatching. Figure 14(c) shows the results of each possible move from Fig. 14(b). If Left exercises his first option, there will remain one unpainted region, but this will be tinted red and so have value  $-1$ . After his second option, the unpainted region is tinted both red *and* blue, so neither player may use it and the value is zero. Right's only possible move leaves a blue tinted region, value 1. The value of Fig. 14(a) is therefore  $\{-1, 0 \mid 1\} = \frac{1}{2}$ .

### A Star is Born!



**Figure 15.** A Startling Value.

In Fig. 15(a) the only available region is not restricted in any way. Either player may therefore paint it and so move to a position of value zero. The value of Fig. 15(a) is therefore  $\{0 \mid 0\}$ . How should we interpret this? The Simplicity Rule will not help us, for there is no number strictly between 0 and 0, but we should expect the value to be less than or equal to each of

$$\{0 \mid 1\}, \{0 \mid \frac{1}{2}\}, \{0 \mid \frac{1}{4}\}, \dots,$$

since Right's option 0 is less than or equal to each of

$$1, \frac{1}{2}, \frac{1}{4}, \dots$$

In other words the value is less than or equal to each of

$$\frac{1}{2}, \frac{1}{4}, \frac{1}{8}, \dots$$

Since it is also greater than or equal to the negatives of these, one might guess the value 0. But is Fig. 15(a) a zero position? No! For whoever starts is the winner, not the loser. In fact, the position is fuzzy. Since the value  $\{0 \mid 0\}$  arises in many games, it deserves a proper name, and we write it  $*$ , pronounced **Star**. A solitary green stalk in Hackenbush has a value  $*$  (Fig. 15(b)), since again each player must end the game with his first move.

Although the value  $*$  is not a number it can perfectly well be added to any other positions, whether their values are numbers or not. For instance the entire Fig. 15 can be regarded as a compound position in the sum of a Col game with a Hackenbush one, and has value  $* + *$ . Who wins this compound position? If you start and paint the region, I shall take the stalk and finish. If you take the stalk, I shall paint the region. In either case the second player wins and so the value is zero!

$$* + * = 0.$$

More generally, we consider positions of value  $\{x \mid x\}$  for any number  $x$ . This is strictly greater than every number  $y < x$  and strictly less than every number  $z > x$ , but neither greater than, less than nor equal to  $x$  itself. We can also add such values to other values of the same kind or to numbers.

Let us add  $\frac{3}{4}$  to  $*$ , that is  $\{\frac{1}{2} \mid 1\} + \{0 \mid 0\}$ . Left has two options  $\frac{1}{2} + *$  (moving from  $\frac{3}{4}$ ) and  $\frac{3}{4} + 0$  (moving from  $*$ ), and Right has the two options  $1 + *$ ,  $\frac{3}{4} + 0$ . Since  $* < \frac{1}{4}$ , Left's best option is  $\frac{3}{4}$ , and this is also Right's best option for the same reason. So we have

$$\frac{3}{4} + * = \{\frac{3}{4} \mid \frac{3}{4}\}$$

and more generally

$$x + * = \{x \mid x\}$$

for any number  $x$ .

THE VALUE  $x*$

This type of value occurs so often that we'll use an abbreviated notation

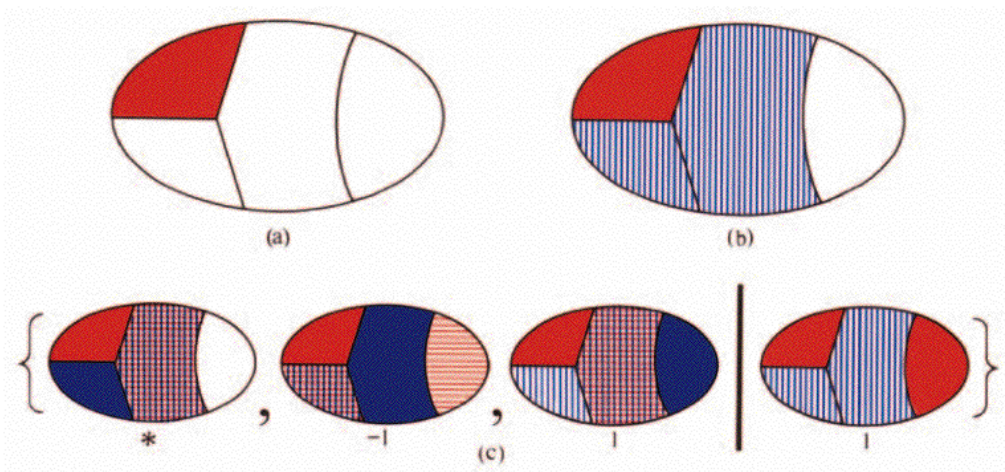
$$x * \quad \text{for} \quad x + *$$

just as people write  $2\frac{1}{2}$  for  $2 + \frac{1}{2}$ . You must learn not to confuse  $x*$  with  $x$  times  $*$ , just as you don't confuse  $2\frac{1}{2}$  with 2 times  $\frac{1}{2}$ .

## Col Contains Such Values

For example, in the position of Fig. 16(a), which has tints as in Fig. 16(b), the players have the options shown in Fig. 16(c). It therefore has the value  $\{*, -1, 1 \mid 1\}$ . Since the values  $*$  and  $-1$  are both less than 1, this simplifies to  $\{1 \mid 1\} = 1*$ .

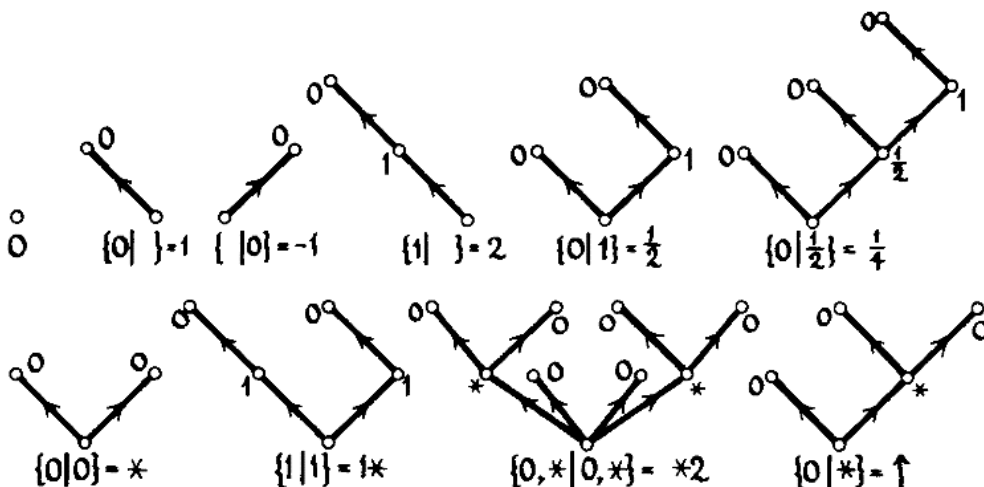
You'll find more about Col in the Extras.



**Figure 16.** The Value of a Col Position.

## Game Trees

We usually display games by trees, with nodes for positions and edges for moves, as in the examples



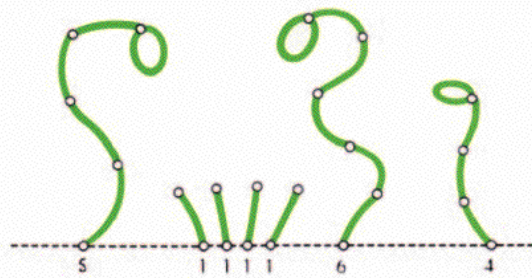
Of course we use edges slanting to the left for Left's moves and to the right for Right's. This can help you to see that games that superficially look very different may have the same essential structure (e.g. Figs. 15(a) and 15(b)). In complicated positions we often combine nodes to avoid repetitions and we sometimes draw the diagrams upside-down as we did for Ski-Jumps and Toads-and-Frogs in Figs. 12 and 16 of Chapter 1.

## Green Hackenbush, The Game of Nim, and Nimbers

In Chapter 7 we shall give a complete theory for Hackenbush pictures that are entirely green, containing neither blue nor red edges. Of course the game represented by a green Hackenbush picture is an **impartial** one, in the sense that from any position exactly the same moves are legal for each player. There are several of our chapters (4, 12–17) devoted to impartial games, which make it clear that the game of **Nim** plays a central role in the theory of such games. We shall introduce this game by analyzing some particularly simple green Hackenbush positions.

A very simple kind of green Hackenbush picture is the green snake, which consists of a chain of green edges with just one edge touching the ground. It will not affect the play to bend some of the topmost edges into loops, so allowing our snakes to have heads. Figure 17 illustrates a number of snakes, those of length one being perhaps better called blades of grass. How shall we play such a game?





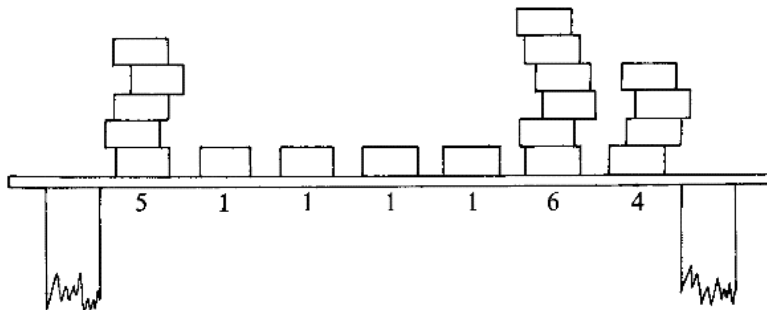
**Figure 17.** *Latet anguis in herba* (Virgil, Eclogue, III,93).

Plainly any move will affect just one snake, and will replace that snake by a strictly shorter one. This means that if we write  $*n$  for the value of a snake with  $n$  edges (counting the head loop, if present), then we have

$$\begin{aligned} *0 &= \{ \mid \} = 0, \\ *1 &= \{ *0 \mid *0 \} = \{ 0 \mid 0 \}, \text{ the game we called } *, \\ *2 &= \{ *0, *1 \mid *0, *1 \} = \{ 0, * \mid 0, * \}, \dots, \\ *n &= \{ *0, *1, *2, \dots * (n-1) \mid *0, *1, *2, \dots * (n-1) \}. \end{aligned}$$

These special values are called **nimbers** and you'll hear about them incessantly from now on. The fact that the same options appear on both sides of the  $\mid$  emphasizes the impartiality of the game.

It might be safer to play the game with heaps of counters instead of snakes. In this form, the general position has a number of heaps, and the move is to remove any positive number of counters from any one heap. In the normal play version, the winner is the person who takes the last counter. So this is the same as the snake game, with an  $n$ -edge snake replaced by a heap of  $n$  counters, and Fig. 17 becomes Fig. 18.



**Figure 18.** A Simple Nim Position.

The game is the celebrated game of Nim, analyzed by C. L. Bouton, and we shall meet it again and again, for R. P. Sprague and P. M. Grundy showed (independently) that it implicitly



contains the additive theory of all impartial games. For the moment, we refrain from giving the theory in general (see the Extras to Chapter 3), and just describe a few simple positions and equalities.

## Get Nimble with Nimbers

Firstly, note that a single non-empty heap is fuzzy, for the first player to move can take the whole heap. In the Hackenbush form, he chops the bottom edge of the snake. Next, two heaps of equal size add up to zero, for the impartiality ensures that a position is its own negative. So any pair of equal heaps in a position may be neglected—this allows us to neglect all four blades of grass in Fig. 17. On the other hand, the sum of two unequal heaps is a fuzzy game, for the first player can equalize them by reducing the larger one.

These remarks show that in a three-heap game, the player who first (fatally) equalizes two of the heaps or empties any heap is the loser, for in the first case his opponent can remove the third heap, and in the second, equalize the two non-empty heaps. But in the position  $*1 + *2 + *3$ , every move of the first player loses for one of these reasons, and so  $*1 + *2 + *3 = 0$ . Since nimbers are their own negatives this can also be written in any of the forms

$$*1 + *2 = *3, \quad *1 + *3 = *2, \quad *2 + *3 = *1,$$

which are very useful in simplifying positions. For example, any situation in which there is one heap of size 2 and another of size 3 may be simplified by regarding these as a single heap of size 1.

From the position  $*1 + *4 + *5$ , if either player reduces one of the larger heaps to 2 or 3, the other player can reduce the other to 3 or 2 respectively. Since all the other moves are fatal for one of our two reasons, this shows that  $*1 + *4 + *5 = 0$ , enabling us in general to replace two heaps of any two distinct sizes from 1, 4, 5 by one heap of the third size.

The equality  $*2 + *4 + *6 = 0$  can be checked in a similar way. If either player reduces one of the larger heaps to 1 or 3, his opponent can reduce the other to the other, getting  $*2 + *1 + *3$ . The only other moves not obviously fatal are to reduce 2 to 1 or 6 to 5, and these counter each other since  $*1 + *4 + *5 = 0$ .

We can now do some rather clever nimber arithmetic:

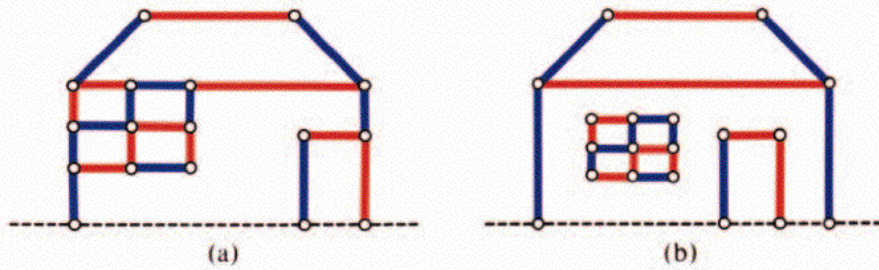
$$*3 + *5 = *2 + *1 + *5 = *2 + *4 = *6,$$

so we have another equality, representable in any of the ways

$$*3 + *5 = *6, \quad *3 + *6 = *5, \quad *5 + *6 = *3, \quad *3 + *5 + *6 = 0.$$

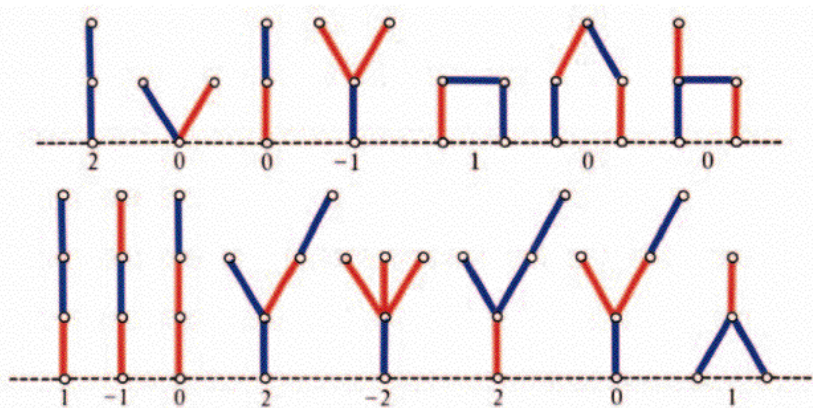
Later on we shall show that the sum of *any* two nimbers is another nimber, and give rules for working out which one it will be. But we already have more than enough to work out who wins the game of Figs. 17 and 18, and how. Since the four blades of grass can be neglected, the value of this is  $*5 + *6 + *4 = *3 + *4$ , which, being fuzzy, is a first player win by reducing 4 to 3. So one winning move is to chop the head off the third snake, reducing his value from  $*4$  to  $*3$ . The diligent reader should check that the only other two winning first moves are to reduce  $*5$  to  $*2$  and  $*6$  to  $*1$ . Our Most Assiduous Reader will prepare an extended nim-addition table using our examples as basis.

## Childish Hackenbush



**Figure 19.** Childish and Grown-Up Pictures.

We call a Hackenbush picture *childish* because every edge is connected to the ground, perhaps via other edges. For example, the house of Fig. 19(a) is childish, but that of Fig. 19(b) is not, because the window will fall down and no longer be part of the position. The rule in ordinary Hackenbush is that edges which might make a picture non-childish are deleted as soon as they arise. However in **Childish Blue-Red Hackenbush** (J. Schaer) you are only allowed to take edges which leave all the others connected to the ground; nothing may fall off. It might be thought that this is not a very interesting game. However Childish Blue-Red Hackenbush is far from trivial and the reader may like to verify the values of the positions in Fig. 20, and to compare them with the values of ordinary Blue-Red Hackenbush in Fig. 16 of Chapter 1.

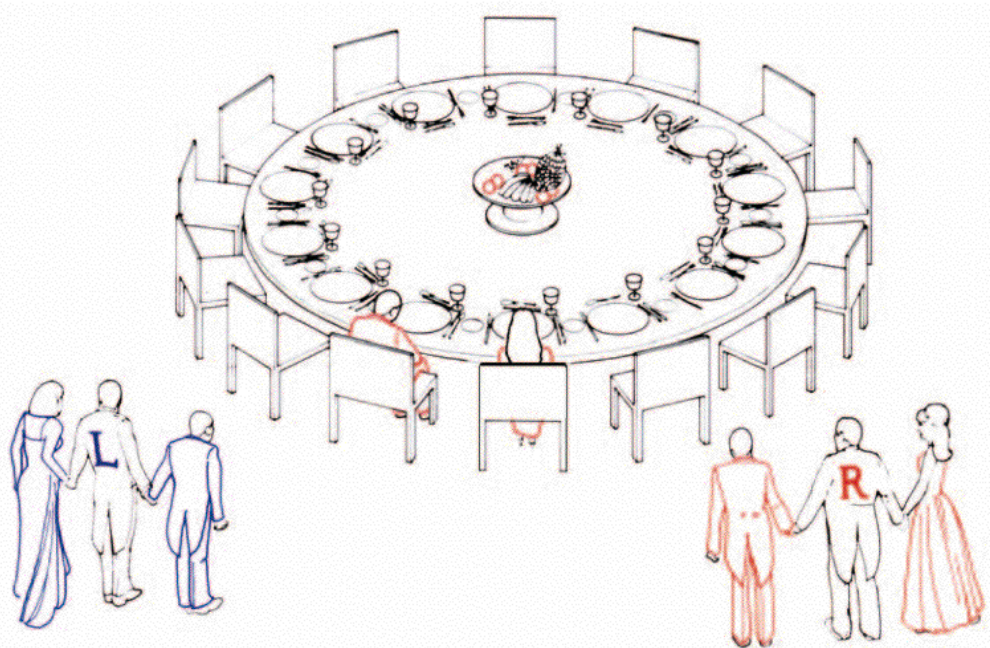


**Figure 20.** Values of Childish Blue-Red Hackenbush Positions.

Some Childish Hackenbush positions with non-integer values can be found in the Extras.



## Seating Couples



**Figure 21.** A Dinner to Celebrate the End of Chapter 2.

Figure 21 shows the dining table around which Left and Right are taking turns to seat couples for a dinner to celebrate the end of this chapter. Left prefers to seat a lady to the *left* of her partner, while Right thinks it proper only to seat her to the *right*. No gentleman may be seated next to a lady other than his own partner. The player, Left or Right, who first finds himself unable to seat a couple, has the embarrassing task of turning away the remaining guests, and so may be said to *lose*.

Of course the rules have the effect of preventing either player Left or Right from seating two couples in four adjacent chairs, for then the gentleman from one of his two couples will be next to the lady from the other. So when either player seats a couple, he effectively reserves the two seats on either side for the use of his opponent only. So after the game has started, the available chairs will form rows of three types:

- $LnL$ , a row of  $n$  empty chairs between two of Left's guests,
- $RnR$ , a row of  $n$  empty chairs between two of Right's, and
- $LnR$  or  $RnL$ , a row of  $n$  empty chairs between one of Left's guests and one of Right's.

Thus Fig. 21 is R12R. It is convenient to start the numbering from  $n = 0$ , but of course disallowing the positions L0L and R0R in which one player has illegally seated two adjacent couples. When we do this we have

$$\begin{aligned} LnL &= \{LaL + LbL \mid LaR + RbL\} \\ RnR &= \{RaL + LbR \mid RaR + RbR\} (= -LnL) \\ LnR &= \{LaL + LbR \mid LaR + RbR\} (= RnL) \end{aligned}$$

where  $a$  and  $b$  range over all pairs of numbers adding to  $n - 2$ , but excluding the disallowed positions L0L and R0R. Of course this is because whenever a player seats a couple they occupy 2 of the  $n$  seats.

As an example we have

$$R5R = \left\{ \begin{array}{l|l} R3L + L0R & R2R + R1R \\ R2L + L1R & R1R + R2R \\ R1L + L2R & \\ R0L + L3R & \end{array} \right\} = \left\{ \begin{array}{l|l} * + 0 & 1 + 0 \\ 0 + 0 & 0 + 1 \\ 0 + 0 & \\ 0 + * & \end{array} \right\}$$

which simplifies to  $\{0, * \mid 1\}$ . What value is this? To find out, we use the inequalities  $-\frac{1}{4} \leq * \leq \frac{1}{4}$ , which tell us that

$$\{0, -\frac{1}{4} \mid 1\} \leq R5R \leq \{0, \frac{1}{4} \mid 1\},$$

and so we must have  $R5R = \frac{1}{2}$ , since the Simplicity Rule tells us that this is the value of both  $\{0, -\frac{1}{4} \mid 1\}$  and  $\{0, \frac{1}{4} \mid 1\}$ . Verify in like manner the first few entries of Table 6. Who wins Fig. 21?

$n$	0	1	2	3	4	5	6	7	8	9	10	11	12	13	14	...
$LnL$	-	0	-1	-1	*	$-\frac{1}{2}$	$-\frac{1}{2}$	0	$-\frac{1}{4}$	$-\frac{1}{4}$	*	$-\frac{1}{8}$	$-\frac{1}{8}$	0	$-\frac{1}{16}$	...
$LnR = RnL$	0	0	0	*	*	*	0	0	0	*	*	*	0	0	0	...
$RnR$	-	0	1	1	*	$\frac{1}{2}$	$\frac{1}{2}$	0	$\frac{1}{4}$	$\frac{1}{4}$	*	$\frac{1}{8}$	$\frac{1}{8}$	0	$\frac{1}{16}$	...

**Table 6.** Values of Positions in Seating Couples.

# Extras

## Winning Strategies

It is not hard to see that for games which satisfy the eight conditions given in the Extras to Chapter 1, with a given player to start, say Right, there must be a winning strategy for either Left or Right. We prove this as follows.

Suppose first that there is a right option  $G^R$  of  $G$  for which Right has a winning strategy, supposing that Left starts in  $G^R$ . Then of course Right has a winning strategy in  $G$ —he moves to that  $G^R$  and continues by playing his winning strategy for  $G^R$ .

If there is no such Right option, it may happen that all the Right options have winning strategies for Left, supposing Left starts in them. But in this case Left has a winning strategy in the whole game—he waits until Right has made his first move, which must be to some  $G^R$ , and then Left continues play with his winning strategy in that  $G^R$ .

So if neither player has a winning strategy from  $G$  under the supposition that Right starts, there must be some  $G^R$  from which neither player has a winning strategy supposing Left starts. This in turn involves the existence of some Left option  $G^{RL}$  of that  $G^R$  from which neither player has a winning strategy supposing Right starts, and so on. But we obtain in this way an infinite sequence

$$G \rightarrow G^R \rightarrow G^{RL} \rightarrow G^{RLR} \rightarrow \dots$$

of legal moves in  $G$ . This shows that a play of  $G$  can last forever, which contradicts the ending condition (8, in the Extras for Chapter 1) for  $G$ .

## The Sum of Two Finite Games Can Last Forever

It is possible that two games  $D$  and  $G$  which individually satisfy the ending condition might have a sum  $D + G$  that does not. For instance if Left can make an infinite succession of moves in  $D$ :

$$\begin{array}{cccc} D & \rightarrow & D_1 & \rightarrow & D_2 & \rightarrow & \dots \\ & & L & & L & & L \end{array}$$

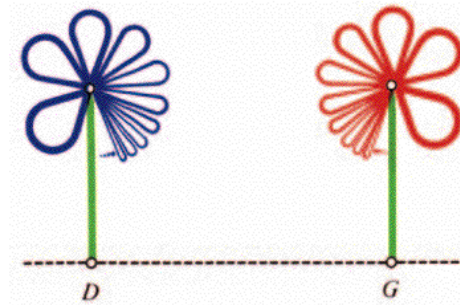
and Right an infinite succession of moves in  $G$ :

$$\begin{array}{cccc} G & \rightarrow & G_1 & \rightarrow & G_2 & \rightarrow & \dots \\ & & R & & R & & R \end{array}$$

then even though neither component game might have an infinite sequence of *alternating* Left and Right moves, there is such a sequence in the compound game  $D + G$ , namely

$$\begin{array}{cccccc} D + G & \rightarrow & D_1 + G & \rightarrow & D_1 + G_1 & \rightarrow & D_2 + G_1 & \rightarrow & D_2 + G_2 & \rightarrow & \dots \\ & & L & & R & & L & & R & & L \end{array}$$





**Figure 22.** An Infinite Delphinium and an Infinite Geranium.

If we compare the Hackenbush Hotchpotch picture of Fig. 22 with those of Fig. 5, we will see that if play is restricted to the delphinium (or the geranium) *only*, then the first player wins smartly by plucking the flower by its stem. But if *both* flowers are available, then *neither* player will take a stem, lest his opponent grab the other and win the game. So each sits plucking appropriate petals alternately and the game goes on forever.

If we want a condition that ensures that all sums of games will end, we should demand that in no game is there any infinite sequence  $G \rightarrow G_1 \rightarrow G_2 \rightarrow \dots$  of legal moves, *alternating or not*. You must look in Chapters 11 and 12 if you want to know how to add games that violate this condition.

## A Theorem about Col

Each Col position has a value

$$z \text{ or } \{z \mid z\} = z^*$$

for some number  $z$ .

To prove this we'll use a notation like that we'll introduce in Chapter 6 for the (contrasting) game of Snort, namely:

- for a region available to either player,
- (blue) for one usable by Left only,
- (red) for one usable only by Right, and
- ⊗ (piebald) for one available to neither;

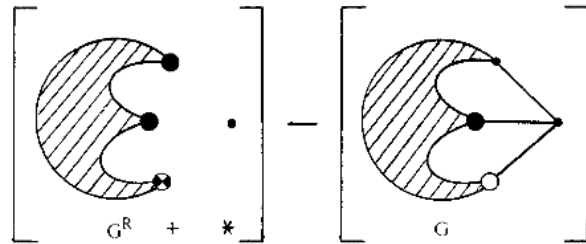
with edges joining these spots indicating adjacency of regions. The typical Left option is obtained by deleting a node of type ● or • and adding a red tint to all adjacent nodes; similarly for Right options.

We assert that for any  $G^L$  or  $G^R$  we must have

$$G^L + * \leq G \leq G^R + *$$



As an example, the latter inequality is proved by providing the obvious imitation strategy that wins for Left as second player in the difference game:



It follows that we have

$$\text{every } G^L \leq \text{every } G^R$$

Since these are simpler positions we know inductively that their values are either numbers or numbers plus Star. Call the best Left options  $x$  or  $x^*$ , and the best Right ones  $y$  or  $y^*$ . If  $x < y$ , then  $G$ 's value is a number by the Simplicity Rule. Otherwise  $G$  must be one of the two forms

$$\{x \mid x\} = x^* \quad \text{or} \quad \{x + * \mid x + *\},$$

since the condition  $G^L \leq G^R$  precludes such forms as

$$\{x \mid x + *\}.$$

### Col-lections and Col-lapsings

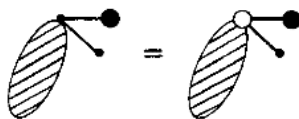
Here are the values of some Col positions in the above notation (Fig. 23), and some rules collected from ONAG, for simplifying larger positions.

1. You may omit piebald nodes and edges connecting oppositely tinted nodes without altering the value.
2. The value is unaltered or increased if you either

tint a node blue, or  
delete an edge ending in a blue tinted node.

(Similarly with “decreased” and “red”.)

- 3.

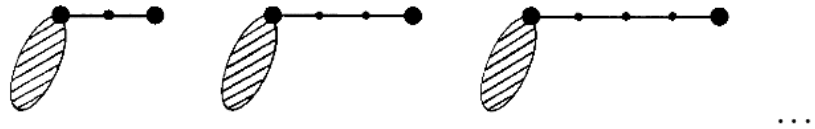




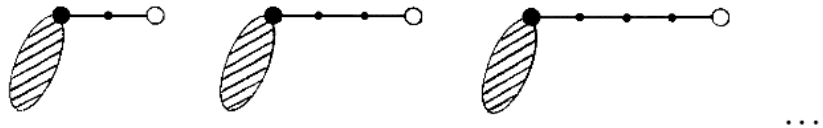
## 4. The positions



all have equal value  $A$ , say, and the corresponding positions

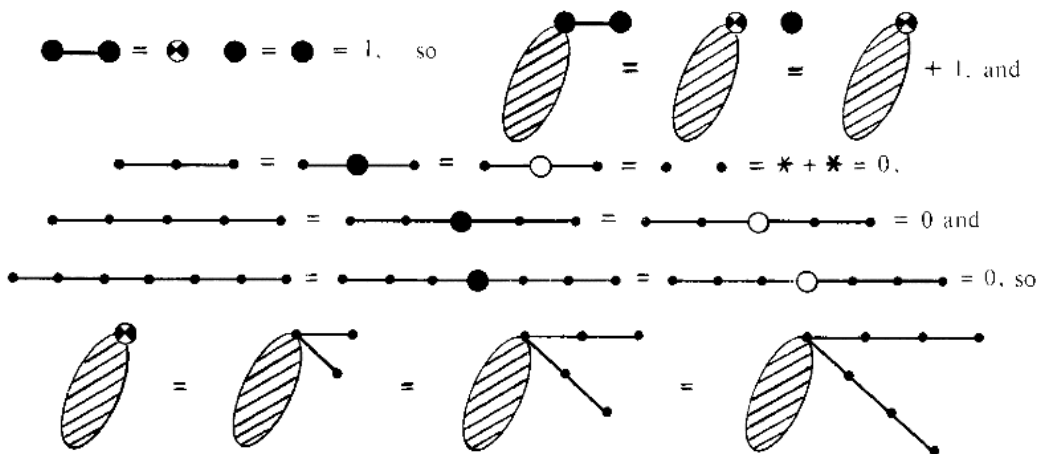


and these



have values  $A + \frac{1}{2}$  and  $A - \frac{1}{2}$  respectively.

5. If two joined untinted nodes are each connected to the same set of nodes, you may tint one blue and one red (and then delete their join).
6. If the value of a configuration is unaltered, both when a node is tinted blue and tinted red, it's **explosive** and you may delete that node, even when it joins the configuration to another. For example



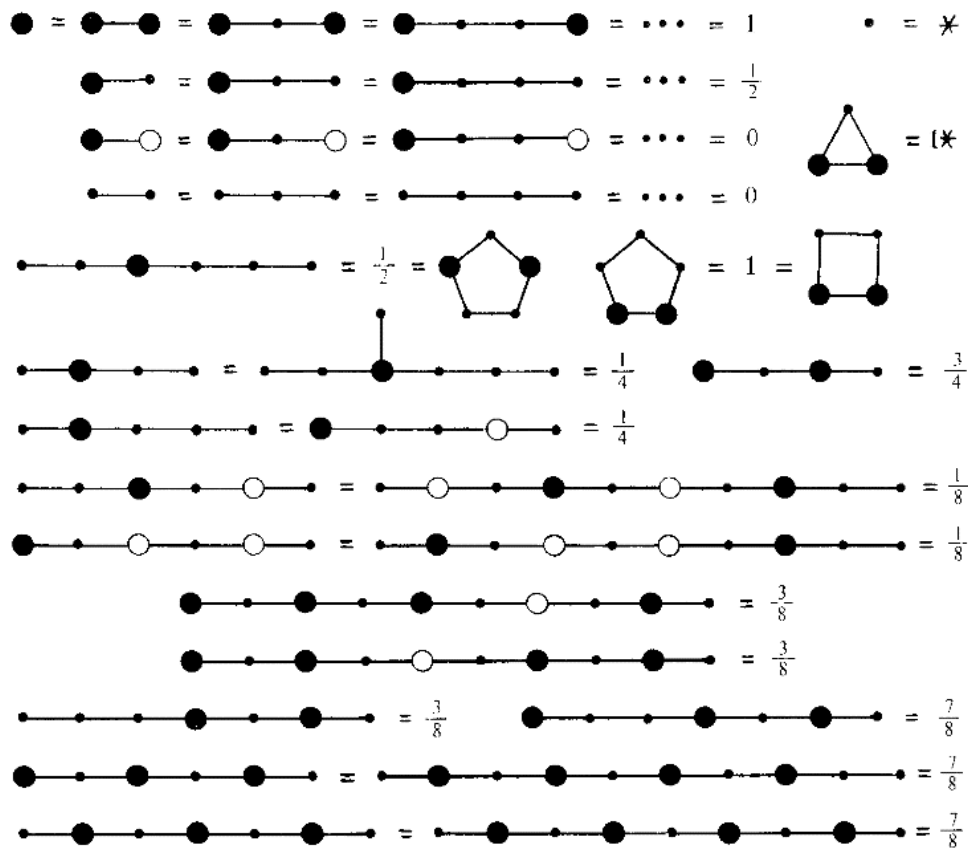
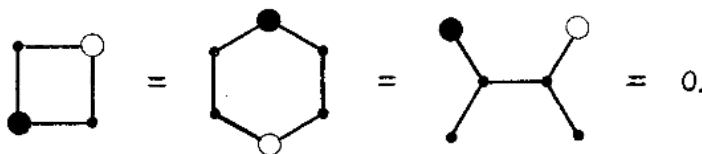


Figure 23. Some Col Values.

7. Other examples of explosive nodes are: any node in an untinted chain with at least three others on each side; and the ones indicated by the lightning bolts in



8. A configuration having a symmetry moving every node and reversing any tints has value 0. For example



Nick Inglis has shown that there are Col positions with arbitrarily large denominators.

## Maundy Cake

Here's how we work out the value  $M(r, l)$  of an  $r \times l$  cake ( $r$  rows,  $l$  columns):

$$\begin{array}{r}
 r = 999 : \quad 333 : \quad 111 : \quad 37 : \quad 1 \\
 l = 1000 : \quad 500 : \quad 250 : \quad 125 : \quad 25 : \quad 5 : \quad 1 \\
 M(999, 1000) = 5 + 1 = 6 \text{ for Lefty, i.e. } +6. \\
 \\
 r = 1000 : \quad 500 : \quad 250 : \quad 125 : \quad 25 : \quad 5 : \quad 1 \\
 l = 1001 : \quad 143 : \quad 13 : \quad 1 \\
 M(1000, 1001) = 25 + 5 + 1 = 31 \text{ for Rita, i.e. } -31.
 \end{array}$$

In every line you divide by the smallest possible prime to get the next number, stopping exactly when you get to 1. You then add the “leftovers” as in the examples, and assign the game to whoever has the longer sequence (so the value is 0 if Lefty's sequence is the same length as Rita's).

## Another Cutcake Variant

Dean Hickerson, who independently discovered the game of Cutcake, notes that if Lefty must make  $v$  vertical cuts at each turn, and Rita  $h$  horizontal ones, then the value of an  $r \times l$  cake is equal to that of an ordinary Cutcake of size  $\lceil \frac{r}{h} \rceil \times \lceil \frac{l}{v} \rceil$ . To make a table of values, start with a border of  $h$  by  $v$  rectangles in which the values are  $\lfloor (l-1)/v \rfloor$  along the top,  $1 \leq r \leq h$  and  $-\lfloor (r-1)/h \rfloor$  down the left side,  $1 \leq l \leq v$ .

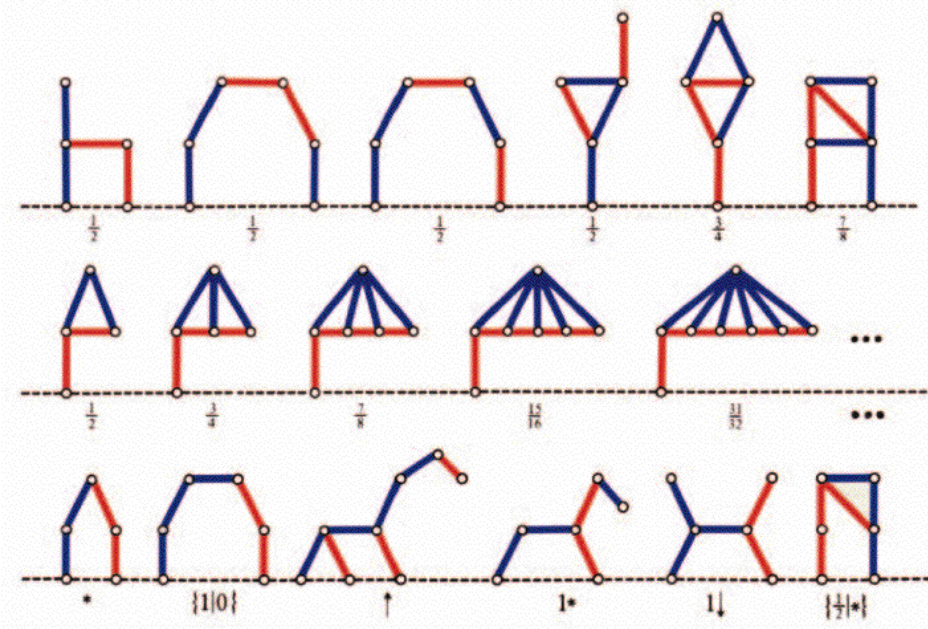
(The **ceiling** symbol,  $\lceil \ ]$ , and **floor** symbol,  $\lfloor \ ]$ , introduced by K. E. Iverson, and popularized by Donald Knuth, mean respectively, “least integer greater than or equal to” and “greatest integer less than or equal to”.)

## How Childish Can You Get?

When you compared the values in Fig. 20 with the ones in Fig. 18 of Chapter 1, you may have thought that not only are the pictures simpler for Childish Hackenbush, but that the values



are too. But this isn't always so, as you'll find out if you check the values in Fig. 24. The value at the end of the first row was found by Richard Austin, and for a long time we couldn't find one with a bigger denominator. Then Steve Tschantz came up with the sequence on the second row. Some positions aren't even numbers at all! You'll learn about the values in the third row in the next few chapters, and meet some more Childish Hackenbush positions in Chapters 6 and 8.



**Figure 24.** Childish Hackenbush Can Get Quite Playful!

## References and Further Reading

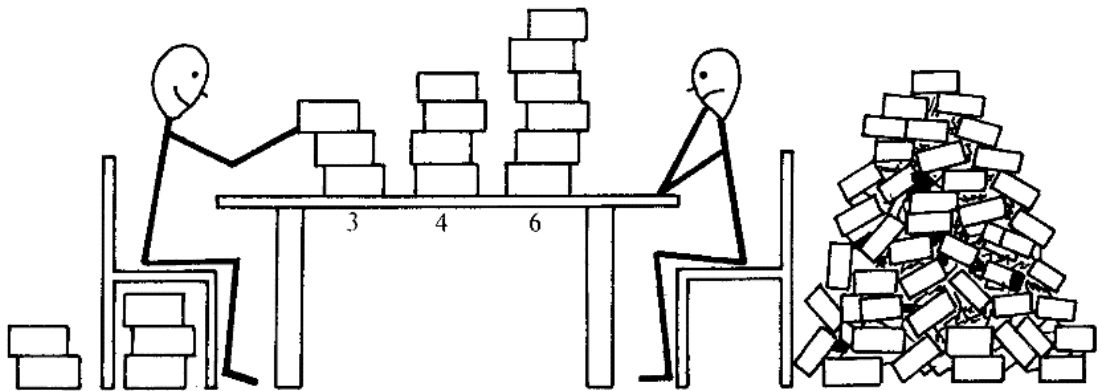
- Richard Austin, Impartial and Partizan Games, M.Sc. Thesis, The University of Calgary, 1976.  
 J. G. Baron, The game of nim—a heuristic approach, *Math. Mag.*, **47**(1974) 23–28.  
 C. L. Bouton, Nim, a game with a complete mathematical theory, *Ann. Math.*, Princeton(2) **3**(1902) 35–39.  
 D. W. Bushaw, On the name and history of Nim, *Washington Math.*, **11**(Oct.1966); reprinted *N.Y. State Math. Teachers J.*, **17**(1967) 52–55.  
 J. H. Conway, *On Numbers and Games*, Second Edition, A K Peters, Ltd., 2001.  
 J. H. Conway, All games bright and beautiful, *Amer. Math. Monthly*, **84**(1977) 417–434.  
 Martin Gardner, Mathematical Games, *Sci. Amer.*, (monthly from 1957–1981).  
 D. Moews, Sum of games born on days 2 and 3, *Theoret. Comput. Sci.*, **91**(1991), 119–128.  
 J. L. Walsh, The name of the game of Nim, *Math. Gaz.*, **37**(1953) 290.

# -3-

## Some Harder Games and How to Make Them Easier

Our life is frittered away by detail . . . Simplify, simplify.  
Henry David Thoreau, *Walden*.

Nim? Yes, yes, yes, let's nim with all my heart.  
John Byrom, *The Nimmers*, 27



**Figure 1.** A Well Advanced Game of Poker-Nim.

### Poker-Nim

This game is played with heaps of Poker-chips. Just as in ordinary Nim, either player may reduce the size of any heap by removing some of the chips. But now we allow a player the alternative move of increasing the size of some heap by adding to it some of the chips he acquired in earlier moves. The two kinds of move are the only ones allowed.

Let's suppose there are three heaps, of sizes 3, 4, 6 as in Fig. 1, and that the game has been going on for some time, so that both players have accumulated substantial reserves of



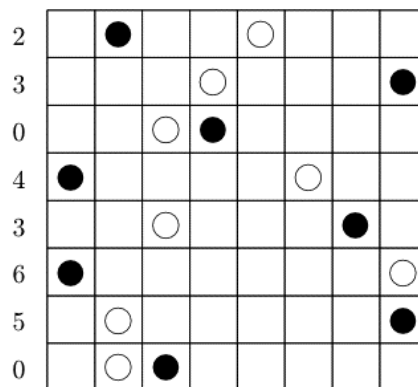
chips. It's Left's turn to move, and he moves to 2, 4, 6 since he remembers from Chapter 2 that this is a good move in ordinary Nim. But now Right adds 50 chips to the 4 heap, making the position 2, 54, 6, which is well beyond those discussed in Chapter 2.

This seems somewhat disconcerting, especially since Right has plenty more chips at his disposal, and doesn't seem too scared of using them to complicate the position. What does Left do? After a moment's thought, he just removes the 50 chips Right has just added and waits for Right's reply. If Right adds 1000 chips to one of the heaps, Left will remove them and restore the position to 2, 4, 6 again. Sooner or later, Right must reduce one of the three heaps (since otherwise he'll run out of chips no matter how many he has), and then Left can reply with the appropriate Nim-move.

So whoever can win a position in ordinary Nim can still win in Poker-Nim, no matter how many chips his opponent has accumulated. He replies to the opponent's reducing moves just as he would in ordinary Nim, and reverses the effect of any increasing moves by using a reducing move to restore the heap to the same size again. The new moves in Poker-Nim can only postpone defeat, not avoid it indefinitely. Since the effect of any of the new moves can be immediately reversed by the other player, we call them **reversible moves**.

## Northcott's Game

The same sort of thing happens in other games, often in better disguise. Northcott's game is played on a checkerboard which has one black piece and one white piece on each row, as in Fig. 2. You may move any piece of your own color to another empty square in the same row, provided you do not jump over your opponent's piece in that row. If you can't move (because all your pieces are trapped at the side of the board by your opponent's), you lose.



**Figure 2.** A Position in Northcott's Game.

This can seem an aimless game if you don't see the point, and indeed it usually goes on forever if it is played badly. But when you realize that it's only Nim in disguise once more, you'll soon be able to beat anybody pretty quickly. To the left of the board in Fig. 2 we have

shown the numbers of spaces between the two pieces in each row. When someone moves, just one of these numbers will be changed, and might be either increased or decreased, according as the move was retreating or advancing. But just as in Poker-Nim, any moves increasing one of the numbers can be reversed by the next player, and so are not much use.

Who wins in Fig. 2? We can see the zero-position 2, 4, 6 among the numbers shown, and of course the two numbers 3 form another zero. Neglecting the two rows that are already 0, the only other number is 5, and we maintain that the first player can win by moving so as to reduce this 5 to 0. Whenever the other player enlarges some gap by retreating, the first player should reduce it again by the same extent. In fact the winner should *always advance* on his opponent, *never retreat*.

It should not be thought that the moves we advise here are the only good ones. For example, from Fig. 2 instead of reducing 5 to 0, we could replace 6 by 3, 4 by 1 or even 3 by 6 in the second row (for White) or 0 by 5 in the last row (for Black). In fact it will help to avoid revealing the strategy if you do *not* always reply to a retreating move by the corresponding advance—for similar reasons occasional retreating moves might be desirable.

## Bogus Nim-Heaps and the Mex Rule

Consider the impartial game

$$G = \{ *0, *1, *2, *5, *6, *9 \mid *0, *1, *2, *5, *6, *9 \}.$$

This is a new kind of Nim-heap from which either player can move to a heap of size 0, 1, 2, 5, 6 or 9. In other words, we can regard it as a rather peculiar Nim-heap of size 3 (the first missing number) from which, as well as the usual moves to heaps of sizes 0 or 1 or 2, we are allowed to move to a heap of size 5 or 6 or 9. However, the Poker-Nim Argument shows that this extra freedom is in fact of no use whatever. To be more precise, suppose some player has a winning strategy in the game  $*3 + H + K + \dots$ . Then in the same circumstances he has one in  $G + H + K + \dots$ . When his strategy calls for a move in any of  $*3, H, K, \dots$ , that move is still available, and he need not use the new permitted moves from  $G$  to  $*5, *6$  or  $*9$ . If his opponent tries to do so, he can immediately reverse the effect of this move by moving back to  $*3$  (since 5, 6 and 9 are all greater than 3), and revert to the original strategy. So  $G$  can be replaced by  $*3$  without affecting either player's chances.

The same argument shows that any game of the form

$$G = \{ *a, *b, *c, \dots \mid *a, *b, *c, \dots \},$$

in which the same numbers appear on both sides, is really a Nim-heap in disguise. For if  $m$  is the least number from 0, 1, 2, 3,  $\dots$  that does *not* appear among the numbers  $a, b, c, \dots$ , then either player can still make from  $G$  any of the moves to  $*0, *1, *2, \dots, *(m-1)$  that he could make from  $*m$ . If his opponent makes any other move from  $G$ , it must be to some  $*n$  for which  $n > m$ , and can be reversed by moving back from  $*n$  to  $*m$ . So  $G$  is really just a bogus Nim-heap  $*m$ .



We summarize:

If Left and Right have exactly the same options from  $G$ ,  
 all of which are Nim-heaps  $*a, *b, *c, \dots$ ,  
 then  $G$  can itself be regarded as a Nim-heap,  $*m$ ,  
 where  $m$  is the least number 0 or 1 or 2 or  $\dots$   
 that is *not* among the numbers  $*a, *b, *c, \dots$ .

#### THE MINIMAL-EXCLUDED (MEX) RULE

This **minimal-excluded** number is called the **mex** of the numbers  $a, b, c, \dots$ .

### The Sprague-Grundy Theory for Impartial Games

The above result enables us to show that *every* impartial game can be regarded as a bogus Nim-heap. For suppose we have an impartial game

$$G = \{A, B, C, \dots \mid A, B, C, \dots\}.$$

Then  $A, B, C, \dots$  are simpler impartial games, and therefore we can suppose they have already been shown to be equivalent to Nim-heaps  $*a, *b, *c, \dots$ . But in this case  $G$  can be thought of as the Nim-heap  $*m$  defined above. This gives us

#### THE BOGUS NIM-HEAP PRINCIPLE

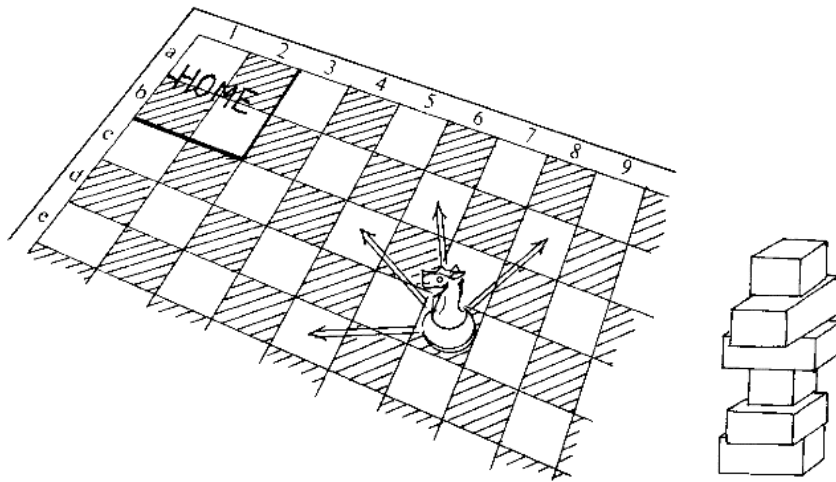
Every impartial game is just a bogus Nim-heap  
 (that is, a Nim-heap with reversible  
 moves added from some positions).  
 The Mex Rule gives the size of the heap for  $G$  as  
 the least possible number that is not the size of  
 any of the heaps corresponding to the options of  $G$ .

This principle was discovered independently by R. P. Sprague in 1936 and P. M. Grundy in 1939, although they did not state it in quite this way. This means that provided we can play the game of Nim, we can play *any* other impartial game given only a “dictionary” saying which **nimbers** (i.e. Nim-heaps) correspond to the positions of that game. Here’s a game played with a White Knight that gives a simple example of this dictionary method.

### The White Knight

The White Knight has, from any position on the chessboard, the moves shown in Fig. 3. You may recall that he was in the habit of losing his belongings. Alice has kindly boxed them up and the boxes now form the Nim-heap to the right of the figure. Now consider the game in which you can *either* move the Knight to one of the four places shown *or* steal some of the boxes. The game ends only when the Knight is on one of the four home squares and all the boxes have gone.



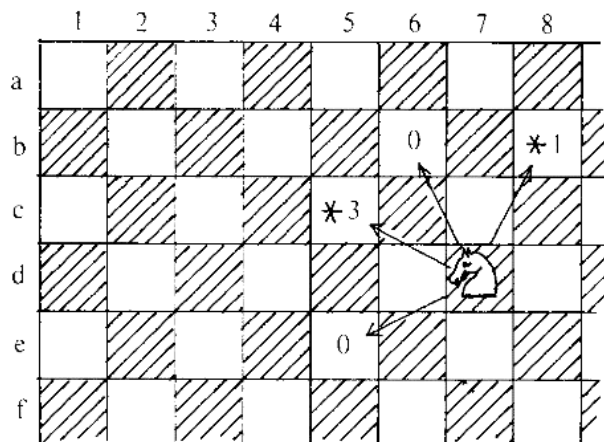


**Figure 3.** The White Knight and his Baggage.

The whole game is the result of adding a Nim-heap \*6 to a game with only the Knight. Table 1 shows which numbers correspond to the game with the Knight in various positions. Let's find the value of the Knight on d7 as in Fig. 3, assuming we already know the values of the four places he can move to. Figure 4 shows that these places can be thought of as bogus Nim-heaps of sizes

$$0, 3, 0, 1 \text{ (mex} = 2\text{)}$$

and so the present position corresponds to a bogus Nim-heap of size 2, value \*2. So the good move in Fig. 3 is to steal all but two of the boxes.



**Figure 4.** What the White Knight Moves are Worth.



	1	2	3	4	5	6	7	8	9	10	11	12	13	14	15	16	17	18	19	20
a	0	0	*1	*1	0	0	*1	*1	0	0	*1	*1	0	0	*1	*1	0	0	*1	*1
b	0	0	*2	*1	0	0	*1	*1	0	0	*1	*1	0	0	*1	*1	0	0	*1	*1
c	*1	*2	*2	*2	*3	*2	*2	*2	*3	*2	*2	*2	*3	*2	*2	*2	*3	*2	*2	
d	*1	*1	*2	*1	*4	*3	*2	*3	*3	*3	*2	*3	*3	*3	*2	*3	*3	*3	*3	*2
e	0	0	*3	*4	0	0	*1	*1	0	0	*1	*1	0	0	*1	*1	0	0		
f	0	0	*2	*3	0	0	*2	*1	0	0	*1	*1	0	0	*1	*1	0	0		
g	*1	*1	*2	*2	*1	*2	*2	*2	*3	*2	*2	*2	*3	*2	*2	*2	*3			
h	*1	*1	*2	*3	*1	*1	*2	*1	*4	*3	*2	*3	*3	*3	*2	*3	*3			
i	0	0	*3	*3	0	0	*3	*4	0	0	*1	*1	0	0	*1	*1				
j	0	0	*2	*3	0	0	*2	*3	0	0	*2	*1	0	0	*1	*1				
k	*1	*1	*2	*2	*1	*1	*2	*2	*1	*2	*2	*2	*3	*2						
l	*1	*1	*2	*3	*1	*1	*2	*3	*1	*1	*2	*1								
m	0	0	*3	*3	0	0	*3	*3	0	0										
n	0	0	*2	*3	0	0	*2	*3												
o	*1	*1	*2	*2	*1	*1														
p	*1	*1	*2	*3																
q	0	0																		

Table 1. Numbers for the White Knight.

## Adding Numbers

We saw in Chapter 2 that a Nim-heap of size 2 together with one of size 3 is equivalent to one of size 1. We now see that this was no accident, for the sum of *any* two Nim-heaps  $*a$  and  $*b$  is an impartial game, and so equivalent to *some* other Nim-heap  $*c$ . The number  $c$  is called the **nim-sum** of  $a$  and  $b$ , and written  $a \ddagger b$ . How can we work out nim-sums in general?

The options from  $*a + *b$  are all the positions of the form  $*a' + *b$  or  $*a + *b'$  in which  $a'$  denotes any number (from 0, 1, 2, ...) less than  $a$ , and  $b'$  any number (from 0, 1, 2, ... again) less than  $b$ . So  $a \ddagger b$  is the least number 0, 1, 2, ... not of either of the forms

$$a' \ddagger b, \quad a \ddagger b' \quad (a' < a, b' < b)$$

Table 2 was computed using this rule. For example the entry  $6 \ddagger 3$  was computed as follows. The earlier entries 3, 2, 1, 0, 7, 6 in column 3 correspond to the options  $*6' + *3$  (where  $6'$  means one of 0, 1, 2, 3, 4, 5) and the earlier entries 6, 7, 4 in row 6 correspond to options

0	1	2	3	4	5	6	7	8	9	10	11	12	13	14	15
1	0	3	2	5	4	7	6	9	8	11	10	13	12	15	14
2	3	0	1	6	7	4	5	10	11	8	9	14	15	12	13
3	2	1	0	7	6	5	4	11	10	9	8	15	14	13	12
4	5	6	7	0	1	2	3	12	13	14	15	8	9	10	11
5	4	7	6	1	0	3	2	13	12	15	14	9	8	11	10
6	7	4	5	2	3	0	1	14	15	12	13	10	11	8	9
7	6	5	4	3	2	1	0	15	14	13	12	11	10	9	8
8	9	10	11	12	13	14	15	0	1	2	3	4	5	6	7
9	8	11	10	13	12	15	14	1	0	3	2	5	4	7	6
10	11	8	9	14	15	12	13	2	3	0	1	6	7	4	5
11	10	9	8	15	14	13	12	3	2	1	0	7	6	5	4
12	13	14	15	8	9	10	11	4	5	6	7	0	1	2	3
13	12	15	14	9	8	11	10	5	4	7	6	1	0	3	2
14	15	12	13	10	11	8	9	6	7	4	5	2	3	0	1
15	14	13	12	11	10	9	8	7	6	5	4	3	2	1	0

**Table 2.** A Nim-Addition Table.

$*6 + *3'$  ( $3'$  means 0, 1 or 2). The least number not observed earlier in either row or column is 5, so  $6 \ddagger 3 = 5$ , i.e.  $*6 + *3 = *5$ . It might help you to follow how the table is computed if you look at the game in which our White Knight is replaced by a White Rook which can only move North or West.

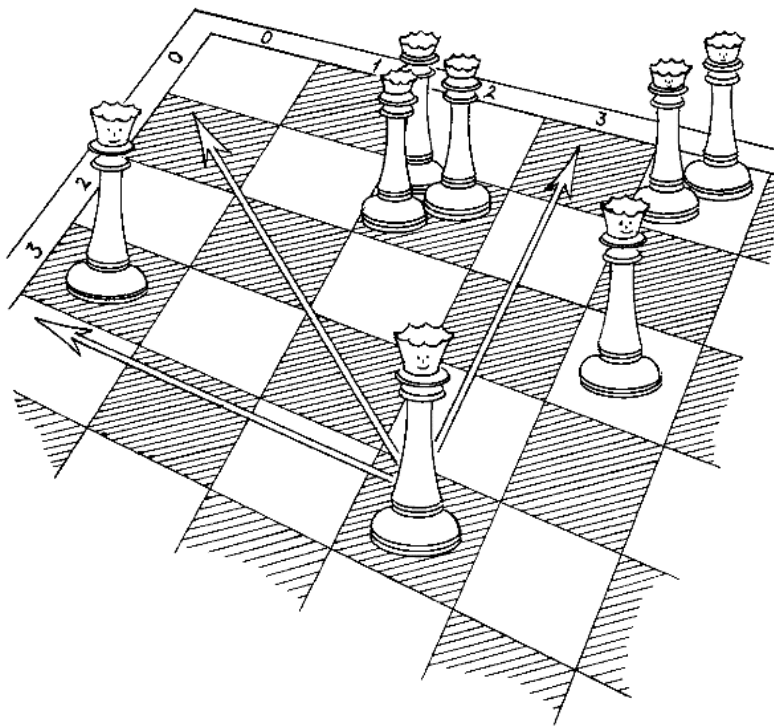
You'll find a general Nim-Addition Rule in the Extras, and will have many opportunities to apply it; for example, in Chapters 4, 12, 14 and 15.

## Wyt Queens

In the game of Wyt Queens any number of Queens can be on the same square and each player, when it is her turn to move, can move any single Queen an arbitrary distance North, West or North-West as indicated, even jumping over other Queens.

Because the Queens move independently, we can regard the whole game as the sum of smaller ones with just one Queen. The various Queens on the board will therefore correspond to nim-heaps  $*a, *b, *c, \dots$  which we can add using the Nim-Addition Rule. Try computing the nimber dictionary for this game—when you get tired you can look in the Extras for more information.

The one-Queen game is a transformation of **Wythoff's Game** (1905) played with two heaps in which the move is to reduce *either* heap by *any* amount, or *both* heaps by the *same* amount. We'll meet Wyt Queens again in Chapters 12 and 13.



**Figure 5.** How the Wyt Queens Move.

## Reversible Moves in General Games

What does it mean for some move to be reversible in an arbitrary game  $G$ ? We shall suppose that Right's move to  $D$  is reversible in the game

$$G = \{A, B, C, \dots \mid D, E, F, \dots\}.$$

This will mean that there is some move for Left from  $D$  to a left option  $D^L$  which is at least as good for Left as  $G$  was, i.e.  $D^L \geq G$ . Then if ever Right moves from  $G$  to  $D$ , Left can at least reverse the effect by moving back from  $D$  to  $D^L$ , and might even improve his position by doing so. We shall suppose that  $D^L$  is the game

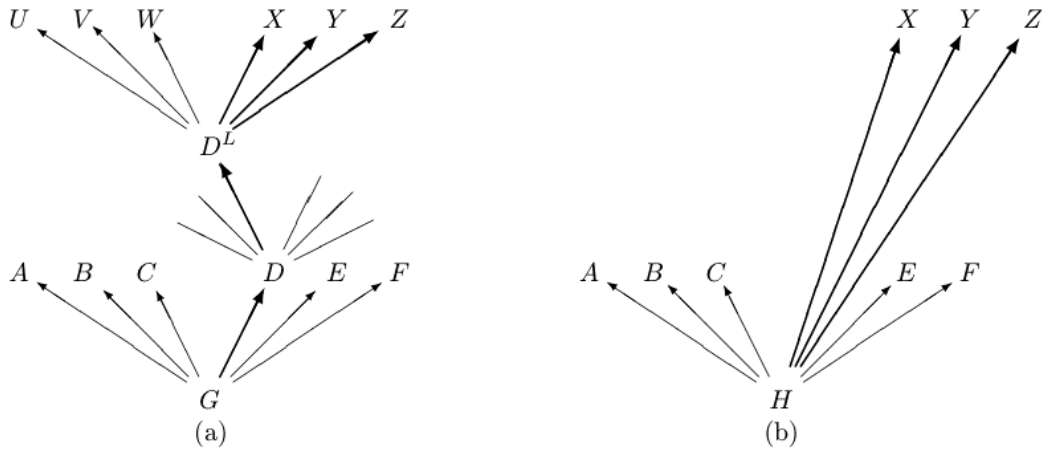
$$D^L = \{U, V, W, \dots \mid X, Y, Z, \dots\}$$

so that  $G$  looks something like Fig. 6(a).

Now whenever Right plays from  $G$  to  $D$ , Left will reverse from  $D$  to  $D^L$ , from which Right can move to any of  $X, Y, Z, \dots$ . So we might as well shorten  $G$  by omitting Right's move to  $D$  and letting him move directly to  $X$  or  $Y$  or  $Z$  or  $\dots$ . In this way we get the game

$$H = \{A, B, C, \dots \mid X, Y, Z, \dots, E, F, \dots\},$$

shown in Fig. 6(b), which should have the same value as  $G$ .



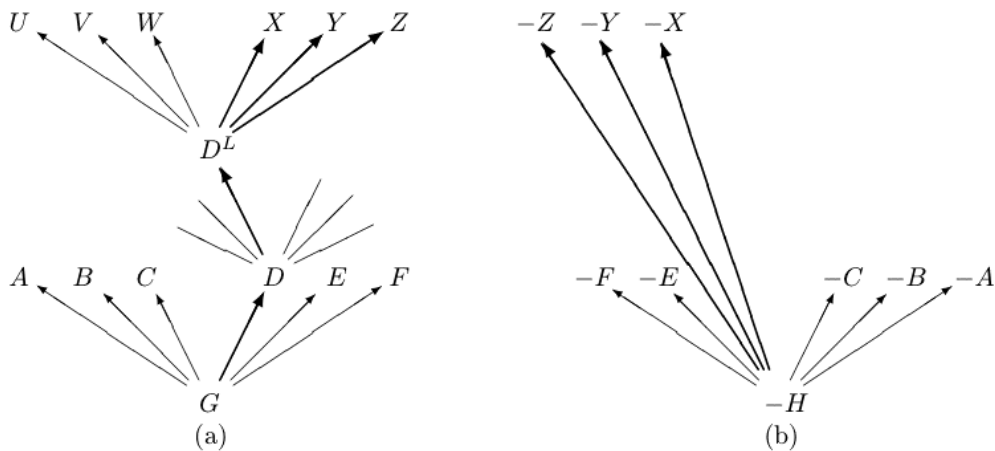
**Figure 6.** Bypassing a Reversible Move.

We can easily test this by playing the game  $G - H$ , that is

$$\{A, B, C, \dots \mid D, E, F, \dots\} + \{-X, -Y, -Z, \dots, -E, -F, \dots \mid -A, -B, -C, \dots\},$$

shown in Fig. 7, and verifying that there is no good move for either player as follows.

Obviously the moves from  $G$  to  $A, B, C, \dots$  or  $E, F, \dots$  are exactly countered by moves to their negatives from  $-H$ , and conversely, so that the only hopeful moves are those for Left from  $-H$  to  $-X$  or  $-Y$  or  $-Z$  or  $\dots$ , and that for Right from  $G$  to  $D$ .



**Figure 7.** A Zero Game.



Left's hopes are soon dashed. His move from  $-H$  to  $-X$ , say, leaves the total position  $G - X$ , worse for him than  $D^L - X$ , which Right can win by moving from  $D^L$  to  $X$ . There remains Right's move from  $G$  to  $D$ , which Left will reverse to  $D^L$ , leaving the total position  $D^L - H$ , namely:

$$\{U, V, W, \dots \mid X, Y, Z, \dots\} + \{-X, -Y, -Z, \dots, -E, -F, \dots \mid -A, -B, -C, \dots\}.$$

Now Right dare not move from  $D^L$  to  $X$  or  $Y$  or  $Z$  or  $\dots$ , since Left can counter by moving from  $-H$  to the corresponding one of  $-X$  or  $-Y$  or  $-Z$  or  $\dots$ . So Right's only hope is to move from  $-H$ , leaving the total position  $D^L - A$  or  $D^L - B$  or  $D^L - C$  or  $\dots$ . But since  $D^L \geq G$  these are at least as bad for Right as  $G - A$ ,  $G - B$ ,  $G - C$ ,  $\dots$ , which Left can win by moving in  $G$  to the appropriate one of  $A$  or  $B$  or  $C$  or  $\dots$ .

Since we have now dealt with all possible first moves,  $G - H$  is a zero game, and we can afford to replace  $G$  by  $H$  in any of our calculations, which will often be a very valuable simplification. We summarize:

If any Right option  $D$  of  $G$  has itself a Left option  $D^L \geq G$ , then it will not affect the value of  $G$  if we replace  $D$  as a Right option of  $G$  by all the Right options  $X, Y, Z, \dots$  of that  $D^L$ .

#### BYPASSING RIGHT'S REVERSIBLE MOVE

Of course a move by Left can also be reversible:

If any Left option  $C$  of  $G$  has itself a Right option  $C^R \leq G$ , then it will not affect the value of  $G$  if we replace  $C$  as a Left option by the list of all Left options of that  $C^R$ .

#### BYPASSING LEFT'S REVERSIBLE MOVE

## Deleting Dominated Options

Now there is another kind of simplification we've already mentioned, which it would be wise to discuss more precisely here. In the game

$$G = \{A, B, C, \dots \mid D, E, F, \dots\},$$

if  $A \leq B$  we say that  $A$  is **dominated** by  $B$ , and if  $D \leq E$ , that  $E$  is dominated by  $D$ . In other words, given two possible moves for the same player, one dominates the other if it is at least as good for the person making it. Then we can simplify by *omitting dominated moves* (provided we retain the moves that dominate them). In the case discussed, this will mean that  $G$  has the same value as the game

$$K = \{B, C, \dots \mid D, F, \dots\}.$$

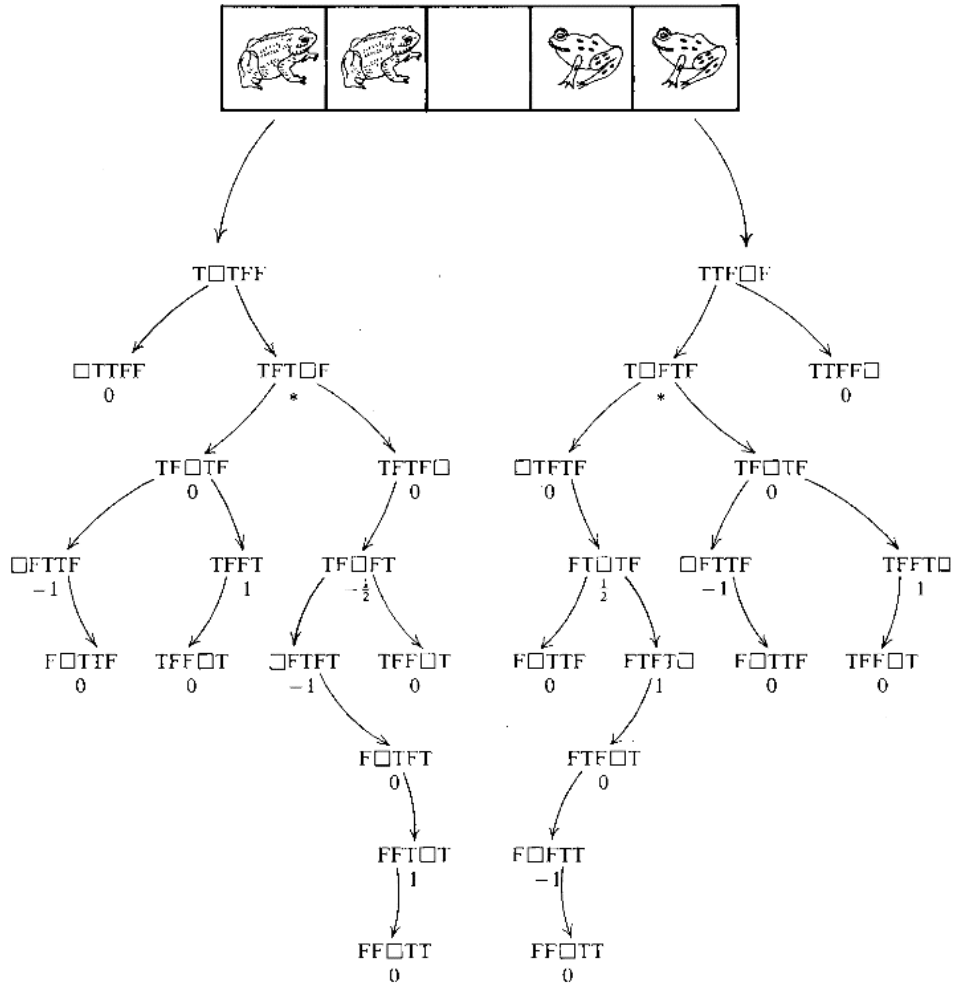
And indeed,  $G - K$  is a zero game, since the moves from  $G$  to  $A$  or  $E$  are countered by those from  $-K$  to  $-B$  or  $-D$ , and all other moves in either component are countered by moves to their negatives from the other.

It won't affect the value of  $G$   
if we delete dominated options  
but retain the options that dominated them.

### DELETING DOMINATED OPTIONS

But remember that *reversible* options are *not* deleted, but *bypassed*, i.e., replaced by the list of options, for the appropriate player, from the position his opponent reverses to.

### Toads-and-Frogs with Ups and Downs



**Figure 8.** Anatomy of Toads-and-Frogs.



We considered a 4-place version of this game in Chapter 1. The 5-place version we now consider displays more interesting behavior. In any 5-place lane Left may move one of his toads one space right, onto an empty square, or jump over just one frog onto an empty square immediately beyond. Right's moves are similar, moving his frogs leftwards. Figure 8 shows the complete play from the initial position in which the two toads are separated by just one space from two frogs. We already know how to evaluate, working upwards, all positions except the top three.

The next position to be considered is

$$T \square T F F = \{ \square T T F F \mid T F T \square F \} = \{ 0 \mid * \}.$$

Since 0 is a loss for the player to move from it, Left can win this game by moving to 0, and Right's move to \* does not win since Left will reply to 0. So  $\{ 0 \mid * \}$  is a positive game. But since \* is less than each of the numbers

$$2, \quad 1, \quad \frac{1}{2}, \quad \frac{1}{4}, \quad \dots$$

$\{ 0 \mid * \}$  is less than or equal to each of

$$\{ 0 \mid 2 \}, \{ 0 \mid 1 \}, \{ 0 \mid \frac{1}{2} \}, \{ 0 \mid \frac{1}{4} \}, \dots$$

that is, each of

$$1, \quad \frac{1}{2}, \quad \frac{1}{4}, \quad \frac{1}{8}, \quad \dots$$

So we have here a positive value less than every positive number. Since we have not seen such a thing before, we cannot hope to simplify it, and we therefore need a new name.  $\uparrow$ , pronounced "**up**".

Similarly, the position  $T F F \square F$ , obtained by interchanging the roles of Left and Right, has the value  $\{ * \mid 0 \}$  which is negative, but greater than any negative number. Since \* is its own negative,  $\{ * \mid 0 \}$  is the negative of  $\{ 0 \mid * \}$  and we call it  $\downarrow$ , pronounced "**down**". By the end of the book we shall have had many ups and downs!

So the starting position of Fig. 8 has value

$$T T \square F F = \{ T \square T F F \mid T F F \square F \} = \{ \uparrow \mid \downarrow \}.$$

Do we need a new name for this? Let's first see if we can simplify it. Since each player has only one option, no move dominates another, so we next look for reversible moves. Is Right's move to  $\downarrow$  reversible from the game  $G = \{ \uparrow \mid \downarrow \}$ ? This happens only if there is some Left option  $\downarrow^L \geq G$ . Since  $\downarrow = \{ * \mid 0 \}$  we are asking if  $* \geq G$ , i.e. if  $G - * \leq 0$ . Has Left a winning move from

$$G - * = \{ \uparrow \mid \downarrow \} + \{ 0 \mid 0 \} ?$$

His move from \* to 0 is parried by Right's reply from  $G$  to  $\downarrow$ , and his move from  $G$  to  $\uparrow$  is countered by Right's response from  $\uparrow$  to \*, which leaves the total value  $* + * = 0$ . So indeed if Left starts Right wins, showing that  $G - * \leq 0$ . This means that Right can bypass his move to  $\downarrow$  by moving directly from  $G$  to  $\downarrow^{LR} = *^R = 0$ , and shows that  $G = \{ \uparrow \mid 0 \}$ . In this Left can also bypass his move so that  $G$  simplifies further to  $\{ 0 \mid 0 \} = *$ .

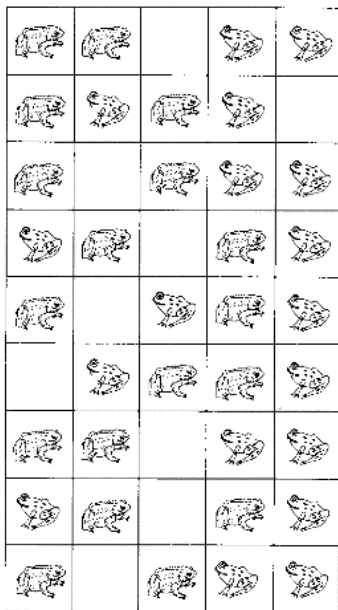
$$\boxed{\{ \uparrow \mid \downarrow \} = \{ \uparrow \mid 0 \} = \{ 0 \mid \downarrow \} = \{ 0 \mid 0 \} = *}$$

We could otherwise have seen that  $G = *$  by observing that Right also had no winning move from  $G - *$ . However, for a more complicated  $G$  we can ask which moves are reversible even before we have guessed the simplest form of  $G$ .



## Game Tracking and Identification

Much of this book is about finding out who wins various partizan games from arbitrary positions. **Partizan** games, we recall from the Extras to Chapter 1, are those in which the options available to the two players are not necessarily the same. For example, to find the winner in the 9-lane 5-place Toads-and-Frogs position of Fig. 9, we must work with sums of terms whose values may be  $\uparrow$ ,  $\downarrow$ ,  $*$ , or various numbers. When stalking other game we shall need to know how to add even more general values and find when the result is positive, negative, zero or fuzzy. We learned how to add *numbers* at school and we can add any small enough *numbers* using our nim-addition table (Table 2). We also know that  $x + * = \{x \mid x\} = x*$  for any number  $x$ . So perhaps the simplest pair of values we have not yet added are  $\uparrow$  and  $*$ . We shall call their sum  $\uparrow*$ . Is it perhaps equal to  $\{\uparrow\uparrow\}$ ?



**Figure 9.** Toads and Frogs make easy Big Game.

We can always test for equality of two values by seeing if their difference is a win for the second player. Is this true of the difference game

$$\{\uparrow\uparrow\} - \uparrow* = \{\uparrow\uparrow\} + \overset{\downarrow}{\{*\mid 0\}} + \overset{*}{\{0\mid 0\}}$$

do you think? No! If Left makes his move to  $*$  from the component  $\downarrow$ , the total value becomes  $\{\uparrow\uparrow\} + * + * = \{\uparrow\uparrow\}$  which is clearly positive, since Left can win and Right can't. In fact it turns out that Right has no good move from  $\{\uparrow\uparrow\} - \uparrow*$  so that  $\{\uparrow\uparrow\}$  is strictly greater than  $\uparrow*$ .



We shall find a correct formula for  $\uparrow*$ . From the definition of the sum of two games we have, by considering the moves of Left and Right in the two components,

$$\uparrow* = \uparrow + * = \{0 + *, \uparrow + 0 \mid * + *, \uparrow + 0\} = \{*, \uparrow \mid 0, \uparrow\}$$

using the equation  $* + * = 0$ . We can simplify this to

$$\uparrow* = \{\uparrow, * \mid 0\}$$

since Right's option  $\uparrow$  was dominated by his other option, 0. Neither of Left's options dominates the other, for from their difference  $\uparrow - * = \uparrow + *$ , Left can win by moving to  $\uparrow + 0$  and Right by moving to  $* + *$ .

However, Left's option  $\uparrow$  is reversible by Right through  $\uparrow^R = *$ , for plainly  $* \leq \uparrow*$ . So we can bypass  $\uparrow$  by allowing Left to move directly to  $\uparrow^{RL} = *^L = 0$ , without affecting the value of the game. We therefore have the equation

$$\uparrow* = \uparrow + * = \{0, * \mid 0\}$$

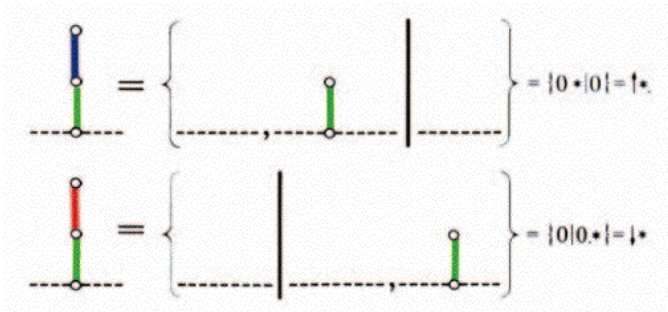
and similarly its negative

$$\downarrow* = \downarrow + * = \{0 \mid 0, *\}$$

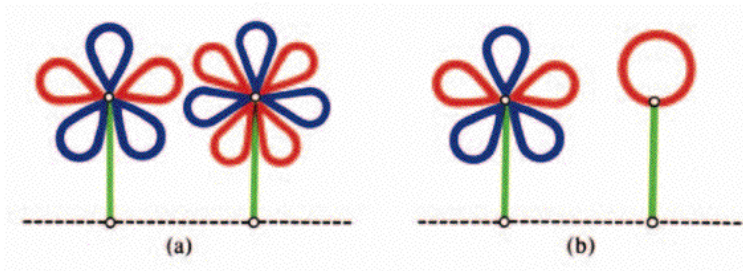
We have put these in boxes because they are in fact the simplest forms. They have no dominated or reversible options.

### What Are Flowers Worth?

We can now evaluate some simple Hackenbush Hotchpotch positions:



A prettier position is the flower of Fig. 5(a) in Chapter 2. More generally we can consider such flowers with any numbers of red and blue petals, as in Fig. 10(a). Which player will win the sum of two flowers of this kind?

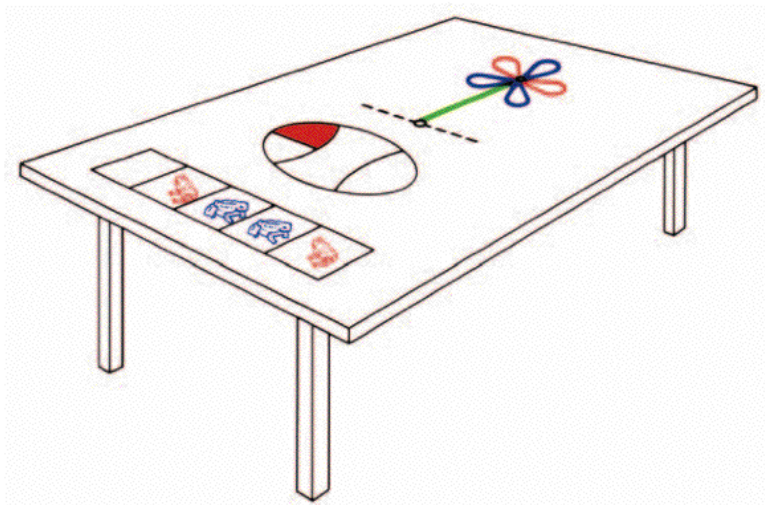


**Figure 10.** Two Flower Shows Ready for Judging.

Here it is easy to see that whoever first chops one of the two green stalks will lose, for his opponent will chop the other. So this kind of game reduces to “She-Loves-Me, She-Loves-Me-Not”, this time played on the red and blue colored petals. Whichever of Left and Right is first unable to remove a petal of his color will lose, since his only other options are the stalks. So in a two-flower position the player having the larger number of petals of his own color will win, except that if there are as many red as blue petals in all, the second player will win, for his opponent must take the first petal and hence the first stalk.

This argument proves that Fig. 10(b) is a zero game, for each player has three petals in all, and it establishes that the value of the flower of Fig. 5(a) in Chapter 2 is  $\uparrow + *$ , since the one-petal flower in Fig. 10(b) has the value  $\downarrow + *$  (the petal can be uncurled without affecting play, like a snake’s head).

## A Gallimaufry of Games



**Figure 11.** A Gallimaufry of Games.



Left and Right will soon return to the table shown in Fig. 11, on which they have been playing the sum of three games, namely Hackenbush Hotchpotch, Col, and Toads-and-Frogs. You can be sure that they will be unable to agree whose turn it was to move. Will it matter?

## Who Wins Sums of Ups, Downs, Stars, and Numbers?

A 5-place Toads-and-Frogs position with any number of lanes has a value which is the sum of terms from

$$0, 1, -1, \frac{1}{2}, -\frac{1}{2}, *, \uparrow \text{ and } \downarrow$$

To work out who wins we need rules telling us when such a sum is positive, negative, zero or fuzzy. Using the equations  $* + * = 0$ , and  $\downarrow = -\uparrow$ , any such sum reduces to a form  $x + n.\uparrow$  or  $x + n.\uparrow + *$ , where  $x$  is a number and  $n$  is an integer which may be positive, negative or zero. The rules (valid for arbitrary numbers  $x$ ) are:

If  $x$  is any number, then  $x + n.\uparrow$  is  
*positive*, if  $x$  is positive, or  $x$  is zero and  $n \geq 1$ ;  
*negative*, if  $x$  is negative, or  $x$  is zero and  $n \leq -1$ ;  
 and *zero*, only if  $x$  and  $n$  are both zero.

If  $x$  is any number, then  $x + n.\uparrow + *$  is  
*positive*, if  $x$  is positive, or  $x$  is zero and  $n \geq 2$ ;  
*negative*, if  $x$  is negative, or  $x$  is zero and  $n \leq -2$ ;  
 and *fuzzy*, if  $x$  is zero and  $n = -1, 0$  or  $1$ .

In these rules  $n.\uparrow$  denotes the sum of  $n$  copies of  $\uparrow$  or  $-n$  copies of  $\downarrow$ . We usually abbreviate  $2.\uparrow$  to  $\uparrow\uparrow$ , pronounced “**double-up**”, and write  $\uparrow*$  for  $\uparrow + *$ , etc.

The proofs require only the observations we have already made that  $*$  is fuzzy and  $\uparrow$  positive and that both are dominated by any positive number, together with the observations that  $\uparrow*$  is fuzzy but  $\uparrow* = \uparrow + \uparrow + *$  is positive.

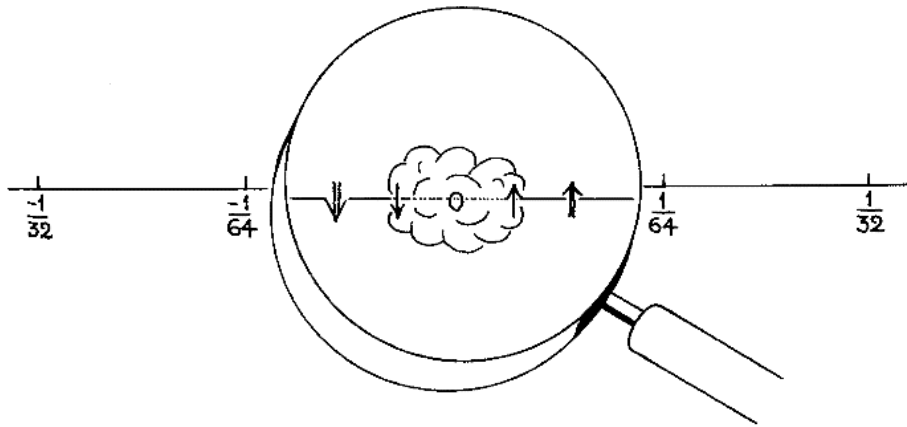
To see that  $\uparrow*$  is fuzzy we need only observe that from the equivalent form  $\{0, * \mid 0\}$  each player has a winning move to 0. From

$$\uparrow* = \{0 \mid \overset{\uparrow}{*}\} + \{0 \mid \overset{\uparrow}{*}\} + \{0 \mid \overset{*}{0}\}$$

Right’s only options are to replace a component  $\uparrow$  by  $*$ , leaving a total of  $\uparrow + * + * = \uparrow$ , or to replace  $*$  by 0, leaving  $\uparrow$ . Since both of these are positive, Right has no winning option, so that  $\uparrow* \geq 0$ . Since  $\uparrow$  is positive it cannot equal  $*$ , so  $\uparrow*$  must be strictly positive. In fact Left wins by replacing  $*$  by 0, leaving the positive remainder  $\uparrow$ .

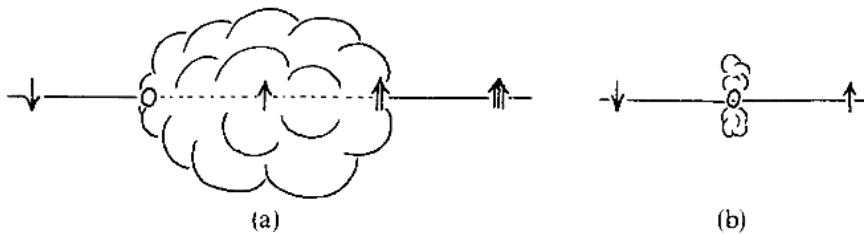
## A Closer Look at the Stars

We have now asquired a better idea of how fuzzy  $*$  really is, for we have shown that it is *less than*  $\uparrow\uparrow = \uparrow + \uparrow$ , *greater than*  $\downarrow\downarrow = \downarrow + \downarrow$ , but *confused with* each of  $\downarrow$ , 0,  $\uparrow$ . The cloud (Fig. 12) under which it is hiding, although it covers only one *number*, 0, can now be seen to have a radius of at least  $\uparrow$ .



**Figure 12.** Star, Seen Through a Glass, Darkly.

We can examine other small games using similar devices. Figure 13(a) shows  $\uparrow^*$ , obtained by adding  $\uparrow$  to Fig. 12. Figure 13(b) will serve for any  $^*n$  with  $n \geq 2$ .



**Figure 13.** The Whereabouts of  $\uparrow^*$  and of  $^*n$  ( $n \geq 2$ ).

### The Values $\{\uparrow|\uparrow\}$ and $\{0|\uparrow\}$

In more complicated positions,  $\uparrow$  and  $\downarrow$  frequently arise as options. For example, we have already seen that  $\{\uparrow|\downarrow\} = \{\uparrow|0\} = \{0|\downarrow\} = *$ , and enquired about the position  $\{\uparrow|\uparrow\}$ .

The value  $\{0|\uparrow\}$  arises from the 7-place Toads-and-Frogs position of Fig. 14, in which the four positions marked 0 may be checked to be second player wins. How big are  $\{\uparrow|\uparrow\}$  and  $\{0|\uparrow\}$ ?

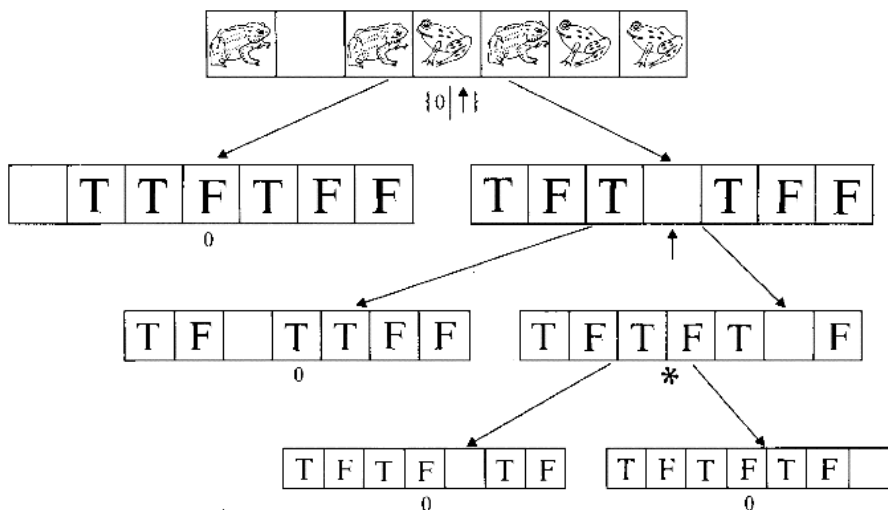


Figure 14. Up Among the Toads and Frogs.

We first examine  $\{\uparrow|\uparrow\} = X$ , say. Right's option of  $\uparrow$  will only be reversible if there is some  $\uparrow^L \geq X$ , i.e. if  $0 \geq X$ , which we know to be false. As a Left option,  $\uparrow$  will be reversible if there is some  $\uparrow^R \leq X$ , i.e. if  $* \leq X$ , which is true since

$$* = \{0 | 0\} \leq \{\uparrow|\uparrow\} = X.$$

So we can bypass, replacing  $\uparrow$  by  $*^L = 0$ , to obtain  $X = \{0|\uparrow\}$ , the value of Fig. 14, proving that our two questions were the same. Since 0 has no Right option there will be no further simplification.

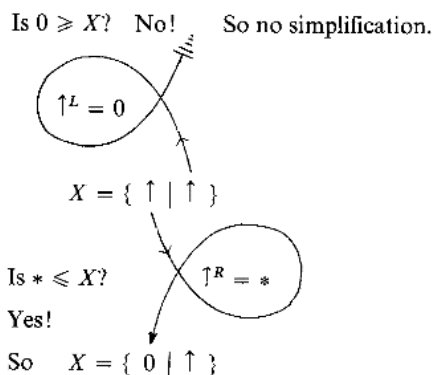


Figure 15. Searching for Reversible Moves.

For a general  $X$ , each player must ask if to any one of his opponent's options from  $X$  he has a response  $Y$  which is at least as good for him as  $X$  was. If so, he replaces that option by the list of all his opponent's options from  $Y$ . Figure 15 shows a graphical way of asking these questions that we have often found useful. The arrows are curved so as to remind us which players make which of the moves we hope to bypass.

## The Upstart Equality

How big is  $X = \{0 \uparrow\}$  on our microscopic scale? It is certainly less than  $4\uparrow$  (the sum of four copies of  $\uparrow$ ), since in the difference  $X + 4\downarrow$ , Right can move from  $X$  to  $\uparrow$  at his first opportunity and there will be at least two  $\downarrow$  components, even after cancelling  $\uparrow$  with  $\downarrow$ . By a similar move Right can win  $x + 3\downarrow$  if he moves first. However, Left can also win this moving first if he replaces  $\downarrow$  by  $*$ , leaving

$$X + \downarrow* = \{0 \uparrow\} + \{*\downarrow\} + \{*\downarrow\} + \{0\downarrow\}$$

To see this, recall that we already know that  $X$ , alias  $\{\uparrow\uparrow\}$ , is strictly greater than  $\uparrow*$ , so Left wins if Right replaces a  $\downarrow$  by 0, while if Right replaces  $*$  by 0, Left can win by replacing a  $\downarrow$  by  $*$ . Right's only other option is from  $X$  to  $\uparrow$  leaving a fuzzy total of  $\downarrow*$ .

The argument has shown that  $X$  is confused with  $3\uparrow$ , and so with  $\uparrow\uparrow$  and  $\uparrow$ , since even from  $X + \downarrow$  Left has a winning move (to  $X + *$ ). We now know all order relations between  $X$  and values of the form  $n\uparrow$ . How does it compare with values  $n\uparrow + *$ ? Since it is greater than  $\uparrow*$  we compare it with  $\uparrow*$ . In the difference  $X + \downarrow*$ , displayed above, we have already dismissed all Right's options. However, Left's option from  $X$  leaves the negative total  $\downarrow*$ ; his option from  $\downarrow$  leaves the fuzzy total  $X + * + \downarrow + * = X + \downarrow$ , while that from  $*$  leaves another fuzzy total  $X + \downarrow$ , so all Left's options can be dismissed too! This gives us the remarkable identity

$$\boxed{\{0 \uparrow\} = \uparrow + \uparrow + * = \uparrow*}$$

The theory of partizan games is notable for the occurrence of such surprising identities. Although the pattern in Table 3 extends naturally in both directions, some of the middle entries are far from immediately obvious. In the last column  $*n$  denotes the number  $\{0, *, \dots, *(n-1) \mid o, *, \dots, *(n-1)\}$  for some  $n \geq 2$  and  $m = n \uparrow 1$ ;  $\uparrow*n$  denotes  $\uparrow + *n$ , etc.

In particular, these relationships allow us to obtain a tractable expression for Toads-and-Frogs positions of the form

$$(\text{TF})^x \text{T} \square (\text{TF})^n \text{F}$$

Omar will already notice that the Toad move gives a position of value 0; our less assiduous readers will find that this is a consequence of a more general result in Chapter 5. It follows that

$$(\text{TF})^x \text{T} \square (\text{TF})^n \text{F} = \{0 \mid (\text{TF})^{x+1} \text{T} \square (\text{TF})^{n-1} \text{F}\}$$

which equals  $n.\uparrow + (n+1).*$  by induction on  $n$  (and doesn't depend on  $x$ ).



$3.\downarrow = \{\downarrow * \mid 0\}$	$3.\downarrow + * = \{\downarrow \mid 0\}$	$3.\downarrow + * n = \{\downarrow * m \mid 0\}$
$\downarrow = \{\downarrow * \mid 0\}$	$\downarrow * = \{\downarrow \mid 0\}$	$\downarrow * n = \{\downarrow * m \mid 0\}$
$\downarrow = \{ * \mid 0\}$	$\downarrow * = \{0 \mid 0, *\}$	$\downarrow * n = \{ * m \mid 0\}$
$0 = \{ \mid \}$	$* = \{0 \mid 0\}$	
$\uparrow = \{0 \mid *\}$	$\uparrow * = \{0, * \mid 0\}$	$\uparrow * n = \{0 \mid * m\}$
$\uparrow = \{0 \mid \uparrow\}$	$\uparrow * = \{0 \mid \uparrow\}$	$\downarrow * n = \{0 \mid \uparrow * m\}$
$3.\uparrow = \{0 \mid \uparrow *\}$	$3.\uparrow + * = \{0 \mid \uparrow\}$	$3.\uparrow + * n = \{0 \mid \uparrow * m\}$

**Table 3.** Simplest Forms for Ups and Stars.

## Gift Horses

The following principle often makes it easy to check one's guess about the value of a position:

It does not affect the value of  $G$   
 if we add a new Left option  $H$  provided  $H \triangleleft G$ ,  
 or a new right option  $\bar{H}$  provided  $\bar{H} \triangleright G$

### THE GIFT HORSE PRINCIPLE

The new options  $H$  or  $\bar{H}$  are the **gift horses**; although they may appear to be useful presents, the recipient who looks them in the mouth will find that they have no teeth. For in the difference game

$$\{G^L, H \mid G^R\} + \{-G^R \mid -G^L\} \\ (-G)$$

if  $H$  is a gift horse, Left will find no joy in moving to the difference  $H - G \triangleleft 0$ , and the other options for Left and Right cancel each other as in the Tweedledum and Tweedledee Argument.

Thus we know that  $\{0 \mid \uparrow\} = \uparrow *$  is confused with  $\uparrow$ , so  $\uparrow$  will make a fine gift horse for Left:  $\{0 \mid \uparrow\} = \{0, \uparrow \mid \uparrow\}$ . Since Left's old option 0 becomes dominated in the new form, we can deduce  $\{0 \mid \uparrow\} = \{\uparrow \mid \uparrow\}$  more simply than we did before. In fact we have  $\uparrow * \parallel \uparrow$  and  $\uparrow * \parallel 3.\uparrow$  and so by a similar argument

$$\uparrow * = \{0 \mid \uparrow\} = \{\uparrow \mid \uparrow\} = \{\uparrow \mid \uparrow\} = \{3.\uparrow \mid \uparrow\}$$

On the other hand  $\uparrow * < 4.\uparrow$ , so the latter would *not* be a mere gift horse for Left, and indeed  $\{4.\uparrow \mid \uparrow\}$  is strictly greater than  $\uparrow *$ .



# Extras

## The Nim-Addition Rule in Several Variations

If you think about the way the nim-addition table (Table 2) extends, you'll see that

$$\begin{aligned} &\text{if } a \text{ and } b \text{ are less than } 2^k, \\ &\text{then so is } a \ddagger b, \text{ and} \\ &2^k \ddagger a = 2^k + a. \end{aligned}$$

From this you can deduce that

the nim-sum of a number of different powers of 2  
is their ordinary sum, and, of course,  
the nim-sum of two equal numbers is zero.

### THE BASICS OF NIM-ADDITION

You can use these two basic properties to find the nim-sum of any collection of numbers by writing each of them as a sum of distinct powers of 2 and then cancelling repetitions in pairs. For example,

$$5 \ddagger 3 = (4 + 1) \ddagger (2 + 1) = 4 \ddagger 1 \ddagger 2 \ddagger 1 = 4 \ddagger 2 = 4 + 2 = 6,$$

$$11 \ddagger 22 \ddagger 33 = (8 + 2 + 1) \ddagger (16 + 4 + 2) \ddagger (32 + 1) = 8 + 16 + 4 + 32 = 60.$$

These could also be written in terms of numbers,

$$*5 + *3 = *6 \quad \text{and} \quad *11 + *22 + *33 = *60,$$

and you should get used to working in either notation:

$$*9 + *25 + *49 = (*8 + *1) + (*16 + *8 + *1) + (*32 + *16 + *1) = *32 + *1 = *33.$$

This way of calculating shows you that

the nim-sum is less than or equal to the ordinary sum,  
and they differ by an even number.

### SEE HOW THE SUMS COMPARE AND HAVE COMMON PARITY

The textbooks usually say "write the numbers in binary and add without carrying" which comes to the same thing:



$$\begin{array}{r}
 \begin{array}{r}
 4 \ 2 \ 1 \\
 5 = \frac{1 \ 0 \ 1}{3 = \frac{1 \ 1}{6 = \frac{1 \ 1 \ 0}
 \end{array}
 \end{array}
 \quad
 \begin{array}{r}
 \begin{array}{r}
 32 \ 16 \ 8 \ 4 \ 2 \ 1 \\
 11 = \frac{1 \ 0 \ 1 \ 1}{22 = \frac{1 \ 0 \ 1 \ 1 \ 0}{33 = \frac{1 \ 0 \ 0 \ 0 \ 0 \ 1}{60 = \frac{1 \ 1 \ 1 \ 1 \ 0 \ 0}
 \end{array}
 \end{array}
 \quad
 \begin{array}{r}
 \begin{array}{r}
 32 \ 16 \ 8 \ 4 \ 2 \ 1 \\
 9 = \frac{1 \ 0 \ 0 \ 1}{25 = \frac{1 \ 1 \ 0 \ 0 \ 1}{49 = \frac{1 \ 1 \ 0 \ 0 \ 0 \ 1}{33 = \frac{1 \ 0 \ 0 \ 0 \ 0 \ 1}
 \end{array}
 \end{array}$$

But since you don't want to be scribbling on bits of paper, you should use our way, which makes it easy to do in your head, and is less prone to error.

## Wyt Queens and Wythoff's Game

Table 4 gives the numbers for various possible positions of Wyt Queens.

	0	1	2	3	4	5	6	7	8	9	10	11	12	13	14	15	16	17
0	0	*1	*2	*3	*4	*5	*6	*7	*8	*9	*10	*11	*12	*13	*14	*15	*16	*17
1	*1	*2	0	*4	*5	*3	*7	*8	*6	*10	*11	*9	*13	*14	*12	*16	*17	*15
2	*2	0	*1	*5	*3	*4	*8	*6	*7	*11	*9	*10	*14	*12	*13	*17	*15	*16
3	*3	*4	*5	*6	*2	0	*1	*9	*10	*12	*8	*7	*15	*11	*16	*18	*14	*13
4	*4	*5	*3	*2	*7	*6	*9	0	*1	*8	*13	*12	*11	*16	*15	*10	*19	*18
5	*5	*3	*4	0	*6	*8	*10	*1	*2	*7	*12	*14	*9	*15	*17	*13	*18	*11
6	*6	*7	*8	*1	*9	*10	*3	*4	*5	*13	0	*2	*16	*17	*18	*12	*20	*14
7	*7	*8	*6	*9	0	*1	*4	*5	*3	*14	*15	*13	*17	*2	*10	*19	*21	*12
8	*8	*6	*7	*10	*1	*2	*5	*3	*4	*15	*16	*17	*18	0	*9	*14	*12	*19
9	*9	*10	*11	*12	*8	*7	*13	*14	*15	*16	*17	*6	*19	*5	*1	0	*2	*3
10	*10	*11	*9	*8	*13	*12	0	*15	*16	*17	*14	*18	*7	*6	*2	*3	*1	*4
11	*11	*9	*10	*7	*12	*14	*2	*13	*17	*6	*18	*15	*8	*19	*20	*21	*4	*5

**Table 4.** Numbers for Wyt Queens.

Most of the entries are chaotic, but Wythoff's **Difference Rule** is that the *zero* entries have coordinates

$$(0,0), (1,2), (3,5), (4,7), (6,10), (8,13), (9,15), (11,18), \dots$$

with differences

$$0, 1, 2, 3, 4, 5, 6, 7, \dots$$

the first number in every pair being the smallest number that hasn't yet appeared. He also showed that the  $n$ th pair is

$$(\lfloor n\tau \rfloor, \lfloor n\tau^2 \rfloor) \quad n = 0.1.2.\dots$$

where  $\tau$  is the golden number

$$\frac{1 + \sqrt{5}}{2}$$

## Answers to Figures 8, 9, and 11.

Now that we know that  $\{0 \mid *\} = \uparrow$ ,  $\{*\mid 0\} = \downarrow$  and  $\{\uparrow \mid \downarrow\} = *$  we can fill in the values of the positions in the first two rows of Fig. 8. Then in the easy big game of Toads-and-Frogs shown in Fig. 9, the values of the 9 lanes are  $*$ ,  $0$ ,  $\uparrow$ ,  $\frac{1}{2}$ ,  $*$ ,  $-1$ ,  $*$ ,  $\frac{1}{2}$ , and  $\uparrow$ , whose total is  $\uparrow*$ , a win for Toads. But if Left has to play first, he must be careful and move in one of the star lanes, either in the starting position of lanes 1 or 7 to make the value  $3.\uparrow$ , or in the middle lane, making the value  $\uparrow\uparrow$ .

In our Gallimaufry of Games (Fig. 11) the Hackenbush position has the value  $\uparrow*$ , the Col position  $1*$ , and the Toads-and-Frogs position  $-1$ . In their sum,  $1$  and  $-1$  cancel, as do the two stars, leaving simply  $\uparrow$ . This is a win for Left, no matter who starts.

## Toad Versus Frog

A special case of Toads-and-Frogs which we can analyze completely is when each lane contains just one toad and one frog. After some moves we might find that the toad confronts the frog, so that either could jump over the other into an empty space just beyond. We then have

$$\begin{array}{c}
 \boxed{a + 1 \text{ spaces} \quad \text{toad} \quad \text{frog} \quad b + 1 \text{ spaces}} = \\
 \\
 \left\{ \boxed{a + 2 \text{ spaces} \quad \text{frog} \quad \text{toad} \quad b \text{ spaces}} \quad \Bigg| \quad \boxed{a \text{ spaces} \quad \text{frog} \quad \text{toad} \quad b + 2 \text{ spaces}} \right\} \\
 = \{b - a - 2 \mid b - a + 2\}
 \end{array}$$

since after either jump is made we can see exactly how many moves each creature has left to make. So for such positions the value is  $\{d - 2 \mid d + 2\}$  where  $d$  is the difference

(number of spaces to right of frog)  $-$  (number of spaces to left of toad).

This rule also works if either of these parentheses is 0. In the general position before confrontation there will be  $c$  spaces between the two creatures and a move by either player will shorten the gap to  $c - 1$  and decrease  $d$  by 1, if a toad move, increase it by 1 if a frog move.

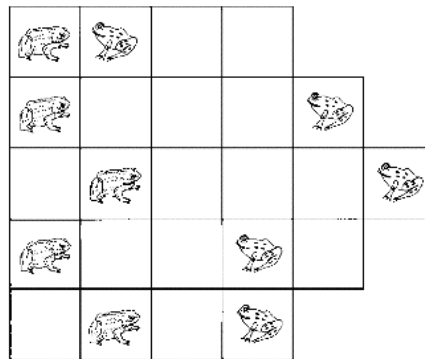


$d$	...	-4	-3	-2	-1	0	1	2	3	4	...
$c = 0$	...	-3	-2	-1	0	0	0	1	2	3	...
$c = 1$	...	-3	-2	-1	$-\frac{1}{2}$	*	$\frac{1}{2}$	1	2	3	...
$c = 2$	...	-3	-2	-1	0	0	0	1	2	3	...
$c = 3$	...	-3	-2	-1	$-\frac{1}{2}$	*	$\frac{1}{2}$	1	2	3	...

**Table 5.** Toad Approaching Frog.

So in Table 5 the Left and Right options for each entry are the entries left and right of it in the row above, for  $c = 1, 2, 3, \dots$ , while for  $c = 0$  they are  $d - 2$  and  $d + 2$ .

Using this rule to compute the entries it is easy to see that the rows continue to alternate. In the position of Fig. 16 the values of the lanes are, in order, 1, \*,  $-\frac{1}{2}$ , 0 and  $-\frac{1}{2}$ , which add to \*, so that either player can win by moving in the second lane. Can the reader find Left's only other winning move?



**Figure 16.** A 5-lane Game of Toad versus Frog.

### Two Theorems on Simplifying Games

We prove that by omitting all dominated options and bypassing reversible ones we really do obtain the absolutely simplest form of any game with finitely many positions. For suppose that  $G$  and  $H$  are games which have the same value, but that neither of them has any positions with dominated or reversible options. Then we shall prove that for every option of  $G$  there is an equal option of  $H$ , for the same player, and vice versa, so that  $G$  and  $H$  are not only equal in value, but identical in form.

Since the difference game

$$G - H = \{G^L \mid G^R\} + \{-H^R \mid -H^L\}$$

is a second player win, Right must have some winning response

$$G^{LR} - H \leq 0 \quad \text{or} \quad G^L - H^L \leq 0$$

to any of Left's options  $G^L - H$ . The first case would imply  $G^{LR} \leq H = G$ , making  $G^L$  a reversible move from  $G$ , so that for every  $G^{L_0}$  there must be some  $H^{L_0} \geq G^{L_0}$ . by a similar argument there must be some  $G^{L_1} \geq H^{L_0} (\geq G^{L_0})$  and since there are no dominated options, in fact  $G^{L_1} = H^{L_0} = G^{L_0}$ . The argument works equally well if we interchange  $G$  with  $H$  or Left with Right.

Our second theorem is that from the simplest form one can obtain any other form by adding gift horses and then perhaps deleting some dominated options. For if  $G = \{G^L \mid G^R\}$  is the simplest form of some game  $H = \{H^L \mid H^R\}$ , we can prove as before that Right's winning move from  $G^L - H$  must be to some game  $G^L - H^L \leq 0$  (rather than some  $G^{LR} - H \leq 0$ ).

This proves that for each  $G^L$  there is some  $H^L \geq G^L$ , and similarly for each  $G^R$ , some  $H^R \leq G^R$ . Also for every  $H^L$  we must have  $H^L \triangleleft H$  and for every  $H^R$ ,  $H^R \triangleright H$ , since neither player can have a winning move from  $H - H = 0$ . The last sentence shows that the options of  $H$  will serve as gift horses for  $G$ , so that

$$G = \{G^L, H^L \mid G^R, H^R\}$$

by the Gift Horse Principle. In this form each option  $G^L$  or  $G^R$  is dominated by some  $H^L$  or  $H^R$  and so may be omitted.

## Berlekamp's Rule for Hackenbush Strings

Here's how to find a Hackenbush string for a given number. The color of the edge which touches the ground is taken from the sign of the number, so that positive numbers start with a blue edge and negative with a red one. We'll just do the positive case.

Write the fractional part in binary; thus

$$3\frac{5}{8} = 3 \cdot 101.$$

Then, to find the Hackenbush string, replace the integer part by a string of L's, the point by LR

and convert 1's and 0's after the point into L's and R's, but *omitting the final digit, 1*:

$$3\frac{5}{8} = \begin{array}{ccccccc} 3 & & & \cdot & & 1 & 0 & 1 \\ \text{L} & \text{L} & \text{L} & & \text{LR} & & \text{L} & \text{R} \end{array}$$

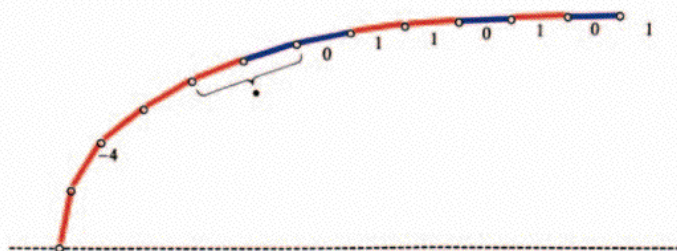
Of course,

$$-3\frac{5}{8} = \begin{array}{ccccccc} \text{R} & \text{R} & \text{R} & & \text{RL} & & \text{R} & \text{L} \end{array}$$

The Rule actually works even for real numbers which don't terminate, except that there is then no final 1 to be omitted. E.g.,

$$\frac{1}{3} = 0 \begin{array}{cccccccc} \cdot & 0 & 1 & 0 & 1 & 0 & 1 & \dots \\ \text{L} & \text{R} & \text{R} & \text{L} & \text{R} & \text{L} & \text{R} & \text{L} & \dots \end{array}$$

Of course, the rule can be reversed to convert any Blue-Red Hackenbush string to a number. For example



We write this as a string of L's and R's and replace the first pair of adjacent branches of different colors by a point, convert subsequent branches by the rule:

a color agreeing with the grounded color becomes 1,

a color opposite to the grounded color becomes 0,

and append an extra 1 bit at the end. Thus

R R R R R L L R R L R L

becomes

-4 . 0 1 1 0 1 0 1

i.e.

$$-\left(4 + \frac{1}{4} + \frac{1}{8} + \frac{1}{32} + \frac{1}{128}\right) = -4\frac{53}{128}.$$

Or you may prefer Thea van Roode's recipe, giving each edge a value 1 (or -1) until there is a color change, then halving each value and changing sign with the color, e.g.,

$$-1 -1 -1 -1 -1 + \frac{1}{2} + \frac{1}{4} - \frac{1}{8} - \frac{1}{16} + \frac{1}{32} - \frac{1}{64} + \frac{1}{128} = -4\frac{53}{128}$$

In certain applications when one wishes to store numbers whose distribution is known *a priori*, this Hackenbush number system may have significant advantages over the more conventional computer representations of fixed or floating point numbers.

## References and Further Reading

Claude Berge, *The Theory of Graphs and its Applications*, Methuen, London, 1962, p.53.

E. R. Berlekamp, The Hackenbush number system for compression of numerical data, *Information and Control*, **26**(1974) 134-140.

U. Blass & A. S. Fraenkel, The Sprague-Grundy function of Wythoff's game, *Theoret. Comput. Sci.*, **75** 311-333.

Charles L. Bouton, Nim, a game with a complete mathematical theory, *Ann. of Math., Princeton*(2), **3**(1901-02) 35-39.

Ian G. Connell, Generalization of Wythoff's game, *Canad. Math. Bull.*, **2**(1959) 181-190.

J. H. Conway, *On Numbers and Games*, Second Edition, A K Peters, Ltd., 2001, Chapter 10.

H. S. M. Coxeter, The golden section, phyllotaxis and Wythoff's game, *Scripta Math.*, **19**(1953) 135-143.

N. Duvdevani & A. S. Fraenkel, Properties of  $k$ -Welter's game, *Discrete Math.*, **76** 197-221.

Noam Elkies, On numbers and endgames: combinatorial game theory in chess endgames, in Richard Nowakowski (ed.) *Games of No Chance*, Cambridge University Press, 1996, 135-150.

- A. S. Fraenkel, How to beat your Wythoff games' opponents on three fronts, *Amer. Math. Monthly*, **89**(1982) 353–361.
- A. S. Fraenkel & M. Ozery, Adjoining to Wythoff's game its  $P$ -positions as moves, *Theoret. Comput. Sci.*, **205**(1998), 283–296.
- P. M. Grundy, Mathematics and games, *Eureka*, **2**(1939) 6–8; reprinted *ibid.* **27**(1964) 9–11.
- V. E. Hoggatt, Marjorie Bicknell-Johnson & Richard Sarsfield, A generalization of Wythoff's game, *Fibonacci Quart.*, **17**(1979) 198–211.
- V. E. Hoggatt & A. P. Hillman, A property of Wythoff pairs, *Fibonacci Quart.* **16**(1978) 472.
- A. F. Horadam, Wythoff pairs, *Fibonacci Quart.*, **16**(1978) 147–151.
- J. G. Mauldon, Num, a variant of Nim with no first player win, *Amer. Math. Monthly*, **85**(1978) 575–578.
- T. H. O'Beirne, *Puzzles and Paradoxes*, Oxford University Press, London, 1965, pp. 131–139.
- Robert Silber, A Fibonacci property of Wythoff pairs, *Fibonacci Quart.*, **14**(1976) 380–384.
- Robert Silber, Wythoff's Nim and Fibonacci representations, *Fibonacci Quart.*, **15**(1977) 85–88.
- R. P. Sprague, Über mathematische Kampfspiele, *Tôhoku Math. J.*, **41**(1935-36) 438–444; *Zbl.* **13**, 290.
- W. A. Wythoff, A modification of the game of Nim, *Nieuw Archief voor Wiskunde* (2), **7**(1905–07) 199–202.





## Taking and Breaking

He's up to these grand games, but one of these days I'll loore him on to skittles — and astonish him.

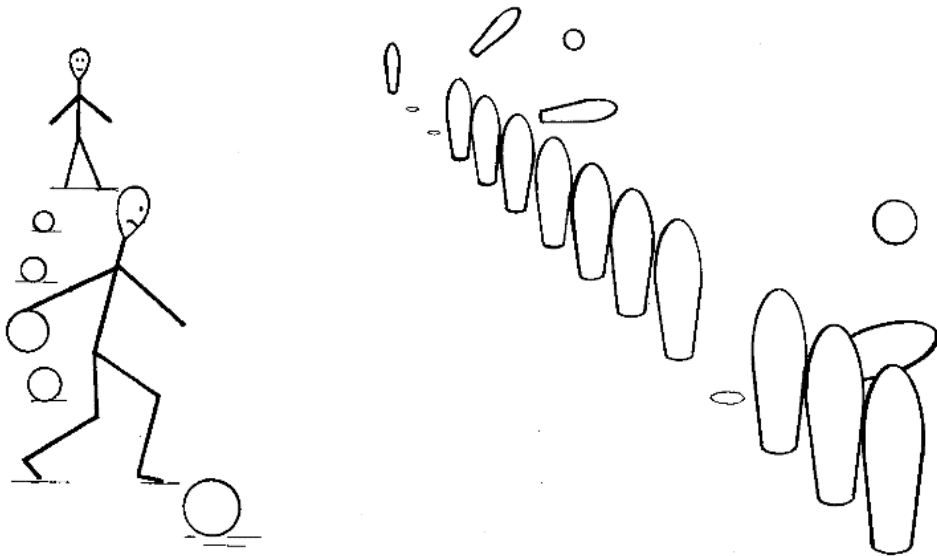
Henry J. Byron, *Our Boys*.

I'll live by Nym and Nym shall live by me; — is not this just? — for I shall sutler be.

William Shakespeare, *King Henry V*, II, i.

### Kayles

In Fig. 1 we see Left and Right playing the old English game of Kayles. They have become so skilful at this game that they can bowl so as to take out any desired pin or any two adjacent ones. The game is played with light and well-spaced pins so that the world champion can do no better; it is impossible to knock down two pins separated by a greater distance. Whoever is unable to knock down a pin loses.



**Figure 1.** Playing Kayles.



How shall we analyze this game? In the general position there are several rows of adjacent pins (e.g. rows of lengths 1, 7 and 3 in Fig. 1). Each move affects just one of these rows, of length  $n$ , say, and replaces it by two rows, whose lengths  $a \geq 0$  and  $b \geq 0$  add to  $n-1$  or  $n-2$ . Rows of length 0 may be ignored. The possible moves from a row  $K_7$  of length 7 are to:

$$K_6, K_5 + K_1, K_4 + K_2, K_3 + K_3, \\ K_5, K_4 + K_1, K_3 + K_2.$$

We can therefore play the same game on a table top with heaps of beans: each player, when it is his turn to move, may take 1 or 2 beans from a heap, and, if he likes, split what is left of that heap into two smaller heaps. We shall analyze Kayles in this form later in the chapter, and discover that Right, bowling in Fig. 1, is in a desperate situation.

Kayles was introduced by Dudeney and also by Sam Loyd, who called it Rip Van Winkle's Game.

## Games With Heaps

Consider any game played with a number of heaps in which each move affects *just one of the heaps* on the table, and in which exactly the same moves are available to each player. Any position in such a game is therefore the sum of its single heap positions, so the game is solved when we know the value of a heap of  $n$  beans for every  $n$ . Moreover, since the games are *impartial*, each such value is a Nim-heap,  $*m$ . In this chapter we'll usually omit the stars, so if heaps of sizes 0, 1, 2, 3, ... have values  $*a, *b, *c, *d, \dots$  we shall say that the game has the **nim-sequence**

$$a.bcd\dots$$

(sometimes we omit the decimal point) and refer to

$$\mathcal{G}(0) = a, \quad \mathcal{G}(1) = b, \quad \mathcal{G}(2) = c, \quad \mathcal{G}(3) = d,$$

as the **(nim)-values**. Using the information contained in the nim-sequence, we can analyze any position.

The nim-value of a sum of heaps of sizes

$$i, \quad j, \quad k, \quad \dots$$

is the nim-sum

$$\mathcal{G}(i) \ddagger \mathcal{G}(j) \ddagger \mathcal{G}(k) \ddagger \dots$$

and each nim-value,  $\mathcal{G}(n)$ , is computed as the least one of 0, 1, 2, 3, ... that is *not* the nim-value of any option from a heap of size  $n$ . As in Chapter 3 we shall call the least number (from 0, 1, 2, 3, ...) which is *missing* from a set  $\{x, y, z, \dots\}$  the **mex** (**minimal excluded number**) of that set. Thus

$$\text{mex}(0,1,3,7) = 2, \quad \text{mex}(2,4,5) = 0$$

and the mex of the empty set is 0.

## $\mathcal{P}$ -Positions and $\mathcal{N}$ -Positions

Impartial games can only have *two* outcome classes which we call

$\mathcal{P}$ -positions (Previous player winning), and  
 $\mathcal{N}$ -positions (Next player winning).

In this chapter we'll frequently be working with numbers, so you'll need to know that

a value of 0 indicates a  $\mathcal{P}$ -position, while  
 values  $*, *2, *3, \dots$  indicate  $\mathcal{N}$ -positions.

No other value is possible for an impartial game. But remember that if you're going to add up your games, you'll need to know the exact value, and not just the outcome class, of each component.

## Subtraction Games

We might modify the game of Nim by requiring that in any move the number of beans taken is at most three. This will mean that for the nim-values we have

$$\mathcal{G}(n) = \text{mex}(\mathcal{G}(n-1), \mathcal{G}(n-2), \mathcal{G}(n-3))$$

so that the nim-sequence is

$$\begin{array}{rcccccccccccc} n = & 0 & 1 & 2 & 3 & 4 & 5 & 6 & 7 & 8 & 9 & \dots \\ \mathcal{G}(n) = & 0 & 1 & 2 & 3 & 0 & 1 & 2 & 3 & 0 & 1 & \dots \end{array}$$

and a single heap is a  $\mathcal{P}$ -position (previous player winning) just if its size is a multiple of 4. We could instead allow a heap to be reduced by any number up to  $k$ , when the nim-sequence would be

$$\begin{array}{rcccccccccccccccc} n = & 0 & 1 & 2 & \dots & k-1 & k & k+1 & k+2 & \dots & 2k & 2k+1 & 2k+2 & 2k+3 & \dots \\ \mathcal{G}(n) = & 0 & 1 & 2 & \dots & k-1 & k & 0 & 1 & \dots & k-1 & k & 0 & 1 & \dots \end{array}$$

and a single heap would be a  $\mathcal{P}$ -position just if its size were a multiple of  $k+1$ .

These results are well known and easily discovered so that it might be wise to play a game whose theory is less obvious. For example the game in which a heap may be reduced only by taking 2, 5 or 6 beans from it. In this case

$$\mathcal{G}(n) = \text{mex}(\mathcal{G}(n-2), \mathcal{G}(n-5), \mathcal{G}(n-6))$$

and the nim-sequence is found to be

$$\begin{array}{rcccccccccccccccc} n = & 0 & 1 & 2 & 3 & 4 & 5 & 6 & 7 & 8 & 9 & 10 & 11 & 12 & 13 & 14 & 15 & 16 & 17 & 18 & \dots \\ \mathcal{G}(n) = & 0 & 0 & 1 & 1 & 0 & 2 & 1 & 3 & 0 & 2 & 1 & 0 & 0 & 1 & 1 & 0 & 2 & 1 & 3 & \dots \end{array}$$

where the dots indicate that the first eleven values repeat indefinitely, so a single heap is a  $\mathcal{P}$ -position only if its size is congruent to 0, 1, 4 or 8, modulo 11. But of course we can also analyze positions with arbitrarily many heaps. Let us find all the winning moves from the position with three heaps of sizes

$$5, 7, 9 \quad \text{values} \quad 2, 3, 2.$$



In Nim, the winning moves from the position

2, 3, 2

are to

1, 3, 2    *or*    2, 0, 2    *or*    2, 3, 1.

So by subtracting 2, 5 or 6 we must achieve a change from

the 5-heap to one of value 1, that is a 3-heap ( $5 - 2 = 3$ ),  
*or* the 7-heap to one of value 0, that is a 1-heap ( $7 - 6 = 1$ ),  
*or* the 9-heap to one of value 1, that is a 3-heap ( $9 - 6 = 3$ ).

More generally, for any **subtraction set**  $\{s_1, s_2, s_3, \dots\}$  we can define the corresponding **subtraction game**  $S(s_1, s_2, s_3, \dots)$  in which a heap may be reduced only by one of the numbers  $s_1, s_2, s_3, \dots$ . Table 1 gives the nim-sequences for some of these games.

For the subtraction game  $S(2, 5, 6)$  we find that  $\mathcal{G}(n)$  is never equal to  $\mathcal{G}(n-9)$ , so the game  $S(2, 5, 6, 9)$  has the same nim-sequence since adjoining  $\mathcal{G}(n-9)$  never alters the mex. More generally, if for the subtraction set  $\{s_1, s_2, \dots, s_k\}$  we find another number  $s$  with the property that  $\mathcal{G}(n)$  is never equal to  $\mathcal{G}(n-s)$  we can adjoin  $s$  to the subtraction set without affecting the nim-sequence. Such optional extras are shown in parentheses in Table 1 which therefore displays the nim-sequences for all cases with numbers up to 7.

**Table 1.** Nim-Sequences for Subtraction Games.

Subtraction set (with optional extras)	nim-sequence	period
1(3 5 7 9 11 ...)	0̇101...	2
2(6 10 14 18 ...)	0̇01i0011...	4
1 2(4 5 7 8 10 11 ...)	0̇12̇012...	3
3(9 15 21 27 ...)	0̇0011i000111...	6
2 3(7 8 12 13 17 18 ...)	0̇0112̇00112...	5
1 2 3(5 6 7 9 10 11 13 ...)	0̇123̇0123...	4
4(12 20 28 36 ...)	0̇000111i00001111...	8
1 4(6 9 11 14 16 19 ...)	0̇1012̇01012...	5
2 4(3 8 9 10 14 15 16 ...)	0̇01122̇001122...	6
3 4(10 11 17 18 24 25 ...)	0̇00111i2̇0001112...	7
1 3 4(6 8 10 11 13 15 17 ...)	0̇101232̇0101232...	7
1 2 3 4(6 7 8 9 11 12 13 14 ...)	0̇1234̇01234...	5
5(15 25 35 45 ...)	0̇00001111i0000011111...	10
2 5(9 12 16 19 23 26 ...)	0̇01102i0011021...	7
3 5(4 11 12 13 19 20 21 ...)	0̇0011122̇00011122...	8
2 3 5(4 9 10 11 12 16 17 18 19 ...)	0̇011223̇0011223...	7
4 5(13 14 22 23 31 32 40 ...)	0̇0001111i2̇000011112...	9
1 4 5(3 7 9 11 12 13 15 17 19 ...)	0̇1012323̇01012323...	8
2 4 5(3 9 10 11 12 16 17 18 19 ...)	0̇011223̇0011223...	7
1 2 3 4 5(7 8 9 10 11 13 14 15 16 ...)	0̇12345̇012345...	6

**Table 1.** (*continued*)

Subtraction set (with optional extras)	nim-sequence	period
6(18 30 42 54 ...)	0̇00000111111̇000000111111...	12
1 6(8 13 15 20 22 27 29 ...)	0̇101012̇0101012...	7
1 2 6(5 8 9 12 13 15 16 19 20 ...)	0̇120123̇0120123...	7
3 6(4 5 12 13 14 15 21 22 23 ...)	0̇00111222̇000111222...	9
1 3 6(8 10 12 15 17 19 21 24 ...)	0̇1010123̇2010101232...	9
2 3 6(7 11 12 15 16 20 21 24 ...)	0̇0112031̇2001120312...	9
4 6(5 14 15 16 24 25 26 34 ...)	0̇00011112̇20000111122...	10
2 4 6(3 5 10 11 12 13 14 18 19 ...)	0̇0112233̇00112233...	8
1 2 4 6(7 9 10 12 14 15 17 18 20 ...)	0̇1201234̇01201234...	8
5 6(16 17 27 28 38 39 49 50 ...)	0̇0000111112̇00000111112...	11
1 5 6(3 8 10 12 14 16 17 19 21 ...)	0̇101012323̇201010123232...	11
2 5 6(9 13 16 17 20 24 27 28 ...)	0̇0110213021̇00110213021...	11
2 3 5 6(4 10 11 12 13 14 18 19 ...)	0̇0112233̇00112233...	8
1 4 5 6(3 8 10 12 13 14 15 17 19 ...)	0̇10123234̇010123234...	9
1 2 4 5 6(8 9 11 12 14 15 16 18 19 ...)	0̇120123453̇0120123453...	10
1 2 3 4 5 6(8 9 10 11 12 13 15 16 17 ...)	0̇123456̇0123456...	7
7(21 35 49 63 ...)	0̇000000111111̇00000001111111...	14
2 7(11 16 20 25 29 34 ...)	0̇01100112̇001100112...	9
3 7(13 17 23 17 33 37 ...)	0̇001110221̇0001110221...	10
4 7(5 6 15 16 17 18 26 27 28 ...)	0̇0001111222̇00001111222...	11
1 4 7(9 12 15 17 20 23 25 28 ...)	0̇1012012̇01012012...	8
2 4 7(10 13 16 19 22 25 28 31 ...)	001122031̇02102...	3
3 4 7(5 6 13 14 15 16 17 23 24 ...)	0̇001112223̇0001112223...	10
1 3 4 7(5 9 11 12 13 15 17 19 20 ...)	0̇1012323̇01012323...	8
2 3 4 7(8 9 13 14 15 18 19 20 24 ...)	0̇011220314̇200112203142...	11
5 7(6 17 18 19 29 30 31 41 ...)	0̇0000111112̇2000001111122...	12
2 5 7(11 15 17 20 24 27 29 33 ...)	0̇011021322031001122332̇...	22
3 5 7(4 6 13 14 15 16 17 23 24 ...)	0̇001112223̇0001112223...	10
2 3 5 7(4 6 11 12 13 14 15 16 20 ...)	0̇01122334̇001122334...	9
2 4 5 7(3 6 11 12 13 14 15 16 20 ...)	0̇01122334̇001122334...	9
6 7(19 20 32 33 45 46 58 ...)	0̇000001111112̇0000001111112...	13
1 6 7(3 5 7 9 11 13 15 17 18 19 ...)	0̇1010123232̇3010101232323...	12
2 6 7(11 15 19 20 24 28 32 33 ...)	0̇01100112031̇20011001120312...	13
1 2 6 7(4 9 10 12 14 15 17 18 20 ...)	0̇1201234̇01201234...	8
3 6 7(4 5 13 14 15 16 17 23 24 ...)	0̇001112223̇0001112223...	10
1 4 6 7(9 12 14 17 19 20 22 25 ...)	0̇10120123201̇20101201232012...	13
2 4 6 7(3 5 11 12 13 14 15 16 20 ...)	0̇01122334̇001122334...	9
1 3 4 6 7(5 9 11 13 14 15 16 17 19 ...)	0̇101232345̇0101232345...	10
2 5 6 7(10 14 17 18 19 22 26 29 ...)	0̇01102132233̇001102132233...	12
1 2 5 6 7(4 9 10 12 13 15 16 17 18 ...)	0̇1201234534̇01201234534...	11
1 4 5 6 7(3 9 11 13 14 15 16 17 19 ...)	0̇101232345̇0101232345...	10
1 2 3 4 5 6 7(9 10 11 12 13 14 15 17 ...)	0̇1234567̇01234567...	8



The table displays many regularities. For all entries except  $\{2, 4, 7\}$  the sequence is *exactly* periodic in the sense that  $\mathcal{G}(n) = \mathcal{G}(n+p)$  for *all* values of  $n \geq 0$ . Moreover for every other entry except  $\{2, 5, 7\}$ , the period  $p$  is the sum of two numbers from the subtraction set. We feel that these features deserve explanation even though they occasionally fail. It is easy to prove that they hold for two-element subtraction sets and for sets in which  $s_{i+1} \leq s_i + s_1$ .

There are obviously some new theorems waiting to be discovered. In Chapter 15 we shall analyze subtraction games  $S(a, b, a+b)$  and we close here with a surprising result about *all* subtraction games:

### Ferguson's Pairing Property

T. S. Ferguson has observed and proved that there is a remarkable pairing between nim-values 0 and 1 in *any* subtraction game, namely

$$\mathcal{G}(n) = 1 \text{ if and only if } \mathcal{G}(n - s_1) = 0, \text{ where } s_1 \text{ is the least member of the subtraction set.}$$

For example, the nim-sequence for  $S(2, 5, 6)$ :

$$\begin{array}{cccccccccccccccc} \downarrow & \downarrow & & \downarrow & \downarrow & & \downarrow & \downarrow & & \downarrow & \downarrow & & \downarrow & \downarrow & & \dots \\ 0 & 0 & 1 & 1 & 0 & 2 & 1 & 3 & 0 & 2 & 1 & 0 & 0 & 1 & 1 & 0 & 2 & 1 & \dots \\ & & \uparrow & \uparrow & & & \uparrow & \uparrow & & \uparrow & \uparrow & & \uparrow & \uparrow & & & & & \end{array}$$

has its zeros and ones paired as shown ( $s_1 = 2$ ).

We can prove Ferguson's pairing property by obtaining a contradiction. If  $n$  is the *least* number for which the above boxed statement *fails*, we have *either*

$$\mathcal{G}(n) = 1 \text{ and } \mathcal{G}(n - s_1) \neq 0$$

or

$$\mathcal{G}(n - s_1) = 0 \text{ and } \mathcal{G}(n) \neq 1.$$

These respectively imply

$$\begin{array}{l} \mathcal{G}(n - s_1 - s_k) = 0 \text{ for some } s_k, \\ \text{which implies inductively} \\ \mathcal{G}(n - s_k) = 1, \\ \text{which implies} \\ \mathcal{G}(n) \neq 1. \end{array}$$

or

$$\begin{array}{l} \mathcal{G}(n - s_k) = 1 \text{ for some } s_k, \\ \text{which implies inductively} \\ \mathcal{G}(n - s_k - s_1) = 0, \\ \text{which implies} \\ \mathcal{G}(n - s_1) \neq 0. \end{array}$$

In Chapter 13 we shall show how Ferguson uses this pairing to analyze subtraction games in *misère* play. For subtraction games with long periods, see the references to Althöfer, Bültermann and Flammenkamp.

## Grundy Scales

Calculation of nim-sequences is often made easier if we use a **Grundy scale**. Figure 2 shows such a scale being used for the subtraction game  $S(2, 5, 6)$ . Successive values are written on squared paper and the arrowed entry is computed as the mex of the underlined entries, before the scale is moved on one place. Thus in Fig. 2,  $\mathcal{G}(14) = 1$  is about to be computed as the mex of 0, 2 and 0. Boxwood scales like that in the figure are expensive, but a serviceable substitute can be made from a strip of squared paper.

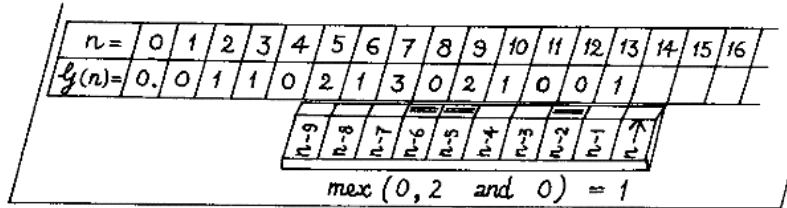


Figure 2. Using a Grundy Scale.

## Other Take-Away Games

We can modify the rules slightly so as to obtain games with less regular behavior which can still be handled by the same methods, provided the rules are such that only one heap is affected by any move. In the game called **·123** the possible moves are to

- remove a heap containing just *one* bean,
- or remove *two* beans from any heap with *more than two*,
- or remove *three* beans from *any* heap.

A heap of one has nim-value 1, since it may be reduced to zero, using the first kind of move. The restriction on the second kind of move implies that that a heap of two has nim-value 0, since it cannot be removed. For heaps of three or more we can use the Grundy scale shown in Fig. 3, since either 2 or 3 beans may be removed.

We can see that the sequence has period 5 after the first few terms, and this property will persist: the scale now refers to the same numbers (1,0) as it did five steps ago and so we get the same answer, 2, for  $\mathcal{G}(13)$  as we did for  $\mathcal{G}(8)$ .

$n =$	0	1	2	3	4	5	6	7	8	9	10	11	12	13	14	15
$\mathcal{G}(n) =$	0	1	0	2	2	1	0	0	2	1	1	0	0			

$n = 5$	$n = 4$	$n = 3$	$n = 2$	$n = 1$	$n = 0$
---------	---------	---------	---------	---------	---------

Figure 3. The Nim-sequence for **·123**



## Dawson's Chess

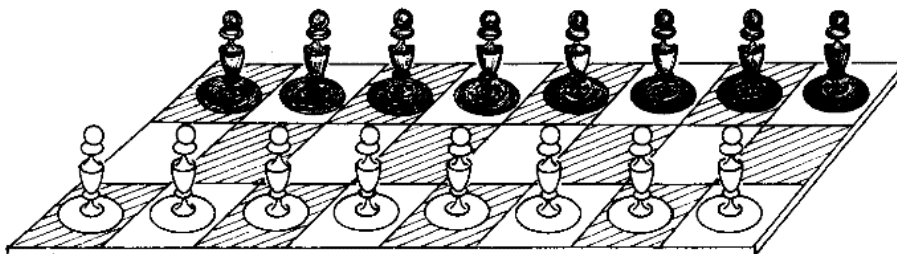


Figure 4. Ready for a Game of Dawson's Chess.

T. R. Dawson invented a game, which, as modified in Guy & Smith, we shall call Dawson's Chess. It is played on a  $3 \times n$  chessboard with White pawns on the first rank and Black pawns on the third. Pawns move (forwards) and capture (diagonally) as in Chess; in this game capturing is obligatory and the winner in normal play is the last player to move. We shall see that "queening" can never arise in this game. For example, if White starts on a  $3 \times 8$  board by advancing his *a*-pawn, Black must capture this with his *b*-pawn, White must then recapture with his *b*-pawn and the result is Fig. 5(a) in which the *a*-pawns are immobilized and it is Black's turn to move. If Black now advances his *f*-pawn, White must capture with his *e*- or *g*-pawn, which Black will recapture, and after two further recaptures we reach Fig. 5(b). Once again a pair of pawns is blocked and the player to move has changed. White may pass the turn back to Black by advancing his *h*-pawn, and so immobilizing yet another pair of pawns.

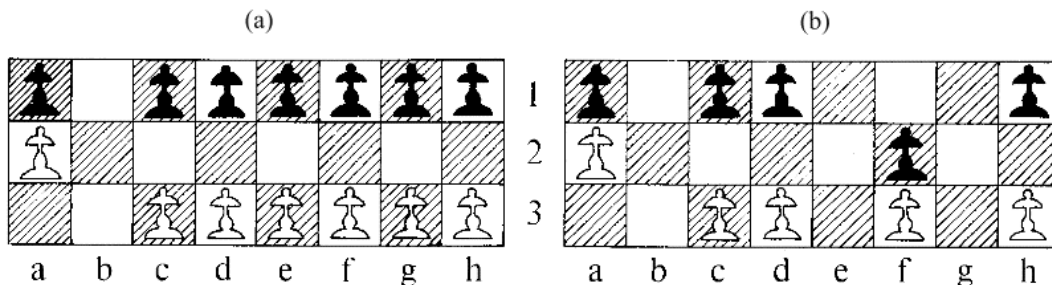


Figure 5. Playing Dawson's Chess on a  $3 \times 8$  Chessboard.

In general the advance of a pawn is followed by pairs of captures until the neighboring files are empty, isolating an immobilized pair of pawns and passing the turn to the opposing player. So we can imagine the same game played by skilful players with rows of pins like Kayles. This time the rule is that any one pin may be taken out provided that its immediate neighbors, if any, are removed at the same time. The player unable to move because no pin remains is the



loser. When recast in this way as a pin game, we can see that the game is impartial, even though the moves in the board game were different for the two players. Moreover as in Kayles the initial row of pins may become separated into independent rows and the value of the whole position will be the sum of the values of these.

The moves from a row of 11 pins leave rows of

$$9, \quad 8, \quad 7 \text{ and } 1, \quad 6 \text{ and } 2, \quad 5 \text{ and } 3, \quad \text{or} \quad 4 \text{ and } 4$$

pins, so that

$$\mathcal{G}(11) = \text{mex}(\mathcal{G}(9), \mathcal{G}(8), \mathcal{G}(7) \dagger \mathcal{G}(1), \mathcal{G}(6) \dagger \mathcal{G}(2), \mathcal{G}(5) \dagger \mathcal{G}(3), \mathcal{G}(4) \dagger \mathcal{G}(4)).$$

With the natural conventions  $\mathcal{G}(-1) = \mathcal{G}(0) = 0$ , we have in general

$$\mathcal{G}(n) = \text{mex}(\mathcal{G}(a) \dagger \mathcal{G}(b)) \quad \text{where} \quad -1 \leq a, b \text{ and } a + b = n - 3.$$

$n$	-1	0	1	2	3	4	5	6	7	8	9	10	11	12	13	14
$\mathcal{G}(n)$	0	0	1	1	2	0	3	1	1	0	3	3				
		3	3	0	1	1	3	0	2	1	1	0	0	$\mathcal{G}(n)$		
	12	11	10	9	8	7	6	5	4	3	2	1	0	-1	$n$	

Figure 6. Calculating  $\mathcal{G}(11)$  in Dawson's Chess.

A Grundy scale suitable for this calculation appears in Fig. 6. As the nim-values are computed they are entered both on the paper and, in the reverse order, on the scale. Reading from the figure we see that  $\mathcal{G}(11)$  is the mex of the nim-sums  $\mathcal{G}(a) \dagger \mathcal{G}(b)$  in the table

$$\begin{aligned} \mathcal{G}(a) &= 0 \ 0 \ 1 \ 1 \ 2 \ 0 \ 3 \ 1 \ 1 \ 0 \ 3 \\ \mathcal{G}(b) &= 3 \ 0 \ 1 \ 1 \ 3 \ 0 \ 2 \ 1 \ 1 \ 0 \ 0 \\ \mathcal{G}(a) \dagger \mathcal{G}(b) &= 3 \ 0 \ 0 \ 0 \ 1 \ 0 \ 1 \ 0 \ 0 \ 0 \ 3 \end{aligned}$$

whence  $\mathcal{G}(11) = \text{mex}(3, 0, 1) = 2$ .

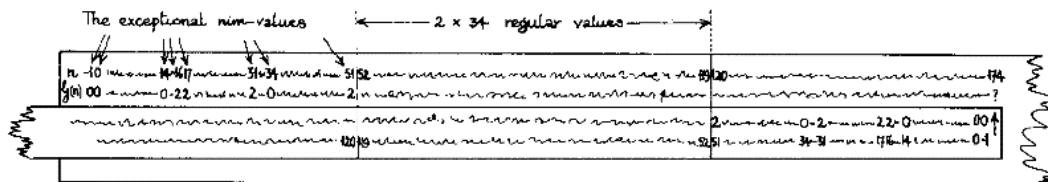
$n$	0	1	2	3	4	5	6	7	8	9	11	13	15	17	19	21	23	25	27	29	31	33												
	0	1	1	2	0	3	1	1	0	3	3	2	2	4	0	5	2	2	3	3	0	1	1	3	0	2	1	1	0	4	5	2	7	4
34	0	1	1	2	0	3	1	1	0	3	3	2	2	4	4	5	5	2	3	3	0	1	1	3	0	2	1	1	0	4	5	3	7	4
68	8	1	1	2	0	3	1	1	0	3	3	2	2	4	4	5	5	9	3	3	0	1	1	3	0	2	1	1	0	4	5	3	7	4
102	8	1	1	2	0	3	1	1	0	3	3	2	2	4	4	5	5	9	3	3	0	1	1	3	0	2	1	1	0	4	5	3	7	4
136	8	1	1	...																														

Table 2. The Remarkable Periodicity of Dawson's Kayles.



A persevering reader, armed with a very long Grundy scale, might find sufficient reward in the remarkable pattern that emerges (Table 2). If we disregard the seven exceptional numbers printed bold-face in the table, we find that the nim-values have period 34, and of course if this persists, we can regard ourselves as having solved the game completely.

Does it persist? In Fig. 7 we take a careful look at that very long Grundy scale, set to compute  $\mathcal{G}(174)$ , which is the first value we *don't* need to compute. As the scale is positioned, we can see two complete periods of 34 regular values between the innermost exceptional ones ( $\mathcal{G}(51) = 2$ ; one is on the scale, the other on the paper).



**Figure 7.** A Finicky Look at a Very Long Grundy Scale.

The calculation is exactly the same as it was for  $\mathcal{G}(140)$ , with the scale shifted back 34 places, except that 34 of the nim-sums of regular values are repeated. So the last value we need to compute in order to establish periodicity is  $\mathcal{G}(173)$ . The number 173 is obtained by doubling the last irregularity (51) and adding twice the period (34) together with the number 3, the largest number of pins that may be taken in a single move.

### The Periodicity of Kayles

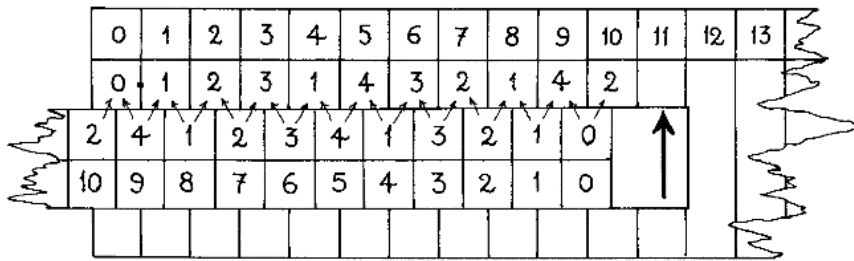
It is slightly harder to use the Grundy scale for the original game of Kayles in which one or two adjacent pins may be removed from anywhere in the row, giving the equation

$$\mathcal{G}(n) = \text{mex}(\mathcal{G}(a) \dagger \mathcal{G}(b)) \quad \text{where } 0 \leq a, b \text{ and } a + b = n - 1 \text{ or } n - 2.$$

We could first align the scale and note down the nim-sums for  $a + b = n - 2$  and then realign it and adjoin those for  $a + b = n - 1$ , before taking the mex. However, by placing the scale in an intermediate position we can read off all the nim-sums with one setting. The small arrows in Fig. 8 indicate exactly which pairs of numbers must be nimmed to calculate  $\mathcal{G}(11)$ . Reading them from left to right we find

$$\mathcal{G}(11) = \text{mex}(2, 4, 5, 0, 3, 0, 1, 0, 2, 5, 0, 5, 2, 0, 1, 0, 3, 0, 5, 4, 2) = 6.$$

(The obvious symmetry means we need only examine half of this list, but calculation of the whole list provides a useful check when doing hand calculation.) The nim-values for Kayles also exhibit periodicity (see Table 3). This time we have period 12, but with 14 exceptional



**Figure 8.** Grundy Skayles?

values, the last of which is  $\mathcal{G}(70) = 6$ . The periodicity may be checked by verifying that it holds up to

$$n = 166 = 2(70) + 2(12) + 2.$$

since the last irregularity occurs at  $n = 70$ , the period is 12 and no move takes more than 2 pins.

$n$	0	1	2	3	4	5	6	7	8	9	10	11
	<b>0</b>	1	2	<b>3</b>	1	4	<b>3</b>	2	1	<b>4</b>	2	<b>6</b>
12	4	1	2	<b>7</b>	1	4	<b>3</b>	2	1	<b>4</b>	<b>6</b>	7
24	4	1	2	8	<b>5</b>	4	7	2	1	8	<b>6</b>	7
36	4	1	2	<b>3</b>	1	4	7	2	1	8	2	7
48	4	1	2	8	1	4	7	2	1	<b>4</b>	2	7
60	4	1	2	8	1	4	7	2	1	8	<b>6</b>	7
72	4	1	2	8	1	4	7	2	1	8	2	7
84	4	1	2	8	1	4	7	2	1	8	2	7
96	4	1	2	8	1	4	7	...				

**Table 3.** The Periodicity of the Nim-Values of Kayles.

## Other Take-and-Break Games

Let us turn Dawson's Chess into a game with heaps. Recall that in the form with pins a pin may only be removed along with its neighbors, so that:

A *single* pin may be removed just if it is the only pin in its row, and so leaves nothing behind.

*Two* pins may be removed only if they are the two pins at one end of a longer row or form a whole row by themselves, so their removal leaves either a shorter row or nothing at all.

Any *three* adjacent pins may be removed; their removal will usually leave two shorter rows, but may leave only one row or none at all.



So if we play it with heaps of beans, the moves from a single heap must have the effect of replacing that heap by

0 heaps, if just *one* bean is removed,  
 1 or 0 heaps, if just *two* beans are removed, and  
 2, 1 or 0 heaps, if just *three* beans are removed.

We can symbolize such conditions by a code digit for each number of beans that may be removed. For Dawson's Chess these digits are

**1**       $2^0$       for removal of *one* bean,  
**3**       $2^1 + 2^0$       for removal of *two* beans,  
**7**       $2^2 + 2^1 + 2^0$       for removal of *three* beans,

and so the game may be written symbolically as **·137**.

More generally, if in some game we remove  $k$  beans from a heap provided we partition what remains of that heap into just  $a$  or  $b$  or  $c$  or  $\dots$  heaps (where  $a, b, c, \dots$  are distinct) we give that game the code digit

$$\mathbf{d}_k = 2^a + 2^b + 2^c + \dots \quad \text{for removal of } k \text{ beans.}$$

In Kayles we can remove 1 or 2 beans in any way so as to replace some heap by 2 or 1 or 0 heaps, so that  $\mathbf{d}_1 = \mathbf{d}_2 = \mathbf{7}$ , since  $2^2 + 2^1 + 2^0 = 7$ . In Dawson's Chess we have seen that  $\mathbf{d}_1 = \mathbf{1}$ ,  $\mathbf{d}_2 = \mathbf{3}$  and  $\mathbf{d}_3 = \mathbf{7}$ . For the game we called **·123** we have  $\mathbf{d}_1 = \mathbf{1}$ ,  $\mathbf{d}_2 = \mathbf{2}$ ,  $\mathbf{d}_3 = \mathbf{3}$ . In general there is a game

$$\cdot \mathbf{d}_1 \mathbf{d}_2 \mathbf{d}_3 \dots$$

for any possible sequence of code digits. In this notation, Kayles is the game

$$\cdot \mathbf{77} = \cdot \mathbf{77000} \dots$$

while Dawson's Chess is, as we have already seen,

$$\cdot \mathbf{137} = \cdot \mathbf{137000} \dots$$

If the digit  $\mathbf{d}_k = \mathbf{0}$ , there is no move removing exactly  $k$  beans. The subtraction games are those in which every code digit is  $\mathbf{0}$  or  $\mathbf{3}$  ( $3 = 2^1 + 2^0$ ); for example  $S(2, 5, 6)$  has the name **·030033**. Table 4 interprets the smallest values of  $\mathbf{d}_k$ .

## Dawson's Kayles

The particular case **·07** corresponds to the bowling game in which the only legal move is to knock down *two* adjacent pins. We call this Dawson's Kayles because it is a sort of first cousin to Dawson's Chess (**·137**). In fact the nim-value,  $D_n$ , of a row of  $n$  pins in Dawson's Kayles

Value of $\mathbf{d}_k$	Conditions for removal of $k$ beans from a single heap.
0	Not permitted.
1	If the beans removed are the whole heap.
2	Only if some beans remain and are left as a single heap.
3	Provided the remaining beans, if any, are left in one heap.
4	Only if some beans remain and are left as exactly two non-empty heaps.
5	Provided the remaining beans, if any, are left as two non-empty heaps.
6	Only if some beans remain and are left as one or two heaps.
7	Provided the remaining beans are left in at most two heaps.
8	Only if some beans remain and are left in just three non-empty heaps.
etc.	

**Table 4.** Interpretation of Code Digits for Take-and-Break Games.

is the same as that of the Dawson's Chess game with  $n-1$  pairs of pawns:

$$\begin{array}{cccccccccccccccccccccccc}
 n = 0 & 1 & 2 & 3 & 4 & 5 & 6 & 7 & 8 & 9 & 10 & 11 & 12 & 13 & 14 & 15 & 16 & 17 & 18 & 19 & 20 & \dots \\
 D_n = 0 & . & 0 & 1 & 1 & 2 & 0 & 3 & 1 & 1 & 0 & 3 & 3 & 2 & 2 & 4 & 0 & 5 & 2 & 2 & 3 & 3 & \dots
 \end{array}$$

Because its rules are slightly simpler than those for Dawson's Chess, it is Dawson's Kayles that arises most naturally in other contexts, and so in Chapters 8, 13, 15 and 16, the notation  $D_n$  refers to this variant.

## Variations

The nim-sequences for these take-and-break games are often related to each other in various ways. The nim-values for  $\cdot\mathbf{17}$

$$\begin{array}{cccccccccccccccccccccccc}
 n = 0 & 1 & 2 & 3 & 4 & 5 & 6 & 7 & 8 & 9 & 10 & 11 & 12 & 13 & 14 & 15 & 16 & 17 & 18 & 19 & 20 & \dots \\
 \mathcal{G}(\cdot\mathbf{17}) = 0 & . & 1 & 1 & 0 & 2 & 1 & 3 & 0 & 1 & 1 & 3 & 2 & 2 & 3 & 4 & 1 & 5 & 3 & 2 & 2 & 3 & \dots \\
 \mathcal{G}(\cdot\mathbf{07}) = 0 & . & 0 & 1 & 1 & 2 & 0 & 3 & 1 & 1 & 0 & 3 & 3 & 2 & 2 & 4 & 0 & 5 & 2 & 2 & 3 & 3 & \dots
 \end{array}$$

are obtained from those of Dawson's Kayles by nim-adding 1 when  $n$  is odd.

Some other cases show duplication or doubling of nim-values, as we'll see later.

## Guiles

For many of these games the nim-values are easily established, using suitable Grundy scales and taking care with the early values. The possible moves in the game of Guiles are to remove a heap of 1 or 2 beans completely, or to take two beans from a sufficiently large heap and partition what remains into two smaller non-empty heaps. In short it is the game  $\cdot\mathbf{15}$ .

As usual,  $\mathcal{G}(0) = 0$ , and since the only moves from heaps of 1 or 2 remove them completely, we have  $\mathcal{G}(1) = \mathcal{G}(2) = 1$ . A heap of 3 admits no legal move and can take no part in the game,



$\mathcal{G}(3) = 0$ . For larger heaps we have

$$\mathcal{G}(n) = \text{mex}(\mathcal{G}(a) \dagger \mathcal{G}(b)) \quad \text{where } 1 \leq a, b \text{ and } a + b = n - 2.$$

and we can use the Grundy scale shown in Fig. 9. The nim-sequence is

0.11011221221101122122110...

in which the values after the point turn out to have period 10.

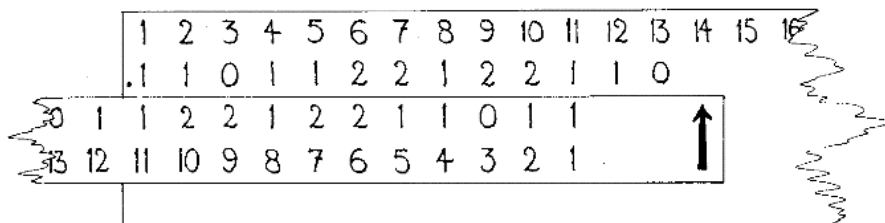


Figure 9. Guiles.

## Treblecross

Treblecross is a Tic-Tac-Toe game played on a  $1 \times n$  strip in which both players use the same symbol (X). The first person to complete a line of three consecutive crosses wins. How shall we analyze this game?

It's stupid to move next or next but one to a pre-existing cross, since your opponent wins immediately. If we consider only sensible moves we can therefore regard each X as also occupying the two neighbors of the square in which it lies (one of which may be off the board), and no two of these 3-square regions may overlap.

Our treblecrosser is therefore only James Bond ( $\cdot 007$ ) in disguise (see Fig. 10)!

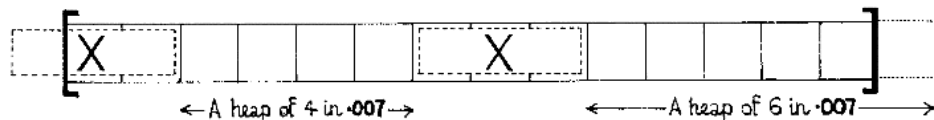


Figure 10. Treblecross is  $\cdot 007$  in Disguise.

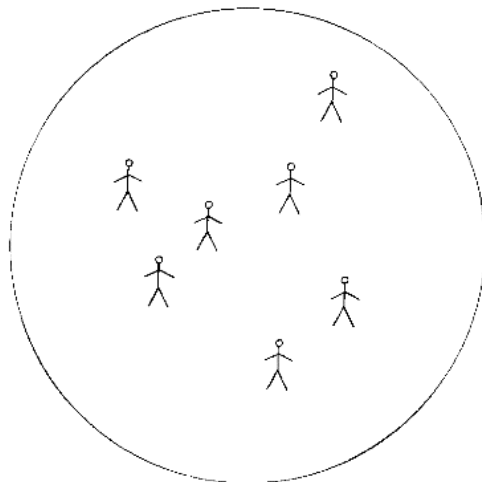
So writing  $X_n X$  for a strip of  $n$  empty squares between X's, and using [ and ] for the ends of the board we have the values:

	[0]	[1]	[2]	[3]	[4]	[5]	[6]	[7]	[8]	[9]	[10]	[11]	[12]
Treblecross	X0]	X1]	X2]	X3]	X4]	X5]	X6]	X7]	X8]	X9]	X10]	X11]	X12]
	X2X	X3X	X4X	X5X	X6X	X7X	X8X	X9X	X10X	X11X	X12X	X13X	X14X
$\cdot 007$ heap	0	1	2	3	4	5	6	7	8	9	10	11	12
nim-value	0	0	0	1	1	1	2	2	0	3	3	1	1

For more on Treblecross, see the Extras.

## Officers

The take-and-break games often arise in other unexpected contexts. We shall see that both Kayles and Dawson's Kayles arise naturally in the theory of Dots and Boxes (Chapter 16) and Dawson's Kayles in the game Seating Families of Five (Chapter 8), a variation of the game we called Seating Couples in Chapter 2. Some other cases appear in our Chapter 17 on Spots and Sprouts, and we give a further example here.



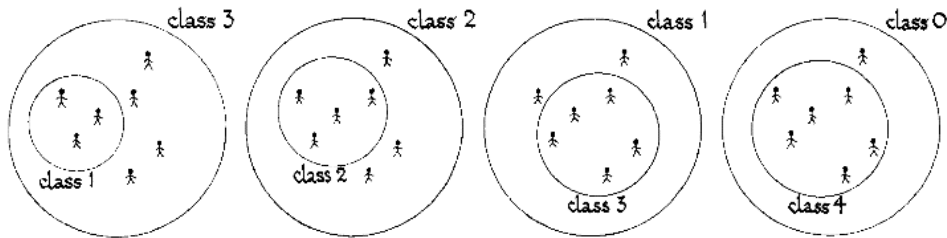
**Figure 11.** A Seven-Man Army in Disarray.

The army has been in disarray and the General has reduced all officers to the ranks and made everyone directly responsible to him. He now intends, on the alternate advice of his military advisors, Left and Right, to recruit, from outside the army, a new heirarchy of officers.

Left and Right will alternately advise that some officer currently in direct charge of four or more officers and men should recruit a new subordinate. The new officer will be directly responsible to the one who appointed him, and will, until further notice, take over direct responsibility for three or more, but not all, of those officers and men previously directly responsible to his appointer. Of course the game must end when every officer has either 2 or 3 direct subordinates, and whichever of Left and Right gave the last advice retains the confidence of the General.

We can play the game with pencil and paper by drawing the men with a circle round them all to represent the General, as in Fig. 11. As each officer is recruited we draw a circle round all his subordinates. Figure 12 shows four different ways in which the first officer can be recruited for the seven-man army.

For administrative purposes officers are classified, not according to rank, but according to their number of *direct* subordinates. A class  $n$  officer is directly responsible for just  $n + 2$  officers and men. So the General for the army in Fig. 11 is initially a class 5 officer, but after the first move his class will be reduced in one of the four ways indicated in Fig. 12.



**Figure 12.** The First Recruit Takes Command of his Men.

Every move reduces the class of some officer from  $n$  to  $a$  and introduces a new officer of class  $b$ , where  $a + b = n - 1$ , and  $b$  may not be 0. So the Officers game is equivalent to the take-and-break game  $\cdot 6$ , in which one bean is removed from a heap and what remains of that heap must be left in exactly 2 or 1 non-empty heaps ( $6 = 2^2 + 2^1$ ).

The initial nim-values for  $\cdot 6$ , namely

```

0 . 0 1 2 0 1 2 3 1 2 3 4 0 3 4 2 1 3 2 1 0 2 1 4 5 1
4 5 1 2 0 1 2 3 1 2 3 4 2 3 4 2 3 4 2 1 0 2 8 4 5 3
4 5 6 2 5 1 2 3 1 2 3 4 2 3 4 2 3 4 2 3 0 ...

```

after starting with period 3, show a strong inclination towards a period of 26. Richard Austin computed as far as  $\mathcal{G}(10342) = 256$ ; a complete analysis is still to be found.

Should the officers hold a ball in honor of the superb reorganization of their army, the game itself will provide an excellent waltz (N.B. one note spans the 7th and 8th bars).

We are indebted to the trustees of Blanche Descartes and to the publishers of *Eureka* for permission to reproduce the  $\cdot 6$  Waltz, and to make small changes in the words and the arrangement. See the illustration on the following page.

## Grundy's Game

Grundy's Game is a breaking game in which the only legal move is to split a single heap into two smaller ones of different sizes. Eventually all the heaps will have size 1 or 2 and can no longer be split, and the player who splits the last heap is the winner. You can use a Grundy scale to work out the values, provided you remember *not* to include the move which breaks a heap into two *equal* ones. Here are the first 101 nim-values:

```

n = 0-19   0 0 0 1 0 2 1 0 2 1   0 2 1 3 2 1 3 2 4 3
          20-39  0 4 3 0 4 3 0 4 1 2   3 1 2 4 1 2 4 1 2 4
          40-59  1 5 4 1 5 4 1 5 4 1   0 2 1 0 2 1 5 2 1 3
          60-79  2 1 3 2 4 3 2 4 3 2   4 3 2 4 3 2 4 3 2 4
          80-100 5 2 4 5 2 4 3 7 4 3   7 4 3 7 4 3 5 2 3 5 2 ...

```

The strong tendency to period 3 continues as far as values have been calculated, but the sequence has not been proved to be periodic, despite extensive calculations by many people.

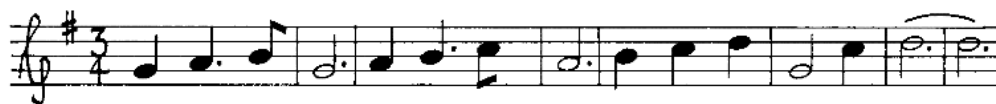


## The -6 Waltz

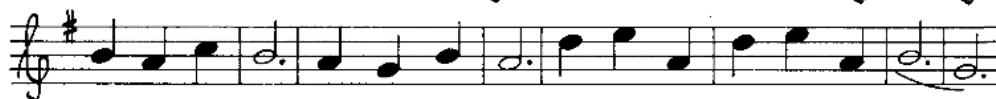
(unfinished)

Melody by -6. Arr. C. A. B. Smith  
Key of G.

Words by Blanche Descartes



If I'm a-lone, all on my own, there I must al-ways st-a-y.



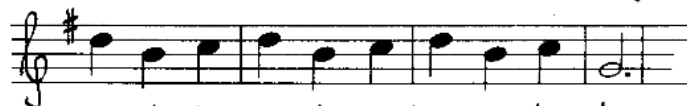
But if I touch an-oth-er such, I may be ta-ken a-wa-y.



And as a boon, this lit-tle tune shows you the right move to pla-y.



The val-ues G quite baf-fle me; do they show per-io-di-ci-ty?



Pt'aps they just wan-der a-long aim-less-ly ...

In 1973 we computed more than a quarter of a million values and discovered some interesting phenomena we'll tell you about in the Extras. Variations on the game appear in Chapters 10, 13 and 14.

## Prim and Dim

In **Prim** you may remove  $m$  beans from a heap of size  $n$  provided  $m$  and  $n$  are coprime (i.e., no number larger than 1 divides both  $m$  and  $n$ ). In **Dim** you may take  $d$  beans from a heap of size  $n$  provided  $d$  divides  $n$ . Each game has two variants:

Prim<sup>+</sup> if 1 to 0 is legal; Prim<sup>-</sup> if not.

Dim<sup>+</sup> if  $n$  to 0 is legal; Dim<sup>-</sup> if not.



Here are the nim-values

$n$	0	1	2	3	4	5	6	7	8	9	10	11	12	13	14	15	...	$n > 0$	...
Prim <sup>-</sup>	0	.0	1	2	1	3	1	4	1	2	1	5	1	6	1	2	...	$j$	...
Prim <sup>+</sup>	0	.1	0	2	0	3	0	4	0	2	0	5	0	6	0	2	...	$j'$	...
Dim <sup>-</sup>	0	.0	1	0	2	0	1	0	3	0	1	0	2	0	1	0	...	$k$	...
Dim <sup>+</sup>	0	.1	2	1	3	1	2	1	4	1	2	1	3	1	2	1	...	$k+1$	...

where the  $j$ th prime is the least prime divisor of  $n$ ,  
 $j'$  is obtained from  $j$  by swapping 0 and 1, and  
 $2^k$  is the largest power of 2 dividing  $n$ .

### Replication of Nim-Values

It is easy to see that the subtraction game  $S(4, 10, 12)$  has nim-sequence

$$0.000111100221133002211000011\dots$$

obtained by duplicating every digit in the nim-sequence

$$0.0110213021001\dots$$

for the subtraction game  $S(2, 5, 6)$ . More generally the nim-sequence for

$$S(ms_1, ms_2, \dots, ms_k)$$

is the  $m$ -plicate of that for

$$S(s_1, s_2, \dots, s_k)$$

obtained by repeating each nim-value  $m$  times.

Any game, such as  $\cdot 777077$ , whose code has only 0's and 7's and no isolated 7's, has an  $m$ -plicate. Wherever there is a run of 7's between  $\mathbf{d}_u$  and  $\mathbf{d}_{v+1}$  inclusive in the original game, the  $m$ -plicate game will have a run of 7's from  $\mathbf{d}_{mu}$  to  $\mathbf{d}_{mv+1}$  inclusive, and otherwise has only 0 digits. Games obtained by changing some digits, not at the ends of these runs of 7's, will have the same nim-sequence provided that not more than  $2m - 2$  consecutive digits are changed.

### Double and Quadruple Kayles

Double Kayles is the game  $\cdot 7777$  in which any number up to four beans may be removed from a heap and what remains is left in at most two heaps. We display its nim-sequence in correspondence with that for Kayles ( $= \cdot 77$ ).

Double Kayles	0.1	2 3	4 5	6 7	3 2	8 9	7 6	5 4	3 2	8 9	4 5	...
Kayles	0	1	2	3	1	4	3	2	1	4	2	...

The reader will see that each nim-value  $g$  for Kayles doubles up into a pair of values  $2g, 2g - 1$  for  $\cdot 7777$  in either that or the reverse order. Guy and Smith showed that this situation persists indefinitely and that the order is given by the scheme shown in Table 5. The table applies

equally to the game Quadruple Kayles ( $\cdot 77777777$ ) except that now  $g$  in Kayles is replaced by a sequence  $4g, 4g+1, 4g+2, 4g+3$  or its reverse according to the same scheme. The game  $\cdot 77 \dots 7$  with  $2^{m+1}$  7's may be called  $2^m$ -tuple Kayles. Its nim-sequence is similarly obtained on replacing  $g$  by

$$2^m g, \quad 2^m g+1, \quad \dots, \quad 2^m(g+1) - 1$$

or the reverse. The rather irregular-looking scheme can be summarized as follows: write the value  $\mathcal{G}(n) = g$  for Kayles in binary and ignore the 2's bit (e.g.  $7=01\mathbf{1}1$ ); if the sum of the remaining bits is even, and  $n$  is even, then the sequence is in its normal order, as it is if both  $n$  and the sum of the remaining bits is odd; otherwise the sequence is reversed.

$\mathcal{G}(n)$			For $\cdot 7777$		For $\cdot 77777777$	
	$n$ even	$n$ odd	$n$ even	$n$ odd	$n$ even	$n$ odd
0	up	down	0, 1	1, 0	0, 1, 2, 3	3, 2, 1, 0
1	down	up	3, 2	2, 3	7, 6, 5, 4	4, 5, 6, 7
2	up	down	4, 5	5, 4	8, 9, 10, 11	11, 10, 9, 8
3	down	up	7, 6	6, 7	15, 14, 13, 12	12, 13, 14, 15
4	down	up	9, 8	8, 9	19, 18, 17, 16	16, 17, 18, 19
5	up	down	10, 11	11, 10	20, 21, 22, 23	23, 22, 21, 20
6	down	up	13, 12	12, 13	27, 26, 25, 24	24, 25, 26, 27
7	up	down	14, 15	15, 14	28, 29, 30, 31	31, 30, 29, 28
8	down	up	17, 16	16, 17	35, 34, 33, 32	32, 33, 34, 35

**Table 5.** Values for Multiple Kayles.

## Lasker's Nim

The standard game of Nim is the subtraction game  $S(1, 2, 3, \dots)$  and so may be written  $\cdot 333 \dots$  or  $\cdot \mathbf{3}$ . Ed. Lasker has proposed that we adjoin the option of splitting a heap into two smaller non-empty ones without removing any bean. It is natural to denote the new option by the code digit  $\mathbf{d}_0 = 4$ , so that Lasker's Nim is the game  $4 \cdot 333 \dots$  or  $4 \cdot \mathbf{3}$ . Its nim-sequence is

$$0.1 \ 2 \ 4 \ 3 \ 5 \ 6 \ 8 \ 7 \ 9 \ \dots$$

in which the numbers  $4m$  and  $4m-1$  occur in the reverse of the usual order. This is one of a number of games with infinitely many non-zero code digits, many of which exhibit **arithmetic periodicity**. We will say that  $\mathcal{G}(n)$  has (ultimate) **period**  $p$  with **saltus**  $s$  if (for all sufficiently large  $n$ )

$$\mathcal{G}(n+p) = \mathcal{G}(n) + s.$$

Of course,  $s = 0$  corresponds to ordinary periodicity. We write the nim-sequence of  $4 \cdot \mathbf{3}$  as  $0.124\mathbf{3}(+4)$  where the parenthesis means that the saltus 4 is to be added to each successive period, and similarly for other games displaying arithmetic periodicity,

Some other games of this type appear in the Extras.

# Extras

## Some Remarks on Periodicity

When we used our very long Grundy scale to analyze Dawson's Chess (= **.137**) we were exemplifying a general theorem for all games whose code digits  $\mathbf{d}_z = \mathbf{0}$  for  $z > t$ . If the nim-values of an octal game are observed to have period  $p$  after the last irregular value  $\mathcal{G}(i)$ , then the last value that need be computed to verify that the period persists is

$$\mathcal{G}(2i + 2p + t).$$

After this point we can see that the calculations will duplicate earlier ones in the same way as they did for Dawson's Chess. Some of the examples displayed below in Tables 6 and 8 are (ultimately) periodic, but many games of this kind have not yet been shown to be so. It is an open question whether there are games with only a finite number of non-zero code digits which do not ultimately become periodic. We will have more to say on this topic at the end of the Extras.

## Standard Form

If we analyze the game **.4** (take one bean and break the remainder of the heap into two non-empty heaps) we find that its nim-sequence begins

$$0.001120311033224052233011302\dots$$

where  $\mathcal{G}(1) = \mathcal{G}(2) = 0$  because we cannot move from heaps of 1 or 2 beans. From here on the values agree with those for Dawson's Chess, if we have 2 more beans in a heap in **.4** than we had pairs of pawns in Dawson's Chess. A similar coincidence occurred when we analyzed **.07** (Dawson's Kayles; take 2 beans from a heap, leaving the rest of it in at most two heaps).

Generally, if  $\mathbf{d}_1$  is even, we are not allowed to remove a heap of 1 bean and  $\mathcal{G}(1) = 0$ , but if  $\mathbf{d}_1$  is odd, we can remove isolated beans and  $\mathcal{G}(1) = 1$ . In the latter case ( $\mathbf{d}_1$  odd) we say that the game **. $\mathbf{d}_1\mathbf{d}_2\mathbf{d}_3\dots$**  is in **standard form**.

A game  $\mathbf{D} = \mathbf{.d}_1\mathbf{d}_2\mathbf{d}_3\dots$  with  $\mathbf{d}_1$  *even* can be reduced to standard form by (a sufficient number of) applications of the following rule. Construct a new code name  $\mathbf{E} = \mathbf{.e}_1\mathbf{e}_2\mathbf{e}_3\dots$  from **. $\mathbf{d}_1\mathbf{d}_2\mathbf{d}_3\dots$**  where

- $\mathbf{e}_r$  contains **1** (i.e. is odd) if  $\mathbf{d}_{r+1}$  contains **1**
- $\mathbf{e}_r$  contains **3** (i.e. is of form  $4m+3$ ) if  $\mathbf{d}_r$  contains **2** (is of form  $4m+2$  or  $4m+3$ )
- $\mathbf{e}_r$  contains **7** (i.e. is of form  $8m+7$ ) if  $\mathbf{d}_{r-1}$  contains **4** (is of form  $8m+4, 5, 6$  or  $7$ )
- $\mathbf{e}_r$  contains **F** (=15, i.e. is of form  $16m+15$ ) if  $\mathbf{d}_{r-2}$  contains **8**, and generally
- $\mathbf{e}_r$  contains  $\mathbf{2}^{h+2}-\mathbf{1}$  if  $\mathbf{d}_{r-h}$  contains  $\mathbf{2}^{h+1}$  ( $h \geq -1$ ).

Then it is not hard to show that

$$\mathcal{G}_{\mathbf{E}}(n) = \mathcal{G}_{\mathbf{D}}(n+1).$$

If  $e_1$  is now odd,  $\mathbf{E}$  is in standard form and we will call  $\mathbf{D}$  its **first cousin**. If  $e_1$  is even, we repeat the rule. If  $t$  applications of the rule are necessary before the game  $\mathbf{D}$  is changed to standard form, we say that  $\mathbf{D}$  is the  $t$ **th cousin** of its standard form. For example, Dawson's Kayles is the first cousin and  $\cdot\mathbf{4}$  the second cousin of Dawson's Chess. Again if we apply the rule to  $\mathbf{D} = \cdot\mathbf{04}$  or to  $\mathbf{D} = \cdot\mathbf{042}$  we obtain  $\mathbf{E} = \cdot\mathbf{007}$ , and two further applications give  $\cdot\mathbf{0137}$  and  $\cdot\mathbf{11337}$ . So  $\cdot\mathbf{04}$  and  $\cdot\mathbf{042}$  are third cousins,  $\cdot\mathbf{007}$  a second cousin and  $\cdot\mathbf{0137}$  a first cousin, to  $\cdot\mathbf{11337}$ .

## A Compendium of Octal Games

Tables 6 and 7 give information about all **octal games** (i.e. every code digit less than 8) of the forms  $\cdot\mathbf{d_1d_2}$ ,  $\mathbf{4}\cdot\mathbf{d_1}$  and  $\cdot\mathbf{d_1d_2d_3}$ ,  $\mathbf{4}\cdot\mathbf{d_1d_2}$ . Dots indicate the first complete period. A question mark, ?, for the period means that we are not aware that the nim-sequence has been shown to be (ultimately) periodic. The sign § is a reference to the additional remarks on page 109, or to Tables 8 or 9.

If you can't find your game  $\cdot\mathbf{d_1d_2}$ , or  $\mathbf{4}\cdot\mathbf{d_1}$  in Table 6, use the table below to locate the appropriate row. Similarly the table on p. 103 locates 3-digit octal games in the rest of Table 7 or in Table 6; the octal points have been omitted.

$d_2$ $d_1$	0	1	2	3	4	5	6	7	$\mathbf{4}\cdot\mathbf{d_1}$
0				$\cdot\mathbf{02}$					$\cdot\mathbf{05}$
1	$\cdot\mathbf{01}$			$\cdot\mathbf{02}$					$\cdot\mathbf{51}$
2	$\cdot\mathbf{05}$	$\cdot\mathbf{05}$		$\cdot\mathbf{22}$	$\cdot\mathbf{05}$	$\cdot\mathbf{05}$		$\cdot\mathbf{06}$	$\cdot\mathbf{05}$
3	$\cdot\mathbf{05}$			$\cdot\mathbf{22}$					
4	$\cdot\mathbf{07}$	$\cdot\mathbf{17}$	$\cdot\mathbf{07}$	$\cdot\mathbf{17}$			$\cdot\mathbf{44}$	$\cdot\mathbf{45}$	$\cdot\mathbf{77}$
5	$\cdot\mathbf{05}$					$\cdot\mathbf{51}$			$\cdot\mathbf{51}$
6	$\cdot\mathbf{37}$	$\cdot\mathbf{37}$	$\cdot\mathbf{37}$	$\cdot\mathbf{37}$		$\cdot\mathbf{64}$	$\cdot\mathbf{64}$	$\cdot\mathbf{64}$	$\cdot\mathbf{77}$
7	$\cdot\mathbf{05}$			$\cdot\mathbf{26}$					$\cdot\mathbf{75}$

Game Locator for Table 6.

game	cousins		standard form	nim-sequence, from $\mathcal{G}(1) = 1$				period
	2nd	1st						
.01	.001	.01	.1	i0				1
.02	.02y	.03y	.13	i100				4
.04	.007	.0137	.11337	1112203311	1043332224	4055222330	5011133356	?
.05	{ .05W .2YW .012 4.WY }		{ .U0X .10U }	i0				2
.06	.06x	.03T	.1337	1122031122	3344053342	2113022114	4552647581	?
.07	.4Wx	.07x	.137	1120311033	2240522330	1130211045	2740112031	34
.11		.011	.11	i10				1
.12			.12	i00i				4
.14			.14	1001021221	0414412212	0104126164	1401021261	?
.15			.15	i101122122				10
.16			.16	1001221401	4214014214	2102142145	1421421423	149459§
.17		.4Vy	.17	1102130113	2234153223	1103120114	4264110213	34
.22		.2Sy	.33	i20				3
.26	{ .2Tx 4.WN }		{ .33U .73X }	i230				4
.31		.2y1	.31	i20i				2
.32			.32y	i02				3
.34			.34y	101201 03121203				8
.35			.35	i20102				6
.36			.36y	1021021321	3243043241	2312012415	4154152102	?
.37		.6xy	.37	1201231234	0342132102	1451451201	2312342342	?
.44	.4Qx	.07Z	.1377	1122331144	3322114422	6644112277	1144332211	24
.45		.4Rx	.177	1122311443	2211422644	1122711443	2211482744	20
.51			.5PY 4.PY	i				1
.52			.52x	1022103				4
.53			.53y	1122102240	i2211224i			9
.54			.54x	10i2224ii				7
.56			.56x	1022411324	4662117684	11654811C4	56113C6689	144§
.57			{ .175 .53z .57Y 4.1T 4.5N }	i122	A = 10, B = 11, C = 12			4
.64		.6Zx	.377	1234153215	4268123745	8295476814	624B23854	?
.71	{ .2y3 .2zV }		{ .31M .71X }	i2i0				2
.72			.32N .72X	i023				4
.74			.74x	1012324146	2321517685	1AB26845A6	2151562681	?
.75			{ .35R .75X 4.7Y }	i2				2
.76			.76x	1023416234	1673216752	8965871A4	371A428613	?
.77		4.Qx	.77y	1231432142	6412714321	4674128547	2186741231	12
4.3			.352 4.3Y	i20				2

M=1,3,5,7   N=2,3,6,7   P=1,5   Q=4,6   R=5,7   S=2,3   T=6,7   U=3,5,7   V=1,3  
W=0,2   X=0,1,2,3,4,5,6,7   x=1,2,3   Y=0,1,4,5   y=0,1   Z=4,5,6,7   z=4,5

**Table 6.** Octal Games with two Code Digits.



$d_3 =$	1	2	3	4	5	6	7	$d_3 =$	1	2	3	4	5	6	7
$d_1 d_2$								$d_1 d_2$							
00	01	—	002	—	—	—	04	10	—	—	05	—	05	—	05
01	11	05	002	—	—	—	—	11	—	—	002	—	—	—	051
02	02	—	022	—	024	—	026	12	—	—	—	—	—	—	—
03	02	022	022	—	034	06	06	13	—	—	022	—	—	—	07
04	017	04	017	—	—	044	045	14	—	—	—	—	—	—	—
05	—	05	051	—	—	054	055	15	51	—	—	—	51	—	—
06	06	06	06	—	064	064	064	16	—	—	—	—	—	—	—
07	07	07	07	44	44	44	44	17	—	—	—	—	57	—	45
20	31	05	71	—	—	—	—	30	05	05	05	05	05	05	05
21	31	05	71	204	205	206	207	31	71	—	71	31	71	—	71
22	22	26	26	—	224	—	226	32	32	72	72	—	324	72	72
23	22	26	26	224	224	226	226	33	—	—	26	—	26	—	26
24	71	05	71	—	—	244	245	34	34	—	342	—	344	—	346
25	71	05	71	244	245	244	245	35	—	4·3	—	—	75	—	75
26	26	26	26	—	264	264	264	36	36	—	362	—	364	—	366
27	26	26	26	264	264	264	264	37	—	332	—	—	—	—	64
40	07	07	07	—	404	404	404	50	05	05	05	05	05	05	05
41	17	173	173	—	414	—	416	51	51	—	512	51	51	157	157
42	07	07	07	404	404	404	404	52	52	52	52	—	524	524	524
43	17	173	173	414	414	416	416	53	53	—	532	57	57	—	536
44	44	44	44	—	444	444	444	54	54	54	54	147	147	147	147
45	45	45	45	—	454	454	454	55	51	157	157	51	51	157	157
46	44	44	44	444	444	444	444	56	56	56	56	—	564	564	564
47	45	45	45	454	454	454	454	57	57	536	536	57	57	536	536
60	37	373	373	—	604	—	606	70	05	05	05	05	05	05	05
61	37	373	373	604	604	606	606	71	71	71	71	71	71	71	71
62	37	373	373	604	604	606	606	72	72	72	72	72	72	72	72
63	37	373	373	604	604	606	606	73	26	26	26	26	26	26	26
64	64	64	64	—	644	644	644	74	74	74	74	—	744	744	744
65	64	64	64	644	644	644	644	75	75	75	75	75	75	75	75
66	64	64	64	644	644	644	644	76	76	76	76	—	764	764	764
67	64	64	64	644	644	644	644	77	77	—	772	—	774	—	776
				$d_2 =$	1	2	3	4	5	6	7				
				4· $d_1$											
				4·0	05	26	26	05	05	26	26				
				4·1	51	—	4·12	51	51	57	57				
				4·2	05	26	26	05	05	26	26				
				4·3	4·3	332	332	4·3	4·3	332	332				
				4·4	77	77	77	776	776	776	776				
				4·5	51	57	57	51	51	57	57				
				4·6	77	77	77	776	776	776	776				
				4·7	75	—	4·72	75	75	4·72	4·72				

Game Locator in Tables 7 and 6.



game	cousins		standard	nim-sequence, from $\mathcal{G}(1) = 1$				period
	2nd	1st	form					
·002	·003	·013	·113	i11000				6
·004	·00137	·011337	·1113337	1111222033	3111104433	3322224440	5552222333	?
·005	·005	·0107	·10137	1011222033	4110154333	2221601045	2216657010	?
·006	·0037	·01337	·113337	1112220331	1122433355	2144333222	1114050222	?
·014		·014	·1007	1001012212	3401051212	5303451211	2303323451	?
·015		·015	·1107	1101021223	0142145122	3234014512	5123423401	?
·016		·016	·1037	1012220101	4422161604	2127661512	8461210845	?
·017		·017	·1137	1112023114	0451320211	1402616404	1112026154	60§
·022	·02S	·03S	·133	i1200				5
·024	·02z	·0307	·13137	1122304112	5324115560	3125148142	1967422168	?
·026	·02T	·0337	·13337	1122304112	5334112530	4421133442	1156322815	?
·034		·03z	·1307	1102231401	4312210514	5632481402	7624584113	?
·044	·0077	·01377	·113377	1112223331	1144433322	2111444222	6664441112	36
·045	·04R	·0177	·11377	1112223311	1444332221	1144222664	4411122277	32
·051		·05V	·117	1110221340	1113222340	1543222310	1043222010	48§
·054		·05Q	·1077	1012223441	1163222411	6667344511	1673544187	?
·055		·05R	·1177	1112223111	4443222111	4222644411	1222711144	148§
·064	·06Z	·0377	·13377	1122334115	5332211544	2266841122	3374455872	?
·101			·101	1010				1
·102			·102	i000i				6
·104			·104	1000102212	2410401566	1228104015	6625481010	?
·106			·106	1000122214	4010621242	1045166512	4510653045	?
·111			·111	1110				1
·112			·112	i1000i				6
·114			·114	1100112021	2041104115	2415241120	1120432244	?
·115			·115	i1101112221222				14§
·116			·116	1100212021	1044152411	2041204115	4425202154	96§
·121			·121y	102i00i				4
·122			·122y	i002i				5
·123			·123y	1022i002i				5
·124			·124y	1001102130	2130113023	3223425042	5322332031	62§
·125			·125y	1021102130	1130234223	4253225320	3110312011	?
·126			·126y	1002133210	4250315041	5041304130	2234453722	?
·127			·127y	1022104412	2014461770	1226144812	7810726814	4§
·131			·131	i1200i				4
·132			·132	i1002				5
·134			·134	1100112031	2031103122	3322435143	5223322130	62§
·135			·135	1120112031	1031224322	4352235221	3011302110	?
·136			·136	1100213021	1022334251	4223342011	2031205144	?
·141			·141y	1011012212	410	i1212212412		11
·142			·142y	1002221103	3241063231	0162240115	3384062355	?
·143			·143y	1012220104	2215047228	0412228104	2215047228	?
·144			·144y	100	i222244111			10§
·145			·145y	10	i1222241i			9§
·146			·146y	1002224111	3324446662	3111766842	1176534811	?
·147			·54Zy	10	i222441i			8§

Table 7. Octal Games with three Code Digits.



**Table 7.** (*continued*)

game	1st cousins	standard form	nim-sequence, from $\mathcal{G}(1) = 1$				period
<b>·152</b>		<b>·152y</b>	1102220104	3231013224	0104223101	3234010222	48§
<b>·153</b>		<b>·153y</b>	1112221102	22440	11222111222441		14
<b>·154</b>		<b>·154y</b>	110	11222224111			11
<b>·156</b>		<b>·156y</b>	1102224411	1322444666	2111576688	1112655581	349§
<b>·157</b>		<b>·157y</b>	111222				6
<b>·162</b>		<b>·162y</b>	1002231104	2261034266	0542330142	8365142308	?
<b>·163</b>		<b>·163y</b>	1022310422	6104226104	3221043265	0432610532	?
<b>·164</b>		<b>·164y</b>	1001223445	1163223415	66738211A7	6675541A82	?
<b>·165</b>		<b>·165y</b>	1021321344	3623128126	5445182182	136C564812	1550§
<b>·166</b>		<b>·166y</b>	1002234116	6224411338	5446633118	826441933A	?
<b>·167</b>		<b>·167y</b>	1022341162	2441133544	663315866A	44336AA443	?
<b>·171</b>		<b>·171y</b>	1122110214	0	11221122142		11
<b>·172</b>		<b>·172y</b>	1102230113	2244063224	0163220116	3344110354	?
<b>·173</b>	<b>·4VS</b>	<b>·173y</b>	1122310432	0112235143	2211023741	3221046274	40§
<b>·174</b>		<b>·174y</b>	1102132214	4564223115	4128865741	B22688A1BA	?
<b>·176</b>		<b>·176y</b>	1102234411	6223441166	332	41166334	8
<b>·204</b>	<b>·2y4</b>	<b>·3007</b>	1012010123	1212314303	1432324323	2452021523	?
<b>·205</b>	<b>·2y5</b>	<b>·3107</b>	1201012312	3134034532	3253210202	5473420464	?
<b>·206</b>	<b>·2y6</b>	<b>·3037</b>	1012320101	2323451232	3454010342	4217545321	?
<b>·207</b>	<b>·2y7</b>	<b>·3137</b>	1212030124	5312124303	0214358213	6304121205	?
<b>·224</b>	<b>·2Sz</b>	<b>·3307</b>	1201231231	4304314213	2102142641	6426120123	?
<b>·226</b>	<b>·2ST</b>	<b>·3337</b>	1234012345	123451230	51234		5
<b>·244</b>	<b>·2zQ</b>	<b>·3077</b>	1012323451	5673232158	9767654548	232AB45452	?
<b>·245</b>	<b>·2zR</b>	<b>·3177</b>	1212345156	7321289765	64C9212A74	52C73D2183	?
<b>·264</b>	<b>·2TZ</b>	<b>·3377</b>	1234516325	1867524816	A45267A518	7E6153861C	?
<b>·312</b>		<b>·312y</b>	1202	01			2
<b>·316</b>		<b>·316y</b>	120	212301030123			12
<b>·324</b>		<b>·32zy</b>	1021301340	2342132034	1346201253	1678134160	?
<b>·331</b>		<b>·331</b>	123	012			3
<b>·332</b>		$\left\{ \begin{array}{l} \mathbf{·332y} \\ \mathbf{·372y} \\ \mathbf{4·3N} \end{array} \right\}$	1203				4
<b>·334</b>		<b>·334y</b>	1201203123	1243503426	1241302172	4784206152	?
<b>·336</b>		<b>·336y</b>	1203124031	2034123612	3051306413	5246301430	?
<b>·342</b>		<b>·34Sy</b>	1012320103	2345023254	0102321456	7205476232	?
<b>·344</b>		<b>·34zy</b>	1012324514	6232145876	7A14123264	1482321A18	?
<b>·346</b>		<b>·34Ty</b>	1012324516	7232158676	A548923AB4	58326A1589	?

A=10 B=11 C=12 D=13 E=14



Table 7. (concluded)

game	cousins		standard form	nim-sequence, from $\mathcal{G}(1) = 1$	period
	2nd	1st			
·351			·351y	i212010 $\dot{2}$	8
·353			·353y	121 $\dot{2}0$	2
·354			·354y	1201243123 5243513524 7247864762 786836C742	?
·356			·356y	1202124516 7512826281 5B79581212 C258561812	142§
·362			·36Sy	1023410234 1523714237 0123750132 5486254872	?
·364			·36zy	1021321345 3423125125 7457482962 968764721A	?
·366			·36Ty	1023451623 4576891276 85432915B3 284AB3659A	?
·371			·371y	1231032402 3401241632 0123413421 0734162187	?
·373		·6xS	·373y	1 $\dot{2}$ 340123415 2314721043 2140264 $\dot{0}$	28
·374			·374y	1201243123 5243513524 7247864762 7869369742	?
·375			·375y	1231243213 4274814812 4814381482 148148 i248	18§
·376			·376y	1203124352 4351432645 867A827362 7465392534	4§
·404	·4WZx	·07x7x	·13737	1122334115 6332211087 7255401122 8845566772	?
·414		·4Vzx	·1707y	1102234401 1322344566 3223118763 AA01187644	?
·416		·4VTx	·1737y	1122341166 3221066844 5A17833241 66884AAC18	?
·444	·4QZx	·0777x	·13777	1122334115 6332211887 7655441122 8845566778	?
·454		·4RZx	·1777y	1122341166 3221166844 5A11833447 6688411678	?
·512			·51Sy	11 i2221 $\dot{0}$	6
·524			·52Zy	i022104416 7012261446 1870187614 7610781674	52§
·532			·53Sy	112240 i224i	5
·536			$\left\{ \begin{array}{l} \cdot53Ty \\ \cdot57Ny \end{array} \right\}$	i1224	5
·564			·56Zy	1022441132 5476823A76 8932C65432 11945AACE9	?
·604		·6xzW	·3707y	1201231234 5345321321 0254754768 9201239674	?
·606		·6xTx	·3737y	1234012345 1234562345 6734167891 6789143765	?
·644		·6ZZx	·3777y	1234516325 896A5496EA 42367G49EA GH94EF19G2	442§
·744			·74Zy	1012324516 723218967A 45981ABA45 961AB39896	?
·764			·76Zy	1023451623 4576891A76 8543261543 28EAB59GEF	?
·772			·77Sy	1234162 416 $\dot{3}$	4
·774			·77zy	1231456713 289546C219 645CD23895 6DC3296AGC	?
·776		4·QZy	·77Ty	1234163216 74581A5476 1236143218 A4EG123416	?
4·12			4·1Sy	11220 4 $\dot{2}$ 1122i	7
4·72			4·7Ny	i24	3

A=10 B=11 C=12 D=13 E=14 F=15 G=16 H=17

game	period $p$	regular nim-values, $\mathcal{G}(n)$ , $n \equiv 1, 2, \dots, p, \text{ mod } p$	exceptional nim-values, $\mathcal{G}(0) = 0, \mathcal{G}(1) = 1$ and
·017	60	1112026114 0461320211 1402616404 1112026154 0461320211 1802616404	$\mathcal{G}(7) = 3$ , $\mathcal{G}(13) = 5$ .
·051	48	10102323 40101323 23401043 23231010 43232010 10432340	$\mathcal{G}(n) = 1$ for $n = 2, 7, 12, \mathcal{G}(22) = 5$ , $\mathcal{G}(n) = 2$ for $n = 6, 16, 26, 36, \mathcal{G}(46) = 5$ .
·116	96	1120A120 61104415 24112041 50411524 25A0A154 2C582855 24A1A0A5 24251140 51202114 A5142011 20A120A8 18981C20	$\mathcal{G}(3) = 0, \mathcal{G}(88) = 1$ , $\mathcal{G}(n) = 2$ for $n = 5, 9, 25, 35, 37, 47$ , $\mathcal{G}(n) = 4$ for $n = 31, 41$ , $\mathcal{G}(n) = 8$ for $n = 42, 94, 138$ .
·124	62	58411 02130 21301 1302 3322 7465 4455 79633 20311 03120 3120 1140 5547 5647	$\mathcal{G}(n) = 0$ for $n = 2, 3, 28, 64$ , $\mathcal{G}(n) = 2$ for $n = 26, 30, 33, 34, 59, 95$ , $\mathcal{G}(n) = 3$ for $n = 24, 32, 121$ .
·134	62	51401 12031 20311 0312 2332 6475 4475 62732 21301 13021 3021 1041 5446 3746	$\mathcal{G}(3) = 0$ , $\mathcal{G}(28) = 1$ , $\mathcal{G}(n) = 2$ for $n = 24, 32, 59$ , $\mathcal{G}(n) = 3$ for $n = 26, 30, 34$ .
·152	48	01022201 04323101 32240104 22310132 34010222 01043234	no others
·173	40	01223 10462 01122 75147 22110 23741 32210 46274	$\mathcal{G}(n) = 3$ for $n = 9, 16, 20$ .
·375	18	124814 781482 148174	$\mathcal{G}(4) = 1, \mathcal{G}(n) = 2$ for $n = 5, 8, \mathcal{G}(13) = 7$ , $\mathcal{G}(n) = 3$ for $n = 3, 7, 10, 25$ , $\mathcal{G}(n) = 4$ for $n = 11, 17, 35, \mathcal{G}(n) = 8$ for $n = 18, 36$ .
·524	52	1022104416701 2261446187018 7614761078167 4107210781678	no others
·1[1]5	$4k+10$	11[1]01[1]12[2]21[2]22	none
·1[1]44	$4k+10$	11[1]11[1]22[2]22[2]44	$\mathcal{G}(k+2) = \mathcal{G}(k+3) = 0$ .
·1[1]45	$4k+9$	11[1]11[1]22[2]22[2]4	$\mathcal{G}(k+2) = 0$ .
·1[1]47	$3k+8$	111[1]22[2]24[4]4	$\mathcal{G}(k+2) = 0$ .
·[1]53	$5k+9$	1[1]12[2]21[1]12[2]24[4]	$\mathcal{G}(3k+6) = \mathcal{G}(5k+10) = 0$ .
·[1]54	$4k+7$	[1]11[1]12[2]22[2]4	$\mathcal{G}(k+2) = 0$ .
·1[1][3]77	$12k+20$	1[1]12[2]28[8]1[1]14[4]47[7] 2[2]21[1]18[8]2[2]27[7]44[4]	many

Table 8. Periods of some Octal Games.



1 1	4 4 4	7 2	C 5 5 5 6	8 1 2 2 2	G 5 E N 9 2
1 1 1	4 4 4	8	CC 6 6	8 1 2 2 2	G 5 E 9 2
1 1 2	4 4 4		C 5 6 6 6	8 8 2 2 2	G 5 E N 2 9
1 1 1 2 7	4 4 4		5 C 6 6 B	1 8 2 2	G E 5 N 2
1 1 1 7 4		7 2	CC 6 6 6	8 8 2 2 2	G E 5 N 2 9
1 1 1 4 4 4	7		5 6 6	8 8 1 2 2 2	G 5 E 2 9
1 1 2 8 4 4			CC 6 F	8 8 2 2 2	G R 5 N 2 9
1 1 1 2 7 4 4 4			C 5 6 6 6	8 1 2 2 2	G 5 E N 2 9
1 1 1 8 4 4		2	CC 6 6	8 1 2 2 2	G 5 N S 2
1 1 1 4 4 4 7 2			C 5 6 6 6	8 8 2 2 2	G E 5 N 2 9
1 2 8			5 5 5 6	8 1 8 2 2	G 5 E N 2 9
4 4 1 1 1 2 7			CC 6 6 6	8 8 2 2 2	5 E N S 2
4 4 4 1 1 1 2 8			5 6 6	8 8 1 2 2 2	G 5 E N 2 9
4 4 7 1 1 1			CC 6 F	8 8 1 2 2	G 5 E N 2
4 4 4 7 2 1 1 1			C 5 6 6 6	8 1 2 2 2	G R 5 N 9 2
4 4 4 2 1 2 7			F 5 6 6 6	1 2 2 2	G 5 E N 2 9
4 4 1 1 1 2 2			C 5 6 6 6	8 1 2 2 2	G 5 N 2 9
4 4 7 8 1 1			CC 6 6	8 1 2 2 2	G E 5 2 9
4 4 4 7 2 1 1 1			CC 6 6 6	8 1 1 B 2	G R 5 N S 2
4 4 4 8 1 1 7			5 C 6 6	8 1 2 2 2	G 5 E N 2 9
4 4 4 1 1 1 7			CC 6 6 6	8 8 2 2 2	G 5 E N 2
4 7 8			5 6 6 6	8 1 2 2 2	G R 5 E 2 9
			F 5 6 6 6	8 2 2 2	G 5 E N 2 9
			C 5 6 6 6	8 8 2 2	G 5 N S 2
			C CC 6 6	8 1 2 2 B	G E 5 N 2 9
			CC 6 6 6	8 8 2 2 2	G 5 E N 2
			5 C 6 6 G	1 2 2 2	G R 5 N S 2
			CC 6 6 6	8 8 2 2 2	9 5 E N 2 9
			5 6 6 6	8 1 1 B 2	G 5 N S 2
			C 5 6 6 6	8 2 2 2	G E 5 N 2 9
			C 5 6 6 6	8 8 2 2 B	G 5 N 2 9
			CC 6 6	8 1 2 2 B	G E 5 N 9 2
			C 5 C 6 6 G	8 2 2 2	G 5 E N 2
			5 C 6 6 B	1 8 2 2	G R 5 N 9 2
			K C 6 6 6	8 8 2 2 2	G 5 E N 9 2
			5 C 6 6	8 1 2 2 2	G 5 E 9 2
			CC 6 6 6	8 2 2 2	G R 5 N 2 9
					G E 5 N 2 9
					E 5 N S 2
					G 5 E

Period of **·055**

B=11	F=15	N=23
C=12	G=16	R=27
E=14	K=20	S=28

GFB 5 1 5 1 C 8 6 2 6 2  
 GBF 1 5 1 5 8 C 2 6 2 6  
 BFB 5 1 5 1 C 8 6 2 6 2  
 FBF 1 5 1 5 8 C 2 6 2 6  
 BFB 5 1 5 1 C 8 6 2 6 2  
 FBF 1 5 1

Half-Period of **·356**Period of **·156**Half-period of **·644****Table 9.** Some Long Periods of Octal Games.

## Additional Remarks

Table 8 gives some periods which were too long for display in Table 7. The later entries actually refer to infinitely many games since each bracket [ ] contains a digit which may be repeated the same number,  $k$ , of times ( $k \geq 0$ ). Guy & Smith gave a complete analysis of **·177** which may be called  $\frac{5}{3}$ -plicate Kayles (period 20) whose last exceptional value is  $\mathcal{G}(497) = 8$ . The last entry in Table 8 is a sort of  $(k+1\frac{2}{3})$ -plicate Kayles.

Jack Kenyon discovered the period 349 for **·156** and Richard Austin later found periods 142, 148, 442 and 1550 for **·356**, **·055**, **·644** and **·165**. Table 9 exhibits the noteworthy structure in these periods, except the longest, which you can find in Austin's thesis. As you can see, the second half of the period for **·055** is obtained, with few exceptions, by nim-adding 5 to the first half. For similar reasons only half of the periods of **·356** and **·644** are shown; you can get the other halves by nim-adding 7 to every value except the two values  $G = 16$  in **·356**. More recently the periods 149459, 144, 4 and 4 were found by Anil Gangolli & Thane Plambeck for the games **·16**, **·56**, **·127** and **·376**; the last exceptional values were respectively for  $n = 105350, 326637, 46577$  and  $2268247$ .

The relationship between the structure of the period, if any, and the rules of the game, is an intriguing one. Tom Schaefer has done some investigations into this. Omar will discover numerous features: subperiods, reflexion, repetition, nim-additions, and ...

## Sparse Spaces and Common Cosets

In many take-and-break games some nim-values occur much more often than others. For example in Kayles

0 and 5 happen only once each  
3 and 6 only four times each, while

1, 2, 4, 7, 8

all occur infinitely often with frequencies

$\frac{1}{4}, \frac{1}{4}, \frac{1}{6}, \frac{1}{6}, \frac{1}{6}$

It's not too surprising that the small numbers 1 and 2 happen more often than 4, 7 and 8, but the reason why 0, 3, 5 and 6 occur so rarely is more subtle. Let's look at the binary expansions of the two kinds of value

common values	rare values
...0001 = 1	...0000 = 0
...0010 = 2	...0011 = 3
...0100 = 4	...0101 = 5
...0111 = 7	...0110 = 6
...1000 = 8	...1001 = 9
	...1010 = 10



To help you see the pattern, we've added 9 and 10 (which don't occur) to the rare list. If you've already peeked ahead at Chapter 14 you might recognize that the common values are what we call the *odious* numbers with an odd number of ones in their expansions, while the rare ones are the *evil* ones, with an even number.

However, the property that interests us here is that just for these meanings of the words rare and common we have

$\begin{aligned} \text{rare} \dagger \text{rare} &= \text{rare} = \text{common} \dagger \text{common}, \\ \text{rare} \dagger \text{common} &= \text{common} = \text{common} \dagger \text{rare}. \end{aligned}$
--

There are other octal games which have *different* splittings into rare and common values, but in each case the above relations hold, so that the rare values form a closed space under nim-addition (the **sparse space**) and the common ones its complementary set (the **common coset**).

How does this come about? Look at the nim-values

$$\mathcal{G}(0), \mathcal{G}(1), \mathcal{G}(2), \dots, \mathcal{G}(n-1)$$

for some take-and-break game. Suppose there is a way of separating all numbers into rare and common halves so that the rare half is a closed subspace under nim-addition which happens to contain relatively few of the above numbers. Then

$$\mathcal{G}(n) = \text{mex} \mathcal{G}(i) \dagger \mathcal{G}(j) \quad (i, j < n)$$

taken over certain pairs  $(i, j)$  which depend on the rules of the game. In this most of the *excluded* values will be

$$\text{common} \dagger \text{common} = \text{rare},$$

while a common value will only be excluded when just one of  $\mathcal{G}(i)$  and  $\mathcal{G}(j)$  is rare.  $\mathcal{G}(n)$ , being the first value that *isn't* excluded, is therefore likely to be in the common set.

A space that's sparse so far  
tends to remain so

So once the nim-values in a sequence begin to cluster in a suitable coset of common values, this clustering is likely to persist. Often it shows itself much earlier than the ultimate periodicity; for example the first 25 nim-values of Kayles include 19 occurrences of 1, 2, 4 and 7, but only six of 0, 3, 5 and 6, so that the sparse space is already quite well established.

A division of  $0, 1, 2, \dots, 2^n - 1$  into a sparse space and its common complement can be extended to the numbers  $0, 1, 2, \dots, 2^{n+1} - 1$  in two distinct ways. Thus the division of the first 25 Kayles values into

$$\text{sparse: } 0,3,5,6 \qquad \text{and common: } 1,2,4,7$$

might extend either to

or to

sparse: 0,3,5,6,9,10,12,15	and common: 1,2,4,7,8,11,13,14
sparse: 0,3,5,6,8,11,13,14	and common: 1,2,4,7,9,10,12,15.

However the first few values that exceed 7 are likely to be 8 because numbers larger than 8 can only occur when 8 is excluded, which would require a previous value of 8 or more. More generally:

A new power of two  
is quite likely to  
establish itself as  
a new common value.

So on the basis of the first 25 Kayles values it would be quite reasonable to conjecture that there will be sparse space containing none of

1, 2, 4, 8, 16, ...

explaining the evil-odious division.

## Will Grundy's Game Be Ultimately Periodic?

The sparse space phenomenon was first suggested to us by our computation of the first quarter of a million nim-values for Grundy's Game (divide any heap into two unequal ones). This has a different sparse space, consisting of all numbers whose binary expansions, after deleting the last digit, have an even number of ones. Thus

common	rare
...0010 = 2	...0000 = 0
...0011 = 3	...0001 = 1
...0100 = 4	...0110 = 6
...0101 = 5	...0111 = 7
...1000 = 8	...1010 = 10
...1001 = 9	...1011 = 11
.....	.....

The largest of the first quarter million nim-values for Grundy's Game is 230 and among them there are only 1273 rare ones.  $\mathcal{G}(82860) = 108$  is the only rare value of  $\mathcal{G}(n)$  in the range  $36184 < n \leq 250000$ . Since our first edition, Mike Guy calculated  $10^7$  nim-values, including  $\mathcal{G}(7250049) = 256$ . This remains the only value  $> 249$  with  $n < 47132748$ . Achim Flammenkamp and also Anil Gangolli & Thane Plambeck found that the nim-value  $\mathcal{G}(n) = 256$  then establishes itself as a common value, appearing 3822 times for  $47132748 \leq n \leq 54589100$ ,



and that rare nim-values  $258 \leq \mathcal{G}(n) \leq 265$  occur for 13 such  $n$ , the latest being  $\mathcal{G}(48399022) = 259$ . Dan Hoey finds that for all other  $n < 11 \times 10^9$ ,  $\mathcal{G}(n)$  is a common nim-value less than 292.

If we suppose that the values remain bounded and that the rare ones die out absolutely, as happened for Kayles and seems to be happening for Grundy's Game, then the values must ultimately become periodic, since the value of  $\mathcal{G}(n)$  can be computed from the finitely many nim-values  $\mathcal{G}(n-r)$  for which  $\mathcal{G}(r)$  is rare. We therefore conjecture that the answer to our section heading is

YES!

### Sparse Space Spells Speed

Naively, it would seem that to compute  $\mathcal{G}(250001)$  would require 125000 nim-sum calculations, but we can find the first unexcluded common value after only 1273 nim-sums and  $\mathcal{G}(250001)$  must be either this number or a smaller rare value. We can now proceed by computing further nim-sums until *either* all the smaller rare values are excluded (which will probably happen fairly quickly) *or* (just possibly) we have computed all 125000 nim-sums and established a new rare value. On average we expect this method to find  $\mathcal{G}(n)$  in only a few thousand operations.

We also computed values for the games

**·0007, ·00007, ·000007**

with the following results.

$m$	Smallest value of $n$ for which $\mathcal{G}(n) = m$			
	<b>·007</b>	<b>·0007</b>	<b>·00007</b>	<b>·000007</b>
1	3	4	5	6
2	6	8	10	12
4	15	20	25	30
8	55	75	95	115
16	154	157	190	230
32	434	508	437	530
64	1320	1521	1257	1125
128	3217	5894	3368	2691
256	9168	22337	11776	5425
512	35662	65758	31700	15858
1024	109362	157185	86894	74667
apparent sparse space	???	...11111000	...???10000	...11011110

John Stone has replaced our lost **·007** column; he calculated  $2^{21}$  nim-values, which begin to show a comparative stagnation. The maximum nim-value in this range is  $\mathcal{G}(1683655) = 1314$ ;



the last new nim-value to occur is  $\mathcal{G}(1686918) = 1237$ . The most frequently occurring nim-value in this range is 1024, which occurs 63506 times; the second most frequently occurring is 1026, which occurs 62178 times. There are 37  $\mathcal{P}$ -positions, of which the last occurs at  $n = 16170$ .

## Games Displaying Arithmetic Periodicity

If there are infinitely many non-zero code-digits in the name of the game, the nim-values are usually unbounded and sometimes display arithmetic periodicity of the kind we saw in Lasker's Nim. In Table 10 we show all games  $\cdot d_1 d_2$  ( $= \cdot d_1 d_2 d_2 d_2 \dots$ ),  $\cdot d_1 d_2$  ( $= \cdot d_1 d_2 d_1 d_2 \dots$ ), and  $4 \cdot d_1$  ( $= 4 \cdot d_1 d_1 d_1 d_1 \dots$ ).

$d_2$ $d_1$	0	1	2	3	4	5	6	7	$4 \cdot d_1$
0	*	*	$0\dot{2}$	$0\dot{2}$	$0\dot{4}$	$0\dot{5},*$	$0\dot{2}$	$0\dot{2}$	*
1	*	*	$1\dot{2},1\dot{2}$	$0\dot{2}$	$1\dot{4},1\dot{4}$	*	$1\dot{6},1\dot{6}$	$1\dot{7}$	*
2	*	*	$\dot{2}$	$\dot{2}$	$2\dot{4},*$	$2\dot{5},*$	$\dot{2}$	$\dot{2}$	$\dot{2}$
3	*	*	$3\dot{2}$	$\dot{2}$	$3\dot{4}$	*	$3\dot{2}$	$\dot{2}$	$4 \cdot \dot{3}$
4	$*,0\dot{2}$	$*,1\dot{7}$	$0\dot{2}$	$1\dot{7}$	$0\dot{2}$	$1\dot{7}$	$0\dot{2}$	$1\dot{7}$	$\dot{2}$
5	*	*	$5\dot{2},5\dot{6}$	$5\dot{3},5\dot{7}$	$5\dot{4}$	*	$5\dot{6}$	$5\dot{7}$	*
6	$*,\dot{2}$	$?,\dot{2}$	$\dot{2}$	$\dot{2}$	$\dot{2}$	$\dot{2}$	$\dot{2}$	$\dot{2}$	$\dot{2}$
7	*	*	$3\dot{2}$	$\dot{2}$	$7\dot{4}$	*	$3\dot{2}$	$\dot{2}$	$4 \cdot \dot{7}$

Locator for Games  $\cdot d_1 d_2$ ,  $\cdot d_1 d_2$  and  $4 \cdot d_1$  listed in Table 10.

Two entries in the same place in this game locator refer to the games  $\cdot d_1 d_2$  and  $\cdot d_1 d_2$ ; a single entry refers to both. An asterisk indicates *bounded* nim-values, for example  $\cdot \dot{1}$ ,  $\cdot \dot{5}$ ,  $\cdot 1\dot{5}$ ,  $\cdot 1\dot{5}$ ,  $\cdot 5\dot{1}$ ,  $\cdot 5\dot{1}$ ,  $4 \cdot \dot{1}$  and  $4 \cdot \dot{5}$  each have nim-sequence 0.1;  $\cdot 3\dot{1}$ ,  $\cdot 3\dot{1}$ ,  $\cdot 3\dot{5}$ ,  $\cdot 3\dot{5}$ ,  $\cdot 7\dot{1}$ ,  $\cdot 7\dot{1}$ ,  $\cdot 7\dot{5}$ ,  $\cdot 7\dot{5}$  each have nim-sequence 0.12; while  $\cdot 0\dot{5}$ ,  $\cdot 2\dot{0}$ ,  $\cdot 2\dot{1}$ ,  $\cdot 2\dot{4}$  and  $\cdot 2\dot{5}$  each have nim-sequence 0.01, so they are first cousins of  $\cdot 10\dot{7}$ ,  $\cdot 30\dot{7}$ ,  $\cdot 50\dot{7}$  and  $\cdot 70\dot{7}$ , which are each forms of She-Loves-Me; She-Loves-Me-Not; finally  $4 \cdot \dot{1}$  has nim sequence 0.01122.

The ? in the game locator means that the status of  $\cdot 6\dot{1}$  is unknown; it has been analyzed to  $n = 14999$ ; it may have bounded nim-values.

In Table 10,  $\cdot 0\dot{2}$ ,  $\cdot 0\dot{4}$ ,  $\cdot \dot{2}$ ,  $\cdot 2\dot{4}$  and  $4 \cdot \dot{3}$  are respectively Duplicate Nim, Triplicate Nim, ordinary Nim, Double Duplicate Nim and Lasker's Nim.



game	3rd	cousins 2nd	1st	standard form	nim-sequence, from $\mathcal{G}(1) = 1$	$p$	$s$
$\cdot 0\dot{2}$		$\left\{ \begin{array}{l} \cdot 0\dot{2} \cdot 0\dot{2} \\ \cdot 0\dot{6} \cdot 0\dot{6} \\ \cdot 4\dot{2} \cdot 4\dot{W} \\ \cdot 4\dot{Q} \cdot 4\dot{Q} \end{array} \right\}$	$\cdot 0\dot{3} \cdot 0\dot{3}$ $\cdot 0\dot{7} \cdot 0\dot{7}$	$\cdot 1\dot{3}$ $\cdot 1\dot{3}$	$i\dot{i}(+1)$ i.e. 0.1122334455...	2	1
$\cdot 0\dot{4}$	$\left\{ \begin{array}{l} \cdot 0\dot{4} \\ \cdot 0\dot{4} \end{array} \right\}$	$\cdot 00\dot{7}$	$\cdot 013\dot{7}$	$\cdot 1133\dot{7}$	$i\dot{i}i(+1)$ i.e. 0.111222333...	3	1
$\cdot 0\dot{5}$			$\cdot 0\dot{5}$	$\cdot 11\dot{7}$	$11\dot{i}22\dot{2}(+2)$ i.e. 0.111222344456667...	4	2
$\cdot 1\dot{2}$				$\cdot 1\dot{2}$	$100\dot{2}\dot{2}(+1)$	2	1
$\cdot 1\dot{4}$				$\cdot 1\dot{4}$	$10012\dot{2}22444\dot{4}(+4)$	7	4
$\cdot 1\dot{6}$				$\cdot 1\dot{6}$	$100\dot{2}\dot{2}\dot{3}(+2)$	3	2
$\cdot 1\dot{7}$			$\cdot 4\dot{U} \cdot 4\dot{U}$ $\cdot 4\dot{i}$	$\cdot 1\dot{7}$ $\cdot 1\dot{7}$	$11\dot{2}2\dot{3}(+2)$	3	2
$\cdot 2$		$\left\{ \begin{array}{l} \cdot 2\dot{3} \cdot 2\dot{S} \\ \cdot 2\dot{T} \cdot 2\dot{T} \\ \cdot 6\dot{S} \cdot 6\dot{X} \\ \cdot 6\dot{Z} \\ 4\cdot 2 \cdot 4\cdot \dot{Q} \end{array} \right\}$		$\cdot 3$ $\cdot 3\dot{7}$ $\cdot 3\dot{7}$ $\cdot 7\dot{3}$ $\cdot 7\dot{3}$	$i(+1)$	1	1
$\cdot 2\dot{4}$			$\cdot 2\dot{4}$	$\cdot 30\dot{7}$	$101\dot{2}(+2)$	4	2
$\cdot 2\dot{5}$			$\cdot 2\dot{5}$	$\cdot 31\dot{7}$	$12\dot{i}2345\dot{4}(+4)$	6	4
$\cdot 3\dot{2}$				$\left\{ \begin{array}{l} \cdot 3\dot{2} \cdot 3\dot{2} \\ \cdot 3\dot{6} \cdot 3\dot{6} \\ \cdot 7\dot{2} \cdot 7\dot{2} \\ \cdot 7\dot{6} \cdot 7\dot{6} \end{array} \right\}$	$10\dot{2}(+1)$	1	1
$\cdot 3\dot{4}$				$\cdot 3\dot{4} \cdot 3\dot{4}$	$101\dot{2}3\dot{2}(+2)$	3	2
$\cdot 5\dot{2}$				$\cdot 5\dot{2}$	$1022443355\dot{7}688AA99BB\dot{C}(+8)$	12	8
$\cdot 5\dot{3}$				$\cdot 5\dot{3}$	$11224463355\dot{7}788AAC99BBDD\dot{E}EGGIFHHJJ\dot{K}(+8)$	13	8
$\cdot 5\dot{4}$				$\cdot 5\dot{4}$	$1012\dot{2}244\dot{4}(+4)$	5	4
$\cdot 5\dot{6}$				$\cdot 5\dot{6}$	$10\dot{2}\dot{2}(+2)$	2	2
$\cdot 5\dot{7}$				$\cdot 5\dot{7}$	$11\dot{2}\dot{2}(+2)$	2	2
$\cdot 7\dot{4}$				$\cdot 7\dot{4} \cdot 7\dot{4}$	$1012324546\dot{7}(+4)$	5	4
$\cdot 1\dot{2}$				$\cdot 1\dot{2}$	$\dot{i}0(+1)$	2	1
$\cdot 1\dot{4}$				$\cdot 1\dot{4}$	$10112123\dot{2}44446\dot{6}(+4)$	7	4
$\cdot 1\dot{6}$				$\cdot 1\dot{6}$	$102132\dot{4}4\dot{5}(+2)$	3	2
$4\cdot \dot{3}$				$4\cdot \dot{3}$	$\dot{i}24\dot{3}(+4)$	4	4
$4\cdot \dot{7}$				$4\cdot \dot{7}$	$1\dot{2}(+2)$	1	2

**Table 10.** Guide to Octal Games  $\cdot d_1 \dot{d}_2$ ,  $\cdot \dot{d}_1 \dot{d}_2$  and  $4 \cdot \dot{d}_1$ .

## A Non-Arithmetic-Periodicity Theorem

We've just seen a number of take-and-break games with infinite recurring octal definitions, which exhibit arithmetic periodicity,

$$\mathcal{G}(n+p) = \mathcal{G}(n) + s, \quad s > 0$$

for all large enough  $n$ . Jack Kenyon noticed that this didn't seem to happen for *finite* octal games. Here's why!

As usual the rules of the game tell us that  $\mathcal{G}(n)$  is the mex of certain values

$$\mathcal{G}(i) \dagger \mathcal{G}(j),$$

where  $i+j = n-c$  for one of a finite number of values of  $c$ . If the nim-values were arithmetico-periodic then the *ordinary* sums

$$\mathcal{G}(i) + \mathcal{G}(j),$$

would also assume only finitely many values, of various forms  $\lambda n + \mu$ .

But we'll show that the number of different nim-sums

$$x \dagger y$$

among the pairs for which

$$x + y = \lambda n + \mu$$

is very small compared with  $n$ . It follows that  $\mathcal{G}(n)$ , the first non-excluded value, would also be small compared with  $n$ , contradicting the supposed arithmetico-periodicity.

The number,  $f(N)$ , of nim-sums corresponding to a given ordinary sum  $N$ , can be read from the diagonals of a nim-addition table (Fig. 13).

$$\begin{array}{r} f(N) = 1 \ 1 \ 2 \ 1 \ 3 \ 2 \ 3 \ 1 \ 4 \ 3 \ 5 \ 2 \ 5 \ 3 \ 4 \ 1 \ 5 \ \dots \\ \text{for } N = 0 \ 1 \ 2 \ 3 \ 4 \ 5 \ 6 \ 7 \ 8 \ 9 \ 10 \ 11 \ 12 \ 13 \ 14 \ 15 \ 16 \ \dots \end{array}$$

It satisfies

$$\begin{aligned} f(2n+1) &= f(n) \\ f(2n) &= f(n) + f(n-1), \end{aligned}$$

and since one of  $n$  and  $n-1$  is odd, we have

$$f(N) = f(a) \quad \text{or} \quad f(a) + f(b) \quad \text{where} \quad a \leq \frac{1}{2}N, \quad b \leq \frac{1}{4}N.$$

It follows that

$$f(N) \leq \frac{5}{4}N^\theta \quad (N = 1, 2, 3, \dots)$$

where we define

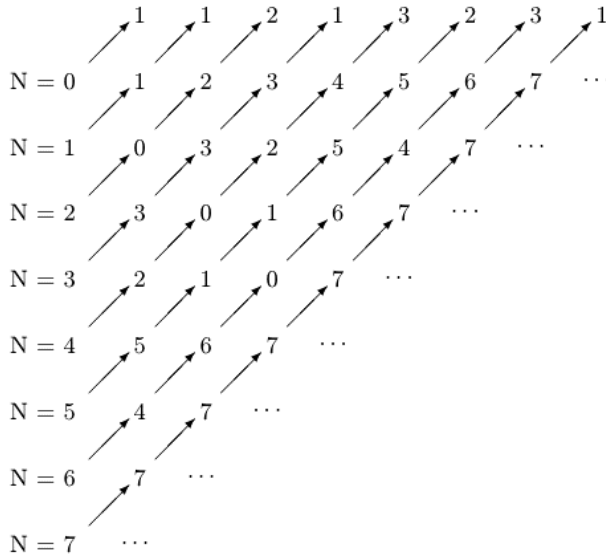
$$\theta = 0.694\dots \quad \text{by} \quad \left(\frac{1}{2}\right)^\theta = \sigma$$

and

$$\sigma = 0.618\dots \quad \text{by} \quad \sigma^2 + \sigma = 1.$$

For after verifying the inequality at  $N = 1$  and  $2$ , we can continue inductively,

$$f(N) \leq f(a) + f(b) \leq \frac{5}{4}\left[\left(\frac{1}{2}N\right)^\theta + \left(\frac{1}{4}N\right)^\theta\right] = \frac{5}{4}(\sigma N^\theta + \sigma^2 N^\theta) = \frac{5}{4}N^\theta.$$



**Figure 13.** Read the Nim-Addition Table Diagonally for  $f(N)$ .

Game	Nim-sequence	
·8	0.000(+1)	First cousin of Triplicate Nim.
·9	0.1000122234445666783838AAAC7C7C5E5EG...	
·A	0.01	First cousin of She-Loves-Me, She-Loves-Me-Not.
·B ·D ·F	0.1	She-Loves-Me, She-Loves-Me-Not.
·C	0.00(+1)	First cousin of Duplicate Nim.
·E	0.01234153215826514...	$\mathcal{G}(246) = 128$ .
·18	0.1000012222344445666678838...	
·19	0.1100002222334444556666888899AAAACCCC77...	
·1A	0.100122(+1)	
·1B	0.110022(+1)	
·1C	0.100102222444466668883333A...	
·1D	0.11012222444466668333...	$\mathcal{G}(240) = 128$ .
·1E	0.1001223445667883...	
·1F	0.1102234456673885...	$\mathcal{G}(207) = 128$ .
·38	0.101021010232345343456...	$\mathcal{G}(301) = 128$ .
·39	0.12010120345343478...	$\mathcal{G}(164) = 77$ .
·3A	0.1021023453456876...	$\mathcal{G}(190) = 121$ .
·3B	0.1201203453456789A...	$\mathcal{G}(206) = 128$ .
·3C	0.10120103234534547678...	
·3D	0.120103453426276...	
·3E	0.102102345345768...	
·3F	0.12012(+3)	Kenyon's Game: take 1 from a heap or take 2 and leave the rest in any number of heaps up to 3.

**Table 11.** Hexadecimal Games are Even More Unruly than Octal Games.

## Some Hexadecimal Games

The hexadecimal games are those with one or more code digits  $\mathbf{d}_k$ ,  $8 \leq \mathbf{d}_k \leq \mathbf{15}$  (compare Table 4). This usually leads to larger nim-values. Jack Kenyon showed that a few of these games are arithmetico-periodic, including  $\cdot\mathbf{3F}$  ( $\mathbf{F}=\mathbf{15}$ ) which has a period of 6 and saltus 3, countering a conjecture of Guy & Smith that the saltus was always a power of 2. Richard Austin found some rather restrictive conditions under which such games are arithmetico-periodic, but usually they seem even less disciplined than octal games. A few examples are given in Table 11: the notation is as in Table 10. Enough nim-values are given to confound your early guesses about the behavior of the games.

## Further References and Reading

- E. W. Adams & E. C. Benson, Nim-type games, Carnegie Inst. Tech. Report **13**, 1956.
- I. Althöfer, Nim games with arbitrary moving orders, *Internat. J. Game Theory* **17**(1988) 165–175.
- I. Althöfer & J. Bültmann, Superlinear period lengths in some subtraction games, *Theoret. Comput. Sci.*, **148**(1995) 111–119.
- Richard Bruce Austin, Impartial and Partisan Games, M.Sc. thesis, The University of Calgary, 1976.
- W. W. Rouse Ball & H. S. M. Coxeter, *Mathematical Recreations & Essays*, 12th edition, University of Toronto, 1974, pp. 36–40.
- H.L.Bodlaender, Kayles on special classes of graphs—an application of Sprague-Grundy theory, in: *Graph-theoretic concepts in computer science* (Wiesbaden-Naurod, 1992), Lecture Notes in Comput. Sci., **657**(1993), Springer, Berlin, pp. 90–102.
- I. Caines, C. Gates, R. K. Guy & R. J. Nowakowski, Periods in taking and splitting games, *Amer. Math. Monthly* **106**, 359–361.
- J. H. Conway, *On Numbers and Games*, Second Edition, A K Peters, Ltd., 2001, Chapter 11.
- Thomas Rayner Dawson, *Fairy Chess Review* (Dec. 1934) p. 94, problem 1603.
- Thomas Rayner Dawson, *Caissa's Wild Roses*, 1935, p. 13.
- Blanche Descartes, Why are series musical? *Eureka*, **16**(1953) 18–20; repr. *ibid* **27**(1964) 29–31.
- Andreas Dress, Achim Flammenkamp & Norbert Pink, Additive periodicity of the Sprague-Grundy function of certain Nim games, *Adv. in Appl. & Math.*, **22**(1999) 249–270; *MR* **2000h**:91007.
- Henry Ernest Dudeney, *Canterbury Puzzles*, London, 1910, pp. 118, 220.
- R. Ehrenborg and E. Steingrímsson, Playing Nim on a simplicial complex, *Electronic J. Combin.*, **3**(1)(1996), #R9, 33pp.[http://www2.combinatorics.org/Volume\\_3/cover.html](http://www2.combinatorics.org/Volume_3/cover.html)
- R. J. Epp & T. S. Ferguson, A note on take-away games, *Fibonacci Quart.*, **18**(1980) 300–303; *MR* **52** #5046.
- Thomas S. Ferguson, On sums of graph games with last player losing, *Internat. J. Game Theory*, **3**(1974) 198–167.
- Achim Flammenkamp, *Lange Perioden in Subtraktions-Spielen*, Hans-Jacob Verlag, 1997; ISBN 3-932136-10-1.
- David Gale & A. Neyman, Nim-like games, *International J. Game Theory*, **11**(1982) 17–20.
- Anil Gangolli & Thane Plambeck. A note on periodicity in some octal games, *Internat. J. Game Theory*, **18**(1989) 311–320.
- S. W. Golomb, A mathematical investigation of games of “take-away”, *J. Combin. Theory*, **1**(1966) 443–458.
- P. M. Grundy, R. S. Scorer & C. A. B. Smith, Some binary games, *Math. Gaz.*, **28**(1944) 96–103.
- Richard Kenneth Guy, She loves me, she loves me not; relatives of two games of Lenstra, *Een Pak met een Korte Broek* (papers presented to H. W. Lenstra), Mathematisch Centrum, Amsterdam.



Richard Kenneth Guy, *Fair Game: how to play impartial combinatorial games*, COMAP Math. Exploration Series, Arlington MA, 1989.

Richard Kenneth Guy, Impartial games, in Richard Nowakowski (ed.) *Games of No Chance*, Cambridge University Press, 1996, pp. 61–78; see also *Proc. Symp. Appl. Math.*, **43**(1991), Amer. Math. Soc., pp. 35–55.

Richard Kenneth Guy & Cedric Austen Bardell Smith, The  $G$ -values for various games, *Proc. Cambridge Philos. Soc.*, **52**(1956) 514–526; *MR* **18**, 546.

John C. Holladay, Cartesian products of termination games, *Ann. Math. Studies, Princeton*. **39**(1957) 189–199.

John C. Holladay, Matrix nim, *Amer. Math. Monthly*, **65**(1958), 107–109.

M. Kano, An edge-removing game on a graph (a generalization of Nim and Kayles), in: *Optimal combinatorial structures on discrete mathematical models* (in Japanese, Kyoto, 1992), Sūri-kaiseikikenkyūsho Kōkyūroku, (1993) pp. 82–90.

M. Kano, Edge-removing games of star type, *Discrete Math.*, **151**(1996), 113–119.

John Charles Kenyon, *Nim-like Games and the Sprague Grundy Theory*, M.Sc. Thesis, The University of Calgary, 1967.

John Charles Kenyon, A Nim-like game with period 349, The University of Calgary Math. Research Paper No. 13, Feb. 1967.

Edward Lasker, *Brettspiele der Völker*, Berlin, 1931, pp. 183–186.

Sam Loyd, *Cyclopedia of Tricks and Puzzles*, New York, 1914, p. 232.

James Propp, A new take-away game, in R. K. Guy & R. E. Woodrow (eds.) *The Lighter Side of Mathematics*, Spectrum Series, Math. Assoc. of America, 1994, pp. 212–221.

Thomas J. Schaefer, Self-sustaining periods in the  $G$ -series of Kayles-like games (unpublished notes, Jan. 1977).

Fred. Schuh, *The Master Book of Mathematical Recreations*, (trans. Frits Göbel, edited Thomas H. O’Beirne), Dover, New York, 1968, Chapters VI, XII.

Cedric Austen Bardell Smith, Graphs and composite games, *J. Combin. Theory*, **1**(1966) 51–81; see also *A Seminar on Graph Theory* (F. Harary, ed.), Holt Reinhart and Winston, 1967.

Cedric Austen Bardell Smith, Compound games with counters, *J. Recreational Math.*, **1**(1968) 67–77.

Neil Y. Wilson, A number problem, *Proc. Edinburgh Math. Soc.*, Vol. II, Part 4 (Nov. 1959) 11–14.

Michael Zieve, Take-away games, in Richard Nowakowski (ed.) *Games of No Chance*, Cambridge University Press, 1996, pp. 351–361.

-5-

# Numbers, Nimbers and Numberless Wonders

Acquaintance I would have, but when't depends

Not on the number, but the choice of friends.

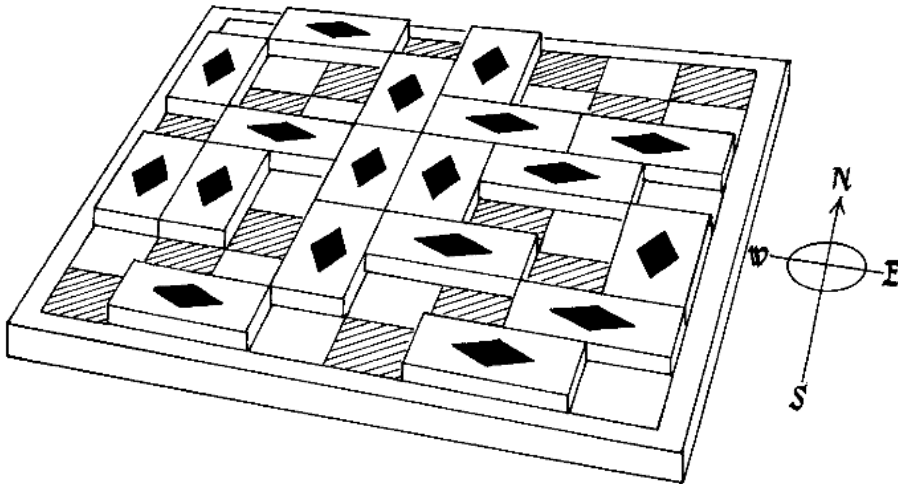
Abraham Cowley, *Of Myself*.

To numbers I'll not be confined.

Sir Charles Hanbury Williams, *A Ballad in Imitation of Martial*.

## Domineering

This game has been considered by Göran Andersson and has also been called Crosscram and Dominoes. Left and Right take turns in placing dominoes on a checker-board. Left orients his dominoes North-South and Right East-West. Each domino must exactly cover two squares of



**Figure 1.** A Game of Domineering.



the board and no two dominoes may overlap. A player who can find no room for one of his dominoes loses.

After a time the available space may separate into several disconnected regions, and then the game for the whole board will be the sum of several smaller games corresponding to these. In Fig. 2 we display values of all regions with five squares or fewer. A square may be added to any *one* of the indicated edges without affecting the value of the region. Some other values are given in the Extras to this chapter.

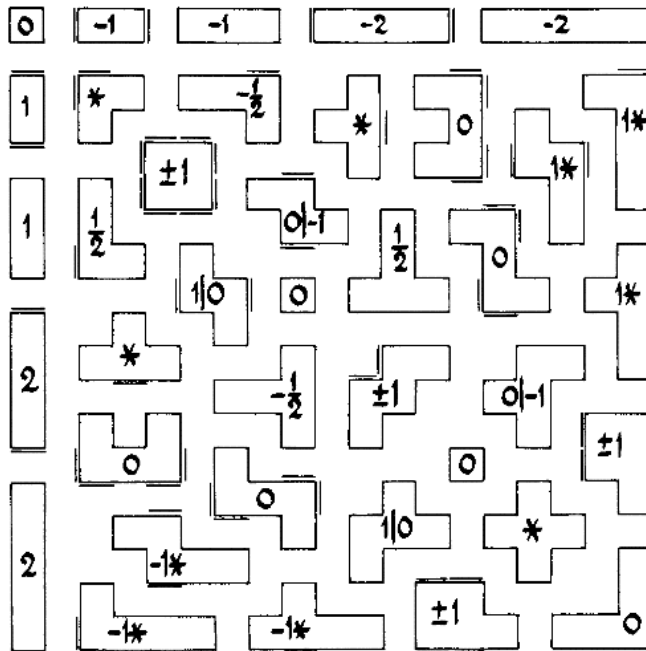


Figure 2. Values of Domineering Positions ( $\pm 1$  means  $1 \mid -1$ ).

We discuss some of the more interesting simple cases. The positions

$$\begin{array}{|c|c|} \hline \square & \square \\ \hline \square & \square \\ \hline \end{array} = \left\{ \begin{array}{|c|c|} \hline \square & \square \\ \hline \square & \square \\ \hline \end{array} \mid \begin{array}{|c|c|} \hline \square & \square \\ \hline \square & \square \\ \hline \end{array} \right\} = \{0 \mid 0\} = *$$

$$\begin{array}{|c|c|} \hline \square & \square \\ \hline \square & \square \\ \hline \square & \square \\ \hline \end{array} = \left\{ \begin{array}{|c|c|} \hline \square & \square \\ \hline \square & \square \\ \hline \square & \square \\ \hline \end{array} \mid \begin{array}{|c|c|} \hline \square & \square \\ \hline \square & \square \\ \hline \square & \square \\ \hline \end{array} \right\} = \{-1, 0 \mid 1\} = \frac{1}{2}$$



yield two old friends, but we also find some new values:

$$\begin{array}{c} \begin{array}{|c|c|} \hline \square & \square \\ \hline \square & \square \\ \hline \end{array} = \left\{ \begin{array}{|c|c|} \hline \square & \square \\ \hline \square & \square \\ \hline \end{array} \left| \begin{array}{|c|c|} \hline \square & \square \\ \hline \square & \square \\ \hline \end{array} \right. \right\} = \{1 \mid -1\} \\ \\ \begin{array}{|c|c|c|} \hline \square & & \\ \hline \square & \square & \\ \hline & \square & \square \\ \hline \end{array} = \left\{ \begin{array}{|c|c|c|} \hline \square & & \\ \hline \square & \square & \\ \hline & \square & \square \\ \hline \end{array} \left| \begin{array}{|c|c|c|} \hline \square & & \\ \hline \square & \square & \\ \hline & \square & \square \\ \hline \end{array} \right. \right\} = \{1 \mid 0\} \end{array}$$

How shall we reckon with these?

## Switch Games

In a position  $\{x \mid y\}$  where  $x$  and  $y$  are numbers and  $x \geq y$ , each player will be keen to move first, since he prefers the effect of his own move to that of his opponent's. Although this feature is common in real-life games we have tended to avoid it in our carefully chosen examples. How do such **switch values** compare with ordinary numbers? As a more interesting

example we consider  $\begin{array}{|c|c|c|} \hline \square & \square & \square \\ \hline \square & \square & \square \\ \hline \end{array} = \{2 \mid -\frac{1}{2}\}$  in which Left's best move is to  $\begin{array}{|c|} \hline \square \\ \hline \end{array} + \begin{array}{|c|} \hline \square \\ \hline \end{array} = 2$ , and

Right's moves lead to positions like  $\begin{array}{|c|c|c|} \hline \square & & \\ \hline \square & \square & \\ \hline \end{array}$  of value  $-\frac{1}{2}$ , the negative of  $\begin{array}{|c|} \hline \square \\ \hline \square \\ \hline \end{array} = \frac{1}{2}$ .

If  $z$  is a number, Left's best option from  $\{2 \mid -\frac{1}{2}\} - z$  is to  $2 - z$ , and so he can win only if  $z \leq 2$ . Right's best option is to  $-\frac{1}{2} - z$ , so that *he* can win only if  $z \geq -\frac{1}{2}$ . We conclude that

$$\begin{array}{ll} \text{for } z > 2, & z > \{2 \mid -\frac{1}{2}\} \\ \text{for } z < -\frac{1}{2}, & z < \{2 \mid -\frac{1}{2}\} \\ \text{for } -\frac{1}{2} \leq z \leq 2, & z \parallel \{2 \mid -\frac{1}{2}\} \end{array}$$

as illustrated in Fig. 3.

More generally:

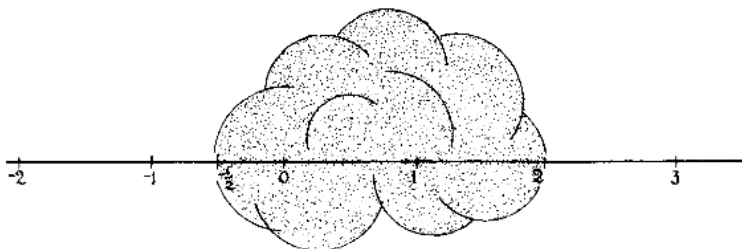
If  $x$  and  $y$  are numbers and  $x \geq y$ , then for any number  $z$ :

$$z > x \text{ implies } z > \{x \mid y\},$$

$$z < y \text{ implies } z < \{x \mid y\},$$

$$y \leq z \leq x \text{ implies } z \parallel \{x \mid y\}.$$

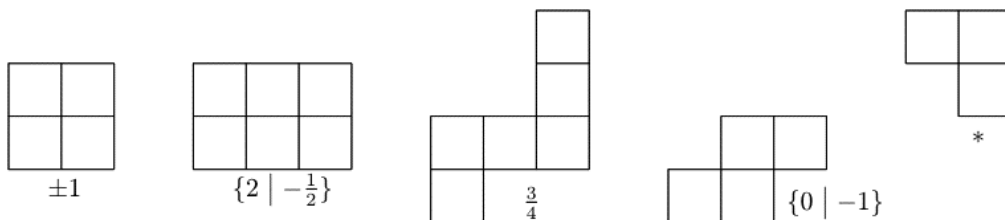
COMPARING NUMBERS WITH SWITCHES



**Figure 3.** Where is  $\begin{array}{|c|c|} \hline & \\ \hline & \\ \hline \end{array} = \{2 \mid -\frac{1}{2}\}$  ?

### Cashing Cheques

Figure 4 shows the usable regions of the Domineering position of Fig. 1 with their values. Who should win?



**Figure 4.** The Available Regions of Figure 1.

More generally, how do we cope with any sum of values each of which is either a number,  $z$ , or a switch  $\{x \mid y\}$ ? In particular, what happens for the game  $\{x \mid y\} + z$ ? It is easy to guess the answer:

If  $x, y$  and  $z$  are numbers, and  $x \geq y$ , then each player should prefer to move in  $\{x \mid y\}$  rather than in  $z$ .  
 In symbols  

$$\{x \mid y\} + z = \{x + z \mid y + z\}$$

#### ADDING NUMBERS TO SWITCHES

This is also easy to prove, for since  $\{x \mid y\}$  is less than any number strictly greater than  $x$ , Left's other option  $\{x \mid y\} + z^L$  will be less than any number greater than  $x + z^L$ , and so less than his sensible option  $x + z$ . So for example we have

$$\{2 \mid -\frac{1}{2}\} + 5 = \{7 \mid 4\frac{1}{2}\}, \quad \{2 \mid -\frac{1}{2}\} - \frac{3}{4} = \{1\frac{1}{4} \mid -1\frac{1}{4}\}.$$

We can use this principle to eliminate the bias from any value like  $\{x \mid y\}$ :

If  $x$  and  $y$  are numbers with  $x \geq y$ , then  
 $\{x \mid y\} = u + \{v \mid -v\} = u \pm v$ , say,  
 where  $u = \frac{1}{2}(x + y)$ ,  $v = \frac{1}{2}(x - y)$ .

#### CENTRALIZING SWITCHES

So any sum of such terms reduces to the sum of a collection of terms of form  $\{v \mid -v\}$  for various  $v$ , together with an ordinary number. We shall write  $\pm v$  for  $\{v \mid -v\}$ , and more generally

$$z \pm a \pm b \pm c \pm \dots$$

for

$$z + \{a \mid -a\} + \{b \mid -b\} + \{c \mid -c\} + \dots$$

We may think of a position of value  $\pm v$  as a cheque for  $v$  moves, payable to whoever moves in it, while the ordinary number term represents the difference between the bank balances of Left and Right.

In the game of Cashing Cheques, each player starts with a sum of money, and there are a number of cheques (or coins) on the table, already made out for various amounts. The players

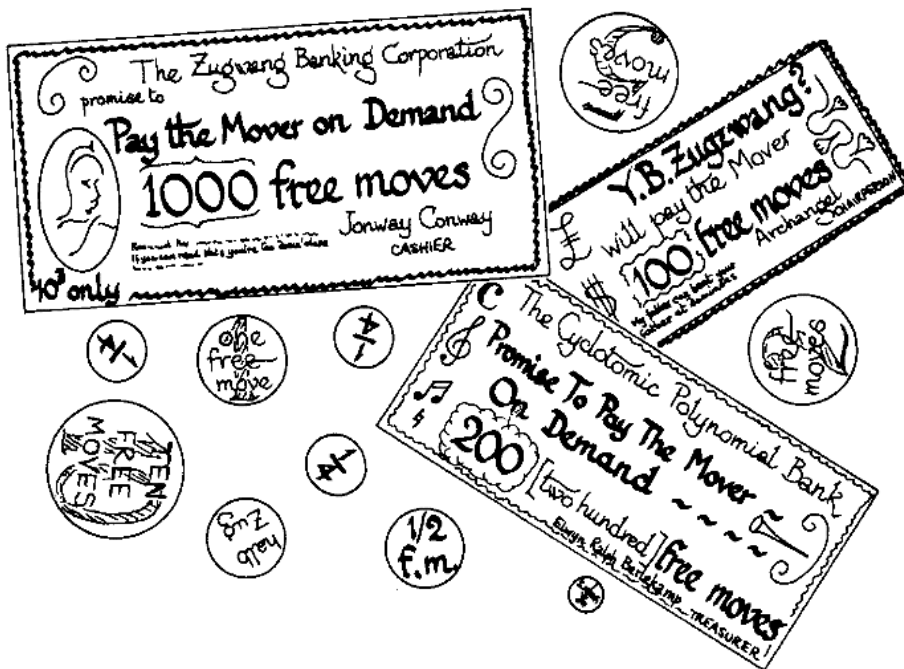


Figure 5. Some Cheques Ready for Cashing.



alternately appropriate these cheques, and at the end of the game the winner is whoever has the larger amount of money in all, except that if both have exactly the same amount, the last to cash a cheque is the winner.

No worldly reader will have much difficulty planning his moves in this game. Obviously, whoever goes first will grab the largest available amount, his opponent will grab the next largest, and so on until we find ourselves fighting over the quarters. So the game

$$z \pm a \pm b \pm c \pm \dots \quad (a \geq b \geq c \geq \dots \geq 0)$$

will soon become

$$z + a - b + c - \dots$$

if Left starts, and

$$z - a + b - c + \dots$$

if Right starts. Moreover, we can tell whose turn it is to move next, for the number of moves made so far is simply the total number of terms of form  $\pm v$ . Knowing this, it is easy to see who wins in any particular case.

There is no need to reduce the switches  $\{x \mid y\}$  to the form  $u \pm v$  before applying this method. Since the value of  $v$  is  $\frac{1}{2}(x - y)$ , which we call the **temperature** of  $\{x \mid y\}$ , the policy is simply:

In any sum of switches  $\{x \mid y\}$ , together possibly with a number, move in any  $\{x \mid y\}$  having the largest possible temperature  $\frac{1}{2}(x - y)$ .

When the dust has settled after these moves the result will be a number which tells us the winner. Of course, when this number is 0, the outcome depends on whose turn it is to move.

#### THE TEMPERATURE POLICY FOR SWITCHES

The values in Fig. 4, arranged in decreasing order of temperature, with the number at the end, are

$$\{2 \mid -\frac{1}{2}\}, \{1 \mid -1\}, \{0 \mid -1\}, \{0 \mid 0\} \text{ and } \frac{3}{4}.$$

So if Left starts, after four moves we reach the number

$$2 - 1 + 0 + 0 + \frac{3}{4} = 1\frac{3}{4}$$


while if Right starts, the opposing four moves lead to

$$-\frac{1}{2} + 1 - 1 + 0 + \frac{3}{4} = \frac{1}{4}.$$

Since both numbers are positive, so is the whole game, and Left can win no matter who starts.

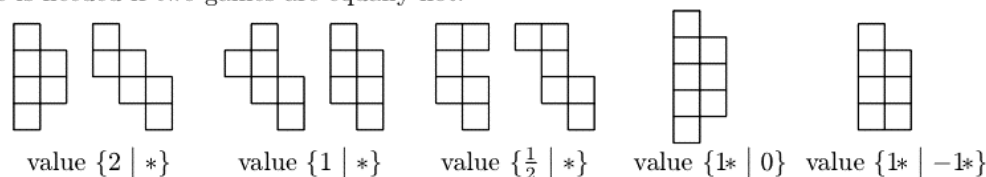
Suppose however that Left stupidly moves in the bottom left-hand corner, so converting

the region of value  $\frac{3}{4}$  to , value  $\frac{1}{2}$ . Will Right be able to win if Left makes no other lapses?

No! Although Right is better off, in that the value after four moves will be 0 rather than  $\frac{1}{4}$ , he will still lose because it will be his turn to move. What would have happened had Left instead made his first move in the top right-hand corner, so creating a second region  of value  $\pm 1$ ?

## Some Simple Hot Games

Positions like the ones we've just been discussing, in which both players are eager to move, naturally make for exciting play and so may be called **hot**. Thus  $\pm 1$  is hot, but  $\pm 1000$  is hotter still, indeed it has a temperature of  $1000^\circ$  on the natural scale. Some new hot values appear in the positions of Fig. 6. They are all of the form  $\{x \mid y^*\}$ ,  $\{x^* \mid y\}$  or  $\{x^* \mid y^*\}$ , with  $x \geq y$ . The temperature policy we laid down for sums of ordinary switches  $\{x \mid y\}$  extends to include these: we still move in the game with the greatest temperature  $\frac{1}{2}(x - y)$ . But some care is needed if two games are equally hot.



**Figure 6.** Heat Associated with Stars.

We have the identities:

$$\begin{aligned} \{x \mid y\} + * &= \{x^* \mid y^*\} \quad (x \geq y) \\ \{x \mid y^*\} + * &= \{x^* \mid y\} \quad (x > y) \end{aligned}$$

So the value of the last region of Fig. 6 can be written in several forms:

$$\begin{array}{|c|c|} \hline & \\ \hline & \\ \hline & \\ \hline & \\ \hline \end{array} = \{1^* \mid -1^*\} = \pm(1^*) = \pm 1 + * = \pm 1^*, \text{ say.}$$

## The Tiniest Games

The value of the position

$$\begin{array}{|c|c|} \hline & \\ \hline & \\ \hline & \\ \hline & \\ \hline \end{array} = \left\{ \begin{array}{|c|c|} \hline & \\ \hline & \\ \hline & \\ \hline & \\ \hline \end{array} , \begin{array}{|c|c|} \hline & \\ \hline & \\ \hline & \\ \hline & \\ \hline \end{array} \mid \begin{array}{|c|c|} \hline & \\ \hline & \\ \hline & \\ \hline & \\ \hline \end{array} , \begin{array}{|c|c|} \hline & \\ \hline & \\ \hline & \\ \hline & \\ \hline \end{array} \right\}$$

$$= \{ 0, \quad \{2 \mid 0\} \mid \{0 \mid -2\}, \{ \frac{1}{2} \mid -2\} \}$$

simplifies on bypassing Left's reversible move and omitting Right's dominated one, to

$$\{0 \mid \{0 \mid -2\}\}.$$

It turns out that this value, though positive, is very small indeed, much smaller than  $\uparrow$ , and we shall write it  $+_2$  and pronounce it "**tiny-two**". More generally there is a game "**tiny- $x$** ", namely

$$+_x = \{0 \mid \{0 \mid -x\}\}$$



for any value  $x$ , and as  $x$  gets larger  $+_x$  gets smaller, very rapidly. Indeed, if  $x$  and  $y$  are numbers with  $x > y \geq 0$ , then  $+_x$  is so much smaller than  $+_y$  that no matter how many terms  $+_x$  we add to each other, the sum will be less than  $+_y$ . So any multiple of  $+\frac{1}{4}$  will be less than  $\uparrow$ , for we have

$$+_0 = \{0 \mid \{0 \mid 0\}\} = \{0 \mid *\} = \uparrow.$$

The negative of  $+_x$  is, of course

$$-_x = \{\{x \mid 0\} \mid 0\}.$$

We may pronounce this “**miny**- $x$ ”! For sums involving tinies and minies we use natural abbreviations, thus

$$\begin{aligned} 1+_2 &= 1 + (+_2) = 1 + \{0 \mid \{0 \mid -2\}\} = \{1 \mid \{1 \mid -1\}\} = \{1 \mid \pm 1\} \\ \frac{1}{2}-\frac{1}{4} &= \frac{1}{2} + (-\frac{1}{4}) = \frac{1}{2} + \{\{\frac{1}{4} \mid 0\} \mid 0\} = \{\{\frac{3}{4} \mid \frac{1}{2}\} \mid \frac{1}{2}\}. \end{aligned}$$

## Modern Management of Cash Flow

The tiny game

$$+_{500} = \{0 \mid \{0 \mid -500\}\}$$

may be interpreted as a clause in the fine print of a contract which reads:

If Left has not yet filed form XYZ, then Right may issue a formal request that he do so. After such a request has been issued, on any subsequent turn on which Left has still not filed the form, Right may file a decree compelling Left to forfeit a penalty of 500 moves.

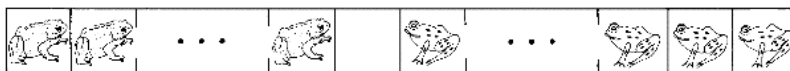
The reason that this clause gives no competitive advantage to Right is that issuing the request requires just as much effort (one turn) as filing the form. In fact, careful analysis reveals that the clause gives a tiny advantage to Left, because he has the option of filing the form even before it's requested. Not surprisingly, the amount of this tiny advantage decreases rapidly with the increasing value of the penalty which may be imposed for failure to comply with the formal request.

In a sum of tinies and minies, each player emulates the modern businessman who is quick to bill but slow to pay, even though the effort required to issue an invoice is the same as the effort needed to write a cheque. The optimal cash management strategy may be to postpone payment of every bill until the prospect of a penalty is imminent. Every payment is made just prior to its deadline, so no penalties need ever actually be invoked. Thus, issuing a formal request which threatens the opponent with the prospect of a larger penalty always takes precedence over responding to any outstanding smaller threat. In any well-played sum of tinies and minies, the games are completed in order of *increasing* magnitude.

The tinies and minies receive the highest priorities because they are associated with the transactions involving the largest potential penalties. In the end, the outcome of the sum depends only on the sign of the largest component. The winner is the accounts-payable manager who can set the longest record for slow payment while still avoiding any penalty. The explanation for his success is that he holds the purchasing contract on which the penalty for late payment is minimal.

## Tiny Toads-and-Frogs

We return to the game of Toads-and-Frogs and consider some positions in which the numbers of toads and frogs need not be equal, but each lane has just one empty space. The  $(l, r)$  game is that whose starting position is



in which Left has  $l$  toads and Right  $r$  frogs. It turns out that the position



resulting from Right's first move in the  $(3,2)$  game has the value  $-\frac{1}{4}$  and other tiny and miny values arise from longer Toads-and-Frogs positions. Let's see how this comes about.

First observe the

### DEATH LEAP PRINCIPLE

If the only legal moves from some position are jumps, the value is 0.

This applies just when there is neither a toad immediately to the left of the space, nor a frog immediately to its right. In such positions the first player's later moves are also necessarily jumps and always clear a space for his opponent to reply. Now we can deduce that

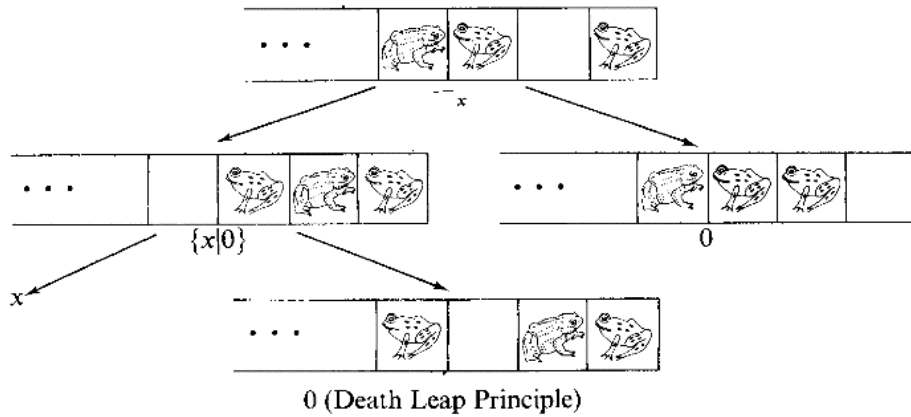
the value of any position of the form

is  $-x$ , where  $x$  is the value of the position obtained by making two toad moves, or is  $-\frac{1}{2}$  ( $= -_{-2}$ ) if only one toad move can be made.

Figure 7 illustrates this.

## The Opening Dissection of Toads-and-Frogs

We can now evaluate the initial position of any game  $(l, r)$  of Toads-and-Frogs with one empty space.



**Figure 7.** Miny Toads and Frogs.

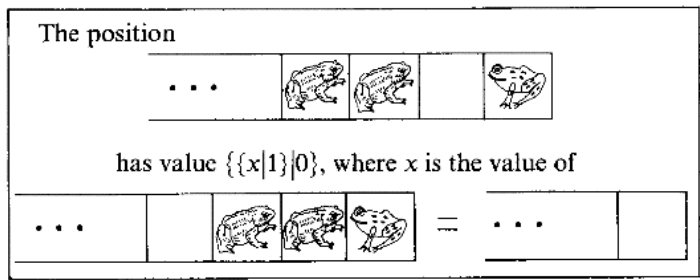
Trivially:

If  $r = 0$ , the value is  $l$ .

However,

If  $r = 1$  and  $l \geq 1$ , the value is  $\{\{l-2 \mid 1\} \mid 0\}$ .

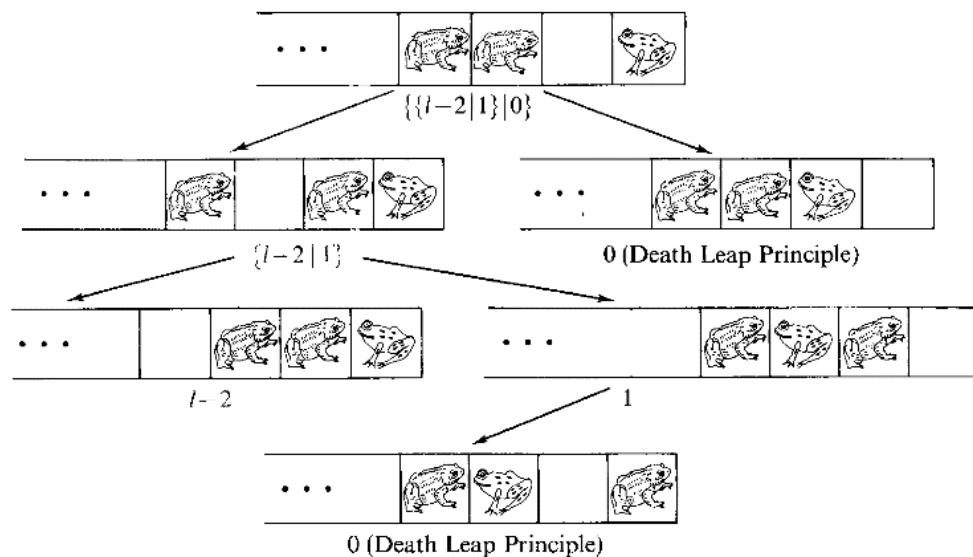
This is proved (for  $l \geq 2$ ) by Fig. 8. In fact the same figure proves the more general result:



The remaining initial positions are covered by

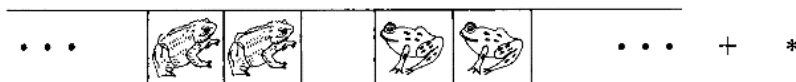
If  $r \geq 2, l \geq 2$ , the initial position of  $(l, r)$  has value  $*$ .





**Figure 8.** A Lone Frog Faces Toads.

The skeptical reader should play the game



as second player, always playing in the Toads-and-Frogs component if he can. He will find that after a few moves the Death Leap Principle applies.

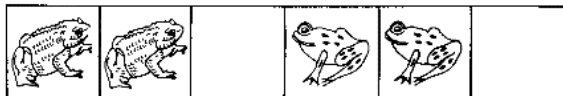
Our results on initial positions are summarized in Table 1. To save space we have omitted the braces, writing  $1* \mid 0$  for  $\{1* \mid 0\}$ , etc. Since  $2 \mid 1 \mid 0$  would be ambiguous we have introduced  $\parallel$  (“slashes”) as a stronger form of  $\mid$ . Thus  $2 \mid 1 \parallel 0$  means  $\{\{2 \mid 1\} \mid 0\}$ , whereas  $2 \parallel 1 \mid 0$  would mean  $\{2 \mid \{1 \mid 0\}\}$ .

	$r = 0$	1	2	3	4	5	6
$l = 0$	0	-1	-2	-3	-4	-5	-6
1	1	*	$0 \mid -\frac{1}{2}$	$0 \mid -1*$	$0 \parallel -1 \mid -2$	$0 \parallel -1 \mid -3$	$0 \parallel -1 \mid -4$
2	2	$\frac{1}{2} \mid 0$	*	*	*	*	*
3	3	$1* \mid 0$	*	*	*	*	*
4	4	$2 \mid 1 \parallel 0$	*	*	*	*	*
5	5	$3 \mid 1 \parallel 0$	*	*	*	*	*
6	6	$4 \mid 1 \parallel 0$	*	*	*	*	*

**Table 1.** Initial Values for Toads-and-Frogs.



In the Extras to this chapter we evaluate a number of other Toads-and-Frogs positions. The position



with two empty spaces has value  $\{\frac{1}{4} \mid \downarrow\}$ . Our policy about playing in the hottest game still applies to sums involving such values, but it can be hard to make the correct choice when several components are equally hot.

Figure 9 shows a Toads-and-Frogs position chosen so as to make these ideas clear. We suppose that it is Left's turn to move. To help him we have appended the values (see the Extras to this chapter) and arranged the lanes in decreasing order of temperature. What should he do?

	value	temperature $\frac{1}{2}(x-y)$																																				
<table border="1" style="border-collapse: collapse; text-align: center; width: 150px; height: 150px;"> <tr><td>T</td><td>T</td><td>F</td><td></td><td>F</td><td>F</td></tr> <tr><td></td><td>F</td><td>T</td><td>T</td><td></td><td>F</td></tr> <tr><td>T</td><td>F</td><td>T</td><td></td><td>F</td><td>F</td></tr> <tr><td>T</td><td>T</td><td></td><td>F</td><td>F</td><td></td></tr> <tr><td>F</td><td>T</td><td>T</td><td></td><td>T</td><td>F</td></tr> <tr><td>T</td><td></td><td>T</td><td>F</td><td>F</td><td>T</td></tr> </table>	T	T	F		F	F		F	T	T		F	T	F	T		F	F	T	T		F	F		F	T	T		T	F	T		T	F	F	T	$* \mid -1$ $-\frac{1}{2} \mid -1$ $0 \mid -\frac{1}{4}$ $\frac{1}{4} \mid \downarrow$ $1 \mid 1 = 1*$ $0 \mid * = \uparrow$	$\frac{1}{2}$ $\frac{1}{4}$ $\frac{1}{8}$ $\frac{1}{8}$ $0$ $0$
T	T	F		F	F																																	
	F	T	T		F																																	
T	F	T		F	F																																	
T	T		F	F																																		
F	T	T		T	F																																	
T		T	F	F	T																																	

**Figure 9.** Left to Move and Win.

There is no room for doubt about the first moves of the two players. Left moves from the hottest game  $* \mid -1$ , to  $*$ , and Right then converts the next hottest game,  $-\frac{1}{2} \mid -1$ , to  $-1$ .

But now Left faces a dilemma, since the next two games,  $0 \mid -\frac{1}{4}$  and  $\frac{1}{4} \mid \downarrow$ , are equally hot. If Left moves in  $0 \mid -\frac{1}{4}$  and Right in  $\frac{1}{4} \mid \downarrow$ , the value will become

$$* - 1 + 0 + \downarrow + 1* + \uparrow = 0,$$

a win for Right, as the most recent mover. But if instead Left moves in  $\frac{1}{4} \mid \downarrow$  and Right in  $0 \mid -\frac{1}{4}$ , the value will be

$$* - 1 + \frac{1}{4} - \frac{1}{4} + 1* + \uparrow = \uparrow,$$

a clear win for Left. We might have guessed this, for since the difference between  $\frac{1}{4}$  and  $\downarrow$  is greater than that between  $0$  and  $-\frac{1}{4}$ , the value  $\frac{1}{4} \mid \downarrow$  is really just a little bit hotter than  $0 \mid -\frac{1}{4}$ , and should perhaps have been placed above it. But neither of  $1 \mid *$  and  $0 \mid -1$  can be considered hotter than the other, for in their sum

$$\{1 \mid *\} + \{0 \mid -1\}$$

Left should prefer to move from the latter and Right from the former. Find the best starting move for each player from the 3-lane Toads-and-Frogs position of Fig. 10

F	T		F	F	F	value	0   -1*
T		F		F	T	value	-1*
T	T	T		T	F	value	2   1

**Figure 10.** What Are the Best Moves?

Positions involving tinies and minies can be even more difficult, and the temperature policy may suggest the wrong move. If Left starts and both players apply the temperature policy from

	T	T		F	T	value	temperature
	T	T		F	T	$\frac{1}{2}   0$	$\frac{1}{4}$
T	F	T		F	F	$0   -\frac{1}{4}$	$\frac{1}{8}$
T		T	F	F	F	$+\frac{1}{4}$	0
	T	T	F		F	$-\frac{1}{4}$	0

the value after two moves will be

$$\frac{1}{2} - \frac{1}{4} + +\frac{1}{4} - \frac{1}{4} = +\frac{1}{4},$$

a win for Left.

However, if Right had responded to Left's opening by moving from

$$+\frac{1}{4} = \{0 | \{0 | -\frac{1}{4}\}\}$$

to  $0 | -\frac{1}{4}$ , the resulting value would have been

$$\frac{1}{2} + \{0 | -\frac{1}{4}\} + \{0 | -\frac{1}{4}\} - \frac{1}{4},$$

which after two more moves becomes

$$\frac{1}{2} + 0 - \frac{1}{4} - \frac{1}{4} = 0,$$

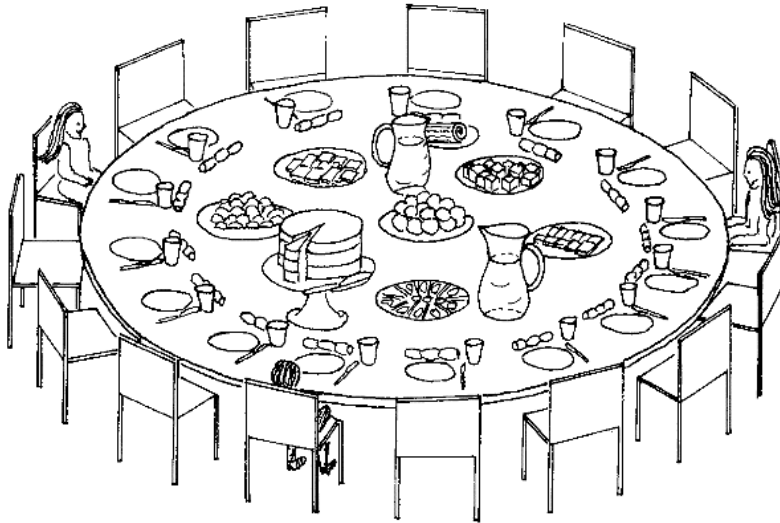
a win for Right, the last mover. We can say that  $+\frac{1}{4}$  possesses **latent heat** since it has the hot option  $0 | -\frac{1}{4}$ . The temperature policy works with games whose options are like

$$x, \quad x + *, \quad x + \uparrow, \quad x + *2, \quad x + \uparrow + *$$

for any number  $x$ , since these have no latent heat.

## Seating Boys and Girls

Let's have a children's party to celebrate the end of this chapter. Left will seat the boys and Right the girls round the table shown in Fig. 11. To preserve decorum no child may be seated next to another of the opposite sex. Whichever of Left and Right is first unable to seat a child must cope with the angry parents.



**Figure 11.** Where Does Left Seat the Next Boy?

This is rather like the game of Seating Couples from Chapter 2, with the difference that a player’s move effectively reserves the adjacent seats, if empty, for him rather than for his opponent. We use

- $LnL$  for a row of  $n$  empty chairs between two boys,
- $RnR$  for a row of  $n$  empty chairs between two girls, and
- $LnR$  for a row of  $n$  empty chairs between a boy and a girl.

The values are computed using the equations

$$\begin{aligned} LnL &= \{LaL + LbL | LaR + RbL\} \\ RnR &= \{RaL + LbR | RaR + RbR\} \quad (= -LnL) \\ LnR &= \{LaL + LbR | LaR + RbR\} \quad (= RnL) \end{aligned}$$

where  $a$  and  $b$  are any numbers adding to  $n-1$  *except* that  $L0R$  and  $R0L$  are illegal. These look like the equations for Seating Couples (Chapter 2). However, the values are hotter, as in Table 2.

$n$	0	1	2	3	4	5	6
$LnL$	0	1	2	2   0	3   *	{4   0, ±1}	{3   *} ± 1
$LnR$	—	0	*	±1	±2	±2*	±2 ± 1
$RnR$	0	-1	-2	0   -2	*   -3	{±1, 0   -4}	{*   -3} ± 1

**Table 2.** Values of Positions in Seating Boys and Girls.

In Fig. 11 can Left win?

# Extras

In Fig. 10 the only good move for Left is in the first lane and the only good move for Right is in the last.

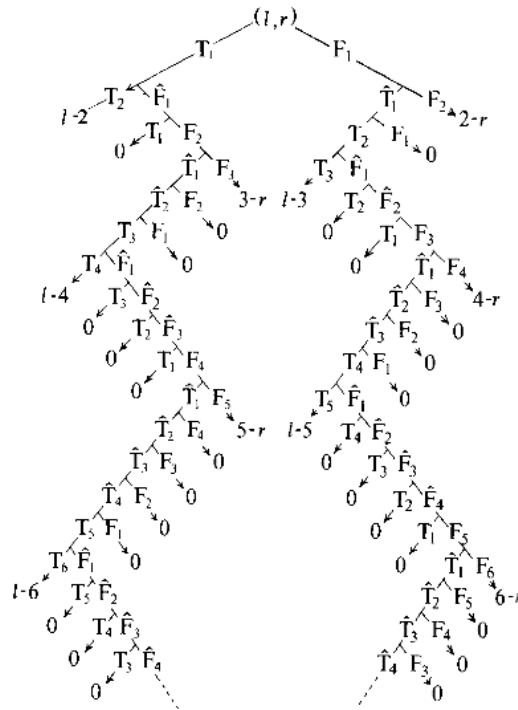
Left cannot win the position R5R, R4L, L3R in Seating Boys and Girls shown in Fig. 11. The value is

$$\{\pm 1, 0 \mid -4\} \pm 2 \pm 1.$$

If Left plays in the first component (seats a boy on the far side of the table) Right seats a girl by the near jug of lemonade, while if he seats a boy anywhere else, Right seats a girl opposite the far jug, securing four more seats for girls.

## Toads-and-Frogs Completely Dissected

Figure 12 represents the moves from the general initial position  $(l, r)$  in 1-space Toads-and-Frogs.



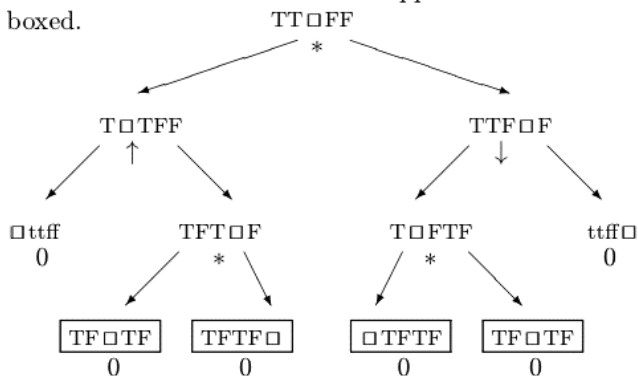
**Figure 12.** A General Analysis of 1-space Toads-and-Frogs.



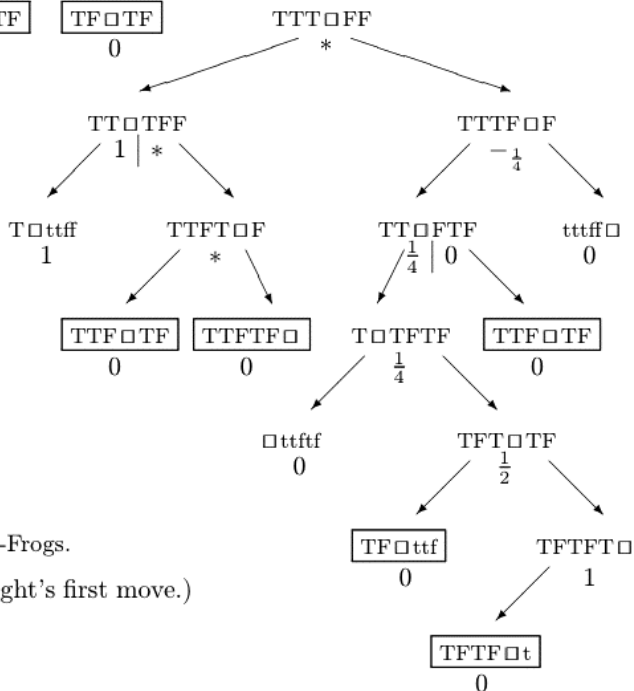
Each edge is labelled so as to show exactly which creature makes the corresponding move (the creatures of each species being numbered from the initial space outwards); a circumflex indicates that the move is a jump. There are only two ways of leaving the main zig-zags of the figure: the positions marked 0 are instances of the Death Leap Principle, and those marked with the integers

$$l-2, l-3, l-4, \dots \quad \text{or} \quad 2-r, 3-r, 4-r, \dots$$

are cases in which only toads or only frogs are able to move from now on. The values in any particular case can be found by omitting moves which would be made by non-existent animals. Figures 13 to 16 illustrate the cases  $(l, r) = (2, 2), (3, 2), (4, 2)$  and  $(3, 3)$ , which together with  $(l, 1)$  (which we have already discussed) and their negatives suffice for positions with up to 7 places and only 1 space. **Dead** animals, no longer able to move, are indicated by lower case letters. Positions where further application of the Death Leap Principle has been made are boxed.

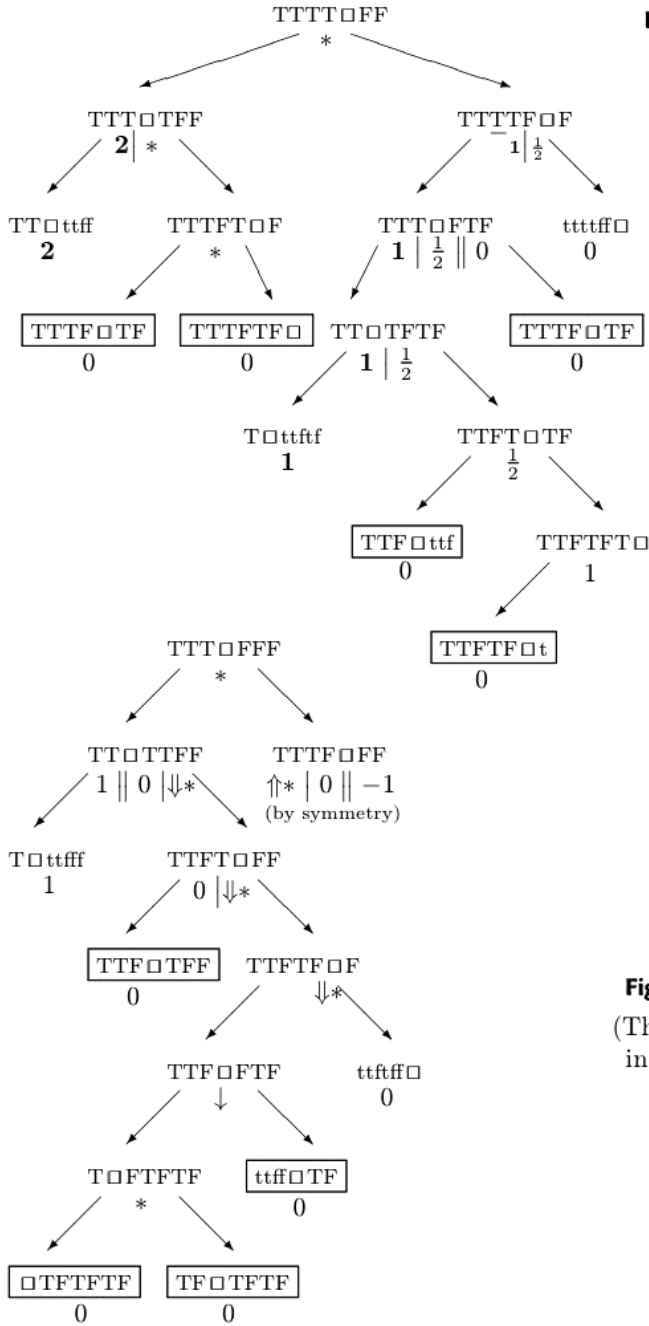


**Figure 13.**  
5-place Toads-and-Frogs  
(Of course, this is an abbreviated  
form of Fig. 8 of Chapter 3.)



**Figure 14.**  $(3, 2)$  Toads-and-Frogs.

(Note the appearance of  $-\frac{1}{4}$  after Right's first move.)



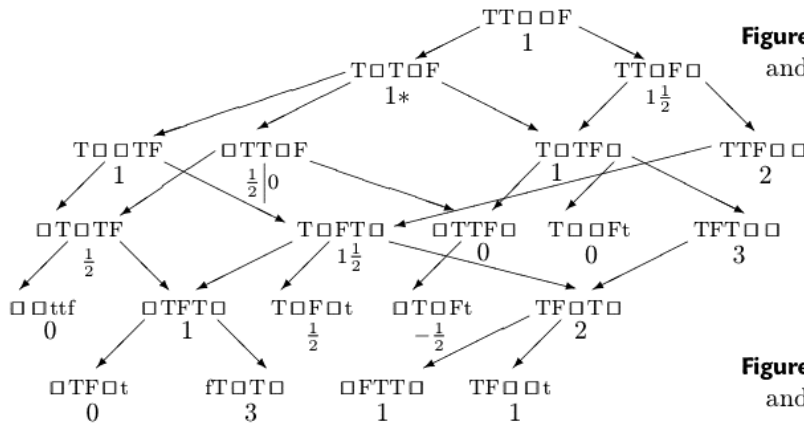
**Figure 15.** (4,2) Toads-and-Frogs  
 (We obtain the figure for the position  $(l, 2)$  with larger  $l$  on replacing the bold figures **2** and **1** by  $l - 2$  and  $l - 3$  respectively.)

**Figure 16.** (3,3) Toads-and-Frogs.  
 (The value  $\uparrow* | 0$  will occur again in Bynum's game of Eatcake in Chapter 8.)

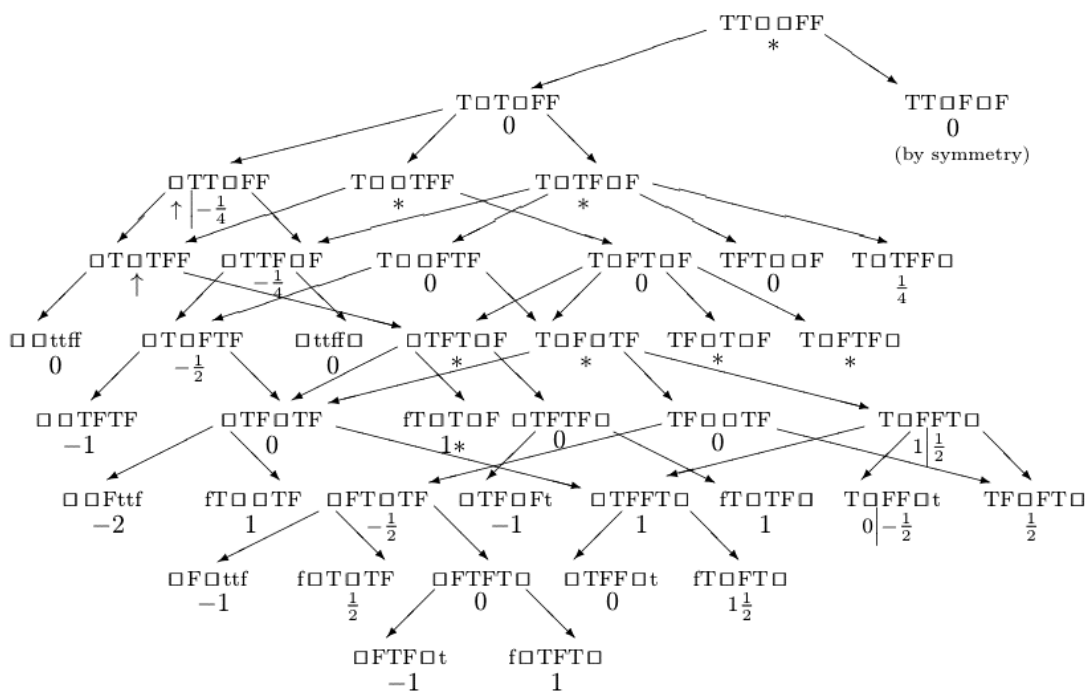


### Toads-and-Frogs with Two Spaces

In general one can play  $(l + c + r)$ -place Toads-and-Frogs from the starting position in which  $l$  toads are separated by  $c$  spaces from  $r$  frogs; we call this the  $(l, r)_c$  game, where we have omitted  $c$  when it is 1. Figures 17, 18 and 19 show the positions arising in one lane of each of

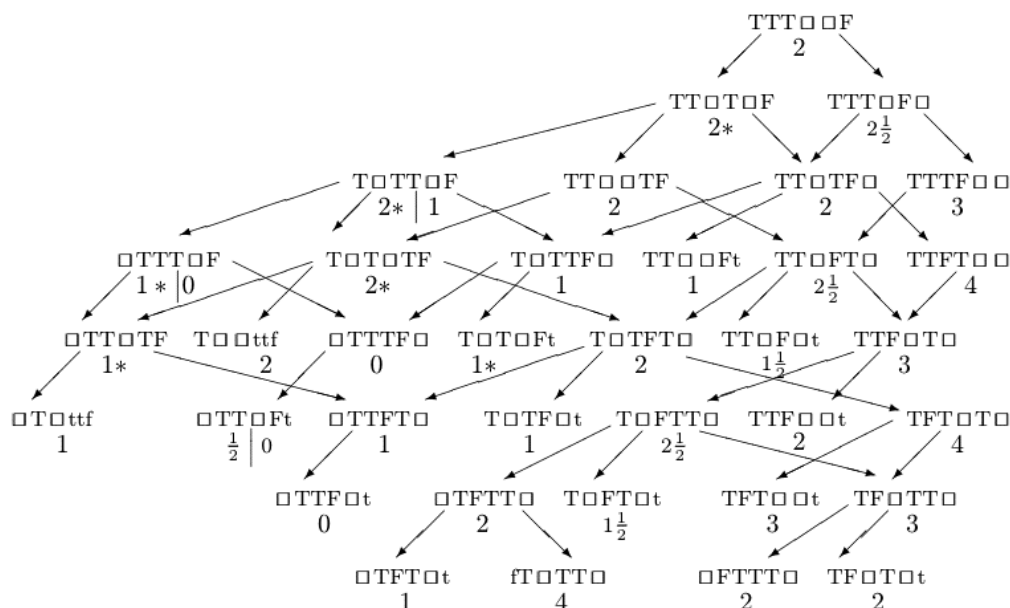


**Figure 17.** The 5-place Toads-and-Frogs Game  $(2, 1)_2$ .



**Figure 18.** The 6-place Toads-and-Frogs Game  $(2, 2)_2$ .





**Figure 19.** The 6-place Toads-and-Frogs Game  $(3,1)_2$ .

the 2-space games  $(2,1)_2$ ,  $(2,2)_2$  and  $(3,1)_2$ . Options are shown except where values, or their negatives, can be quoted from elsewhere, e.g. from Fig. 16 of Chapter 1 (the  $(1,1)_2$  game), Fig. 8 of Chapter 3 (the  $(2,2)$  game), or Figs. 13 to 16 in this chapter.

An incarnation of Omar is Jeff Erickson who has considerably extended the results of Table 3 of values of starting positions for some  $(l,r)_2$  games. Erickson also gives the very complicated values for  $l = r = 4, 5$  and 6 and conjectures that for  $l > r \geq 2$  the value is  $l-3 \parallel l-r \parallel * \parallel 3-r$ .

	$r = 0$	1	2	3	4	5	6
$l = 0$	0	-2	-4	-6	-8	-10	-12
1	2	0	-1	-2	-3	-4	-5
2	4	1	*	$0 \parallel -\frac{1}{2}$	$0 \parallel -\frac{3}{2}$	$0 \parallel -\frac{5}{2}$	$0 \parallel -\frac{7}{2}$
3	6	2	$\frac{1}{2} \parallel 0$	$\pm \frac{1}{8}$	$\uparrow \parallel -1*$	$\uparrow \parallel -2*$	$\uparrow \parallel -3*$
4	8	3	$\frac{3}{2} \parallel 0$	$1* \parallel \downarrow$			
5	10	4	$\frac{5}{2} \parallel 0$	$2* \parallel \downarrow$	$2 \parallel 1 \parallel * \parallel -1$		
6	12	5	$\frac{7}{2} \parallel 0$	$3* \parallel \downarrow$	$3 \parallel 2 \parallel * \parallel -1$	$3 \parallel 1 \parallel * \parallel -2$	
7	14	6	$\frac{9}{2} \parallel 0$	$4* \parallel \downarrow$	$4 \parallel 3 \parallel * \parallel -1$	$4 \parallel 2 \parallel * \parallel -2$	$4 \parallel 1 \parallel * \parallel -3$

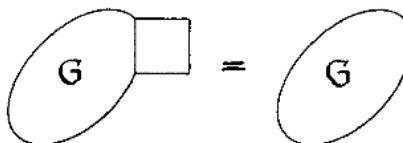
**Table 3.** Values of Starting Positions in  $(l,r)_2$  Toads-and-Frogs.



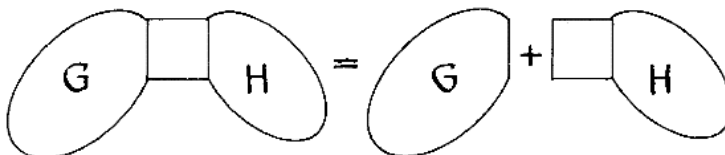
### More Domineering Values



Values for all positions with six and seven squares are shown in Figs. 20 and 21 and values for some larger positions in Fig. 22. These results are partly quoted from ONAG where some of them are explained. The following ideas are useful:

- (i) If from some position, Left has an option of value  $n$  and it is impossible to pack  $n + 1$  vertical dominoes into the region, then  $n$  is Left's best option.
- (ii) The value of a position is unaltered or increased by cutting it along some vertical lines; it is unaltered or decreased by cutting it along horizontal lines.
- (iii) If



then



For example, since  =  , we have

$$\begin{array}{|c|c|c|c|} \hline \square & \square & & \square \\ \hline \square & \square & \square & \square \\ \hline \end{array} = \begin{array}{|c|c|} \hline \square & \square \\ \hline \square & \square \\ \hline \end{array} + \begin{array}{|c|} \hline \square \\ \hline \square \\ \hline \end{array} = \pm 1*$$

Care must be exercised in making *multiple* use of this principle; a square may be added to any *one* of the double edges in each position of Figs. 2 and 20 without affecting the values of the position (there are 3 cases where a square may be added to two double edges *simultaneously*).

Figure 20 gives the values of all the 35 6-square regions; note that if a region is turned through a right angle its value changes sign. There are 108 7-square regions. The values of 30 of these are the same as those of appropriate 6-square regions, the 7-square regions being obtained by adjoining a square to any one of the double edges in Fig. 20. Figure 21 gives the values of 58 other 7-square regions. The remaining 20 are obtained by rotating the sets of squares marked with circles about the axis drawn through one of the circles.

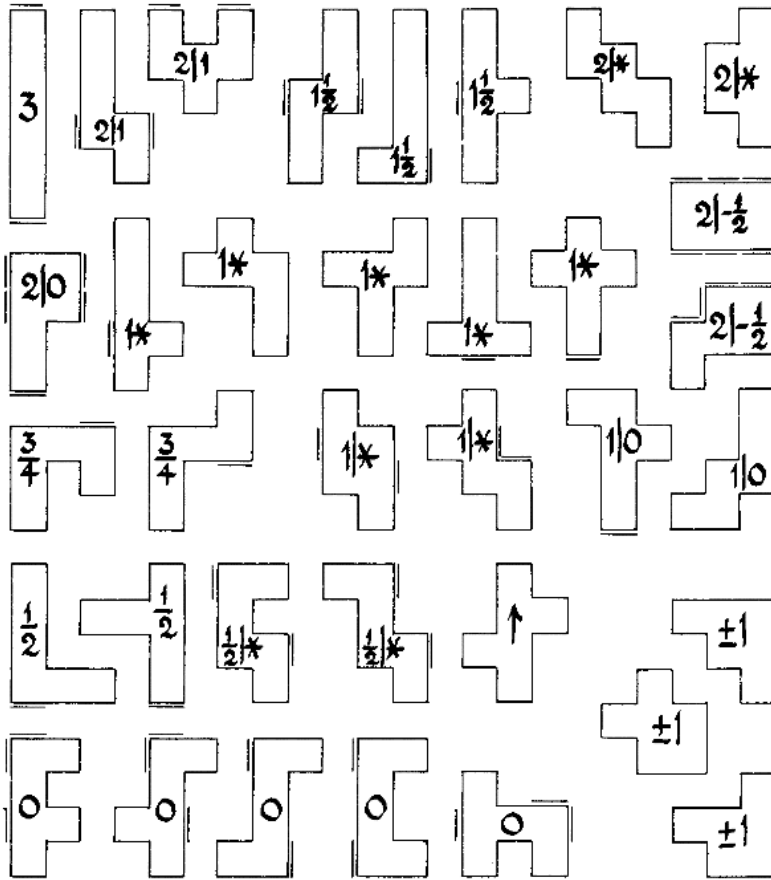
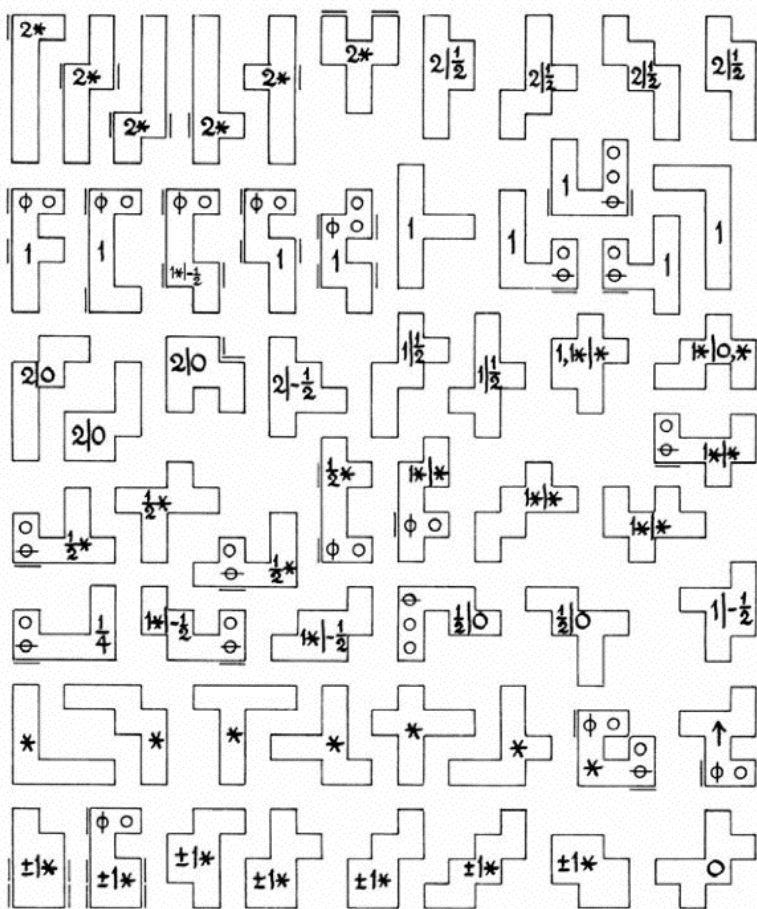


Figure 20. Domineering Values for All 6-square Regions.



**Figure 21.** Domineering Values for 7-square Regions.

Table 4 gives the values of  $m \times n$  rectangles in Domineering. This has been much amplified by David Wolfe, using his Gamesman's Toolkit; he has also corrected errors in Figs. 21 and 22.

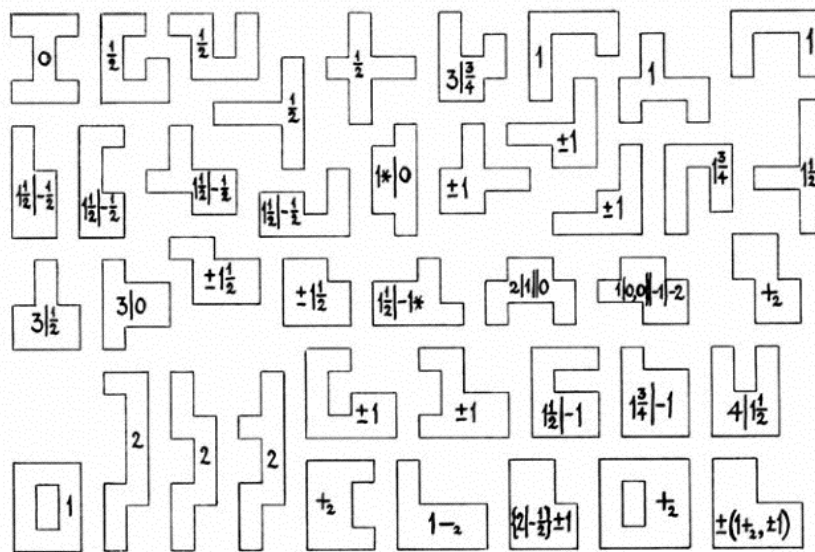
$n =$	1	2	3	4	5	6	7	8
$m = 1$	0	-1	-1	-2	-2	-3	-3	-4
2	1	$\pm 1$	$2 \mid -\frac{1}{2}$	-2	$\frac{1}{2}$	$1-2 \mid -1$	$1\frac{1}{2} \mid -\frac{1}{2}$	$2-2 \mid 0 \parallel -\frac{1}{2} \mid -2$
3	1	$\frac{1}{2} \mid -2$	$\pm 1$	$-1\frac{1}{2}$	-1	$-1 \mid -3\frac{1}{2}$	$-\frac{3}{4} \mid -3$	$-\frac{1}{2} \mid -3 \parallel -3\frac{1}{4} \mid -5\frac{1}{2}$
4	2	$+2$	$1\frac{1}{2}$	$a$	1	$b$	1	$\{1\frac{1}{2} \mid 0 \parallel -\frac{1}{2} \mid -2\} + c$
5	2	$-\frac{1}{2}$	1	-1	0	$-1\frac{1}{2}$		
6	3	$1 \mid -1+2$	$3\frac{1}{2} \mid 1$	$-b$	$1\frac{1}{2}$	$\pm 1 + d$		
7	3	$\frac{1}{2} \mid -1\frac{1}{2}$	$3 \mid \frac{3}{4}$	1				

where  $-2t < a < 2t$ ,  $-4t < b < 3t$ ,  $-2t < c < 4t$ ,  $-6t < d < 6t$  with  $t = +2$ .

**Table 4.** Values of Rectangular Regions in Domineering.

Figure 22 gives values for some miscellaneous regions with eight or more squares, while Fig. 23 shows some interesting sequences.

The impartial version of Domineering, in which either player may place his domino in either orientation, is discussed in Chapter 15 under the name of Cram.



**Figure 22.** Domineering Positions with 8 or more Squares.

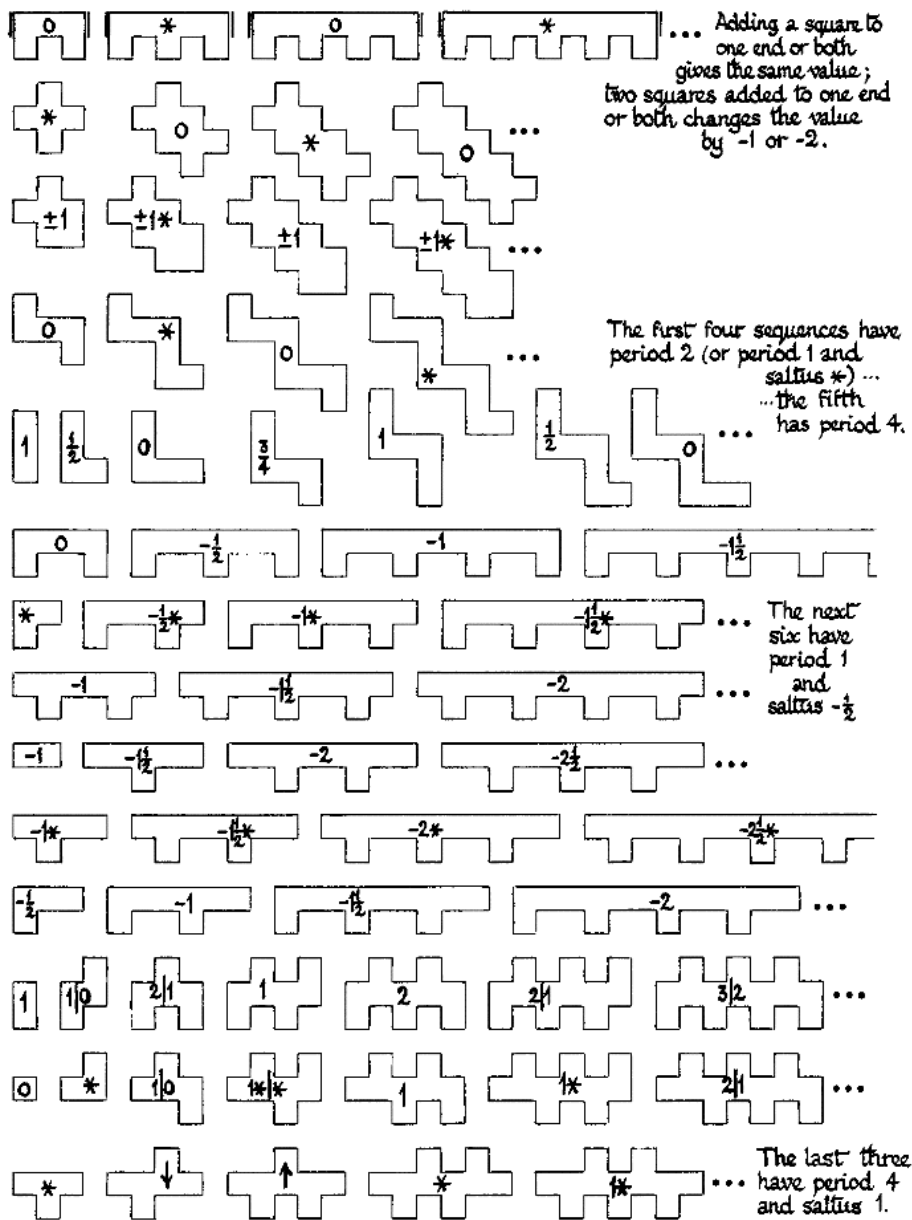


Figure 23. Some Sequences of Domineering Positions.

## References

E. R. Berlekamp, Blockbusting and Domineering. *J. Combin. Theory Ser. A*, **49** 67-116; see also R. K. Guy & R. E. Woodrow (eds.) *The Lighter Side of Mathematics, Proc. E. Strens Mem. Conf. Recr. Math.*, Calgary, 1986, Spectrum Series, Math. Assoc. Amer., 1994, 137-148.

D. M. Breuker, J. W. H. M. Uiterwijk & H. J. van den Herik, Solving  $8 \times 8$  Domineering, *Theoret. Comput. Sci.*, **230**(2000), 195-206.

J. H. Conway, *On Numbers and Games*, Second Edition, A K Peters, Ltd., 2001, pp. 74-77, 114-121.

Jeff Erickson, New Toads-and-Frogs results, in *Games of No Chance*, Proc. MSRI Workshop on Combinatorial Games, July 1994, Berkeley CA (Richard Nowakowski, ed.), MSRI Publ. **29**, Cambridge University Press, 1996, pp. 287-297.

Martin Gardner, Mathematical Games: Cram, crosscram and quadruphage: new games having elusive winning strategies, *Sci. Amer.*, **230**#2(Feb. 1974) 106-108.

Yonghoan Kim, New values in Domineering, *Theoret. Comput. Sci.*, **156** 263-280.

Julian West, Championship-level play of Domineering, in *Games of No Chance*, Proc. MSRI Workshop on Combinatorial Games, July 1994, Berkeley CA (Richard Nowakowski, ed.), MSRI Publ. **29**, Cambridge University Press, pp. 85-91.

David Wolfe, Snakes in Domineering games, *Theoret. Comput. Sci.*, **119**(1993) 323-329.

David Wolfe, The Gamesman's Toolkit, in *Games of No Chance*, Proc. MSRI Workshop on Combinatorial Games, July 1994, Berkeley CA (Richard Nowakowski, ed.), MSRI Publ. **29**, Cambridge University Press, 1996, pp. 93-98.





# -6-

## The Heat of Battle

When the hurly-burly's done  
When the battle's lost and won.  
William Shakespeare, *Macbeth*, Li 1.

. . . not without dust and heat.  
John Milton, *Areopagitica*.

When you're playing a sum of cold games there's not much of a problem. Their values will be numbers, every move gives something away and you just have to tot up the numbers to find the least disadvantageous move. When the hot games are switches with only cold options, as in Cashing Cheques, you just move in the hottest game. But if you're in a really complicated battle, and things are likely to stay hot for quite some time, then you'll have a hard job deciding what to do. This chapter will give you some help in coping with the heat.

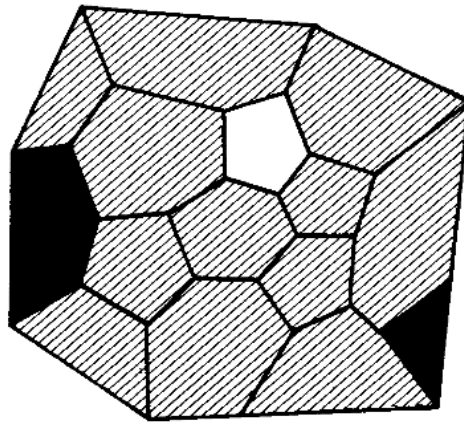
### Snort

This is a game introduced by S. Norton in which there are many hot and complicated positions. On alternate weeks Farmer Black is in the bull market buying black bulls, and in the intervening weeks Farmer White will be found buying white cows. They jointly rent a certain farm and intend to put each herd in a separate field. Of course they mustn't put bulls and cows in adjoining fields. That farmer loses who is first unable to find a suitable open field for his latest purchase.

You can play this game like the map-coloring game of Col, introduced in Chapter 2. The difference is that in Snort adjacent fields may not be used by *opposing* players, whereas adjacent regions of the maps in Col were not available to the *same* player.

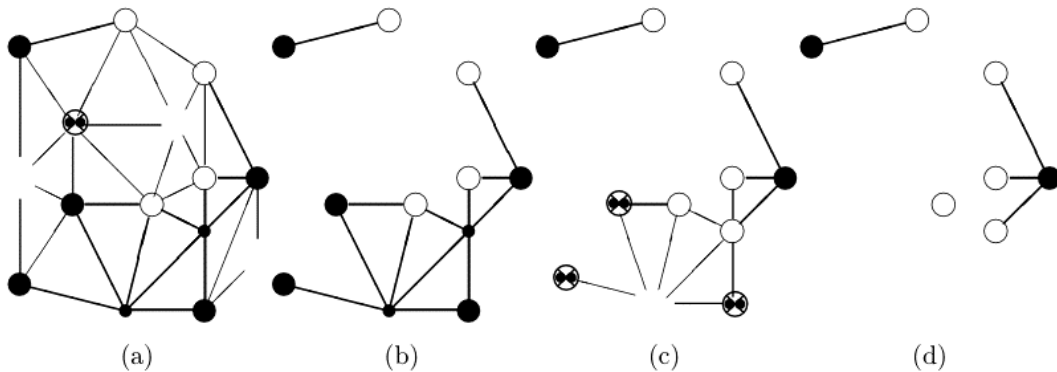
### A Graphic Picture of Farm Life

Figure 1 shows a farm as it might look after Farmer Black's second purchase. The two black fields hold bulls, the white ones hold cows and the shaded ones are still empty. to get a clear idea of what is going on let's put a dot (●) in each field that is still available to both players, a black spot (●) in one usable only for bulls, and a white spot (○) in one open to cows only. There's one field that's not available to either player since it's adjacent to both bulls and



**Figure 1.** Snort Farm After Farmer Black's Second Purchase of Bulls.

cows, and we've indicated this in Fig. 2(a) by the piebald spot ( $\otimes$ ). These dots and spots are now joined by lines indicating adjacency of fields.



**Figure 2.** Reducing the Problems of Farm Management.

So Fig. 2(a) contains all the information of Fig. 1 in a more perspicuous form. We can further simplify such figures by

- omitting any piebald spot,
- omitting any (thin) line joining similarly colored spots,

as in Fig. 2(b), since the omitted things have no further effect on the game.

To play Snort directly on these simplified graphs, Black, when he takes a node, should add a black coloration to all neighboring ones. This is in addition to any coloration already present, so that a white node will become piebald and can therefore be omitted. Of course,

similar remarks can be made for the other player; for instance if Farmer White now puts cows in the lowest field available to him we get Fig. 2(c), simplifying to Fig. 2(d).

Figure 3 contains the values of a number of Snort positions that can be found this way:

$$\bullet\text{---}\bullet\text{---}\bullet = \left\{ \begin{array}{c|c} \begin{array}{c} \bullet\text{---}\bullet\text{---}\bullet \\ \bullet\text{---}\bullet \\ \bullet\text{---}\bullet\text{---}\bullet \end{array} & \begin{array}{c} \otimes\text{---}\bullet\text{---}\bullet \\ \bullet\text{---}\otimes \\ \bullet\text{---}\bullet\text{---}\circ \end{array} \end{array} \right\} = \left\{ \begin{array}{c|c} \{2|-1\} & \pm 1 \\ 1+\{1|0\} & \\ \{1|0\}+1 & *-1 \\ \{1|0\}+1 & \pm 1 \end{array} \right\} = 2|1||-1*$$

In the Extras you'll find a more extensive Snort dictionary from which many of the examples for this chapter have been taken.

•	*	•---•---•	±2	•---•---•	±(2   1)	•---○---•---•	2   -1*
●	1	●---•---•	2 -1	●---•---•	3   -1*	●---•---○---•	±1*
○	-1	○---●---•	2   *	○---●---•	2 1    -1*	○---•---•---○	±2
•---•	±1	•---•---●	2   0	•---•---●	3   *	•---●---○---•	±1*
●---•	1   0	●---○---•	±1	●---•---•	3   *	●---○---●---•	2   *
○---•	0 -1	○---•---○	±1	○---○---•		○---○---•---●	2   *
●---○	*	●---○---●	1   0	●---○---○	±1	●---•---●---○	2   -1

**Figure 3.** A Short Snort Dictionary.

## Don't Move In A Number Unless There's Nothing Else To Do!

When you're playing in a sum of games with values of different types, it can be quite hard to decide where your best move lies. But since if  $x$  is a number in simplest form, we have

$$x^L < x < x^R,$$

each player makes himself worse off by moving in  $x$ . So when considering which component to move in, you should always prefer the non-numbers:

DON'T MOVE IN A NUMBER  
UNLESS THERE'S  
NOTHING ELSE TO DO!

### THE NUMBER AVOIDANCE THEOREM

You'll find a more formal proof in the Extras. More generally the obvious question to ask when comparing moves in different components is



## What's in it for Me?

For example, if Left makes the move from  $G$  to  $G^L$  then what's in it for him is the amount

$$G^L - G$$

by which the value is increased. On the other hand, Right, who's trying to keep things down, gains

$$G - G^R$$

by moving from  $G$  to  $G^R$ , since this is how much the value is *reduced*. So we'll call the various differences

$$G^L - G \quad \text{and} \quad G - G^R$$

the (Left and Right) **incentives** of  $G$ .

Looking at various numbers in simplest form, for example

$$1 = \{0|\}, \quad 2\frac{1}{2} = \{2|3\}, \quad \frac{3}{4} = \{\frac{1}{2}|1\},$$

you can see that the incentives

$$x^L - x \quad \text{and} \quad x - x^R$$

are found among the negative numbers

$$-1, -\frac{1}{2}, -\frac{1}{4}, -\frac{1}{8}, \dots$$

explaining why each player feels a *disincentive* to move from  $x$ . But we'll see that from any *non*-number, each player has an incentive which is *almost* positive, being strictly greater than all these negative numbers.

For example,  $2|-1$  *isn't* a number, but  $1\frac{1}{4} = 1|1\frac{1}{2}$  *is*. and so we have

$$\{2|-1\} + 1\frac{1}{4} = 3\frac{1}{4}|\frac{1}{4},$$

since the players won't consider the moves to

$$\{2|-1\} + 1 \quad \text{and} \quad \{2|-1\} + 1\frac{1}{2}$$

because they know the number avoidance theorem.

More generally we have

### THE TRANSLATION PRINCIPLE

<p>If <math>G = \{G^L G^R\}</math> <i>isn't</i> a number and <math>x</math> <i>is</i>, then</p> $\{G^L G^R\} + x = \{G^L + x G^R + x\}$
---

because

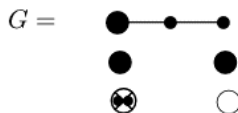
$$G + x = \{G^L + x, G + x^L \mid G^R + x, G + x^R\}$$

and, by the Number Avoidance Theorem, the options

$$G + x^L \quad \text{and} \quad G + x^R$$

are dominated.

The Snort position  
is *hot* because Left will move to  
with value 2, and Right to



with value  $-1$ , but whichever of these two positions is reached, neither player would like to move in what remains because their values are numbers. We call 2 the Left stop of  $G$ , and  $-1$  the Right stop. And because  $G$  satisfies the equation

$$G + G = 1,$$

we might say that it has a **mean value** of  $\frac{1}{2}$ .

Similarly the game

$$H = \bullet \text{---} \bullet \text{---} \bullet \text{---} \bullet = 2 \parallel -1^*$$

has a left stop of 1, a Right stop of  $-1$ , and has a mean value  $\frac{1}{4}$  because it satisfies

$$4 \cdot H = 1.$$

In this case the mean value is *not* the average of the Left and Right stops. How do we compute the stopping values and the mean value for an arbitrary game which doesn't seem to satisfy any convenient little equation?

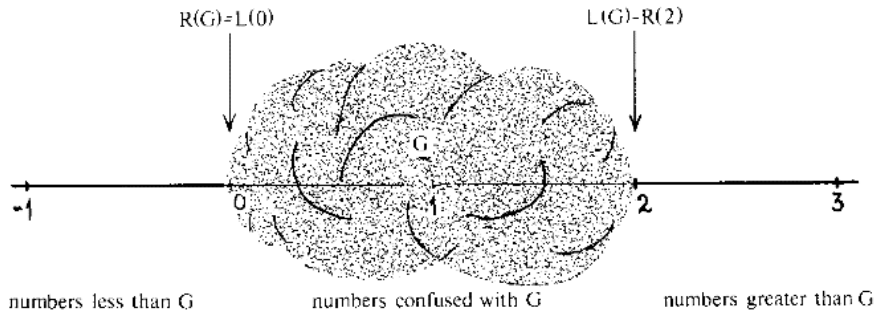
## The Left and Right Stops

The Left and Right stops are easily found. Let us agree to stop the play of any game when its value becomes a number. Because moving in numbers is bad for you this doesn't have any effect on intelligent play. When all the components have become numbers sensible players will stop playing altogether and just tot up the score! So the positions of a game whose values are numbers become stopping positions with this rule. The ones whose values *aren't* numbers may be called *active* positions since the players will still want to move in them.

When an active game such as

$$G = \bullet \text{---} \bullet \text{---} \bullet \text{---} \bullet = 3 \parallel 2 \parallel 0, \pm 1$$

is played together with some other games that have already stopped at numerical values the play will concentrate in  $G$  until it also reaches a stopping position,  $x$ , say. Left should try to make  $x$  as large as possible, and Right to make it as small as possible. In this case, if Left



**Figure 4.** The Left and Right Stops and Confusion Interval of  $3|2 \parallel 0, \pm 1$ .

starts,  $G$  will stop at value 2 with Left to move, while if Right starts,  $G$  will stop at 0, again with Left to move. We indicate this situation by writing

$$L(G) = L(2), \quad R(G) = L(0)$$

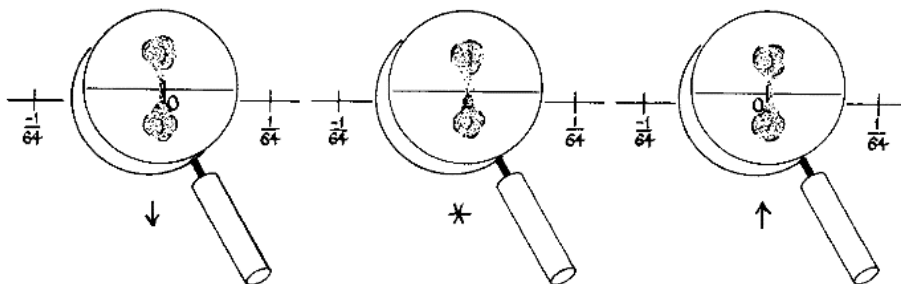
By playing a general game  $G$  in this way we define the two numbers which we call the **Left stop** and **Right stop** of  $G$ , and also find who is to move when these stops are reached. We then know how  $G$  compares with all numbers, because the cloud for  $G$  in Fig. 4 crosses the axis at the Left and Right stops on the sides determined by whose turn it is to play. In our example the cloud passes to the *left* of 0 and to the *left* of 2. The region between the Left and Right stops (covered by the cloud in our figures) is called the **confusion interval**.

Figure 5 shows the confusion intervals of

$$\downarrow = 0 | 0 \parallel 0, \quad * = 0 | 0, \quad \uparrow = 0 \parallel 0 | 0$$

for which we have

$$L(\downarrow) = R(\downarrow) = L(0); \quad L(*) = R(0), \quad R(*) = L(0); \quad L(\uparrow) = R(\uparrow) = R(0).$$



**Figure 5.** The Confusion Intervals of Down, Star and Up.

You can see that a confusion interval may contain just one point, or be empty, in several different ways. In each of these cases, the game is *infinitesimally close* to a number.

## Cooling—and the Thermograph

A game which is confused with a *large* interval of numbers is *hot* and both players will be eager to move in it. To find its mean value we should try to decrease the confusion by cooling it. To cool a game by  $t$  degrees we impose a tax of size  $t$  payable at each move. However we must take care to provide appropriate exemptions for moves to stopping positions so that our tax rule won't distort the underlying economy. Numbers are already inactive and must not be changed by additional cooling.

The game  $G_t$  ( $G$  cooled by  $t$ ) is defined for increasing values of  $t$  as follows:

$$G_t = \{G_t^L - t \mid G_t^R + t\} \text{ unless there is a smaller temperature } t' \text{ for which } G_{t'} \text{ is infinitesimally close to a number } x, \text{ in which case } G_t = x \text{ for all } t > t'.$$

### THE COOLING FORMULA

Let's look at our Snort position  $G = \bullet \bullet \bullet = 2 \mid -1$  as  $t$  increases. We find

$$\begin{aligned} G = G_0 &= 2 \mid -1 \\ G_{\frac{1}{2}} &= 1\frac{1}{2} \mid -\frac{1}{2} \quad (= 2 - \frac{1}{2} \mid -1 + \frac{1}{2}) \\ G_1 &= 1 \mid 0 \\ G_{1\frac{1}{2}} &= \frac{1}{2} \mid \frac{1}{2} = \frac{1}{2} + * \end{aligned}$$

which is infinitesimally close to  $\frac{1}{2}$  and so  $G_t = \frac{1}{2}$  for all  $t > 1\frac{1}{2}$ .

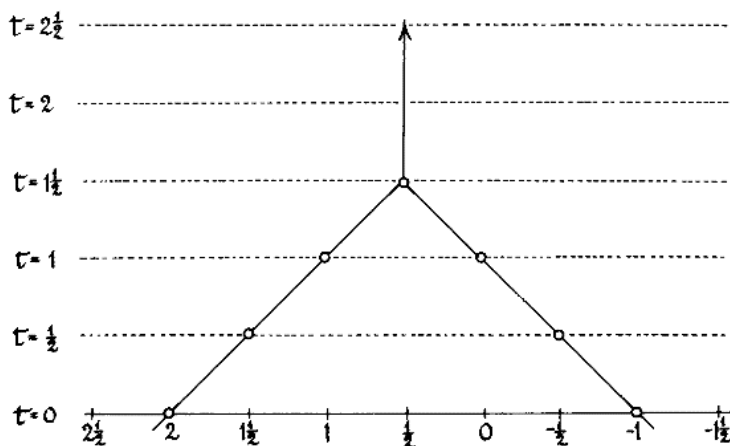


Figure 6. The Thermograph of  $2 \mid -1$ .

## Cooling—and the Thermograph

A game which is confused with a *large* interval of numbers is *hot* and both players will be eager to move in it. To find its mean value we should try to decrease the confusion by cooling it. To cool a game by  $t$  degrees we impose a tax of size  $t$  payable at each move. However we must take care to provide appropriate exemptions for moves to stopping positions so that our tax rule won't distort the underlying economy. Numbers are already inactive and must not be changed by additional cooling.

The game  $G_t$  ( $G$  cooled by  $t$ ) is defined for increasing values of  $t$  as follows:

$$G_t = \{G_t^L - t \mid G_t^R + t\} \text{ unless there is a smaller temperature } t' \text{ for which } G_{t'} \text{ is infinitesimally close to a number } x, \text{ in which case } G_t = x \text{ for all } t > t'.$$

### THE COOLING FORMULA

Let's look at our Snort position  $G = \bullet \bullet \bullet = 2 \mid -1$  as  $t$  increases. We find

$$\begin{aligned} G = G_0 &= 2 \mid -1 \\ G_{\frac{1}{2}} &= 1\frac{1}{2} \mid -\frac{1}{2} \quad (= 2 - \frac{1}{2} \mid -1 + \frac{1}{2}) \\ G_1 &= 1 \mid 0 \\ G_{1\frac{1}{2}} &= \frac{1}{2} \mid \frac{1}{2} = \frac{1}{2} + * \end{aligned}$$

which is infinitesimally close to  $\frac{1}{2}$  and so  $G_t = \frac{1}{2}$  for all  $t > 1\frac{1}{2}$ .

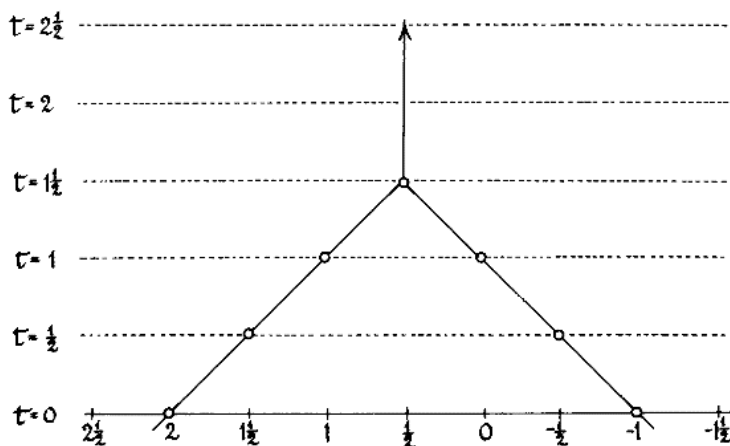


Figure 6. The Thermograph of  $2 \mid -1$ .





So this game reduces to its mean value,  $\frac{1}{2}$ , when it is cooled through any temperature exceeding  $1\frac{1}{2}$ .

We represent this by drawing the **thermograph** of  $G$  (Fig. 6) in which, at height  $t$  above the ground, we plot the Left and Right stops of  $G_t$ . It's handy to have the numbers along the axis in *descending* order to keep Left's moves to the left and Right's moves to the right.

## Cooling Settles the Mean Value

It will be clear that cooling by a sufficiently large amount must necessarily lead to a number,  $m$ , say, so that we have

$$G_t = m \quad \text{for } t > t_0$$

This means that every thermograph is surmounted by an infinite vertical **mast**. The smallest value of  $t_0$  for which this holds is called the **temperature**,  $t(G)$ , of  $G$ , and we have

$$m = t < G < m + t$$

for all  $t > t(G)$ . Why is  $m$  the mean value of  $G$ ? The answer is that we can prove

$$(A + B + C + \cdots)_t = A_t + B_t + C_t + \cdots$$

and in particular

$$(G + G + G + \cdots)_t = G_t + G_t + G_t + \cdots$$

so that for all  $t > t(G)$  we have

$$(G + G + G + \cdots)_t = m + m + m + \cdots$$

and

$$m + m + m + \cdots - t < G + G + G + \cdots < m + m + m + \cdots + t.$$

To within a bounded error,  
a lot of copies of  $G$  may be  
replaced by the same number  
of copies of its mean value.

If it were not for the tax exemptions for stopping positions, the equation

$$(A + B + C + \cdots)_t = A_t + B_t + C_t + \cdots$$

would be obvious, because the typical Left option is

$$(A + B^L + C + \cdots)_t - t = A_t + (B_t^L - t) + C_t + \cdots,$$

so that the tax on the whole move from

$$A + B + C + \cdots \quad \text{to} \quad A + B^L + C + \cdots$$

can be regarded as charged to the component move from

$$B \quad \text{to} \quad B^L.$$

Fortunately the tax exemptions on stopping positions don't affect this because if  $x$  is a number, the Translation Principle ensures that

$$(x + G)_t = x + G_t \quad (x - G)_t = x - G_t \quad x_t = x$$

so that the equation

$$(A + B)_t = A_t + B_t$$

holds true if any one of  $A$ ,  $B$  or  $A + B$  is made equal to a number  $x$ .

### How to Draw Thermographs

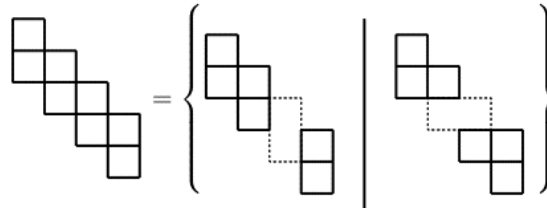
The Snort position



has the same value

$$G = 2 | 1 || 0$$

as the Domineering position



Let's draw its thermograph and find its mean value.

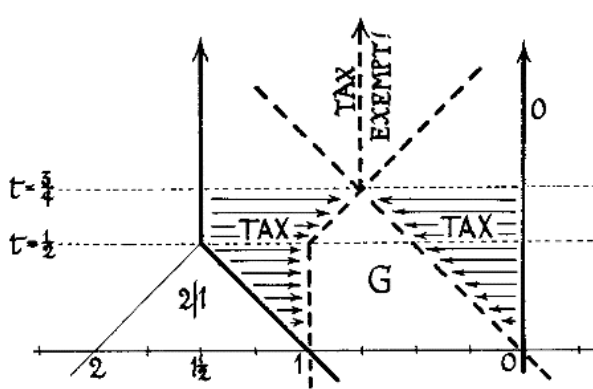


Figure 7. Drawing the Thermograph of  $G$ .

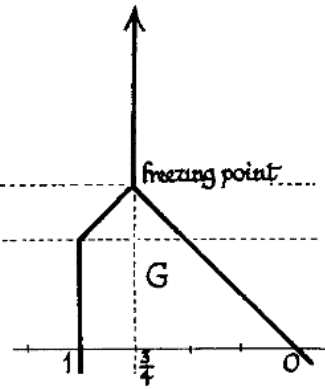


Figure 8. The Final Form.

The thermograph of  $2|1$  is like the one we already found for  $2|-1$ ; its Left and Right boundaries are slanting lines which start at 2 and 1 and then meet and become vertical at height  $t = \frac{1}{2}$  showing that  $2|1$  has temperature  $\frac{1}{2}$  and mean value  $1\frac{1}{2}$ . Because 0 is already a number, its thermograph is just a vertical line.



After Left has moved from  $G$  to  $2|1$  it will be *Right's* turn and so the *Right* boundary of  $2|1$  is important and has been boldly drawn. We've also emphasized the *Left* boundary of  $0$  (which happens to coincide with its *Right* boundary).

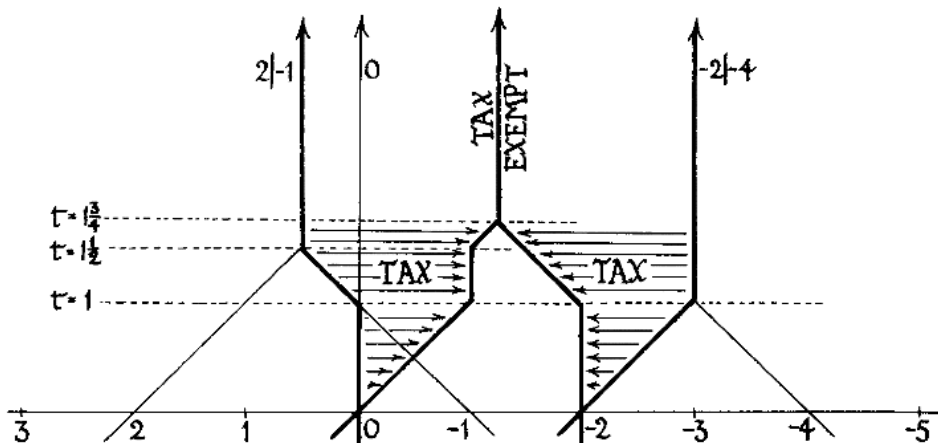
Now to impose the tax! We tax Left by moving *rightwards* since this corresponds to *subtraction* of  $t$  on our reversed scale. When we move the *Right* boundary through a distance  $t$  at height  $t$  it yields the thick broken line which starts vertically at  $1$  before turning to slant to the right at height  $\frac{1}{2}$ . Because *Right* is taxed by *addition* of  $t$  we move the *Left* boundary of  $0$  to the *left* yielding the thick broken line through  $0$ .

These two thick broken lines define the *Left* and *Right* stops for  $G_t$  until they meet at a place called the **freezing point** (in this case at height  $\frac{3}{4}$  above the point  $\frac{3}{4}$ ), showing that  $G$  cooled by  $\frac{3}{4}$  is infinitesimally close to  $\frac{3}{4}$  and so  $G_t = \frac{3}{4}$  for all  $t > \frac{3}{4}$ . The thermograph of  $G$  is therefore as in Fig. 8, both boundaries coinciding with the vertical mast above this point.

### When A Player Has Several Options

When a player has several options the best one to choose may depend on the cooling temperature. Figure 9 shows how to draw the thermograph in such a case, namely for the Snort position

$$G = \bullet \bullet \bullet \circ \bullet \circ = \{ \{2|-1\}, 0 \parallel \{-2|-4\} \}.$$



**Figure 9.** Drawing a Thermograph when Left has Two Options.

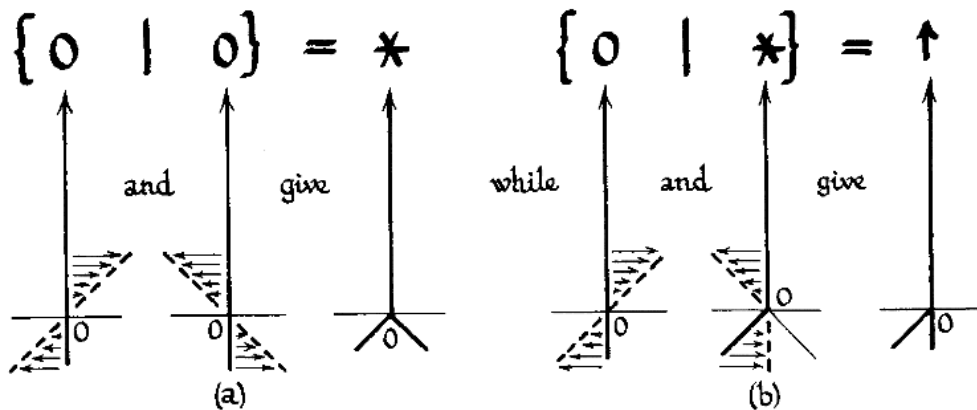
Which of his options  $2|-1$  and  $0$  does Left choose? Since it will be *Right's* turn to move it is the option's *Right* boundary which is important and so

For each temperature  $t$ ,  
*Left* chooses whichever of  
 his options has *leftmost*  
*Right* boundary at  $t$ .

In the example this is 0 for  $t \leq 1$ , and  $2|-1$  for  $t > 1$ , and so we've emphasized the Right boundary of 0 below the dotted line at  $t = 1$  and the Right boundary of  $2|-1$  above it. We have also emphasized the Left boundary of Right's only option,  $-2|-4$ . The thermograph boundaries for  $G$  are therefore given by the thick lines obtained by taxing these by an amount  $t$  at each height  $t$  until they meet.

## Foundations for Thermographs

You'll see that the bottoms of our thermographs are always a bit ragged because we continue their boundaries a little bit below the ground. To see why, let's look at the thermographs of  $*$  and  $\uparrow$ . For  $* = 0|0$  the relevant option boundaries are both the vertical line through 0 which are taxed in two oppositely slanting lines through 0. Since these meet at 0, the thermograph of  $*$  is vertical above 0, but has two slanting lines just below 0, as in Fig. 10(a) (or Fig. 11(a) with  $a = b = 0$ ).

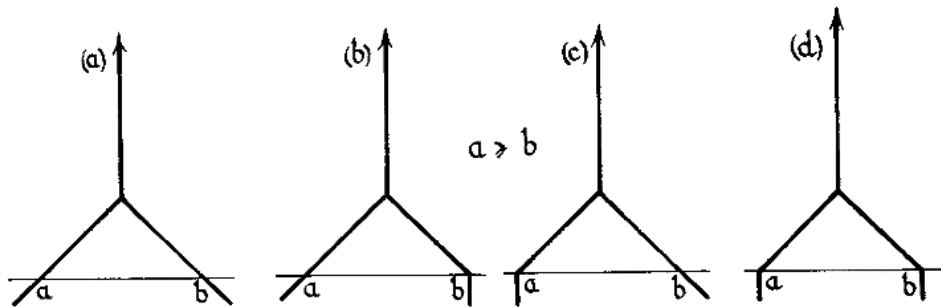


**Figure 10.** The Thermographs of Star and Up.

The same Left boundary serves for  $\uparrow$ . To find its *Right* boundary we tax the Left boundary of  $*$  to obtain the broken line which is slanting above the ground, but vertical just below it, as shown in Fig. 10(b) (or Fig. 11(b) with  $a = b = 0$ ). Once again, these meet at ground level, but diverge just below it, although this time the *Right* boundary remains vertical.

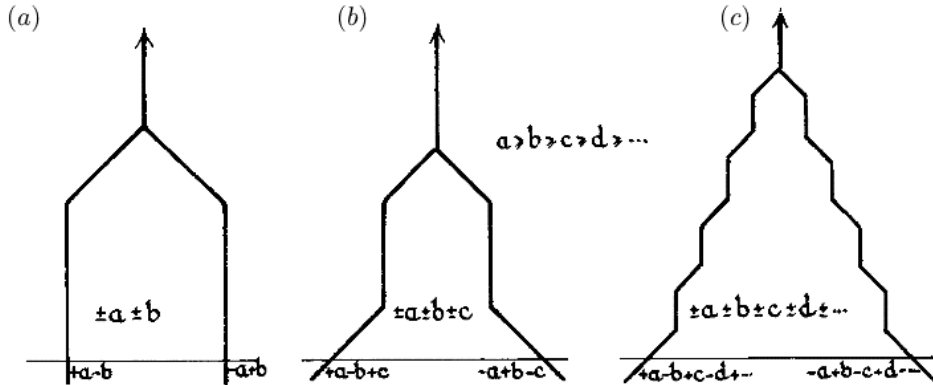


Examples of Thermographs



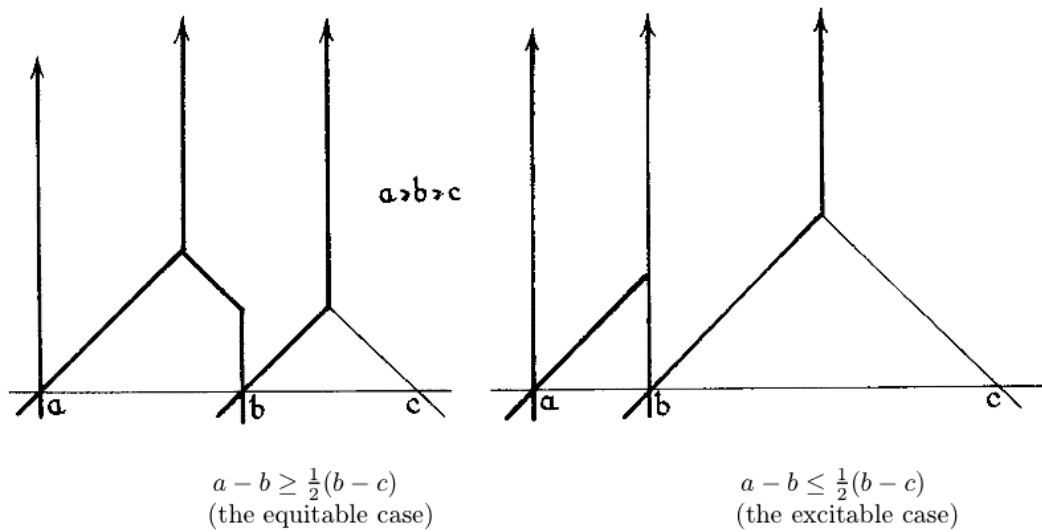
Examples: (a) ●—● = ●—○—● = 1|0    ●—●—●—○ = 2|-1  
 (b) ●—●—● = 2|\*    ●—●—●—● = 3|-1\*  
 (c) ○—●—●—○ = \*|-3    ○—●—●—● = 1\*|-2  
 (d) ●—●—○—● = ±1\*    ○—●—●—●—● = 2\*|-1\*

Figure 11. Thermographs of Games with Two Stops,  $x$  or  $x^*$ .



Examples:  
 (a) ●—●—●—● = ±1½ ± ½ = ±(2|1)    ●—●—●—●—○ = ±2 ± 1 = ±(3|1)  
 (b) ●—●—●—○—● = ±1½ ± ½ ± 0 = ±(2\*|1\*)  
 (c) The Childish Hackenbush positions with several loops of  $l_i$  blue and  $r_i$  red edges,  $i = 1, 2, 3, \dots$

Figure 12. Saskatchewan Landscape. Thermographs of Games with Two, Three or More Switches.



**Figure 13.** Thermographs of Games  $a \parallel b \mid c$ .

### Who Is To Move From The Final Stop?

This is easy to see from the thermograph, since a *vertical* line represents a stopping point reached after *equal* numbers of moves by each player, while a *slanting* line is one reached after the starting player has *also* made the last move. This means that the confusion interval of  $G_t$  includes endpoints on slanting lines but *excludes* ones on vertical lines. It is important to notice that where a thermograph boundary changes slope the confusion interval is determined from the *downward* slope. Thus in Fig. 11(a) *both* endpoints are in the confusion interval, and in Fig. 11(d) *neither*. For Fig. 11(b),  $a$  is in and  $b$  is not, and conversely for Fig. 11(c).

If  $x$  is a number you can tell whether  $G \geq x$  or  $G \leq x$  by seeing whether the thermograph of  $G$  is entirely to the left or right of the vertical line through  $x$ . Thus the thermograph shown in Fig. 14 for the game

$$G = \bullet \text{---} \bullet \text{---} \bullet \text{---} \bullet \text{---} \bullet \text{---} \bullet = 4|3||1 * |-1*$$

shows that  $G \leq 3$ , but  $G \not\geq 1$  because the thermograph has a “toenail” protruding to the right of 1. On the other hand, if  $x$  is any number less than 1, we have  $G > x$  (the toenail is infinitesimally small).

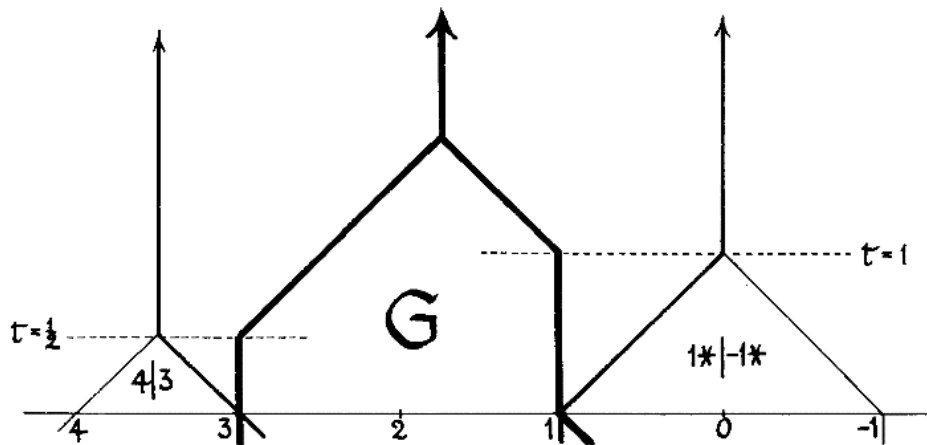


Figure 14. A Thermograph with a Toenail.

### A Four-Stop Example

If you're to play well in complicated situations you'll need to be familiar with thermographs and to understand the Thermostatic Strategy given later in the chapter. In the next few sections we'll discuss play in sums of 4-stop games of the form

$$H = a | b || c | d \quad (a \geq b > c \geq d)$$

to show you the kinds of considerations that arise. By the Translation Principle this can be converted into the form

$$H = \frac{1}{4}s + \{x \pm y | -x \pm z\} = \frac{1}{4}s + G, \text{ say,}$$

where

$$\begin{aligned} s &= a + b + c + d \\ x &= \frac{1}{4}(a + b - c - d) \\ y &= \frac{1}{2}(a - b) \\ z &= \frac{1}{2}(c - d) \end{aligned}$$

The thermograph of this game has three possible forms (Fig. 15) according to the sizes of the numbers involved. The informal terms *equitable* and *excitable* refer to certain aspects of your strategy when playing sums of these games. We won't give exact definitions but the next few sections contain a heuristic discussion of these ideas.

### The Cheque-Market Exchange

In Chapter 5 we played the game of Cashing Cheques. Each cheque had a specified value in terms of some number of moves, but a blank payee. Either player may acquire any single cheque at his turn. An unclaimed cheque of amount  $x$  is the game  $\pm x = \{x|-x\}$ .

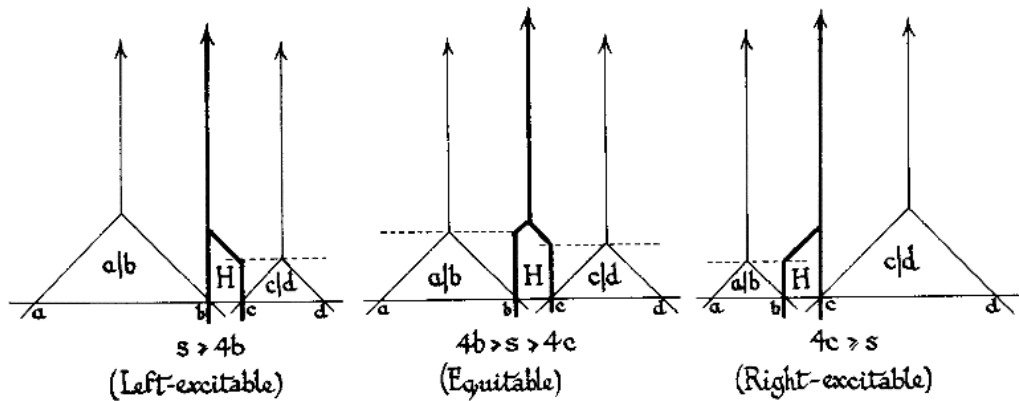


Figure 15. Various Thermographs for  $a \mid b \parallel c \mid d$ , ( $a \geq b > c \geq d$ ).

Let us now imagine a market-place for cheques in which Honest Joe offers either player an unclaimed cheque of value  $x$  in return for another unclaimed cheque of value  $y$ . If  $x$  exceeds  $y$ , then we have only a disguised form of the two-unclaimed-cheques game,

$$\{x \pm y \mid -x \pm y\} = \pm x + \pm y.$$

However if  $y \geq x$ , then neither player will ever accept Honest Joe's offer, which evidently has value 0.

More interesting variations arise when the *same* unclaimed cheque of size  $x$  is offered for sale to Left and Right at *different* prices! Suppose that  $x$  moves are offered to Left in exchange for an unclaimed cheque of value  $y$ , but the same  $x$  moves are offered to Right in exchange for an unclaimed cheque of value  $z$ . The game represented by this pair of offers is

$$G = \{x \pm y \mid -x \pm z\}$$

If  $x$  is quite large compared with  $y$  and  $z$ , then it's quite obvious how to play  $G$ , even when it's added to other games of similar type.

## Equitable Games

Indeed, play in the sum of  $n$  copies of it,

$$n \cdot G = n \cdot \{x \pm y \mid -x \pm z\}$$

proceeds in a very equable and equitable manner whenever  $x$  is large enough compared with  $y$  and  $z$ . In this case the players each view  $G$  as a bargain of largish size  $x$  and they take turns in acquiring these desirable bargains. They won't bother about the comparatively small prices  $\pm y$  and  $\pm z$  while there are still big bargains to be had. This short-sighted view is optimal because the unclaimed cheques of values  $\pm y$  and  $\pm z$  will themselves be equitably divided later





on in the game. If  $x > y \geq z \geq 0$  and both  $x - y$  and  $x - z$  are greater than  $y - z$  then the Left stops of  $n \cdot G$  are:

$$\begin{array}{cccccccccccc} L(0) & L(G) & L(2 \cdot G) & L(3 \cdot G) & L(4 \cdot G) & L(5 \cdot G) & L(6 \cdot G) & L(7 \cdot G) & L(8 \cdot G) & \dots \\ 0 & x-y & y-z & x-z & 0 & x-y & y-z & x-z & 0 & \dots \end{array}$$

In our 4-stop example,  $H = a|b||c|d$ , when

$$3b + c > s > 2b + 2c$$

the equitableness of  $H$  becomes very clear when we write the stopping positions of  $n \cdot H$  in terms of those of  $H$ :

$$\begin{array}{cccccccccccc} L(0) & L(H) & L(2 \cdot H) & L(3 \cdot H) & L(4 \cdot H) & L(5 \cdot H) & L(6 \cdot H) & L(7 \cdot H) & L(8 \cdot H) & \dots \\ 0 & b & a+d & a+b+d & s & s+b & s+a+d & s+a+b+d & 2s & \dots \end{array}$$

In general, a very **equitable** game is one in which, for some sufficiently large  $n = 2^j$ , the value of both the Left stop and Right stop of  $n \cdot G$  is

$$\sum_i 2^{j-k(i)} a_i$$

where the  $a_i$  are all the possible stopping positions of  $G$  and  $k(i)$  is the number of moves from  $G$  to the stopping position  $a_i$ . So  $2^j$  copies of a very equitable game add up to a number when  $j$  is large enough.

## Excitable Games

If  $y + z \geq 2x$ , then the game

$$G = \{x \pm y \mid -x \pm z\}$$

simplifies to a number. But if  $G$  is a non-number in which just one of  $y$  and  $z$  exceeds  $x$ , then we call  $G$  **excitable**.

Considered as a public market offer of  $x$  free moves, the excitable game  $G$  is certainly not equitable, for it is offered to one player at a discount and to the other at a markup! And while the unlikelihood of immediate redemption allows the player a sum of many copies of an *equitable* game to ignore the possible cost (or profit!) which he may realize later as a result of the  $\pm x$  or  $\pm z$  which he pays for the immediate gain of  $x$ , the player of the sum of many copies of an *excitable* game can't!

If  $y > x$  and Left accepts the offer represented by  $G$ , then he must face the likelihood that Right will realize a quick profit by immediately redeeming the  $\pm y$  cheque. It will cost Left about  $n(y - x)$  to play  $n$  copies of the excitable game  $G$ . In fact Left plays in  $G$  primarily because he is a spoiler who realizes that if he doesn't buy up every available copy of  $G$  at a small loss, Right will later be able to buy some of them at a handsome profit. Right, on the other hand, may view Left's move from  $G$  to  $x \pm y$  as a threat to move to  $+y$  next time, a threat serious enough to demand an immediate response to  $-y$ .

In general, when playing a sum of several games, a move in an equitable component is usually followed by a reply in a different component, but a move in an excitable one usually requires a response in the same component. A *very* excitable move poses a grave threat which

*must* be answered immediately; an equitable move does not. In the language of the Japanese game of Go:

Excitable moves keep  **sente**.  
Equitable ones don't.

The game  $H = a|b||c|d$ , with  $a \geq b > c \geq d$ , is very equitable if  $3b + c > s > b + 3c$ , and is excitable if  $s > 4b$  or  $4c > s$ . Otherwise, the sum  $n \cdot H$  is best played equitably until about 3 turns before the stopping position, when optimum play switches to a more exciting finish. Many games,  $2|1||-1|-5$  for example, have non-obvious tendencies to be mildly excitable in certain circumstances, and so “equitable” and “excitable” are best thought of as informal terms.

In general the left stop of  $n \cdot H$ , when well played, is:

	$L(H)$	$L(2 \cdot H)$	$L(3 \cdot H)$	$L(4 \cdot H)$	$L(5 \cdot H)$	$L(6 \cdot H)$	$L(7 \cdot H)$	$L(8 \cdot H)$	$L(9 \cdot H)$	...	$m$
$s > 4b$	$b$	$2b$	$3b$	$4b$	$5b$	$6b$	$7b$	$8b$	$9b$	...	$b$
$4b > s > 3b + c$	$b$	$2b$	$3b$	$s$	$s + b$	$s + 2b$	$s + 3b$	$2s$	$2s + b$	...	$\frac{1}{4}s$
$3b + c > s > 2b + 2c$	$b$	$a + d$	$a + b + d$	$s$	$s + b$	$s + a + d$	$s + a + b + d$	$2s$	$2s + b$	...	$\frac{1}{4}s$
$2b + 2c > s > b + 3c$	$b$	$b + c$	$a + b + d$	$s$	$s + b$	$s + b + c$	$s + a + b + d$	$2s$	$2s + b$	...	$\frac{1}{4}s$
$b + 3c > s > 4c$	$b$	$b + c$	$b + 2c$	$b + 3c$	$s + b$	$s + b + c$	$s + b + 2c$	$s + b + 3c$	$2s + b$	...	$\frac{1}{4}s$
$4c > s$	$b$	$b + c$	$b + 2c$	$b + 3c$	$b + 4c$	$b + 5c$	$b + 6c$	$b + 7c$	$b + 8c$	...	$c$

## The Extended Thermograph

Let's see if we can't manage to compute the thermograph of a fairly complicated game like the Snort position

$$G = \bigcirc \text{---} \bullet \text{---} \bigcirc \text{---} \bullet \text{---} \bullet \text{---} \bullet = \{0, \{2|-1\} \parallel \{-2|-4\}\}$$

without first having to draw separate thermographs for all its options (cf. Fig. 9). For small enough  $t$  we have

$$\begin{aligned} G_t &= \{0 - t, \{2 - t|-1 + t\} - t \parallel \{-2 - t|-4 + t\} + t\} \\ &= \{-t, \{2 - 2t|-1\} \parallel \{-2|-4 + 2t\}\}. \end{aligned}$$

and we can indicate the stopping positions of this game by lines of appropriate slants as in Figure 16. Some of these lines meet at height  $t = 1$  for which we find

$$G_1 = \{-1, \{0|-1\} \parallel -2 + *\}.$$

If  $t$  is just greater than 1, say  $t = 1 + u$ , the first option becomes dominated and we have

$$G_t = G_{1+u} = \{\{-2u|-1\} \parallel -2 + u\}$$

until at  $t = 1\frac{1}{2}$ ,  $u = \frac{1}{2}$

$$G_{1\frac{1}{2}} = \{-1 + * \mid -1\frac{1}{2}\}$$

and so for  $t = 1\frac{1}{2} + v$  and small enough  $v$

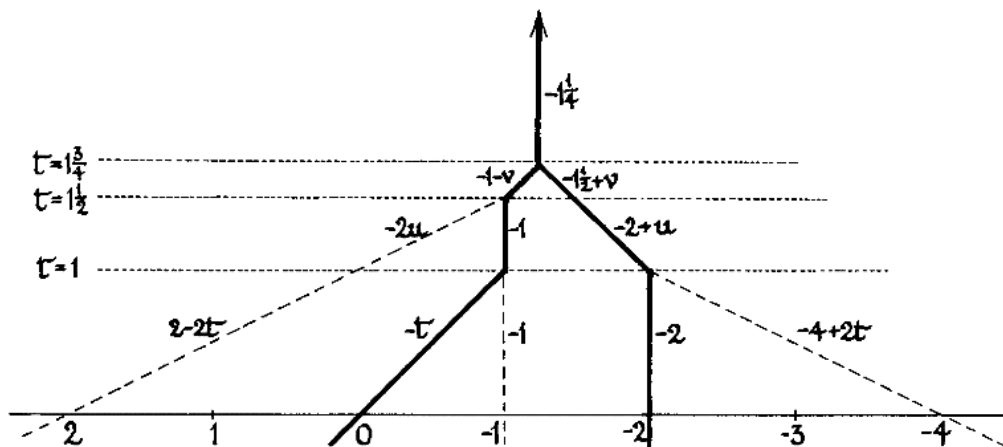


Figure 16. An Extended Thermograph.

$$G_t = \{-1 - v \mid -1\frac{1}{2} + v\}$$

until at  $t = 1\frac{3}{4}$ ,  $v = \frac{1}{4}$  we reach

$$G_{1\frac{3}{4}} = -1\frac{1}{4} + *$$

and so

$$G_t = -1\frac{1}{4}$$

for all larger  $t$ .

The **extended thermograph** contains lines representing *all* the stopping positions of the simplest forms of  $G_t$  for all values of  $t$ , with the Left and Right stops emphasized.

### Getting the Right Slant

It's fairly easy to work out the slants of all these lines directly. For instance, consider the game

$$\{a \parallel b|c\} \parallel \parallel \left\{ \{d \parallel e|f\} \parallel \parallel g \right\}.$$

Begin by putting a 0 under the slash of highest "order"; then put a 1 under the principal slash (a double one) in the Left option, and a  $-1$  under the treble one in the Right option. Then continue with successive generations of options, adding 1 to or subtracting 1 from the parent number:

$$\begin{array}{ccccccc}
 \{a & || & b & | & c\} & |||| & \{\{d & || & e & | & f\} & ||| & g\} \\
 & & & & & 0 & & & & & & & \\
 & & 1 & & & & & & & & & -1 & \\
 2 & & & & 0 & & 0 & & & & & & -2 \\
 & & & 1 & -1 & & 1 & & -1 & & & & \\
 & & & & & & & 0 & & -2 & & & \\
 \end{array}$$

and we read off the slants of the lines through

$$\begin{array}{ccccccc}
 a & b & c & d & e & f & g \\
 2 & 1 & -1 & 1 & 0 & -2 & -2
 \end{array}$$

to be

When there is more than one option, treat each one similarly. Our previous example was

$$\begin{array}{ccccccc}
 0 & , & 2 & | & -1 & || & -2 & | & -4 \\
 & & & & & 0 & & & \\
 1 & & & 1 & & & & -1 & \\
 & & 2 & & 0 & & 0 & & -2
 \end{array}$$

giving the lines  $0 - 1t$ ,  $2 - 2t$ ,  $-1 - 0t$ ,  $-2 - 0t$ ,  $-4 - (-2t)$ .

## The Thermostatic Strategy

We can't always work out the thermograph of a sum of several games from the thermographs of the components. For example, if

$$G = 4|-4 \quad \text{and} \quad H = \{4, 4 \pm 4 \mid -4, -4 \pm 4\}$$

then  $G$ ,  $H$  and  $G + H$  all have the same thermograph. However the thermograph of  $G + G$  is just a simple mast through 0, and so is different from that of  $G + H$ . The Left stop of the sum of two games with the same thermograph as  $G$  might be anything from 0 to 4, while the Right stop may be anything from  $-4$  to 0. We can't hope to obtain any more precise estimates of the confusion interval without looking beyond the thermographs into the more detailed structure of the components.

Indeed, when there are many components, the optimal strategy can be very complex and you may have neither the time nor the computing power needed to find the very best move. However, our thermostatic strategy, THERMOSTRAT, gives you an easy way of finding a "good move" which is close to optimal and will be enough to ensure your victory in many situations. THERMOSTRAT finds a good component for you to move in and then you can ignore the other components and find your proper play by just looking at the thermograph of this one. Even though the number of components may be very large, THERMOSTRAT ensures that you'll get a stopping position for the sum which differs from the optimal one by no more than the temperature of the hottest game.

Here's how to play THERMOSTRAT on

$$A + B + C + \dots,$$



supposing that your name is Left and you know the thermographs of  $A, B, C, \dots$ . Draw the **compound thermograph** whose *right boundary* is the sum

$$R_t(A) + R_t(B) + R_t(C) + \dots$$

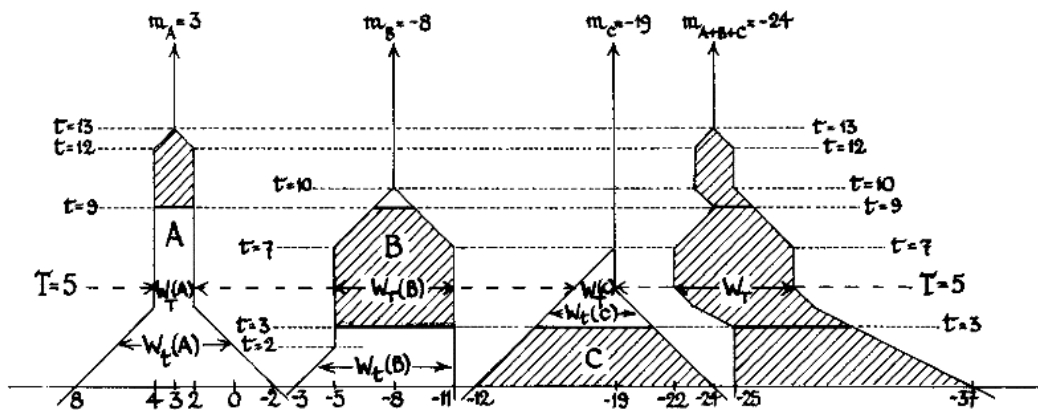
of those for the components, and whose *width* at height  $t$

$$W_t = \max\{W_t(A), W_t(B), W_t(C), \dots\}$$

is the largest width of any of the components at that height (Fig. 17). In other words the Left boundary of the compound thermograph is

$$R_t(A) + R_t(B) + R_t(C) + \dots + W_t$$

This is the amount that THERMOSTRAT guarantees Left if he starts with his thermostat set to give an ambient temperature of  $t$ .



**Figure 17.** Drawing a Compound Thermograph.

The temperatures at which Left feels most comfortable in our example are those between 5 and 7, where the Left boundary of the compound thermograph is furthest left. Since he's a seasoned campaigner who shows only just as much heat as is absolutely necessary, he prefers an ambient temperature of  $T = 5$ , and will therefore move in the component  $B$ , whose thermograph is the widest one at  $T = 5$ .

The **ambient temperature**  
is the least  $T$  for which  
 $R_T(A) + R_T(B) + R_T(C) + \dots + W_T$   
is maximal.

To find the THERMOSTRAT move,  
first find the ambient temperature,  $T$ ,  
and then make the  $T$ -move in a  
component that's widest at  $T$ .

Left's  $T$ -move in a game  $G$  is a move to an option which determined the Left boundary of the thermograph of  $G$  at temperature  $T$ .

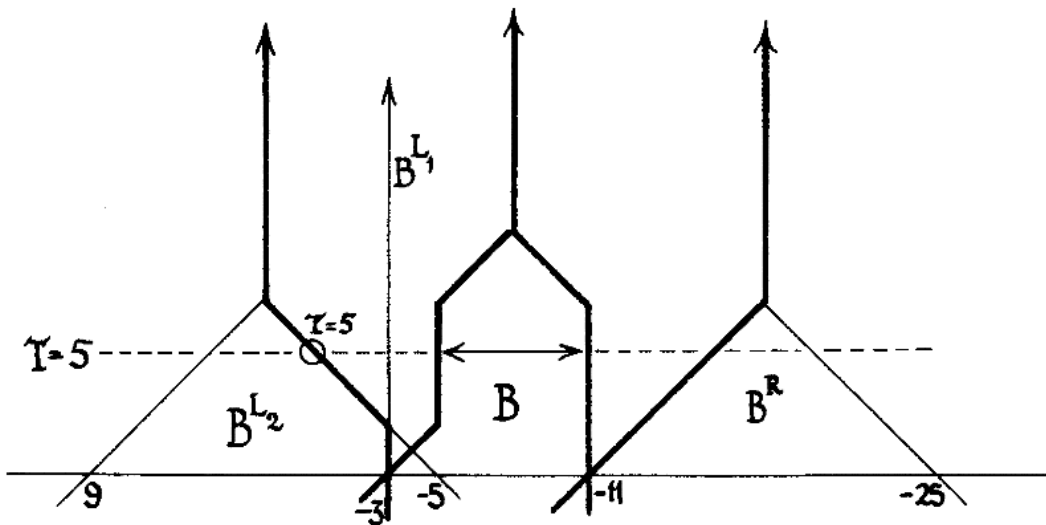
In our example, suppose that the thermograph of

$$B = \{-3, 9 \mid -5 \parallel -11 \mid -25\}$$

was worked out as in Fig. 18, and you'll see that  $B^{L_2} = 9 \mid -5$  was the option that determined its Left boundary at temperature  $T = 5$ . The THERMOSTRAT move is therefore that from

$$A + B + C \quad \text{to} \quad A + B^{L_2} + C.$$

In the Extras you'll see a proof that THERMOSTRAT does as well as we say it does.



**Figure 18.** Thermograph of  $B = \{B^{L_1}, B^{L_2} \mid B^R\} = \{-3, 9 \mid -5 \parallel -11 \mid -25\}$ .

### Thermostat's Not Often Wrong!

Because the boundary lines of a thermograph are always vertical or diagonal the difference between the Left or Right stop of a game and its mean value is at most equal to the game's temperature. Moreover,



the temperature of any sum  
is no more than the  
temperature of any component.

THERMOSTRAT achieves this bound, so

when you're playing the sum  
of a large number of games,  
the difference between THERMOSTRAT  
and the optimal strategy is  
bounded by the largest temperature.

For example if Left is playing the sum of a million games which all have integer stopping positions and temperatures at most 10, then THERMOSTRAT guarantees that he'll come within 10 of the stopping position. In fact by playing THERMOSTRAT, Left evidently makes a suboptimal move (i.e. one that decreases his final stopping position) at most 10 times, even though the compound game lasts several million moves:

THERMOSTRAT makes millions  
of optimal moves, and only  
a few suboptimal ones!

THERMOSTRAT provides independent proofs that

The Mast Value of a game  
is also its Mean Value,

and that

the Mast Value of a sum of  
games is the sum of the  
Mast Values of the components,

because the value it guarantees to either player is within a bounded amount of the sum of the mast values. THERMOSTRAT might therefore be called

PLAYING THE AVERAGES.

THERMOSTRAT has the property that for sums of many components,

the action's routinely  
in the hottest game.

WHERE'S THE ACTION?

But it also tells you a good move to make in the more exciting situations when this isn't so.

## Heating

The inverse of cooling is called **heating**. Formally, the result of heating  $G$  through a temperature  $t$  is the **integral**

$$\int^t G = \left\{ \int^t G^L + t \left| \int^t G^R - t \right. \right\},$$

unless  $G$  is a number, in which case

$$\int^t G = G.$$

As we cool a game down until it freezes at its mean value there will be certain critical temperatures at which it undergoes a phase change and "gives off" **particles**, and we can obtain the original game from the mean value by adding the heated forms of these particles.

Let's look at this for some of our examples. For the Snort position

$$G = \bullet \text{---} \bullet \text{---} \bullet = 2|-1$$

we found

$$G_{1\frac{1}{2}} = \frac{1}{2} + *$$

and

$$G_t = \frac{1}{2} \quad \text{for} \quad t > 1\frac{1}{2}.$$

So at temperature  $1\frac{1}{2}$ ,  $G$  gives off the particle  $*$ , and heating  $G_{1\frac{1}{2}}$  by  $1\frac{1}{2}$  we find

$$\bullet \text{---} \bullet \text{---} \bullet = \frac{1}{2} + \int^{1\frac{1}{2}} *.$$

For

$$G = \bullet \text{---} \bullet \text{---} \bullet \text{---} \bullet \text{---} \bullet = 1 || 0 | -2,$$

at the (only) critical temperature of 1 we find

$$G_1 = 0 || 0 | 0 = \uparrow$$

and so

$$G = \bullet \text{---} \bullet \text{---} \bullet \text{---} \bullet \text{---} \bullet = \int^1 \uparrow$$





For the example

$$G = \bullet - \circ - \bullet - \circ - \bullet - \circ - \bullet = 2 \mid 1 \parallel 0$$

there are two critical temperatures. We find

$$G_{\frac{1}{2}} = \{1 \mid 1 \parallel \frac{1}{2}\} = \{1 + * \mid \frac{1}{2}\}$$

but for small  $\delta > 0$

$$G_{\frac{1}{2}+\delta} = \{1 - \delta \mid \frac{1}{2} + \delta\}$$

whose “limit” as  $\delta$  tends to 0 is

$$G_{\frac{1}{2}+} = 1 \mid \frac{1}{2}.$$

The particle given off at temperature  $\frac{1}{2}$  is the difference

$$\begin{aligned} G_{\frac{1}{2}} - G_{\frac{1}{2}+} &= 1 * \mid \frac{1}{2} + -\frac{1}{2} \mid -1 \\ &= \{\frac{1}{2} * \mid *, \frac{1}{2} * \mid 0 \parallel 0 \mid -\frac{1}{2}, * \mid -\frac{1}{2}\} \\ &= \epsilon, \text{ say.} \end{aligned}$$

The next and last critical temperature is  $t = \frac{3}{4}$ , at the freezing point, and we find

$$G_{\frac{3}{4}} = \frac{3}{4} + *$$

so that

$$G = \bullet - \circ - \bullet - \circ - \bullet - \circ - \bullet = \frac{3}{4} + \int^{\frac{3}{4}} * + \int^{\frac{1}{2}} \epsilon.$$

In general a game  $G$  has certain **critical temperatures**

$$t_0, t_1, t_2. \dots$$

at which  $G_t$  differs from the limit  $G_{t+}$  of  $G_{t+\delta}$  as  $\delta$  tends to 0, so that at temperature  $t$  the cooled game changes phase and gives off the particles

$$\epsilon_t = G_t - G_{t+}$$

We then have Simon Norton’s **thermal dissociation** of  $G$ :

$$G = G_{\infty} + \int^{t_0} \epsilon_{t_0} + \int^{t_1} \epsilon_{t_1} + \dots$$

in which  $G_{\infty}$  is the mean value, the  $\epsilon_t$  are the (infinitesimal) particles given off and the largest  $t_i$  is  $G$ ’s own temperature. BUT BEWARE: Although every corner on the thermograph indicates a phase change there can be *latent* phase changes as well. Several instances occur among Snort positions, for example

$$G = \bullet - \circ - \bullet - \bullet - \bullet - \bullet = \{3 \mid 1 * \parallel -1 * \mid -2 *, 0 \mid -3\}$$

undergoes a phase transition from

$$G_{1\frac{1}{2}} = \frac{1}{2} \mid 0, * \quad \text{to} \quad G_{1\frac{1}{2}+} = \frac{1}{2} \mid 0$$

which is concealed in its thermograph (Fig. 19).

A common type of example is

$$\int^3 \uparrow + \int^5 \uparrow$$

which has the same thermograph (Fig. 20) as its hotter component, obscuring the phase change at  $t = 3$ .

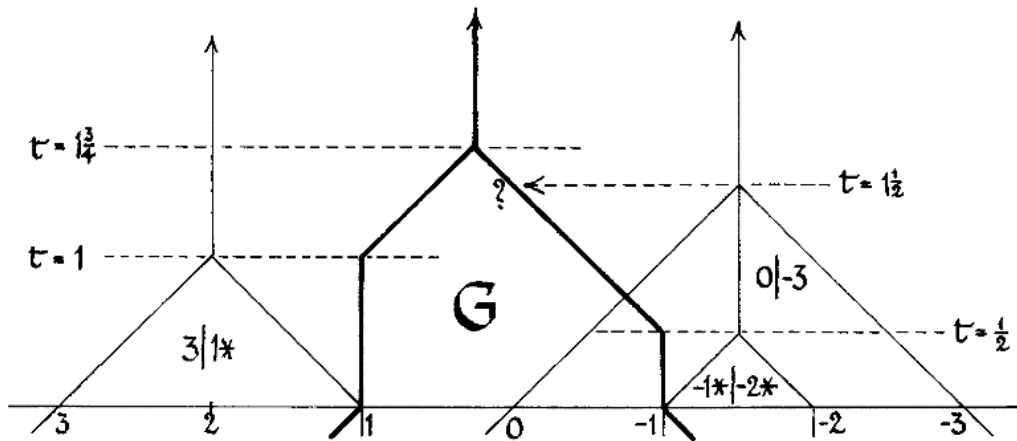


Figure 19. The Thermograph of  $\{3 | 1^*\} \parallel \{-1^* | -2^*\}, \{0 | -3\}$ .

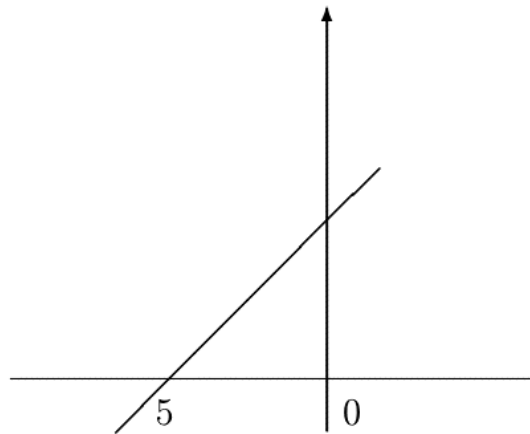


Figure 20. The Thermograph of  $f^3 \uparrow + f^5 \uparrow$ , or of  $f^5 \uparrow$ .

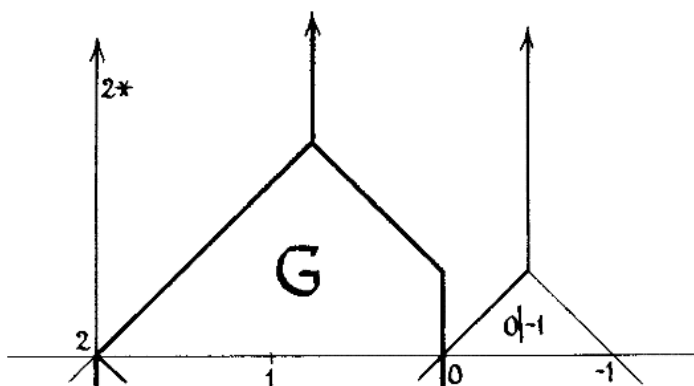
### Does The Excitement Show?

When the Left and Right boundaries are both slanting as they meet, it's a hint that the game may be equitable, and in the simplest cases the particle given off at the freezing point will be  $*$ . This happens for

$$G = \bullet \text{---} \bullet \text{---} \bullet \text{---} \circ \text{---} \bullet = 2^* \parallel 0 | -1,$$

whose thermograph is shown in Fig. 21.

But if, say, the Right boundary is vertical at the freezing point, the game is likely to be Right-excitable and the final particle given off will be a positive infinitesimal, often a tiny. For



**Figure 21.** Thermograph of  $\{2* \parallel 0 \mid -1\}$ .

example, the game

$$H = 5 \parallel 1 \mid -9$$

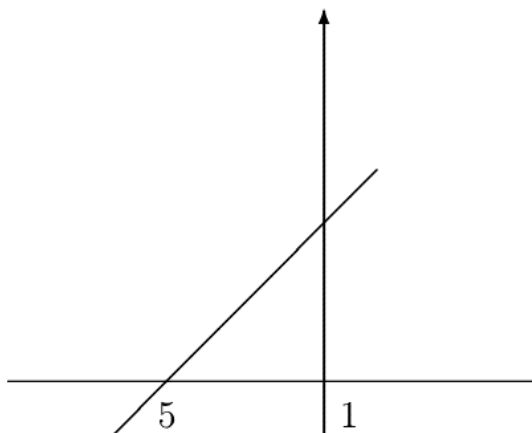
has temperature 4 and we find

$$H_4 = 1 \parallel 1 \mid -1 = 1 + \{0 \parallel 0 \mid -2\} = 1 + +_2$$

indexboundary, Left

Since this is the only critical temperature we have

$$H = 1 + \int +_2^4$$



**Figure 22.** The Thermograph of  $\{5 \parallel 1 \mid -9\}$ .

an excitable game whose thermograph is shown in Fig. 22.

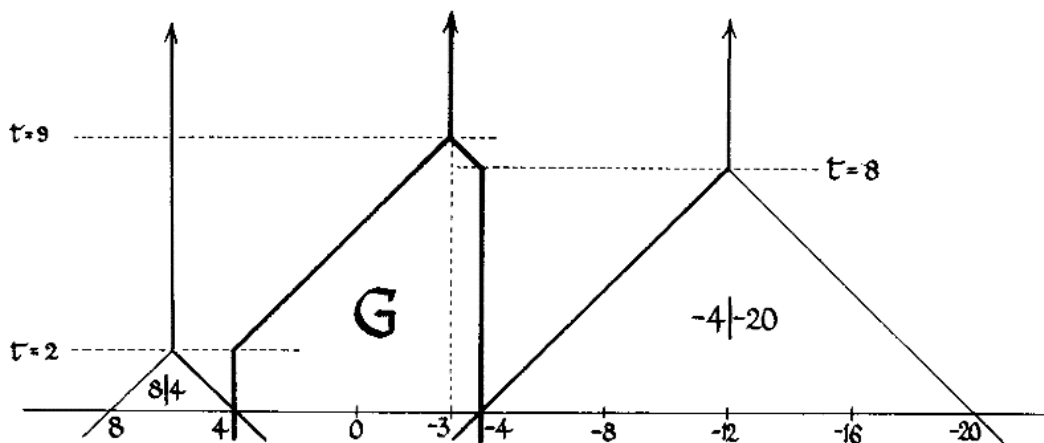
However, we'll see that in some cases the behavior of the game is controlled by a particle given off just *before* its freezing point, and in these cases the opposite adjective (of excitable, equitable) may be more appropriate.

## Selling Infinitesimal Values To Your Profit-Conscious Friends

Those who think in business terms usually associate the stopping positions with money rather than numbers of free moves. Such hard-headed business people aren't usually interested in infinitesimal games. "When there's no money in it," they ask, "why quibble about who gets the last move?" The answer is

You can't know all about hot games  
unless you know all about infinitesimals.

This is obvious because any hot game can be built by heating up infinitesimals. Although sums of differently heated infinitesimals can be very complex, sometimes a single heated infinitesimal provides an idea which is crucial to finding the best move in a hot game.



**Figure 23.** Thermograph of  $\{8 \mid 4 \parallel -4 \mid -20\}$ .

For example let's consider the game

$$G + G + \{-4 \mid -20\}$$

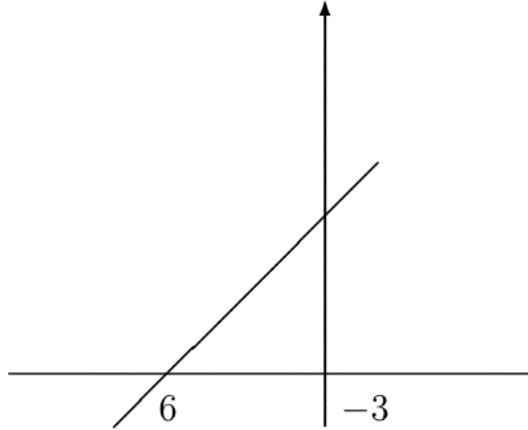
where

$$G = 8 \mid 4 \parallel -4 \mid -20$$

has the thermograph shown in Fig. 23, mean value  $-3$ , temperature  $9$ , and whose freezing point has the two slanting lines we normally associate with equitable games. However, if you



don't look too closely you won't see much difference between  $G$  and the following excitable approximation whose thermograph (Fig. 24) differs by at most 1 unit from that of  $G$  for all temperatures above 1:



**Figure 24.** Thermograph of  $H = -3 + \int^9 \uparrow = \{6 \parallel -3 \mid -21\}$ .

Since the approximating game satisfies

$$H + H + \{-3 \mid -21\} = -18 + \int^9 (\uparrow + \uparrow + *),$$

the original game behaves like

$$\uparrow + \uparrow + *,$$

in which Left should take care to move *not* to  $\uparrow + *$  (which is *not* positive), but to  $\uparrow + \uparrow$ . So Left's best move in the original game is *not* to

$$G + \{8 \mid 4\} + \{-4 \mid -20\}$$

but to

$$G + G - 4$$

A Right move from

$$G + G + G$$

to

$$G + G + \{-4 \mid -20\}$$

might not have been exciting in any strict sense, but it was bold enough to force Left to abandon his routine defence in order to get the last move in one of the hotter games (temperature greater than 2).

## Nim, Remoteness and Suspense in Hot Games

Again, if you understand the purely infinitesimal game of Nim, you'll not be too surprised to find that from the hot sum

$$-50 + \int^{100} *5 + \int^{99} *6 + \int^{98} *8$$

the only winning move is in the coolest game, to

$$48 + \int^{98} *3.$$

This won't be found by any strategy which plays the averages, because the hottest moves obscure it. But because there's a big temperature gap between 98 and 0 and only a small one between 100 and 98, the infinitesimal considerations dominate the thermal ones. In this position Left can ensure a stopping value of at least 40, but only with the above starting move. Any other starting move gives Right  $-37$  or better.

Hot games can also be made to depend on notions such as the suspense and remoteness numbers we'll introduce in Chapter 9. Consider *asymmetrical* heating:

$$\begin{aligned} \int^x \int^y 0 &= 0, \\ \int^x \int^y * &= x \mid -y. \\ \int^x \int^y *2 &= \left\{ x, x + \int^x \int^y * \mid -y, -y + \int^x \int^y * \right\}, \\ \dots &= \dots \\ \int^x \int^y *n &= \left\{ x + \int^x \int^y *k \mid -y + \int^x \int^y *k \right\}_{k=0,1,2,\dots,n-1} \end{aligned}$$

This is Nim with the condition that Left collects  $x$  points every move while Right collects  $y$  points. In a game like

$$100 \int^{99} *5 + 100 \int^{99} *6 + 100 \int^{99} *8$$

each player will try first to win the Nim game, but subject to that, Left will try to prolong the game and Right will try to shorten it. The confusion interval runs from 100 to  $-99$ , corrected by the suspense and remoteness functions of the corresponding Nim game. Evidently

you can't know everything about hot games  
unless you know lots of things about lots of others.



## Overheating

Other kinds of heating sometimes turn up. If you apply the rule for heating  $G$  by an amount  $X$  without any reservation at all we get what we call **overheating** by  $X$ , starting from  $s$ , where  $X$  and  $s$  are games, and for which we use the notation

$$\int_s^X G$$

whose value is  $\overbrace{s + s + \cdots + s}^{G \text{ times}}$  if  $G$  is a non-negative integer and

$$\int_s^X G = \left\{ X + \int_s^X G^L \mid -X + \int_s^X G^R \right\}$$

if  $G$  is not an integer. The most common case is  $X = 1$ , although  $X$  may be any positive game. Let's see what happens when we overheat by 1, starting from 2, using just

$$\int G \quad \text{for} \quad \int_2^1 G.$$

We find

$$\begin{aligned} 0 &= \{ \mid \}, & \text{so} & \quad \int 0 = \{ \mid \} = 0, \\ 1 &= \{ 0 \mid \}, & \text{so} & \quad \int 1 = \{ 1 + \int 0 \mid \} = 1 \mid = 2, \\ 2 &= \{ 1 \mid \}, & \text{so} & \quad \int 2 = \{ 1 + \int 1 \mid \} = 3 \mid = 4, \end{aligned}$$

and so on, all integers doubling.

$$\begin{aligned} \frac{1}{2} &= \{ 0 \mid 1 \}, & \text{so} & \quad \int \frac{1}{2} = \{ 1 + \int 0 \mid -1 + \int 1 \} = 1 \mid 1 = 1*, \\ \frac{1}{4} &= \{ 0 \mid \frac{1}{2} \}, & \text{so} & \quad \int \frac{1}{4} = \{ 1 + \int 0 \mid -1 + \int \frac{1}{2} \} = 1 \mid *, \\ \frac{3}{4} &= \{ \frac{1}{2} \mid 1 \}, & \text{so} & \quad \int \frac{3}{4} = \{ 1 + \int \frac{1}{2} \mid -1 + \int 1 \} = 2* \mid 1, \\ \frac{1}{8} &= \{ 0 \mid \frac{1}{4} \}, & \text{so} & \quad \int \frac{1}{8} = \{ 1 + \int 0 \mid -1 + \int \frac{1}{4} \} = 1 \parallel 0 \mid -1*, \end{aligned}$$

We can also overheat non-numbers:

$$\begin{aligned} \pm 1 &= \{ 1 \mid -1 \}, & \text{so} & \quad \int \pm 1 = \{ 1 + \int 1 \mid -1 + \int -1 \} = 3 \mid -3 = \pm 3, \\ * &= \{ 0 \mid 0 \}, & \text{so} & \quad \int * = \{ 1 + \int 0 \mid -1 + \int 0 \} = 1 \mid -1 = \pm 1, \\ \uparrow &= \{ 0 \mid * \}, & \text{so} & \quad \int \uparrow = \{ 1 + \int 0 \mid -1 + \int * \} = 1 \parallel 0 \mid -2. \end{aligned}$$

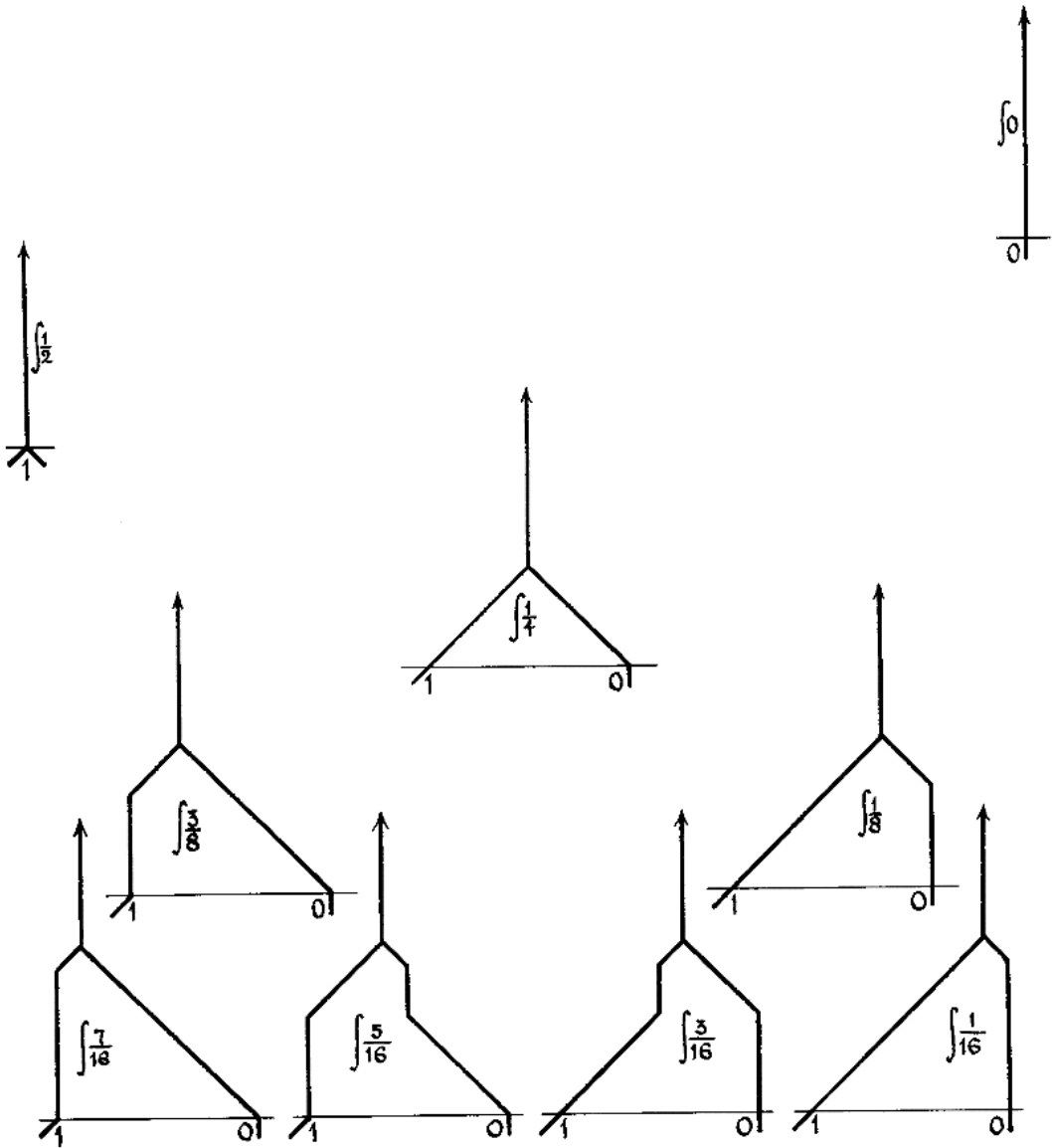
When  $X > 0$ , overheating from  $X+1$  to  $X$  preserves sums:

$$\int_{X+1}^X (A + B + C + \cdots) = \int_{X+1}^X A + \int_{X+1}^X B + \int_{X+1}^X C + \cdots$$

and so must multiply mean values by a constant factor. In particular, since

$$\int_2^1 1 = 2, \quad \text{the mean value of } \int_2^1 x \text{ is } 2x$$

for any number  $x$ . Figure 25 illustrates this with a few thermographs. These are easily found successively; for instance, each in the last row derives from the two nearest to it above. You can find the thermograph for  $\int(1-x)$  by reflecting that for  $\int x$  in the vertical line through 1.

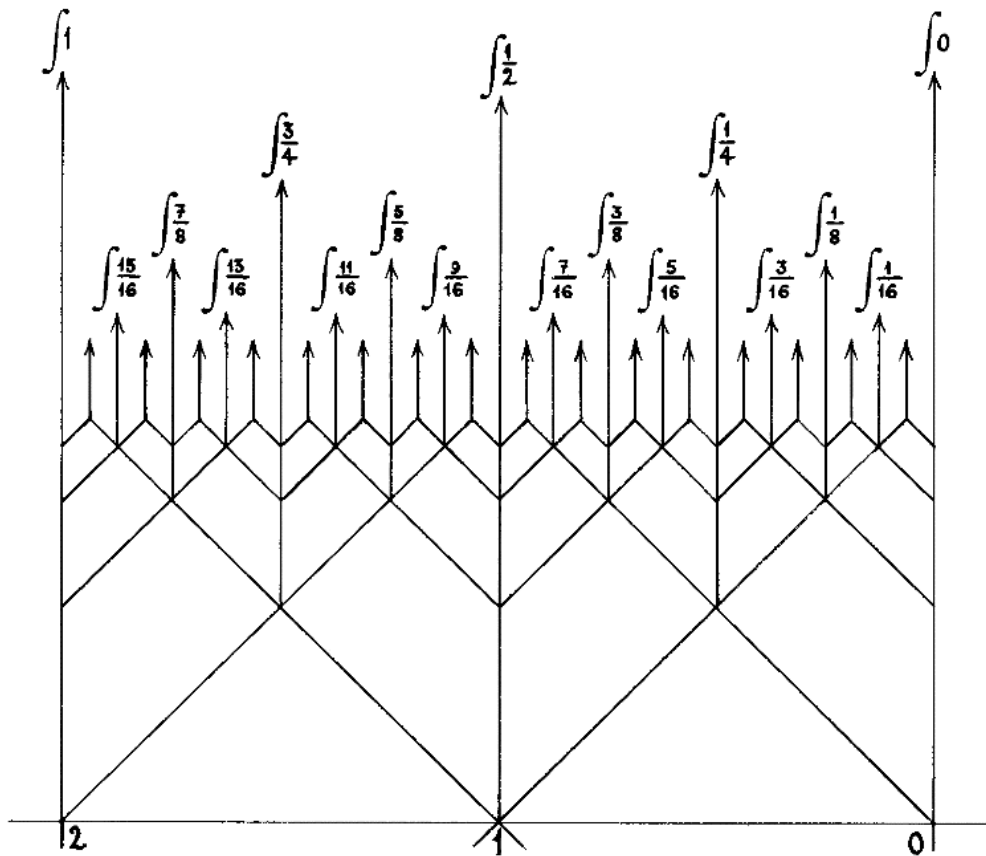


**Figure 25.** Thermographs of  $\int_2^1 x$ ,  $x = \frac{1}{2}, \frac{7}{16}, \frac{3}{8}, \frac{5}{16}, \frac{1}{4}, \frac{3}{16}, \frac{1}{8}, \frac{1}{16}, 0$ , which are the same as  $\int_{1*}^1 y$ ,  $y = 1, \frac{7}{8}, \frac{3}{4}, \frac{5}{8}, \frac{1}{2}, \frac{3}{8}, \frac{1}{4}, \frac{1}{8}, 0$ .





Figure 26 superposes all these thermographs, so that you can see how the thermograph for  $\int x$  changes as  $x$  varies.



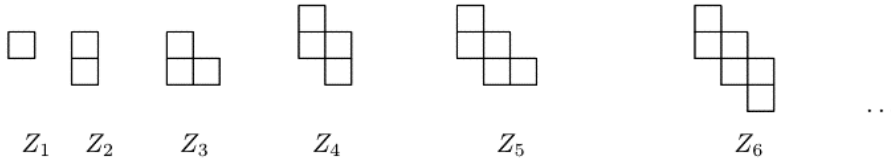
**Figure 26.** A Thermographic Thicket of Numbers Overheated from 2 to 1.

Sequences like

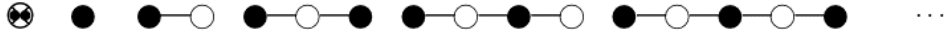
$$\begin{aligned} \int \frac{1}{2} &= 1*, \\ \int \frac{3}{4} &= 2* | 1, \\ \int \frac{7}{8} &= 3* | 2 || 1, \\ \int \frac{15}{16} &= 4* | 3 || 2 ||| 1, \\ \dots &= \dots \end{aligned}$$

arise in several games. Here are some examples.

The sequence of Domineering zigzags:



has the same values as the sequence of Snort positions



We have

$$Z_{2n+1} = \pm(Z_0 + Z_{2n-1}, Z_2 + Z_{2n-3}, Z_4 + Z_{2n-5}, \dots),$$

$$Z_{2n+2} = \{Z_0 + Z_{2n}, Z_2 + Z_{2n-2}, Z_4 + Z_{2n-4}, \dots \mid Z_1 + Z_{2n-1}, Z_3 + Z_{2n-3}, Z_5 + Z_{2n-5}, \dots\}$$

leading to the table

$n$	0	1	2	3	4	5	6	7	8	9	10	11	...
$Z_n$	0	0	1	*	1 0	$\pm 1$	2 *	$\pm 1^*$	2 1  0	$\pm(2 *, 2 0)$	1*	$Z_9 + *$	...

Let's compare

$$Z_8 = 2|1||0 \quad \text{with} \quad \int_2^1 \frac{3}{8} = 2|1^* || *$$

There is only an infinitesimal difference, so that  $Z_8$  is just  $\int \frac{3}{8}$  **infinitesimally shifted** and we write

$$Z_8 \quad \text{is} \quad \int \frac{3}{8}\text{-ish.}$$

In the same notation, we find that

$$\begin{array}{ll}
 Z_{8n+1} \text{ or } Z_{8n+3} & \text{is } 0\text{-ish} \quad \text{i.e. } \int 0\text{-ish,} \\
 Z_{8n-1} \text{ or } Z_{8n-3} & \text{is } \pm 1\text{-ish} \quad \text{i.e. } \int *\text{-ish.} \\
 Z_{8n+2} & \text{is } 1\text{-ish,} \quad \text{i.e. } \int \frac{1}{2}\text{-ish,} \\
 Z_{8n-2} & \text{is } 2|0\text{-ish,} \quad \text{i.e. } \int \frac{1}{2}^*\text{-ish,}
 \end{array}$$

while  $Z_{4n}$  gives the interesting sequence

$$Z_4 = 1|0, \quad Z_8 = 2|1||0, \quad Z_{12} = \{3|2||1 ||| 0\}\text{-ish}, \quad Z_{16} = \{4|3||2 ||| 1 |||| 0\}\text{-ish} \quad \dots$$

Comparing these with

$$\int \frac{3}{4} = 2 * |1, \quad \int \frac{7}{8} = 3 * |2||1, \quad \int \frac{15}{16} = 4 * |3||2 ||| 1, \quad \int \frac{31}{32} = 5 * |4||3 ||| 2 |||| 1, \quad \dots$$

and noting that  $\int \frac{1}{2} = 1^*$  is 1-ish, we see that

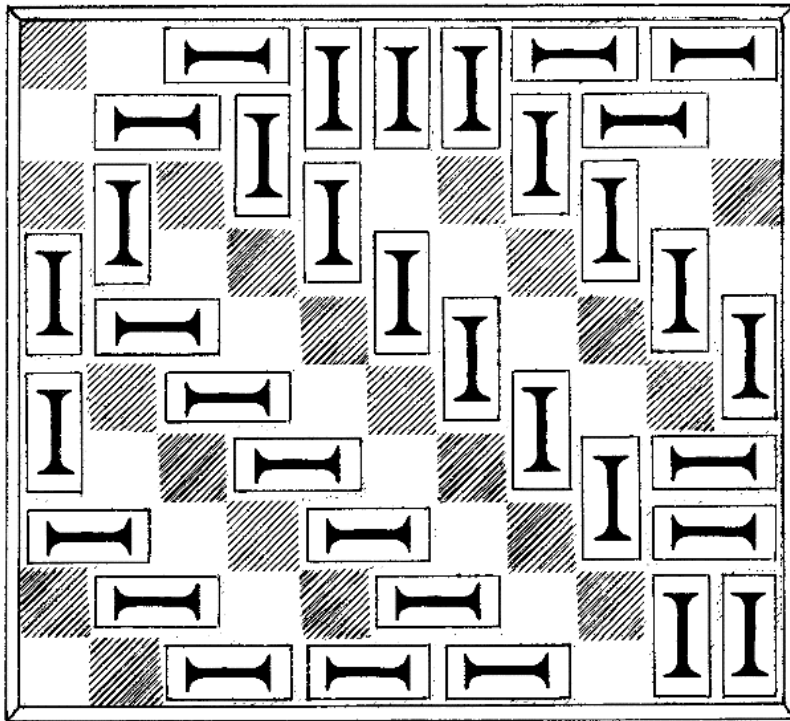
$$Z_4 \text{ is } \int \frac{1}{4}\text{-ish,} \quad Z_8 \text{ is } \int \frac{3}{8}\text{-ish,} \quad Z_{12} \text{ is } \int \frac{7}{16}\text{-ish,} \quad Z_{16} \text{ is } \int \frac{15}{32}\text{-ish,} \quad \dots$$

The Domineering position of Fig. 27 has value

$$\frac{1}{2} + * + Z_7 + Z_{14} - Z_8 + *$$

which is

$$\frac{1}{2} + \int (* + \frac{1}{2} * - \frac{3}{8})\text{-ish, i.e. } \frac{1}{2} + \int \frac{1}{8}\text{-ish.}$$

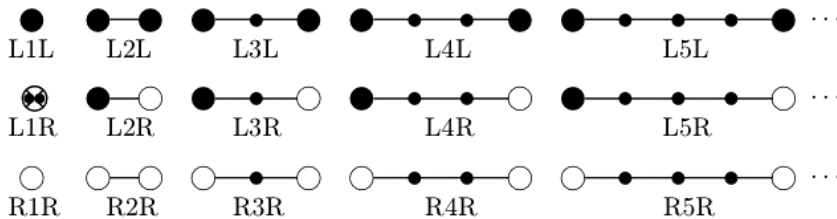


**Figure 27.** A Domineering Position after Left's Eighteenth Move.

Although  $\int \frac{1}{8}$  is surely positive, it has a Right stop of 0 and so there are  $\int \frac{1}{8}$ -ish games which are not positive. However, in our case the  $\frac{1}{2}$  outweighs the "ish", so that Left should win, even though it is not his turn. Even without the  $\frac{1}{2}$ , Left could win by starting, because the *Left* stop of  $\int \frac{1}{8}$  is 1 and this *won't* be affected by the ish.

### Cooling the Children's Party

The children's party game that closed our previous chapter is really just Snort played on a circular graph, which after some moves gets replaced by a number of chains of the forms



This time it's only after cooling by 1 that we see the structure. In fact

$$(LnR)_1 \text{ is } \begin{cases} 0\text{-ish} & \text{for } n = 6k + 1, 6k + 2, 6k + 3, \\ \pm 1\text{-ish} & \text{for } n = 6k, 6k - 1, 6k - 2, \end{cases}$$

while

$$(LnL)_1 \text{ is } \begin{cases} 2\text{-ish} & \text{for } n = 6k + 2, \\ (3|1)\text{-ish} & \text{for } n = 6k - 1, \end{cases}$$

and otherwise

$$\begin{array}{cccccc} 1\text{-ish} & (2|1)\text{-ish} & (3|2||1)\text{-ish} & (4|3||2||1)\text{-ish} & \dots & \\ \text{for } n = 1 \text{ or } 3 & 4 \text{ or } 6 & 7 \text{ or } 9 & 10 \text{ or } 12 & \dots & \end{array}$$

All these cooled values are  $\int_2^1 X$ -ish for suitable  $X$ , as given in the table

	1	2	3	4	5	6	7	8	9	10	11	12	13	14	...
$X$ for $(LnL)_1$	$\frac{1}{2}$	1	$\frac{1}{2}$	$\frac{3}{4}$	1*	$\frac{3}{4}$	$\frac{7}{8}$	1	$\frac{7}{8}$	$\frac{15}{16}$	1*	$\frac{15}{16}$	$\frac{31}{32}$	1	...
$X$ for $(LnR)_1$	0	0	0	*	*	*	0	0	0	*	*	*	0	0	...

## But How Do You Cool A Party By One Degree?

The obvious answer is to insist that each child bring a present suitable for one of the opposite sex. We suggest that each girl bring a unit blue Hackenbush stick and each boy a red one:

“blue for a boy, pink for a girl”

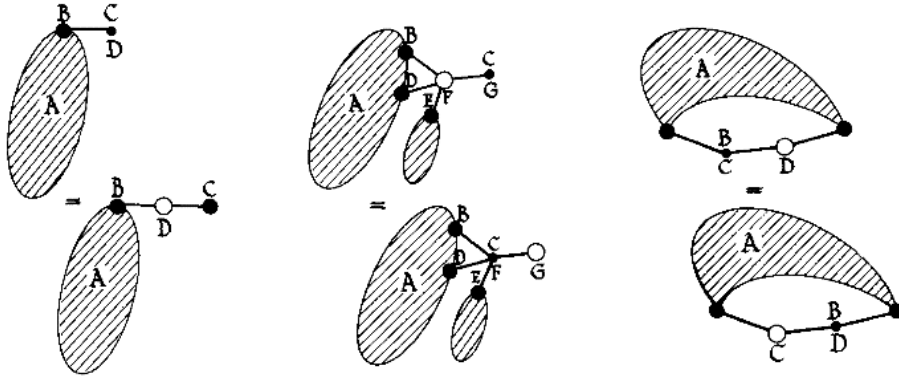
But a child who promises to be sociable and sit in a gap containing only 1 or 2 chairs is exempt from this requirement because the values of

L1L, L1R, R1R, L2L, L2R, R2R

are already number-ish and must not be further cooled.

# Extras

## Three Snort Lemmas



These identities are established by noting the corresponding moves indicated by letters above (Left) or below (Right) the appropriate nodes. In the middle figure the nodes D, E need not be present.

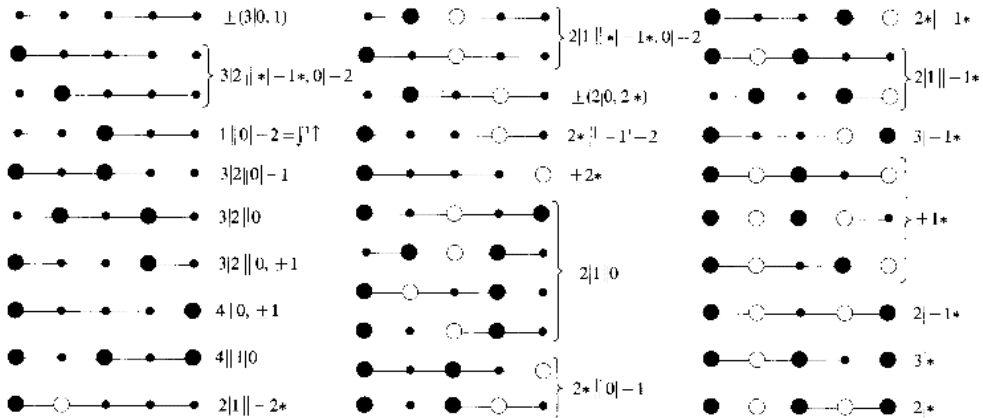


Figure 28. Values of 5-Node Snort Chains.

2	$4 2 1 1 *$	$4 2 1$	$3 2  0$	$3 2  1,1 *$	1	$4 2 0,-2$								
$4 2  * *$	$4 2  1 *$	$1 (3 0,3 *)$	$3 2  0,1$	$3 2  -1,-2$	$3  * -2$	$4 1 4 *  0 -2,3 * -3$								
$4 3  * *$	$4 3  1 *$	$1 *$	$3 2  0$	$3 2  -1$	$3  * -*$	$4 1 *,2 * -2 *$								
$4 2  1$	$1 (3 0,3 *)$	$4 1,4 *  1 *,1 *$	$3 2  0,1$	$3 1 0,-2$	$3  0 -2$	$4 1 * -3$								
$3 2  0$	$3 2  0,1$	1	1	$2  0$	$2  0 -1$	$3 2  1 *,0 -2$								
$3 2  1,1 *$	$3 2  -2,-1$	$3 1 0,-2$	$2  0$	$2  1 -1$	$\pm(2 0,2 *)$	$3 1 * -2 *,0 -3$								
1	$3  * -2$	$3  * -*$	$2  0,-1$	$\pm(2 0,2 *)$	0	$3  -1 *-3$								
$4 2 0,-2$	$4 1,4 *  0 -2,3 * -3$	$4 1 *,2 * -2 *$	$3 2  1 *,0,-2$	$3 1 * -3$	$3  -1 * -3$	*								
$3 2  1,1 *$	$3 2  0,-2$	$1 *$	$2  0$	$2  -1,0,-2$	$\pm(2 0,2 *)$	$3 1 * -1 -3$								
$3 * 0,-1$	$3 * 0,-2,*,*-2$	$3 0,3 *,2 *  1 *,0,-2$	$2  1 *$	$\pm 2 *$	$2 0,  -1,-2$	$3 0,2 *  1 *-1 -3$								
$2 * 0,-1$	$2 *  -2$	$\pm(2 0,2 *)$	$2 0,1 *  -2$	$\pm 1 *$	$1 *-1,-2$	$2 0,1 *  2 -3$								
$3 1 0$	$3 1  0,-3 0 -1,-2$	$3 1 * -2 *$	$\pm(3 0,3 *)$	$2  * +*,0,-2$	$2 0,  -1,-2$	$3 * -1 * -4$								
$3 1 0,0,3$	$3 1 * -3,1 *-2 *$	$\pm(2 0,*)$	$2 * * -1 -3$	$\pm 2 0 *$	$2 0,1 *  0,-3,*,3,1 * -2 *$	$2 * * -1 * -4,-2$								
$3 1  -2$	$\pm(3 1)$	$3 0,2 *  * -1 -3$	$3 0,2 0,-1 -3$	$2  1 -2 *$	$2 0,2 *  0,-1 -4,-1,-4$	$3 1 * -2 *,2 0,-1 -4,-1,-4$								
$\pm(2 1)$	$2  1 -1 -3$	$0 -1 -3$	$1 0 -2 *$	$1 0 -3 *$	$* -1 * -2 3$	$0,2 1 -2 1,-4$								

Table 1. Values of Snort Chains with Six Nodes.

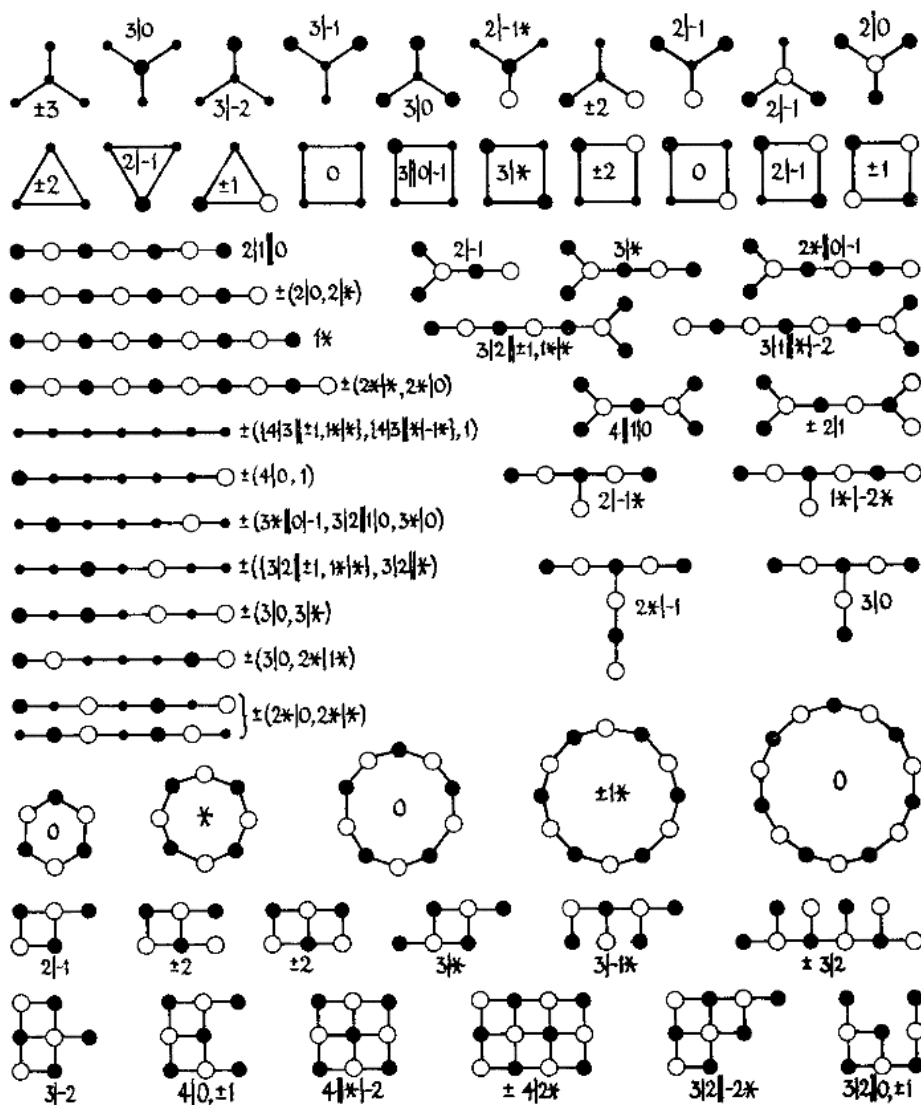


Figure 29. Values of Various Snort Positions.

## A Snort Dictionary

In Fig. 3 we gave the values of Snort chains with at most four nodes. Figure 28 gives values of 5-node chains and Table 1 those of chains with 6 nodes. Every such chain, or its negative, occurs. For the 6-node chains find 3 nodes at the head of a column and the remaining 3 on the right of the table; the arrowheads indicate the connexions. Figure 29 lists some miscellaneous positions.

## Proof of the Number Avoidance Theorem

It will be enough to prove that if  $x$  is equal to a number, but  $G$  is not, and if

$$G + x \triangleright 0, \quad \text{then some } G^L + x \geq 0.$$

This statement is unaffected if we replace  $x$  by an equivalent game and so we can suppose that  $x$  is in its simplest form. The good move from  $G + x$  must be to  $G + x^L \geq 0$  since otherwise some  $G^L + x \geq 0$ . If no  $G^L + x \geq 0$ , let

$$x > x^L > x^{LL} > x^{LLL} > \dots$$

be the finite decreasing sequence of successive Left options of  $x$ . If  $y$  is the smallest of these which has

$$G + y \geq 0,$$

then since  $G$  is not equal to the number  $-y$ , we have

$$G + y > 0, \quad \text{and so some } G^L + y \geq 0,$$

since we cannot have  $G + y^L \geq 0$ . So, for this  $G^L$ ,

$$G^L + x \geq G^L + y \geq 0.$$

The result can be used repeatedly to show that if  $x, y, z, \dots$  are equal to numbers, but  $G, H, K, \dots$  are not, and if

$$x + y + z + \dots + G + H + K + \dots \triangleright 0,$$

then we can find a good move for Left from one of the components  $G, H, K, \dots$ .

## Why Thermostrat Works

We assert that for any given  $T$ , Left can guarantee at least

$$R_T(A) + R_T(B) + R_T(C) + \dots - T$$

if *Right* starts, and at least

$$R_T(A) + R_T(B) + R_T(C) + \dots + W_T$$

if he starts himself.

For suppose that Right moves from

$$A + B + C + \dots \quad \text{to} \quad A^R + B + C + \dots.$$

Then Left is inductively guaranteed at least

$$R_T(A^R) + R_T(B) + R_T(C) + \dots + W_T(A^R)$$





and Fig. 30 shows that

$$R_T(A^R) + W_T(A^R) \geq R_T(A) - T,$$

no matter how  $T$  compares with the temperature of  $A$ .

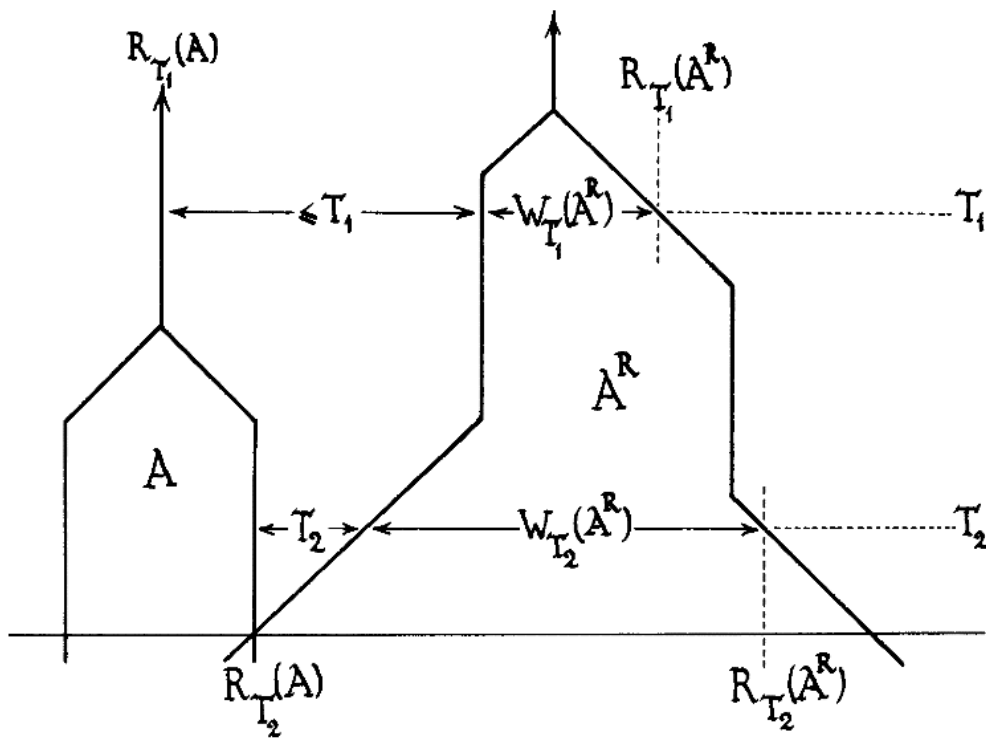


Figure 30. When Right Starts.

If it's *Left's* turn to move, we'll suppose first that some component has temperature at least  $T$ , and so the component,  $B$ , say, which is widest at  $T$ , will have a temperature at least  $T$  since games of lower temperature have width 0 at  $T$ . In this case THERMOSTRAT tells Left to make the  $T$ -move in  $B$ , say from

$$A + B + C + \dots \text{ to } A + B^L + C + \dots$$

when he is inductively guaranteed at least

$$R_T(A) + R_T(B^L) + R_T(C) + \dots - T,$$

and Fig. 31 shows that

$$R_T(B^L) - T = R_T(B) + W_T$$

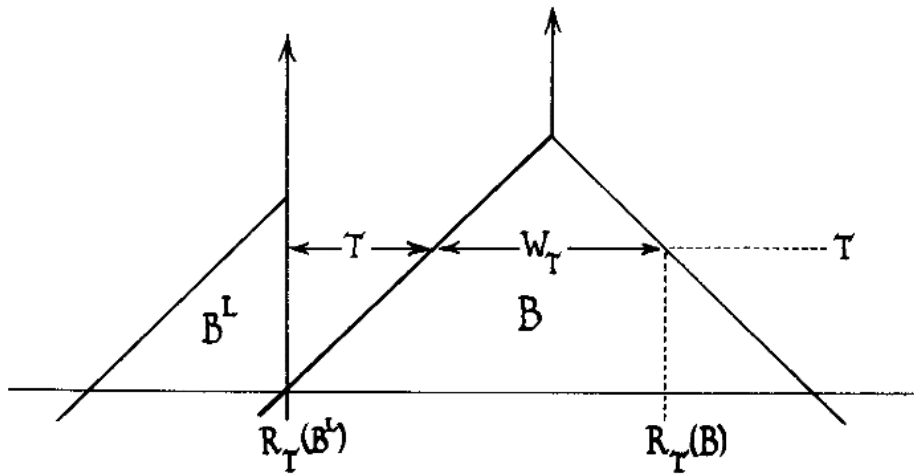


Figure 31. When Left Starts.

But, if every component has temperature strictly less than  $T$ , this argument fails. In this case Left should *reset* his thermostat to  $T_0$ , the largest temperature of any component (or possibly to an even cooler temperature) before continuing. Figure 32 shows that this will not reduce the value of

$$R_T(A) + R_T(B) + R_T(C) + \dots + W_T.$$

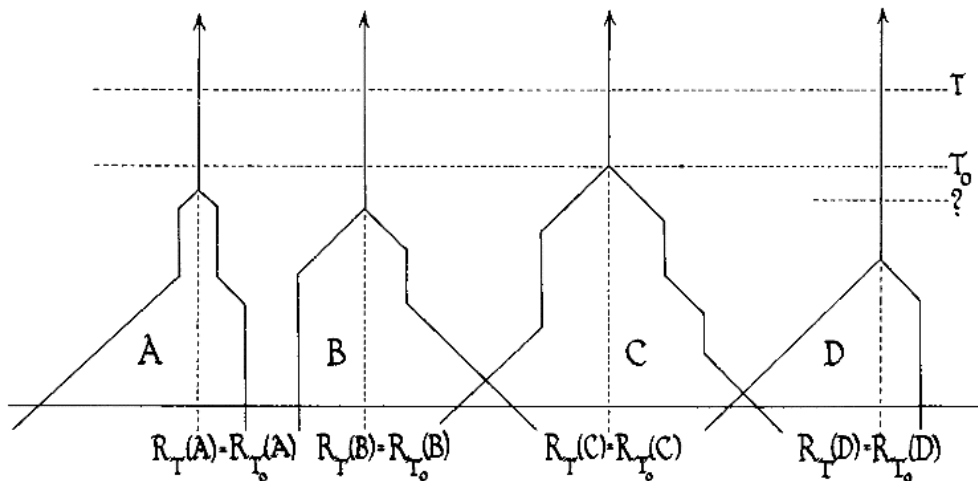


Figure 32. Resetting the Thermostat.



## Blockbusting

In the mid 1980s Berlekamp and his students were able to extend the idea of overheating. They used it to obtain a complete analysis of a game they called Blockbusting, and to obtain much more information about Domineering than was known earlier. Most remarkably, they were able to evaluate end-positions in the ancient and very difficult oriental game of Go.

Blockbusting is a partizan game in which Left and Right play on an  $n \times 1$  strip of squares called **parcels**. Each player, in turn, claims one previously unclaimed parcel and colors it with his color, blue for Left; Red for Right. The game ends when all parcels have been colored and Left's score is then equal to the number of parcel boundaries which have been colored blue on both sides. No points are awarded for blue-red or red-red adjacencies. Evidently, Left seeks to maximize the number of blue-blue adjacencies while Right seeks to minimize this number.

Three types of position occur:  $LnL$ ,  $LnR$ ,  $RnR$  denote  $n \times 1$  strips with ends bordered respectively by two blue parcels, a red and a blue parcel, two red parcels. The values are given *exactly* by

$$\int_1^{1*} x_n, \quad \int_1^{1*} y_n, \quad \int_1^{1*} z_n,$$

where  $\int = n \cdot * + \int$ , i.e.  $* + \int$  or  $\int$  according as  $n$  is odd or even, and  $x_n, y_n, z_n$  are as in the table:

$n$	0	1	2	3	4	5	6	7	8	...
$x_n$	1	1*	1	$1\frac{1}{2}$	$1\frac{3}{4}$	$1\frac{7}{8}$	2	$2\frac{1}{4}$	$2\frac{1}{2}$	...
$y_n$	0	$\frac{1}{2}$	$\frac{3}{4}$	$\frac{7}{8}$	1	$1\frac{1}{4}$	$1\frac{1}{2}$	$1\frac{3}{4}$	$1\frac{7}{8}$	...
$z_n$	0	0	0	$\frac{1}{2}$	$\frac{1}{2}$	$\frac{3}{4}$	1	1	$1\frac{1}{2}$	...

where the values, apart from irregularities for  $n = 0, x_1$  and  $x_2$ , are arithmetically periodic with period 5 and saltus 1.

### ... An On We Go!

These Blockbusting results have been extended in two important ways. First, thanks to a close relationship between Blockbusting and Domineering, precise expressions for the values of Domineering boards of sizes  $2 \times (2n + 1)$  and  $3 \times (2n + 1\frac{1}{3})$  were discovered, namely

$$\int_{\frac{1}{2}}^{\frac{5}{4}} \int_{\frac{1}{2}}^{\frac{1}{2}*} x_n \quad \text{and} \quad \int_{\frac{1}{4}}^{\frac{9}{8}} \int_{\frac{1}{4}}^{\frac{1}{4}*} x_n$$

where  $\int = n \cdot * + \int$  and  $x_n$  are as in Blockbusting.

Second, and even more remarkable, is the fact that a wide class of endgame positions in the Asian board game, Go, have values which can be expressed as

$$G = \int_{1*}^1 g$$

where  $g$  is the **chilled** value, obtained by cooling  $G$  by 1 degree. Thus, in Go as in Blockbusting, chilling can be inverted by warming. This result has led to a breakthrough in the study of late-stage Go endgames.

Go contains many loopy positions (see Chapter 11), called **kos** and **superkos**. The study of such positions, using extensions of thermography, is an active area of research. Some preliminary results appear in GONC, *More Games of No Chance* (the Proceedings of the 1994 and 2000 MSRI workshops), and other papers referenced there.

The modern overheating operator as now defined in the first paragraph of p. 176 of this second edition, may or may not be linear, depending on the games  $s$  and  $X$  and on the domain of  $G$  to which the operator is applied. One interesting case, studied by Kao Kuo-Yuen, in which the operator is *not* linear, is when  $s = X = 0$  and  $G$  ranges over the numbers. Then  $\int_0^0 G$  is a sum of powers of  $\uparrow$ , which depends on the binary expansion of  $G$  according to rules which Omar will enjoy working out.

## Hotstrat, Thermostrat and Sentestrat

Thermography can be extended to cover kos in the game of Go, situations where repetition of moves is not allowed.

There are various strategies you might consider when playing the sum of several hot games.

1. *Hotstrat*: Move in a component whose temperature is maximal.
2. *Thermostrat*: Move in a component whose thermograph is widest at the present ambient temperature (current tax rate).
3. *Sentestrat*: If your opponent has just moved to a temperature higher than the ambient temperature, respond directly in the same component. Otherwise, play Hotstrat. The new ambient temperature is the minimum of its previous value and the temperature of the position selected by Hotstrat. (Sente is the Japanese word for a forcing move in Go.)

These give the same answer in simple situations, but Hotstrat can lead you astray in more complicated ones. Look, for example, at the sum  $G + H$  where

$$G = 1 \parallel\parallel\parallel 10 \parallel 0 \mid -20 \parallel\parallel -21 \quad \text{and} \quad H = 1 \parallel 0 \mid -18$$

each have temperature 1. If Right plays  $G^R$ , then all three strategies recommend that Left responds with  $G^{RL} = 10 \parallel 0 \mid -20$ . If Right now plays to  $H^R = 0 \mid -18$ , the temperatures of the two components are 10 and 9 but Left is ill-advised to follow Hotstrat and play to  $10 + 0 \mid -18$ , since Right then plays to  $10 - 18 = -8$ . Left should respond immediately to  $H^{RL} = 0$  and win by playing to 0 after Right's move to  $0 \mid -20$ .

As another example, consider the sum  $F + G + H$  where

$$F = 6 \parallel A \mid -99. \quad G = -5 \parallel B \mid -99 \quad \text{and} \quad H = -6 \parallel C$$

with  $A, B, C$  as shown in Fig. 17, from which we find

$$m_{F+G+H} = m_F + m_G + m_H = 2 - 11 - 12 \quad \text{and} \quad t_{F+G+H} = t_G = t_H = 6.$$



No matter which of the three strategies Left uses to play second on  $F + G + H$ , he will answer Right's play from  $F$  to  $F^R$  with  $F^{RL}$  and Right's play from  $G$  to  $G^R$  with  $G^{RL}$ . But after Right next plays from  $H$  to  $H^R$ , arriving at the position  $A + B + C$ , Left's strategies differ. According to Sentestrat, the ambient temperature is still 6. Right just played to  $C$  and  $t_C = 7 > 6$ , so Sentestrat responds by playing  $C$  to  $C^L = -12$ , ensuring an eventual result

$$\geq R_6(A) + R_6(B) - 12 - 6 = 2 - 11 - 12 - 6 = -27 \geq m_{F+G+H} - t_{F+G+H}$$

But, as we saw on pp. 164–165, Thermostrat recomputes a reduced ambient temperature of 5, and plays on  $B$  to ensure an eventual score  $\geq -24$ .

## References and Further Reading

The existence of mean values for a class of games rather like ours was first raised and proved by Milnor and Hanner. Another proof (with a constructive algorithm) is due to Berlekamp, and yet another (very short, but nonconstructive) to S. Norton. Our thermographic method was originally taken from ONAG, but has since been considerably generalized by Berlekamp, Martin Müller, Bill Spight and their students.

E. R. Berlekamp, Blockbusting and Domineering, *J. Combin. Theory Ser. A*, **49**(1988) 67–116.

Elwyn Berlekamp, Introduction to Blockbusting and Domineering, in *The Lighter Side of Mathematics* (R. K. Guy & R. E. Woodrow, eds.), Spectrum Series, Math. Assoc. of America, 1994, 137–148.

Elwyn Berlekamp, An economist's view of combinatorial games, in *Games of No Chance*, Proc. MSRI Workshop on Combinatorial Games, July 1994, Berkeley CA (Richard Nowakowski, ed.), MSRI Publ. **29**, Cambridge University Press, pp. 365–405.

Elwyn Berlekamp & David Wolfe, *Mathematical Go: Chilling Gets the Last Point*, A K Peters, Ltd., 1994; also as *Mathematical Go: Nightmares for the Professional Go Player*, Ishi Press International, 1994.

Dan Calistrate, The reduced canonical form of a game, in R. J. Nowakowski (ed.) *Games of No Chance*, Proc. MSRI Workshop on Combinatorial Games, July 1994, Berkeley CA (Richard Nowakowski, ed.), MSRI Publ. **29**, Cambridge University Press, pp. 409–416.

J. H. Conway, *On Numbers and Games*, Second Edition, A K Peters, Ltd., 2001, Chapter 9.

Olof Hanner, Mean play of sums of positional games, *Pacific J. Math.*, **9**(1959) 81–99; *MR* **21** #3277.

Kao Kuo-Yuen, Sums of hot and tepid combinatorial games, PhD thesis, Univ. of North Carolina, Charlotte, 1997, 115 pp.

David Moews, On some combinatorial games connected with Go, PhD thesis, Univ. of California, Berkeley, Dec. 1993.

John Milnor, Sums of positional games, in Kuhn & Tucker (eds.) *Contributions to the Theory of Games*, Ann. Math. Studies, **28**, Princeton, 1953, 291–301.

Martin Müller, Elwyn R. Berlekamp & William L. Spight, Generalized thermography: algorithms, implementation and application to Go endgames, TR-96-030. Internat. Comput. Sci. Inst., Berkeley CA, ISSN 1075-4946, 1996.

William M. Spight, Extended thermography for multiple kos in Go, in *Computers and Games*, Springer Lecture Notes in Computer Science, **1558**(1999) 232–251.

Laura J. Yedwab, On playing well in a sum of games, MSc thesis, MIT, 1985. Issued as MIT/LCS/TR-348, MIT Lab. for Comput. Sci., Cambridge MA.

-7-

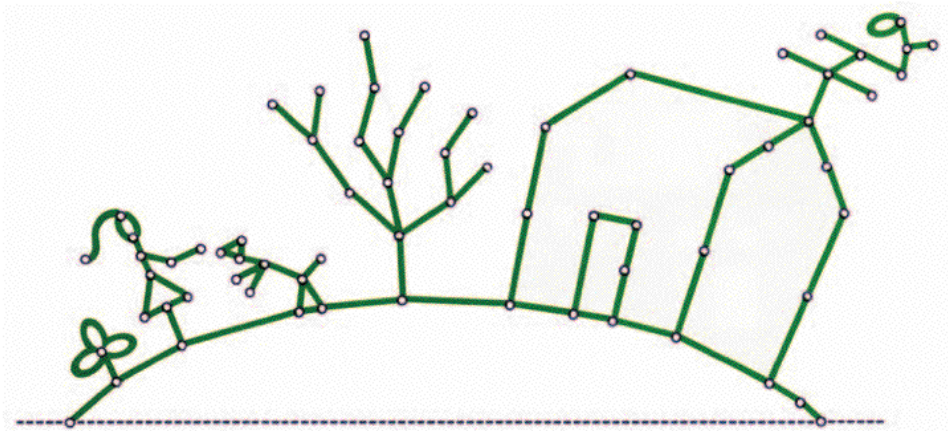
# Hackenbush

All things by immortal power,  
Near or far,  
Hiddenly  
To each other linkéd are.  
That thou canst not stir a flower  
Without troubling of a star.

Francis Thompson, *The Mistress of Vision*.

In this chapter we'll tell you what we know about Hackenbush (except for infinite and loopy varieties that you'll find in Chapter 11) but first we'd better warn you that the arguments are rather long. For those who are eager to skip on, some of the remarks about flower gardens are repeated in Chapter 8, so that you won't need to read this chapter to understand anything else in the book.

## Green Hackenbush



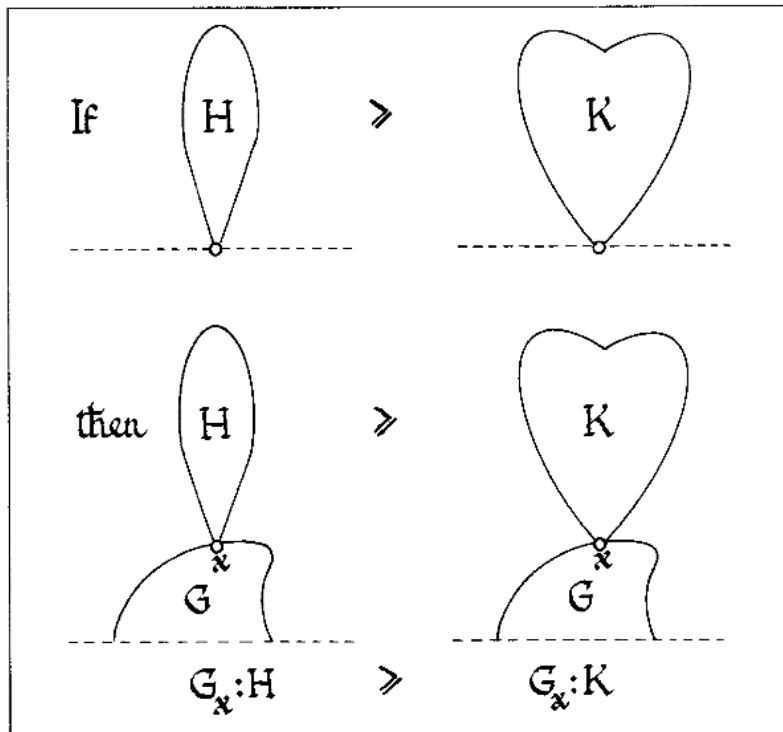
**Figure 1.** A Green Hackenbush Bridge.



In a totally grEen Hackenbush picture such as Fig. 1, any edge may be chopped by Either player, after which any edges no longer connected to the ground disappear.

Here there's a complete theory. First we observe that the Snakes-in-the-Grass argument of Chapter 2 shows that Hackenbush pictures made only of green strings are directly equivalent to Nim.

Next we use a very important tool, applicable not only in Green Hackenbush, but in Hackenbush more generally, called the **Colon Principle**.



### THE COLON PRINCIPLE

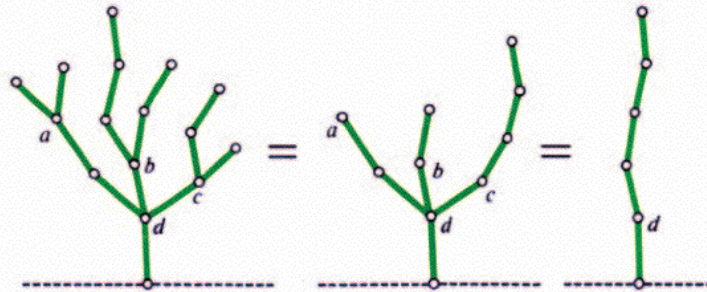
You can easily prove this by playing the difference of the two lower games. In particular,

$$\boxed{\text{if } H = K, \text{ then } G_x : H = G_x : K}$$

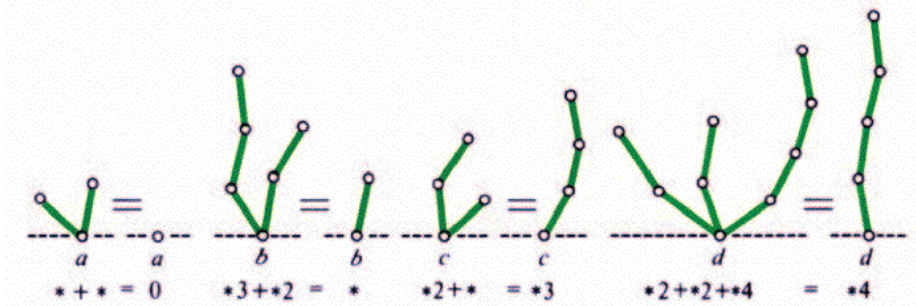
For a formal definition of  $G : H$  see the Extras.

## Green Trees

Green trees can now be evaluated using only the Colon Principle. For example, the tree



has value  $*5$  because



You can see that the Colon Principle often allows you to do your additions at some distance above the ground.

Observe that two kinds of addition are needed here. When moving down a branch towards the ground the nim-value is increased by adding 1 in the schoolbook way,  $+1$ , but when several branches join at a node, their values are added in the nim way,  $*\dagger$ . But because *both* types of addition have the properties

$$\begin{aligned} \text{odd plus odd} &= \text{even plus even} = \text{even}, \\ \text{odd plus even} &= \text{even plus odd} = \text{odd}, \end{aligned}$$

you can see that

The nim-value of any sum of green trees has the same parity as the total number of edges.

### THE PARITY PRINCIPLE

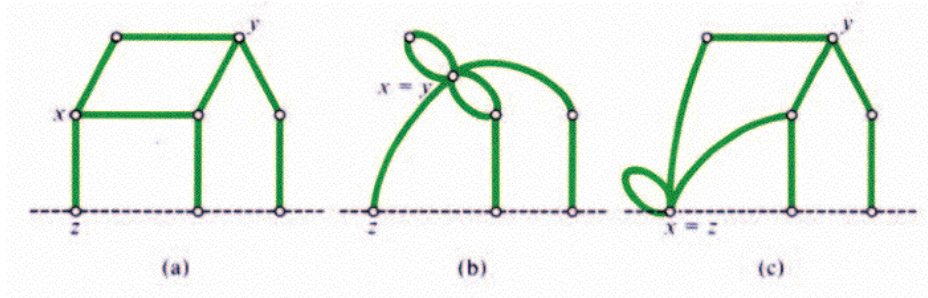
The Fusion Principle below will show that this extends to all Green Hackenbush pictures.





### Fusion

You **fuse** two nodes of a picture by bringing them together into a single one. Any edge joining them gets bent into a loop at the resulting node. If you fuse  $x$  and  $y$  in Fig. 2(a) you get Fig. 2(b); if you fused  $x$  and  $z$ , you'd get Fig. 2(c).



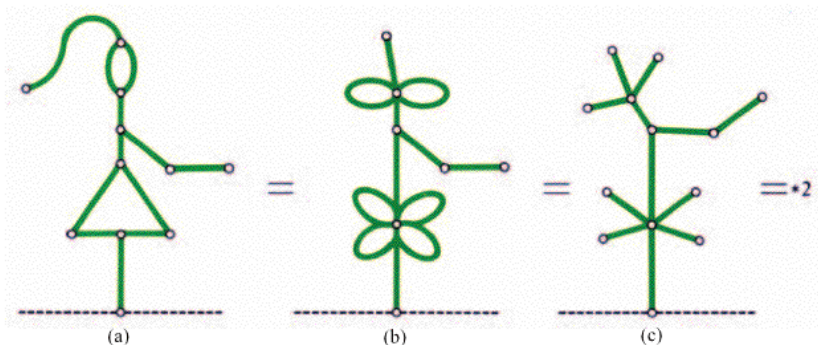
**Figure 2.** Fusion to your house!

Green Hackenbush is completely solved by

#### THE FUSION PRINCIPLE:

you can fuse all the nodes in any cycle of a Green Hackenbush picture without changing its value,

and the fact that a loop at any node has the same effect as a twig there. For example the girl



**Figure 3.** Sizing Up a Green Girl.

of Fig. 3(a) becomes the green shrub of Fig. 3(b) when we've fused the four nodes of her skirt and the two nodes of her head, and this becomes a tree (Fig. 3(c)) on replacing the leaves by twigs. The Colon Principle then shows the tree, and therefore the girl, to have value  $*2$ .

## Proving The Fusion Principle

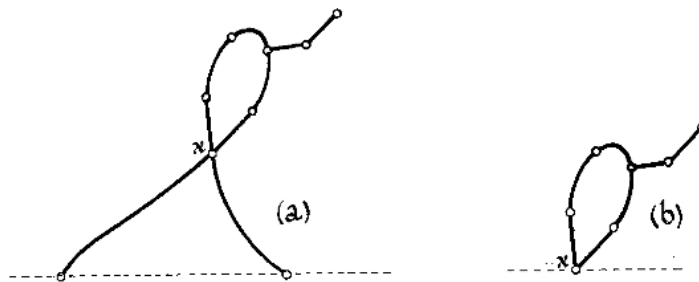
It will take us quite a long time to prove this principle. An alternative, but equally long, proof using mating functions and the Welter function (see Chapter 15) will be found in ONAG. The proof here has the advantage of explicitly constructing the winning move. We'll omit some purely arithmetic computations which are needed for the proof, but not to find the winning move.

If there's any counter-example to the Principle, choose one with the smallest number  $n$  of edges, and among counter-examples with  $n$  edges, choose one,  $G$ , say, with the smallest number of nodes (so there can be no legal fusion of any two nodes of  $G$ ).

First,  $G$  can only have one ground node since it never affects play to fuse all ground nodes.

Next,  $G$  can contain no pair of nodes  $a, b$ , connected by three or more edge-disjoint paths for otherwise the game  $H$ , obtained by fusing  $a$  and  $b$ , would have to have a different nim-value and so there would be a winning move in  $G + H$ . Whichever of  $G$  and  $H$  this move is in, respond with the corresponding move in the other, reaching a game  $G' + H'$ . But since  $G'$  and  $H'$  have at most  $n - 1$  edges, we can fuse any cycles in them to single points without affecting their values and because there is still a cycle containing both  $a$  and  $b$ , we see that  $G' + H' = 0$ , dismissing the supposed winning move from  $G + H$ .

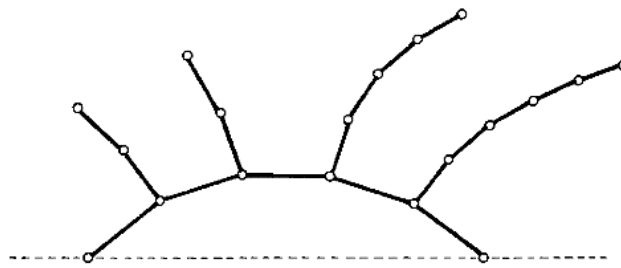
No cycle of  $G$  can exclude the ground for if  $G$  had such a cycle  $C$ , consider the position  $G'$  which would remain after Hackenbush moves chopping all edges of  $C$ . Then  $G'$  can't contain two distinct nodes of  $C$ , for these would be connected, in  $G$ , by three edge-disjoint paths (two in  $C$  and one in  $G'$ ). So  $G'$  contains only one node,  $x$ , of  $C$ , and  $G$  looks like Fig. 4(a). Now if  $x$  were the ground we could apply the Fusion Principle to fuse all nodes of the smaller graph (Fig. 4(b)) and the Colon Principle allows us to fuse these nodes off the ground.



**Figure 4.** Pulling Cycles to the Ground.

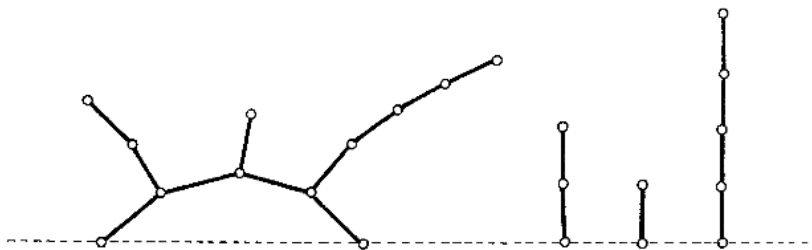
Finally,  $G$  contains only one cycle which includes the ground for otherwise it would be the sum of smaller graphs, since nodes from distinct cycles can't be joined by other paths. But we could now apply the Fusion Principle to the smaller graphs.

We can now see that  $G$  must look like a bridge (Fig. 5, though officially we should identify the two ground nodes) in which, by the Colon Principle, we can suppose that the edges not in the bridge form at most one string at each node.



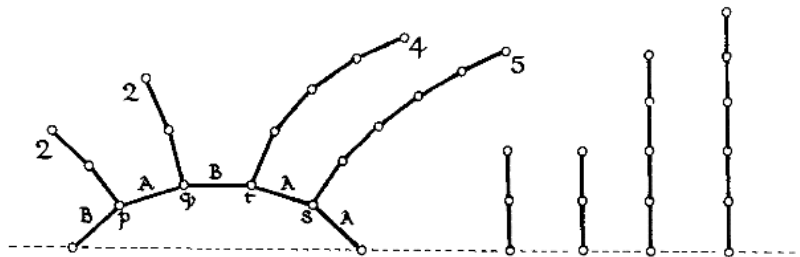
**Figure 5.** What a Minimal Criminal Looks Like.

The number of edges in the bridge (its **span-length**) is *odd*. If a bridge has an even span-length, consider the sum (Fig. 6) of this bridge with copies of all of its strings. Removing any edge of the bridge in this is bad, because the resulting nim-value is odd by the Parity Principle. A symmetry strategy therefore shows that Fig. 6 has value 0 and the Fusion Principle applies.



**Figure 6.** An Even Span Bridge with Copies of its Strings.

The Fusion Principle for a bridge of *odd* span-length asserts that its value is found by adding \* to the sum of its strings. So we must show that Fig. 7 has value \*.



**Figure 7.** An Odd Span Bridge with Copies of its Strings.

Certainly *no option has value \**, because moves in the bridge lead to even nim-values by the Parity Principle, and moves in the strings can be reversed to \* by responding with their images (after which the Fusion Principle will apply to the smaller picture).

It will therefore suffice to find an option of value 0. To do this, label the bridge edges with  $A$  or  $B$ , giving adjacent edges the *same* label if there is an *odd* string between them, and different labels if there's an *even* string between. The edges with the (*Devil's*) label which occurs an *even* number of times ( $B$  occurs twice in Fig. 7) are bad moves since each of them can be seen to lead to a sum of two trees and several strings where the nim-value of the sum is congruent to 2, mod 4, and therefore non-zero. However any of the (*odd* number of) edges with the other (*Godd's*) label leads to a sum with nim-value congruent to 0, mod 4. To find a good bridge move among these, we reduce the graph to a simpler one by shrinking any edge with a Devil's label to a single point, and halving all string-lengths (rounding *down* if they're odd). It can be shown that this reduction also halves the nim-value. Applying it to Fig. 7 leads to the simpler Fig. 8 because 2 halves to 1,  $2 \not\equiv 4$  halves to 3 and 5 halves to 2. A similar labelling splits the bridge edges into an even (*Devil's*) number labelled  $D$  and an odd (*Godd's*) number labelled  $C$ . Since in our case there is only one  $C$  edge, it is the winning move in Fig. 8, and the corresponding edge (between the 5 string and the ground) wins in Fig. 7.

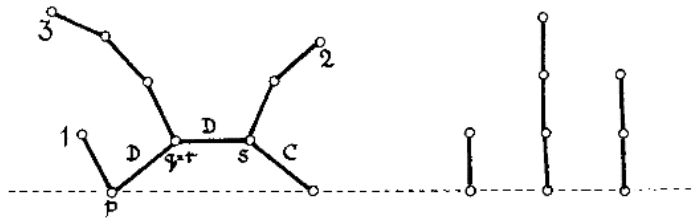


Figure 8. Half of Figure 7.

## A More Complicated Picture

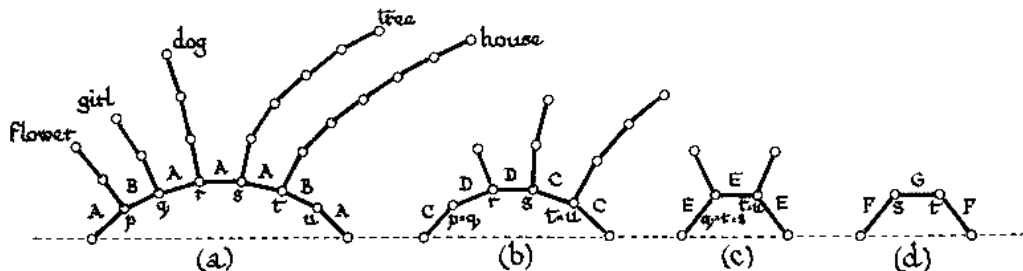


Figure 9. Simplifying and Halving Figure 1.

We'll find a winning move in our opening picture, Fig. 1. When we fuse the cycles contained in or under the girl, dog and house, and evaluate the various pieces we get Fig. 9(a). The

halving process leads successively to Figs. 9(b), 9(c) and 9(d). The only good move in this last is the centre span of the reduced bridge. This corresponds to the edge between the tree and the house in Fig. 1.

Since edges on grounded cycles tend to split the picture up too quickly, the reader who wishes to bamboozle his opponents will verify that there are 17 other good moves in Fig. 1: the bird's tail, the top left branch of the T.V. antenna, any of the four pieces of foundation under the house, the lowest twig on the (right of the) tree, the dog's tail, his face, either hind leg, either part of the girl's head and any of the four parts of her skirt.

Green Hackenbush can be applied to the theory of

### Impartial Maundy Cake

Impartial Maundy Cake which is played like ordinary Maundy Cake (Chapter 2) except that either player may divide the cake in either direction. Since the game is impartial, any even number of identical cakes cancel, while an odd number have the same value as a single cake.

If  $\alpha$  and  $\beta$  are the numbers of *odd* prime divisors of  $a$  and  $b$ , counted with mutiplicities, we shall say that an  $a$  by  $b$  cake has type

$$D(\alpha, \beta) \quad \text{or} \quad E(\alpha, \beta)$$

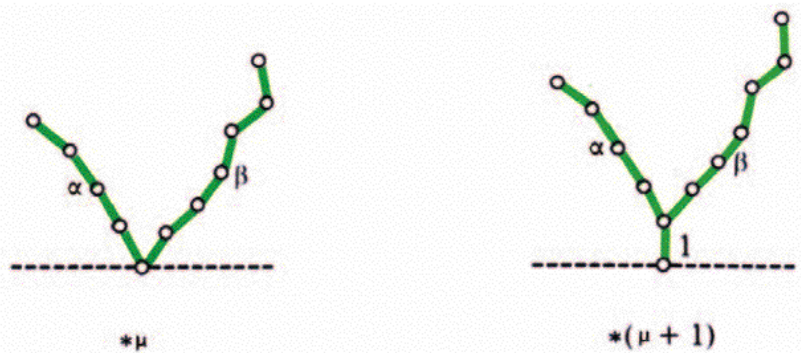
according as  $ab$  is

odd or even.

The moves that produce an odd number of cakes correspond just to reductions of  $\alpha$  or  $\beta$ . However, a move that produces an even number of cakes is necessarily from a type  $E(\alpha, \beta)$  cake and gives value 0, so

$$D(\alpha, \beta) \quad \text{and} \quad E(\alpha, \beta)$$

have the same values as the Green Hackenbush positions



where  $\mu = \alpha \ddagger \beta$ .

We shall discuss Many-Way Maundy Cake in the Extras.

## Blue-Red Hackenbush

Recall that in Hackenbush

bLue edges may be chopped by Left,  
 Red edges may be chopped by Right,  
 grEen edges may be chopped by Either.

We've just seen what happens when *all* edges are green. If *no* edges of a picture  $P$  are green its value is always an ordinary number. For suppose Left makes a move resulting in a picture  $P^L$ , say. Then  $P$  can be obtained from  $P^L$  by adding a blue edge which perhaps supports some other edges and it is easy to see that this has *strictly* increased the value, so

$$P^L < P < P^R \quad \text{for all options } P^L, P^R.$$

By induction,  $P^L$  and  $P^R$  are numbers, so  $P$  is a number. On the other hand, we'll see later in this chapter that it can be very hard to work out just which number it is.

## Hackenbush Hotchpotch

You'll remember from Chapter 2 that this is our name for Hackenbush when the picture may involve all three colors, bLue, Red, grEen.

Roughly how big is a Hotchpotch picture? The most important thing to look at is the part of the picture made up of the red and blue edges which are connected to the ground by other red and blue edges. We call this the **purple mountain**; the rest of the picture is the **green jungle** (which may have red and blue blossoms embedded in it).

The value of a Hotchpotch picture is only infinitesimally different from the value of its purple mountain.

To see this, suppose that the value of the purple mountain is the number  $x$ . Then chopping any edge not in the mountain yields a smaller picture with the same mountain whose value is

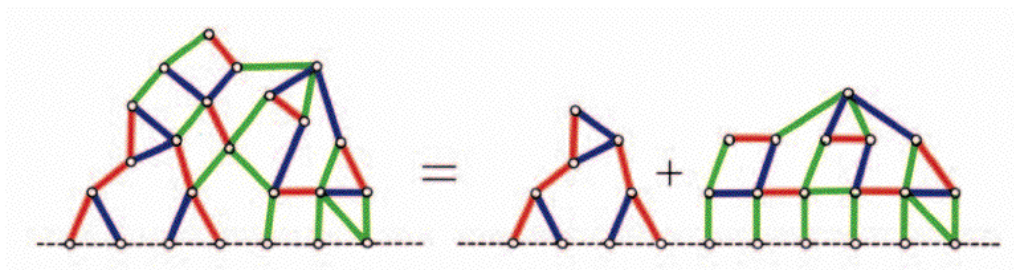
$x$ -ish ("x infinitesimally shifted")

meaning the sum of  $x$  and something like  $\uparrow$  or  $*$  that is infinitesimally small. Moves in the mountain lead to values that are  $x^L$ -ish or  $x^R$ -ish, depending on who makes them. Since these are more than infinitesimally different from  $x$ ,

no sane person will chop an edge in the purple mountain while there's any other edge to chop.

It follows that, from the point of view of all the edges *not* in it, the purple mountain behaves exactly like the ground.

The green jungle slides  
down the purple mountain!

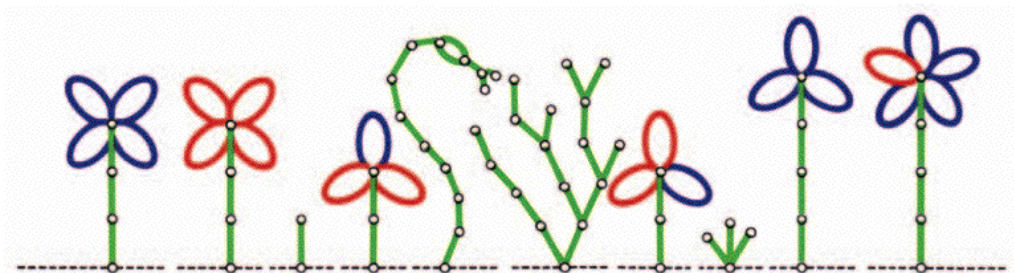


**Figure 10.** Sliding Jungles down Mountains.

If you know all about  
Purple Mountains  
and Green Jungles  
you know all about  
Hackenbush Hotchpotch.

## Flower Gardens

The green jungles that have come nearest to being cleared are the **flower gardens** which are sums of flowers and totally green positions.



**Figure 11.** A Variegated Flower Garden.

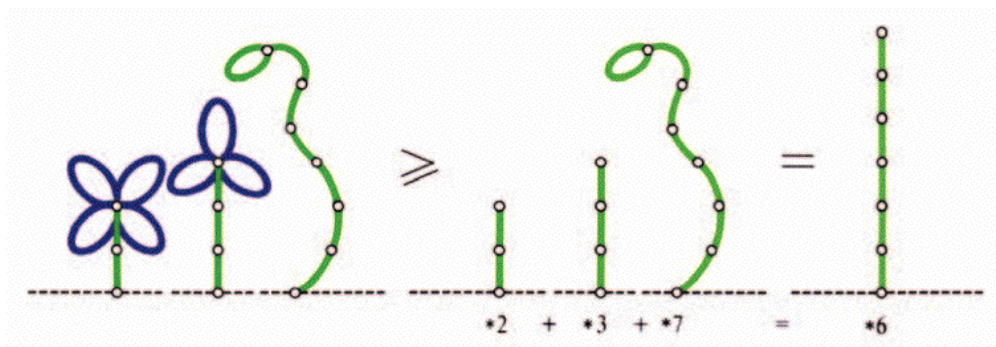


A **flower** has a **stem** of green edges supporting a **blossom** of blue or red petals. Of course the *negative* of a flower is another flower of the same stem-length, but with petals of opposite colors — the first two flowers of Fig. 11 are negatives of each other. By the Colon Principle a flower with  $l$  blue petals and  $r$  red ones has the same value as an equally long one with  $l - r$  blue petals or  $r - l$  red ones according as  $l \geq r$  or  $l \leq r$ . So the last flower of Fig. 11 simplifies to its neighbor. For this reason we shall assume from now on that any blossom is purely red or purely blue — a **geranium** or a **delphinium**

As a flower game proceeds some of the blossoms may be cut right off although part of the stems remain. You can think of the resulting green strings as grass or snakes — their values are just numbers and can be summed by the nim-addition rule to a single number,  $*n$ .

### The Blue Flower Ploy

If there are no red flowers,  
at least one blue one, and  
any amount of greenery,  
then Left has a winning move.



**Figure 12.** Blue Petals Won't Hurt Left.

For such a position (Fig. 12(a)) is better for Left than the one (Fig. 12(b)) obtained from it by removing the blue petals, which has a number value  $*n$ , say. But if  $n \neq 0$ , Left can move to 0 in this (and so to a position  $\geq 0$  in the original) while if  $n = 0$  he moves to a position  $\geq 0$  by taking a blue petal.

Moreover:

If there are no red flowers,  
at least *two* blue ones, and  
any amount of greenery, Left  
wins even if Right begins,

THE TWO-AHEAD RULE





because Right can destroy at most one blue flower. It follows that the difference between any blue and any red flower exceeds any number, and so:

In a sum of flowers and numbers,  
Left will prefer any move which  
cuts a red flower to any move  
which cuts a blue flower.

Of course Right prefers all the moves cutting blue flowers to all the ones cutting red ones. Green edges make good Hotchpotch players more aggressive than Blue-Red Hackenbush players, who win by conserving their own resources. In the presence of green edges you should destroy your opponent's property.

### Atomic Weights

In Blue-Red Hackenbush the basic unit of measurement (+1) is the single blue edge — there is a sense in which Hotchpotch positions can be measured in terms of another sort of unit.

In any sum of flowers and numbers either player might play aggressively and refrain from playing on any number until all flowers of his opponent's color are gone. This shows that

a flower garden with at least two more  
blue flowers than red ones is positive —  
one with at least two more red flowers  
than blue ones is negative.

So to a possible uncertainty of 1 or 2 flowers, the total *numbers* of blue and red flowers are all that concern us; their shapes are relatively unimportant.

We can say that all blue flowers have **atomic weight** +1, all red ones atomic weight -1, and pure green positions make no contribution to the atomic weight.

If atomic weight  $\geq 2$ , then Left wins.  
If atomic weight  $\leq -2$ , then Right wins.

For other atomic weights we have to look at the position more closely.

Although the basic unit of atomic weight is the "blue flower", this is not a precise unit because different blue flowers certainly have different values. In general the longer the stem-length of a blue flower the less advantageous it is for Left, and the number of petals becomes relevant only for flowers of the same stem-length.

But to the first order of importance it doesn't matter! A thousand blue flowers is a 1000-flower advantage to Left and he can win the sum of this position with any position which is a 998-flower advantage to Right, even if the red flowers are bigger and better than the blue ones.

### QUANTITY BEATS QUALITY!

Among Hotchpotch flowers, *quantity*  
is much more important than *quality*,

except in certain cases where the *quantities* differ by at most one. Any positions of atomic weight 0 is infinitesimally small compared to one of atomic weight 2 or more.

### Atomic Weights of Jungles

Recall that in a green jungle there may be red and blue edges, but only green edges touch the ground. For jungles with no red edges we have a slight generalization of the Blue Flower Ploy:

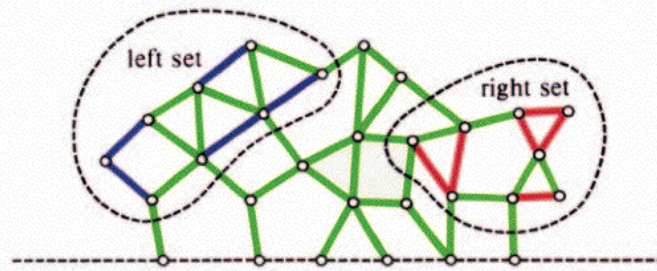
If a jungle has no red edges  
and at least one blue one,  
Left has a winning move.

### THE BLUE JUNGLE PLOY

For if we were to rub out all the blue edges we'd get a pure Green Hackenbush position which we could evaluate as  $*n$ , for some  $n$ , using Green Hackenbush theory. If  $n \neq 0$ , Left has a winning move in this and his corresponding move in the original jungle is at least as good. If  $n = 0$ , Left chops a blue edge.

For more general jungles we'll prove at the end of Chapter 8 that there is a whole number atomic weight, although this can be quite hard to find. However, for *parted* jungles, there is a way, based on "max-flow min-cut" theory.

A **parted jungle** is a green jungle in which red and blue edges never touch each other. This is how to look at a parted jungle (Fig. 13). The left set contains all nodes that belong to blue edges, the right set those belonging to red ones, and there may be other nodes in between where there are only green edges.



**Figure 13.** How to Look at a Parted Jungle.

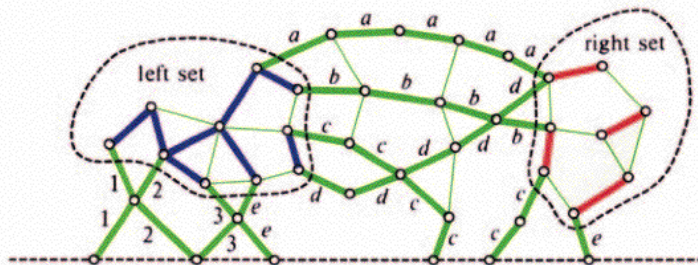
Here's how to work out the atomic weight of a parted jungle.



First find a *maximal flow* from the left set to the right set along the green edges, treating the ground as a single node. Then, if you can, *enlarge* the flow to obtain as many tracks as you can from the left or right set to the ground. If this enlargement has  $n$  tracks from the left set to the ground, the atomic weight is  $+n$ ; if  $m$  tracks from the right set to the ground, the atomic weight is  $-m$ .

### THE FLOW RULE

A **flow** between two sets of nodes consists of a number of green **tracks** (paths) from the first set to the second and is **maximal** if it contains as many such tracks as possible. No two tracks may share an edge, although they may share nodes, as in Fig. 14, showing a case of atomic weight  $+3$ . The maximal flow has five tracks,  $a, b, c, d, e$ ; the enlargement three more tracks 1, 2, 3. Thin green edges are not part of the flow, nor are the red and blue edges.



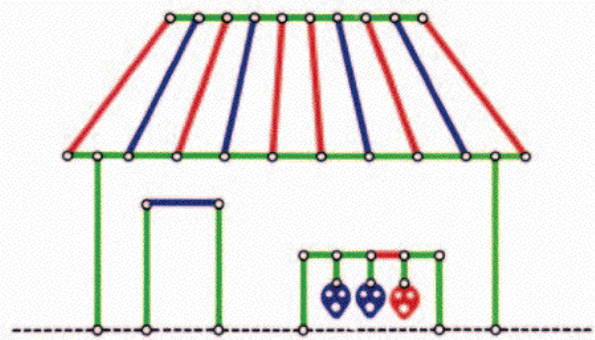
**Figure 14.** A Parted Jungle with Atomic Weight  $+3$ .

Of course, in the parted jungle you're faced with, the left and right sets need not be so conveniently at the left and right of the picture. What is the atomic weight of Fig. 15? The camera we've used doesn't provide enough resolution for you to see the fine structure of those skulls, but it won't affect the answer.

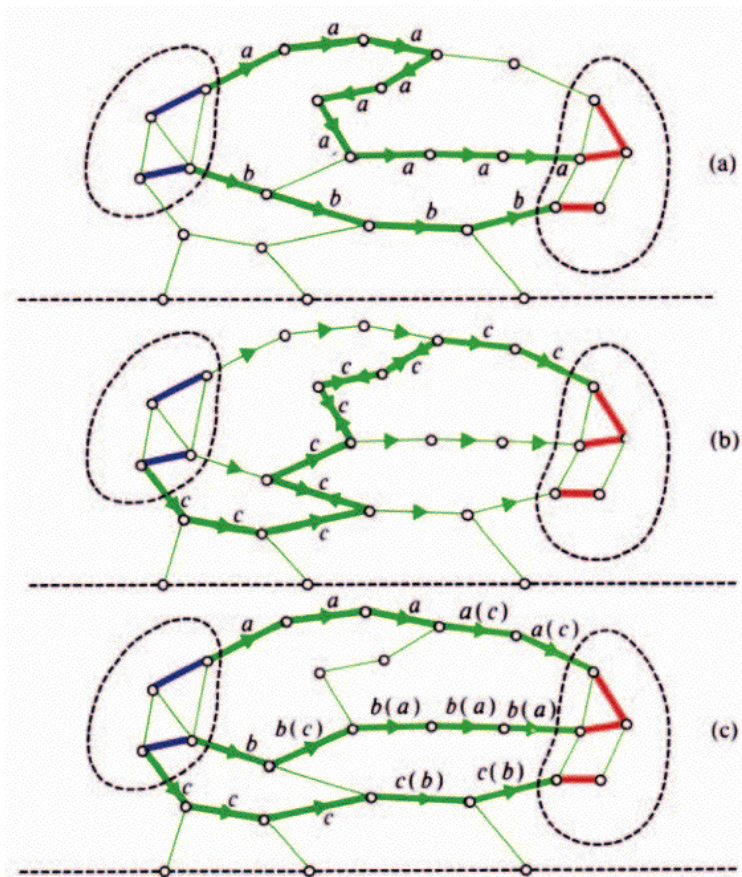
### Making Tracks in the Jungle

To find the desired maximal flow, first find as many green tracks from the left set to the right set as you can, using no green edge twice, and put arrows showing the direction of travel on all the green edges you've used (Fig. 16(a)). Even if you can't add a new track to these, you can't be sure you've found a maximal flow because you might have started badly.

Now start at the left set and try to reach the right set along green edges possibly using ones you've already used, but *only in the wrong direction*, as in Fig. 16(b). If you can do this, then by deleting any edge you have used both ways you can get a larger flow, as in Fig. 16(c).



**Figure 15.** What Do You Find After Traversing the Tracks?



**Figure 16.** Retracing Your Tracks.



If you carry on like this until you can go no further, you've found a maximal flow between the left and right sets.

To be absolutely sure that this has happened, you can *tint* the various nodes. The nodes in the left set are already tinted blue and you tint another node blue only if you can reach it from a previously tinted node by going along a green edge *not* in the flow, or *backwards* along one that *is*. You could alternatively tint nodes red starting from the right set, but this time only allowing yourself to use the flow edges *forwards*. You can increase the size of your flow when (and only when) some node gets tinted both colors. When you *do* have a maximal flow, you've also partitioned the nodes into three separate sets: those tinted blue, those tinted red, and the rest.

The atomic weight of the jungle is  
*positive, negative* or *zero*  
 according as the ground node is  
*tinted blue, tinted red* or *untinted*.

If the ground is tinted you can enlarge the flow by adding more tracks between it and the appropriate set. When trying to find a new track you may, as before, use the edges of the original flow, provided you do so in the wrong direction. The Flow Rule now tells us that the atomic weight is the largest number of tracks by which you can enlarge the flow (with sign + for tracks from the left set to the ground, sign - for tracks from the ground to the right set).

Of course, the enlarged flow defines a whole new set of tints as follows:

**Blue tinted nodes** are those you can reach from the left set by walking along unused, or backwards along used, green edges.

**Red tinted nodes** are those reached from the right set along unused, or forwards along used, green edges.

But now:

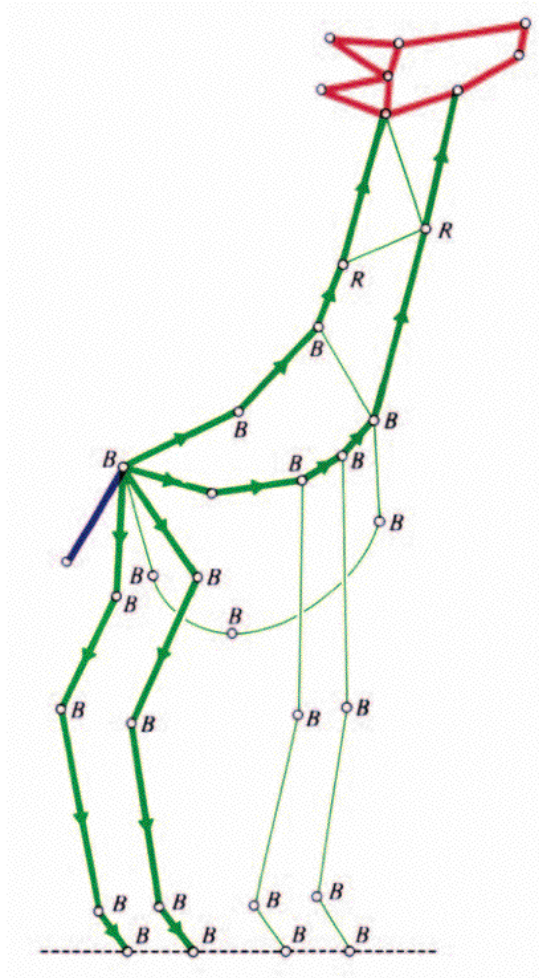
**Green tinted nodes** are those you can reach from the ground without going in *either* direction along an edge carrying a flow *direct from blue to red*, and without going *against* the flow along an edge carrying flow from blue to ground, or *with* it along one carrying flow from ground to red.

*All other nodes* are **untinted**.

If the atomic weight were *negative*, of course you would pretend that the ground is blue when enlarging the flow, and in defining green tinted nodes.

## Tracking Down an Animal

Penetrating one particular jungle we found the fabulous beast of Fig. 17. Now let's work out those maximal flows. The two arrowed tracks are easy to find and are a maximal flow from left set to right set because we could sever the animal's head with just two cuts at the base of



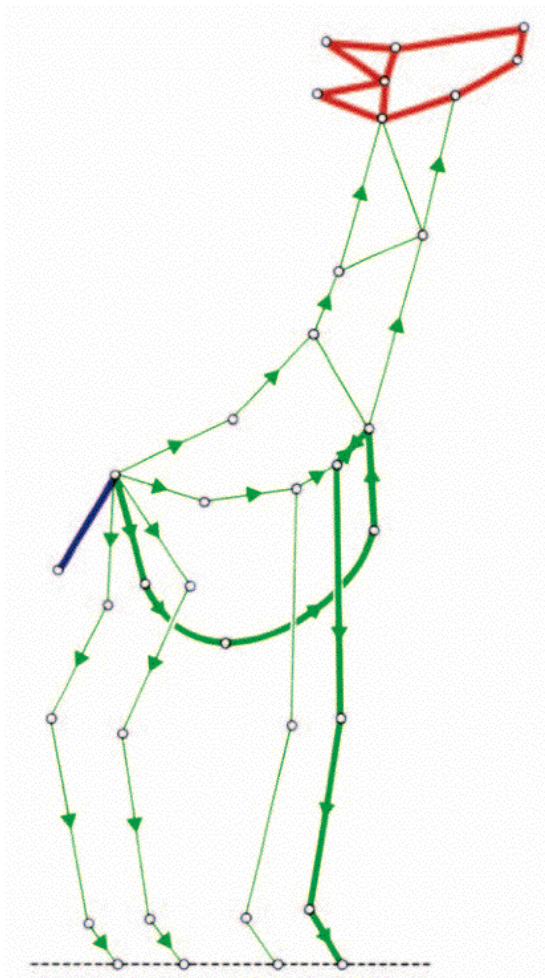
**Figure 17.** The *Red-headed bLue-tailed G-raph* (Before).

his neck. Ford and Fulkerson's Max-Flow Min-Cut Theorem tells us that we can always check maximality this way.

Now to enlarge the flow! The ground is tinted blue at the moment because we can get to it from the tail down either back leg. We must therefore find more tracks from the left set to the ground. The two back legs will obviously be tracks in our enlarged flow. Is this maximal?

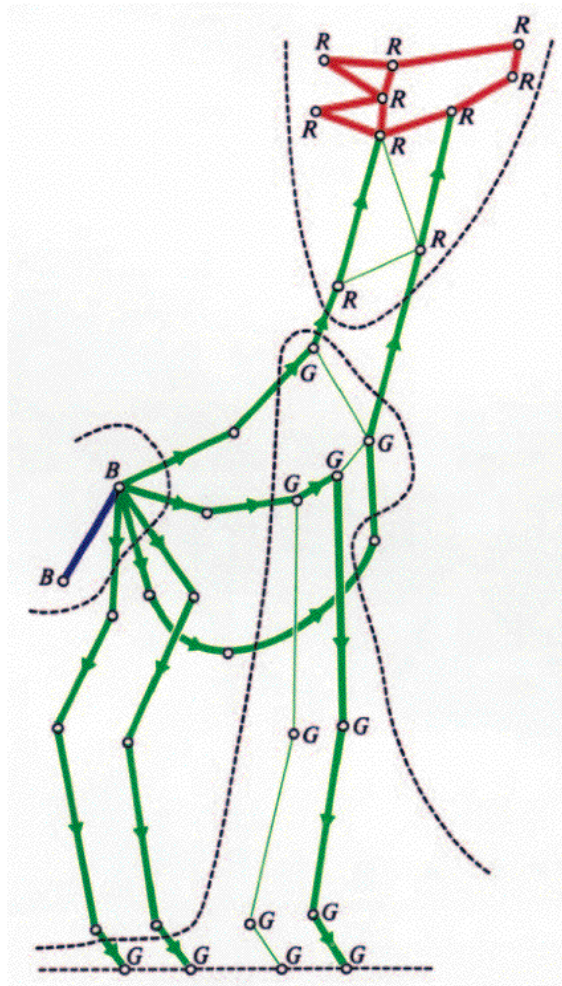
No! By creeping rightwards along the animal's underbelly until you reach the base of the neck, back down one edge of the original flow, and then down his front leg, we find a third track (Fig. 18).





**Figure 18.** A Third Track in the Enlarged Flow.

The resulting triply enlarged flow (Fig. 19) is maximal, because there are only 5 green edges emerging from the monster's tail. The atomic weight is therefore +3, even though there are 10 red edges and only 1 blue one. The tints are shown by labels in Fig. 19, untinted nodes being unlabelled.



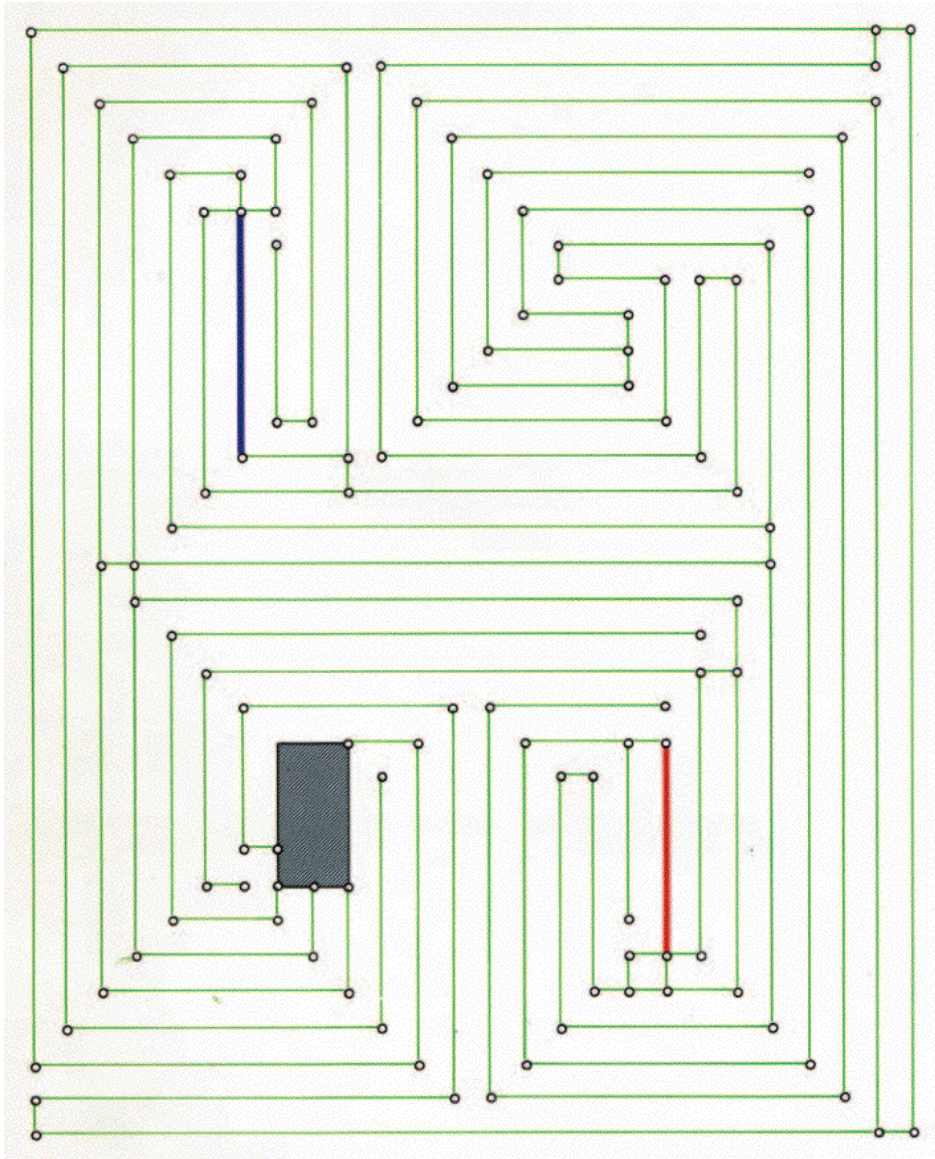
**Figure 19.** The Red-headed bLue-tailed *G*-raph (After).





## Amazing Jungle

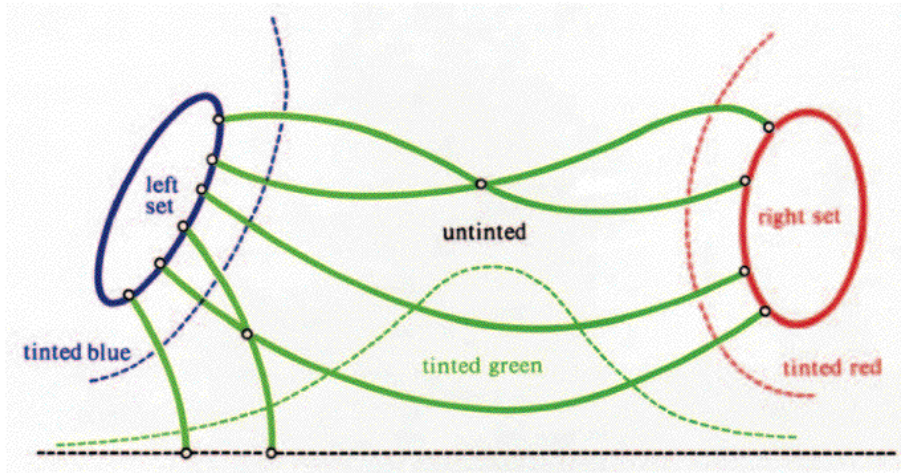
What is the atomic weight of the Amazing Jungle of Fig. 20? The ground is the shaded rectangle. (Answer in the Extras.)



**Figure 20.** Make Tracks Through the Amazing Jungle.

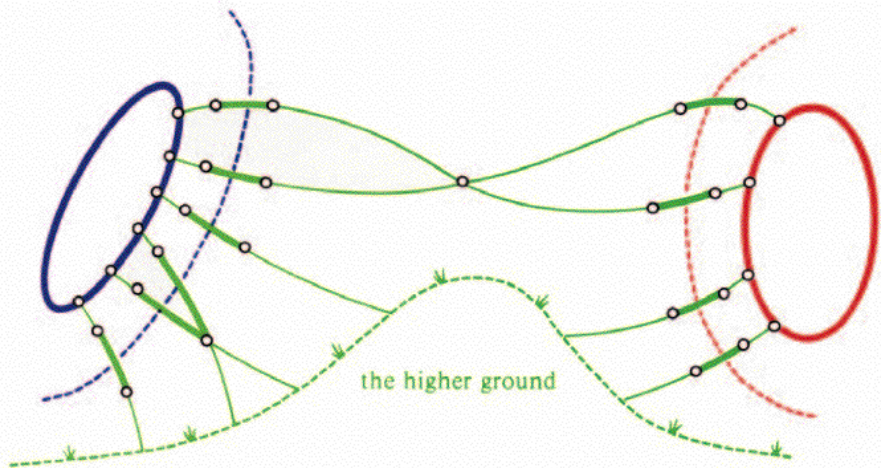
## Smart Game in the Jungle

As experienced trackers we can advise you on good moves in the jungle. They may not always be the very best ones but they'll let you (Left) win when the atomic weight is 2 or more, or if it's 1 and you have the move.



**Figure 21.** Parted Jungle with Enlarged Maximal Flow and Tints.

Your jungle, with the enlarged maximal flow and tints, should look something like Fig. 21, but you should see it as Fig. 22 in your mind's eye.



**Figure 22.** Your Mind's Eye View of Figure 21.

The green tinted nodes are just an extension of the grassy ground and the tracks (of the flow) which join them to blue or red tinted nodes are like the tangled stems of blue or red



imbedded flowers. All the other edges are more or less irrelevant, including those on any of the tracks between the left and right sets which don't have any green tinted nodes.

What move should you make?

For each imbedded flower the stem edge to chop is the one which crosses the boundary of the red or blue tinted region, and in general the players should behave just as they do in a flower garden, aggressively chopping down their opponent's flowers.

More precisely:

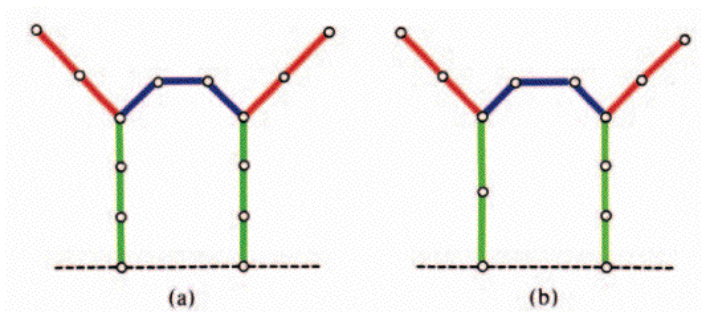
If you've a move leading to a Green Hackenbush position of value 0, make it and play Green Hackenbush thereafter.  
(Can only happen when there's just one flower.)  
Otherwise, chop down a flower of your opponent's color, if there is one, and if not, chop one of the track edges where it crosses the boundary of his region.  
If this is impossible, then there's no edge of your opponent's color and you can use the Blue Jungle Ploy (or the Red Jungle Ploy if you're Right).

### JUNGLE WARFARE TACTICS

But beware!! As you play the game the status of the various nodes will change, and you may have to blaze some new trails through the jungle.

The Jungle Warfare Tactics can be used to prove the Flow Rule. To see how they work, you must play a few games for yourself.

### Unparted Jungles



**Figure 23.** Deceptively Similar-Looking Unparted Jungles.

When red and blue edges touch inside a green jungle, the theory gets very complicated and we don't know the answers. The unparted jungles of Figs. 23(a) and 23(b) look very similar but (a) has atomic weight 0, while (b) has atomic weight +2. The more general theory of atomic weight in Chapter 8 can be used to show that *every* jungle has an integer atomic weight, but there are great difficulties in extending the max-flow min-cut theory:

HACKENBUSH IS HARD!

## Blue-Red Hackenbush Can Be Hard, Too!

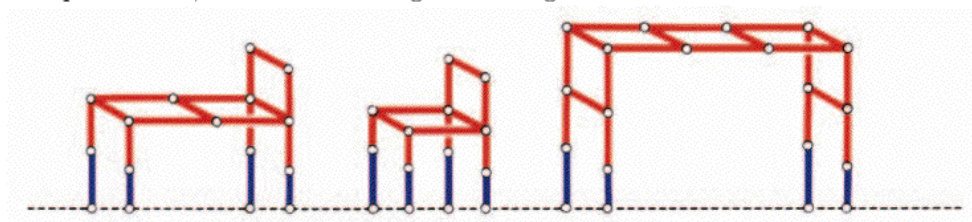
The hardness of Hackenbush Hotchpotch arises partly from the poorly understood infinitesimal values that turn up there. The hardness of Blue-Red Hackenbush is rather different. Although the values are all ordinary numbers, it may be hard to work out exactly which ordinary number is the answer. If you're only interested in finding the values of individual pictures, don't bother with the rest of this chapter.

## Redwood Furniture

A piece of **redwood furniture** is a Blue-Red Hackenbush picture in which

no red edge touches the ground,  
each blue edge (**foot**) has one end on the ground and  
the other touching a unique red edge (called a **leg**),

for example the bed, chair and climbing bars of Fig. 24.



**Figure 24.** Some Pieces of Redwood Furniture.

Now:

Any connected piece of redwood  
furniture has value  
 $\frac{1}{2^n}$   
for some  $n = 0, 1, 2, \dots$

THE REDWOOD FURNITURE THEOREM



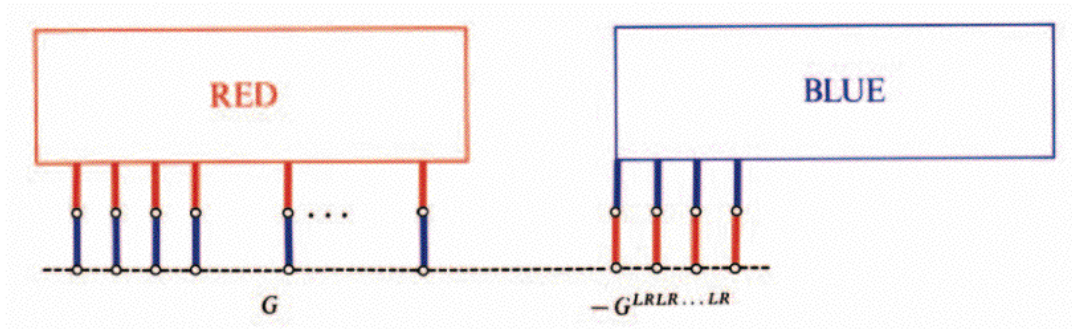


This is proved by a reversibility argument in which Right responds to any Left move (which is necessarily to chop a foot) by chopping the corresponding leg. Let

$$G^{LRLR\dots LR}$$

be the position obtained from  $G$  after several such pairs of moves. We assert that

$$G^{LRLR\dots LR} \leq G.$$



**Figure 25.** How Furniture Reduces in Value.

This is because Left has an obvious strategy when Right starts in Fig. 25, pairing all edges of  $-G^{LRLR\dots LR}$  with the corresponding edges in  $G$  and the remaining feet and legs in  $G$  with each other.

Since, in particular, every

$$G^{LR} \leq G,$$

every left option of  $G$  is reversible, showing that  $G$  simplifies to a form

$$\{G^{LRL} \mid G^R\}.$$

But then since every

$$G^{LRLR} \leq G,$$

every Left option in *this* is reversible, and so on, as long as the furniture has any legs to stand on. Eventually we conclude that

$$G = \{0 \mid G^R\}$$

and so its value is the first of

$$1, \frac{1}{2}, \frac{1}{4}, \frac{1}{8}, \dots$$

that is less than every  $G^R$ .

In the remainder of this section it will be handy to count the picture consisting of a single blue edge as a degenerate piece of redwood furniture. Since the value of this is 1, the Redwood Furniture Theorem still holds.

Now:

If there is any move for Right  
which leaves a piece of  
redwood furniture connected,  
then one of these moves is  
a worthwhile move for Right.

### THE DON'T-BREAK-IT-UP THEOREM

We'd better explain exactly what this means. Since

$$\frac{1}{2^n} = \left\{ 0 \left| \frac{1}{2^{n-1}} \right. \right\},$$

any move to a value  $\leq 1/2^{n-1}$  is a move that's **worthwhile** for Right (even if he has other moves to strictly smaller values).

If there were any counter-example to the Don't-Break-It-Up Theorem, there'd be one,  $G$  say, with the smallest number of edges. Since  $G$  contains a Right move leaving it connected, it must contain a red cycle or a red twig (an edge with one end free). Now let  $G^R$  be a worthwhile option for Right, corresponding to an edge  $x$  whose removal breaks  $G$  into non-empty portions  $G_1, G_2$ . Since  $G_1$  has fewer edges than  $G$ , the Don't-Break-It-Up Theorem is known to apply to it, and it has a worthwhile option, removing an edge  $x'$ , that doesn't break it up. Let  $G^{R'}$  be the Right option of  $G$  obtained by removing  $x'$ . So  $G$  looks like Fig. 26, where  $G_3$  is what remains of  $G_1$  when  $x'$  is removed. Let

$$G_2 = \frac{1}{2^p}, \quad G_3 = \frac{1}{2^q},$$

so that

$$G_1 = \left\{ 0 \left| \frac{1}{2^q} \right. \right\} = \frac{1}{2^{q+1}},$$

$$G = \{ 0 | G^R \} = \left\{ 0 \left| \frac{1}{2^p} + \frac{1}{2^{q+1}} \right. \right\}$$

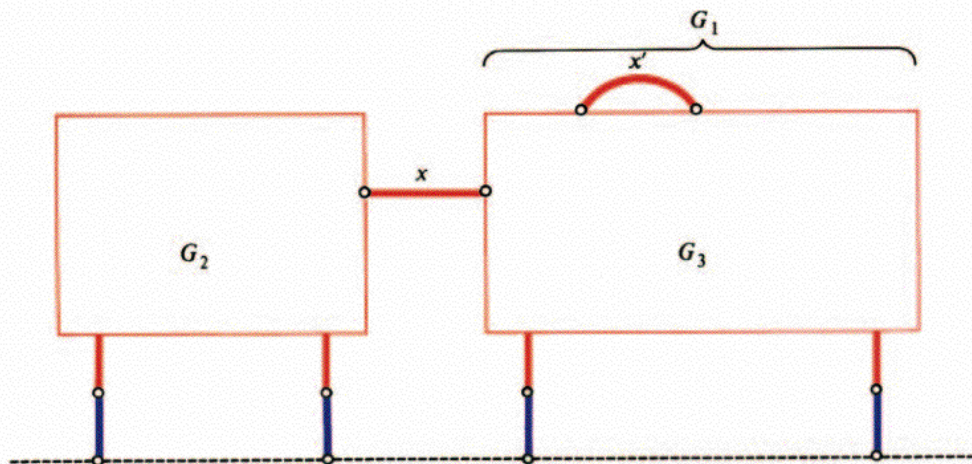
and

$$G^{R'} \leq \left\{ 0 \left| \frac{1}{2^p} + \frac{1}{2^q} \right. \right\}$$

because removing  $x$  from  $G^{R'}$  leaves  $\frac{1}{2^p} + \frac{1}{2^q}$ . But now

$$\frac{1}{2}G^{R'} \leq \left\{ 0 \left| \frac{1}{2^{p+1}} + \frac{1}{2^{q+1}} \right. \right\} \leq G,$$

showing that  $G^{R'}$  is an all-in-one-piece worthwhile option of  $G$ .



**Figure 26.** A Minimal Criminal for the Don't-Break-It-Up Theorem.

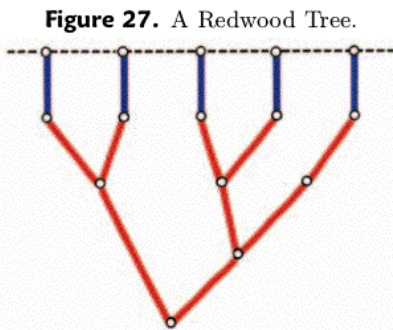
Now let  $A$  be a piece of redwood furniture, with a worthwhile move for Right that leaves it all in one piece,  $B$ . Then

$$A = \{0 \mid B\} = \frac{1}{2}B$$

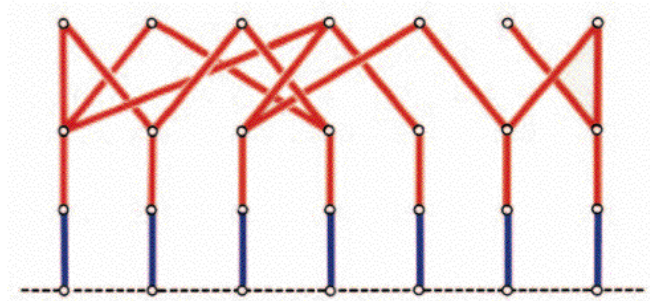
since the value of  $B$  has the form  $1/2^n$  by the Redwood Furniture Theorem. Similarly, if  $B$  has a worthwhile move to  $C$ , still in one piece, then  $B = \frac{1}{2}C$ , and so on. By making  $m$  such worthwhile moves we eventually conclude that

$$A = \frac{1}{2^m}T,$$

where  $T$  is a piece of redwood furniture which is disconnected by the removal of any red edge. You should look at this upside-down (Fig. 27) because the red edges, having no cycle, now form a tree, and the blue ones touch the sky!



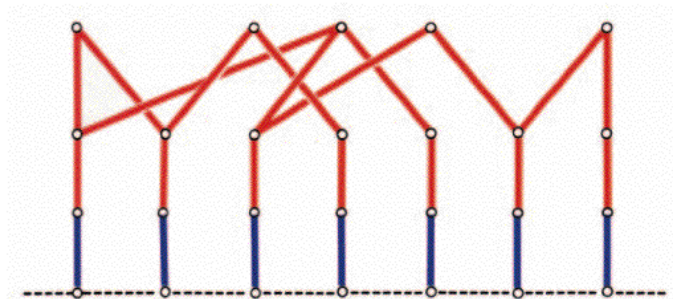
## Redwood Beds



**Figure 28.** A Redwood Bed.

A **redwood bed** is a piece of redwood furniture in which the **mattress** edges (all red edges other than the legs) each have just one end at the top of a leg (Fig. 28). Its value will be of form

$$\frac{1}{2^n} T$$



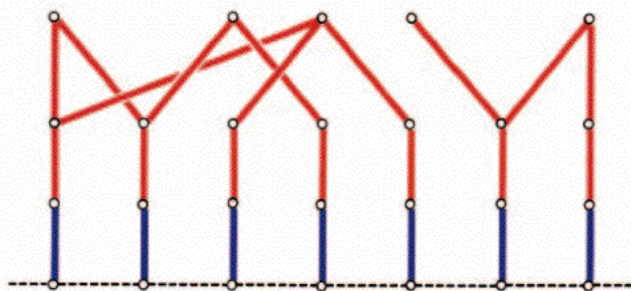
**Figure 29.** Redwood Tree  $T$  Used in Making the Bed.

where  $T$  is a redwood tree obtained by making a succession of worthwhile moves for Right until any further such move would disconnect the picture (Fig. 29). We assert that

$$T \text{ has value } \frac{1}{2}.$$

If not, let  $T$  be the smallest counter-example and let Right make any worthwhile move from  $T$ . The result is a pair of redwood trees. Either these are both smaller trees of the same type (and therefore have value  $1/2$ ) or just one of them has an extra twig (on the left of the right-hand tree in Fig. 30).





**Figure 30.** Two Redwood Trees of Differing Type.

But in the former case

$$T = \left\{ 0 \mid \frac{1}{2} + \frac{1}{2} \right\} = \frac{1}{2}$$

and in the latter

$$T = \left\{ 0 \mid \frac{1}{2} + \frac{1}{4} \right\} = \frac{1}{2}$$

since the twig must be a worthwhile move (and so halve the value) by the Don't-Break-It-Up Theorem.

### How Big Is A Redwood Bed?

Make worthwhile moves from the bed  $B$  for as long as you can without disconnecting it. Since the tree  $T$  you obtain has value  $1/2$ , we find

$$B = \frac{1}{2^m} \times \frac{1}{2} = \frac{1}{2^{m+1}},$$

where  $m$  is the number of moves you have made. How big is  $m$ ?

We assert that  $m$  is the *largest* number of red edges,  $m'$ , whose removal keeps the bed in one piece,  $T'$ . For, take away these edges one at a time, obtaining a sequence of pictures

$$B, C, \dots, T'.$$

Then  
and so

$$B \leq \{0 \mid C\} = \frac{1}{2}C, \quad C \leq \{0 \mid D\} = \frac{1}{2}D, \quad \dots$$

$$B \leq \frac{1}{2^{m'}} T' = \frac{1}{2^{m'+1}}$$

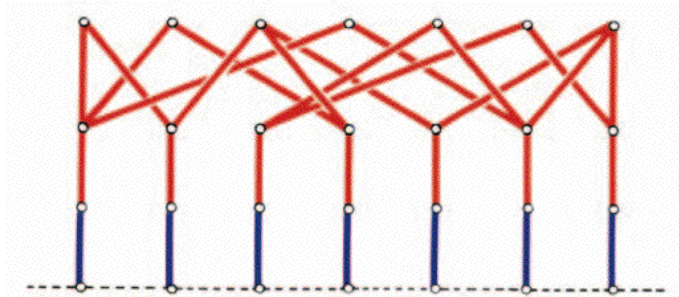
so that  $m \geq m'$ .

To work out the size of a redwood bed  $B$  you must know what is the smallest redwood tree in  $B$  which contains all its legs.

But it follows from the work of Karp (and see also Garey & Johnson) that this problem is “NP-complete”. Now among those who know them best, such problems are universally regarded as hard. So

EVEN BLUE-RED  
HACKENBUSH  
CAN BE HARD!

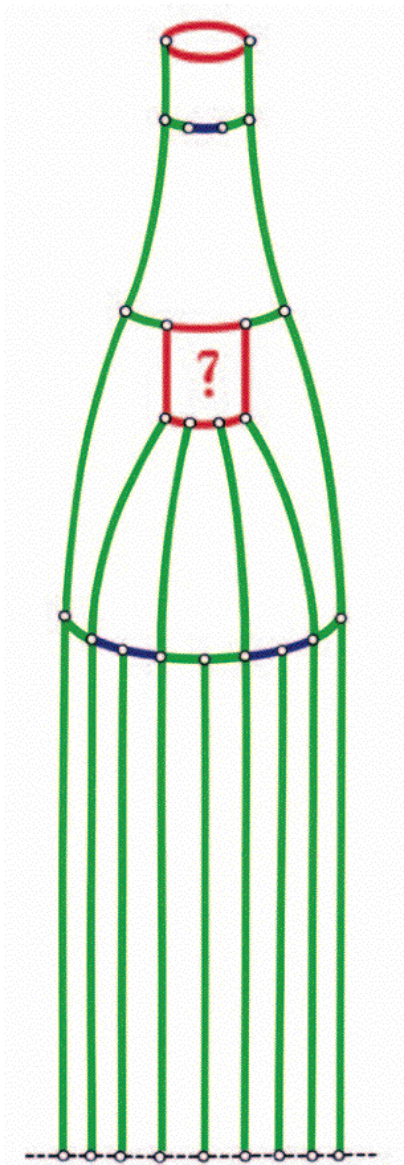
Would you like to find the value of Fig. 31?



**Figure 31.** A Moderately Hard Bed.



# What's The Bottle



**Figure 32.** What's the Bottle?

# Extras

## Ordinal Addition, The Colon Principle, and Norton's Lemma

The compound Hackenbush game  $G_x : H$  at the beginning of the chapter is a generalization of the **ordinal sum**,  $G : H$ , which can be defined for any two games,

$$G : H = \{G^L, G : H^L \mid G^R, G : H^R\}.$$

In this kind of sum, any move in  $G$  annihilates  $H$ , while moves in  $H$  leave  $G$  unaffected. (The general Hackenbush compound is similar but there may be moves in  $G$  which do not annihilate  $H$ .)

The Colon Principle,

$$H \geq K \text{ implies } G : H \geq G : K,$$

applies in general, and shows in particular that

$$H = K \text{ implies } G : H = G : K,$$

so that  $G : H$  depends only on the *value* of  $H$ , not on its form. Unfortunately it *may* depend on the *form* of  $G$ , because there are games  $G_1 = G_2$  for which  $G_1 : H \neq G_2 : H$ . This defect is compensated by Norton's Lemma (Chapter 8) which implies that  $G : H$  is usually almost indistinguishable in value from  $G$ . The lemma asserts, more precisely, that if

$$G < K, \quad G \parallel K, \quad G > K$$

then

$$G : H < K, \quad G : H \parallel K, \quad G : H > K,$$

*unless* some position of  $K$  has the same value as  $G$ .

Most of these properties continue to hold for variations such as the general Hackenbush compound  $G_x : H$ .

## Both Ways of Adding Impartial Games

We know that nim-values are exactly what you need to work out outcomes of ordinary sums of impartial games. What else is required if you might be taking ordinal sums as well? The answer is: just the nim-values of the options.

If a game has nim-value  $m$  and options with nim-values  $a, b, c, \dots$ , the possible changes in nim-value are

$$\alpha = m \dagger a, \quad \beta = m \dagger b, \quad \gamma = m \dagger c, \dots$$



and so we'll write

$$\{a, b, c, \dots\} = m_{\{\alpha, \beta, \gamma, \dots\}}$$

for such a game and call  $\{\alpha, \beta, \gamma, \dots\}$  the **variation set**. The Sprague-Grundy theory tells us how to “add” this information in the ordinary sense:

$$m_{\{\alpha, \beta, \gamma, \dots\}} + n_{\{\delta, \epsilon, \zeta, \dots\}} = (m \ddagger n)_{\{\alpha, \beta, \gamma, \dots + \delta, \epsilon, \zeta, \dots\}}$$

(nim-add the values and unite the variations). Thus, since  $\{0, 1, 6\} = 2_{\{2,3,4\}}$  and  $\{0, 3, 4\} = 1_{\{1,2,5\}}$  we have

$$\{0, 1, 6\} + \{0, 3, 4\} = 3_{\{1,2,3,4,5\}} = \{2, 1, 0, 7, 6\}.$$

To add them in the *ordinal* sense we can use the rule

$$\{a, b, c, \dots\} : \{d, e, f, \dots\} = \{a, b, c, \dots, m_d, m_e, m_f, \dots\}$$

where  $m_0, m_1, m_2, \dots$  are *all* the numbers *not* appearing in  $\{a, b, c, \dots\}$ . For  $\{0, 1, 6\}$  the missing numbers are  $m_0 = 2, m_1 = 3, m_2 = 4, m_3 = 5, m_4 = 7, m_5 = 8, \dots$  and so

$$\{0, 1, 6\} : \{0, 3, 4\} = \{0, 1, 6, 2, 5, 7\}.$$

### Many-Way Maundy Cake

You can play Maundy Cake in as many dimensions as you like, with reservations of certain of the dimensions for certain players. Then the value of an

$a \times b \times c \times \dots$	$\times r \times s \times t \times \dots$	$\times l \times m \times n \times \dots$	cake,
in which the dimensions			
$a, b, c, \dots$	$r, s, t, \dots$	$l, m, n, \dots$	
may be cut by			
either player,	Right only,	Left only,	
is			

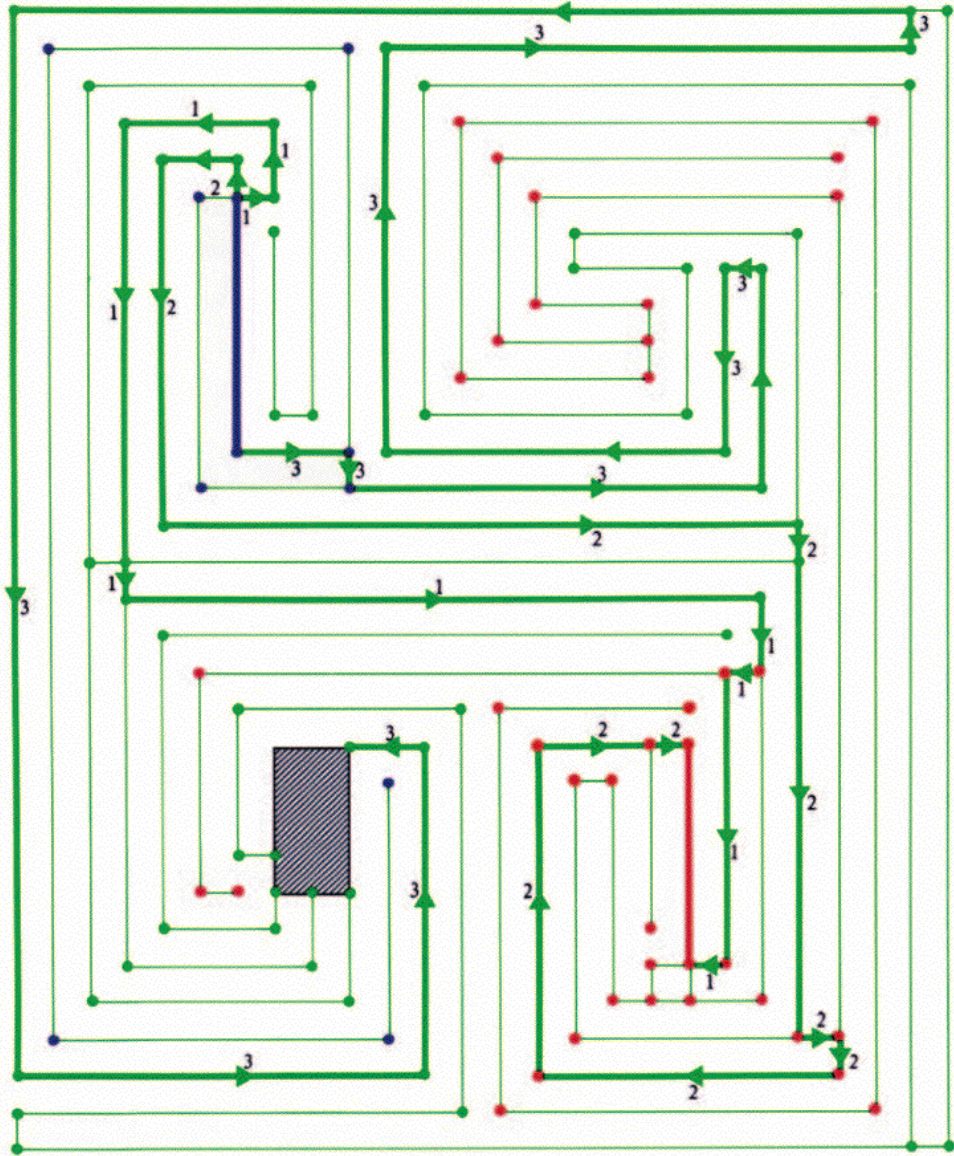
$$abc \dots M(rst \dots, lmn \dots) + *(\mu \text{ or } \mu + 1)$$

where  $M(x, y)$  is the function of Chapter 2 (Extras), and

$$\mu = \alpha \ddagger \beta \ddagger \gamma \ddagger \dots$$

where  $\alpha, \beta, \gamma, \dots$  are the numbers of odd prime divisors (counting repetitions) of  $a, b, c, \dots$  respectively. The 1 is added just if  $abc \dots$  is even.

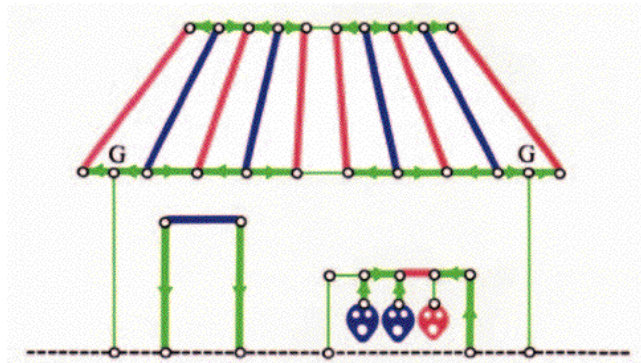
The proof involves the sliding of an abstract green jungle down an abstract purple mountain, the mountain being multiplied by a factor at each stage of the slide!



**Figure 33.** Tracks Cleared Through the Amazing Jungle.

### Solution to Figure 15

The atomic weight of the door is 2. The maximum Blue to Red flow occupies all but the centremost horizontal edges of the roof ridge and the eaves. The nodes where the walls meet the eaves are tinted Green and the atomic weight of the roof and walls is 0. The maximum Blue-Red flow occupies both Green hairs by which the shrunken Blue heads are hanging.



**Figure 34.** How to Keep Track Without Losing Your Head.

The left post carries no flow to the ground, but the right one carries a flow from Ground to Red, so the atomic weight of the three shrunk heads and the bar and posts which hold them is  $-1$ . Therefore the atomic weight of the whole picture is  $2 + 0 + (-1) = +1$ .

### Tracks Cleared Through the Amazing Jungle

Kimberly King, who's an experienced tracker, found two tracks (1 and 2 in Fig. 33) from Blue to Red direct, and a third one (3) from Blue to ground, and you won't be able to find any more. Therefore Blue is one up, but if he's to bag his game he'd still better go first.

### How Hard Was The Bed?

We have to find the smallest redwood tree in Fig. 31 which includes all the legs. Figure 35 is the adjacency matrix for the graph formed by the two top rows of nodes and the edges which connect the legs. It is not enough to include just three of the top nodes, since only two of them (columns 3 and 7) are on three edges, and  $3+3+2=8$  edges are not enough to connect the seven legs, which would need  $7+(3-1) = 9$ . If we use four top nodes, then  $7+(4-1) = 3+3+2+2$  and we can manage with columns 3 and 7, just one of columns 5 and 6 (in order to connect the third leg, row 3) and just one other (column 1, 2 or 4). So, of the 16 connecting edges, only 10 are really required, and 6 can be removed, and the value of the bed is

$$\frac{1}{2^{6+1}} = \frac{1}{128}$$



	1	2	3	4	5	6	7
1	1	1	0	1	0	0	0
2	1	0	1	0	0	0	0
3	0	0	0	0	1	1	0
4	0	1	1	0	0	0	0
5	0	0	1	0	0	0	1
6	0	0	0	1	1	0	1
7	0	0	0	0	0	1	1

**Figure 35.** Coverlet for the Moderately Hard Bed.

## NP-Hardness

Throughout this book we try to help you to acquire winning ways. We consistently focus our attention on those games which have enough structure for us to help you acquire tools and technique so that you can beat your friends consistently until they've read the book too. When both sides have read it, fair competition is again possible, but with a much higher standard of play.

Many combinatorial theorists have made a quite different approach. Instead of studying particular games for which clever strategies can be demonstrated, they try to prove that certain classes of games are **hard** in the sense that any algorithm for playing all of them correctly must necessarily take a very large amount of computation. In some sense this approach is complementary to ours. Every positive result, consisting of a constructive strategy of the sort we seek, opens up a question of generalization: can the same techniques be used to solve some larger class of games efficiently? Every negative result, consisting of a proof that any algorithm which solves all the games in some large class must be complex in some sense or other, opens up a question of specialization: what subclasses of the large class of “hard” games are really hard, and which are “easy”? Typically the “hard” class of games contains infinitely many hard games, but it's often true that all the games of such a class which satisfy some additional conditions are “easy”. Sometimes there is even a known algorithm which solves most of the games in the “hard” class very quickly and efficiently, but it requires an inordinately long time to solve a relatively small subset of these games; this small subset makes the class “hard”.

Complexity theorists have established a hierarchy of classes of problem which are computationally “hard”. One of the strongest definitions is EXPTIME, those which are “complete in exponential time”. This means that any algorithm which can solve all the problems in the class has the property that its running time, measured as a function of the length of the input needed to define the problem, is greater than an exponential function of this input infinitely often. Stockmeyer & Chandra have introduced a game called PEEK and several games on Boolean formulas which they were able to prove were EXPTIME complete. The EXPTIME completeness result was extended to chess by Fraenkel & Lichtenstein, and to Go





and then to Checkers by Robson. All of these results involve the construction of a single complicated position.

Several other classes of games *appear* to be just as hard, but no one has yet been able to prove whether they really require exponential time (infinitely often) or not! The two most important such classes are problems which are “complete in PSPACE” and problems which are “NP-complete”. For precise definitions see the beautiful book by Garey & Johnson. Even & Tarjan have shown that Generalized Hex is PSPACE-complete and Schaeffer has done the same for Generalized Geography, Generalized Kayles, Col and Snort. Fraenkel and others found that  $N \times N$  Checkers is PSPACE-hard and PSPACE-complete for certain drawing rules; Lichtenstein & Sipser that  $N \times N$  Go is PSPACE-hard; and the analogous result for Chess was obtained by Jim Storer at Bell Labs. Yedwab showed that some sums are PSPACE-hard and Moews found this to be so even if every summand is a very simple 3-stop game. Their results were applied to Go endgames by Wolfe, based on the techniques introduced in the book of Berlekamp & Wolfe. Problems known to be at least as hard as NP-complete problems are said to be NP-hard. Fraenkel & Yesha have shown that their annihilation games are NP-hard and more recently the Demaines & Eppstein that not only is Phutball (Chapter 22) NP-hard, but it may be hard even to determine whether you have a winning jump.

Problems which are complete in exponential time are PSPACE-hard, and PSPACE-hard problems are NP-hard, but it's not known if the converses to either of these statements are true. It *is* known, though, that a good algorithm for solving any NP-hard problem would solve *all* problems which are NP-complete. For example, we've seen in this chapter that any good algorithm for evaluating arbitrary Blue-Red Hackenbush positions could be modified to give a good algorithm for finding the minimum spanning tree of a bipartite graph. Moreover if some miraculous hypothetical algorithm to evaluate Blue-Red Hackenbush positions had a running time which was bounded by a polynomial function of the length of its input, the same would be true of the derived algorithm for finding a minimal spanning tree. Since this latter problem is NP-complete, the problem of evaluating Blue-Red Hackenbush positions is NP-hard.

By following ideas pioneered by Cook and Karp, Garey & Johnson have uncovered a very wide range of combinatorial problems which are NP-complete. An asymptotically good algorithm for solving any of these problems could be modified to yield a good algorithm for solving any of the others. Many famous mathematicians and computer scientists have tried very hard to solve some of these problems, and without success. Thus:

If you can prove that a game is  
NP-hard, you can be confident  
that, as of 1999, no one knows  
an asymptotically good algorithm  
for solving it.

Our thermography-based strategy in Chapter 6 requires only a small amount of computation to find near-optimal moves in the sum of any number of short hot games. THERMOSTRAT yields millions of optimal moves, only a few sub-optimal ones. But if you always

insist on finding the very best move, you will have to do a lot of computing, because Lockwood Morris has found a way to construct some rather short hot games whose sum is NP-hard.

In Chapter 16, we'll prove, in a formal sense, that Dots-and-Boxes is NP-hard. However, notice that this asymptotic result says little about the difficulties of calculating good strategies for playing games on boards of sizes small enough to be interesting. In fact most of Chapter 16 is devoted to exhibiting such strategies. Indeed, we consider the class of Dots-and-Boxes positions which we prove to be NP-hard to be a rather degenerate, relatively dull subclass of end-game positions. Some people consider a class of problems "finished" when it has been shown to be NP-hard. Philosophically this is a viewpoint we strongly oppose.

Some games which are NP-hard  
are very interesting!

It may be possible to find strategies for playing such games which will enable you consistently to beat opponents who haven't read this book; Dots-and-Boxes is an excellent example.

## The Bottle at the End of Chapter 7

The bottle at the end of Chapter 7 is  $7.\uparrow$ , together perhaps with some additives of no atomic weight.

## References and Further Reading

Elwyn Berlekamp & David Wolfe, *Mathematical Go: Chilling Gets the Last Point*, akpeters, 1994; also published as *Mathematical Go Endgames; Nightmares for the Professional Go Player*, Ishi Press International.

H. L. Bodlaender, Complexity of path forming games, *Theoret. Comput. Sci.*, **110**(1993) 215–245.

J. H. Conway, *On Numbers and Games*. A. K. Peters, 2000, pp. 86–91 (Blue-Red Hackenbush), 165–172 (Green Hackenbush), 188–189 (Hackenbush Hotchpotch).

Stephen A. Cook, The complexity of theorem-proving procedures, *Proc. 3rd A.C.M. Sympos. Theory of Comput.*, 1971, 151–158; *Zbl.* **253**.68020.

J. Culberson, Sokoban is PSPACE complete, in *Fun with Algorithms*, Vol. 4 *Proc. Informatics*, Carleton Scientific, Univ. of Waterloo, Waterloo, Ont., 1999, pp. 65–76.

J. E. Damß & D. Markert, Strategien für ein kombinatorisches Spiel, *Praxis Math.*, **20**(1978) 75–83.

E. Demaine, M. Demaine & D. Eppstein, Phutball is NP-hard, in R. J. Nowakowski, *More Games of No Chance*, Cambridge University Press, 2001.

S. Even & R. E. Tarjan, A combinatorial problem which is complete in polynomial space, *J. Assoc. Comput. Mach.*, **23**(1976) 710–719; *Zbl.* **355**.68041.

L. R. Ford & D. R. Fulkerson, *Flows in Networks*, Princeton Univ. Press, 1962.

A. S. Fraenkel, Recent results and questions in combinatorial game complexities, *Theoret. Comput. Sci.*, **249**(2000) 265–288.

A. S. Fraenkel, Scenic trails ascending from sea-level Nim to alpine chess, in Richard Nowakowski (ed.) *Games of No Chance*, Proc. MSRI Workshop on Combinatorial Games, July 1994, Berkeley CA, MSRI Publ. **29**, Cambridge University Press, pp. 365–405.



A. S. Fraenkel, Complexity of games, in R. K. Guy (ed.) *Combinatorial Games, Proc. Symp. Appl. Math.*, **43**, Amer. Math. Soc., 1991, pp. 111–153.

A. S. Fraenkel & E. Goldschmidt, Pspace-hardness of some combinatorial games, *J. Combin. Theory Ser. A*, **46**(1987) 21–38.

A. S. Fraenkel, M. R. Garey, D. S. Johnson, T. Schaefer & Y. Yesha, The complexity of checkers on an  $n \times n$  board — Prelim. report. *Proc. 19th Ann. Sympos. Foundations Comput. Sci.*, IEEE Comput. Soc., Long Beach, 1978, 55–64.

A. S. Fraenkel & D. Lichtenstein, Computing a perfect strategy for  $n \times n$  chess requires time exponential in  $n$ , *J. Combin. Theory Ser. A* **31**(1981) 199–214.

A. S. Fraenkel & Y. Yesha, Complexity of problems in games graphs and algebraic equations, *Discrete Appl. Math.*, **1**(1979) 15–30.

M. R. Garey & D. S. Johnson, Approximation algorithms for combinatorial problems: an annotated bibliography, in J. F. Traub (ed.) *Algorithms and Complexity; New Directions and Recent Results*, Academic Press, 1976, pp. 41–52.

Michael R. Garey & David S. Johnson, *Computers and Intractability; a Guide to the Theory of NP-completeness*, W. H. Freeman, 1979.

M. R. Garey, D. S. Johnson & L. Stockmeyer, Some simplified NP-complete problems, *Proc. 6th A.C.M. Sympos. Theory of Comput.*, 1974, 47–63.

M. R. Garey, D. S. Johnson & L. Stockmeyer, Some simplified NP-complete graph problems, *Theoret. Comput. Sci.*, **1**(1976) 237–267; *Zbl.* **338**.05120.

M. R. Garey, D. S. Johnson & R. Endre Tarjan, The planar Hamiltonian circuit problem is NP-complete, *SIAM J. Comput.*, **5**(1976) 704–714; *Zbl.* **346**.05110.

I. J. Good, And Good saw that it was god(d), *Parascience Proc.*, **1** #2 (Feb. 1975) 3–13.

Richard M. Karp, Reducibility among combinatorial problems, in R. E. Miller & J. W. Thatcher (eds.) *Complexity of Computer Calculations*, Plenum, New York, 1972, pp. 85–103.

Richard M. Karp, The fast approximate solution of hard combinatorial problems, *Proc. 6th SE Conf. Combinatorics, Graph Theory, Computing*. Boca Raton, 1975, 15–31; *Zbl.* **369**.05049.

Richard M. Karp, On the computational complexity of combinatorial problems, *Networks*, **5**(1975) 45–68; *Zbl.* **324**.05003.

David Lichtenstein & Michael Sipser. Go is PSPACE-hard, *Proc. 19th Ann. Sympos. Foundations Comput. Sci.*, IEEE Comput. Soc., Long Beach 1978, 48–54; *MR* **80e**:68115.

David Moews, On Some Combinatorial Games Connected with Go, PhD thesis, Univ. of California at Berkeley, 1993.

W. J. Paul & R. E. Tarjan, Time-space trade-offs in a pebble game, *Acta Informatica*, **10**(1978) 111–115.

Wolfgang J. Paul, Robert Endre Tarjan & James R. Celoni, Space bounds for a game on graphs, *Math. Systems Theory*, **10**(1977) 239–251; *Zbl.* **366**.90151. Corrections, *ibid.* **11**(1977) 85.

Stefan Reisch, Gobang ist PSPACE-vollständig, *Acta Informatica*, **13**(1980) 59–66.

Stefan Reisch, Hex ist PSPACE-vollständig, *Acta Informatica*, **15**(1981) 167–191.

Edward Robertson & Ian Munro, NP-completeness, puzzles and games, *Utilitas Math.*, **13**(1978) 99–116.

J. M. Robson, The complexity of Go, *Proc. Information Processing* **83**(1983) (R. E. A. Mason, ed.), Elsevier, Amsterdam, pp. 413–417.

J. M. Robson, Combinatorial games with exponential space complete decision problems, *Proc. 11th Symp. Math. Foundations of Computer Science* (M. P. Chytil & V. Koubek, eds.), **176**(1984) Springer, Berlin, pp. 498–506.

J. M. Robson,  $N$  by  $N$  checkers is Exptime complete, *SIAM J. Comput.* **13**(1984) 252–267.

- Thomas J. Schaefer, On the complexity of some two-person perfect information games, *J. Comput. Systems Sci.*, **16**(1978) 185–225.
- Larry J. Stockmeyer & Ashok K. Chandra, Provably difficult combinatorial games, *SIAM J. Comput.*, **8**(1979) 151–174; *MR* **80d**:68055 *Zbl.* **421**.68044.
- Larry J. Stockmeyer & Ashok K. Chandra, Intrinsically difficult problems, *Sci. Amer.*, **240** #5 (May 1979) 140–159.
- R. Uehara & S. Iwata, Generalized Hi-Q is NP-complete, *Trans. IEICE*, **E73**(1990) 270–273.
- David Wolfe, Go endgames are PSPACE-hard, in Richard J. Nowakowski (ed.) *More Games of No Chance*, Cambridge University Press, 2001.
- Laura Yedwab, On playing well in a sum of games, Master's thesis MIT, August 1985; MIT/LCS/TR-348.



# It's a Small Small Small Small World

The jury all wrote down on their slates, 'She doesn't  
believe there's an atom of meaning in it.  
Lewis Carroll, *Alice in Wonderland*, ch. 12.

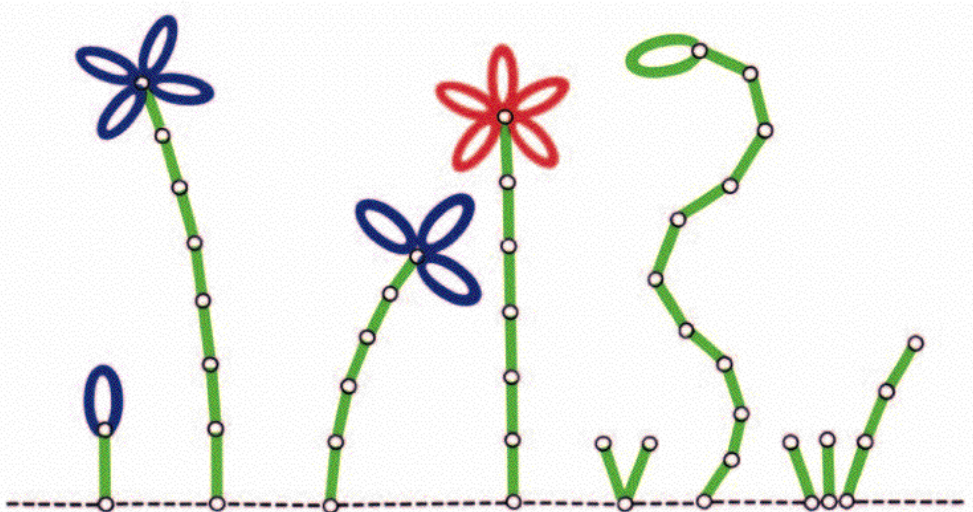
There are many games, such as

$$* = 0 \mid 0, \quad \uparrow = 0 \mid *, \quad *2 = \{0, * \mid 0, *\}, \quad \uparrow * = \{0, * \mid 0\}, \quad \dots,$$

in which *both* players have legal moves from *every* non-terminal position. This prevents numbers such as

$$1 = \{0 \mid \}, \quad -3 = \{ \mid -2\}, \quad \dots,$$

from arising, and in fact ensures that all the positions have infinitesimal values. We'll call such games **all small**.



**Figure 1.** Another Flower Garden.



Figure 1 shows a Hackenbush Hotchpotch flower garden. Recall from earlier chapters that although

blue edges may only be chopped by Left, and  
 Red only by Right, any  
 green edge may be chopped by Either,

so since the only edges which touch the ground are green, both players will have legal moves if anything at all remains of the picture. Hackenbush flower gardens are therefore all small.

You don't need to have read Chapter 7, which dealt with complicated Hackenbush positions, because the simple properties of flowers which we use now will be redeveloped as we want them.

### Uppitiness and Uncertainty

The small games that occurred in Hackenbush Hotchpotch (Chapter 7) have values that can be expressed as a whole number of flowers or an equivalent number of ups. In this chapter we'll show that every small game has a certain *atomic weight* which can also be called its *uppitness* since it tells us what number of ups it's most nearly equal to.

Even in sums of Hackenbush Hotchpotch flowers there's a fundamental uncertainty of  $\uparrow$  or  $\uparrow\uparrow$  which makes a complete analysis very hard. What we *can* say is that an advantage of 2 or more flowers is enough to win even if the opponent has the next move. One or no flowers may or may not suffice because then the players must prepare to fight a Nim-like battle over stem-lengths, in addition to their main aim of weeding out the opponent's color. In fact when all earthly blooms have faded, the stars will still remain, and the outcome will depend on the resulting Nim-game value.

Much the same can be said even about the all small games that do not arise in Hackenbush. Every such game  $g$  has a definite atomic weight  $G$ , and

$$\text{if } G \geq 2, \text{ then } g \geq 0.$$

#### DOUBLE-UP TO BE SURE

On the other hand, an atomic weight  $G$  of 0 or 1 may not be enough because of the subtle Nim-like problems embedded in  $g$ .

We can reduce the amount of uncertainty, but at some cost, by adding a very large Nim-heap. Since this has value  $*N$  for some large number  $N$ , we shall call it a **remote star**. Since the exact value of  $N$  doesn't matter provided it's large enough, we'll use a special symbol,

$\star$  ("far star")

for any remote enough star. It turns out that

$$g + \star \geq 0 \text{ exactly when } G \geq 1.$$

So if Right starts when a remote star is present, an atomic weight of at least 1 is not only sufficient, but also necessary, for Left to win.

The remote star stops us from having to worry about the exact structure of the Nim-like part of the game, since from a remote enough star we can reach any desired number,

$$0, \ *1, \ *2, \ *3, \ \dots$$

To know the outcome of  
 $g + \star$   
 what you need is just  
 the  
 atomic weight of  $g$ .

In general we'll use small letters for small games and large ones for their atomic weights.

## Computing Atomic Weights

Calculating atomic weights is very like cooling by temperature 2 (Chapter 6) except that we must occasionally compare  $g$  with the remote stars.

Suppose that

$$g = \{a, b, c, \dots \mid d, e, f, \dots\}$$

and that we already know the atomic weights

$$A \text{ of } a, B \text{ of } b, C \text{ of } c, \dots; \quad D \text{ of } d, E \text{ of } e, F \text{ of } f, \dots,$$

then:

the atomic weight  $G$  of  $g$  is  
 $G_0 = \{A-2, B-2, C-2, \dots \mid D+2, E+2, F+2, \dots\}$   
*unless  $G_0$  is an integer and*  
*either  $g > \star$  or  $g < \star$ .*  
**In these eccentric cases:**  
 if  $g > \star$ ,  $G$  is the largest integer for which  
 $G \triangleleft D+2$ ,  $G \triangleleft E+2$ ,  $G \triangleleft F+2$ , ...;  
 if  $g < \star$ ,  $G$  is the least integer for which  
 $G \triangleright A-2$ ,  $G \triangleright B-2$ ,  $G \triangleright C-2$ , ... .

### THE ATOMIC WEIGHT CALCULUS

We'll usually write just

$$G = \{A-2, B-2, C-2, \dots \mid D+2, E+2, F+2, \dots\},$$

the quotation marks indicating that proper care must be taken in the eccentric cases.





How remote should  $\star$  be?

$\star N$  will already serve as a remote star for  $g$ , provided that no position of  $g$  (including  $g$  itself) has value  $\star N$ .

Thus  $\star 2$  is remote enough for  $\uparrow = 0 \mid \star$ , and so, since

$$\uparrow > \star 2, \text{ we can write } \uparrow > \star.$$

Similarly  $\star(m+1)$  is remote enough for  $\star m$ , and since

$$\star m \parallel \star(m+1), \text{ we have } \star m \parallel \star.$$

This is enough to show that

every number  $\star m$  has atomic weight 0.

for if we know this of  $0, \star 1, \star 2$ , say, then since  $\star 3 \parallel \star$ , our formula gives

$$G_0 = \{0-2, 0-2, 0-2 \mid 0+2, 0+2, 0+2\} = 0,$$

for the atomic weight of

$$\star 3 = \{0, \star 1, \star 2 \mid 0, \star 1, \star 2\}.$$

On the other hand,

$\uparrow$  has atomic weight 1,

because although we find

$$G = "\{0-2 \mid 0-2\}" = "\{-2 \mid 2\}"$$

we have an eccentric case

$$\uparrow > \star$$

and so we must choose the *largest* integer  $\ll 0+2$ , namely 1.

Let's check that  $\downarrow \star \mid 0 = \downarrow$  has atomic weight  $-2$ , as it should. Our calculus gives

$$G = "\{-1-2 \mid 0+2\}" = "\{-3 \mid 2\}"$$

but since

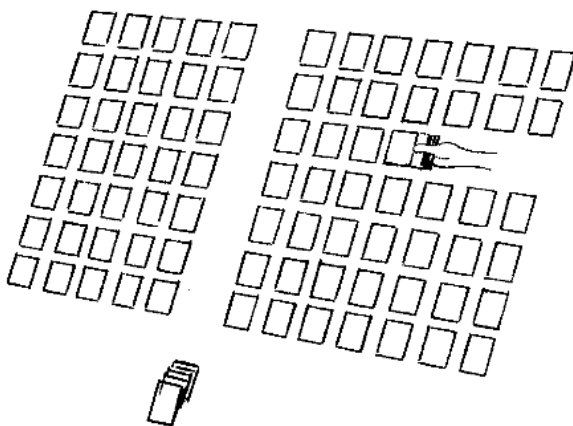
$$\downarrow < \star$$

we must choose the *least* integer  $\mid \triangleright -3$ , namely  $-2$ .

## Eatcake

Eatcake is a game due to Jim Bynum. It is the disjunctive version of Eatcakes, which we will meet in Chapter 9. A number of rectangular cakes (initially just one) are on the table, ruled into  $1 \times 1$  squares. At his move Left (Lefty) must eat a vertical strip of width 1 through *just one* of these cakes, thereby probably dividing it into two smaller cakes. Right (Rita) eats horizontal strips in a similar way.

So that you don't have to keep asking Mother to bake more cakes, Bynum suggests you play his game with ordinary playing cards. In Fig. 2 you see Rita making the second move of a game.



**Figure 2.** Rita Making the Second Move in a Game of Eatcake.

Bynum made a case by case analysis of all sufficiently small starting rectangles and empirically discovered that the outcome depends only on the parity of the two edge-lengths. This was proved in ONAG (pp. 201–204) where it is shown that the values of rectangles are as shown in Table 1(a),

	1	2	3	4	5	6		1	2	3	4	5	6	7
1	*	$-g_1$	*	$-g_1$	*	$-g_1$	1		-		-		-	
2	$g_1$	*	$g_2$	$g_2 - g_1 + *$	$g_3$	$g_3 - g_1 + *$	2	+		+		+		+
3	*	$-g_2$	*	$-g_2$	*	$-g_2$	3		-		-		-	
4	$g_1$	$g_1 - g_2 + *$	$g_2$	*	$g_3$	$g_3 - g_2 + *$	4	+		+		+		+
5	*	$-g_3$	*	$-g_3$	*	$-g_3$	5		-		-		-	
6	$g_1$	$g_1 - g_3 + *$	$g_2$	$g_2 - g_3 + *$	$g_3$	*	6	+		+		+		+
							7		-		-		-	

**Table 1.** (a) Values of Eatcake.

(b) Outcomes of Eatcake.



where the games  $g_i$  are defined by

$$\begin{aligned} g_1 &= 0 \mid * = \uparrow, \\ g_2 &= \{g_1 + g_1 \mid *\}, \\ g_3 &= \{g_1 + g_2, g_2 + g_1 \mid *\}, \\ g_4 &= \{g_1 + g_3, g_2 + g_2, g_3 + g_1 \mid *\}, \\ g_5 &= \{g_1 + g_4, g_2 + g_3, g_3 + g_2, g_4 + g_1 \mid *\}, \end{aligned}$$

and in general

$$g_n = \{g_1 + g_{n-1}, g_2 + g_{n-2}, \dots, g_{n-1} + g_1 \mid *\}.$$

What are the atomic weights of these? We know that

$$\begin{aligned} g_1 = \uparrow &\text{ has atomic weight 1, and so} \\ g_2 = \uparrow \mid * &\text{ has atomic weight } \{2 - 2 \mid 0 + 2\} = 1, \text{ then} \\ g_3 = \{g_1 + g_2 \mid * \} &\text{ has the same atomic weight } \{2 - 2 \mid 0 + 2\} = 1, \end{aligned}$$

and by induction so do  $g_4, g_5, \dots$ .

When you're playing a game of Eatcake you can use Table 1 to evaluate the position in the form

$$g_a + g_b + \dots - g_c - \dots (+ *, \text{ possibly})$$

and since all the  $g_i$  have atomic weight 1,

if there are at least 2 more positive  $g_i$  than negative ones, or at least 1 more and Left has the move, then Left can win.

For the further analysis, it's wise to let

$$g_n = h_1 + h_2 + \dots + h_n$$

The  $h_i$  are positive infinitesimals with very interesting properties (see ONAG, pp. 203–204).

## Splitting The Atom

Atomic weights are usually whole numbers, but not always. For example,

$$\uparrow \mid \downarrow \text{ has atomic weight } \{2 - 2 \mid -1 + 2\} = 0 \mid 1 = \frac{1}{2}$$

and more complicated numbers can also happen. But atomic weights needn't even be numbers:

$$\begin{aligned} \uparrow \mid \downarrow &\text{ has atomic weight } \{2 - 2 \mid -2 + 2\} = \{0 \mid 0\} = *, \text{ and} \\ 3.\uparrow \mid 3.\downarrow &\text{ has atomic weight } \{3 - 2 \mid -3 + 2\} = \{1 \mid -1\} = \pm 1. \end{aligned}$$

But they still add up nicely:

If  $g, h, k, \dots$  have atomic weights  $G, H, K, \dots$ ,  
then  $g + h + k + \dots$  has atomic weight  $G + H + K + \dots$ .

For example,

$$\uparrow \downarrow + \uparrow \downarrow \downarrow \text{ has atomic weight } \frac{1}{2} + *.$$

In a moment we'll see that some quite interesting atomic weights arise in the game of Childish Hackenbush Hotchpotch. But first

## Turn-and-Eatcake

This game was introduced in ONAG (pp. 199–200) where it was described as the twisted form of Bynum's Game. It is played just like Eatcake except that before eating a strip, the player must turn the appropriate cake through one right angle.

	1	2	3	4	5	6	7	8	9	10	11	12
1	*	↑	*	↑ <sup>2</sup>	↑ <sup>2</sup>		*	↑	*	↑ <sup>2</sup>	↑ <sup>2</sup>	
2	↓	0	↓	0	↓ <sub>2</sub>	0	↓	0	↓	0	↓ <sub>2</sub>	0
3	*	↑	*	↑ <sup>2</sup>	↑ <sup>2</sup>		*	↑	*	↑ <sup>2</sup>	↑ <sup>2</sup>	
4	↓ <sub>2</sub>	0	↓ <sub>2</sub>	0	↓ <sub>3</sub>	0	↓ <sub>2</sub>	0	↓ <sub>2</sub>	0	↓ <sub>3</sub>	0
5		↑ <sup>2</sup>		↑ <sup>3</sup>	*	↑ <sup>2</sup>		↑ <sup>3</sup>		↑ <sup>2</sup>	*	↑ <sup>3</sup>
6	↓ <sub>2</sub>	0	↓ <sub>2</sub>	0	↓ <sub>2</sub>	0	↓ <sub>2</sub>	0	↓ <sub>2</sub>	0	↓ <sub>2</sub>	0
7	*	↑	*	↑ <sup>2</sup>	↑ <sup>2</sup>		*	↑	*	↑ <sup>2</sup>	↑ <sup>2</sup>	
8	↓	0	↓	0	↓ <sub>3</sub>	0	↓	0	↓	0	↓ <sub>3</sub>	0
9	*	↑	*	↑ <sup>2</sup>	↑ <sup>2</sup>		*	↑	*	↑ <sup>2</sup>	↑ <sup>2</sup>	
10	↓ <sub>2</sub>	0	↓ <sub>2</sub>	0	↓ <sub>2</sub>	0	↓ <sub>2</sub>	0	↓ <sub>2</sub>	0	↓ <sub>2</sub>	0
11		↑ <sup>2</sup>		↑ <sup>3</sup>	*	↑ <sup>2</sup>		↑ <sup>3</sup>		↑ <sup>2</sup>	*	↑ <sup>3</sup>
12	↓ <sub>2</sub>	0	↓ <sub>2</sub>	0	↓ <sub>3</sub>	0	↓ <sub>2</sub>	0	↓ <sub>2</sub>	0	↓ <sub>3</sub>	0

**Table 2.** Most of the Values in Turn-and-Eatcake.

Except for rectangles having a side of form  $6n+5$  the values have period 6 (Table 2). The games

$$\begin{aligned} \uparrow^2 &= \{0 \mid \downarrow + *\} && \text{(pronounced "up second"), and} \\ \uparrow^3 &= \{0 \mid \downarrow + \downarrow_2 + *\} && \text{(pronounced "up third")} \end{aligned}$$

behave as if they were indeed the square and cube of  $\uparrow$ , so that:

$$\begin{aligned} \text{any number of copies of } \uparrow^2 &\text{ add to less than } \uparrow \\ \text{any number of copies of } \uparrow^3 &\text{ add to less than } \uparrow^2 \end{aligned}$$



We've written

$\downarrow_2$  ("down second") and  $\downarrow_3$  ("down third")

for the negatives of  $\uparrow^2$  and  $\uparrow^3$ . These games have atomic weight 0.

In the rows corresponding to an edge-length  $6n+5$  the entries, after the third, have period 12. For the entries missing from Table 2 the other edge-length is odd and the value is

(a multiple of  $\uparrow$ ) + \*

	1	3	5	7	9	11	13	15	17	19
$6n+5$	$\uparrow+*$	$*\cdot\uparrow$	$*$	$\frac{1}{2}\cdot\uparrow+*$	$\frac{1}{4}\cdot\uparrow+*$	$*$	$\frac{1}{2}\cdot\uparrow+*$	$\frac{1}{4}\cdot\uparrow+*$	$*$	$\frac{1}{2}\cdot\uparrow+*$

(Column entries missing from Table 2 are the negatives of these, i.e. they have  $\downarrow$  in place of  $\uparrow$ .)

As you can see, the multipliers involve stars and fractions. We'll show you how to define general multiples of  $\uparrow$  later in this chapter. The only non-integer multipliers which arise in Turn-and-Eatcake are

$$\begin{aligned} * \cdot \uparrow + * &= \uparrow \downarrow \text{ which has incentive } (2+*) \cdot \uparrow + * \\ \frac{1}{4} \cdot \uparrow + * &= \uparrow \downarrow \text{ which has incentive } (1\frac{3}{4}) \cdot \uparrow + * \\ \frac{1}{2} \cdot \uparrow + * &= \uparrow \downarrow \text{ which has incentive } (1\frac{1}{2}) \cdot \uparrow + * \end{aligned}$$

You should choose between them in this order and prefer to move in one of these (or its negative) rather than elsewhere.

Beware! It is *not true* that  $\uparrow^2 < \frac{1}{4} \cdot \uparrow$   
and it is *not true* that  $\uparrow^2 = \uparrow \cdot \uparrow$

## All You Need To Know About Atomic Weights But Were Afraid To Ask

Although it's quite hard to *prove* things about atomic weights, they're very easy to *use*, because they usually turn out to be whole numbers. Here's a complete list of properties; big letters are the atomic weights of the corresponding little ones:

If	$G \geq 2$	then	$g \geq 0$ ,
If	$G \leq -2$	then	$g \leq 0$ ,
If	$G \triangleright 0$	then	$g \triangleright 0$ ,
If	$G \triangleleft 0$	then	$g \triangleleft 0$ .
	$G \geq 1$	just if	$g > \star$ .
	$G \leq -1$	just if	$g < \star$ .
	$-1 \triangleleft G \triangleleft 1$	just if	$g \parallel \star$ .

And remember that for

$$g = \{a, b, c, \dots \mid d, e, f, \dots\}$$

our Atomic Weight Calculus gives

$$G = \{A-2, B-2, C-2, \dots \mid D+2, E+2, F+2, \dots\}$$

except in the eccentric cases when this is an integer and

$$\begin{aligned} \text{either } g &> \star; & G &= \text{largest integer } \triangleleft \text{ all of } D+2, E+2, F+2, \dots : \\ \text{or } g &< \star; & G &= \text{least integer } \triangleright \text{ all of } A-2, B-2, C-2, \dots . \end{aligned}$$

Also

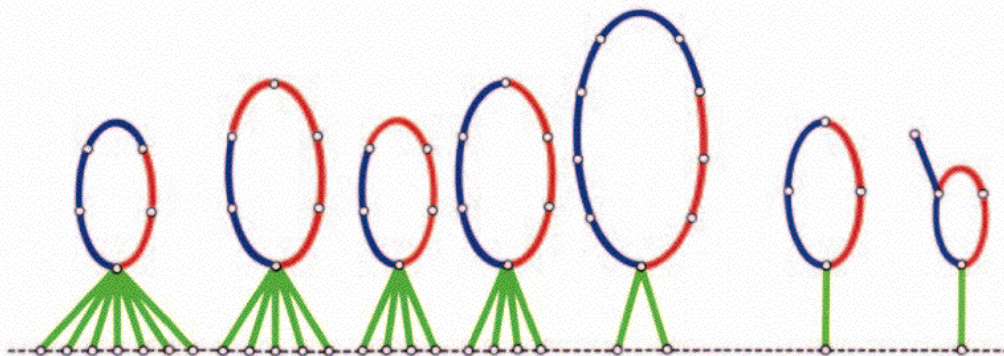
$\begin{array}{ll} g+h+k+\dots & \text{has atomic weight } G+H+K+\dots, \\ -g & \text{has atomic weight } -G. \end{array}$
--

We'll be back to prove all these results after a childish interlude.

## Childish Hackenbush Hotchpotch

Like other variations on the Hackenbush theme, this game is played on a picture with colored edges. This time each edge is either red or blue or green. Just as in ordinary Hackenbush Hotchpotch, Either player may remove *any* grEen edge along with all other edges no longer connected to the ground. Alternatively, Left may remove any single bLue edge but only under the *childish* condition that its removal does not disconnect any other edge from the ground. Similarly Right may chop a Red edge only if it leaves all other edges connected to the ground. Observe that the childish condition applies *only* to the red and blue edges, *not* to the green ones.

Left and Right can't remember whose turn it is to move next in the Childish Hackenbush Hotchpotch position of Fig. 3. Does this matter?

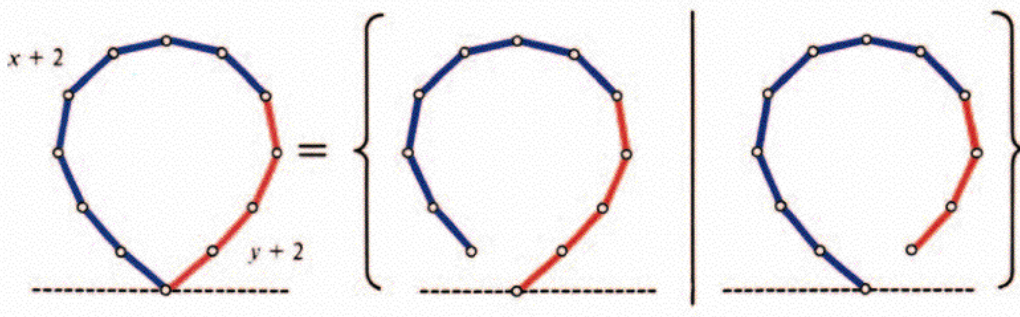


**Figure 3.** Does it Matter who Gets First Lick at the Lollipops?

Except for the rightmost summand, the position is a sum of **lollipops** made of red and blue loops supported by a number of green branches each of which connects the base of the loop directly to the ground. The value of a grounded loop made of  $x+2$  blue edges joined at



the top to  $y+2$  red ones is  $\{x \mid -y\}$ , good moves being as shown in Fig. 4. Each player chops his lowest edge because this allows him to play all but one of his remaining edges at leisure.



**Figure 4.** A Childish Hackenbush Loop Worth  $\{x \mid -y\}$ .

For the childish lollipop made of such a red-blue loop supported by  $n$  green edges, we'll use the symbol

$$\{x \mid -y\}_n$$

From this game Left has only two plausible moves:

$$\text{to } \{x \mid -y\}_{n-1} \quad \text{or } (x)_n$$

where  $(x)_n$  denotes a picture of value  $x$  supported by a sheaf of  $n$  green edges. Since Right has a similar choice of moves, we have

$$\{x \mid -y\}_n = \{ \{x \mid -y\}_{n-1}, (x)_n \mid \{x \mid -y\}_{n-1}, (-y)_n \},$$

and similarly

$$(x)_n = \{ (x)_{n-1}, (x^L)_n \mid (x)_{n-1}, (x^R)_n \}.$$

In this notation, the six lollipops of Fig. 3 have values

$$\{1 \mid 0\}_7 \quad \{0 \mid -2\}_5 \quad \{0 \mid -1\}_4 \quad \{1 \mid -1\}_4 \quad \{4 \mid -1\}_2 \quad \{0 \mid 0\}_1$$

and you can check that the non-lollipop at the end has value  $(\frac{1}{2})_1$

### Atomic Weights of Lollipops

If  $z$  is an integer, the position  $(z)_n$  is actually a grown-up Hackenbush Hotchpotch position whose atomic weight is

$$n, \quad 0 \quad \text{or} \quad -n,$$

according as

$$z > 0, \quad z = 0 \quad \text{or} \quad z < 0,$$

(Work this out for yourself, or use the flow method of Chapter 7.)

We can now use the Atomic Weight Calculus to find the atomic weights of all Childish Hackenbush lollipops. When  $x = y = 0$ , we have

$$\{0 \mid 0\}_n \parallel \star \text{ for all } n, \text{ and so it has atomic weight } 0.$$

In the more interesting case  $x > 0, y = 0$ , we have

$$\{x \mid 0\}_n > \star,$$

and so we can work out the atomic weights:

<i>game</i>	<i>atomic weight</i>
$\{x \mid 0\}_1$	" $\{1-2 \mid 0+2\} = 1$ , an eccentric case,
$\{x \mid 0\}_2$	$\{2-2 \mid 0+2\} = 1$ ,
$\{x \mid 0\}_3$	$\{1 \mid 2\} = 1\frac{1}{2}$ ,
$\{x \mid 0\}_4$	$\{2 \mid 2\} = 2^*$ ,
$\{x \mid 0\}_5$	$\{3 \mid 2\} = 2\frac{1}{2} \pm \frac{1}{2}$ ,
$\{x \mid 0\}_6$	$\{4 \mid 2\} = 3 \pm 1$ ,
$\{x \mid 0\}_7$	$\{5 \mid 2\} = 3\frac{1}{2} \pm 1\frac{1}{2}$ ,

---

In the most common case with  $x > 0, -y < 0$ , we have

$$\{x \mid -y\}_n \parallel \star$$

and so:

<i>game</i>	<i>atomic weight</i>
$\{x \mid -y\}_1$	$\{1-2 \mid -1+2\} = 0$ ,
$\{x \mid -y\}_2$	$\{2-2 \mid -2+2\} = *$ ,
$\{x \mid -y\}_3$	$\{1 \mid -1\} = \pm 1$ ,
$\{x \mid -y\}_4$	$\{2 \mid -2\} = \pm 2$ ,
$\{x \mid -y\}_5$	$\{3 \mid -3\} = \pm 3$ ,

---

From these results we can find the atomic weights of all the components in Fig. 3, respectively

$$\begin{array}{ccccccc}
 3\frac{1}{2} \pm 1\frac{1}{2} & -2\frac{1}{2} \pm \frac{1}{2} & -2^* & \pm 2 & * & 0 & 1 \\
 \text{corresponding to the values} & & & & & & \\
 \{1 \mid 0\}_7 & \{0 \mid -2\}_5 & \{0 \mid -1\}_4 & \{1 \mid -1\}_4 & \{4 \mid -1\}_2 & \{0 \mid 0\}_1 & (\frac{1}{2})_1
 \end{array}$$

so that the atomic weight of the whole figure is precisely

$$\pm 2 \pm 1 \pm \frac{1}{2}.$$

If we were playing the resulting game of Cashing Cheques (Chapter 5) on these atomic weights the first player would clearly win with a full move to spare, so writing

$$g = \{a, b, c, \dots \mid d, e, f, \dots\}$$





for the sum of everything in Fig. 3 we can suppose

$$A \geq 1 \quad \text{and} \quad D \leq -1.$$

Now since  $A \geq 1$  implies  $a > \star$  and  $D \leq -1$  implies  $d < \star$ , the optimal strategy in the Cashing Cheques game would also ensure a win for the first player on the sum of Fig. 3 with a remote star. But what, if anything, can we deduce about the outcome of Fig. 3 alone? Since some games of atomic weight 1 are positive (e.g.  $\uparrow$ ) but others are fuzzy (e.g.  $\uparrow*$ ) we can't say for sure that a move to a position of atomic weight at least 1 is always good enough to win for Left.

Nevertheless we *can* assert (and prove!) that the first player can win Fig. 3 and *only* by optimizing the atomic weight. The reason is that a remote star actually *is* present! The lollipop of atomic weight 0 has value

$$\{0 \mid 0\}_1 = (*1)_1 = *2,$$

and with respect to everything else in the figure,  $*2$  is remote!

## Proving Things About Atomic Weights

Proving things about atomic weights will take us quite a long time, so if you only want to *use* them, why not just play a few more childish games while you're waiting for the rest of us to finish the chapter? You don't *have* to follow the proofs!

We can use Hackenbush flower gardens to make the proofs look easier and prettier! To be quite precise we'll define a **flower** to have a green **stem** of at least one edge, topped by a completely blue or a completely red **blossom** which must also have at least one edge (**petal**). A **flower garden** is any position made up of flowers and possibly some purely green grass (or snakes!) as in Fig. 1.

Recall the rules saying who can chop the various colors of edge and that after each chop we remove any edges no longer connected to the ground. So that you don't have to reread Chapter 7, we'll remind you here how to play well in flower gardens.

## Playing Among the Flowers

*If your garden has no flowers*, then each piece of grass (or snake) has some value  $*n$  and you're really playing Nim (Chapter 2).

*If there's a blue flower but no red ones*, then Left, if he has the move, can win as follows; if there is a winning move in the Nim-position got by ignoring the blue petals, he should make it. Otherwise he should pluck a blue petal, and leave this awkward Nim-position for Right. Any blue petals that remain won't hurt Left. (This is the Blue Flower Ploy of Chapter 7.)

*In more general flower gardens:*

Left can win if he has the move  
and is at least 1 flower ahead  
( $G \geq 1$ )

THE ONE-UPMANSHIP RULE

Left can win without the move  
if he is at least 2 flowers ahead  
( $G \geq 2$ )

THE TWO-AHEAD RULE

These are particular cases of

THE ATOMIC WEIGHT RULES:

if  $G \triangleright 0$ , then  $g \triangleright 0$ ;  
if  $G \geq 2$ , then  $g \geq 0$ ,

but can be proved directly, for if the position has 2 more blue flowers than red ones when Left presents it to Right, it will still have at least one more when the turn reverts to Left. He can then either restore his advantage by chopping down a red flower or use the Blue Flower Ploy if no red flower remains.

When is  $g$  as uppity as  $h$ ?

We'll reserve the name **flowerbed** for a flower garden that has just as many blue flowers as red ones:

When your garden is BalancED  
With just as many Blue as rED  
We shall call it a flowerBED.

Since the blue and red flowers cancel, we want to say that a flowerbed has atomic weight 0. But we can't use the notion of atomic weight before we prove things about it, and so we'll define  $g$  and  $h$  to be **equally uppity** and write  $g \doteq h$  exactly when there are flowerbeds  $f_1$  and  $f_2$  for which

$$f_1 \geq g - h \geq f_2$$

Two games are equally uppity just  
if we can trap their difference  
between two flowerbeds.



Obviously

$$g \doteq h \quad \text{implies} \quad g + k \doteq h + k,$$

and, because the sum of 2 flowerbeds is a flowerbed,

$$g \doteq h \quad \text{and} \quad h \doteq k \quad \text{imply} \quad g \doteq k.$$

If we can only find a *single* flowerbed  $f$  for which

$$g - h \geq f$$

we'll say that  $g$  is **at least as uppity** as  $h$  and write  $g \geq h$ .

If  $g$  is exactly as uppity as some multiple of up, say

$$g \doteq G \cdot \uparrow$$

we'll say that  $G$  is the **uppitness** of  $g$ . It will take us quite a long time to prove that this is just the atomic weight. Note that *any* flowerbed  $f$  has uppitness 0 since

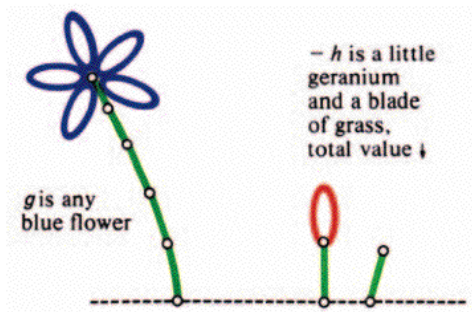
$$f \geq f - 0 \cdot \uparrow \geq f.$$

Taking  $g$  to be *any* blue flower, and  $h$  to be  $\uparrow$ , we have

$$g - h = f$$

for the flowerbed of Fig. 5. This shows that:

any blue flower has uppitness 1.

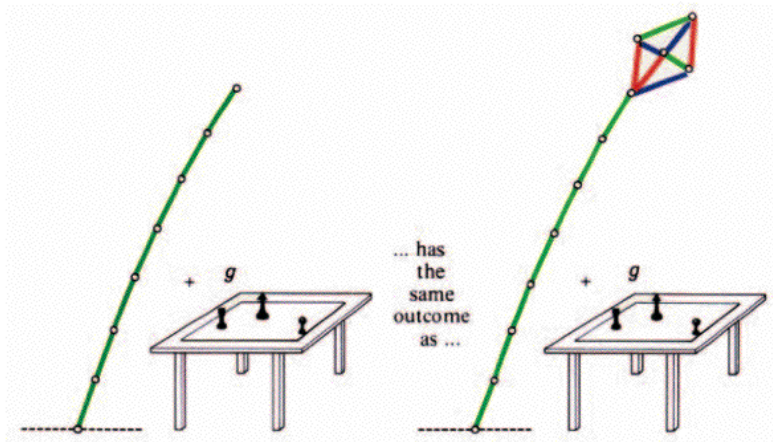


**Figure 5.** The Flowerbed  $f$ .

[Note that flowers of stem length 1, with just one petal, are **geRaniums Red** or **deLphiniums bLue**, whose values are  $\downarrow*$  or  $\uparrow*$ .]

## Go Fly A Kite!

We'll need to show that it doesn't matter which remote star you use when computing the atomic weight of  $g$ . In Hackenbush, a remote star is just a long piece of green string and we can in fact show that provided it's long enough it doesn't matter at all what's on top of it. You might as well go and fly any kind of kite (Fig. 6).



**Figure 6.** The Kite Strategy.

We'll show that Left can convert a winning strategy for

$$\text{string} + g$$

into one for

$$\text{kited string} + g$$

provided that the string is so long that its value is distinct from all the values of positions in  $g$  (this is the exact meaning of "remote").

Left should just ignore the kite and play his old strategy until Right moves in the kite, when, since we're ignoring the kite, it's just as if he's made no move at all. But since Left's strategy wins if we ignore the kite, the position

$$\text{kited string} + h$$

that Right just moved from had

$$\text{string} + h \geq 0$$

and therefore

$$\text{string} + h > 0$$

since

$$\text{string} \neq h,$$

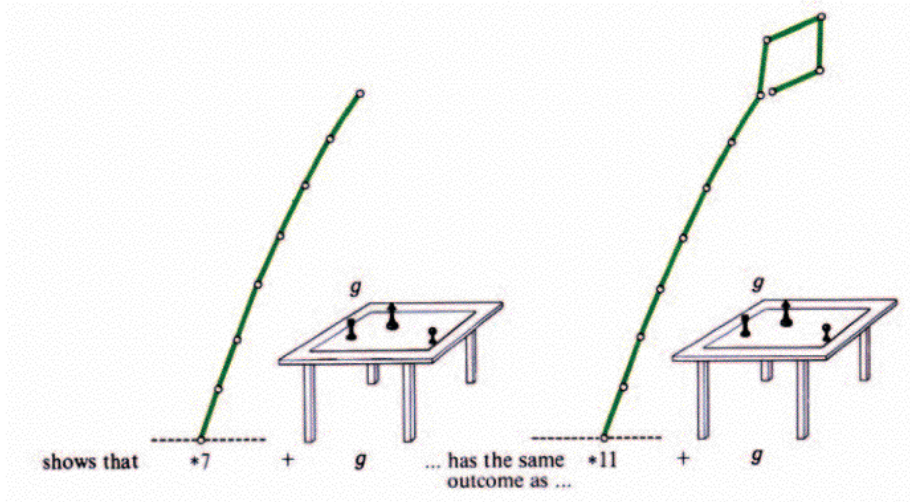


Left therefore had a winning move in  $string + h$ , and since Right's move has affected neither  $string$  nor  $h$ , this move is still available and Left can continue with his strategy.

In the colon notation introduced in the Extras to Chapter 7, the value of a kited string is  $string:kite$ . Our argument actually proves **Norton's Lemma** (more precisely stated there) that for any  $S$  and  $K$ , the games  $S$  and  $S : K$  have the same order relations with every game that has no position of value  $S$ .

### All Remote Stars Agree

The all green kite in



provided that no position of  $g$  has value  $*7$ . More generally,

if neither  $*m$  nor  $*n$  is the value of any position in  $g$ , then the outcomes of  $*m + g$  and  $*n + g$  are the same.

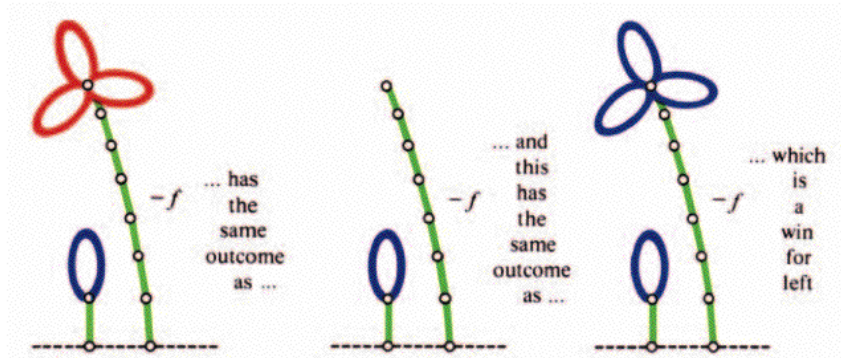
This justifies our use of  $\star$  for all remote stars:

$g > \star$  means  $g > *m$   
 $g < \star$  means  $g < *m$   
 $g \parallel \star$  means  $g \parallel *m$

for any  $*m$  which is not the value of any position in  $g$ .

## Large and Small Flowerbeds

Figure 7 shows that any flowerbed  $f$  is less than a 2-flower flowerbed in which one of the flowers is a very tall red one. This is because it doesn't matter what's at the top of a very long string and so we can change the tall red flower into a tall blue one, making Left two flowers ahead.



**Figure 7.** When a Flower's Very Tall You can Hardly See Its Petals.

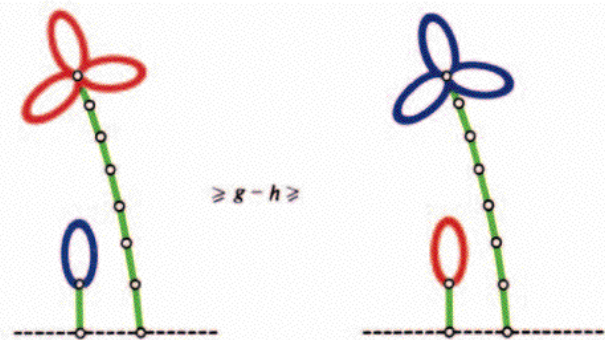
And

For a large flowerbed  
You need just one tall red.

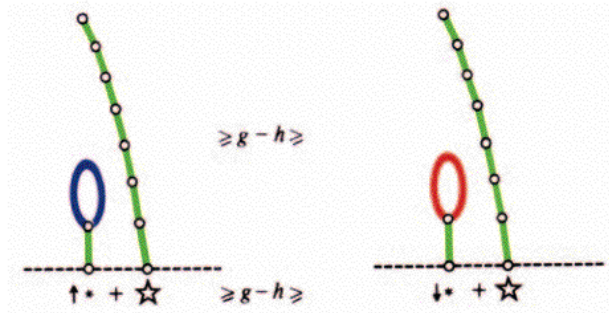
Your bed will be small  
When the blue flower's tall.

Since we now know the largest and smallest flowerbeds, we can simplify our uppitness test.

The games  $g$  and  $h$  will be *equally uppity* only if



(for tall enough flowers) or, simpler still, if



(for remote enough ☆). We call this the **Remote Star Test**.

When comparing remote stars with sums of other games, it is wisest to take

$$\star = *N$$

where  $N$  is the power of 2 next greater than all the  $m$  for which  $*m$  appears in the other games, because then

$$m < N, \quad n < N \quad \text{imply} \quad m \dagger n < N.$$

### Playing Under a Lucky Star

If you find yourself playing the sum of ordinary games and one remote star, you're lucky, because

in the presence of a remote star,  
you can exchange a game for any  
other of the same uppitness.

#### THE EXCHANGE PRINCIPLE

In symbols, if  $g \doteq h$ , then

$$g + \star \quad \text{has the same outcome as} \quad h + \star$$

It will suffice to prove that if  $g \dot{\geq} h$  and

Left can win  $h+$  tall red flower,  
then he can win  $g+$  tall blue flower,

for the Kite Strategy shows that we can replace these tall flowers by remote stars without affecting outcomes.

But then because

$$g - h \geq \text{some flowerbed, } f,$$

we have

$$(g+ \text{ tall blue}) - (h+ \text{ tall red}) \geq f+ (2 \text{ tall blues}),$$

and this is positive by the Two-Ahead Rule.

## General Multiples of Up

We're now almost in a position to prove that the Atomic Weight Calculus gives the right answers. What we've got to do is to show that when the rule says that the atomic weight of  $g$  is  $G$ , then

$$g \doteq G \cdot \uparrow$$

or, by the Remote Star Test, that

$$\uparrow * + \star \geq g - G \cdot \uparrow \geq \downarrow * + \star$$

But since atomic weights need not be integers we'll have to say just what we mean by  $G \cdot \uparrow$  when  $G$  is a non-integer game such as

$$\{0 \mid 1\} = \frac{1}{2}, \quad \{0 \mid 0\} = * \quad \text{or} \quad \{1 \mid -1\} = \pm 1,$$

as well as integer ones such as

$$\{1 \mid \} = 2, \quad \{ \mid -3\} = -4 \quad \text{or} \quad \{ \mid \} = 0.$$

Simon Norton has shown how to define such multiples  $G \cdot U$  for any positive game  $U$ . When we put  $U = \uparrow$  his definition reduces to

$$G \cdot \uparrow = \{G^L \cdot \uparrow + \uparrow * \mid G^R \cdot \uparrow + \downarrow *\}$$

But this formula must *only* be used for *non-integer* games  $G$ —if  $G$  is an integer you must use the obvious rules:

$$2 \cdot \uparrow = \uparrow + \uparrow, \quad (-4) \cdot \uparrow = \downarrow + \downarrow + \downarrow + \downarrow, \quad 0 \cdot \uparrow = 0$$

For the non-integer multipliers

$$\frac{1}{2} = \{0 \mid 1\}, \quad * = \{0 \mid 0\}, \quad \pm 1 = \{1 \mid -1\}$$

we find

$$\begin{aligned} \frac{1}{2} \cdot \uparrow &= \{0 \cdot \uparrow + \uparrow * \mid 1 \cdot \uparrow + \downarrow *\} = \{\uparrow * \mid \downarrow *\}, \\ * \cdot \uparrow &= \{0 \cdot \uparrow + \uparrow * \mid 0 \cdot \uparrow + \downarrow *\} = \{\uparrow * \mid \downarrow *\}, \\ (\pm 1) \cdot \uparrow &= \{1 \cdot \uparrow + \uparrow * \mid (-1) \cdot \uparrow + \downarrow *\} = \{3 \cdot \uparrow * \mid 3 \cdot \downarrow *\}. \end{aligned}$$

In the Extras we'll give Norton's definition of  $G \cdot U$  for all positive games  $U$  and show that

$$(A + B + C + \dots) \cdot U = A \cdot U + B \cdot U + C \cdot U + \dots$$

and in particular

$$(A + B + C + \dots) \cdot \uparrow = A \cdot \uparrow + B \cdot \uparrow + C \cdot \uparrow + \dots$$





## Proof of the Remote Star Rules

One of the things we've got to prove about atomic weights is that

$$G \geq 1 \quad \text{exactly when} \quad g > \star$$

from which, by symmetry,

$$G \leq -1 \quad \text{exactly when} \quad g < \star$$

and so

$$-1 \triangleleft G \triangleleft 1 \quad \text{exactly when} \quad g \parallel \star$$

Of course we can suppose these results for all the options of

$$g = \{a, b, c, \dots \mid d, e, f, \dots\}$$

We suppose first that  $g > \star$  and show that Right has no good move in  $G - 1$  (i.e. that  $G \geq 1$ ). Because Right has no good move in  $g + \star$  we know that

$$d \Vdash \star, e \Vdash \star, f \Vdash \star, \dots$$

and so

$$D \Vdash -1, E \Vdash -1, F \Vdash -1, \dots$$

If  $G$  is *not* an integer, Right won't move in the component  $-1$  ("never move in an integer unless you have to") so his move is to one of

$$(D+2) - 1, (E+2) - 1, (F+2) - 1, \dots, \text{ all } \Vdash 0.$$

If  $G$  is an integer, it is the greatest number

$$\triangleleft \text{ all of } D+2, E+2, F+2, \dots$$

so that we can suppose

$$G+1 \geq D+2, \text{ say,}$$

so that

$$G \geq D+1 \Vdash -1+1 = 0.$$

But an *integer*  $\Vdash 0$  is  $\geq 1$ .

Of course we could also have shown that

$$g < \star \quad \text{implies} \quad G \leq -1$$

Now we suppose that  $G \geq 1$  and we'll deduce that  $g > \star$ . By the previous remark we cannot have  $g < \star$ . So if our statement fails we can only have  $g \parallel \star$  and can therefore suppose that

$$G = \{A-2, B-2, C-2, \dots \mid D+2, E+2, F+2, \dots\}$$

Because  $G \geq 1$  we must have

$$1 \triangleleft D+2, E+2, F+2, \dots$$

that is,

$$D \Vdash -1, E \Vdash -1, F \Vdash -1, \dots$$

and so

$$d + \star, e + \star, f + \star, \dots$$

are all  $\Vdash 0$ . But since  $g \parallel \star$ , Right has *some* good move from  $g + \star$ . This must therefore be to

$$g + *m \quad \text{for some } m.$$

We'll show that this cannot be. Because  $G \neq 0$  we cannot have all of

$$A-2, B-2, C-2, \dots \triangleleft 0$$

and so can suppose

$$A-2 \geq 0, \quad \text{i.e.} \quad A \geq 2.$$

Left can therefore move from  $g + *m$  to  $a + *m$  and win by the Two-Ahead Rule.

## Proof That Atomic Weight = Uppitiness

We suppose once again that

$$g = \{a, b, c, \dots \mid d, e, f, \dots\}$$

where the atomic weights

$$A, B, C, \dots, D, E, F, \dots \quad \text{of} \quad a, b, c, \dots, d, e, f, \dots$$

have already been shown to coincide with their uppitnesses, or, in symbols:

$$\begin{aligned} a \doteq A \cdot \uparrow, & \quad b \doteq B \cdot \uparrow, & \quad c \doteq C \cdot \uparrow, & \quad \dots \\ d \doteq D \cdot \uparrow, & \quad e \doteq E \cdot \uparrow, & \quad f \doteq F \cdot \uparrow, & \quad \dots \end{aligned}$$

We want to prove that

$$g \doteq G \cdot \uparrow,$$

where  $G$  is the value given by the Atomic Weight Calculus.

By the Remote Star Test for uppitness, we only have to prove

$$\uparrow * + \star \geq g - G \cdot \uparrow \geq \downarrow * + \star$$

and by symmetry it will suffice to show that Right has no good move in

$$(G \cdot \uparrow + \uparrow * + \star) - g.$$

Observe that we *always* have

$$A-2, B-2, C-2, \dots \triangleleft G \triangleleft D+2, E+2, F+2, \dots$$

even in the eccentric cases when  $G$  is *not* defined as

$$\{A-2, B-2, C-2, \dots \mid D+2, E+2, F+2, \dots\}.$$

Suppose Right moves from the component  $-g$ , to  $-a$ , say. Then since we have a lucky  $\star$ , the resulting position can be exchanged for

$$(G \cdot \uparrow + \uparrow * + \star) - A \cdot \uparrow$$

But  $G \triangleright A-2$ , so this game has the form

$$X \cdot \uparrow + \downarrow * + \star$$

for some  $X \triangleright 0$ . If  $X$  is an integer we have

$$X \cdot \uparrow + \downarrow * + \star \geq \uparrow + \downarrow * + \star = * + \star$$



from which Left has a winning move to 0. Otherwise there is some  $X^L \geq 0$  and Left can move to

$$(X^L \cdot \uparrow + \uparrow^*) + \downarrow^* + \star \geq \uparrow + \star \geq 0.$$

Now we must consider Right's other moves from

$$(G \cdot \uparrow + \uparrow^* + \star) - g$$

namely those in the parenthesized portion. Fortunately—see the Star-Shifting Principle in the Extras—we can simplify the parenthesis to

$$\left\{ (G^L \cdot \uparrow + \uparrow^*) + \uparrow^* + \star \mid (G^R \cdot \uparrow + \downarrow^*) + \uparrow^* + \star \right\}.$$

When  $G$  is a non-integer, this is

$$\left\{ (A+1) \cdot \uparrow + \star, (B+1) \cdot \uparrow + \star, \dots \mid (D+1) \cdot \uparrow + \star, (E+1) \cdot \uparrow + \star, \dots \right\}$$

and when  $G$  is

$$\dots \quad -4 \quad -3 \quad -2 \quad -1 \quad 0 \quad 1 \quad 2$$

it becomes

$$\dots \quad \{\downarrow + \star \mid 0\} \{\downarrow + \star \mid 0\} \{\star \mid 0\} * + \star \{0 \mid \star\} \{0 \mid \uparrow + \star\} \{0 \mid \uparrow + \star\} \dots$$

There are four cases:

*In the non-integer case* we can suppose Right moves to

$$\left( (D+1) \cdot \uparrow + \star \right) - g$$

from which Left should move to

$$\left( (D+1) \cdot \uparrow + \star \right) - d$$

which we can exchange for

$$(D+1) \cdot \uparrow + \star - D \cdot \uparrow = \uparrow + \star \geq 0.$$

*If  $G$  is a negative integer*, Right can only move to

$$*m - g$$

for some  $*m$  (indeed  $*m = 0$  unless  $G$  is  $-1$ ). But in this case we have  $g < \star$  and so can't have  $G \geq *m$ , so Right's move was no good.

*If  $G$  is zero*, Right's move takes him to

$$\star - g.$$

But, unfortunately for him, we have  $g \parallel \star$  in this case.

*If  $G$  is a positive integer*, Right has moved to

$$G \cdot \uparrow + \star - g.$$

But in this case  $G$  was the largest integer for which

$$G \triangleleft \mid D+2, E+2, F+2, \dots$$

so that we can suppose

$$G+1 \geq D+2, \quad \text{say.}$$

Left can now move to

$$G \cdot \uparrow + \star - d$$

for the appropriate  $d$ , and this can be exchanged for

$$G \cdot \uparrow + \star - D \cdot \uparrow \geq \uparrow + \star \geq 0.$$

## The Wholeness of Hackenbush Hotchpotch

Our last proof of the chapter shows that all ordinary Hackenbush Hotchpotch positions have integer atomic weights. For otherwise let

$$g = \{a, b, c, \dots \mid d, e, f, \dots\}$$

be a smallest counter-example in which  $a$ , obtained by chopping edge  $\alpha$ , is the Left option of largest atomic weight  $A$ , and  $d$ , obtained by chopping edge  $\delta$ , is the Right option of least atomic weight  $D$ .

Now chop *both* edges  $\alpha$  and  $\delta$  to obtain the position  $h$ , of atomic weight  $H$ . Then since either  $h = a$  or  $h$  is a Right option of  $a$ , we must have

$$A - 2 \triangleleft H, \quad \text{and similarly} \quad H \triangleleft D + 2$$

showing that  $H$  is an integer for which

$$A-2, B-2, C-2, \dots \triangleleft H \triangleleft D+2, E+2, F+2, \dots$$

so that the atomic weight of  $g$  must be an integer (though it needn't be  $H$ ).

## Proper Care of the Eccentric

You don't always need to compare  $g$  with remote stars in order to interpret the formula

$$G = \{\{A-2, B-2, C-2, \dots \mid D+2, E+2, F+2, \dots\}\}.$$

In fact you can drop the quotation marks unless there are two or more integers  $N$  that **fit**, i.e. satisfy

$$A-2, B-2, C-2, \dots \triangleleft N \triangleleft D+2, E+2, F+2, \dots$$

Moreover, if only *positive* integers fit,

$$\{\{A-2, B-2, C-2, \dots \mid D+2, E+2, F+2, \dots\}\}$$

means the *most positive* one; and if only negative integers fit, the most negative one.



The only doubtful cases are when 0 and at least one other integer fit, when  $G$  is

	<i>most positive,</i>	<i>zero,</i>	or	<i>most negative,</i>
according as	$g > \star$	$g \parallel \star$	or	$g < \star$
Examples:				
“{0   1}” = $\frac{1}{2}$	“{0   4*}” = 4	“{- $\frac{1}{2}$   1}” = 0		“{-3   $\downarrow$ }” = -2
“{1   -1}” = $\pm 1$	“{*   4}” = 3	or 0		
	“{-2   6+ $\uparrow$ }” = 5	or 0		or -1

### Galvinized Games

Atomic weight theory has a surprising application to the following peculiar kind of sum. Let Left and Right play the **galvinized sum**

$$l_1 + l_2 + l_3 + \dots + r_1 + r_2 + r_3 + \dots$$

just like an ordinary sum except that the winner is declared to be Left or Right according as the last game to end is an  $l_i$  or an  $r_j$  (so you win by finishing off your opponent's games quickly). A game

$$g - \{a, b, c, \dots \mid d, e, f, \dots\}$$

appearing in a galvinized sum has an **electric charge**  $G$ , defined by

$$G = \text{“}\{A - 2, B - 2, C - 2, \dots \mid D + 2, E + 2, F + 2, \dots\}\text{”}.$$

except that now when more than one integer fits we take the

*most positive* if  $g$  is one of the  $l_i$  (positively charged)

and the

*most negative* if  $g$  is one of the  $r_j$  (negatively charged)

(Of course,  $A, B, C, \dots, D, E, F, \dots$  are the charges of  $a, b, c, \dots, d, e, f, \dots$ .) If you remember the race to pick your opponent's flowers in Hackenbush Hotchpotch, you'll see that the *ordinary* sum of

$$L_1 \cdot \uparrow + L_2 \cdot \uparrow + L_3 \cdot \uparrow + \dots + R_1 \cdot \uparrow + R_2 \cdot \uparrow + R_3 \cdot \uparrow + \dots + \star$$

behaves just like the *galvinized* sum

$$l_1 + l_2 + l_3 + \dots + r_1 + r_2 + r_3 + \dots,$$

which is therefore a win for

	Left	Right	or	the first player
according as $X = L_1 + L_2 + L_3 + \dots + R_1 + R_2 + R_3 + \dots$ satisfies	$X \geq 1$	$X \leq -1$	or	$-1 \triangleleft X \triangleleft 1$

Because our electric charges are closely related to atomic weights, this simple version of the theory only applies when the games are such that a player always has a legal move in each of his opponent's games which has not yet ended. However it *does* apply to all impartial games and provides a simple proof of Fred Galvin's nice theorem that when  $l_1$  and  $r_1$  are the same impartial game, then their galvanized sum is a first player win.

## Trading Triangles

Trading Triangles is a simple example. Each player has a number of heaps and may reduce the size of a heap belonging to either player by any one of the triangular numbers

$$1, 3, 6, 10, 15, 21, \dots$$

Using  $T_n$  for the electric charge of a Left-owned heap of size  $n$ , we find, for instance,

$$\begin{array}{l} T_0 \\ T_1 \\ T_2 \\ T_3 \\ T_4 \\ T_5 \\ T_6 \end{array} \quad \begin{array}{l} 0 \\ \text{"}\{0-2 \mid 0+2\}\text{"} = 1 \\ \text{"}\{1-2 \mid 1+2\}\text{"} = 2 \\ \text{"}\{2-2, 0-2 \mid 2+2, 0+2\}\text{"} = 1 \\ \text{"}\{1-2, 1-2 \mid 1+2, 1+2\}\text{"} = 2 \\ \text{"}\{2-2, 2-2 \mid 2+2, 2+2\}\text{"} = 3 \\ \text{"}\{3-2, 1-2, 0-2 \mid 3+2, 1+2, 0+2\}\text{"} = 1\frac{1}{2} \end{array}$$

-----

$$\begin{array}{l} T_0 \\ T_1, T_2 \\ T_3 \text{ to } T_5 \\ T_6 \text{ to } T_9 \\ T_{10} \text{ to } T_{14} \\ T_{15} \text{ to } T_{20} \\ T_{21} \text{ to } T_{27} \\ T_{28} \text{ to } T_{35} \\ T_{36} \text{ to } \dots \end{array} \quad \begin{array}{l} 0 \\ 1 \ 2 \\ 1 \ 2 \ 3 \\ 1\frac{1}{2} \ 2 \ 3 \ 2 \\ 1 \ 2 \ 3 \ 2 \ 3 \\ 1\frac{1}{2} \ 2 \ 3 \ 2 \ 3 \ 2 \\ 1 \ 2 \ 3 \ 2 \ 2 \ 3 \ 2 \\ 1 \ 2 \ 3 \ 2 \ 3 \ 3 \ 2 \ 3 \\ 1\frac{1}{2} \ 2 \ 2 \ \dots \end{array}$$

Is there a simple rule? The most famous entry in Gauss's diary is that for 1796 July 10 which reads

$$\text{ETPHKA!} \quad \text{num} = \triangle + \triangle + \triangle.$$

which we know to mean that it was on that day that the Prince of Mathematicians finally established that every whole number can be represented as the sum of at most three triangular numbers. Every triangular number we have calculated so far has charge 0 or 1 (this happens for 0,1,3,10,21,28,...) or  $1\frac{1}{2}$  (which happens for 6,15,36,...). Let's call these two classes of triangle

**acute** (charge 0 or 1), and  
**obtuse** (charge  $1\frac{1}{2}$ ).



Then we can prove that until a charge 4 first appears, the charge of a *non*-triangular number is the least number of triangles, *not all obtuse*, that are needed to represent it, and moreover that a triangular number is obtuse if and only if there is a move from it to some heap of charge 3. Although we haven't yet seen a charge of 4, because most triangular numbers are obtuse it seems likely that eventually one will appear and sometime thereafter we might expect other new charges such as  $2^*$ ,  $2\frac{1}{2}$ , etc. We can't even be sure that the charges don't tend to infinity!

You can play a similar game, **Squandering Squares**, in which the heap must be reduced by perfect square amounts. In this case a greater variety of charges shows itself almost immediately.

	$S_0$		$0$
$S_1$ to $S_3$			1 2 3
$S_4$ to $S_8$			$1\frac{1}{2}$ 2 3 4 3
$S_9$ to $S_{15}$			$1\frac{1}{2}$ 2 3 4 3 3 4
$S_{16}$ to $S_{24}$			$2^*$ 2 3 3 3 3 4 4 4
$S_{25}$ to $S_{35}$			$2^*$ $2\frac{1}{2}$ 3 4 3 3 4 4 3 3 3
$S_{36}$ to $S_{48}$			$2^*$ $2\frac{1}{2}$ 3 4 3 3 3 4 4 3 3 4 5
$S_{49}$ to $S_{63}$			3 2 2 3 4 3 3 4 4 4 3 3 4 4 4 4
$S_{64}$ to $S_{80}$			3 2 $2\frac{1}{2}$ 3 4 3 3 4 4 4 $3\frac{1}{4}$ 3 3 4 4 4 4 4
$S_{81}$ to $S_{99}$			$2^*$ $2\frac{1}{2}$ 3 4 3 3 4 5 4 3 3 4 4 4 4 5 4 3 3
$S_{100}$ to $S_{120}$			3 2 $2\frac{1}{2}$ 3 4 $3\frac{1}{4}$ $3\frac{1}{2}$ 4 4 4 3 3 4 5 4 3 4 4 3 4 4 4
$S_{121}$ to $S_{143}$			3 2 $2\frac{1}{2}$ 3 4 3 3 4 4 4 3 3 4 4 4 4 4 4 3 4 4 4 4 5
$S_{144}$ to ...			3 2 $3^*$ 3 4 $3\frac{1}{4}$ 3 3 4 4 3 3 4 ...

# Extras

## Multiples of Positive Games

The atomic weight theory is concerned with approximating games by multiples of the basic unit,  $\uparrow$ . In fact we can define multiples  $G \cdot U$  taking any positive game  $U$  as the unit. For *integer* multiples we can of course use the obvious definitions, for example

$$2 \cdot U = U + U, \quad (-4) \cdot U = -U - U - U - U \quad \text{and} \quad 0 \cdot U = 0$$

For *non-integer* multipliers, Simon Norton's ingenious definition makes essential use of the **incentives**

$$I = U^L - U \text{ or } U - U^R$$

of  $U$ . Recall from Chapter 6 that incentives are always  $\leq 0$ . Norton's definition is

$$G \cdot U = \{G^L \cdot U + (U + I_1), G^L \cdot U + (U + I_2), \dots \mid G^R \cdot U - (U + I_1), G^R \cdot U - (U + I_2), \dots\}$$

where  $I_1, I_2, \dots$  are the distinct incentives.

Fortunately most choices for  $U$  have a unique largest incentive  $I$  and then we can simplify Norton's formula:

$$G \cdot U = \{G^L \cdot U + (U + I) \mid G^R \cdot U - (U + I)\}$$

For example, for

$$U = \uparrow = 0 \mid *$$

the incentives are

$$0 - \uparrow = \downarrow \quad \text{and} \quad \uparrow - * = \uparrow *$$

so that  $I = \uparrow *$  is the dominant incentive, and since

$$U + I = \uparrow \uparrow *$$

we recover the definition for the multiples of  $\uparrow$ :

$$G \cdot \uparrow = \{G^L \cdot \uparrow + \uparrow * \mid G^R \cdot \uparrow + \downarrow *\}$$

Remember, you must *only* use Norton's definition for *non-integer*  $G$ .

## Multiples Work!

There are quite a lot of things about multiples to be proved:

<b>Independence of form:</b>	If $A = B$ , then $A \cdot U = B \cdot U$
<b>Monotonicity:</b>	$A \geq B$ if and only if $A \cdot U \geq B \cdot U$
<b>Distributivity:</b>	$(A + B) \cdot U = A \cdot U + B \cdot U$





Fortunately these follow easily from the trivial observation that

$$(-G) \cdot U = -G \cdot U$$

and the remark that you can play the games

$$A + B + C + \dots \quad \text{and} \quad A \cdot U + B \cdot U + C \cdot U + \dots$$

in roughly the same way, except that a sum  $U+I$  changes hands with each move.

So, if, *with* the move, you can win the left-hand sum, then, again with the move, you can win the right hand sum when  $U+I$  has been subtracted:

$$A+B+C+\dots \geq 0 \text{ implies } A \cdot U + B \cdot U + C \cdot U + \dots - (U+I) \geq 0$$

#### The WITH Rule

*Without* the move you can win the right-hand sum whenever you can win the left-hand one

$$A+B+C+\dots \geq 0 \text{ implies } A \cdot U + B \cdot U + C \cdot U + \dots \geq 0$$

#### The WITHOUT Rule

Since multiplications by integers obviously work, it's best to concentrate on the *non-integers* among  $A, B, C, \dots$ . When we've made a move in any of the non-integers we'll regard the problem as simpler even when some of the integer multipliers have increased. We suppose, of course, that all simpler cases have been established.

### First for the "With" Rule

*If all of  $A, B, C, \dots$  are integers*, the condition  $A+B+C+\dots \geq 0$  tells us that their sum is at least 1, and so

$$A \cdot U + B \cdot U + C \cdot U + \dots \geq U$$

and this is  $\geq U+I$  since incentives are always  $\geq 0$ .

*If one of them is a non-integer*, then one of the good moves from  $A+B+C+\dots$  is from a non-integer component,  $A$ , say, and we have

$$A^L + B + C + \dots \geq 0$$

Since this is a simpler case we already know that

$$A^L \cdot U + B \cdot U + C \cdot U + \dots \geq 0$$

by the WITHOUT Rule, and this provides us with the desired good move from

$$A \cdot U + B \cdot U + C \cdot U + \dots - (U+I)$$

to

$$A^L \cdot U + (U+I) + B \cdot U + C \cdot U + \dots - (U+I) \geq 0.$$

## Now for the “Without” Rule:

Given that Right has no good move from

$$A + B + C + \dots$$

we must show that he has no good move from

$$A \cdot U + B \cdot U + C \cdot U + \dots$$

If he moves from a term  $A \cdot U$  for which  $A$  is a *non-integer*, he gets to

$$A^R \cdot U - (U+I) + B \cdot U + C \cdot U + \dots$$

which is  $\Vdash 0$  by the WITH Rule, since we know that

$$A^R + B + C + \dots \Vdash 0.$$

If  $A$  was an *integer*, then  $A \cdot U$  has the form

$$U + U + U + \dots \quad \text{or} \quad -U - U - U - \dots$$

according as  $A \geq 0$  or  $A \leq 0$ , and Right’s move replaces this by

$$U^R + U + U + \dots \quad \text{or} \quad -U^L - U - U - \dots$$

which we can rewrite as

$$(U^R - U) + A \cdot U \quad \text{or} \quad (U - U^L) + A \cdot U$$

Left is therefore faced with

$$A \cdot U + B \cdot U + C \cdot U + \dots - I = (A+I) \cdot U + B \cdot U + C \cdot U + \dots - (U+I)$$

for some incentive  $I$ . But since

$$A + B + C + \dots \geq 0 \quad \text{implies} \quad (A+1) + B + C + \dots > 0$$

we have

$$(A+1) \cdot U + B \cdot U + C \cdot U + \dots - (U+I) \Vdash 0$$

by a case of the WITH Rule that we’ve already proved, despite the fact that the integer  $A$  has been replaced by  $A+1$ .

When we deduce the WITH Rule from the WITHOUT Rule we always strictly simplify at least one of the *non-integer* multipliers. When we deduce the WITHOUT Rule from the WITH Rule, we don’t make the non-integer multipliers any more complicated and it doesn’t matter what happens to the integer ones.



## Shifting Multiples Of Up By Stars

Recall from Chapter 6 that every non-zero game  $G$  has some incentive  $G^L - G$  or  $G - G^R$  which is at least  $-1$ , and if  $G$  is a non-integer both players have such incentives. We'll use this to show that the formula

$$G \cdot \uparrow = \{G^L \cdot \uparrow + \uparrow * \mid G^R \cdot \uparrow + \downarrow *\}$$

for non-integer  $G$  can be translated by any number, i.e.

$$G \cdot \uparrow + *N = \{G^L \cdot \uparrow + \uparrow * + *N \mid G^R \cdot \uparrow + \downarrow * + *N\}$$

### THE STAR-SHIFTING PRINCIPLE

For in the difference

$$\{G^L \cdot \uparrow + \uparrow * + *N \mid G^R \cdot \uparrow + \downarrow * + *N\} - G \cdot \uparrow + *N$$

the only moves without exact counters are those from  $*N$ . If Right makes such a move, Left can respond with a move to a position

$$G^L \cdot \uparrow + \uparrow * + *N - G \cdot \uparrow + *N' = (G^L - G) \cdot \uparrow + \uparrow * + *N + *N'$$

which is positive if  $G^L - G \geq -1$ .

For non-integer  $G$ , the Star-Shifting Principle gives us the formula

$$(G \cdot \uparrow + \uparrow * + \star) = \left\{ (G^L \cdot \uparrow + \uparrow *) + \uparrow * + \star \mid (G^R \cdot \uparrow + \downarrow *) + \uparrow * + \star \right\}.$$

which we used earlier in the chapter.

If  $G$  is an integer you can read off the simplest form of  $G \cdot \uparrow + *N$  from Table 3 of Chapter 3. In particular

$$\uparrow + \star = \{0 \mid \star\}, \quad \uparrow * + \star = \{0 \mid \uparrow + \star\}, \quad 3 \cdot \uparrow * + \star = \{0 \mid \uparrow + \star\}, \quad \dots$$

## A Theorem on Incentives

In an all small game  $g$ ,  
other than  $0, *, *2, \dots$ ,  
at least one player has  
at least one incentive with  
at least one for its  
atomic weight.

### THE AT-LEAST-ONE THEOREM

For let  $g$  have atomic weight  $G$ . We again use the fact that, unless  $G = 0$ , it has some incentive  $\geq -1$ .

If

$$G = \{A-2, B-2, C-2, \dots \mid D+2, E+2, F+2, \dots\}$$

and, say,

$$(A-2) - G \geq -1$$

then  $g$ 's incentive

$$a-g \text{ has atomic weight } \geq 1$$

If  $G$  is defined as the greatest integer

$$\triangleleft \mid D+2, E+2, F+2, \dots$$

then we can suppose

$$G+1 \geq D+2$$

and the incentive

$$g-d \text{ has atomic weight } \geq 1$$

[Similarly if  $G$  was defined to be the least integer  $\triangleleft \mid A-2, B-2, C-2, \dots$ ]

Finally, if  $G = 0$  then both players have good moves from

$$g + \star$$

If either of these is from the component  $G$  we are finished, for if, say,

$$a > \star \text{ then } A \geq 1$$

and so the atomic weight of  $a-g$  is at least 1. Otherwise both good moves are from  $\star$ , to  $*m$  and  $*n$  say, and we have

$$*m \leq g \leq *n$$

so that  $g$  must coincide in value with both  $*m$  and  $*n$ .

We have only restricted the theorem to the all small games so that we can use the Atomic Weight Calculus. In fact it holds for *all* games whose values are *not* of the form

$$x, \quad x+*, \quad x+*2, \quad \dots$$

for some number  $x$ . It has a very simple consequence which doesn't even mention atomic weight:

Every game  $g$  which isn't a number  
has an incentive  $\geq$  one of the stars  
 $*, *2, *3, \dots$

#### THE STAR-INCENTIVE THEOREM

For, any incentive of atomic weight  $\geq 1$  exceeds in particular all the *remote* stars, and if  $g = x+*m$ , the move to  $x$  has incentive  $*m$ .



### Seating Families of Five

After their disastrous experience in organizing the children's party at the end of Chapter 5, Left and Right thought it more prudent to invite the parents to their next children's party. Each of the families they invited consisted of 3 children, a mother and a father, and to preserve the peace the children in each family were to be seated between their parents. Left preferred to arrange his families in the order

Mother, child, child, child, Father,

while Right preferred the opposite order. But to preserve another kind of decorum, no two grownups of opposite sexes were to occupy adjacent chairs.

$n$	0	1	2	3	4	5	6	7	8	9	10	11	12	13	14
$LnL$	-	0	0	0	0	-1	-1	*	*	*	*	↓*	↓*	*2	↓
$LnR$	0	0	0	0	0	0	*	*	*	*	*	*	*2	*2	*2
$RnR$	-	0	0	0	0	1	1	*	*	*	*	↑*	↑*	*2	↑

**Table 3.** Values for Seating Families of Five.

In the analysis we used the same kind of notation as we did for Seating Couples (Chapter 2) and Seating Boys and Girls (Chapter 5). But this time (Table 3) we see Greek crosses which suggest the following identities

$$\begin{array}{ccccccc}
 -F_k = L(3k-1)L = & & L(3k)L & & L(3k+1)L & & \\
 & & & & = & & \\
 & & L(3k)R & = & L(3k+1)R = & L(3k+2)R & = D_k \\
 & & & & = & & \\
 F_k = R(3k-1)R = & & R(3k)R & & R(3k+1)R & & 
 \end{array}$$

These can be proved to persist and indeed  $D_k$  is the Dawson's Kayles value you met in Chapter 4, so that  $LnR$  is Triplicate Dawson's Kayles. We can also show that

$$D_{k-1} \leq F_k \leq D_k$$

$k$	1	2	3	4	5	6	7	8	9	10	11	12	13	14	15	16	17	
$F_k$	0	1	*	$\uparrow_0$	$\uparrow_1$	$\uparrow_1$	$\uparrow_{02}$	*	$\uparrow_3$	$\uparrow_1$	$\uparrow_{12}$	$\uparrow_0$	$\uparrow_{03}$	$\uparrow_{13}$	$\uparrow_{12}$	$\uparrow_2$	$\uparrow_{034}$	
$F_{k+17}$	$\uparrow_{03}$	$\uparrow_{15}$	$\uparrow_{12}$	$\uparrow_{24}$	$\uparrow_3$	$\uparrow_3$	$\uparrow_{025}$	$\uparrow_{12}$	$\uparrow_{14}$	$\uparrow_{03}$	*	$\uparrow_2$	$\uparrow_{12}$	$\uparrow_{13}$	$-1$	$\uparrow_0$	$\uparrow_{04}$	$\uparrow_{1235}$
$F_{k+34}$	$\uparrow_{125}$	$\uparrow_{2347}$	*	$\uparrow_{06}$	$\uparrow_{15}$	$\uparrow_{125}$	$\uparrow_{024}$	*	$\uparrow_{36}$	$\uparrow_{15}$	$\uparrow_{12}$	$\uparrow_{04}$	$\uparrow_{03}$	$\uparrow_{13}$	$\uparrow_{12}$	$\uparrow_2$	$\uparrow_{0134}$	
$F_{k+51}$	$\uparrow_{034}$	$\uparrow_{015}$	$\uparrow_{125}$	$\uparrow_{124}$	$\uparrow_{34}$	*	$\uparrow_{025}$	$\uparrow_{125}$	$\uparrow_{145}$	$\uparrow_{034}$	*	$\uparrow_{236}$	$\uparrow_{125}$	$\uparrow_{123}$	$\uparrow_0$	$\uparrow_{04}$	$\uparrow_{1235}$	

**Table 4.** Stars, Superstars and Other Fancy Forms Found in Seating Families of Five.

Our extended table for  $F_k$  (Table 4) shows that most of them have the form

$$\{ *a, *b, *c, \dots \mid * \alpha, * \beta, * \gamma, \dots \}$$

The value of this game is

$$\begin{array}{ccc} \uparrow_{\alpha\beta\gamma\dots} & *m = * \mu & \downarrow^{abc\dots} \\ \text{according as} & m > \mu & m = \mu & m < \mu \\ \text{where } m = \text{mex}(a, b, c, \dots), \mu = \text{mex}(\alpha, \beta, \gamma, \dots) \end{array}$$

The game  $\downarrow^{abc\dots}$  is the negative of  $\uparrow_{abc\dots}$ . The game  $\uparrow_{abd\dots}$  is the typical **superstar**; it has atomic weight 1 and simplest form

$$\uparrow_{abc\dots} = \{0, *, \dots, *(m-1) \mid *a, *b, *c, \dots\}, \quad \text{where } m = \text{mex}(a, b, c, \dots)$$

but the value does not change if Left is given arbitrarily many extra number options.

We have

$$\uparrow_{abc\dots} \parallel *a, \quad \uparrow_{abc\dots} \parallel *b, \quad \uparrow_{abc\dots} \parallel *c, \dots$$

and otherwise

$$\uparrow_{abc\dots} > *n$$

There is a **Restricted Translation Rule**:

If  $A, B, C, \dots$  are  $a \dagger n, b \dagger n, c \dagger n, \dots$  in some order and  $n$  is the least number with this property, then

$$\uparrow_{ABC\dots} = \uparrow_{abc\dots} + *n$$

If there is just one subscript,

$$\uparrow_0 = \uparrow^*, \quad \uparrow_1 = \uparrow, \quad \uparrow_2 = \uparrow + *3, \quad \uparrow_3 = \uparrow + *2, \quad \uparrow_4 = \uparrow + *5, \quad \dots$$

These properties of superstars, together with our theorems about atomic weights, dramatically simplify the calculations for Seating Families of Five. We imagine that the pattern of subscripts in Table 4 will eventually share in the general period of 102, making a complete analysis possible.



The symbols  $\uparrow_{abc\dots}^-$  denote games obtained from  $\uparrow_{abc\dots}$  by giving Right some (unimportant) extra moves, namely

from	$F_{31}$	$F_{33}$	$F_{45}$	$F_{48}$	$F_{65}$	$F_{67}$
to	$\uparrow_{13}$	$\uparrow_{047}$	$\uparrow_{126}, \uparrow_{1235}$	$\uparrow_{135}, \uparrow_{0137}$	$\uparrow_{1235}, \uparrow_{1235}$	$\uparrow_{0457}, \uparrow_{0467}$

There's a similar game, **Seating Families of  $N$** , for any  $N$ , with the property that either player, on seating a family, effectively reserves the two adjacent seats for his opponent. These games are cool and have mostly infinitesimal values. In Seating Families of

	2	5	8	11	...
the values for the positions $L_nR$ are those of the octal games	$\cdot 7$	$\cdot 07$	$\cdot 007$	$\cdot 0007$	...

each repeated three times. The  $L_nR$  values for families of

$$3, 4, 6, 7, 9, 10, 12, \dots$$

are also nimbers, but the rule for generating them is more complicated.

These values can be shown to be nimbers using the easy little theorem that if

$$-a \leq a, \quad -b \leq b, \quad -c \leq c, \quad \dots$$

then

$$\{-a, -b, -c, \dots \mid a, b, c, \dots\} = *m$$

where  $m$  is the least number for which  $*m$  is distinct from all the games  $a, b, c, \dots$ .

There's another series of games in which the players seat teams of  $n$  boys or  $n$  girls, effectively reserving adjacent seats for themselves. Seating Boys and Girls is the case  $n = 1$ . Omar will find that the other cases provide useful exercises in thermography (Chapter 6).

## References

J. H. Conway, *On Numbers and Games*, Second Edition, A K Peters, Ltd., 2001, Chapters 15 and 16.  
 Stephen Brian Grantham, *An Analysis of Galvin's Tree Game*, PhD thesis, Univ. of Colorado, 1982.  
 Stephen Brian Grantham, *Galvin's 'racing pawns' game and a well-ordering of trees*, *Memoirs Amer. Math. Soc.*, **53**(1985) No. 316.

# Index

- accounts-payable, 127
- action, in hottest game, 167
- active position, 149, 150
- acute triangles, 254
- Adams, E. W., 117
- addition of games, 31, 32
- addition of switches, 122
- addition, nim-, 58, 59, 73, 74, 90, 109, 110, 116, 199, 246
- addition, ordinal, 220
- addition, two kinds, 191
- additives of no atomic weight, 225
- adjacency matrix, 222
- Air on a  $\mathcal{G}$ -string, 96
- Alice in Wonderland, 1, 56, 57, 229
- all small games, 229, 230
- alternating moves, 46, 47
- Althöfer, I., 86, 117
- amazing jungle, 208
- Amazons, 15, 16
- ambient temperature, 164, 165, 188
- anatomy of Toads-and-Frogs, 63
- Andersson, Göran, 119
- animals, dead, 135
- animals, tracking, 202
- annihilation games, 224
- Argument, Poker-Nim, 55, 56
- Argument, Snakes-in-the-Grass, 191
- Argument, Tweedledum and Tweedledee, 2, 3, 35, 72
- arithmetic periodicity, 99, 113–117, 144
- arithmetically periodic, 187
- asymmetrical heating, 173
- atom, 229
- atomic weight = uppitness, 200–202, 204, 206, 208, 209, 211, 220–222, 225, 230–232, 234, 236–240, 242–244, 246, 248, 251, 253, 256, 258, 259, 261
- atomic weight calculus, 231, 232, 234, 237, 239, 242, 247, 249, 256, 259
- atomic weight of lollipops, 238
- atomic weight of numbers and of up, 232
- atomic weight properties, 236
- atomic weight rules, 242
- atomic weight, eccentric, 231, 232, 237, 251
- atomic weight, fractional, 234, 236
- Austin, Richard Bruce, 52, 96, 109, 117
- average versus value, 10
- averages, playing the, 167, 173
- Bültermann, J., 86, 117
- Backgammon, 14
- bad move, 16
- bad moves, 16
- ball, officers', 96
- Ball, W. W. Rouse, 117
- Baron, J. G., 52
- Baseball, 15
- Basketball, 15
- battle, 3





- battle, hot, 145
- battle, Nim-like, 230
- Battleships, 15
- Beasley, John D., 18
- bed, redwood, 211, 213–217, 222
- Benson, E. C., 117
- Berge, Claude, 78
- Berlekamp's Rule, 77, 78
- Berlekamp, Elwyn Ralph, 16, 18, 77, 78, 123, 144, 187, 188, 224, 225
- Bicknell-Johnson, Marjorie, 79
- big game, 65, 75, 202, 206, 222
- binary (base 2), 73
- bipartite graph, 217, 224
- Black, Farmer, 145, 146
- Blass, U., 78
- Blockbusting, 187
- blossom, 198, 199, 240
- bLue edge, 2, 198, 230, 237
- bLue edges, 2
- Blue Flower Ploy, 199, 201, 240, 242
- Blue Jungle Ploy, 201, 210
- bLue tinted nodes, 48
- blue tinted nodes, 204
- Blue-Red Hackenbush, 1–6, 15–17, 20, 22, 27, 29–33, 35, 36, 42, 77, 179, 198, 200, 211–217, 224
- Bodlaender, H.L., 225
- Bodlaender, H. L., 117
- bogus Nim-heap, 56
- Bond, James = **007**, 95
- bottle, 218, 225
- boundary, 158
- boundary, Left, 154–156, 164, 169
- boundary, left, 165
- boundary, Right, 154–156, 164, 169, 170
- Bouton, Charles L., 42, 52, 78
- breakthrough, 188
- Breuker, D. M., 144
- Bridge, 15
- bridge, 190, 194–196
- bulls, 145, 146
- Bushaw, Donald W., 52
- Bynum's Game = Eatcake, 136, 234
- Bynum, James, 136, 234
- bypassing reversible options, 60, 62–64, 66, 70, 71, 75, 77
- Byrom, John, 53
- Byron, Henry James, 81
- Caines, Ian, 117
- cake, 26, 51, 196, 220, 221
- Calculus, Atomic Weight, 231, 232, 234, 237, 239, 242, 247, 249, 256, 259
- Calistrate, Dan, 188
- canonical forms for numbers, 22
- card sharp, 16
- cards, shuffling, 14
- Carroll, Lewis, 229
- cash flow, 126
- Cashing Cheques, 122–124, 145, 158, 159, 240
- ceiling, 51
- Celoni, James R., 226
- centralizing switches, 123
- chain, green, 40
- chain, Snort, 147, 149–151, 153, 156–158, 161, 167, 168, 177, 180–183
- chair, redwood, 211
- chalk-and-blackboard game, 1
- chance moves, 14
- Chandra, Ashok K., 224, 227
- change, phase, 167, 168
- charge, electric, 253, 254
- Checkers, 18
- Checkers = Draughts, 224, 226, 227
- cheque-market exchange, 158, 159
- Chess, 14, 18, 224, 226
- Chess, Dawson's, 89–92, 101, 109
- Childish Hackenbush, 43, 52, 157
- Childish Hackenbush Hotchpotch, 236–238
- childish lollipops, 237–240
- childish picture, 43
- children's party, 132, 179
- chilling, 187
- China, 16
- Chytie, M.P., 227
- class, outcome, 28, 84
- cloud, 31, 36, 121, 149, 150
- coalitions, 15
- code digits, 92, 93, 99, 101, 103–105, 107, 108, 113, 117
- Coinage, Sylver, 15
- coins, 123, 124
- Col, 38, 39, 47–51, 67, 68, 75, 145, 224

- colon notation, 243, 244  
 Colon Principle, 191, 193, 194, 220  
 coloring, 38, 145, 147, 187  
 common coset, 110  
 common values, 110  
 comparing games, 35, 36, 122  
 compendium, 109  
 complete in exponential time, 225  
 complete in Pspace, 224  
 complete information, 14  
 component, 20, 22, 31, 32, 35  
 compound game, 31  
 compound thermograph, 164  
 computing power, 163  
 confused, 31, 68, 69, 71  
 confusion interval, 121, 149–151, 158, 163  
 conjecture, 112  
 Connell, Ian G., 78  
 contract, 126  
 convention, normal play, 14  
 Conway, John Horton, 18, 22, 52, 78, 117, 123, 144, 188, 225, 262  
 Cook, Stephen A., 224, 225  
 cooling, 151, 152, 154, 167, 179, 231  
 cooling formula, 151  
*Corinthians I*, 13.12, 69  
 coset, common, 110  
 cost, 161  
 counters, heaps of, 41  
 Couples, Seating, 44, 45, 132, 133  
 cousin, 101, 103–105, 107, 109, 114, 116  
 Cowley, Abraham, 119  
 cows, 145–147  
 Coxeter, Harold Scott Macdonald, 78, 117  
 Cram, 142  
 Cram = Impartial Domineering, 142, 144  
 Cricket, 15  
 criminal, minimal, 194, 214  
 critical temperature, 167, 168, 171  
 Crosscram = Domineering, 119  
 cucle, 213  
 Cutcake, 25, 26, 31, 32  
 Cutcake, Hickerson's, 51  
 cycles, 192–194, 214  
  
 Dawson's Chess = ·137, 89–92, 101, 109  
 Dawson's Kayles, 261  
 Dawson's Kayles = ·07, 15, 90, 93, 95, 101, 109  
 Dawson, Thomas Rayner, 89, 117  
 dead animals, 135  
 Death Leap Principle, 127–130, 135  
 deleting dominated options, 62, 63, 75, 77  
 delphinium, 47, 199, 242  
 Demaine, Eric, 225  
 Demaine, Martin, 225  
 Descartes, Blanche, 96, 117  
 devil's label, 195  
 dice, rolling, 14  
 Difference Rule, 74  
 digits, code, 92, 93, 99, 101, 103–105, 107, 108, 113, 117  
 dilemma, 132  
 Dim, 98  
 disarray, 95  
 discount, 161  
 disguise, 95  
 disincentive, 147, 148  
 dissection, 128, 129, 134  
 dissociation, thermal, 168  
 Dodgson, Charles Lutwidge, 1, 229  
 dog with leftward leanings, 4  
 dominated option, 62, 63, 75, 77, 126, 149  
 Domineering, 178, 187  
 Domineering = Crosscram, 119–122, 139, 142, 144, 153, 177  
 Domineering, Impartial = Cram, 142, 144  
 Dominoes, 119  
 Dominoes = Domineering, 119  
 Don't-Break-It-Up Theorem, 213, 214, 216  
 Dots-and-Boxes, 15, 95, 225  
 Double Duplicate Nim, 114  
 Double Kayles, 99  
 double-down,  $\Downarrow$ , 68, 69, 71  
 double-up,  $\Uparrow$ , 68, 69, 71  
 double-up,  $\Uparrow$ , 230  
 doubling of nim-values, 94  
 down,  $\Downarrow$ , 68, 151  
 down,  $\Downarrow$ , 63–65  
 down-second, 236  
 down-third, 236  
 downstar, 66, 242  
 drawn, 14



- Dress, Andreas, 117  
 Dudeney, Henry Ernest, 82, 117  
 Duplicate Kayles, 99  
 Duplicate Nim, 114, 116  
 duplication of nim-values, 94, 98, 99, 114, 116  
 Duvdevani, N., 79
- Eatcake = Bynum's Game, 136, 234  
 Eatcakes, 234  
 eccentric cases of atomic weights, 231, 232, 237, 239, 249, 251  
 economy, underlying, 151  
 edges, 40, 43, 135  
 edges for moves, 40  
 edges, bLue and Red, 2–6, 29, 30, 77, 198, 201, 230, 237  
 edges, grEen, 29, 30, 33, 40, 41, 190–196, 198–202, 204–206, 210, 211, 218, 220, 221, 225, 237, 251  
 Ehrenborg, R., 117  
 electric charge, 251, 253, 254  
 Elkies, Noam D., 14, 18, 79  
 empty set, 82  
 endgames, Go, 187  
 ending condition, 14, 35, 46, 47  
 enlarged flow, 204  
 Enough Rope Principle, 16  
 Epp, R. J., 117  
 Eppstein, David, 225  
 equably favorable, 35  
 equally uppity, 242, 245  
 equitable, 157–161, 169–172  
 Erickson, Jeff, 138, 144  
 eternal games, 46  
 Even, Shimon, 224, 225  
 evil numbers, 110  
 Ex-Officers Game = -06, 101, 103  
 exactly periodic, 86  
 exceptional values, 90–92, 101, 108  
 Exchange Principle, 246  
 excitable, 157–161, 169–172  
 excluded values, 111  
 exemptions, tax, 151  
 explosive nodes, 49, 50  
 exponential time algorithms, 224  
 extended thermograph, 161, 162  
 Extras, 14, 46, 73, 101, 134, 180, 220
- fairy chess, 117  
 favorite, 262  
 Ferguson's Pairing Property, 86  
 Ferguson, Thomas S., 86, 117  
 field, 145  
 fine print, 126  
 finicky look, 91  
 first cousin, 101, 103–105, 107, 109, 114, 116  
 first player wins, 28–30  
 fit, 22, 251  
 Flammenkamp, Achim, 86, 112, 117  
 floor, 51, 75  
 flow, 202, 204–206, 208, 209, 222  
 flow method, 238  
 Flow Rule, 201, 202, 204, 210  
 flow, cash, 126  
 flower, 29, 30, 33, 35, 36, 47, 66, 67, 190, 195, 199–201, 210, 230, 240, 242, 245, 246  
 flower garden, 190, 199, 229, 230, 240  
 flowerbed, 242, 244, 246  
 flowerbed should be posy, 33  
 flowerstalk = stem, 36  
 foot, 211, 212  
 Ford, Lester R., 205, 212, 225  
 forest, 33, 34  
 form, canonical, 22  
 form, simplest, 22  
 form, standard, 101, 103–105, 107–109, 114  
 Formula, Cooling, 151  
 foundations for thermographs, 155  
 Fox-and-Geese, 15  
 fractional atomic weight, 234, 236  
 fractional multiples, 256  
 Fraenkel, Aviezri S., 18, 78, 224, 226  
 freezing point, 154, 168–172  
 French Military Hunt, 15  
 Fulkerson, Delbert Ray, 205, 212, 225  
 function, mating, 193  
 function, ruler, 98  
 function, Welter, 193  
 furniture, redwood, 211, 212, 213–217, 222  
 fusion, 192–196  
 fuzzy, 28, 42  
 fuzzy flowers, 29, 30  
 fuzzy games, 28–33, 35, 36, 39, 42, 239  
 fuzzy positions, 28, 32, 33

- Göbel, Fritz, 118  
 Gale, David, 117  
 gallimaufry, 68, 75  
 Galvin, Fred, 253  
 galvanized games, 253, 254  
 game in the jungle, 209  
 game locator, 103, 109, 113  
 game of pursuit, 15  
 game trees, 40  
 Game, big, 65, 75, 202, 206, 222  
 Game, Bynum's = Eatcake, 136  
 game, cold, 145  
 Game, comparisons of, 35  
 Game, compendium, 109  
 Game, compound, 31  
 Game, coolest, 173  
 Game, eating, 136, 234  
 Game, equitable, 157–161, 169, 170, 172  
 Game, eternal, 46  
 Game, Ex-Officers, 101, 103  
 Game, excitable, 157–161, 169–172  
 Game, finite, 46, 115  
 Game, fuzzy, 28–33, 35, 36, 39, 42, 239  
 Game, galvanized, 253, 254  
 Game, Grundy's, 15, 96, 112  
 Game, hard, 211, 217, 223  
 Game, hexadecimal, 116, 117  
 Game, hot, 125, 133, 145–174, 176–185, 187, 225  
 game, identification, 65  
 Game, impartial, 15, 40, 56, 82, 84, 196, 220  
 Game, Kenyon's, 116, 117  
 Game, loopy, 15  
 Game, map-coloring, 38, 145  
 Game, negative of, 33–35  
 Game, Northcott's, 55  
 Game, octal, 101, 103–105, 107–116  
 Game, ordinal sum, 220  
 Game, partizan, 15, 65, 187  
 Game, short hot, 225  
 Game, simplifying, 60, 62, 63, 75, 77  
 Game, subtraction, 84, 86, 87, 98  
 Game, switch, 121–125  
 Game, take-and-break, 81, 82, 84, 86, 87, 89–96, 98, 99, 101, 103–105, 107–117  
 Game, take-away, 82, 84, 86, 87, 98, 101  
 Game, tiniest, 125, 126  
 Game, tracking, 65  
 game, tracking, 222  
 Game, Wythoff's, 15, 60, 74  
 Game, zero, 4, 9, 33, 41  
 game, zero, 28  
 Gamesman's Toolkit, 142, 144  
 Gangolli, Anil, 109, 112, 117  
 garden, 33, 199, 229, 230, 240  
 garden, flower, 190, 199  
 Gardner, Martin, 18, 52, 144  
 Garey, Michael R., 217, 224, 226  
 Gasser, Ralph, 18  
 Gates, Carrie, 117  
 Gauss, Carl Friedrich, 254  
 gee-up, 247  
 Generalized Geography, 224  
 Generalized Hex, 224  
 Generalized Kayles, 224  
 geranium, 47, 199, 242  
 gift horse, 72, 77  
 Gift Horse Principle, 72, 77  
 giraffe, 205, 206  
 glass, magnifying, 151  
 Go, 16, 18, 161, 187, 188, 224, 226  
 Go-Moku, 14  
 Gobang, 226  
 godd, 195, 226  
 godd's label, 195  
 golden number, 75  
 Goldschmidt, E., 226  
 Golomb, Solomon W., 117  
 GONC = *Games of No Chance*, 18, 79, 118, 188, 226  
 good move, 16, 22, 196  
 Good, Irving John, 226  
 graph, 145–147  
 graph, bipartite, 217, 224  
 graph, spanning tree of, 217, 224  
 graphic picture of farm life, 145, 146  
 grass, 40, 42, 199, 240, 242  
 green chain, 40  
 grEen edge, 230  
 green edges, 29, 30, 33, 41, 190–196, 198–202, 204–206, 210, 211, 218, 220, 221, 225, 237, 251  
 green girl, 192, 193  
 green Hackenbush, 39–42, 190–196, 225



- green jungle, 198, 199, 201, 220, 221  
 green shrub, 193  
 green snake, 40  
 green string, 243, 244  
 green tinted nodes, 204  
 green tracks, 202, 204  
 green trees, 191–193  
 greenwood tree, 34  
 greenwood trees, 34  
 grounded cycles, 196  
 grounding cycles, 193  
 grown-up picture, 43  
 Grundy scale, 87, 90, 91, 94, 96, 101  
 Grundy Skayles, 91  
 Grundy's Game, 15, 96, 112  
 Grundy, Patrick Michael, 42, 56, 79, 117, 220, 221  
 Guiles = ·15, 94, 101, 103  
 Guy, Michael John Thirian, 112  
 Guy, Richard Kenneth, 18, 89, 99, 109, 117, 118, 144  
  
 Hackenbush, 1–6, 14, 19, 20, 28, 42, 43, 75, 190–196, 198–202, 204–206, 208–218, 220–222, 224, 225, 240  
 Hackenbush Hotchpotch, 29, 30, 38, 47, 66–68, 198–202, 204–206, 208–211, 225, 230, 238, 251  
 Hackenbush is hard, 211, 217  
 Hackenbush number system, 78  
 Hackenbush picture, 1, 2  
 Hackenbush string, 22, 24, 77, 78, 194, 195  
 Hackenbush, Blue-Red, 1, 2, 4–6, 15, 17, 20, 22, 27, 29–33, 35, 36, 42, 77, 198, 200, 211–217, 224  
 Hackenbush, Childish, 43, 52, 157, 237  
 Hackenbush, Green, 39–42, 190–196, 225  
 half-move, 4, 7, 9, 19, 20  
 halving nim-values, 195  
 Hanner, Olof, 188  
 hard game, 211, 217, 222, 223  
 hard problems, 223–225  
 hard redwood bed, 217, 222  
 hard-headed, 171  
 hardness, 211, 217, 223–225  
 Hawaii, 16  
 Hazlitt, William, 1  
 head, animal's, 205  
 head, girl's, 193, 196  
 head, losing your, 222  
 head, severed, 205, 220–222  
 head, shrunken, 220, 221  
 heat, 125, 132, 145  
 heating, 167, 173  
 heirarchy, 96  
 heptominoes, 139  
   van den Herik, H. J., 144  
 heuristic discussion, 158, 159  
 Hex, 226  
 hexadecimal games, 116, 117  
 hexominoes, 139  
 Hickerson, Dean, 51  
 higher ground, 209  
 Hillman, A. P., 79  
 Hockey, 15  
 Hoey, Dan, 112  
 Hoggatt, Vern E., 79  
 Holladay, John C., 118  
 hollyhocks, 36  
 Honest Joe, 158, 159  
 Horadam, A. F., 79  
 horse, 27, 28  
 horse, gift, 72, 77  
 horse, working out a, 28  
 hot, 125, 133, 145, 149, 151, 171, 173, 225  
 hot battle, 145  
 hot game, 125, 133, 145, 171, 173, 225  
 hot position, 149  
 Hotchpotch, Childish Hackenbush, 236–238  
 Hotchpotch, Hackenbush, 38, 47, 66–68, 198–202, 204–206, 208–211, 225, 230, 238, 251  
 Hotstrat, 188  
 house, 43  
 house and garden, 33  
  
 imminent jump, 9–11  
 impartial, 15, 40, 56, 82, 84, 196, 220  
 impartial Domineering = Cram, 142, 144  
 impartial Maundy Cake, 196  
 incentive, 147, 148, 256–259  
 incomparable, 35  
 induction, 115, 234  
 infinite delphinium, 47  
 infinite geranium, 47  
 infinite play = draw, 14

- infinite repetition, 14  
 infinitesimal, 36, 169, 170, 173, 229  
 infinitesimally close, 151, 152, 154  
 infinitesimally shifted, 177–179, 198  
 infinitesimally small, 158  
 infinitesimals, 171  
 Inglis, Nick, 51  
 integral, 167–174, 176–179  
 interval, confusion, 121, 149–151, 158, 163  
 invoices and cheques, 126  
 irregular values, 90–92, 101, 108, 187  
 ish = Infinitesimally SHifted, 177–179, 198  
 Iverson, K. E., 51
- Japan, 16  
 Johnson, David S., 217, 224, 226  
 jumpee, 11  
 jumper, 9  
 jungle warfare tactics, 210  
 jungle, clearing, 222  
 jungle, green, 198, 201, 220, 221  
 jungle, parted, 201, 202, 209  
 jungle, sliding, 199  
 jungle, sliding , 220, 221  
 jungle, smart game in, 209  
 jungle, tracking, 204  
 jungle, unparted, 210
- Kano, M., 118  
 Kao Kuo-Yuen, 188  
 Karp, Richard M., 217, 224, 226  
 Kayles, 224  
 Kayles = **.77**, 15  
 Kayles = **.77**, 81, 82, 89, 91–93, 95, 99, 110–112  
 Kayles, Dawson's, 261  
 Kayles, Dawson's = **.07**, 15  
 Kayles, Dawson's = **.07**, 90, 93, 95, 101, 109  
 Kayles, Double, 99  
 Kayles, Duplicate, 99  
 Kayles, Quadruple, 99  
 Kayles, Triplicate Dawson's, 261  
 Kenyon's Game, 116, 117  
 Kenyon, John Charles, 109, 115, 118  
 Kim, Yonghoan, 18, 144  
 King, Kimberly, 222  
 kite strategy, 243, 244, 246
- Knight, White, 56–59  
 Knuth, Donald Ervin, 18, 51  
 ko, 16  
 Konane, 16  
 Korea, 16  
 kos, 188  
 Koubek, V., 227  
 Kriegspiel, 15
- Lacrosse, 15  
 Lake, Robert, 18  
 Landman, Harold A., 18  
 Lasker's Nim, 99, 113, 114  
 Lasker, Edward, 99, 118  
 last move, 171  
 last player winning, 2, 9, 12, 14  
 latent heat, 132  
 latent phase change, 168  
 Left, 2  
 Left boundary, 154–156, 164, 165, 169, 170  
 Left excitable, 158, 159  
 Left stop, 149, 150, 152, 161  
 Lefty, 25, 51, 234  
 leg, 211–213, 215, 222  
 Lemma, Norton's, 220, 243, 244  
 Lenstra, Hendrik W., 117  
 Lichtenstein, D., 224, 226  
 Life, 15, 53  
 lightning bolts, 50  
 line, real number, 24  
 lollipops, 237, 238, 240  
 long periods, 109  
 loops, 40  
 loopy game, 15  
 loopy position, 188  
 loopy positions, 16  
 Loyd, Sam, 82, 118  
 lucky star, 246, 249  
 Ludo, 14, 15
- Müller, Martin, 18, 188  
 making tracks, 204  
 management of cash flow, 126  
 many-way Maundy Cake, 220, 221  
 map, 38, 145  
 Markert, D., 225  
 markup, 161  
 mast, 152, 154, 163



- mast value = mean value, 165, 166
- mattress, 215
- Mauhin, Patrick, 27
- Mauldon, James G., 79
- Maundy Cake, 26, 27, 51, 196, 220, 221
- maximal flow, 202, 204–206, 209
- mean value, 149, 151–154, 165–168, 172, 174, 188
- mex = Minimal EXcluded, 56
- mex = Minimum EXcludant, 56, 82
- Mex Rule, 56
- Milnor, John, 188
- Milton, John, 19, 145
- minimal criminal, 194, 214
- minimal spanning tree, 217, 224
- miny, 126–129
- miny- $x$ , 126
- miny-a-quarter, 135
- misère play, 15, 86
- Moews, David, 52, 188, 224
- money, 171
- Monopoly, 15
- Morra, Three-Finger, 15
- Morris, Lockwood, 225
- mountain, purple, 198, 199
- moves, 14, 40
- moves, alternating, 46, 47
- moves, bad, 16
- moves, chance, 14
- moves, equitable and excitable, 161
- moves, five-eighths of a, 20
- moves, good, 16, 196
- moves, half, 4, 19, 20
- moves, hotter, 173
- moves, quarter, 6, 20
- moves, reversible, 55, 56, 60, 62–64, 66, 70, 71, 75, 77, 126, 212, 213
- moves, temperature-selected, 132
- moves, three-quarters, 17
- moves, worthwhile, 213–216
- $m$ -plicate, 98
- multiples of positive games, 256
- multiples of up, 71, 242, 247, 256, 258
- multiples, fractional & non-integer, 236
- multiples, fractional and non-integer, 256
- Munro, Ian, 226
- musical series, 96, 117
- negative, 28
- negative charge, 254
- negative numbers, 19, 147, 148
- negative of a game, 33–35
- negative position, 28
- negative positions, 29, 30, 68
- Neyman, A., 117
- Nim, 15, 40, 42, 53, 55, 56, 114, 173, 191, 240
- Nim in hot games, 173
- Nim, Double Duplicate, 114
- Nim, Duplicate, 114, 116
- Nim, Lasker's, 99, 113, 114
- Nim, Poker, 55
- Nim, Poker-, 53
- Nim, Triplicate, 114, 116
- nim-addition, 58, 59, 73, 74, 90, 109, 110, 116, 191–196, 199, 246
- Nim-Addition Rule, 60
- Nim-Addtion Rule, 59
- Nim-heaps, 41, 42, 56–59, 82
- Nim-heaps, bogus, 56, 57
- Nim-position, 41
- nim-sequence, 82, 84, 86, 87, 94, 98, 99, 101, 103–105, 107–109, 113, 114, 116
- nim-sum, 59, 73, 74, 82, 90, 91, 109–112
- nim-values, 82, 84, 86, 87, 90–96, 98, 99, 110–117, 191–196
- nim-values, doubling, 94
- nim-values, duplication, 94, 98, 99, 114, 116
- nim-values, halving, 195
- nim-values, periodic, 84, 86, 91, 92, 94, 98, 99, 101, 103–105, 107–110, 112–117
- nim-values, reflected, 109
- nim-values, replication, 98
- number, 231, 258
- nimber arithmetic, 42
- numbers, 40–42, 56, 57, 65, 74, 84, 110, 119, 199, 200, 262
- numbers, adding, 42, 58
- node, tinted, 48
- nodes, Col, 47–51
- nodes, explosive, 49, 50
- nodes, game positions, 40
- nodes, Hackenbush, 191–194, 201, 202, 204, 222
- nodes, Snort, 147, 180
- nodes, tinted, 204, 206, 208–210, 222

- nodes, untinted, 204, 209, 210
- non-number, 147, 148, 159, 160
- normal play, 12, 14
- Northcott's Game, 55
- Norton's Lemma, 220, 243, 244
- Norton's product, 247, 256
- Norton, Simon, 145, 168, 188, 247, 256
- Norton, Simon P., 220, 243, 244
- Noughts-and-Crosses = Tic-Tac-Toe, 14
- Nowakowski, Richard Joseph, 18, 117, 118, 144, 188, 225, 226
- NP-complete, 217, 224, 226
- NP-hard, 224, 225
- $\mathcal{N}$ -positions, 84
- Number Avoidance Theorem, 147–149, 183
- number system, Hackenbush, 78
- number tree and line, 24
- numbers, 22, 119
- numbers, canonical form, 22
- numbers, evil, 110
- numbers, negative, 19
- numbers, odious, 110
- numbers, overheated, 176
- numbers, simplest, 19, 21, 22
- numbers, Surreal, 18
- numbers, thermographic thicket of, 176
- numbers, triangular, 254
- numbers, whole, 19
  
- O'Beirne, Thomas H., 79, 118
- obtuse triangles, 254
- octal games, 101, 103–105, 107–116, 262
- odious numbers, 110
- Officers =  $\cdot 6$ , 95
- Omar, 42, 72, 109, 138, 188, 262
- ONAG = *On Numbers and Games*, 18, 22, 48, 52, 78, 117, 139, 144, 188, 193, 225, 234, 236, 262
- One-upmanship Rule, 242
- opposite sex, 179
- option, 14, 154, 155
- option, dominated, 62, 63, 75, 77, 149
- option, Left, 31, 32
- option, reversible, 60, 62–64, 70, 71, 75, 77
- option, Right, 31, 32
- optional extras, 84
- options, worthwhile, 213–215
  
- ordinal addition, 220
- ordinal sum, 220
- ordinary sum, 220, 221
- outcome, 28, 35
- outcome classes, 28, 84
- outcome of sum, 31, 32
- overheating, 174, 176, 187
- overheating operator, 188
- Ozery, M., 79
  
- Pairing Property, Ferguson's, 86
- parcels, 187
- paricles, 167
- parity, 73, 234
- Parity Principle, 191, 194
- parted jungle, 201, 202, 209
- particle, 168–170
- partizan, 15, 65, 187
- paths = tracks, 193, 202, 204, 222
- Patience = Solitaire, 15
- Paul, Wolfgang J., 226
- pawns, 89
- PEEK, 224
- Peg Solitaire, 15
- pencil-and-paper game, 1
- periodicity, 90–94, 99, 101, 109, 113–115, 117, 236
- periodicity, arithmetic, 99, 113–117, 144, 187
- periodicity, Blockbusting, 187
- periodicity, Dawson's Chess, 90, 91
- periodicity, Domineering, 144, 187
- periodicity, Guiles, 94
- periodicity, Kayles, 91, 92
- periodicity, non-arithmetic, 115
- periodicity, octal games, 101, 103–105, 107–109, 113–115
- periodicity, subtraction games, 84, 86
- periodicity, ultimate, 99, 101, 112
- perpetual check = draw, 14
- petal, 33, 47, 66, 67, 199, 201, 240, 245
- petals, 29, 30
- phase change, 167, 168
- phase change, latent, 168
- picture, 1, 2, 192
- picture of farm life, 145, 146
- picture, childish, 43
- picture, grown-up, 43





- piebald node, 47, 48
- piebald spot, 145–147
- Pink, Norbert, 117
- Plambeck, Thane, 109, 112, 117
- play, infinite, 14
- play, misère, 15
- play, normal, 12, 14
- player, first, 28–30
- player, second, 28–30
- playing the averages, 167, 173
- Ploy, Blue Flower, 199, 201, 240, 242
- Ploy, Blue Jungle, 201, 210
- Ploy, Red Jungle, 210
- Poker, 15
- Poker-Nim, 53
- Policy, Temperature, 124, 125, 131, 132
- polyominoes, 139, 142
- poroof, 213
- $\mathcal{P}$ -positions, 84
- position, 14
- position,  $\mathcal{N}$ -, 84
- position,  $\mathcal{P}$ -, 84
- position, active, 149, 150
- position, Domineering, 120, 121, 139, 142, 144, 153, 177
- position, fuzzy, 28, 32, 33
- position, hot, 149
- position, loopy, 16, 188
- position, negative, 28–30, 68
- position, positive, 28, 68
- position, starting, 14
- position, terminal, 2, 7, 28
- position, zero, 3
- position, terminal, 41
- positive, 28
- positive charge, 254
- positive house, 38
- positive house and garden, 33
- positive position, 28
- positive positions, 68
- positive posy, 29, 30, 33
- Prim, 98
- Prince of Mathematicians, 254
- Principle, Bogus Nim-heap, 56
- Principle, Colon, 191, 193, 194, 220
- Principle, Death Leap, 127–130, 135
- Principle, Enough Rope, 16
- Principle, Exchange, 246
- Principle, Fusion, 192–195
- Principle, Gift Horse, 72, 77
- Principle, Parity, 191, 194
- Principle, Star Shifting, 250, 258
- Principle, Translation, 149, 153, 158
- Principle, Uppitiness Exchange, 246
- problems, hard, 223, 224
- profit, 161
- profit-consciousness, 171
- proof, 115, 147, 148, 165, 166, 183, 188, 201, 212, 214, 216, 217, 220, 221, 224, 236, 240, 248–250, 256–259
- Propp, James, 118
- PSPACE-complete, 224, 226
- PSPACE-hard, 224
- purchasing contract, 127
- purple mountain, 198, 199
- pursuit, 15
  
- Quadruple Kayles, 99
- quantity beats quality, 201
- quarter-move, 6, 19, 20
- quotation marks = eccentric cases, 231, 232
  
- rare values, 110–112
- reader, assiduous, 42
- reader, persevering, 90
- reader, skeptical, 130
- real number line, 24
- rectangles, 25–27, 142, 234, 236
- Red edges, 2, 198, 230, 237
- Red Jungle Ploy, 210
- Red tinted nodes, 48, 204
- Red twig, 213
- redwood bed, 211, 213–217, 222
- redwood furniture, 211–217, 222
- redwood tree, 214–217
- redwood twig, 213, 216
- References, 18, 52, 78, 117, 144, 188, 225, 262
- reflexion of nim-values, 109
- Reisch, Stefan, 226
- remote star, 230–232, 236, 237, 239, 240, 243–251, 258, 259
- Remote Star Test, 246, 248, 249
- remoteness, 173
- replication of nim-values, 98

- resetting the thermostat, 185
- Restricted Translation Rule, 261
- reversible moves, 55, 56, 60, 62–64, 66, 70, 71, 75, 77, 126, 212
- reversible option, 75, 77
- Right, 2
- Right boundary, 154–156, 164, 169, 170
- Right excitable, 158, 159
- right slant, 158, 159
- Right stop, 149, 150, 152, 163
- Right-excitable, 169, 170
- Rip Van Winkle's Game = Kayles, 82
- Rita, 25, 51, 234
- Robertson, Edward, 226
- Robson. J.M., 226
- van Roode, Thea, 78
- Rule, Atomic Weight, 242
- Rule, Berlekamp's, 77, 78
- Rule, Difference, 74
- Rule, Flow, 201, 202, 204, 210
- Rule, Go "dialects", 16
- Rule, Mex, 56
- Rule, Misère Play, 15
- Rule, Nim-Addition, 59, 60, 73, 74
- Rule, Normal Play, 12, 14
- Rule, One-upmanship, 242
- Rule, Restricted Translation, 261
- Rule, Simplicity, 22, 24, 25, 27, 39, 45, 48
- Rule, Two-Ahead, 199, 200, 242, 246, 249
- Rule, With, 256, 257
- Rule, Without, 256, 257
- Rule, Wythoff's Difference, 74
- ruler function, 98
- rules, 14
  
- saltus, 99, 114, 117, 144, 187
- Sarsfield, Richard, 79
- Saskatchewan landscape, 157
- scale, Grundy, 87, 90, 91, 94, 96, 101
- Schaefer, Thomas J., 109, 118, 224, 226, 227
- Schaeffer, Jonathan, 18
- Schaer, Jonathan, 43
- Schuh, Fred., 118
- Scissors-Paper-Stone, 15
- Scorer, R. S., 117
- seasoned campaigner, 164
- Seating Boys and Girls, 132, 133, 179, 261
- Seating Couples, 44, 45, 95, 132, 133, 261
- Seating Families, 95, 261
- second cousin, 101, 103–105, 107, 109, 114, 116
- second player wins, 28–30
- sente, 161, 188
- Sentestrat, 188
- set, empty, 82
- set, subtraction, 84, 86
- set, variation, 220, 221
- Seven-up, 218, 225
- severed head, 205, 220, 221
- sex, opposite, 132, 261
- Shakespeare, William, 145
- She-Loves-Me, She-Loves-Me-Not, 67, 262
- She-Loves-Me-Constantly, e.g. **.51**, 101, 103
- She-Loves-Me; She-Loves-Me-Not, e.g. **.05**, 109, 114, 116
- shifting by stars, 250, 258
- shifting infinitesimally, 177, 198
- short hot games, 225
- short-sighted view, 159, 160
- Silber, Robert, 79
- simplest form, 19, 22, 71
- simplest number, 19, 21, 22
- simplicity, 19, 21, 22
- Simplicity Rule, 22, 24, 25, 27, 39, 45, 48
- simplifying games, 60, 62, 63, 75, 77
- Singapore, 16
- Sipser, Michael, 224, 226
- Ski-Jumps, 7, 9–11, 14, 15, 19, 27, 40
- skittles, 81
- slant, right = correct, 163
- slash, 6, 163
- slashes, 130, 163
- sliding jungles, 199, 220, 221
- slipper, 9
- small, 36, 38, 229–232, 234, 236–240, 242–251, 253, 254, 256–259, 261, 262
- Smith, Cedric Austen Bardell, 89, 96, 99, 109, 117, 118
- snakes, 40–42, 240
- Snakes-and-Ladders, 14
- Snort, 47, 145–147, 149–151, 153, 154, 156–158, 161, 167, 168, 177, 180–183, 224
- Snort dictionary, 147, 180–183
- Snort lemmas, 180
- Solitaire, 15



- span-length, 194, 195
- spanning tree of a graph, 217, 224
- sparse space, 110–113
- Spight, William L., 188
- splitting the atom, 234, 236
- spoiler, 161
- spot, 145, 146
- Spots and Sprouts, 95
- Sprague, Roland Percival, 42, 56, 79, 220, 221
- Sprague-Grundy Theory, 56, 118, 220, 221
- Squandering Squares, 254
- stalemate = tie, 14
- stalk, 29, 30
- stalk = stem, 67
- standard form, 101, 103–105, 107–109, 114
- Star, 34, 39, 47, 48, 155, 156
- star, 65, 68, 69, 120, 121, 125, 190, 229, 261
- star, far, 230–232, 236, 237, 239, 240, 243–251, 258, 259
- star, lucky, 246, 249
- star, remote, 230–232, 236, 237, 239, 240, 243–251, 258, 259
- star, thermograph of, 156
- Star-Incentive Theorem, 259
- Star-Shifting Principle, 250, 258
- starting position, 14
- startling value, 39
- Steingrímsson, E., 117
- stem, 36, 47, 67, 199, 201, 210, 230, 240, 242
- Stockmeyer, Larry J., 224, 226, 227
- Stone, John David, 113
- stop, Left & Right, 149, 150, 152, 156, 158–160, 162, 179
- stop, Left and Right, 165, 166
- stopping position, 149–153, 156–166
- stopping value, 149, 153, 173
- Storer, James, 224
- strategy, 173
- strategy, kite, 243, 244, 246
- strategy, symmetry, 3, 194
- strategy, thermostatic, 158, 163–167, 183–185, 188, 225
- strategy, Tweedledum and Tweedledee, 2, 3, 35
- strategy, winning, 28, 31, 32, 46
- string, Hackenbush, 22, 24, 77, 78, 194, 195
- structure of periods, 109
- subperiods of nim-values, 109
- subtraction game, 84, 86, 87, 98
- subtraction set, 84, 86
- sums eternal, 46
- sums of games, 31, 120, 121, 161, 163, 165, 166, 220
- sums of numbers, 42
- sums, galvanized, 253
- sums, NP-hard, 225
- sums, ordinal, 220
- superko, 16
- superkos, 188
- superstars, 261
- Surreal Numbers, 18
- suspense, 173
- switches, 121–125, 157
- Sylver Coinage, 15
- symmetry, 51
- take-and-break games, 81, 82, 84, 86, 87, 89–96, 98, 99, 101, 103–105, 107–117
- take-away games, 82, 84, 86, 87, 98, 101
- Tarjan, Robert Endre, 224–226
- tax, 154–156
- tax exemption, 151, 153–155
- temperature, 124, 125, 131, 151–155, 164–173, 184, 185, 231
- temperature policy, 124, 125, 131, 132
- temperature, ambient, 164, 165, 188
- temperature, critical, 167–171
- Tennis, 15
- terminal position, 2, 7, 28, 41
- Test, Remote Star, 246, 248, 249
- Test, Uppitiness, 245
- Theorem on incentives, 258
- Theorem on simplifying games, 75, 77
- Theorem, At-Least-One, 258
- Theorem, Don't-Break-It-Up, 213, 214, 216
- Theorem, Max-Flow, Min-Cut, 201, 205, 211
- Theorem, non-arithmetic periodicity, 115
- Theorem, Number Avoidance, 147–149, 183
- Theorem, Redwood Furniture, 212–214
- Theorem, Star-Incentive, 259
- Theory, atomic weight, 253
- theory, Green Hackenbush, 190–196, 201
- Theory, Sprague-Grundy, 56, 118, 220, 221
- thermal dissociation, 168

- thermograph, 151–159, 161–166, 168–172, 174, 176  
 thermograph, 4-stop, 158, 159  
 thermograph, compound, 164  
 thermograph, extended, 161, 162  
 thermographic thicket, 176  
 thermographs of star and up, 156  
 thermography, 151–174, 176–179, 188, 225, 262  
 thermostat, 164, 185  
 Thermostat, 188  
 THERMOSTRAT = Thermostatic Strategy, 188, 225  
 THERMOSTRAT = thermostatic strategy, 158, 163–167, 183–185  
 third cousin, 101, 103–105, 107, 109, 114, 116  
 Thompson, Francis, 190  
 Thoreau, Henry David, 19, 53  
 Three-Finger Morra, 15  
 three-quarters, 6, 17  
 thumbnail, 19  
 Thursday, Maundy, 26  
 Tic-Tac-Toe, 14, 94  
 tied, 14  
 time, complete in exponential, 224  
 tinted, 38, 39, 47–49, 51, 204, 206, 209, 210  
 tiny, 126, 127, 169, 170  
 tiny- $x$ , 126  
 tiny-a-quarter, 132  
 tiny-two, 126  
 $T$ -move, 165, 184  
 Toads-and-Frogs, 12, 40, 63–65, 68–70, 72, 75, 77, 127–132, 134–138  
 toenail, 158  
 track = path, 202, 222  
 tracking, 65, 202, 205, 222  
 trading Triangles, 254  
 transition, phase, 168  
 translation by nimbers, 259, 261  
 translation by numbers, 153, 158  
 translation of switches, 123  
 translation, by numbers, 149  
 Traub, J. F., 226  
 Treblecross, 113  
 Treblecross = **·007**, 94, 95  
 tree with extra twig, 214, 216  
 tree, Australian, 22, 24, 214  
 tree, binary, 22, 24  
 tree, game, 40  
 tree, green, 191–193  
 tree, greenwood, 34  
 tree, redwood, 214–217  
 tree, spanning, 217, 224  
 Triangles, Trading, 254  
 triangular numbers, 254  
 Triplicate Dawson's Kayles, 261  
 Triplicate Nim, 114, 116  
 Triplicate Treblecross, 262  
 Tschantz, Steven, 52  
 Turn-and-Eatcake, 236  
 Tweedledum and Tweedledee, 2, 3, 35  
 Tweedledum and Tweedledee Argument, 35, 72  
 twig, 192, 193, 196, 213, 216  
 twigs, redwood, 213, 214, 216  
 Twisted Bynum, 236  
 Two-Ahead Rule, 199, 200  
  
 Uiterwijk, J. W. H. M., 144  
 ultimate periodicity, 99, 101  
 uncertainty, 230  
 underlying economy, 151  
 unparted jungles, 210  
 unruly, 116  
 untinted nodes, 50, 204, 206, 210  
 up,  $\uparrow$ , 151, 155, 229, 247, 258  
 up,  $\uparrow$ , 156  
 up,  $\uparrow$ , 63–72  
 up, powers of, 188  
 up,  $\uparrow$ , 232  
 up-second, 236  
 up-third, 236  
 uppitness = atomic weight, 200–202, 204, 206, 208, 209, 211, 220–222, 225, 230–232, 234, 236–240, 242–244, 246, 248, 251, 253, 256, 258, 259, 261  
 uppity, equally, 242, 245  
 upstar, 65, 242  
 upstart equality, 71  
  
 value, 4–7, 9–12, 17, 19, 20, 22, 24–26, 28, 36, 38, 39, 43–45  
 value versus average, 10  
 value, chilled, 187  
 value, mast, 152–154, 165, 166



- value, mean, 149, 151–154, 165, 166, 188
- value, startling, 39
- values, Childish Hackenbush, 43, 52
- values, Col, 38, 39, 50
- values, common, 110
- values, Cutcake, 25
- values, Domineering, 120, 121, 139, 142, 144
- values, exceptional, 90–92, 101, 108
- values, excluded, 111
- values, Hackenbush, 4–6, 17, 19, 20
- values, irregular, 90–92, 101, 108
- values, Maundy Cake, 26
- values, nim-, 82, 84, 86, 87, 90–96, 98, 99, 110–117, 191–195, 230
- values, rare, 110–112
- values, redwood bed, 216
- values, regular, 90, 91
- values, Seating Boys-and-Girls, 133
- values, Seating Couples, 45
- values, Ski-Jumps, 9–11, 19
- values, small, 36, 229–232, 234, 236–240, 242–251, 253, 254, 256–259, 261, 262
- values, Snort, 147, 180–183
- values, switch, 121–125
- values, Toads-and-Frogs, 12, 131, 134–138
- variation set, 220, 221
- variations, 94
- victory, 163
- Vout, Colin, 38
  
- Walsh, J. L., 52
- waltz, -6, 96
  
- warfare, jungle, 210
- warming, 187
- West, Julian, 144
- White Knight, 56–59
- White Rook, 59
- White, Farmer, 145–147
- whole numbers, 19
- wholeness of Hackenbush Hotchpotch, 251
- width, 164, 184
- Williams, Sir Charles Hanbury, 119
- Wilson, Neil Y., 118
- Wolfe, David, 18, 142, 144, 188, 224, 225
- wonders, numberless, 119
- Woodrow, Robert E., 144
- world, small, 229
- worthwhile move, option, 213–216
- Wyt Queens, 59, 60, 74
- Wythoff's Difference Rule, 74
- Wythoff's Game, 15, 60, 74
- Wythoff, W. A., 74, 79
  
- Yedwab, Laura, 224, 227
- Yedwab, Laura J., 188
- Yes, 53, 112
- Yesha, Y., 224, 226
  
- zero, 2, 3, 7, 19, 28–30, 33, 41
- zero game, 4
- zero position, 2
- Zieve, Michael, 118
- zigzag, 177